



**NAVAL
POSTGRADUATE
SCHOOL**

MONTEREY, CALIFORNIA

THESIS

**A PROTOTYPE WEB-ENABLED INFORMATION
MANAGEMENT AND DECISION SUPPORT SYSTEM FOR
ARMY AVIATION LOGISTICS MANAGEMENT**

by

Joseph A. Hoecherl

September 2004

Thesis Advisor:
Second Reader:

Magdi N. Kamel
Glenn R. Cook

Approved for public release; distribution is unlimited

THIS PAGE INTENTIONALLY LEFT BLANK

REPORT DOCUMENTATION PAGE			<i>Form Approved OMB No. 0704-0188</i>
Public reporting burden for this collection of information is estimated to average 1 hour per response, including the time for reviewing instruction, searching existing data sources, gathering and maintaining the data needed, and completing and reviewing the collection of information. Send comments regarding this burden estimate or any other aspect of this collection of information, including suggestions for reducing this burden, to Washington headquarters Services, Directorate for Information Operations and Reports, 1215 Jefferson Davis Highway, Suite 1204, Arlington, VA 22202-4302, and to the Office of Management and Budget, Paperwork Reduction Project (0704-0188) Washington DC 20503.			
1. AGENCY USE ONLY (Leave blank)	2. REPORT DATE September 2004	3. REPORT TYPE AND DATES COVERED Master's Thesis	
4. TITLE AND SUBTITLE: A Prototype Web-Enabled Information Management and Decision Support System for Army Aviation Logistics Management			5. FUNDING NUMBERS
6. AUTHOR(S) Hoecherl, Joseph A.			
7. PERFORMING ORGANIZATION NAME(S) AND ADDRESS(ES) Naval Postgraduate School Monterey, CA 93943-5000			8. PERFORMING ORGANIZATION REPORT NUMBER
9. SPONSORING /MONITORING AGENCY NAME(S) AND ADDRESS(ES) N/A			10. SPONSORING/MONITORING AGENCY REPORT NUMBER
11. SUPPLEMENTARY NOTES The views expressed in this thesis are those of the author and do not reflect the official policy or position of the Department of Defense or the U.S. Government.			
12a. DISTRIBUTION / AVAILABILITY STATEMENT Approved for public release; distribution is unlimited.			12b. DISTRIBUTION CODE
13. ABSTRACT (maximum 200 words) The purpose of this thesis is to develop a prototype web-enabled database to improve the process flow of data collection and manipulation in support of Army aviation operations. Data collection is focused around routine aviation operations and aviation maintenance with the intention of identifying a feasible replacement for the existing redundant manual and automated collection procedures. The web interface has the potential to reduce the logistical burden on unit's data collection procedures and provides tailorable, near real time information about aircraft maintenance status, individual training, and unit training to decision makers at all levels as a decision support tool. This thesis will describe the design considerations for a web-enabled database to include the development of detailed data and process models.			
14. SUBJECT TERMS Web-Enabled Architecture, Database Management System, Decision Support System, Information Management System, Web Design.			15. NUMBER OF PAGES 77
			16. PRICE CODE
17. SECURITY CLASSIFICATION OF REPORT Unclassified	18. SECURITY CLASSIFICATION OF THIS PAGE Unclassified	19. SECURITY CLASSIFICATION OF ABSTRACT Unclassified	20. LIMITATION OF ABSTRACT UL

THIS PAGE INTENTIONALLY LEFT BLANK

Approved for public release; distribution is unlimited

**A PROTOTYPE WEB-ENABLED INFORMATION MANAGEMENT AND
DECISION SUPPORT SYSTEM FOR ARMY AVIATION LOGISTICS
MANAGEMENT**

Joseph A. Hoecherl
Major, United States Army
M.B.A., Embry-Riddle Aeronautical University, 1998
B.S., University of Central Florida, 1991

Submitted in partial fulfillment of the
requirements for the degree of

MASTER OF SCIENCE IN INFORMATION TECHNOLOGY MANAGEMENT

from the

**NAVAL POSTGRADUATE SCHOOL
September 2004**

Author: Joseph A. Hoecherl

Approved by: Magdi N. Kamel
Thesis Advisor

Glenn R. Cook
Second Reader

Dan C. Boger
Chairman, Department of Information Sciences

THIS PAGE INTENTIONALLY LEFT BLANK

ABSTRACT

The purpose of this thesis is to develop a prototype web-enabled database to improve the process flow of data collection and manipulation in support of Army aviation operations. Data collection is focused around routine aviation operations and aviation maintenance with the intention of identifying a feasible replacement for the existing redundant manual and automated collection procedures. The web interface has the potential to reduce the logistical burden on unit's data collection procedures and provides tailorable, near real time information about aircraft maintenance status, individual training, and unit training to decision makers at all levels as a decision support tool. This thesis will describe the design considerations for a web-enabled database to include the development of detailed data and process models.

THIS PAGE INTENTIONALLY LEFT BLANK

TABLE OF CONTENTS

I.	INTRODUCTION.....	1
A.	BACKGROUND	1
B.	PURPOSE.....	2
C.	ASSUMPTIONS.....	2
D.	EXPECTED BENEFITS OF THIS THESIS	2
E.	METHODOLOGY	3
F.	ORGANIZATION OF THE THESIS.....	4
II.	GENERAL REQUIREMENTS, STAKEHOLDERS, SWOT ANALYSES AND SYSTEM DESIGN	5
A.	EXISTING SYSTEM.....	5
B.	GENERAL REQUIREMENTS.....	5
C.	STAKEHOLDER ANALYSIS	6
D.	STRENGTHS, WEAKNESSES, OPPORTUNITIES, AND THREATS (SWOT) ANALYSIS.....	9
E.	SYSTEM DESIGN.....	11
III.	CONCEPTUAL DATA MODEL AND GENERATED DATABASE SCHEMA.....	13
A.	BUILDING A MODEL	13
B.	SEMANTIC OBJECT MODELS.....	14
1.	Objects	14
2.	Attributes.....	14
3.	Cardinality.....	15
4.	Domain.....	16
C.	PROTOTYPE SEMANTIC OBJECT MODEL	16
1.	Userlist	17
2.	Maintenance Status/Aircraft Type/Rank/Flight Condition/Duty Positions.....	18
3.	Crewmember	19
4.	Unit.....	21
5.	Aircraft.....	22
6.	Flight	23
7.	Log Entry.....	24
D.	PROTOTYPE DATABASE SCHEMA	24
IV.	PROCESS MODEL.....	27
A.	INITIAL PROCESS FLOW	28
1.	Welcome Screen	28
2.	User Authentication.....	28
3.	Registration	29
4.	Portal Home.....	29
B.	AIRCRAFT PROCESS FLOW.....	30

1.	Aircraft Search and Results.....	30
2.	Aircraft Detail	31
	<i>a. Record a New Flight</i>	31
	<i>b. Update Maintenance Status of Selected Aircraft</i>	32
	<i>c. Search for a Different Aircraft</i>	32
	<i>d. View Flight Details</i>	32
3.	Flight Detail	32
	<i>a. Edit Flight Mission Data</i>	33
	<i>b. Add Log Entry to Flight</i>	33
	<i>c. Flight Entry Complete</i>	33
	<i>d. Edit Log Entry</i>	33
C.	CREWMEMBER PROCESS FLOW	33
1.	Search.....	34
2.	Crewmember Detail.....	35
	<i>a. Edit Crewmember Information</i>	35
	<i>b. Delete Crewmember Record</i>	35
3.	Add Crewmember.....	35
D.	REPORT PROCESS FLOW	36
1.	Training Reports.....	36
2.	Maintenance/Aircraft Readiness	37
3.	Aircraft Utilization.....	37
4.	Aviation Units.....	37
V.	PROTOTYPE IMPLEMENTATION AND DEPLOYMENT	39
A.	OVERVIEW OF DREAMWEAVER	39
B.	IMPLEMENTATION DESIGN CONSIDERATIONS.....	40
C.	CONSTRUCTING THE PROTOTYPE.....	41
D.	TOOL CHALLENGES	46
E.	ASSEMBLING, TESTING, AND DEPLOYING THE SITE.....	46
F.	DEPLOYING THE PROTOTYPE	49
VI.	SUMMARY, CONCLUSIONS, AND FUTURE RESEARCH.....	53
A.	SUMMARY	53
B.	CONCLUSIONS	54
C.	FUTURE RESEARCH.....	55
	LIST OF REFERENCES.....	57
	INITIAL DISTRIBUTION LIST	59

LIST OF FIGURES

Figure 1.	Semantic Object Diagram.....	17
Figure 2.	Userlist Semantic Object.....	17
Figure 3.	Maintenance Status, Aircraft Type, Rank, Flight Condition, and Duty Positions Semantic Objects.....	18
Figure 4.	CREWMEMBER Semantic Object.....	19
Figure 5.	UNIT Semantic Object.....	21
Figure 6.	AIRCRAFT Semantic Object.....	22
Figure 7.	FLIGHT Semantic Object.....	23
Figure 8.	LOG ENTRY Semantic Object.....	24
Figure 9.	Database Schema.....	25
Figure 10.	Join Type Depiction.....	26
Figure 11.	Initial Website Process Flow.....	28
Figure 12.	Aircraft Process Flow.....	30
Figure 13.	Crewmember Process Flow.....	34
Figure 14.	Report Process Flow.....	36
Figure 15.	Log-in Template with Dreamweaver workspace view.....	41
Figure 16.	eAviation Project Welcome Screen.....	42
Figure 17.	eAviation Project Aircraft Search Page.....	43
Figure 18.	eAviation Project Aircraft Search Results Page.....	43
Figure 19.	eAviation Project Aircraft Detail Page.....	44
Figure 20.	eAviation Project Add Flight Record Page.....	45
Figure 21.	eAviation Project Application of Insert Record Behavior.....	45
Figure 22.	eAviation Project: Local Site Definition.....	47
Figure 23.	eAviation Project: Testing Server Site Definition.....	48
Figure 24.	eAviation Project: Remote Site Definition.....	49

THIS PAGE INTENTIONALLY LEFT BLANK

LIST OF TABLES

Table 1.	Stakeholder Analysis	8
Table 2.	SWOT Analysis for Army Aviation Information Technology (IT) Implementation	10

THIS PAGE INTENTIONALLY LEFT BLANK

ACKNOWLEDGMENTS

The author would like to acknowledge and express gratitude to Professor Magdi Kamel and Glenn Cook for their tremendous assistance, flexibility, expertise, and guidance throughout the development of the prototype and this project.

THIS PAGE INTENTIONALLY LEFT BLANK

EXECUTIVE SUMMARY

This thesis reviews the existing Army Aviation flight data management process to include regulatory requirements. Based upon this analysis, the thesis focuses on the development of an internet-centric information system to replace the data collection process for aircraft and crewmember flight data. The data collected is also used to develop custom queries of the data to provide a tailorable decision support system. A primary goal of the thesis is to improve the process flow of data collection and manipulation in support of Army aviation operations.

The development of the prototype web-enabled database is documented; focusing on the development of a conceptual data model, transformation of the model into a database schema, a process flow model and the creation of a functional prototype.

Considerations for deployment of the prototype as a beta test are discussed along with conclusions about the implementation of an internet-based information system. Significant benefits identified include: 1) The potential to reduce the logistical burden on unit's data collection procedures, providing potential allocation of this time to aircraft maintenance and primary mission accomplishment; and 2) The ability to provide tailorable, near real time information about aircraft maintenance status, individual training, and unit training to decision makers at all levels as a decision support tool.

THIS PAGE INTENTIONALLY LEFT BLANK

I. INTRODUCTION

A. BACKGROUND

The Army has a very large fleet of rotary wing aircraft that are required to operate in frequently austere environments. A large amount of data is gathered from each aircraft flight in order to facilitate tracking of crewmember flight hours, conditions, and duty positions.(Army Regulation 95-1,1997,p.3) This information is used to ensure compliance with federal, Department of Defense, and Army regulations. The information is also used for both logistic and deployment decision making.(Army Regulation 700-138,2004,pp.22-24)

The Army implemented an automated logistics program called the Unit Level Logistics System-Aviation (ULLS-A); the ULLS-A system, however, was designed primarily around maintenance procedures, which did not fully incorporate crewmember flight data.(Field Manual 3-04.500,2000,p.A-1) Within a flight company, the production control, quality control and technical supply sections are all linked via the ULLS-A system but the flight operations section that is responsible for tracking crewmember and unit training is not incorporated. The ULLS-A implementation resulted in a combination paperless logbook for maintenance procedures and a paper logbook for crewmember flight data tracking, essentially adding to the administrative burden placed upon the aviation unit. The added requirements included the need for a dedicated notebook computer for each aircraft, significant training requirements for all users, maintaining spare notebooks, and most significantly increasing the time that aircrews spend on administrative tracking.

Information about aircraft and aviation operations is required at various levels to support regulatory, planning, and decision support requirements. The current system is difficult to use and the time investment is significant relative to the benefits received. Reducing the time for required gathering and processing aviation flight data can translate directly into increased time available for aviation personnel to focus on aircraft maintenance and aviation training, directly increasing the value provided to the Army and the United States taxpayer.

B. PURPOSE

The purpose of this thesis is to examine how a web-centric data collection and processing system can improve the workflow processes and provide a decision support system to support multi-level decision making. This thesis further discusses the process of developing a web-enabled database, focusing on the data and process models of the application domain.

C. ASSUMPTIONS

The Army is currently undergoing a transformation to a digitized more rapid response force. (Fontenot, 2004, pp.9-11) This transformation combined with the flexibility necessary to respond to numerous global conflicts, stability and support, or humanitarian missions simultaneously will exacerbate the shortcomings of the existing information system. The scope and security requirements of an army-wide implementation will require a robust system. The prototype developed could be modified or used as a model for future development.

D. EXPECTED BENEFITS OF THIS THESIS

Thousands of man-hours are expended recording aviation data and preparing monthly reports. Automated reporting has the potential to allocate these man-hours to aircraft maintenance, directly contributing to increased aircraft availability to conduct missions. "Information and IT are providing the means for innovative companies to create value in ways that were not possible before the advent of the Information Age" (Alberts, D.S.,1999,p.32). The timely availability of aircraft maintenance and training data in customizable views can provide decision makers the ability to better allocate assets and standardize capabilities within aviation units. The implementation of web-based portals for virtually all personnel type actions in the Army paves the road for change along these lines by successfully demonstrating the benefits of this technology, although a certain amount of resistance to deviation from the way things have been done historically is inevitable(El Sawy,2001,pp.39-41).

The sheer volume of information essentially dictates some form of automation/technology solution. The majority of the stakeholders involved are technology savvy enough (aviation is inherently a technology industry) to recognize that an automated system will be beneficial and is inevitable. The challenge is more in selecting the best solution rather than incurring the costs and frustrations of iterating through solutions to find the optimal solution.

The overall driving factor for a technology solution is based upon the human factors (excessive time requirements) of the existing system. A solution that soldiers and leaders believe will make their jobs easier and more efficient, will likely be wholeheartedly embraced.

The web-enabled database development process combined with the prototype can serve as an instructional aid for future web-enabled database development. The data model and process model hold the potential to be used as a tutorial or as a ready reference during the development process.

E. METHODOLOGY

The well defined regulatory requirements combined with the long established needs of the Army Aviation community make the development of an information system potentially suitable for a waterfall approach to development. However, a waterfall development methodology would not allow for an incremental implementation approach that allows the replacement of an individual segment of the system. Due to the interface requirements and the eventual goal of establishing an Enterprise Resource Planning (ERP) system, the development lends itself towards an incremental or spiral development methodology. Delaying any implementation until a complete ERP is designed would result in unacceptable delays and lack sufficient ability to troubleshoot any difficulties that could arise. It is also very likely that the demands for information will increase significantly as decision makers become comfortable with the information system and aware of its capabilities.

The overall approach will be a spiral approach, with the prototype developed for this thesis as the first spiral. The existing requirements for crewmember and unit training information will be analyzed for this first spiral. The project will model the data requirements, model a logical process flow to manage this data and construct a prototype from these models to serve as an initial beta test. Following an initial beta test, subsequent spirals may be undertaken to enhance the data or processes generated from the first spiral or to expand the breadth of the prototype to include greater maintenance management functionality.

F. ORGANIZATION OF THE THESIS

This remainder of the thesis is organized as follows. Chapter II analyzes the operating environment and system design requirements for an army aviation information system. Chapter III describes the development of the prototype conceptual data model. Chapter IV describes the development of the process flow model. Chapter V discusses the tools, design, construction and challenges of prototype implementation as well as deployment of the prototype. Chapter VI provides a summary of the thesis project, presents conclusions about implementation of a web-based information system for aviation flight data, and discusses directions for future research.

II. GENERAL REQUIREMENTS, STAKEHOLDERS, SWOT ANALYSES AND SYSTEM DESIGN

This chapter discusses the current information system and the operating environment in which the system operates. Key aspects of the organization and stakeholders within the organization are analyzed to identify strategies for designing and implementing an information system. The system to be designed is then discussed.

This chapter is organized as follows. Section A discusses the existing system; Section B discusses general requirements for the information system; Section C analyzes the stakeholders that are relevant to the system design and operation; Section D evaluates the organization for design and implementation strategies; and Section E identifies the design of the prototype system.

A. EXISTING SYSTEM

The existing system is only partially automated, specifically not addressing the aircrew flight data. This partial system solution has resulted in excessive administrative burdens on the aviation flight companies rather than providing significant value to the organization through a well-designed information technology solution. This partial automation, which does not provide real time data to decision makers, frequently results in ad hoc reporting requests when current information is needed; this results in even greater stresses upon the aviation unit. Maintaining a separate notebook computer for use as an electronic logbook for each aircraft is very burdensome and is further complicated by the need to maintain spare logbooks with support personnel to troubleshoot logbook problems, load software and transfer data onto a replacement logbook.

B. GENERAL REQUIREMENTS

The information system should be unobtrusive to the primary mission of the aviation unit; this includes minimizing the training required to use the system, minimizing the logistical footprint, and adding value to the immediate user and higher echelons through increased availability of information. In order to minimize training, the

data entry component of the system should bear a strong resemblance to historical data entry tools and formats. The input process should follow an intuitive natural flow and capitalize on the user's familiarity with existing internet-based information systems. Equipment requirements for units that deploy to combat zones should not increase, a primary goal is to decrease the equipment required relative to the current automation system. Maintenance and support of the information system should be centralized in non-combat areas, either in one location or possibly in a few regional locations.

A single data input source should serve all of the flight company requirements. The same flight data should generate the aircrew and maintenance reports without requiring additional human interface to transfer or copy the data. At some level the data system will need to interface with the existing army logistical automation systems.

C. **STAKEHOLDER ANALYSIS**

Primary stakeholders that have a vested interest in the success or failure of any Information Technology (IT) solution that is proposed are listed below. Each category is a general category that may have several subsidiary components (e.g. Senior Army Command/Staff includes organizations such as the Aviation and Missile Command (AMCOM) and the Aviation Training Brigade at Fort Rucker:

Logistics Support Agency (LOGSA) – Responsible for developing technology solution.

Senior Army Command/Staff – Authority to implement policies and benefit from information availability.

Intermediate Aviation Commanders – Enforcement of policies and primary beneficiary of reduced reporting requirements.

Aviators/Mechanics/Flight Operations – End-users that have routine interface with system. Efficiency of the system makes or breaks successful implementation.

Table 1 is a matrix that shows these primary stakeholders on the left side and key characteristics of these stakeholders across the top. This is a tool used during the

development of an automation system to identify communication requirements between the developer and the stakeholder, the stakeholder's importance and level of involvement during the development process, and the stakeholder's strengths and goals relative to the information technology project.

Communication requirements and involvement in the development process are highest for LOGSA prior to implementation and then shifts to the individual stakeholder that interfaces with each component of the system. Primary goals identified based upon this analysis are: 1) Ease of interface, friendly Graphical User Interface (GUI); 2) Minimal training time; and 3) Immediate and accurate visibility of information.

Stakeholder Analysis for Development of Automated Aviation Logbook System

	COMMUNICATION FROM ORGANIZATION	COMMUNICATION FROM STAKEHOLDER	IMPORTANCE OF STAKEHOLDER TO PROJECT	LIKELIHOOD OF STAKEHOLDER INVOLVEMENT	STAKEHOLDER GOALS	STRENGTHS OF STAKEHOLDER
LOGSA	Full & Accurate Info about Requirements	Funding Available, Approval of Contractor, Approval of Concept	High	High, Key Interface	Develop new system, keep costs low & implementation timeline short	Authority to implement, Resources
SENIOR COMMAND/ STAFF	Request for Approval	Milestones, Implementation Timeline, Security Requirements	High	Low until Implementation	Immediate & Accurate Visibility of Data/Info	Authority to influence implementation and development; Directly benefit from increased availability of information
AVIATION COMMANDERS	Technology Solutions Available	Ease of use, User Feedback, Needs & Requirements	Moderate	Low until Implementation	Availability of info, Minimal Train-Up/Time Impact	Enforcement, Implementation
AVIATORS/ MECHANICS/ FLIGHT OPERATIONS	Technology Solutions Available	Ease of use, User Feedback, Needs & Requirements	Mod. High	Low until Implementation, Possible Feedback for Design Requirements	User Friendly Graphical User Interface (GUI), Minimal Time Impact	Professional Individuals, IT/Technical Familiarity

Table 1. Stakeholder Analysis

D. STRENGTHS, WEAKNESSES, OPPORTUNITIES, AND THREATS (SWOT) ANALYSIS

Table 2 is a matrix that identifies the strengths and weaknesses of the army aviation community relative to the implementation of an information system and also identifies opportunities for, and threats to a successful information system implementation. The intent is to capitalize on existing strengths and opportunities while mitigating threats and weaknesses. Internal strengths and weaknesses are identified across the top of the table with external opportunities and threats identified on the left side of the table.

Potential strategies for an information technology implementation are identified within the table in a matrix format with references to specific strengths and opportunities that the strategy capitalizes upon and the specific weaknesses and threats that the strategy mitigates identified in parenthesis. Strategies related to the design of the information system will be addressed in the development of the project prototype and strategies related to implementation will be considered in the deployment of the information system.

There are several key strengths that will assist in the implementation of an information system. The Army owns the operating environment which provides the authority to implement a system that meets all requirements. The organization, as well as many aviation personnel, has a strong technology orientation. The Army also has recent successful experience with the implementation of a web-based personnel portal. These strengths are significant relative to the organizational weaknesses.

<p style="text-align: center;">Internal</p> <p style="text-align: center;">External</p>	<p style="text-align: center;">Strengths</p> <ol style="list-style-type: none"> 1. Lack of competition 2. Own the operating environment 3. Vast resources (R&D/Funding) 4. Technology orientation 5. Recent successful Implementation of web-based personnel portal 	<p style="text-align: center;">Weaknesses</p> <ol style="list-style-type: none"> 1. Time to implement 2. Scale of organization 3. Levels of bureaucracy
<p style="text-align: center;">Opportunities</p> <ol style="list-style-type: none"> 1. Existing system is being replaced; actively seeking new information system 2. Improved efficiency (reduce end users time investment in data input) 	<p style="text-align: center;">Possible Strategies</p> <ol style="list-style-type: none"> 1. Design simple intuitive GUI (O2,S1,S2,S3,S4,S5) 2. Deliver project recommendations within decision cycle (O1,S1,S2,S3,S4,S5) 	<p style="text-align: center;">Possible Strategies</p> <ol style="list-style-type: none"> 1. Design familiar user friendly interface (O1,O2,W1,W2) 2. Solution proposed during active search window (O1,W1,W3)
<p style="text-align: center;">Threats</p> <ol style="list-style-type: none"> 1. Potentially lengthy acquisition process. 	<p style="text-align: center;">Possible Strategies</p> <ol style="list-style-type: none"> 1. Extend PeopleSoft contract utilized for personnel system (T1,S3,S4,S5) 2. Focus on Commercial Off The Shelf (COTS) hardware and operating systems (T1,S3,S4,S5) 	<p style="text-align: center;">Possible Strategies</p> <ol style="list-style-type: none"> 1. Maximize COTS and web-based processing to minimize cost (T1,W1,W2,W3) 2. Consider dovetailing onto PeopleSoft contract (T1,W1,W3)

Table 2. SWOT Analysis for Army Aviation Information Technology (IT) Implementation

The weaknesses are focused primarily around the scale of the organization. Implementation of any system is made more difficult by needing to field the system to a large bureaucratic organization. The current opportunities are significant. The Army is

seeking a replacement aviation logistics system that will be suitable to be a component of a future Enterprise Resource Planning (ERP) system. The current transformation initiatives are also seeking to improve efficiency. The only considerable threat is the historically lengthy acquisition process.

Strategies derived from this SWOT analysis include: 1) Designing a simple intuitive Graphical User Interface (GUI); 2) Maximizing Commercial Off-The-Shelf (COTS) hardware and software along with web-based processing to minimize deployed hardware; and 3) Consider extending existing contract that created the personnel portal.

E. SYSTEM DESIGN

Any information system for the aviation community needs to avoid redundancy. Flight crews need a single data entry for all flight related data. The existing aircraft maintenance information system is functional with the exception of a difficult user interface. The focus for this prototype will be on developing a friendly graphical user interface that is web-enabled.

The web-enabled feature is crucial to eliminate the need for dedicated notebook computers for each aircraft. Any web browser operating on a desktop or notebook computer or even operating on a mobile personal digital assistant can be used to enter flight data for any aircraft. Using the web-browser as the interface for the flight company allows units to use existing personal computers that are used for other administrative tasks for data input. It also adds the flexibility to change the input device as desired when technology changes without requiring changes to the information system. Potential future solutions to data input devices could involve mobile devices using wireless networks, cellular connection to the internet or even satellite connections. This would provide the ability to update aircraft status and flight data even in remote locations with only one data input device for each group of aircraft that are collocated. The data from these updates could be visible instantaneously at any echelon of leadership.

The prototype will be designed to provide the data required by Army Regulation 95-1, which is the data used by the flight operations section to produce unit and

crewmember training reports.(Army Regulation 95-1,1997,p.3) This focus was chosen since it is currently not managed by the existing information system. The current aircraft status will also be included to demonstrate the decision support capabilities of the internet based system. Prior to full implementation, either an interface between the existing maintenance management system or the extension of the prototype to include all maintenance management functions would be required.

The key information required in order to create unit and crewmember training reports includes each crewmember on a flight along with the crewmembers duty position, flight condition and flight hours. Each unique combination of crewmember, duty position and flight condition will constitute a distinct log entry. Each log entry will need to be linked to a specific flight for that aircraft. These log entries and flight entries will be sufficient to create individual crewmember training reports, however, in order to create unit training reports the aircraft and log entries need to be associated with specific assigned units.

This chapter identified the operating environment, stakeholders, strategies, and initial design requirements for the system. This information is used to develop the conceptual model which is discussed in Chapter III.

III. CONCEPTUAL DATA MODEL AND GENERATED DATABASE SCHEMA

This chapter discusses semantic object models and describes the creation of the prototype conceptual semantic object model. The relationships and attributes of each object are discussed followed by the transformation of the model into a database schema.

This chapter is organized as follows. Section A discusses considerations for building a conceptual model; Section B discusses semantic object models and the creation of objects and attributes; Section C describes creation of the prototype semantic object model; and Section D describes creation of a database schema from the semantic object model.

A. BUILDING A MODEL

The first step in developing a database application is to create a conceptual model of the data in the application domain. A detailed review of the current uses of the data provides a starting point. An analysis of all existing reports generated by the current information system combined with any specified improvements to the current system will provide a baseline. The database designer should also consult with system users in order to anticipate future information requests that are likely to be generated by implementation of an automated information system. (Kroenke, 2002, pp.79-81) The next step for the designer is to analyze the information available from the data sources, focusing on potential conflicts or shortcomings in the data available to meet output requirements or desires. The designer will need to resolve any shortcomings through modifying either the output requirements or the data source procedures with the client. It is vital to the design of the database to thoroughly involve clients that are intimately familiar with the existing processes, as well as representatives that understand the desired improvements from the database implementation.

B. SEMANTIC OBJECT MODELS

There are two primary modeling tools used to create a data model: 1) Entity-Relationship Model; and 2) Semantic Object Model. Both models are very useful in modeling the data in the application domain and either one can be used to generate the implementation database. I have chosen to use the Semantic Object Model since the view of the data is generally more closely aligned with how the user views their data, making it an easier model to communicate with the individuals that are the experts on the system that is being improved or replaced. (Kroenke,2002,pp.111-112)

A semantic object model is a method to identify and assign meaning to the data objects. According to Kroenke "...a semantic object is a named collection of attributes that sufficiently describes a distinct entity." (Kroenke,2002,p.80) I will briefly discuss the key terminology of semantic object modeling and then further clarify those terms through the description of the semantic object model used to create the project prototype.

1. Objects

A semantic object is an entity that has a collection of attributes to describe it. Objects are depicted in diagrams and named using all upper case letters. An example of an object is CREWMEMBER which models a real life crewmember. A specific crewmember, such as CPT John Doe, 111-22-3333 would be an instance of the CREWMEMBER object class described above.

2. Attributes

Attributes define the characteristics of a semantic object. In the crewmember example above, Last Name, First Name, Middle Initial, Rank, and Social Security Number are all attributes that describe the characteristics of CREWMEMBER. Attributes can also be objects, thus establish relationships between semantic objects. The CREWMEMBER object could have UNIT ASSIGNED as an attribute, with UNIT ASSIGNED identified as a separate semantic object with its own attributes such as Unit

Name, Address, and Telephone Number. The customary depiction in diagrams for attributes that establish relationships to other objects is to place the attribute inside of a rectangular box.

Each semantic object must have one attribute, or a group of attributes, that uniquely identify each instance of that semantic object. The unique attribute can be an existing attribute such as Social Security Number in the CREWMEMBER semantic object example or an automatically generated unique identifier attribute can be incorporated. The unique identifying attribute is preceded in the model by a double ampersand arranged vertically.

3. Cardinality

Semantic object attributes are always identified by a minimum and maximum cardinality. The minimum cardinality identifies the minimum number of instances that are allowed for that attribute. Most attributes have a minimum cardinality of either 0 or 1; a minimum cardinality of 0 indicates that the attribute is not required. For instance, it would be appropriate to set the cardinality of the Middle Initial attribute in the CREWMEMBER example above to 0 since some individuals do not have a middle initial. The Last Name attribute in the same example would be a good candidate for a minimum cardinality of 1 since all crewmembers will have a last name.

Maximum cardinality can be 1 or greater. The most common maximum cardinalities are 1 or many (depicted as N). In some cases an appropriate maximum cardinality may be a larger discrete number. In the UNIT ASSIGNED semantic object example above, a maximum cardinality of 2 for the Telephone Number attribute would allow the UNIT ASSIGNED object to have two telephone numbers stored in the database, but no more. A maximum cardinality of 1 would be appropriate for the Unit Name attribute in the same example, since each unit would be identified by one unique name. A maximum cardinality of N (or many) would be appropriate for the CREWMEMBER attribute of the UNIT ASSIGNED semantic object since each unit may have many crewmembers assigned to the unit without a specific discrete upper bound.

Minimum and maximum cardinalities are depicted as subscripts for each attribute in a semantic object model using the format **0.1** to reflect a minimum cardinality of 0 and a maximum cardinality of 1. Similarly **1.N** would depict a minimum cardinality of 1 and a maximum cardinality of many.

4. Domain

The domain of an attribute is the pool of possible values that it can acquire. The domain includes the data type, such as numeric, integer, string, or text. The domain can be further limited by restricting the size of the data field or by enumerating a list of values for the specific data field. In the CREWMEMBER semantic object example above, the Rank attribute would be a good candidate for an enumerated list since there is a relatively short list of suitable entries. Restricting the domain to an enumerated list ensures the data is entered in a standard manner. In the Rank attribute example it can prevent an individual rank from being entered in numerous forms, such as the rank of Captain being entered as Captain, CAPTAIN, CPT, Capt., or O-3.

C. PROTOTYPE SEMANTIC OBJECT MODEL

Figure 1 shows the semantic object model for the project prototype. I will describe the objects, attributes and cardinalities below.

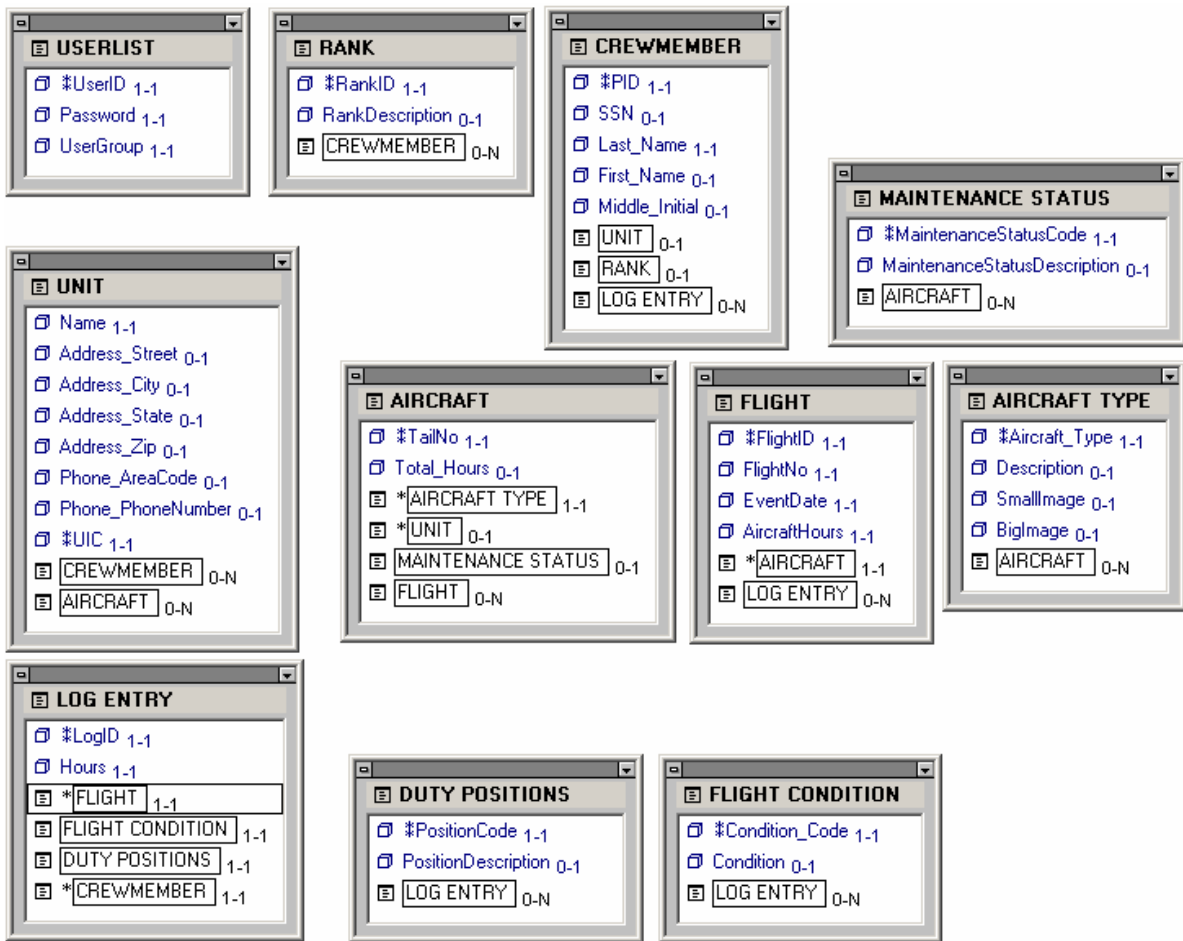

Figure 1. Semantic Object Diagram

1. Userlist



Figure 2. Userlist Semantic Object

The USERLIST semantic object is not integral to the data collected or used by the client. There are no relationships between this object and any other objects within the database. The purpose of the USERLIST object is to model the means to restrict access to some or all of the information based upon desired authorization levels. Each user will have a unique UserID that distinguishes them from all other users. Since UserID is the unique identifier the cardinality is 1:1. This results in each authorized user having exactly one UserID. The Password and UserGroup attributes also have cardinalities of 1:1 since each user requires a password in order to gain access and will require a user group identifier in order to determine which views of the data they are authorized and what modifications to the database they are allowed.

2. Maintenance Status/Aircraft Type/Rank/Flight Condition/Duty Positions

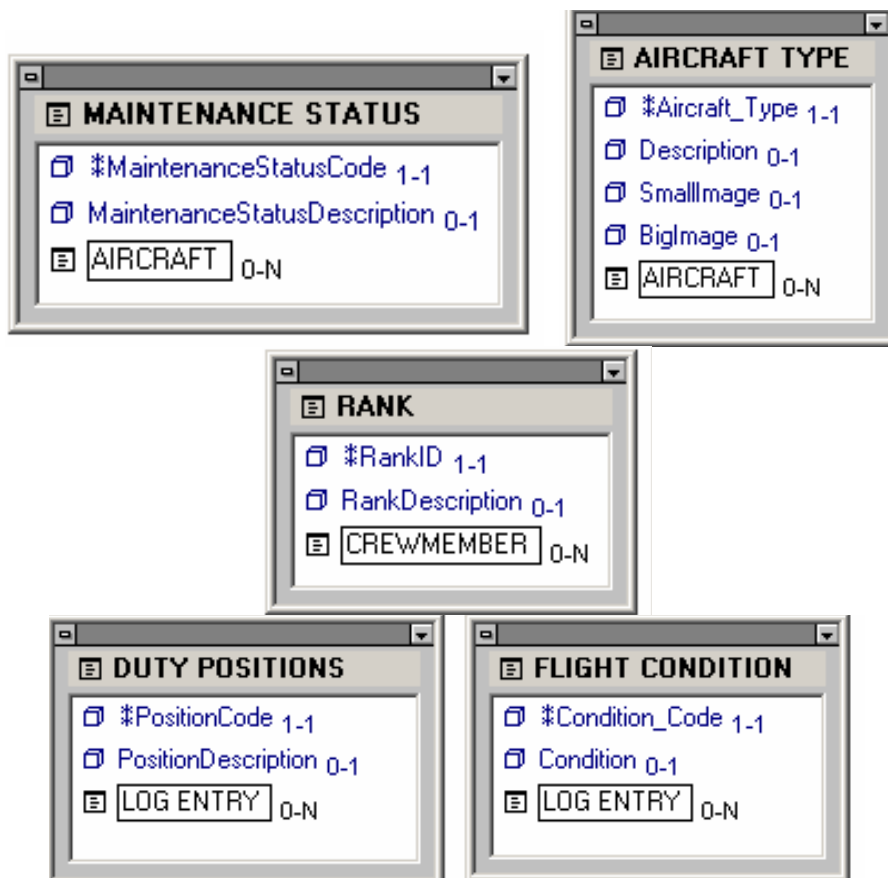

Figure 3. Maintenance Status, Aircraft Type, Rank, Flight Condition, and Duty Positions Semantic Objects

Each of these semantic objects serve the sole purpose of providing enumerated lists for attributes of other semantic objects in the model. These objects are used to populate menus that ensure data is entered into the database in a consistent manner. Each table has an abbreviated code that is the unique identifier for the object with a cardinality of 1:1 since the unique identifier is required for each instance. Each object also has an optional description for each abbreviation. An example instance for the RANK object would be RankID="CPT" and RankDescription="Captain." Each object also has the attribute that establishes its relationship with the other objects in the model. These relationships are all 0.N, or zero to many. For instance, a rank instance can exist in the table even without any crewmembers in the database that hold that rank, hence the minimum cardinality of 0; there also could be thousands of crewmembers in the database that all hold the same rank, hence the maximum cardinality of N. The aircraft object is the only one of these objects that has additional attributes; these attributes are used to hold the path to aircraft images that enhance the web interface but are not key to the data collection or reporting.

3. Crewmember

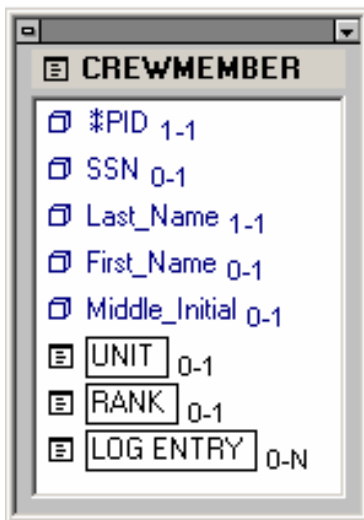

Figure 4. CREWMEMBER Semantic Object

The CREWMEMBER semantic object models real life flight personnel. The crewmember object will allow flight training data to be associated with individual

crewmembers and the crewmembers with units, and hence the flight data, to be associated with units. The identifier attribute for this object is PID; this is the same unique identifier that all crewmembers use in the current information system. It is composed of the crewmember's first initial, last initial, and the last four digits of their social security number. The only other required attribute is Last_Name with a cardinality of 1.1. SSN, First_Name, and Middle_Initial all have a cardinality of 0.1 since an individual may not have one of these attributes; if they do have these attributes, only one is allowed. The First_Name and Middle_Initial fields are long enough to facilitate the rare instances that individuals have multi-word first names or multiple middle initials.

The UNIT attribute establishes the relationship between the CREWMEMBER object and the UNIT object. The cardinality is 0.1 since a crewmember may not be assigned to a unit but can only be assigned to one unit at a given time. The RANK attribute establishes the relationship with the RANK object, which you will recall is simply an enumerated list to ensure standardized data entry. The cardinality is 0.1 to allow a crewmember to be added to the database even if the individual inputting the data is not aware of the crewmember's current rank, but limiting the rank to only one entry since a crewmember cannot simultaneously hold more than one rank. The LOG ENTRY attribute establishes the relationship between the CREWMEMBER object and the LOG ENTRY object. The LOG ENTRY object, which will be described later, holds information about flight duties performed by crewmembers. The cardinality is 0.N since a crewmember will not have any flight duty information when they are first added to the database, but eventually may have hundreds or thousands of log entries.

4. Unit

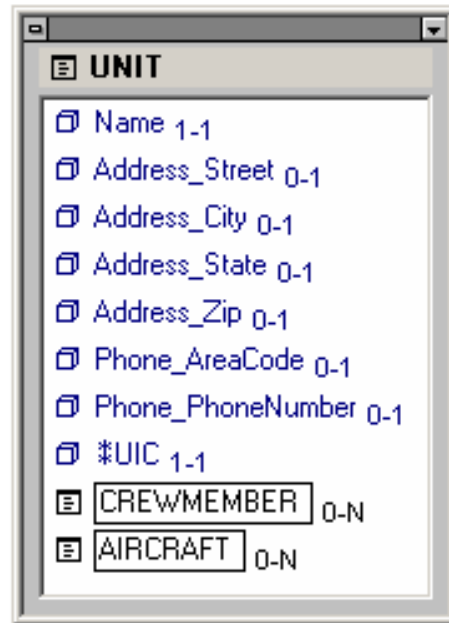

Figure 5. UNIT Semantic Object

The UNIT semantic object models the real life unit entity. It associates crewmembers and aircraft with the assigned unit, providing the capability of generating reports for individual aviation units. The unique identifying attribute is the UIC (Unit Identification Code). This attribute is used by the existing information system and is the standard identifier that uniquely identifies military units. The Name attribute is required and the unit cannot have multiple names, hence the 1.1 cardinality. The other descriptive attributes, such as address and phone number are not mandatory so the cardinality is 0.1. If it was deemed appropriate for the unit to have multiple phone numbers recorded, the maximum cardinality could be adjusted to reflect the maximum number of phone numbers allowed. The CREWMEMBER and AIRCRAFT attributes establish the relationship between the UNIT object and the respective CREWMEMBER and AIRCRAFT objects. The cardinality is 0.N for both of these attributes since initially units will not have crewmembers or aircraft assigned to them, but eventually will have many instances assigned to them.

5. Aircraft

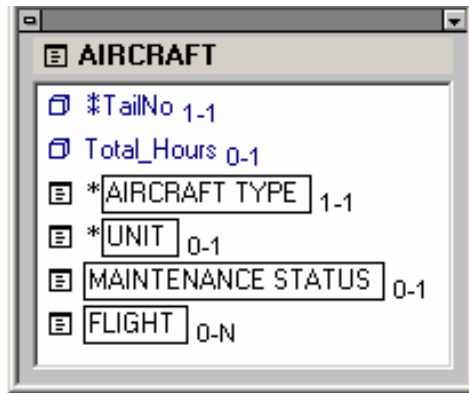

Figure 6. AIRCRAFT Semantic Object

The AIRCRAFT semantic object models a real life aircraft. It establishes primary relationships with the UNIT and FLIGHT objects. The unique identifying attribute is the aircraft tail number, again borrowing from standard existing procedures. The Total_Hours attribute is included with a 0.1 cardinality. It is not used in this prototype but is included for later iterations or deployment of the prototype. The total flight hours would be updated from data collected and stored in the FLIGHT object. The AIRCRAFT TYPE attribute establishes a 1.1 relationship with the AIRCRAFT TYPE object which is essentially an enumerated list to ensure data is input in a standardized manner. The MAINTENANCE STATUS attribute establishes a relationship with the enumerated list MAINTENANCE STATUS object. The cardinality is 0.1 in order to allow an administrator to add the aircraft initially even if knowledge of the maintenance status is unavailable. The UNIT attribute establishes the relationship of the AIRCRAFT object with the UNIT object using a 0.1 cardinality. The minimum cardinality is established at 0 to allow for instances when the aircraft is not assigned to a unit such as during the fielding of new aircraft. The maximum cardinality is established as 1 since the aircraft cannot simultaneously be assigned to multiple units. The FLIGHT attribute establishes the relationship with the FLIGHT object, which is a record of key information about each time the aircraft is flown. The cardinality is 0.N since initially there will be 0 flights associated with the aircraft and eventually there will be hundreds or thousands of flights associated with an aircraft.

6. Flight

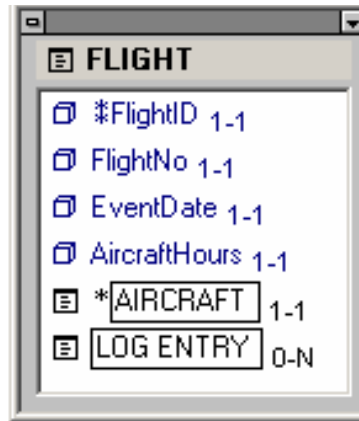

Figure 7. FLIGHT Semantic Object

The FLIGHT semantic object models each aircraft flight, essentially a record of each time the aircraft is flown. The FlightID attribute is an automatically generated unique identifier. The FlightNo attribute is a required attribute that records whether it is the first, second, or third, etc. flight of the day for the particular aircraft. The EventDate and AircraftHours attributes are also required attributes that identify the calendar date on which the flight was conducted and the total number of aircraft hours flown on that flight. The AIRCRAFT attribute establishes the relationship between the FLIGHT object and the AIRCRAFT object. The cardinality is 1.1 since each instance of the FLIGHT object must be associated with one distinct aircraft. The LOG ENTRY attribute establishes the relationship with the LOG ENTRY object which is record of individual crewmembers that conducted that flight. The cardinality is 0.N since the flight will initially not have any log entries, but will eventually have multiple log entries to record the details of each crewmember to include flight conditions and duty positions.

7. Log Entry

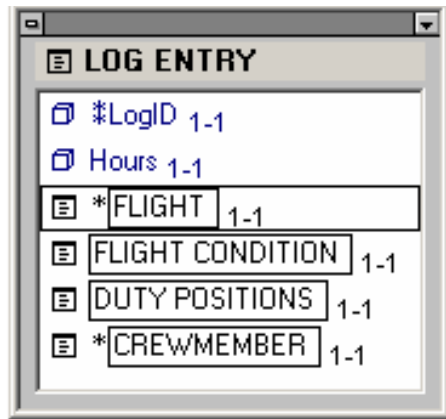

Figure 8. LOG ENTRY Semantic Object

The LOG ENTRY semantic object models each grouping of crewmember data associated with an individual flight as an entity. The LogID attribute is an automatically generated unique identifier. A separate log entry is required for each combination of Flight Condition, Duty Position, and Crewmember. The Hours attribute is required and applies only to the individual log entry and may not be the same as the aircraft hours for the entire flight. The FLIGHT attribute establishes the relationship with the FLIGHT object, the cardinality is 1.1 since each log entry must be associated with one distinct flight. The FLIGHT CONDITION and DUTY POSITIONS attributes establish the relationships with their respective enumerated list objects to ensure data is entered uniformly. The CREWMEMBER attribute establishes the relationship with the CREWMEMBER object, the cardinality is 1.1 since each log entry must have a distinct crewmember.

D. PROTOTYPE DATABASE SCHEMA

A good semantic object model makes the creation of a schema a very simple and mechanical process. Many modeling tools will automatically create the database or the designer can use the model to manually create the tables and relationships in the database. An easy to use semantic object model tool that provides the capability to build the model, generate a schema from the model, and even reverse engineer a model from an existing database is Tabledesigner. A trial version of Tabledesigner is available for

download from www.tabledesigner.com. The schema created in Microsoft Access by the semantic object model shown above is depicted in Figure 9.

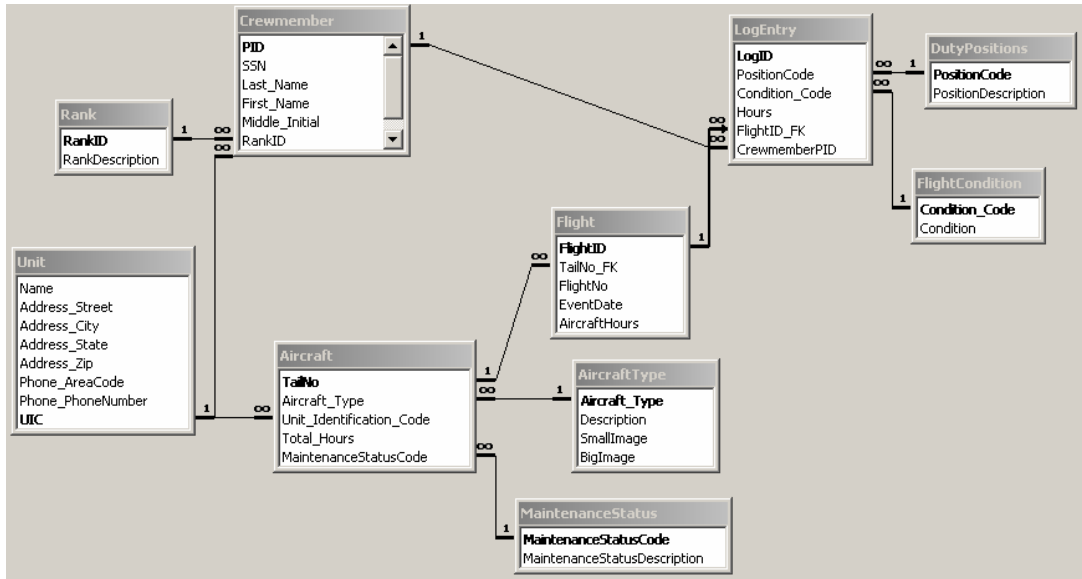

Figure 9. Database Schema

Each object in the semantic object model is transformed into a separate table. All tables within the database along with their relationships to the other tables are depicted in the schema. The USERLIST object from the model is not depicted as a table here since there are no relationships with any of the other tables. The relationships indicated are the same as those described in the conceptual model, but the cardinalities of each attribute are not as intuitively visible in this summary view. The unique identifier attribute for each table is shown in bold print. The primary advantage of this view of the database is that relationships between specific fields within the tables are depicted. The relationships are depicted with a line that shows the “join type.” A one-to-many relationship is the most common and is depicted using the numeral 1 and an infinity sign. The join types are determined by the cardinality of attributes that associate objects in the semantic object model. They depict how the tables are related.

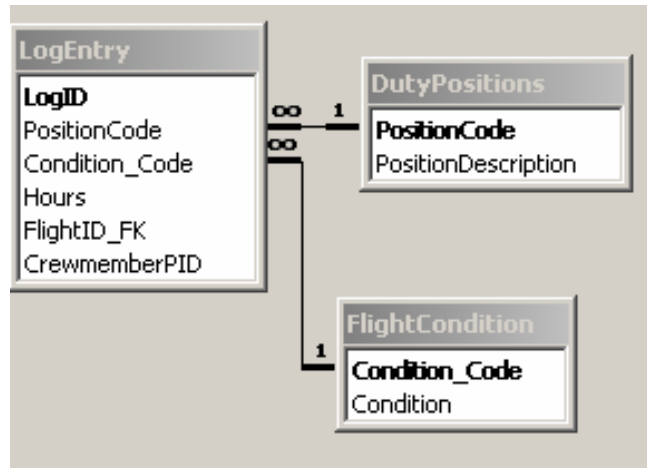

Figure 10. Join Type Depiction

The figure above shows the join types between the Log Entry table and the Duty Positions and Flight Condition tables respectively. The join type is read as each Log Entry can have only one Duty Position and only one Flight Condition stored in its Position Code and Condition_Code fields respectively, but both the Position Code and Condition_Code may be associated with many log entries. Key cardinalities can be determined in Figure 10 by viewing the join type. Within the LogEntry table, LogID has a cardinality of 1.1 since it is the identifier attribute and must be unique by definition. PositionCode and Condition_Code both have a 1.1 cardinality since they are required attributes of LogEntry and each instance of LogEntry can have at most one of each of these attributes. The maximum of one is indicated in the join type depiction by the “1” adjacent to the DutyPosition and Flight Condition tables. To view the cardinality of attributes that do not define relationships with other tables, such as the hours attribute within LogEntry, the user must view the database table to verify that the cardinalities are reflected as designed in the model.

This chapter detailed creation of the prototype conceptual semantic object model. It also discussed the relationships and attributes of each object in the model and transformation of the model into a database schema. Chapter IV will describe the process model that will relate how users interface with the database created by the conceptual data model.

IV. PROCESS MODEL

This chapter describes the process flow that users of the system will experience when they access the prototype. The initial process flow and subsequent process flows are discussed. A logical intuitive flow is the primary consideration in designing the prototype applications.

This chapter is organized as follows. Section A describes the initial process flow that all users will follow upon successfully logging into the prototype portal; Section B describes the aircraft process flow which allows the user to view, add, update or delete flight information; Section C describes the crewmember process flow which allows users to view, add or update crewmember information; and Section D describes the report process flow which allows the generation of tailorable crewmember and unit training reports, aircraft flight hour reports and aircraft status reports.

The process model is independent of the data model. It provides a structured flow that allows control of the data views and data modification capabilities that are provided to each user. In order to describe the process flow, I have broken it down into an initial flow that all users will see each time they access the Web application and then into separate process flows for each major sub-process.

A. INITIAL PROCESS FLOW

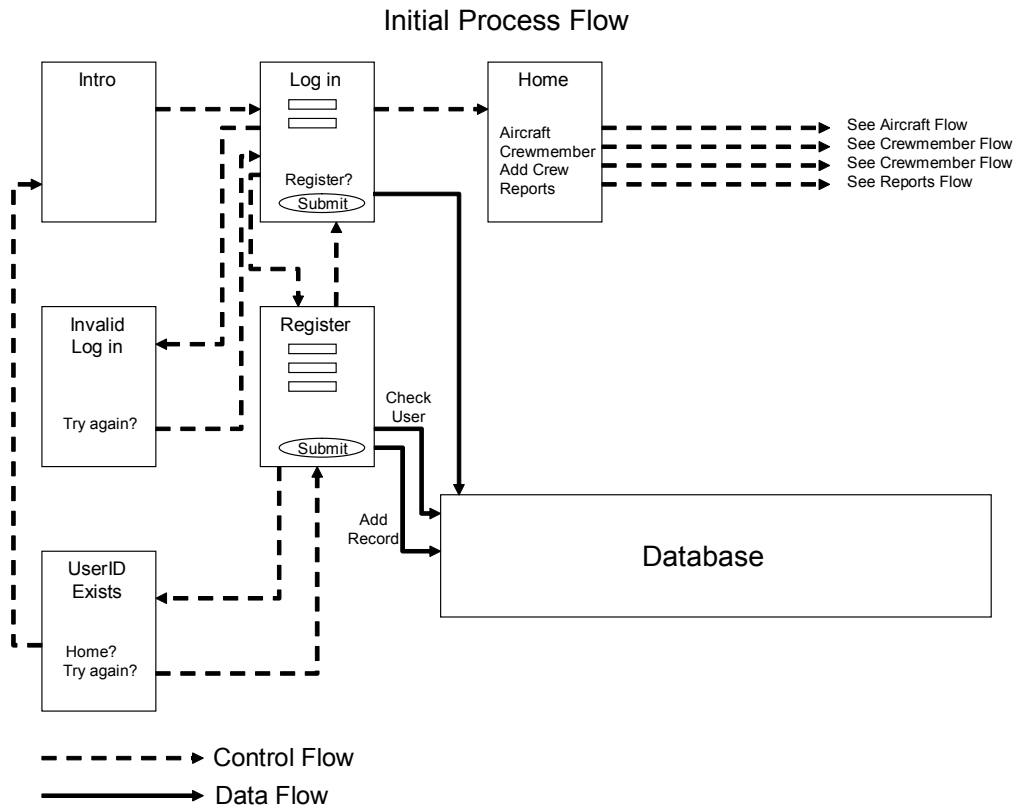

Figure 11. Initial Website Process Flow

1. Welcome Screen

The initial welcome screen identifies the prototype to the user and provides the user access to the user authentication page.

2. User Authentication

The log-in page allows registered users to authenticate themselves to the site using their UserID and password. Each user is assigned a user group by an administrator. The user group will provide or restrict access to certain pages and functions based upon that user group's privileges. The UserID and password are checked against the user list in the database. If the user is found in the database and the correct password is entered, the user will be allowed access to the prototype homepage which is the launching point for all other process flows. When a user enters an invalid UserID and password

combination, he will be directed to a page that advises them that his log-in attempt was invalid and offers him the option to retry his log-in. The log-in page also provides the ability for new users to register for limited access.

3. Registration

The new user registration page allows users to select a UserID and a password. The password must be entered twice for validation. When the registration is submitted, a form validation procedure checks to ensure that both password fields are identical. If the password fields do not match, the user will be given the opportunity to retype the passwords. Once the form is submitted, the requested UserID is checked against the list of currently registered users. If the UserID already exists the user can elect to return to the registration page in order to register with a different UserID. The default user group is automatically assigned to each user upon successful registration to provide the ability to view selected data within the site. Upon successful registration, the user is redirected to the log-in page. An administrator can change the user group to Crew, Commander, or Administrator in order to allow access to the appropriate data views and data modification capability.

4. Portal Home

The portal homepage is the launching point for all data views and data input functions. All pages from this point forward include a standard layout that features a navigation bar with links to each major sub-process and a link back to this portal home page. A log-out link is provided at the top of each page. The sub-process links include Aircraft, Crewmember, Add Crewmember, and Reports. The Add Crewmember link is part of the overall Crewmember process flow, but is provided to reduce the number of steps required when a new crewmember is being added that the user knows is not already in the system. The body of the portal home also includes a brief description of the functionality available within each sub-process and a direct link to those processes.

B. AIRCRAFT PROCESS FLOW

The aircraft process flow is entered through the portal home page through either the navigation bar or through the link within the body of the portal home. The initial entry page within the aircraft process is always the aircraft search page since all views and data input are related to an individual aircraft.

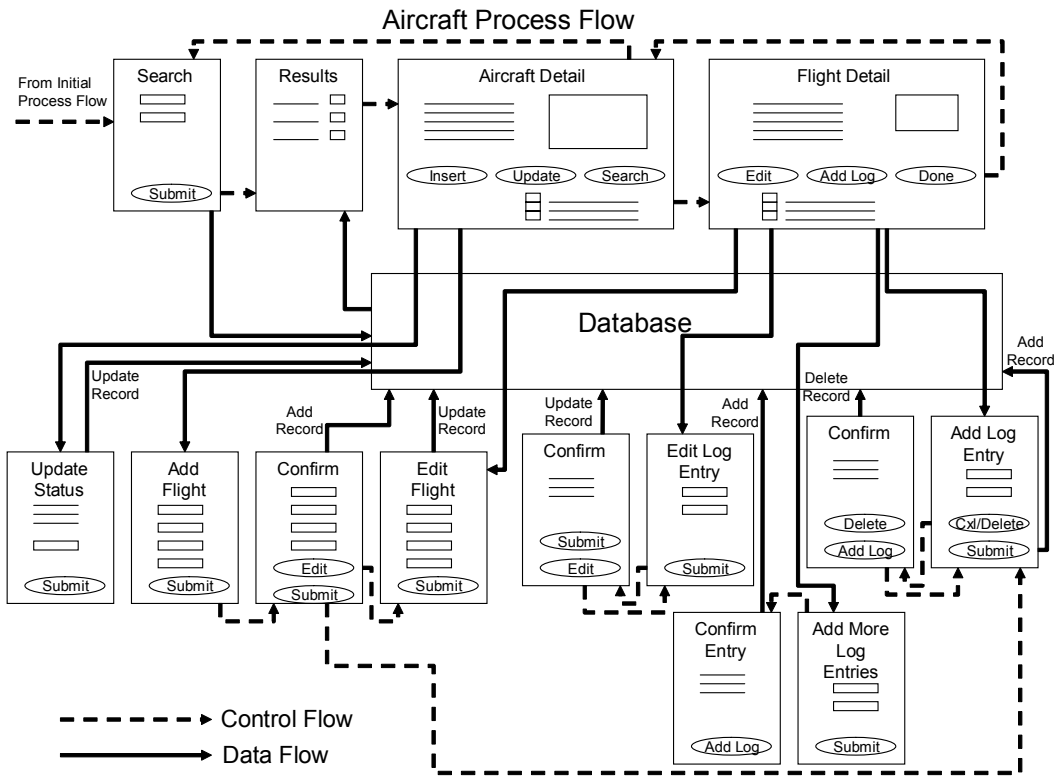

Figure 12. Aircraft Process Flow

1. Aircraft Search and Results

The aircraft search page allows the user to search for aircraft by the aircraft model, the unit to which the aircraft is assigned, or both. Conducting the search on “Any Model” and “Any Unit” will return all aircraft in the database. The searches are simplified by populating drop-down menus with all of the aircraft models and aviation units currently in the database.

The aircraft results page displays all aircraft that meet the search criteria as well as a visual display of what criteria were submitted for the search. The search results are sorted by aircraft tail number and displayed three records per page with navigation buttons to allow navigation through the results of the search. Each aircraft can be selected to provide the user a detailed view of data specific to that aircraft.

2. Aircraft Detail

The aircraft detail page displays the aircraft model, an image of the aircraft model, the aircraft tail number, unit to which the aircraft is assigned, current maintenance status and all flights associated with that aircraft. The options available to the user include:

a. Record a New Flight

This option is restricted to the Crew, Commander, and Administrator user groups. It allows users to record all relevant information about each aircraft flight. Selecting this option will direct the user to an add flight dialog page. The user selects the date of the flight using a calendar menu that ensures the date is added in the proper format, the flight number, and the total aircraft hours for the flight. When the form is submitted, the flight is recorded and the user is presented with a confirmation page that displays the flight information that was submitted. This confirmation page allows the user to verify the information and proceed to the add log entry page or proceed to an edit page to correct the flight data and then loop back to this confirmation page.

Once the flight data is confirmed the user is directed to an initial add log entry page, which is restricted to the Crew, Commander, and Administrator user groups. Users are required to either add the details for the first log entry (Crewmember, Duty Position, Flight Condition and Hours) or to cancel the add log entry process. Since at least one log entry is required for each flight, canceling the log entry process at this point will delete the flight record. To prevent accidental deletion, the user is directed to a confirmation page where they must confirm that they desire to delete the flight record or else return to the add log entry process. Once the first crewmember has been added to the

flight, the user is directed to the flight detail page that displays the flight information and log entries. Additional log entries can be added from this detail page with a similar process. The only exception is that the flight record will not be deleted if the add log entry procedure is aborted. The flight detail page will be discussed in greater detail below.

b. Update Maintenance Status of Selected Aircraft

This option which is restricted to the Crew, Commander, and Administrator user groups, allows users to modify the current maintenance status of the aircraft. The user is directed to an update page where the maintenance status is selected from a menu populated by the acceptable status options in the database. Once the new maintenance status is selected and the form submitted, the user is returned to the aircraft detail page which will reflect the updated status.

c. Search for a Different Aircraft

This option is a quick link back to the aircraft search page and is primarily used when the user is finished working with the current aircraft. The user can also use the navigation bar to return to the aircraft search page.

d. View Flight Details

The flight details of all existing flights for the aircraft are displayed on the aircraft detail page with the most recent flights shown first. Three records are displayed per page with navigation buttons to allow navigation through the remaining list of flights. Each flight can be selected to view the details of that flight.

3. Flight Detail

The flight detail page displays the aircraft tail number, date of flight, flight number, aircraft hours, and log entries associated with that flight. The options available to the user include:

a. *Edit Flight Mission Data*

This option, which is restricted to the Crew, Commander, and Administrator user groups, displays the edit flight process that was discussed during the add flight process. Upon submission of the updated flight data, the user is returned to the flight detail page which will display the updated flight data.

b. *Add Log Entry to Flight*

This option, which is restricted to the Crew, Commander, and Administrator user groups, directs the user to an add log entry page that displays the flight data. The user selects the crewmember, flight condition and duty position from drop-down menus and manually enters the hours. The user can abort the entry which will return the flight detail page without adding a log entry or submit the log entry, returning the flight detail page with the new entry reflected.

c. *Flight Entry Complete*

This option provides a quick link back to the aircraft details page once the user has finished adding or editing the flight and log entry data.

d. *Edit Log Entry*

This option, which is restricted to the Crew, Commander, and Administrator user groups, allows the user to select any of the existing log entries and directs the user to an edit log entry page. The user has the same drop-down options as the add log entry page. After submitting the modifications the user is returned to the flight detail page. The user also has the option to abort the edit log entry process or delete the log entry from within the edit log entry page.

C. CREWMEMBER PROCESS FLOW

The crewmember process flow is entered through the portal home page through either the navigation bar or through the link within the body of the portal home. The

initial entry page within the crewmember process is the crewmember search page unless the user elects to enter the add crewmember process directly from the project portal.

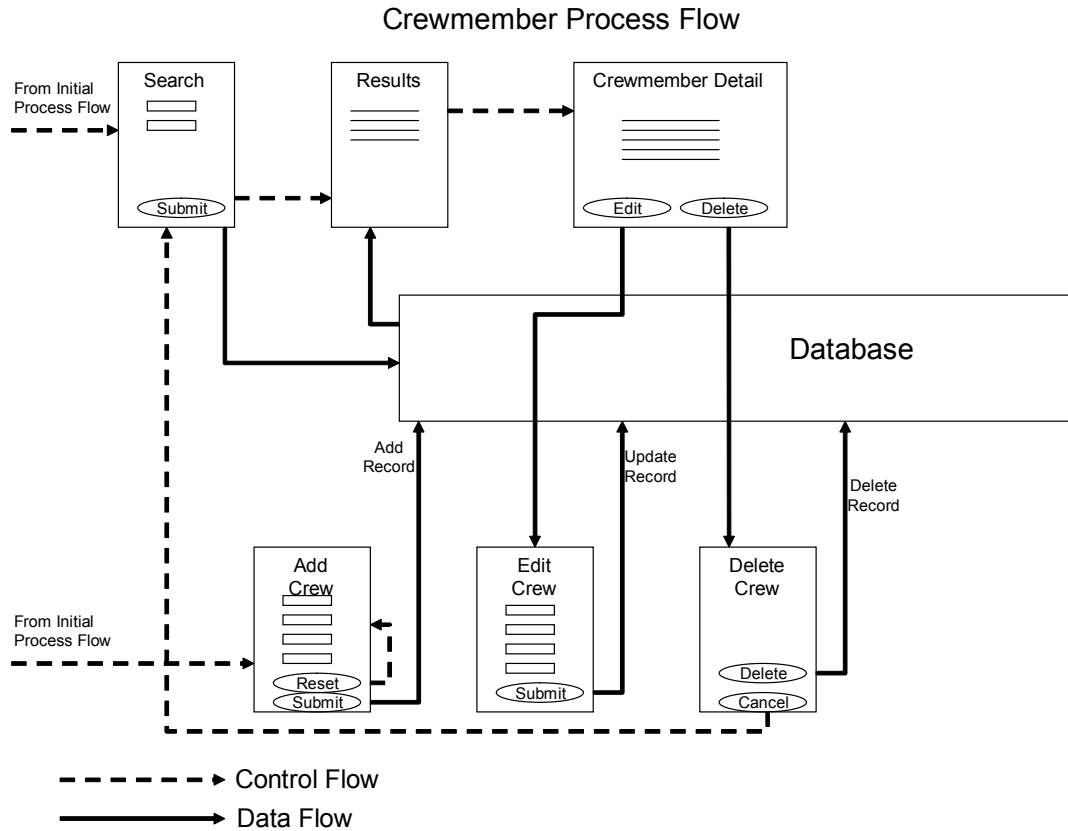

Figure 13. Crewmember Process Flow

1. Search

The crewmember search page allows the user to search for crewmembers by rank, the unit to which the crewmember is assigned, or both. Conducting the search on “Any Rank” and “Any Unit” will return all crewmembers in the database. The searches are simplified by populating drop-down menus with all of the ranks and aviation units currently in the database.

The crewmember results page displays all crewmembers that meet the search criteria as well as a visual display of what criteria were submitted for the search. The search results are sorted alphabetically by last name and displayed three records at a time

with navigation buttons to allow navigation through the results of the search. Each crewmember can be selected to provide the user a detailed view of data specific to that crewmember.

2. Crewmember Detail

The crewmember detail page displays the crewmember rank, complete name, unit assigned, and PID. The social security number is not displayed in order to comply with the Privacy Act. The options available to the user include:

a. Edit Crewmember Information

This option, which is restricted to the Commander and Administrator user groups, allows users to update crewmember data to include social security number. The PID cannot be updated since it is used as the unique identifier that links the crewmember to log entries. After submitting the updates, the user is returned to the crewmember detail page which will reflect the new data.

b. Delete Crewmember Record

This option which is restricted to the Administrator user group, allows administrators to delete a crewmember. This action would normally be conducted only when a crewmember was added erroneously. After an administrator deletes a crewmember record, they are redirected to the crewmember search page.

3. Add Crewmember

This option, which is restricted to the Commander and Administrator user groups, is accessed directly from the portal home page. The user is provided with drop-down menus for rank and unit, the remaining fields must be manually entered. Upon submission of the crewmember data, the user is redirected to the crewmember search page.

D. REPORT PROCESS FLOW

The report process flow is entered through the portal home page through either the navigation bar or through the link within the body of the portal home. The initial entry page is a menu that allows the user to select from training, operational readiness, aircraft hour, or aviation unit reports.

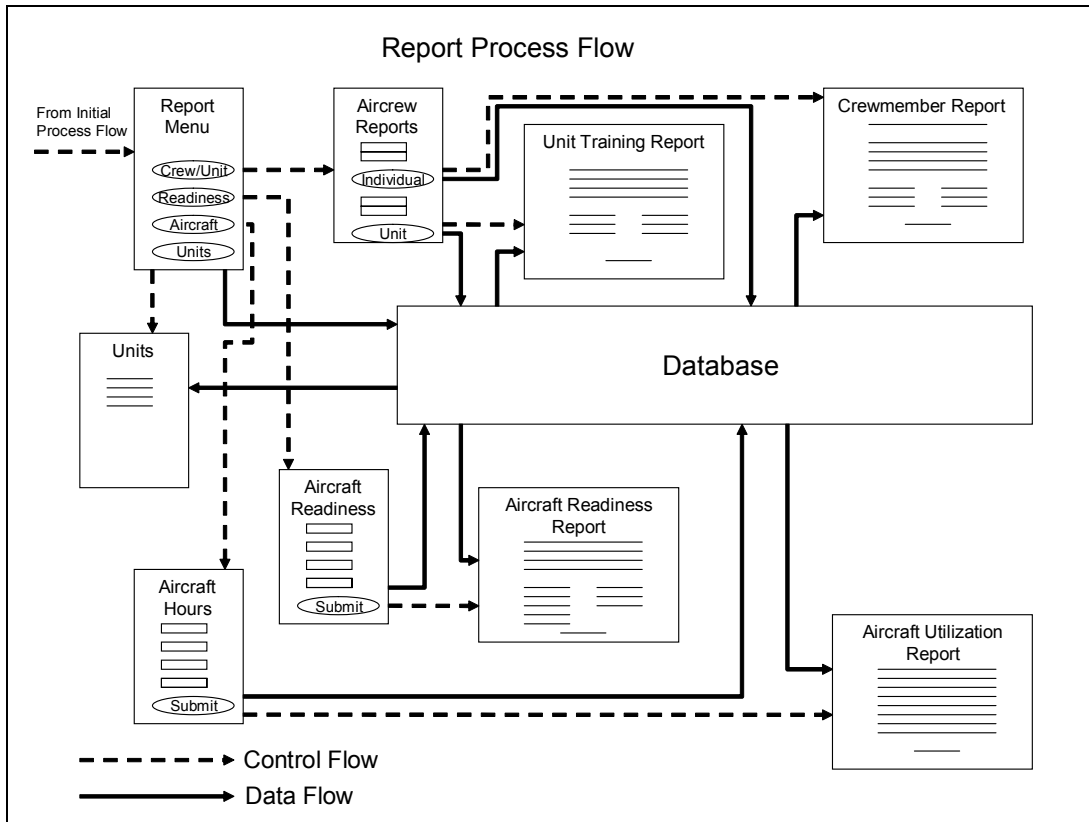

Figure 14. Report Process Flow

1. Training Reports

The training reports process allows the user to create a customized report for either an individual crewmember or an aviation unit. A calendar menu allows the user to select a beginning and end date for the report period. The date function allows the generation of standard or ad hoc reports for any desired time period. Upon submission of the report request the user is directed to a report detail page that displays the criteria for the report, all log entries that occurred within the time period, and summary data for

flight conditions, duty positions, and total flight time. The log entries are also user sortable for each attribute of the log entry.

2. Maintenance/Aircraft Readiness

The readiness report process allows the user to generate a current maintenance report based upon an individual aircraft tail number, a specific aviation unit, or an aircraft model. Upon submission of the report request, the user is directed to a report detail page that displays the criteria for the report, all aircraft that meet the criteria of the report, and summary data reflecting the number and percent of aircraft that are in each maintenance status. The results are also user sortable by tail number, aviation unit, and maintenance status.

3. Aircraft Utilization

The aircraft utilization report process allows the user to create a customized report for an individual tail number, aviation unit, or aircraft model. A calendar menu allows the user to select a beginning and end date for the report period. The date function allows the generation of standard or ad hoc reports for any desired time period. Upon submission of the report request the user is directed to a report detail page that displays the criteria for the report, all aircraft flights that occurred within the time period, and the total flight time for all flights. The flights are also user sortable by date, tail number, aviation unit, and flight hours.

4. Aviation Units

The unit report process allows users to view all aviation units. The user is directed to a detail page that depicts key unit information. The units are sorted alphabetically by unit name and displayed three units at a time with navigation buttons to allow navigation through all aviation units included in the database.

This chapter described the process flow model that provides the basis for building the prototype user interface. At this point everything necessary to create the prototype is completed. Chapter V will discuss considerations for implementation and deployment of the prototype.

V. PROTOTYPE IMPLEMENTATION AND DEPLOYMENT

This chapter discusses the implementation of the prototype and considerations for deployment of the prototype to include issues of security, beta testing, and deployment.

This chapter is organized as follows. Section A provides an overview of Dreamweaver, the tool used to implement the prototype; Section B discusses implementation design considerations; Section C discusses the construction of the prototype; Section D reviews challenges related to the implementation tool; Section E discusses the assembly, testing and deployment of the site; and Section F discusses the deployment of the prototype.

A. OVERVIEW OF DREAMWEAVER

The tool used to develop the prototype is Macromedia Dreamweaver MX. Dreamweaver is a professional HTML editor that assists in the design, coding, and development of websites and web applications. Dreamweaver provides the ability to create a dynamic site and link the site to data sources with minimal training and very little knowledge of HTML tags or the ability to write code. Dreamweaver assists in the development of database-backed applications using a variety of server models, including ASP, ASP.NET, JSP, and PHP.(McGinn,2002,p.11) Dreamweaver offers a Windows-based graphical interface with extensive formatting capabilities, simplifying the rapid design of HTML and ASP pages. The use of templates and style sheets provides the ability to standardize the appearance of a website. Dreamweaver also provides automatic coding for many server behaviors such as database connection, generation of recordsets through database queries, form validation, user authentication, as well as the ability to insert, update, or delete records.

The capabilities of Dreamweaver are fairly extensive, but most custom sites will desire additional capabilities. Macromedia hosts the “Macromedia Exchange” website that allows developers to upload custom code written to supplement the existing Dreamweaver objects, commands, and behaviors. These “add-in” extensions are either

free or charge a nominal fee to download. Common custom extensions include pop-up calendars and enhanced form validation. Dreamweaver also allows developers to readily include their own custom code and debug it directly in Dreamweaver.

B. IMPLEMENTATION DESIGN CONSIDERATIONS

Design considerations include appearance, colors, fonts, and navigation. The design should focus on ease of use and functionality. Colors and fonts used should be appealing and appropriate to the target audience or users. Graphics and flashy layout may be added when they enhance the appeal or usability of the site, but should be avoided if they detract from the sites utility or hinder performance. It is helpful to know the normal access mode and minimum expected connection speed of the site users. If a broadband connection is the normal mode, graphics that enhance the site are helpful; however, if a dial-up connection is the normal usage mode, only essential graphics should be included. Macromedia Fireworks is a good image editor that allows editing of images from within Dreamweaver. Fireworks allows the designer to save the image in a variety of formats and provides an estimated time to load the image in a web browser based upon various connection speeds. Another alternative when graphics are desired is to create a graphical site with a text only version of the site for slower internet connections.

A site should not unnecessarily force users to follow extended link sequences when it is feasible to simplify the flow. Developers should understand the normal user workflow for the site and provide direct links to common or recurring pages. When designing the site, the normal user workflow for each major user group should be considered. Significant time savings and a professional looking site can be achieved best by selecting a color scheme and fonts, as well as acquiring or creating all desired images prior to creating and assigning behaviors to pages. Creating templates that are then used to create subsequent pages ensures a uniform look and allows future modifications to all pages by simply updating the template. Style sheets are another useful technology to provide consistency and rapid design modifications to the site. Specific fonts and colors can be saved for common items such as links, titles, and body text. These style sheets

can then be attached to provide standardized formatting and allow modifications to be applied to the entire site through updating the style sheet.

C. CONSTRUCTING THE PROTOTYPE

Construction of the prototype is not recommended until the images, layout, fonts, colors, and templates discussed previously have been established. The process flow model provides an orderly sequential page design sequence to ensure that the desired variables are passed between pages following the normal user flow. The first pages to create will generally be the introduction and user authentication pages. These pages may require a separate template that does not provide links directly into process flows of the site; an example is shown in Figure 15. These pages can be created, to include authentication of users and user groups, but applying restrictions to subsequent pages should be deferred until the site is near completion since the restrictions will prevent the ability to preview pages from within Dreamweaver during design.

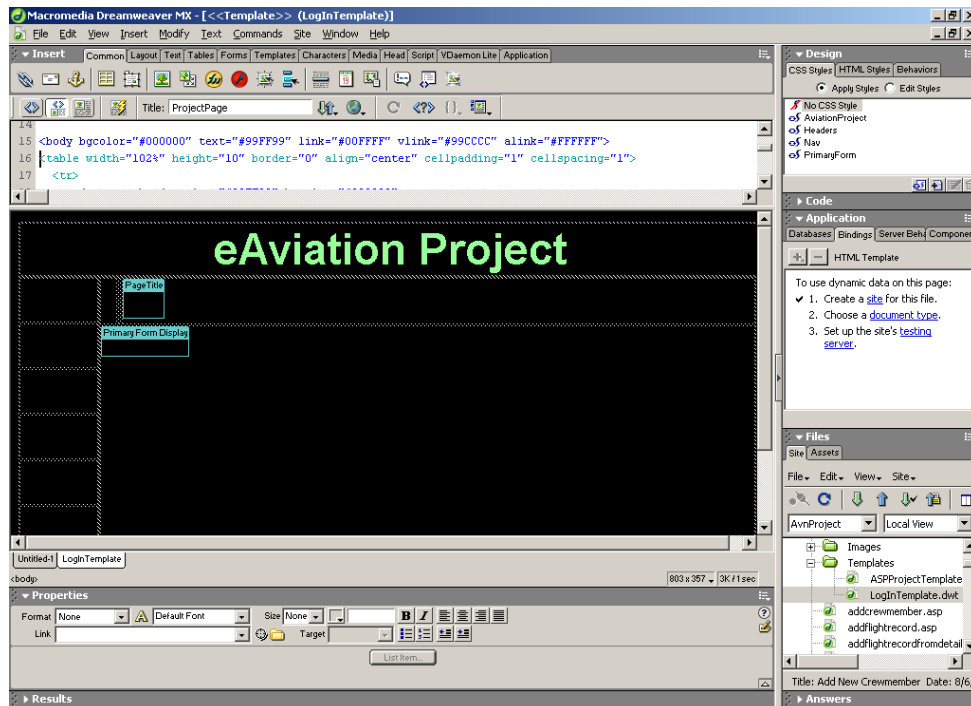

Figure 15. Log-in Template with Dreamweaver workspace view

After users log in to the site, sufficient information should be provided to assist them with navigating the site without unnecessarily cluttering the page (see Figure 16).

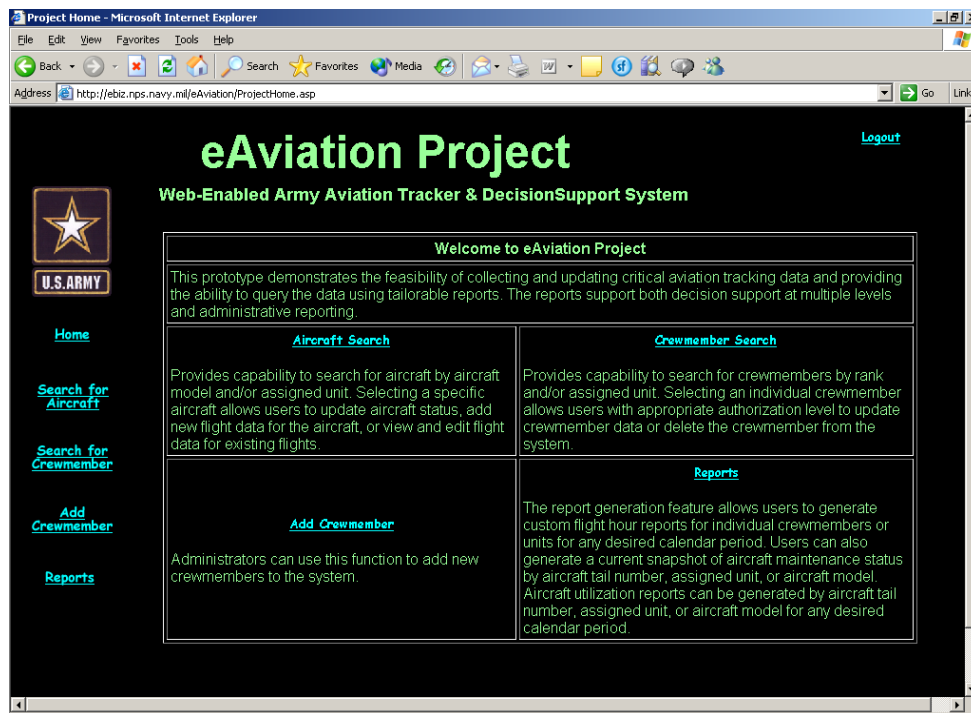

Figure 16. eAviation Project Welcome Screen

The primary sequence used in this prototype is Search-Results-Detail. To construct a search page, specific search criteria must be user selectable and then passed to the results page. Drop-down menus generated from lookup tables within the database, ensure that at least one instance of the search attribute exists within the database and prevents unsuccessful searches and avoids the introduction of typing errors. Figure 17 depicts a typical search page. The results page should display the criteria of the search, this will require some minor code editing if the search allows any record of a specific search attribute to be displayed. The built-in Dreamweaver behavior will display the search variables that were selected, but the wildcard variable “%” that indicates all records were selected is not meaningful to system users. The designer must create a record set on the results page that queries the database based upon the criteria passed from the search page. The results should be limited to the number of records that can be displayed on a page, similar to Figure 18. Dreamweaver provides the ability to insert

record navigation buttons or text to facilitate perusal of all results. In the prototype each aircraft or crewmember found on a results page provides a direct link to a detail page for that specific aircraft or crewmember. Figure 19 depicts a typical detail page.

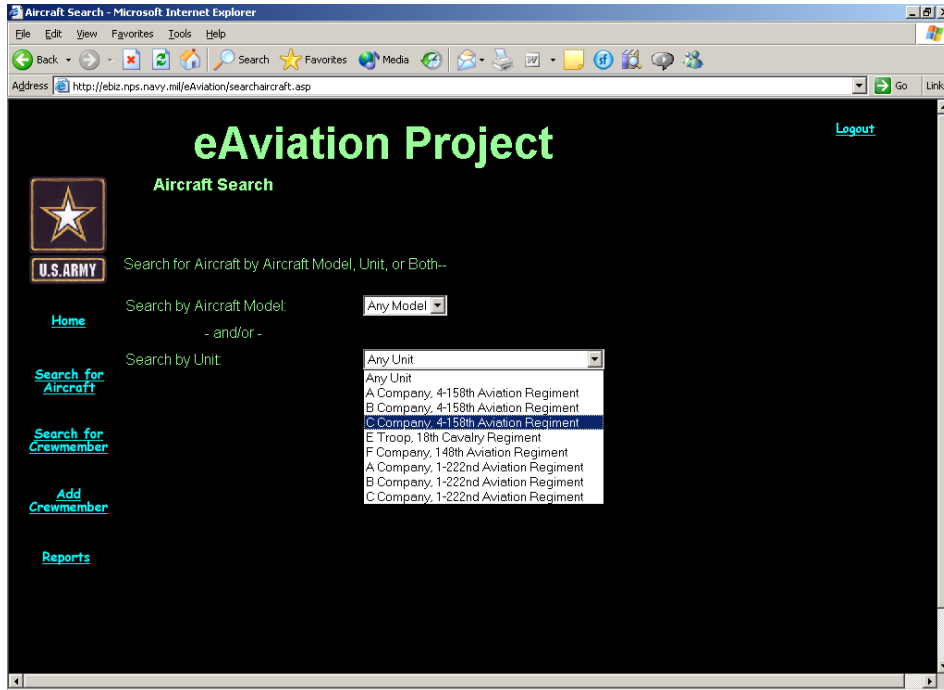

Figure 17. eAviation Project Aircraft Search Page

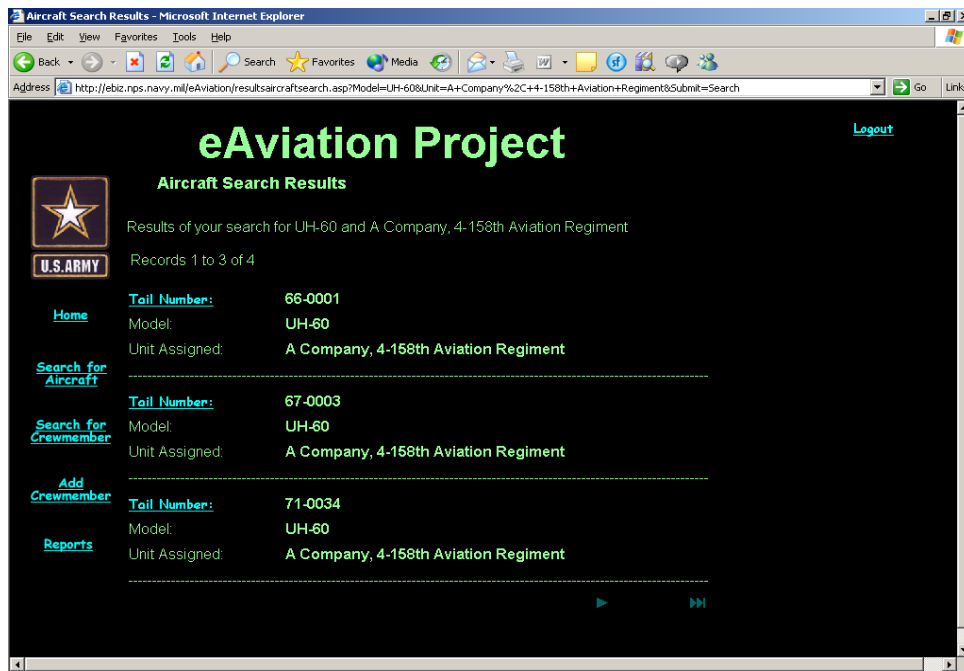

Figure 18. eAviation Project Aircraft Search Results Page



Figure 19. eAviation Project Aircraft Detail Page

Dreamweaver provides built-in behaviors to insert, update and delete records from the database. Figure 20 depicts a typical insert record page and Figure 21 displays the application of the behavior in Dreamweaver.

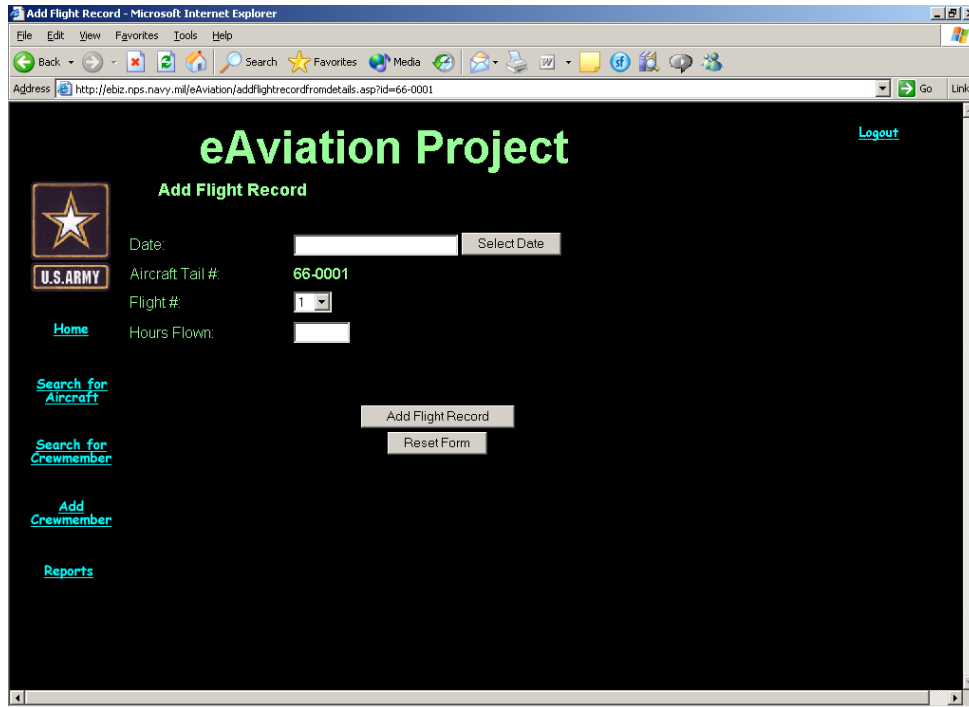

Figure 20. eAviation Project Add Flight Record Page

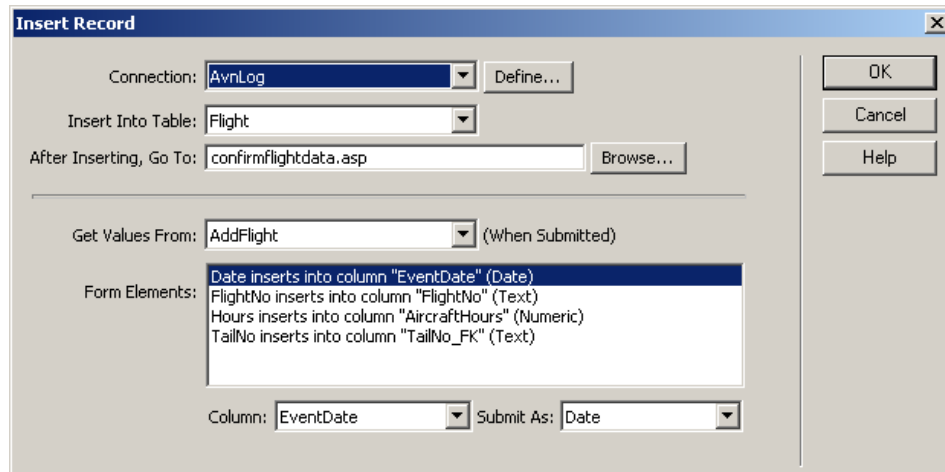

Figure 21. eAviation Project Application of Insert Record Behavior

The creation of a form within the page, along with a “submit” button labeled with the desired action provides the ability to insert, update, or delete records. When the desired behavior is selected, Dreamweaver attempts to automatically match the form elements with the appropriate field in the database table, but also allows the designer to verify that each field is associated with the appropriate form element. After each page

from the process flow has been created and tested, necessary restrictions for individual users or user groups should be assigned. This is conducted easily using Dreamweaver's user Restrict Access to Page behavior.

D. TOOL CHALLENGES

Dreamweaver is an outstanding tool to create dynamic websites, however there are a few minor challenges associated with using Dreamweaver. Errors in the code or in recordset queries can prevent pages from loading properly in the browser. The error messages can be somewhat cryptic, providing only generic error messages. Generally there are two basic types of messages: 1) Database related, which will usually include terms such as "Microsoft OLE" or "too few parameters"; or 2) Script (code) errors that will indicate the line number associated with the code that caused the failure. The database error message indicates that the developer should review and test the recordset queries to ensure that they are formed properly and don't return an empty recordset. The script errors require analysis of the specific line(s) of code that are not executing properly. Frequently deletion of a behavior results in only partial deletion. When this occurs, complete deletion of the behavior will require either direct code manipulation or rebuilding the page. A common script error involves duplication of the page type or re-declaration of the same variables. Simply deleting the lines of code that are repetitive will solve these problems.

E. ASSEMBLING, TESTING, AND DEPLOYING THE SITE

A site can be developed and tested directly on a server or locally on the computer used for developing the website. Development on a local machine is very beneficial since it allows complete testing of the site regardless of whether the deployment server is continuously available as a mapped drive. Development on a local machine is accomplished using Internet Information Services (IIS). IIS is a Windows component available with Windows versions XP Professional, 2000, or NT. IIS also doubles as an application server on the local development computer.

Connection to the database can be accomplished by defining a custom connection string within Dreamweaver that points directly to the database on the testing server. The other option, which simplifies deployment, is to define a Data Source Name (DSN). A DSN can be defined using Administrative Tools within the Windows Control Panel. Defining a DSN with the same name on the deployment server allows uploading the site to the deployment server without losing database connectivity or requiring modifications to the website. In order for website users to insert, update, or delete records in the database, security settings for the database folder and the database must allow internet users to modify the database.

When developing the site on a local computer, the local folder where the files will be stored and the location of the testing server must be defined. Figure 22 and 23 depict the local and testing server set-up.

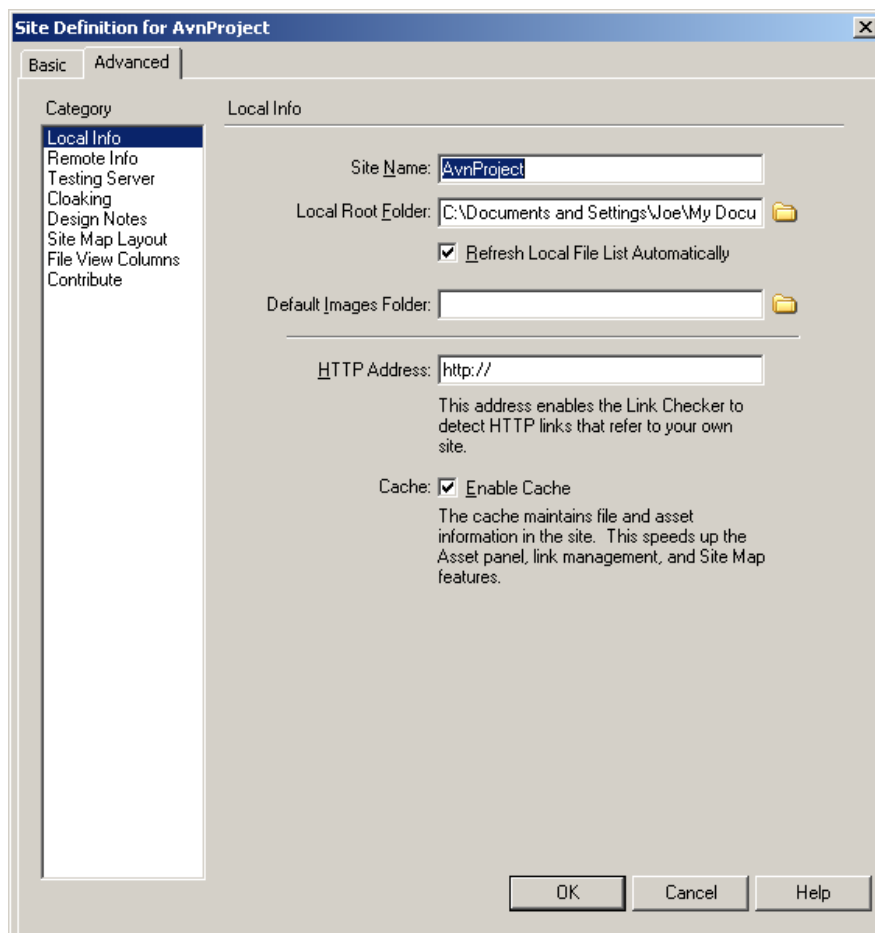

Figure 22. eAviation Project: Local Site Definition

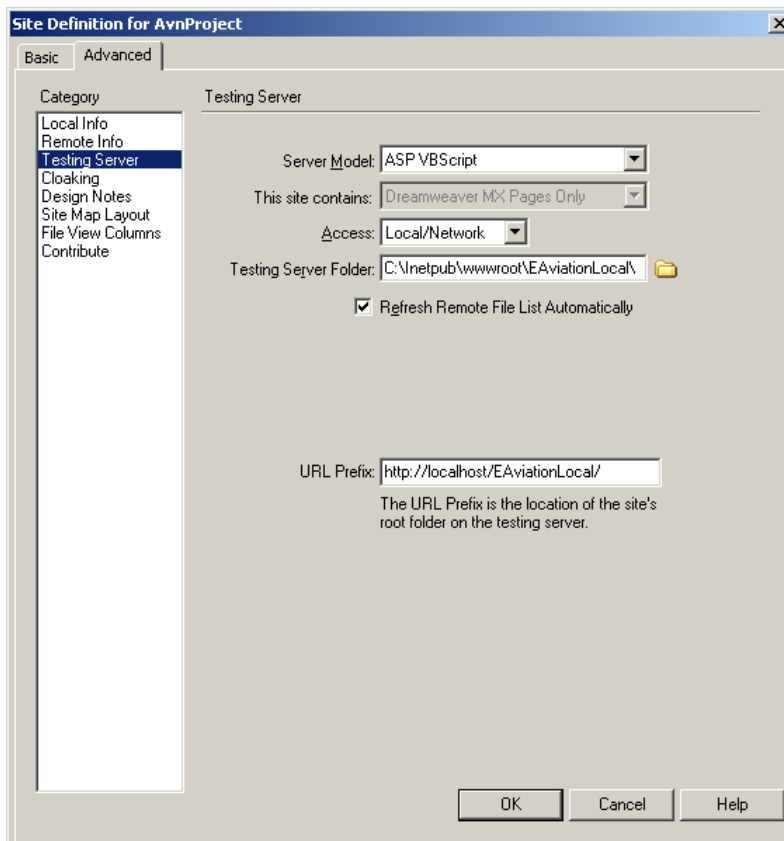

Figure 23. eAviation Project: Testing Server Site Definition

A separate folder for each site within the testing server will prevent unnecessary files getting uploaded to the deployment server. The path using IIS should look like “C:\inetpub\wwwroot\foldername.” Creation of a separate database folder within the testing server provides the ability to allow internet users to modify the database without allowing modification of the website. Copy the database into this folder and ensure that the security settings are correct for the database and database folder. Within Dreamweaver, the entire site from the local view is “put” to the testing server. This method allows complete functionality testing on the local machine during development. Deployment of the site to the deployment server, involves editing the site by adding a remote site. The remote site essentially is the folder on the deployment server. Figure 24 shows the definition of a remote site.

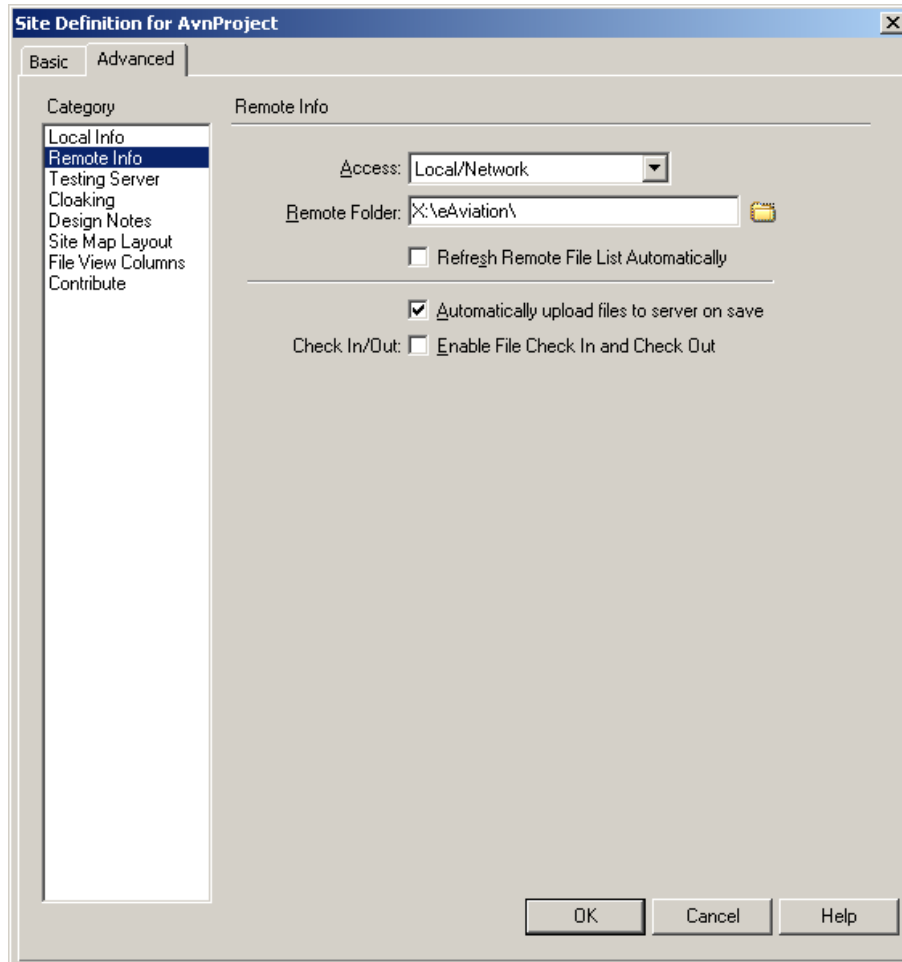

Figure 24. eAviation Project: Remote Site Definition

After the site has been uploaded onto the deployment server, the correct security settings on the database and database folder should be verified and a DSN defined. Occasionally add-in behaviors may not transfer properly, so it is important to test the functionality of each page and reapply behaviors if necessary.

F. DEPLOYING THE PROTOTYPE

The aviation project prototype is suitable for deployment on a local area network for a beta test flight operations center. A detailed analysis of security requirements, which is beyond the scope of this thesis, should be conducted since sensitive information including social security numbers, aggregated aircraft readiness and aggregated training information will require stronger security protocols than a simple UserId and password

system offers. Secure socket layers is likely to be appropriate. An initial recommendation to meet internet security requirements is to piggyback onto the security and authentication used for Army Knowledge Online (AKO). This level of security should be sufficient as long as the aggregated information remains at an unclassified, For Official Use Only (FOUO) level. The restriction to beta testing with actual flight data only on a local area network could be lifted once appropriate security personnel certify security requirements for use on the internet.

As mentioned above, the first beta version should be tested in flight operations to allow modifications based upon feedback before conducting a beta test with the flight crews which will ultimately be the primary individuals conducting data input. The flight operations is already taking paper copies of flight data and manually entering this data into their existing system. The number of personnel that will need to be trained on the prototype beta would be minimal and does not significantly impact the workflow of the flight operations. A design team representative should be present throughout the initial beta to capture as much feedback as possible through observing the flight operations personnel along with conducting interviews. Success of the initial beta is determined by the ability to generate all currently required unit and crewmember training reports, to include any ad hoc report requests that occur during the beta. The results of the initial beta should be used to modify the data and process models for a second beta test.

Prior to the second beta test, an interface between the prototype database and the maintenance management database should be developed. This will allow an incremental implementation that keeps the existing maintenance management system fully functional and allows for potential future expansion of the prototype if desired. With this database interface in place for the second beta test, this keeps aircrews from experiencing the prototype beta as an additional requirement. The crewmember will simply begin conducting data input on the prototype beta with the data feeding directly to the existing maintenance management system through the database interface and will actually reduce the workload of the flight operations section since the data they have historically recorded manually from the paper copy forms the crewmembers complete will be entered into the prototype directly by the crewmember.

During each beta test a separate evaluation of the decision support features should be conducted. The traditional users of the report information generated by the flight operations section involved in the beta test would be the initial focus but select representatives from higher echelon stakeholders would also be included to evaluate format and ease of use for the decision support reporting capability. A potential future consideration for designing views of the data could include adding a dashboard type visual display of the data. The dashboard type display should not require any modifications to the data model or the database, but could be written exclusively by conducting appropriate queries of the database.

This chapter described the implementation of the prototype to include tools, design considerations, challenges, and assembly of the site. Deployment of the prototype considerations and recommendations were also discussed. Chapter VI will summarize the project development, draw conclusions, and propose future research.

THIS PAGE INTENTIONALLY LEFT BLANK

VI. SUMMARY, CONCLUSIONS, AND FUTURE RESEARCH

This chapter summarizes the analysis, modeling and implementation of the prototype. Conclusions are then drawn about the implementation of this prototype and are generalized to benefit the development of future web-centric information systems. The chapter also presents directions for future research opportunities.

This chapter is organized as follows. Section A summarizes the project; Section B discusses conclusions drawn from the project; and Section C proposes future research recommendations.

A. SUMMARY

This thesis reviewed the existing Army Aviation flight data management process including its regulatory requirements. The primary area identified for improvement was the data collection process. The current process has unnecessary redundancies and significant logistical burdens. A secondary area identified for improvement was the timely availability of flight data for decision making and report generation. Based upon these identified areas for improvement, this thesis focused on the development of an internet-centric information system to replace the data collection process for aircraft and crewmember flight data combined with customizable queries for decision support.

The development of the prototype web-enabled database along with guidelines for development was reviewed. This development focused on the conceptual data model, transformation of the model into a database schema, the process flow model and the creation of a functional prototype.

Significant potential benefits identified include: 1) Reducing the logistical burden on unit's data collection procedures, providing the potential allocation of this time to aircraft maintenance and primary mission accomplishment; and 2) The ability to provide tailorable, near real time information about aircraft maintenance status, individual training, and unit training to decision makers at all levels as a decision support tool.

B. CONCLUSIONS

The Army has the potential to reduce the man hours currently expended recording and reporting administrative data, reduce the logistics requirements for collecting aviation flight data and provide near real time visibility of training and maintenance to any desired echelon of command in tailorable views.

The reduction in time spent entering data would allow the crewmembers time to be allocated to aircraft maintenance providing higher aircraft availability to conduct training and actual missions. It also can reduce the opportunities for inducing errors through manual transcription of data. The common entry point for data used in maintenance management and flight training also eliminates discrepancies between the two systems.

The internet based data collection system reduces the logistical burden on flight units by aggregating the software and hardware at central locations. This provides the capability of upgrading the system without the necessity of physically upgrading the data input or processing devices at the flight unit. The need for additional notebook computers is eliminated, allowing existing computing devices with a web browser to fulfill that role. This further reduces the need for spare notebooks, lengthy data transfer processes and technicians to troubleshoot problems with the existing notebook computers.

The near real time aggregation of flight data in a centralized database will allow queries at each echelon of supervision. The benefits of this are twofold; the information is available when needed for decision making purposes and the flight company is not tasked with excessive report generation requirements when ad hoc reports are deemed necessary. The near real time availability of information about both training and maintenance will allow trend analysis and the ability to address issues in a timelier manner along with providing details needed to make decisions about unit employment. The flight operations and flight company leadership would spend considerably less time responding to standard and ad hoc report requests, allowing them to focus on leadership and training.

C. FUTURE RESEARCH

There are several opportunities for extending this research both related to this prototype and to web-enabled database development in general. The three primary areas that I recommend are security, database interfaces, and visual dashboard display.

A detailed analysis of security requirements is needed for DoD website deployment, specifically focused on the changing requirements as information is aggregated for decision support. The deployment of this prototype would likely result in eventually migrating to smaller wireless devices. Research about security needs for wireless PDA type devices would also be beneficial. Another security related research opportunity is analyzing the potential of sharing authentication capabilities with existing DoD portals such as Army Knowledge Online (AKO).

Research about potential interfaces between a prototype web-enabled database and existing backend systems, such as the maintenance management system, would also be very useful. This research could specifically focus on selecting strategies for seamless data flow between the Web and the backend applications.

A very promising area for future research would be designing views of existing data that can be displayed in a dashboard type visual display. The dashboard type display could provide a quick visual status with the potential to drill deeper into the data through queries.

THIS PAGE INTENTIONALLY LEFT BLANK

LIST OF REFERENCES

Alberts, D.S., Garstka, J.J., and Stein, F.P., *Network Centric Warfare: Developing and Leveraging Information Superiority*, DoD C4ISR Cooperative Research Program, Washington, D.C., 2d ed (Revised), 1999.

Army Regulation 700-138, *Army Logistics Readiness and Sustainability*, Department of the Army, Washington, D.C., 2004.

Army Regulation 95-1, *Flight Regulations*, Department of the Army, Washington, D.C., 1997.

El Sawy, O.A., *Redesigning Enterprise Processes for e-Business*, McGraw-Hill Irwin, 2001, pp.39-41.

Field Manual 3-04.500, *Army Aviation Maintenance*, Department of the Army, Washington, D.C., 2000.

Fontenot, G., Degen, E.G., and Tohn, D., *On Point: The United States Army in Operation Iraqi Freedom*, Combat Studies Institute Press, 2004.

Kroenke, D.M., *Database Processing: Fundamentals, Design & Implementation*, 8th ed, Prentice Hall, 2002.

McGinn, S., *Getting Started with Dreamweaver MX*, Macromedia Inc., 2002.

THIS PAGE INTENTIONALLY LEFT BLANK

INITIAL DISTRIBUTION LIST

1. Defense Technical Information Center
Ft. Belvoir, Virginia
2. Dudley Knox Library
Naval Postgraduate School
Monterey, California
3. Defense Logistics Studies Information Exchange
U.S. Army Logistics Management College
Fort Lee, Virginia
4. Dr. Dan C. Boger
Naval Postgraduate School
Monterey, California
5. Professor Magdi N. Kamel
Naval Postgraduate School
Monterey, California
6. Glenn R. Cook
Naval Postgraduate School
Monterey, California
7. COL William Crosby
PEO Aviation
Redstone Arsenal, Alabama
8. LTC Anthony S. Pelczynski
PEO Aviation
Redstone Arsenal, Alabama
9. Mr. Ron Dalton
PEO Aviation
Redstone Arsenal, Alabama