

Airworthiness considerations for UAVs



A general overview about the approach to a UAV
System under current regulations for operation, airspace
and certification

Presentation by :

STN ATLAS ELEKTRONIK
Klaus Wohlers, LMP
Airborne Systems
Type certification

Report Documentation Page

Form Approved
OMB No. 0704-0188

Public reporting burden for the collection of information is estimated to average 1 hour per response, including the time for reviewing instructions, searching existing data sources, gathering and maintaining the data needed, and completing and reviewing the collection of information. Send comments regarding this burden estimate or any other aspect of this collection of information, including suggestions for reducing this burden, to Washington Headquarters Services, Directorate for Information Operations and Reports, 1215 Jefferson Davis Highway, Suite 1204, Arlington VA 22202-4302. Respondents should be aware that notwithstanding any other provision of law, no person shall be subject to a penalty for failing to comply with a collection of information if it does not display a currently valid OMB control number.

1. REPORT DATE 02 SEP 2003	2. REPORT TYPE N/A	3. DATES COVERED -			
4. TITLE AND SUBTITLE Airworthiness Considerations for UAVs		5a. CONTRACT NUMBER			
		5b. GRANT NUMBER			
		5c. PROGRAM ELEMENT NUMBER			
6. AUTHOR(S)		5d. PROJECT NUMBER			
		5e. TASK NUMBER			
		5f. WORK UNIT NUMBER			
7. PERFORMING ORGANIZATION NAME(S) AND ADDRESS(ES) STN ATLAS ELEKTRONIK Germany		8. PERFORMING ORGANIZATION REPORT NUMBER			
9. SPONSORING/MONITORING AGENCY NAME(S) AND ADDRESS(ES)		10. SPONSOR/MONITOR'S ACRONYM(S)			
		11. SPONSOR/MONITOR'S REPORT NUMBER(S)			
12. DISTRIBUTION/AVAILABILITY STATEMENT Approved for public release, distribution unlimited					
13. SUPPLEMENTARY NOTES See also ADM001676, UAV 2002 Conference & Exhibition., The original document contains color images.					
14. ABSTRACT					
15. SUBJECT TERMS					
16. SECURITY CLASSIFICATION OF:			17. LIMITATION OF ABSTRACT UU	18. NUMBER OF PAGES 26	19a. NAME OF RESPONSIBLE PERSON
a. REPORT unclassified	b. ABSTRACT unclassified	c. THIS PAGE unclassified			

Airworthiness considerations for UAVs

**Customers
desires**
Performances,
Features,
Time Frame

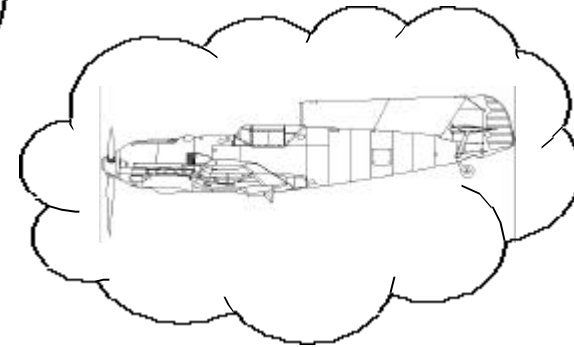

Manufacturers ideas
Resources, Location,
Budget, Time frame
Technical realisation

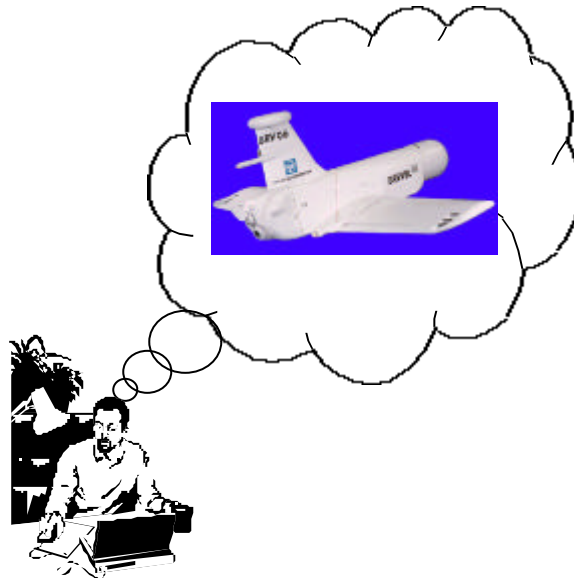

**Certification
Authorities
experience**
Design features,
Safety requirements,
Existing regulations

Airworthiness considerations for UAVs

Road Map to Airworthiness Requirements

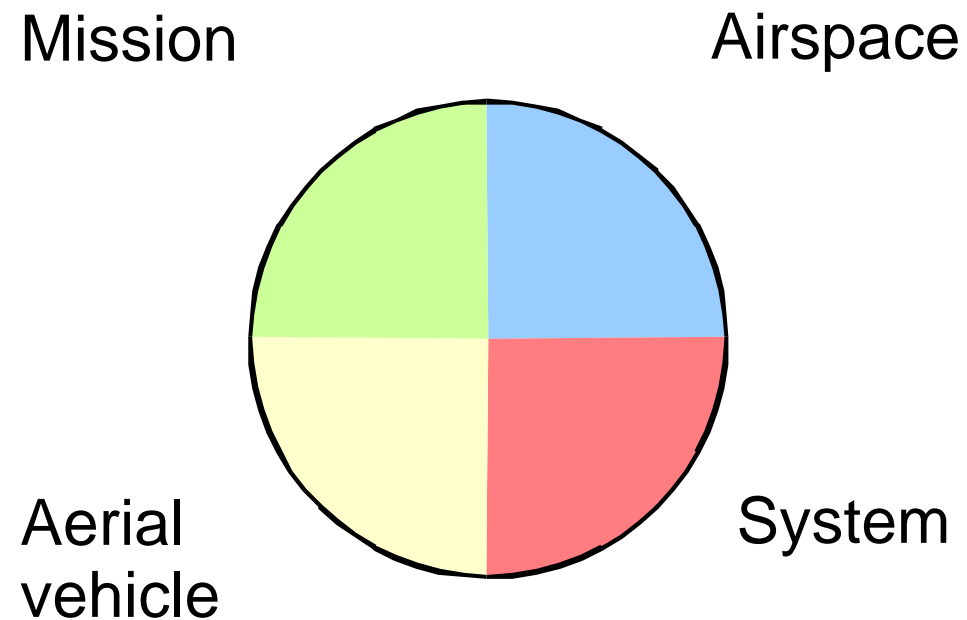

Essential aspects for requirement tracing

Airworthiness considerations for UAVs

Mission

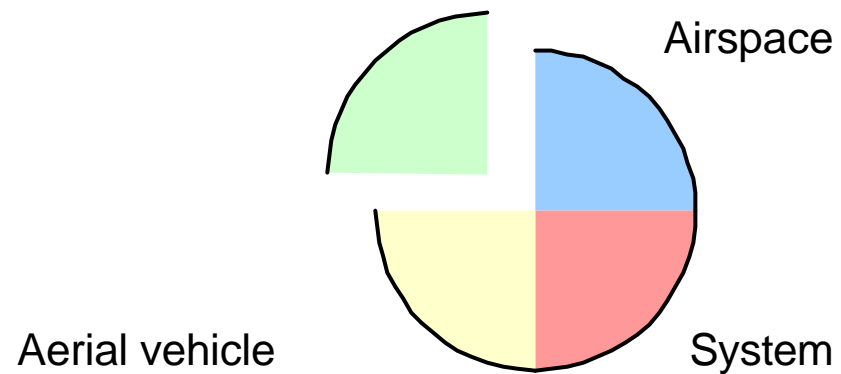

Essential aspects for requirement tracing

”What is the defined mission ?”

Airworthiness considerations for UAVs

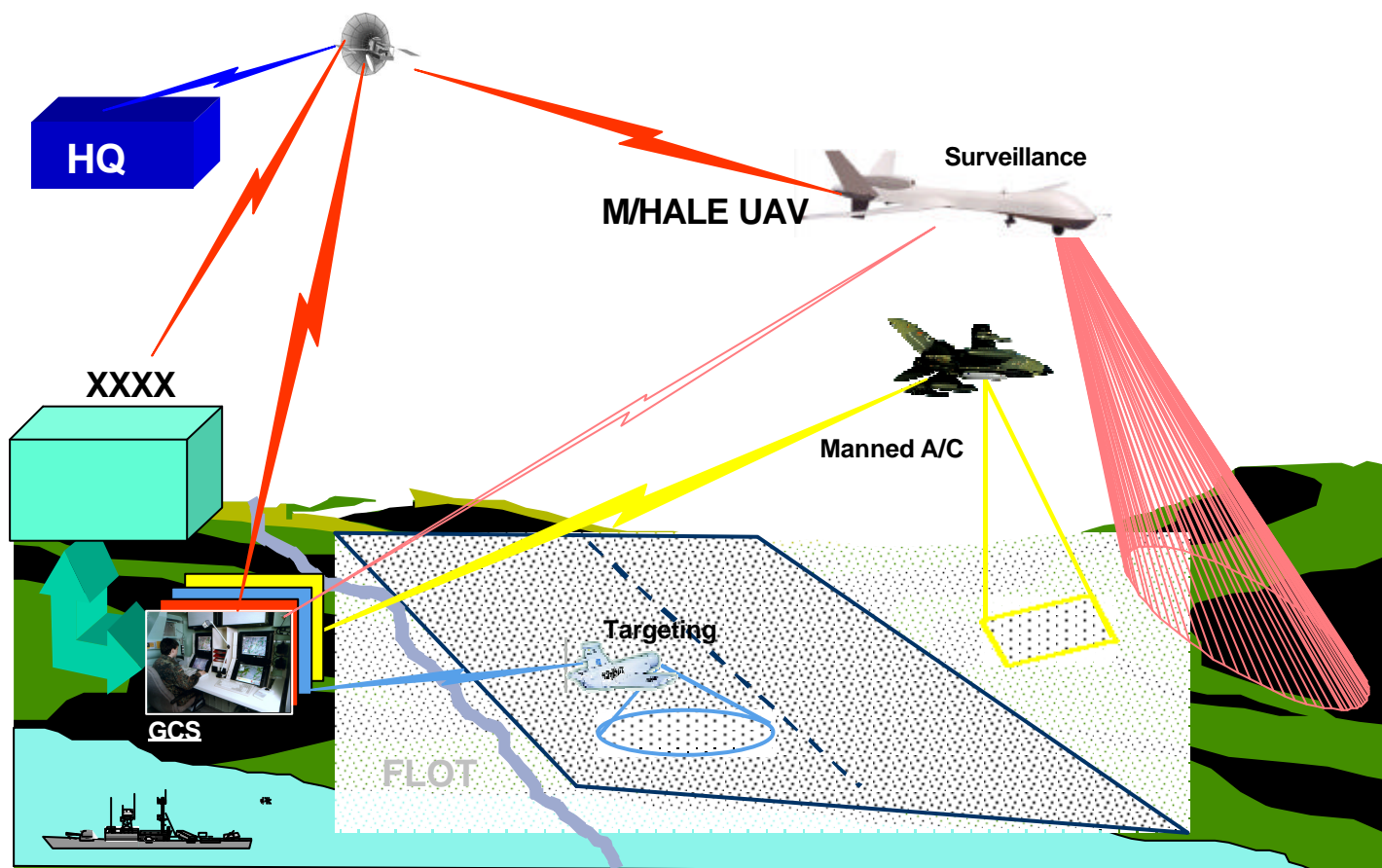

Possible scenario of a surveillance mission

Airworthiness considerations for UAVs

Questions regarding the specified mission:

What will be the main tasks of the system ?

- How long does a mission take ?
- Where do we want to operate it ?
- Who is going to operate it ?

Airworthiness considerations for UAVs

Questions regarding the specified mission:

- Will the UAV be operated beyond national borders ?

CHICAGO Article 8, Pilotless aircraft:

No aircraft capable of being flown without a pilot shall be flown without a pilot over the territory of a contracting State without special authorization by that State and in accordance with the terms of such authorization. Each contracting State undertakes to insure that the flight of such aircraft without a pilot in regions open to civil aircraft shall be so controlled as to obviate danger to civil aircraft.

Airworthiness considerations for UAVs

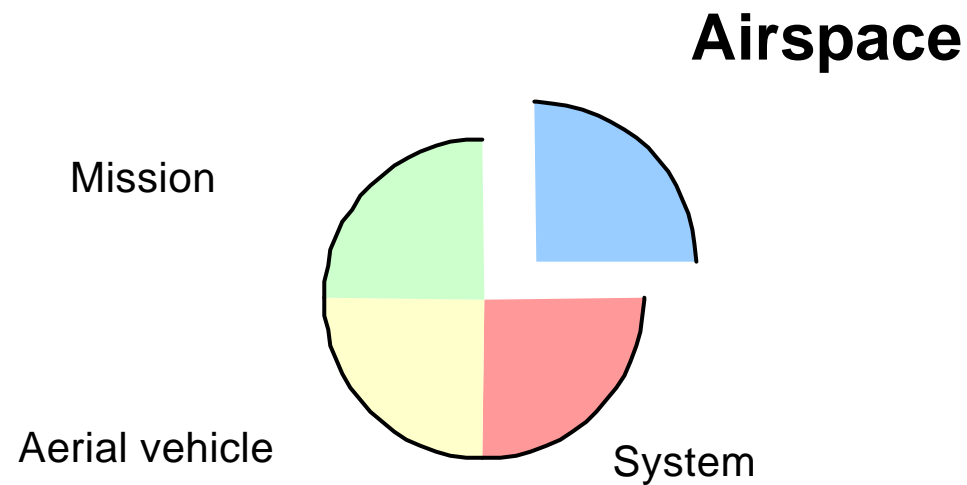

Essential aspects for requirement tracing

”In what type of airspace will the aircraft be operated ?”

Airworthiness considerations for UAVs

For example the German Airspace:

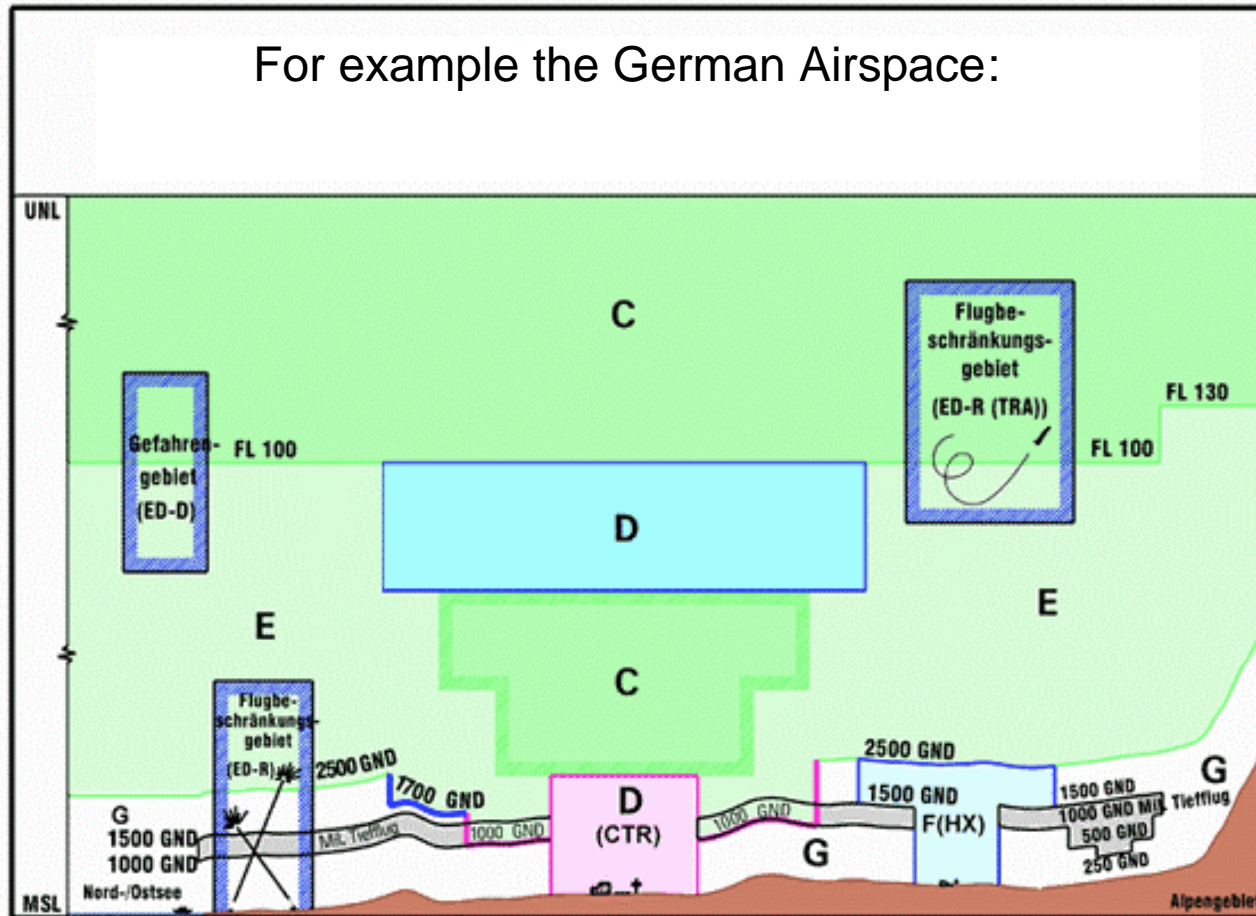

Airworthiness considerations for UAVs

Airspace related requirements in Germany

Airspace classification	Flight rules	Max. Speed (IAS)	Radio communication	ATC clearance
A	IFR	No speed limit	Permanent stand-by	Required
B	IFR, VFR	No speed limit		
C	IFR	250 kts below FL 100		
C	VFR	250 kts below FL 100		
CTR "C"	Same as for airspace "C", special needs for SVFR(AIP VFR, ENR)			
D	IFR, VFR	250 kts below FL 100	Permanent stand-by	required
CTR "D"	Same as for airspace "D", exc. clearance from clouds within CTR.			
E	IFR	250 kts below FL 100	Permanent stand-by	Required
E	VFR		Not required	Only for VFR night
F	IFR		Not required	Required
F	VFR		Only for VFR night	Only for VFR night
G	VFR		Not required	

Airworthiness considerations for UAVs

Airspace related ATS

Airspace classification	Type of airspace	Flight rules	Possible ATS	Separation by ATC
A	Controlled Airspace	Only IFR	ATC	All Aircraft
B		IFR, VFR	ATC	All Aircraft
C		IFR	ATC	IFR/IFR, IFR/VFR
		VFR	ATC, FIS (VFR/VFR)	VFR/VFR
CTR "C"		Same regulations as for airspace C		
D		IFR	ATC, FIS about VFR traffic	IFR/IFR
		VFR	FIS about VFR traffic	No separation
CTR "D"		Same regulations as for Airspace D		
E		IFR	ATC, FIS about known VFR flights	IFR/IFR
		VFR	FIS if possible	No separation
F	Uncontrolled Airspace	IFR	In flight AIS if possible	IFR/IFR as known
		VFR	FIS	No separation
G		Only VFR	FIS	No separation

Airworthiness considerations for UAVs



Summary of airspace related equipment:

- A safe communication link between aircraft and GCS
- Depending on the airspace, a safe communication link between ATC and GCS
- Minimum equipment according to national laws for chosen flight rule and weather conditions (On board sensors for ground based indicators of flight and navigation instruments, radio, sense and avoid devices, transponder)

Airworthiness considerations for UAVs



Summary of airspace related procedures:

- To maintain or change a (given) flight path
- To maintain or change an (given) altitude
- To maintain or change a given airspeed (horizontal and vertical)
- To perform known standard procedures

Airworthiness considerations for UAVs



Summary of airspace related features:

- To identify the current position
- To communicate with ATC or FIS
- To detect other objects (sense and avoid)
- To react autonomously, or remotely controlled by the GCS

Airworthiness considerations for UAVs

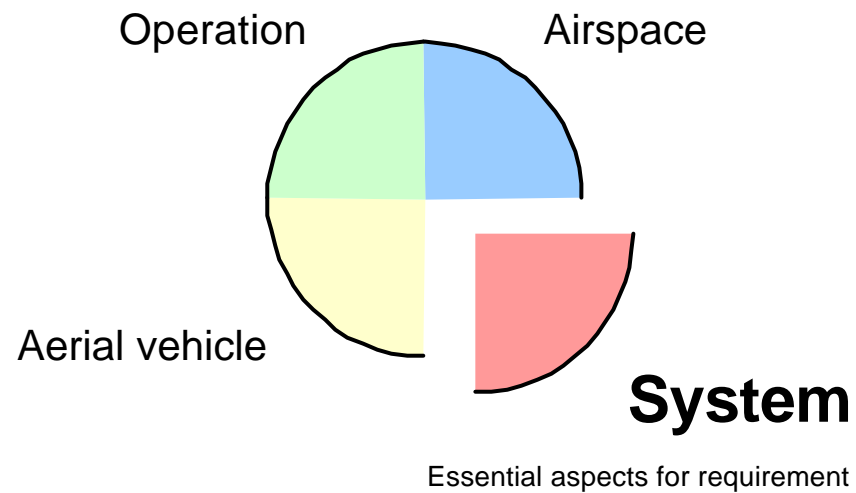

”What are the differences with manned systems ?”

Airworthiness considerations for UAVs



Specific needs for an “unmanned” system:

- A safe command and control-link; if needed, redundant
- A safe communication-link; if needed, redundant
- A flight control-system; if needed, redundant
- A qualified and accepted emergency plan and system

Airworthiness considerations for UAVs



Additional “normal” aircraft compliance capabilities:

- A navigation system
- A detection system

Airworthiness considerations for UAVs



Specific “unmanned” features:

- The ability to make on-board decisions based on the collected data
- The ability to command special functions from the GCS, if the on-board intelligence is not sufficient
- The possibility to re-task the aircraft, to start emergency procedures, or to fly the aircraft actively, if requested in near “real time”.

Airworthiness considerations for UAVs

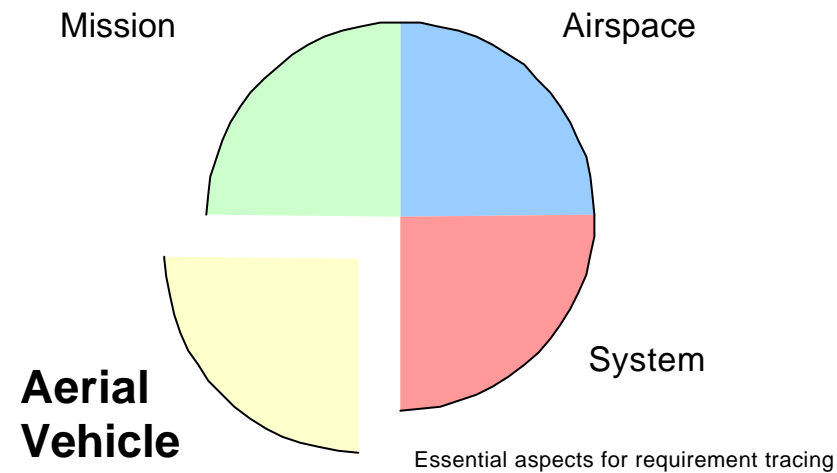

”Pre-design of the aircraft”

Airworthiness considerations for UAVs



Aircraft specified by the mission definition, airspace- and system -requirements

Technical Data:

Endurance:	>30 h
Altitude:	>45000 ft
Speed:	~200 kts
Payload:	>300 kg
Equipment:	>250 kg
Engine, Turbo Prop	~ 500 shp
Fuel:	~1500 kg
Span:	~25,0 m
Length:	~10,0 m
Height:	~4,0 m
Take off 50 ft.	~1000 ft
Runway:	~1500 ft
MTOW:	~3000 kg

Airworthiness considerations for UAVs

Size and location of the payload and operationally related equipment

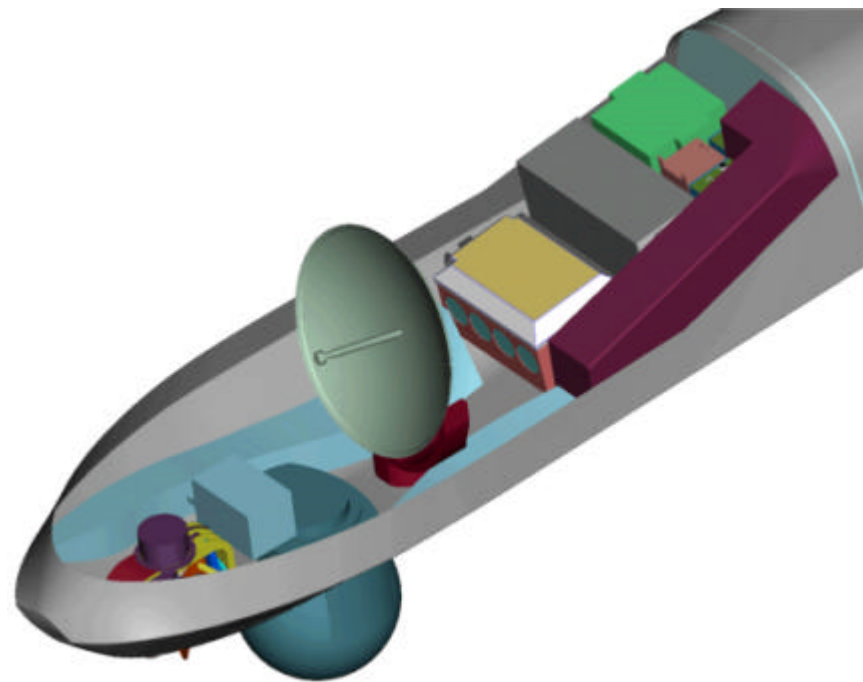

Airworthiness considerations for UAVs

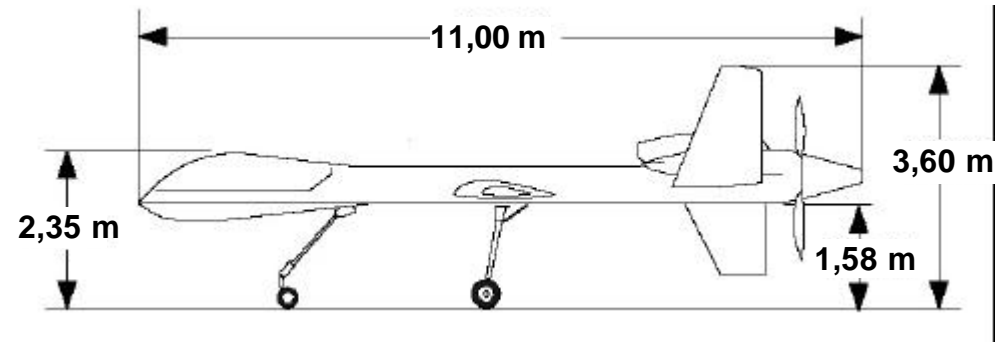

Airworthiness considerations for UAVs

§ Identification of legal demands and project related requirements §

- § Military or civil operations lead to:
- § The responsible Authorities (CAA, military)
- § The related regulations (civil, military)
- § National / international law (ICAO convention)

- § Identified airspace leads to:
- § ATC procedures (clearances)
- § Flight rules and regulations (IFR, VFR)
- § Necessary equipment and abilities

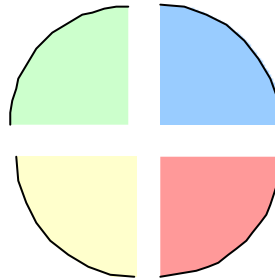

- § The aircraft leads to:
- § Its related airworthiness requirements (FAR, JAR, others)
- § Its required safety levels
- § Proven design features

- § The specified system will help define:
- § For ground based components its associated regulations and requirements
- § Requirements for the emergency procedure
- § Personnel requirements for the operators

Airworthiness considerations for UAVs

Announcing the project to the responsible authority
will start the following processes:

- Defining the overall certification envelope for the system
- Searching applicable requirements for UAVs
- Defining or creating applicable safety levels
- Defining and fixing the way to prove the requirements
- Creating and fixing the certification schedule with the authority
- Defining and fixing the form of the records

Seeking support and co-operation from the authorities

Airworthiness considerations for UAVs

Flow chart of a “typical” certification process

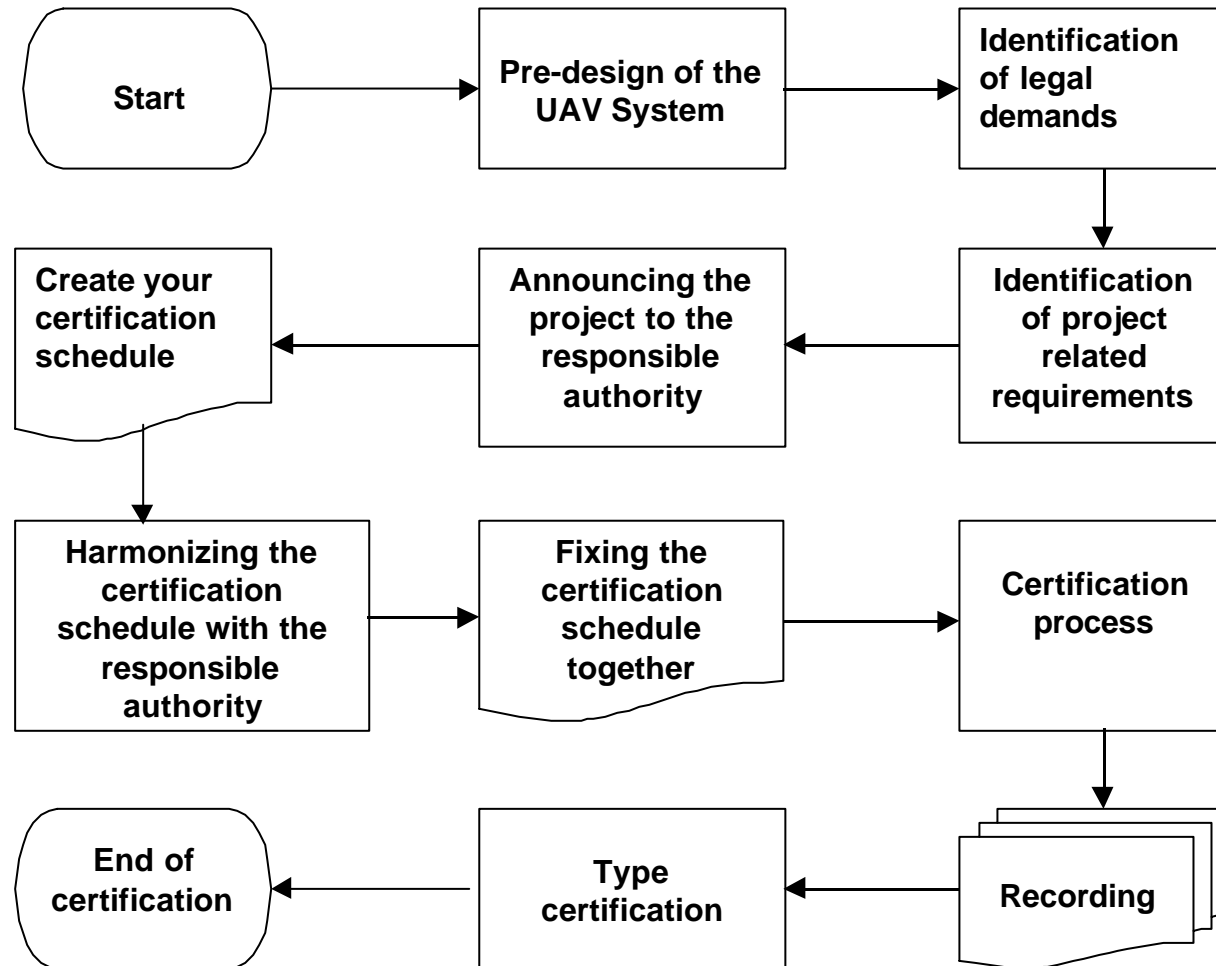

Airworthiness considerations for UAVs

Getting your “Type Certificate”:

- Is the final step to go into operation in civil airspace,
- Will be needed for the individual aircraft flight certificate

Is the end of my presentation,
Thank you !