

Future Trends for the Application of MEMS in Missiles and Gun Launched Munitions

Rob M.E.M. van Heijster
TNO-Physics and Electronics Laboratory
P.O. Box 96864
2509 JG The Hague
The Netherlands
Phone +31 70 374 0385
Fax: +31 70 374 0653
E-mail: vanheijster@fel.tno.nl

Huub L.J. Keizers
TNO Prins Maurits Laboratory
P.O. box 45
2280 AA Rijswijk
The Netherlands
Phone: +31 15 284 3378
Fax: +31 15 284 3958
E-mail: keizers@pml.tno.nl

Introduction

One of the most demanding areas of vehicle application are missiles and Gun Launched Munitions (GLM). From a technical point of view, limited space and severe shock, vibration and acceleration conditions put heavy burden on the system design. From an operational point of view, a demand for increasing functionality should be matched on shrinking defence budgets.

Modern warfare requires versatility in arms and low cost high precision solutions. Weapons are deployed at ever increasing ranges, dictated by deep strike and safe distance requirements where minimisation of collateral damage and effectivity of fire power set requirements for precision. Present war operations underline the importance of range and accuracy. The need for precision at long ranges, especially for small sized missiles and Gun Launched Munitions might well be covered by MEMS technology.

In this paper an outline of the future trends in MEMS for missiles and GLNM is presented. Some of the promising developments are discussed more in detail and the TNO contribution to these developments is mentioned.

MEMS have shown [1] to have good properties to withstand the severe conditions present in missiles and GLM. MEMS might become available at low cost, under the condition that large quantities are produced, which require a high volume civil application. Their small dimensions enable MEMS to be the exclusive solution for many GLM applications. For missiles systems MEMS will become the enabling technology for ongoing missile specific health monitoring developments. When produced in large quantities MEMS might be available at low cost, as is the case for many civil based MEMS.

The paper will start with a short overview on MEMS developments at TNO. The second part of the paper addresses the relevant areas of MEMS application for missiles and GLNM and outlines the specific trends in those areas. The last part of the paper will address future trends in relation to economics, spin-in and spin-off from other application areas.

Paper presented at the RTO AVT Symposium on "Novel Vehicle Concepts and Emerging Vehicle Technologies", held in Brussels, Belgium, 7-10 April 2003, and published in RTO-MP-104.

Report Documentation Page

Form Approved
OMB No. 0704-0188

Public reporting burden for the collection of information is estimated to average 1 hour per response, including the time for reviewing instructions, searching existing data sources, gathering and maintaining the data needed, and completing and reviewing the collection of information. Send comments regarding this burden estimate or any other aspect of this collection of information, including suggestions for reducing this burden, to Washington Headquarters Services, Directorate for Information Operations and Reports, 1215 Jefferson Davis Highway, Suite 1204, Arlington VA 22202-4302. Respondents should be aware that notwithstanding any other provision of law, no person shall be subject to a penalty for failing to comply with a collection of information if it does not display a currently valid OMB control number.

1. REPORT DATE 00 APR 2004	2. REPORT TYPE N/A	3. DATES COVERED -			
4. TITLE AND SUBTITLE Future Trends for the Application of MEMS in Missiles and Gun Launched Munitions		5a. CONTRACT NUMBER			
		5b. GRANT NUMBER			
		5c. PROGRAM ELEMENT NUMBER			
6. AUTHOR(S)		5d. PROJECT NUMBER			
		5e. TASK NUMBER			
		5f. WORK UNIT NUMBER			
7. PERFORMING ORGANIZATION NAME(S) AND ADDRESS(ES) TNO-Physics and Electronics Laboratory P.O. Box 96864 2509 JG The Hague The Netherlands		8. PERFORMING ORGANIZATION REPORT NUMBER			
9. SPONSORING/MONITORING AGENCY NAME(S) AND ADDRESS(ES)		10. SPONSOR/MONITOR'S ACRONYM(S)			
		11. SPONSOR/MONITOR'S REPORT NUMBER(S)			
12. DISTRIBUTION/AVAILABILITY STATEMENT Approved for public release, distribution unlimited					
13. SUPPLEMENTARY NOTES See also ADM201697, NATO RTO-MP-104 Novel Vehicle Concepts and Emerging Vehicle Technologies (Nouveaux concepts et technologies émergentes pour plates-formes), The original document contains color images.					
14. ABSTRACT					
15. SUBJECT TERMS					
16. SECURITY CLASSIFICATION OF:			17. LIMITATION OF ABSTRACT UU	18. NUMBER OF PAGES 34	19a. NAME OF RESPONSIBLE PERSON
a. REPORT unclassified	b. ABSTRACT unclassified	c. THIS PAGE unclassified			

Future Trends for the Application of MEMS in Missiles and Gun Launched Munitions

MEMS development at TNO

The defence part of TNO (Dutch acronym for Netherlands organisation for applied physics research) is already for many years involved in various areas of MEMS development for military applications. Of the involved institutes, TNO Physics and Electronics Laboratory is a 550 employee organisation internationally recognised in the fields of Operational Research, Simulators, Electronics and Electronic Warfare, Observation Systems and Command Control Communication and Information (C3I). TNO Prins Maurits Laboratory employs 340 professionals in the areas of Chemical and Biological Protection, Munition Technology and Explosion Safety and Weapons and Weapon Platforms.

The MEMS activities are divided in a number of application area's:

- MEMS for optical systems
An example is given in Figure 1, a MACH-Zehnder sensor. The sensor is used to detect the presence of a specific gas (determined by the agent used). The laser coupling in this device is also given.
- MEMS for RF systems
An example is given in Figure 2. Shown is a wideband power amplifier of 37 dBm.
- MEMS for Gun Launched Novel Munitions (GLNM).
The last years MEMS for application in weapon systems have gained interest within our organisation. As an example, the result of a design study for an opto-mechanical accelerometer is given in Figure 3.
- MEMS for Health Monitoring
Electromechanical and optical sensors to monitor life critical parameters like temperature, humidity, chemical parameters, mechanical strain and stresses. An experimental set-up is given in Figure 8.

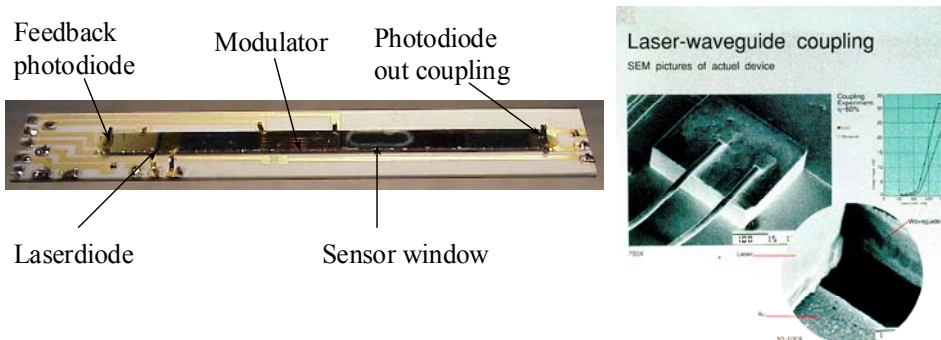

Figure 1 Mach-Zehnder sensor (left) and its laser waveguide coupling (right)

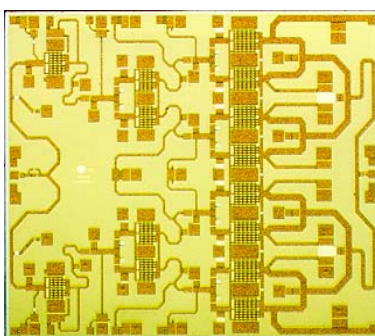

Figure 2 MMIC wideband power amplifier

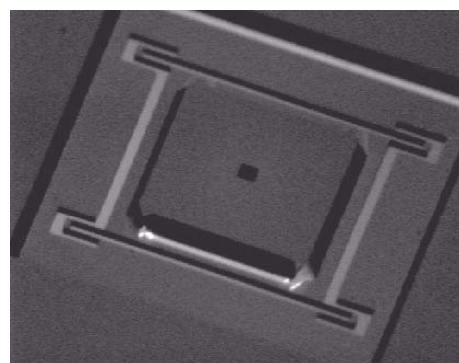

Figure 3 Opto-mechanical accelerometer

Recently, four institutes (both military and civil) of TNO have started an initiative to develop a production facility for medium scale MEMS production. This initiative is supported by the board of directors and will continue up to the end of 2006. A part of the program will be devoted to development of small-to-medium volume MEMS for GLM and missiles.

MEMS in Missiles and GLNM

MEMS are applicable in Missiles and GLM for various applications like:

- Target sensing
- Telemetry
- Initiation of the explosive charge
- Health monitoring
- Navigation
- Trajectory control

Target sensing

Target sensing is performed in the RF or optical domain. High performance RF circuitry often relies on low-loss switches, for instance applied in phase shifters. Electronically Steerable Antennas remove the need of gimbals and enable the use of target sensors in small missiles and GLM [2]. Major achievements in the area of switches and phase shifters will have impact on RF sensor performance. TNO is participating in a 6th framework program ARHMS, the aim is the development of a RF switch that is capable of (cold) switching high power levels. The design goal is in the Watt order of magnitude. Activities have just recently started, to date the definition document has been finalised.

Telemetry

Telemetry is of growing importance given the increasing ranges (developments aim at up to 120 km) that can be covered by GLNM. Battle damage assessment and in flight retargeting are of increasing importance. MEMS technology allow application of modern communication technology to facilitate reliable communication and low risk of detection and interception of the transmitter.

Initiation of explosive charges

Current detonators for explosive charges are relatively bulky. They ignite sensitive so called primary explosives. These primary explosives are not only sensitive to the thermal output of the detonator, but also to shock, vibration, electric discharges etc. The primary explosive in turn has sufficient output to ignite an insensitive secondary explosive. To avoid any unwanted explosion, due to for example an electric discharge (lightning), a mechanical “safe and arm” unit separates the primary and secondary explosive in the “safe” mode. An occasional ignition of the primary explosive will not initiate the main secondary charge.

An Exploding Foil Initiator (EFI) does not require a mechanical safe and arm unit. The EFI “produces” a small particle travelling at a speed of several thousands of meters per second. The impact of this so called “flyer” can directly ignite an insensitive explosive. The flyer is accelerated using a high voltage high current pulse. Discharging the high voltage capacitor present in the EFI disables its capacity to accelerate the flyer, which ensures the EFIs inherent safety. Electronic circuitry is of course required to ensure discharge in the safe mode.

Both conventional detonator combined with “safe and arm” unit and EFIs are relative bulky and consume sparse space available in today’s GLNM. The use of the bulky mechanical safe and arm unit is inevitable, however the EFI consists of components that are prone to miniaturisation, see Figure 4. The reduction in size makes sparse space available for the implementation of new weapon technology. Application of MEMS technology can greatly reduce the size of the EFI. Especially in the case of multi initiator situations, as is the case for aimable warheads, the size reduction can be advantageous. TNO is investigating the possibility of miniaturising EFIs and combining electronic safety functionality with the EFI in a MEMS, see Figure 5. Apart from the current required safety functionality, additional safety features can easily be implemented, making the MEMS EFI versatile, also applicable in civil applications like mining and air bags.

Future Trends for the Application of MEMS in Missiles and Gun Launched Munitions

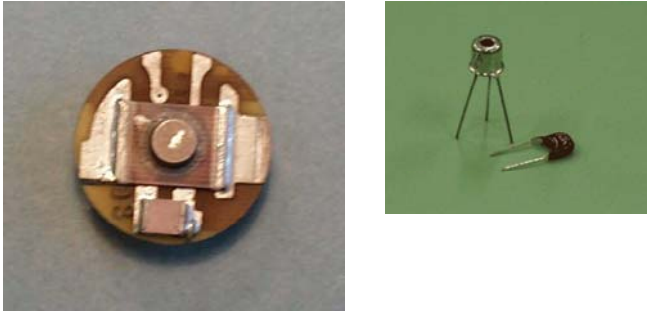

Figure 4 State of the art detonator (left) and mock-up of MEMS EFI (right) on the same scale.

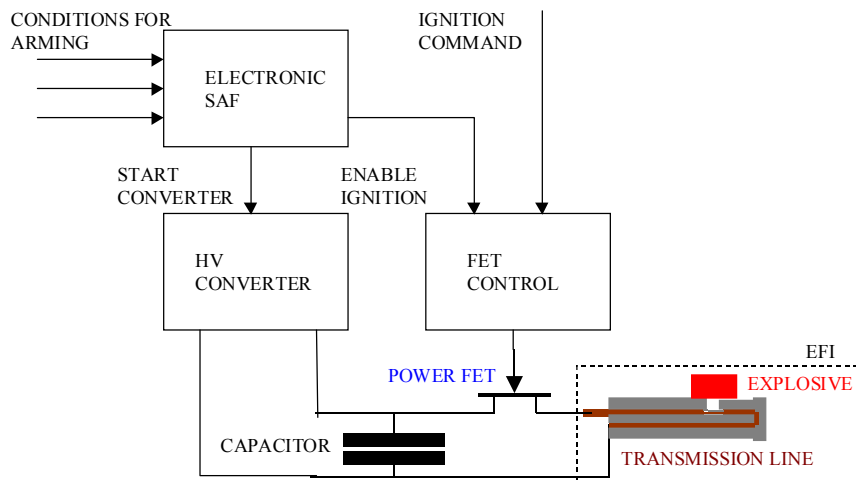

Figure 5 Schematic diagram EFI based detonator

The MEMS-EFI is currently in a start-up phase. Topics included in this study are:

- Non-linear behaviour due to high currents and voltages;
- Integration of all high power components and the transmission line a single silicon process.
- Modelling of EFI behaviour.

Health monitoring

The lifetime of missile systems is generally restricted by the degradation of the energetic materials. Furthermore, solid propellant rocket motors are very sensitive to inhomogeneities, like cracks. These lead to strong variations in thrust and possibly to the burst up of the rocket motor. During production, precautions are made to avoid any form of inhomogeneities. However, during its life the propellant deteriorates, a process that is strongly dependent upon temperature. TNO studies the application of MEMS devices that allow embedding the sensors in the rocket motor (propellant, insulants, liner) without significantly changing either rocket motor performance or internal stress. MEMS devices fulfil this requirement due to their small geometrical features. The MEMS device should be able to operate stand-alone and preferably use wireless communication.

Health monitoring (state-of-the-art)

The safety and reliability of a missile system largely depends on the quality of its energetic components. Due to chemical, physical and mechanical processes, the energetic materials in rocket motors, warheads, gas generators, pyrotechnic components deteriorate (ageing). External conditions like temperature, shock and humidity may accelerate these processes.

If the ageing mechanisms are known, the life of an energetic component can be predicted using state-of-the-art computer models [3]. These models are generally of semi-empirical nature and include the dependence of

the ageing rate and the critical failure modes on the aforementioned external conditions. Different models can be used depending on the particular motor design and materials used. For example, models exist to predict changes in mechanical properties (strength, strain, ..), stability (stabiliser consumption, gas cracking, etc...), safety (sensitivity, exudation, etc...) or migration of specific species.

On behalf of the Dutch MoD, TNO uses COTS MEMS sensors for the recording of the external conditions for missile systems under a variety of situations. Currently, operational conditions are monitored during depot storage, transport, field storage (non-Europe sites) and naval applications. This data is evaluated to:

- 1) determine whether critical conditions have been superseded (T, RH);
- 2) be used as input for ageing models (assessment impact of specific missions on the lifetime).

By the use of modern satellite communication technology, a (near) real-time response capability is provided, allowing for quick responses in case corrective measures would be required.

A typical example of measured temperatures and the impact on the motor life for a solid propellant rocket motor is shown in Figure 6. During this mission in Africa, relatively moderate temperatures were reached due to the specific storage conditions. However, maximum temperatures up to 55 °C were reached during transport and, in case of a longer duration mission, it would have been likely that critical temperature limits would have been superseded. For the particular system investigated, stabiliser depletion was the critical failure mode. Especially the periods of high temperature significantly affect the stabiliser content.

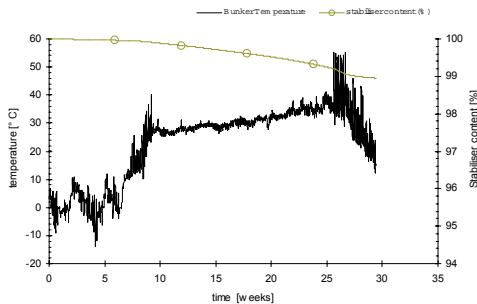

Figure 6 Actual operational temperatures and impact on stabiliser content

Health monitoring (Future)

Recent improvements in MEMS technology not only enable the recording of external conditions, but also can give true health monitoring and missiles specific capability by the use of embedded sensors [4, 5]. Electromechanical and Fibre-optic MEMS devices can be used to measure temperatures, internal strains and stresses, chemical composition (stabiliser, decomposition products, O₂, RH, plasticiser level,..), etc. In this way a direct safety check can be provided (e.g. cracks, stabiliser) and improved input for ageing models is generated. These developments will result in weapon specific safe life predictions, which will improve the safety for the troops and will result in significant cost savings by preventing premature disposal of good assets.

Introduction of embedded sensors in fielded missile systems is to be expected within the next decade. Current developments focus on the reduction in size, development of specific (chemical) sensors, and the long-term behaviour of the sensors.

Figure 7 show some typical examples of research on sensors as is currently being performed at TNO. The research at TNO focuses on the assessment of mechanical bond stresses during thermal cycling (MEMS sensor, Fibre Brags) and the effect of oxidative ageing (chemical oxygen sensor). An experimental set-up is shown in Figure 8. The results so far show that it is very well feasible to use these sensor types for health monitoring of rocket motor. In a follow-on development, the use of RF technology is being explored. This

Future Trends for the Application of MEMS in Missiles and Gun Launched Munitions

could make the lifetime of the sensor independent of battery life and will significantly increase the flexibility of these devices (no through leads required).

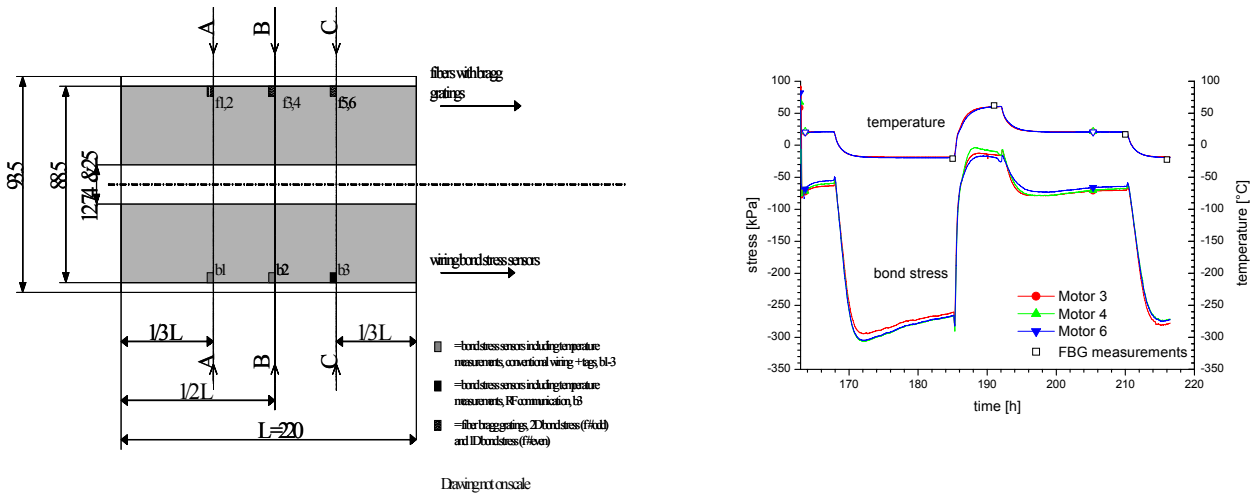

Figure 7 Test geometry and test results of thermal cycle experiments

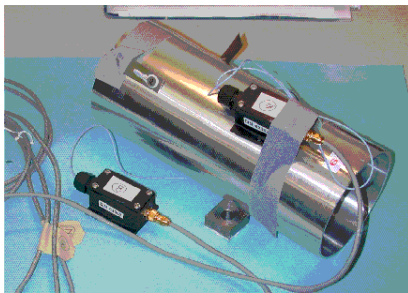

Figure 8 Experimental rocket motor equipped with MEMS sensor

Navigation

MEMS navigation devices are available from various sources, see Figure 9. Foreseen application of low cost inertial measurement units (IMU) in cars will greatly increase the availability of those devices. However, the shortcomings of these devices have to be overcome. Additional information from GPS or other systems can be used for this purpose. TNO has recently started a study to find additional inexpensive ways to overcome the shortcomings, preferably using information that is already present in GLNM.

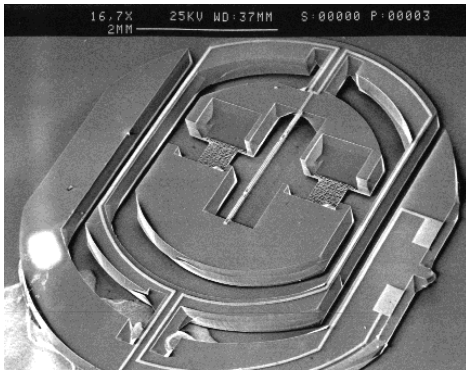

Figure 9 accelerometer by Sextant Avionique

Trajectory control

The aerodynamic control of GLM by MEMS boundary layer control is an upcoming technology [6]. The main advantages of this technology overcome the shortcomings of conventional control: mass, size and power consumption. MEMS actuators for boundary layer control are small by their nature, given the boundary layer itself is only several 100 microns in thickness. Energy consumption is only moderate, given the fact that MEMS control the disturbance rather than the airflow itself.

Future trends

The main hurdle to overcome for application of MEMS in GLNM is not technology but cost. Traditionally, gun ammunition is relatively cheap and often fired in salvo's. Gun fire is used to destroy low and medium value targets. Doctrine still requires volume fire. The gun application is based on large numbers of low cost munitions. For missile systems, system (life) costs are determining, and the (large scale) introduction of MEMS in ammunition will most likely start in these systems.

Given the requirement for low cost only technology available at moderate cost will be implemented in GLNM, size limitations in combination with extremely high mechanical loads are often in favour of application of MEMS.

Already several years ago the WEU commissioned a study "BRAMMS" [7] in which TNO participated. This study had to investigate application area's for MEMS in military applications and to reveal whether there are civil MEMS available that could fulfil the military needs. Given the high development cost for MEMS and MEMS technology, the added value of MEMS applications need to be very high to justify application specific development. For the majority of applications the added value will only allow for the use of COTS MEMS.

Most of GLNM MEMS requirements might be fulfilled by COTS MEMS. The automotive community has developed traffic navigation systems, making MEMS IMU readily available. The limited performance of these devices has to be overcome, however this will not hamper applicability.

Telemetry will follow developments in communications, especially mobile com and Wireless LAN. Telemetry is more or less readily available from a technical point of view, however it requires a C⁴I infrastructure that can handle information to and from the (multiple) weapons in real-time. This will hamper the application of telemetry in war operations. Telemetry for test purposes is available.

The application of health monitoring devices will greatly increase over the next decade. The devices are not application specific, the same device can be used in multiple applications, which will lead to a huge market potential. The devices will include tagging capabilities, which makes the health monitoring system to a valuable asset from a logistic point of view. Health Monitoring of Munitions (HMOM) is one of the five high pay-off MEMS applications identified by the AVT Task Group 078 (TG 19) "Military MEMS

Future Trends for the Application of MEMS in Missiles and Gun Launched Munitions

Applications". As a result of three Task Group meetings, a Co-operative Demonstration of Technology (CDT) opportunity has been identified in this area, which will focus on the different MEMS devices available ("near" on-the-shelf), their usage for health monitoring and the potential use within NATO for future operations. This CDT is planned for the period '03-'04.

MEMS EFI detonators are not yet available, however there are indications that there is a vast interest in these devices. From a safety point of view, only the EFI fits unconditionally in today's insensitive munitions philosophy. MEMS EFI might become available in the military market first. From a market point of view, a cheap MEMS EFI would certainly have a chance in automotive applications. To date, safety of airbags is very good for drivers and passengers. However they are at risk for fireman and paramedics operating on crashed cars and already deaths have been encountered. The MEMS EFI will overcome these drawbacks.

Boundary layer control might be the future way to control GLNM. The development of the necessary devices is beyond the scope for only GLNM application. However there is a vast interest from jet engine manufacturers, which in the future will lead to availability of devices for boundary layer control. Upon availability, the might well be implemented in GLNM, however this is not foreseen in the near to medium future.

Conclusive remarks

MEMS will play an increasing role in missiles and GLNM. For each type of MEMS, fortunately a market exists to share the device and hence development costs. Full advantage of MEMS application will still take a decade to materialise.

The main hurdle to overcome for application of MEMS in GLNM is not technology but cost. Given the high development cost the majority of missile and GLNM applications will have to rely on COTS MEMS. These devices are not tailored to missile and GLNM application, however this will not hamper applicability.

Telemetry will follow developments in communications, especially mobile com and Wireless LAN. However it requires a C⁴I infrastructure in place, this might hamper wartime telemetry application.

The application of health monitoring devices will greatly increase over the next decade. The market potential is huge and will include logistic applications. The application of these devices will be part of a RTO-AVT CDT which is planned for the years 03-04.

MEMS EFI detonators are not yet available, however they fit unconditionally in today's insensitive munition philosophy. From a market point of view, a cheap MEMS EFI would certainly have a chance in automotive applications.

Boundary layer control might be the future way to control GLNM. The vast interest from jet engine manufacturers will in the future lead to availability of suitable devices.

References

- 1 Pisano, A, Presentation of HSTSS program, RTO-AVT, 12 May 2000
- 2 Corey, L., Low Cost Cruise Missile Defense (LCCMD), DARPA, Sept. 2002
- 3 Keizers, H., Reeling Brouwer, G, Weijl, J., Weterings, F.P., Evaluation of rocket motor safelife based on condition monitoring and ageing modelling, RTO-AVT, Sept. 2002
- 4 Buswell, J., Chelner, H., Hubinger, M., Sprinks, G., Characterisation and Use of Bond Stress Sensors in Tactical Rocket Motor, Huntsville, 2000, AIAA2000-3139
- 5 Gilbert, R.W., Bond, L.J., Skorpik, J.R., Posakony, G.J., Smart Multi-Sensor Radio Frequency TAGS for Propulsion Systems.
- 6 Wlezien, R., Micro Adaptive Flow Control, DARPA, Aug 1999
- 7 El-Fataty, A. et. al., BRAMMS final report, WEU, 18 January 2000

Future trends for the application of MEMS in missiles and GLNM

TNO Defence Research



Contents

- **Introduction**
- **BRAMMS**
- **MEMS application areas in GLNM and missiles**
 - Target sensing
 - Telemetry
 - Initiation of the explosive charge
 - Navigation
 - Trajectory control
 - Health monitoring
- **Conclusive remarks**

Introduction

- **Challenges in GLNM and missiles**
 - Requirements
 - Accuracy
 - Range
 - Target detection, selection...
 - Example: requirements for NFS
- **MEMS act as enabler**
 - Size
 - Functionality
 - Harsh environment
 - Shock
 - Vibration



Naval Fire Support

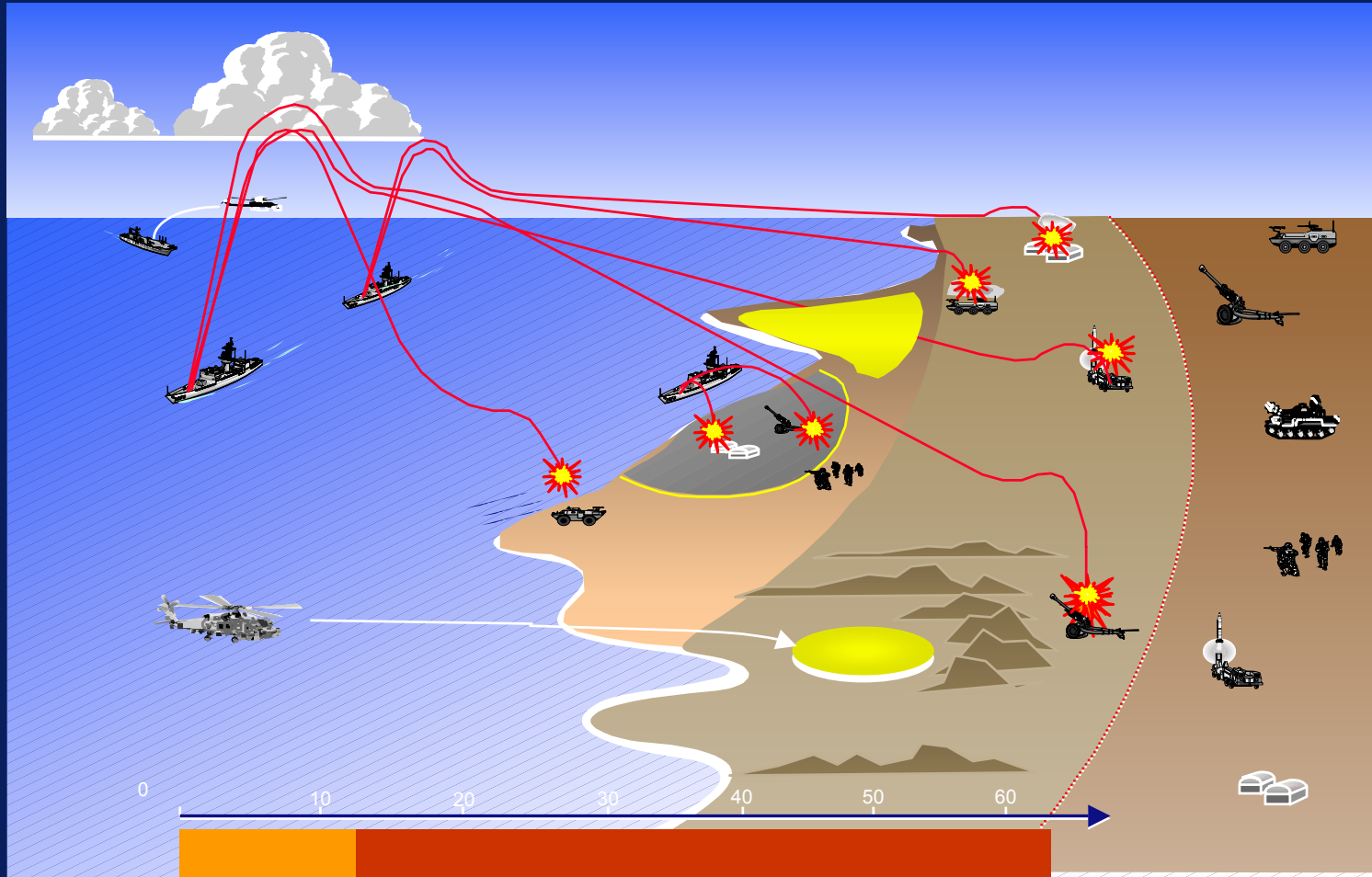



MEMS are Tough Enough to Survive

Modified M831 Launched at 30,000g axial acceleration with

MEMS

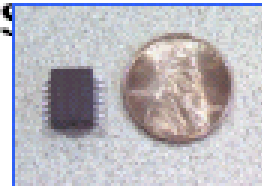

FIRST MOVEMENT, MUZZLE EXIT

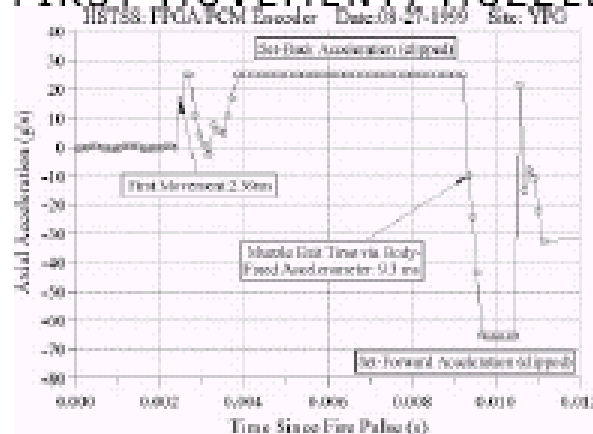

AXIAL FORCE

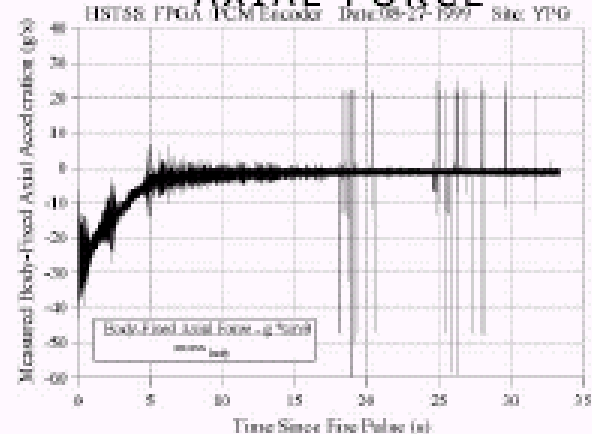

MEMS accels in hardened telemetry for in-bore and in-flight measurements.

BRAMMS (1)

- **REPORT** that identifies the military Systems' **BROAD REQUIREMENTS** for Micro Electromechanical Systems (MEMS)
- **Application in (a.o.)**
 - Inertial Systems for missile guidance & control
 - Health monitoring systems
 - Power management systems



BRAMMS (2)

- **Hurdles**

- Military MEMS will depend, heavily, on the commercial / civil MEMS developments.
- Low volumes, for the military markets, will attract high costs.
- Military product life-cycles exceed those for commercial / consumer products. Both process availability and product obsolescence become a major concern.
- Access to military-specific MEMS developments by the civil markets may have security implications.

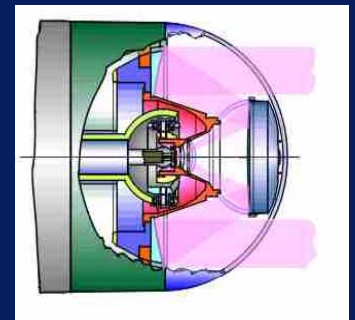

MEMS in GLNM and missiles

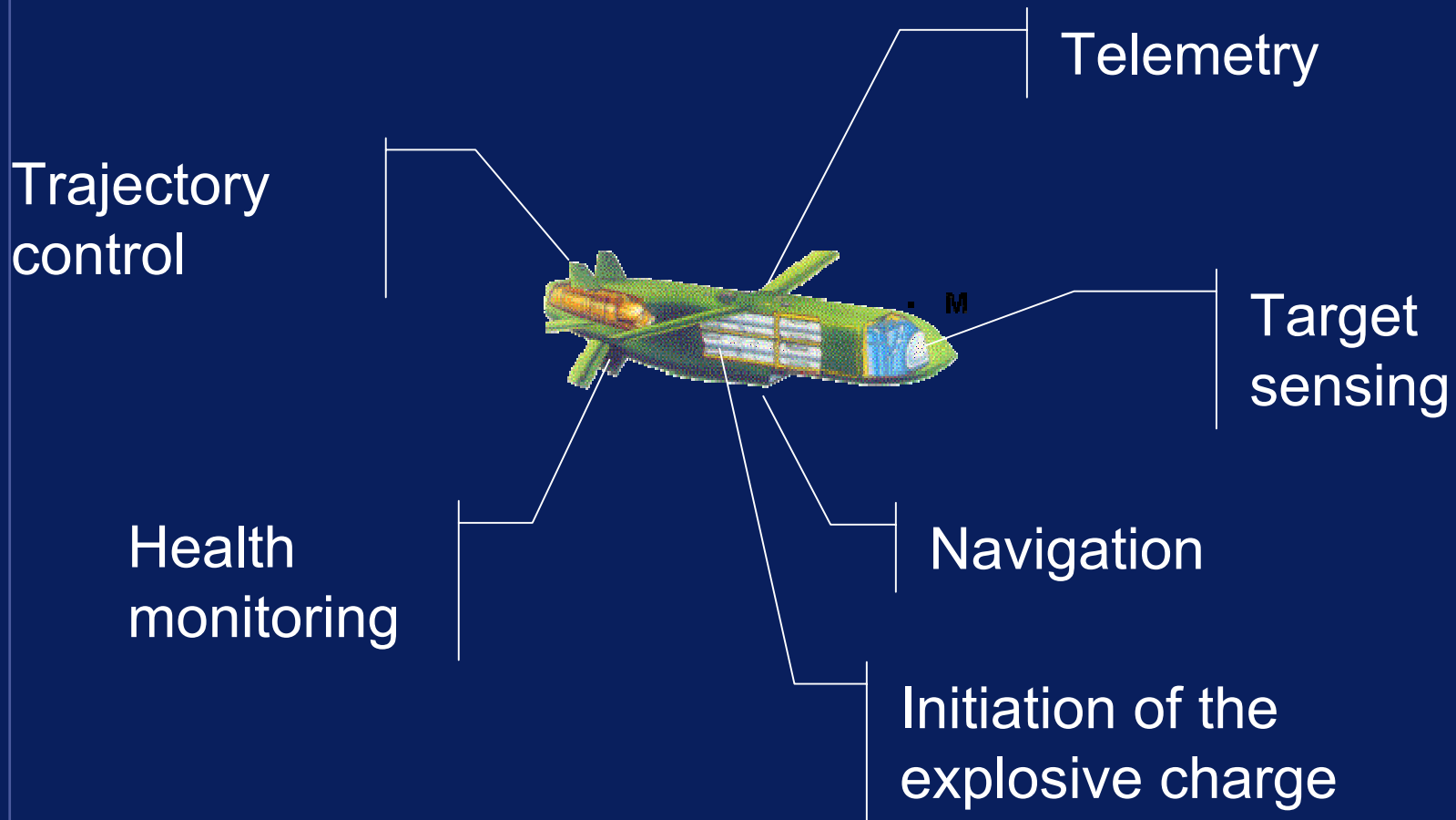

Target sensor

- **Electronically Steerable Antenna (ESA)**
 - RF MEMS switches
 - TNO participation in 6th framework ARHMS
 - MOEMS
- **IR seekers**
 - Imaging
- **Computing**
 - Optical
 - Mass storage

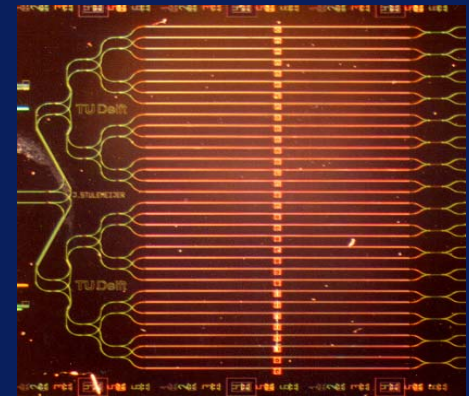

TNO optical beamformer

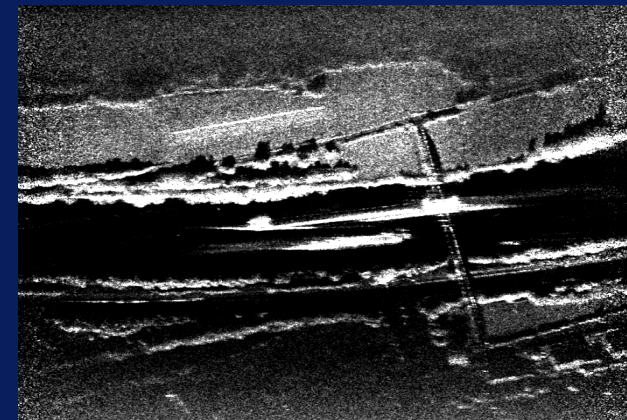

Telemetry

- Battle field damage assesment
- Spread spectrum ~ low risk interception
- Range

- RF switches ~ ESA
- MEMS replacing off-chip components

- Will follow civil communication

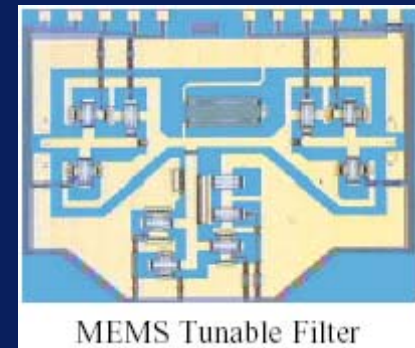

Initiation of explosive charge

- **Advantages of EFI technology**
 - Intrinsic safe
 - Direct ignition of insensitive secondary explosive (NIMIC)
- **MEMS and HV technology combined**
 - Transistors
 - EFI
 - High current & voltage
- **Spin off**
 - Automotive
 - Mining

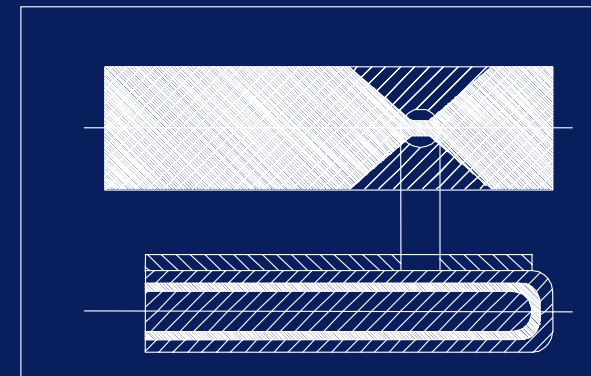
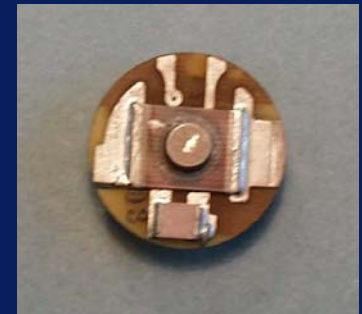

Igniter lay out

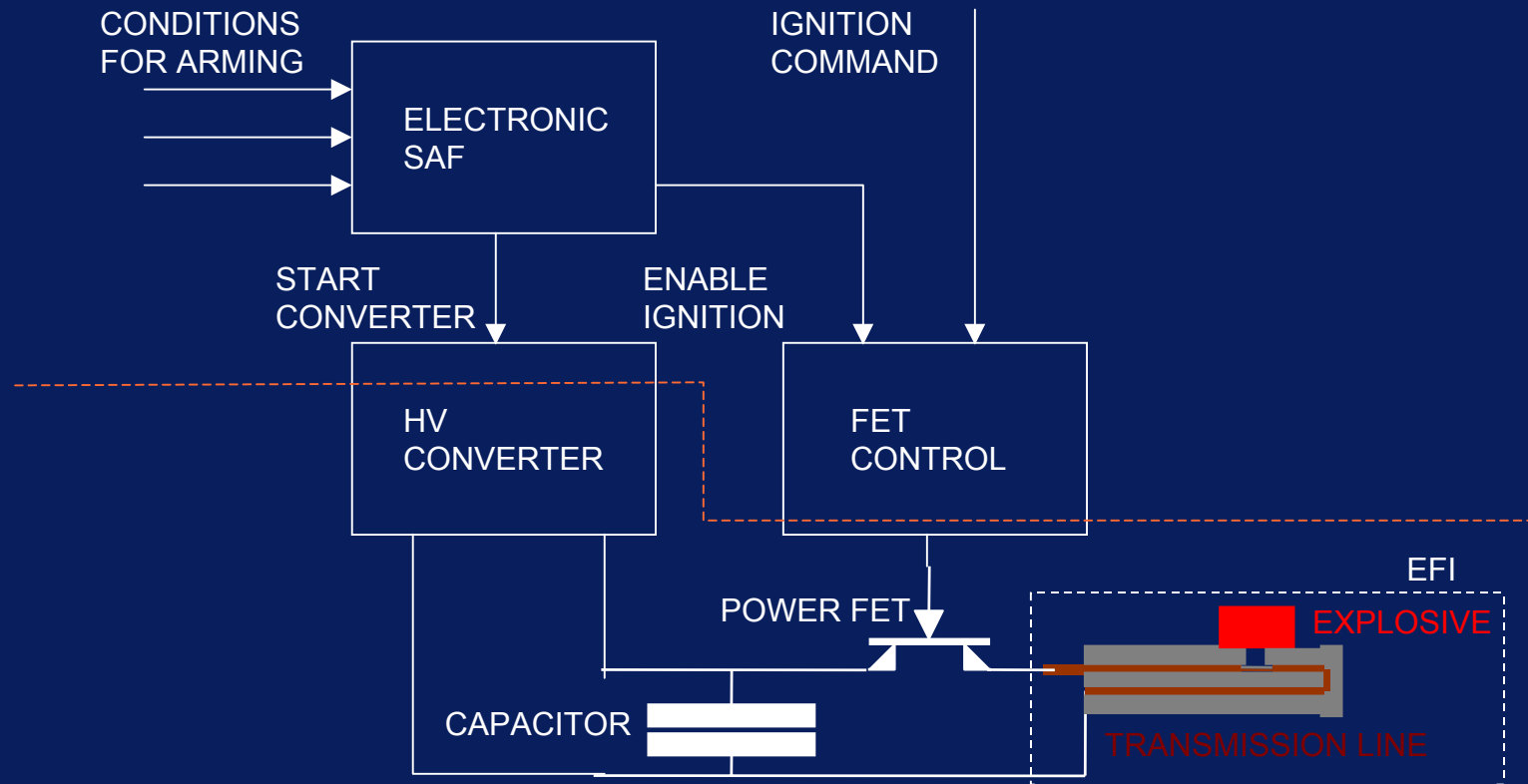

Navigation

- **The market: automotive**
 - Limited accuracy
- **GPS**
- **MEMS: ESA ~ Anti jamming**
- **High shock survivability**
- **TNO study**
 - optomechanical accelerometer

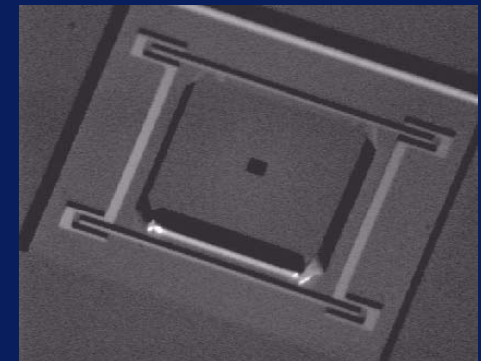

Trajectory control

- **Micro adaptive flow control**
 - Experimental
 - Promising
 - Application in jet engines, airplanes
 - Enabler for many military applications
- **Control of missiles and GLNM**
 - Moderate energy consumption
 - Applicable for small fire arms

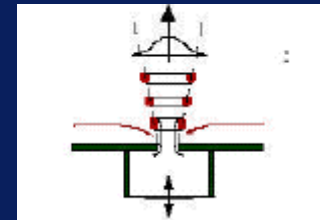

Health motoring (State-of-the-Art)

- The lifetime of missile systems and other high cost ammunition assets is generally limited by the degradation of the energetic materials
- Energetic materials degrade as a function of operational conditions (T, RH, mechanical loads)
- Knowledge on the operational conditions endured and the aging mechanisms involved allow for the evaluation of the safe life of specific systems
- Weapon specific safe life predictions can prevent premature disposal, resulting in significant cost savings

Health motoring (The Netherlands)

- Operational conditions during:
 - Depot storage
 - Transport
 - Field storage
 - Naval applications
 - Assure safety (max. temperatures, “cooling” measures)
 - Predict changes in properties
 - Mechanical (strength, strain, ..)
 - Stability (stabiliser, gas cracking, ..)
 - Safety (exudation, ..)
- => Motor Safe Life

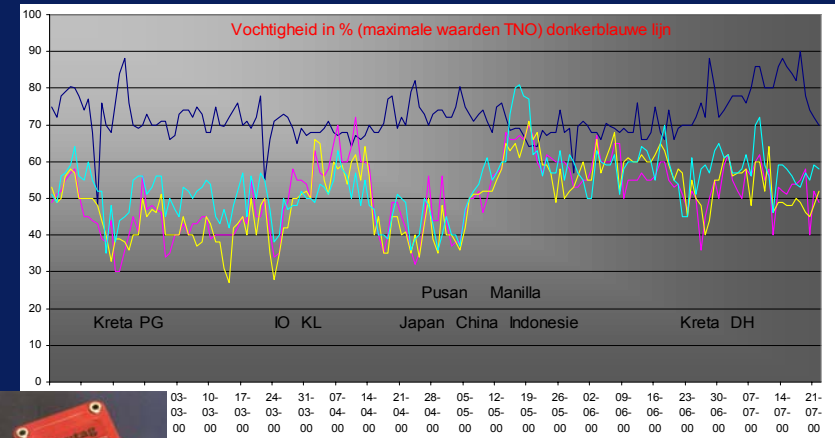

Hr. Ms. Witte de With (SM-1 storage)

Condition monitoring ammunition systems

((near) real time response capability)

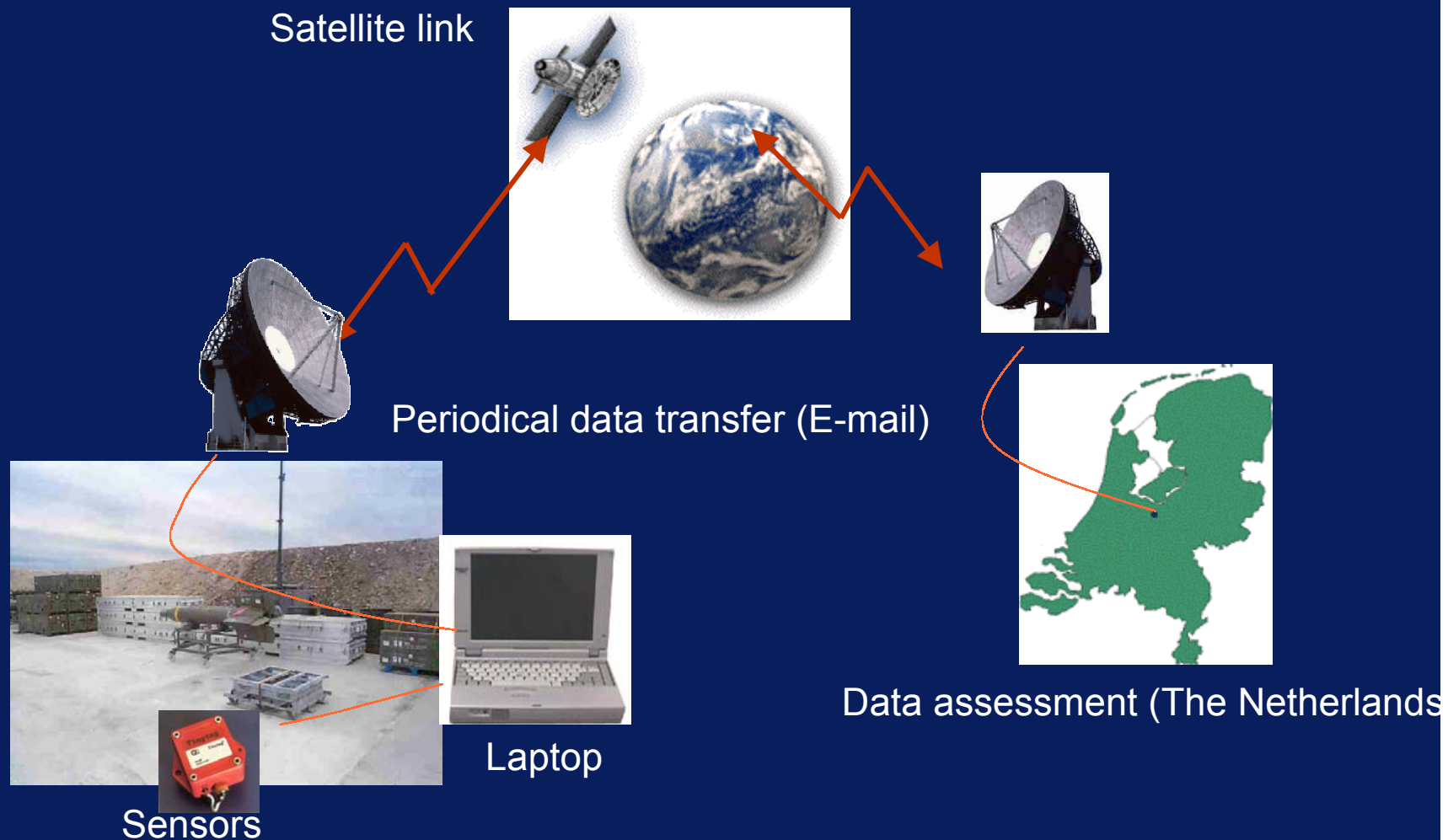

Temperature and RH sensor placing



Condition motoring (Example: Apache mission, Africa)

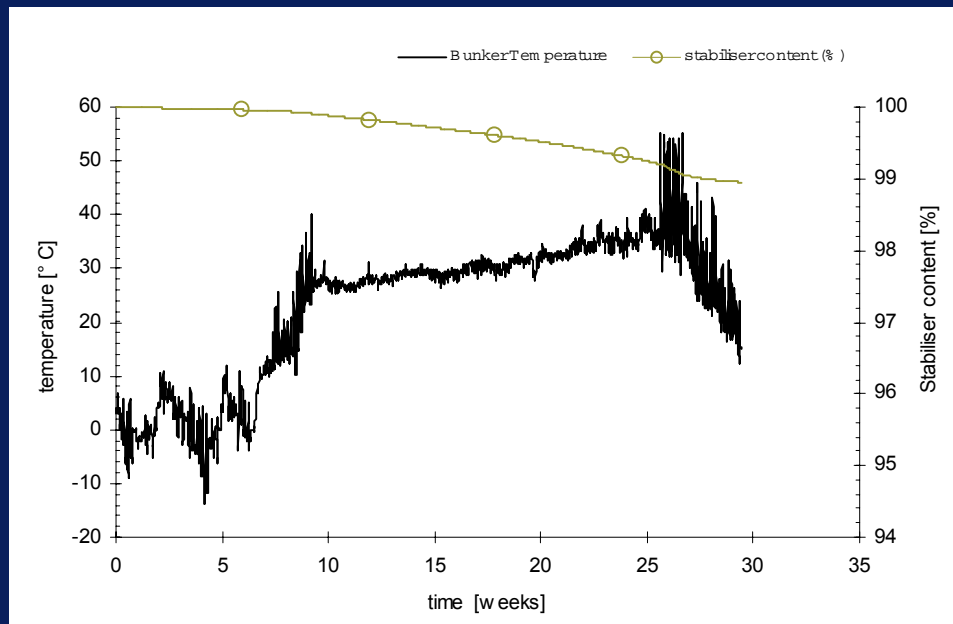

Predicted stabiliser depletion as a function of operational storage conditions

Health monitoring (Future)

Embedded sensors

- Temperature, stress, strain, humidity, O₂, degradation products (NO_x,...), ...
- Input for ageing models & direct safety check (cracks, stabiliser, etc.)

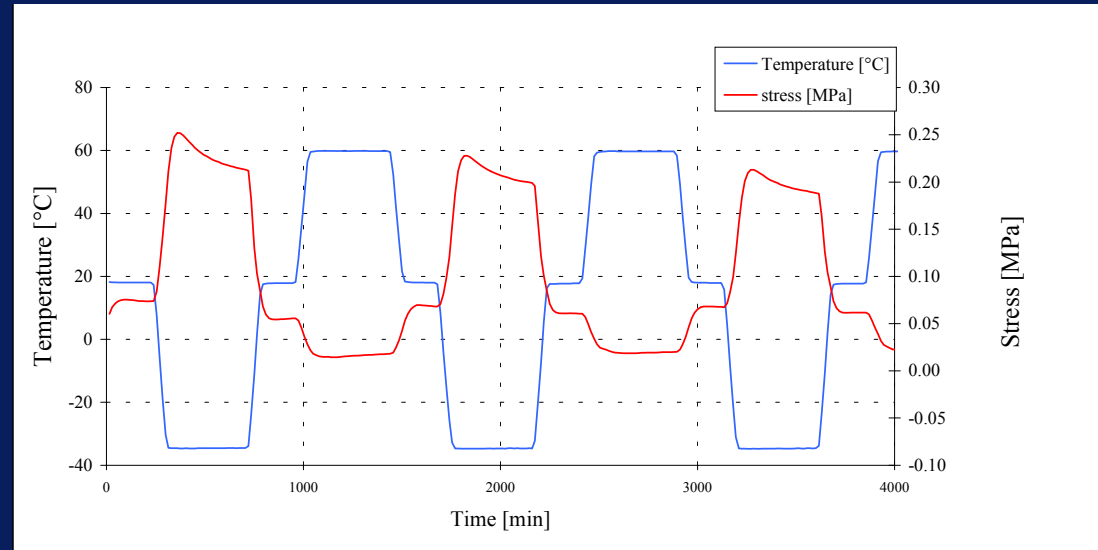

Stress levels and temperature in a motor analogue during thermal cycling

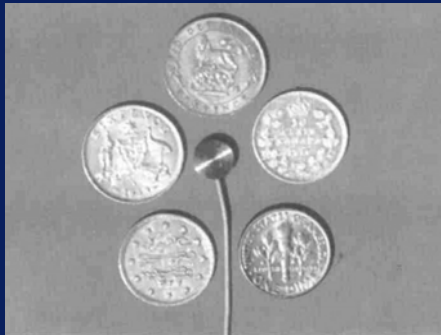

Bond stress sensor (Micron)

- **MEMS for:**
 - Communication
 - Sensors, physical and chemical
 - Data storage
 - Micropower

Health monitoring (TNO trials '02-'04)

Embedded Sensors Demo (rocket motor):

Assessment usability sensors for health monitoring purposes

- Thermal cycling
- Long term SRM ageing (6 months 60 °C trials)

Sensors

- stress sensor
- O₂-sensor
- RF-based temp sensor
- Fibre Braggs (T, stress, strain)

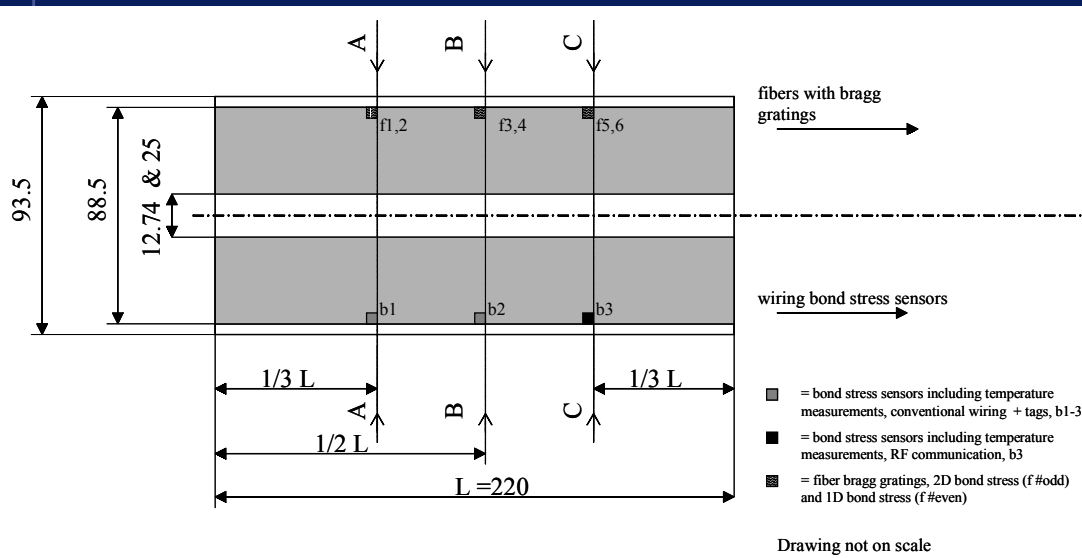

TNO development of autonomous RF powered multisensor device

Conclusive remarks

- MEMS will play an increasing role in missiles and GLNM.
- Civil applications almost necessary for MEMS devices.
- Development cost is still a hurdle to overcome.
- Telemetry will follow developments in communications.
- Application of health monitoring devices will greatly increase over the next decade and will include logistic applications. Their application will be part of a RTO-AVT CDT which is planned for 2003-2004.
- MEMS EFI detonators will become available.
- Boundary layer control might be the future way to control GLNM.

End



MEMS research at TNO

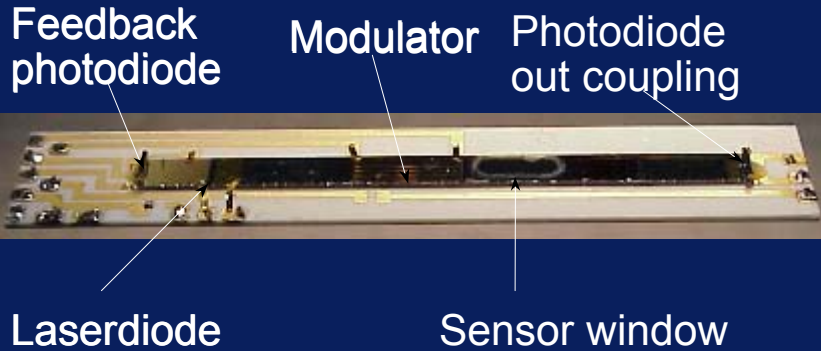

Mach zehnder sensor

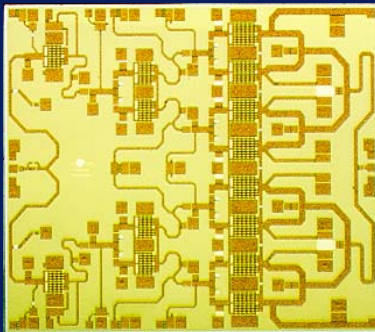
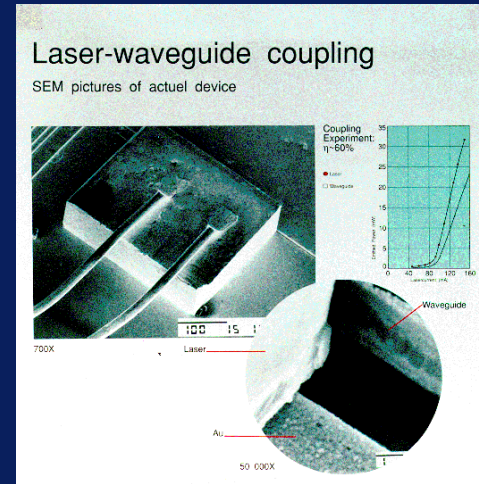

MMIC wideband power amplifier

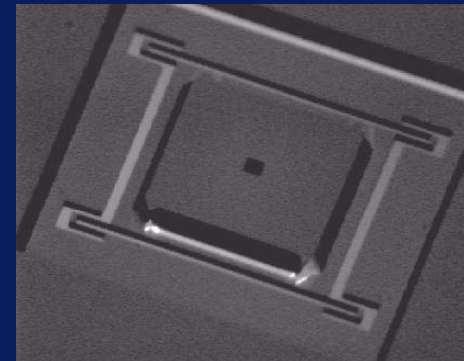

Opto-mechanical accelerometer

Principle of optical accelerometer

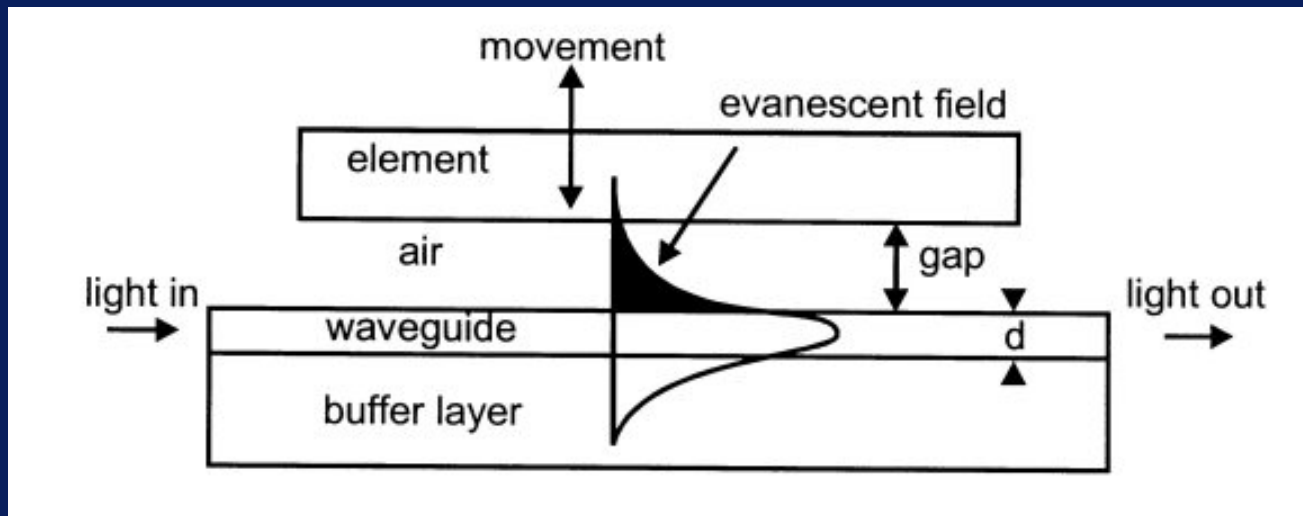

Design detail

