

*ARMY RESEARCH LABORATORY*



**Human Factors Assessment of the UH-60M Crew Station  
During the Early User Demonstration No. 2 (EUD2)**

**by Joshua S. Kennedy and David B. Durbin**

**ARL-MR-0607**

**February 2005**

## **NOTICES**

### **Disclaimers**

The findings in this report are not to be construed as an official Department of the Army position unless so designated by other authorized documents.

Citation of manufacturer's or trade names does not constitute an official endorsement or approval of the use thereof.

**DESTRUCTION NOTICE**—Destroy this report when it is no longer needed. Do not return it to the originator.

# **Army Research Laboratory**

Aberdeen Proving Ground, MD 21005-5425

---

---

**ARL-MR-0607**

**February 2005**

---

---

## **Human Factors Assessment of the UH-60M Crew Station During the Early User Demonstration No. 2 (EUD2)**

**Joshua S. Kennedy and David B. Durbin**  
Human Research and Engineering Directorate, ARL

---

---

Approved for public release; distribution unlimited.

---

---

# REPORT DOCUMENTATION PAGE

*Form Approved*  
OMB No. 0704-0188

Public reporting burden for this collection of information is estimated to average 1 hour per response, including the time for reviewing instructions, searching existing data sources, gathering and maintaining the data needed, and completing and reviewing the collection information. Send comments regarding this burden estimate or any other aspect of this collection of information, including suggestions for reducing the burden, to Department of Defense, Washington Headquarters Services, Directorate for Information Operations and Reports (0704-0188), 1215 Jefferson Davis Highway, Suite 1204, Arlington, VA 22202-4302. Respondents should be aware that notwithstanding any other provision of law, no person shall be subject to any penalty for failing to comply with a collection of information if it does not display a currently valid OMB control number.

**PLEASE DO NOT RETURN YOUR FORM TO THE ABOVE ADDRESS.**

<b>1. REPORT DATE (DD-MM-YYYY)</b> February 2005		<b>2. REPORT TYPE</b>		<b>3. DATES COVERED (From - To)</b> May 2003	
<b>4. TITLE AND SUBTITLE</b>  Human Factors Assessment of the UH-60M Crew Station During the Early User Demonstration No. 2 (EUD2)				<b>5a. CONTRACT NUMBER</b>	
				<b>5b. GRANT NUMBER</b>	
				<b>5c. PROGRAM ELEMENT NUMBER</b>	
<b>6. AUTHOR(S)</b>  Joshua S. Kennedy and David B. Durbin (both of ARL)				<b>5d. PROJECT NUMBER</b> 62716AH70	
				<b>5e. TASK NUMBER</b>	
				<b>5f. WORK UNIT NUMBER</b>	
<b>7. PERFORMING ORGANIZATION NAME(S) AND ADDRESS(ES)</b> U.S. Army Research Laboratory Human Research and Engineering Directorate Aberdeen Proving Ground, MD 21005-5425				<b>8. PERFORMING ORGANIZATION REPORT NUMBER</b> ARL-MR-0607	
<b>9. SPONSORING/MONITORING AGENCY NAME(S) AND ADDRESS(ES)</b>				<b>10. SPONSOR/MONITOR'S ACRONYM(S)</b>	
				<b>11. SPONSOR/MONITOR'S REPORT NUMBER(S)</b>	
<b>12. DISTRIBUTION/AVAILABILITY STATEMENT</b> Approved for public release; distribution unlimited.					
<b>13. SUPPLEMENTARY NOTES</b>					
<b>14. ABSTRACT</b>  Pilot workload, situational awareness (SA), and the pilot-vehicle interface (PVI) characteristics associated with the UH-60M Black Hawk crew station simulator were assessed during the Early User Demonstration No. 2. Additionally, simulator sickness was assessed to determine if the pilots experienced discomfort during missions and if the discomfort affected their perceived levels of workload and SA. Four highly experienced utility helicopter (UH)-60 pilots conducted a series of three different mission scenarios over the course of three days. Pilot feedback, which was obtained via a comprehensive questionnaire battery, showed that for the missions flown, workload in the UH-60M was comparable to the workload pilots experience in the UH-60A/L. Workload results showed that UH-60 aircrew training manual tasks related to digital messages and electronic radio navigation generated higher perceived workload in the UH-60M than in the A/L model. SA was reported to be similar to the UH-60A/L, but major gains were reported from the digital mapping system. The pilots noted several problems with the PVI, which should be resolved. Pilots experienced very mild simulator sickness symptoms. A panel of subject matter experts independently observed and evaluated each mission and reported that pilots experienced low to moderate levels of workload during the missions and moderate levels of SA. Finally, an eye tracker system was used to assess visual gaze during several of the trials. The visual gaze data were used to assess visual workload.					
<b>15. SUBJECT TERMS</b> EUD; pilot-vehicle interface; pilot workload; situational awareness; UH-60M Black Hawk					
<b>16. SECURITY CLASSIFICATION OF:</b>			<b>17. LIMITATION OF ABSTRACT</b>  UL	<b>18. NUMBER OF PAGES</b>  145	<b>19a. NAME OF RESPONSIBLE PERSON</b> Joshua S. Kennedy
<b>a. REPORT</b> Unclassified	<b>b. ABSTRACT</b> Unclassified	<b>c. THIS PAGE</b> Unclassified			<b>19b. TELEPHONE NUMBER (Include area code)</b> 831-601-7445

Standard Form 298 (Rev. 8/98)  
Prescribed by ANSI Std. Z39.18

---

## Contents

---

<b>List of Figures</b>	<b>v</b>
<b>List of Tables</b>	<b>v</b>
<b>Acknowledgments</b>	<b>vii</b>
<b>1. Introduction</b>	<b>1</b>
1.1 Purpose	1
1.2 Assessment of Crew Workload	1
1.2.1 Bedford Workload Rating Scale	1
1.3 Assessment of Crew Situational Awareness (SA)	1
1.3.1 SA Rating Technique	4
1.4 Assessment of the UH-60M Crew Station PVI	4
1.5 Assessment of Simulator Sickness	4
1.5.1 Simulator Sickness Questionnaire (SSQ)	5
1.6 UH-60M EUD2 Simulation Procedure	5
1.6.1 Tactical Steering Committee	5
1.7 UH-60M Black Hawk System Description	5
1.7.1 AMRDEC APEX Labs	7
1.7.2 Battlefield Highly Immersive Virtual Environment (BHIVE)	8
1.7.3 The Reconfigurable UH-60M Crew Station	9
1.7.4 The Reconfigurable UH-60 Crew Station Software	10
<b>2. Method</b>	<b>11</b>
2.1 Participants	11
2.2 Data Collection	12
2.2.1 Eye Tracker System	12
2.2.2 Audio-Video Collection	12
2.3 Data Analysis	14
2.4 Limitations of Assessment	14
2.5 Test Schedule and Description of Mission Scenarios	15
<b>3. Results</b>	<b>16</b>
3.1 Crew Workload	16
3.1.1 Mean Workload Ratings for ATM Tasks	16
3.1.2 TSC Ratings for Workload and Crew Coordination	18
3.2 Crew Situational Awareness	19
3.2.1 SA Ratings by the Subjects	19

3.2.2	SA of Battlefield Elements.....	22
3.2.3	TSC SA Ratings .....	23
3.3	Pilot-Vehicle Interface (PVI) .....	23
3.3.1	MFD Symbology .....	23
3.3.2	JVMF Messages .....	24
3.3.3	Other PVI Comments .....	25
3.4	Simulator Sickness .....	25
3.4.1	Comparison of BHIVE SSQ Scores to Other Helicopter Simulators .....	25
3.5	Eye Tracker .....	26
<b>4.</b>	<b>Summary</b>	<b>28</b>
4.1	Summary of Crew Workload .....	28
4.2	Summary of Crew SA .....	29
4.3	Pilot-Vehicle Interface .....	29
4.4	Simulator Sickness .....	30
4.5	Eye/Head Tracker.....	30
<b>5.</b>	<b>Recommendations</b>	<b>30</b>
<b>7.</b>	<b>References</b>	<b>31</b>
	<b>Appendix A. Bedford Workload Rating Scale (BWRS) Questionnaire</b>	<b>33</b>
	<b>Appendix B. UH-60 Black Hawk Air Crew Training Manual (ATM) Tasks</b>	<b>37</b>
	<b>Appendix C. SA Rating Technique (SART) Questionnaire</b>	<b>39</b>
	<b>Appendix D. PVI Questionnaire</b>	<b>43</b>
	<b>Appendix E. Simulator Sickness Questionnaire (SSQ) Pre- and Post-Mission</b>	<b>53</b>
	<b>Appendix F. TSC Questionnaire</b>	<b>55</b>
	<b>Appendix G. EUD2 APEX Lab System Diagrams</b>	<b>59</b>
	<b>Appendix H. Results of Eye Tracker System</b>	<b>61</b>
	<b>Appendix I. Demographic/Anthropometric Questionnaire</b>	<b>63</b>
	<b>Appendix J. EUD2 Operations Order</b>	<b>65</b>
	<b>Appendix K. Air Crew Mission Briefings</b>	<b>71</b>
	<b>Appendix L. Summary of Crew Workload Ratings and Comments</b>	<b>119</b>
	<b>Appendix M. Summary of Crew SA Ratings and Comments</b>	<b>121</b>
	<b>Appendix N. Summary of TSC Comments</b>	<b>123</b>

<b>Appendix O. Summary of Pilot Ratings and Comments About the PVI</b>	<b>125</b>
<b>Acronyms</b>	<b>129</b>
<b>Distribution List</b>	<b>131</b>

---

## List of Figures

---

Figure 1. Bedford workload rating scale (BWRS).....	3
Figure 2. Artist’s rendering of the UH-60M Black Hawk crew station (courtesy of SAC). .....	7
Figure 3. APEX battlemaster station. (At left is the exercise controller, at right is the DCD UH 60M project officer.) .....	8
Figure 4. BHIVE EUD2 configuration. ....	9
Figure 5. UH-60M BHIVE crew station used for EUD2.....	10
Figure 6. Primary flight display page on an MFD. ....	11
Figure 7. Eye tracker FOV and data capture viewing planes. ....	13
Figure 8. Quad view of EUD2 audio-video collection on DVD.....	13
Figure 9. Workload ratings on ATM tasks for UH-60A/L versus UH-60M. ....	16
Figure 10. Workload ratings on ATM tasks between left and right seats (UH-60M only). .....	17
Figure 11. Overall TSC crew coordination ratings.....	19
Figure 12. Overall SART scores for UH-60A/L versus UH-60M.....	20
Figure 13. Overall SART scores between left and right seats (UH-60M only).....	20
Figure 14. Overall SART subscale ratings between UH-60M and UH-60A/L. ....	21
Figure 15. Overall SART subscale ratings between left and right seats (UH-60M only). .....	21
Figure 16. FOV with the eye tracker camera. ....	27
Figure 17. Composite of visual gaze data.....	28

---

## List of Tables

---

Table 1. Pilot demographics (N = 4).....	11
Table 2. SART subscale ratings between UH-60A/L and UH-60M. ....	22
Table 3. SART subscale ratings between left and right seats (UH-60M only).....	22
Table 4. Ratings for SA of battlefield elements.....	23
Table 5. Ratings of crew SA.....	23
Table 6. Simulator sickness questionnaire (SSQ) ratings.....	25
Table 7. Comparison of BHIVE SSQ ratings with other helicopter simulators. ....	26
Table 8. Composite results of eye tracker.....	28

INTENTIONALLY LEFT BLANK

---

## Acknowledgments

---

The authors wish to acknowledge several key people who directly contributed to the success of this demonstration. Chief Warrant Officer 4 (CW4) Nick Nickles and Captain (CPT) Doug Ferrel designed all the mission scenarios, wrote the operations order and air crew briefings, and prepared all the materials necessary for our subject pilots to fly their missions. CW4 Nickles was the UH-60M Project Officer in the Directorate of Combat Developments (DCD) at Fort Rucker, Alabama, the home of Army Aviation. CPT Ferrell was a military science instructor at the University of Wisconsin (Stevens Point) assigned to DCD during the summer of 2003.

From the Sikorsky Aircraft Corporation, Harvey Bordett is the lead crew station engineer for the utility helicopter (UH)-60M. Harvey helped prepare the demonstration and execute the data collection, as well as conduct a peer review of this report. He has been involved in every step of the UH-60M crew station development. We are also grateful to our other peer reviewers for their time, attention, and expertise: Dr. Mike McCauley of the Naval Postgraduate School in Monterey, California, and Mr. Dan Francis of the Aviation & Missile Research Development, & Engineering Center (AMRDEC).

From the U.S. Army Aeromedical Research Laboratory at Fort Rucker, CPT Gina Adam was instrumental in the use of the eye-tracking technology and was extremely helpful in the initial data reduction and analysis that came from the system.

From the Aviation & Missile Command at Redstone Arsenal, Alabama, several individuals deserve recognition. Daniel Kern is the test and evaluation leader for the UH-60M and sponsors the crew station development and early user demonstration (EUD) process. His support in assembling EUD2 was invaluable.

Thanks also go to Will Nikonchuk from the Systems Simulation & Development Directorate of AMRDEC. Will is the Government leader for the Advanced Prototyping, Engineering, and eXperimentation (APEX) laboratories, and his support of the UH-60M program has been unwavering over the years.

A huge “thank you” goes to Jimmy Moore and the entire Science Applications International Corporation crew that runs the APEX laboratories. These men and women assembled an incredible hardware and software package that allowed us to conduct a sophisticated flight simulation of the UH-60M crew station. Because of their efforts, we were able to make rapid changes in the design and interface of the system. Much of the description of the APEX labs comes from Mr. Moore and a paper he prepared for the 2003 Interservice/Industry Training, Simulation, & Education Conference.

Finally and most importantly, our hearty thanks to our four participants, who shall remain unnamed for scientific protocol reasons. Professional Army aviators all, they and their comrades are the reason that we work so diligently on this aircraft.

INTENTIONALLY LEFT BLANK

---

# **1. Introduction**

---

## **1.1 Purpose**

The utility helicopter (UH)-60M Early User Demonstration No. 2 (EUD2) was a system evaluation of the current UH-60M crew station design, primarily from a human factors standpoint. The primary objectives of EUD2 were to

- a. Provide data to support UH-60M crew station functionality and design baseline for the systems critical design review;
- b. Conduct a human factors evaluation that will provide an early assessment of pilot-vehicle interface (PVI), crew workload, and situational awareness (SA);
- c. Evaluate the functionality of several new crew station components that are still undergoing design. These include the digital mapping system (DigMap), the joint variable message format (JVMF) system, multi-function slew controller (MFSC), flight director/display control panel (FD/DCP), and flight management system (FMS).

At the request of the UH-60M Project Manager's Office (PMO), the U.S. Army Research Laboratory's (ARL's) Human Research and Engineering Directorate conducted a human factors evaluation of the UH-60M crew station, which focused on PVI, workload, and SA. Simulator sickness data were also collected and evaluated during the demonstration.

EUD2 was considered an "engineering event" rather than a formal test event, and the chief focus was on risk assessment and mitigation in the crew station. As such, we focused on identifying components that needed further design work to improve the overall crew station design. EUD2 was the second in a series of three EUDs designed to demonstrate and evaluate the UH-60M crew station. EUD1 was conducted in January 2001 and was the first step in human factors design and evaluation of the new crew station (Nikonchuk, 2001). The UH-60M Limited User Test (LUT) will formally evaluate the UH-60M crew station. This memorandum report is the first in a planned series of ARL reports about the design of the UH-60M crew station.

## **1.2 Assessment of Crew Workload**

A common definition of pilot workload is "the integrated mental and physical effort required to satisfy the perceived demands of a specified flight task" (Roscoe & Ellis, 1990). It is important to assess pilot workload because mission accomplishment is related to the mental and physical ability of the crew to effectively perform their flight and mission tasks. If one or both pilots experience excessively high workload while performing flight and mission tasks, the tasks may be performed ineffectively or abandoned. In order to assess whether the pilots are overloaded with tasks during the mission profiles, the level of workload for each pilot must be evaluated.

### **1.2.1 Bedford Workload Rating Scale**

To estimate the level of workload needed to perform Black Hawk Air Crew Training Manual (ATM) tasks, the subjects completed the Bedford Workload Rating Scale (BWRS) (see figure 1 and appendix A) immediately after each mission. They used the BWRS to rate the workload needed to accomplish several UH-60M tasks (see appendix B), as well as their assessment of the workload necessary to complete the same tasks as if they had been performed in a UH-60A/L. This provided an overall assessment of the workload required to perform the missions in the UH-60M as compared to the UH-60A/L.

The BWRS has been used extensively by the military, civil, and commercial aviation communities for pilot workload estimation (Roscoe & Ellis, 1990). It requires pilots to rate the level of workload associated with a task, based on the amount of spare workload capacity they feel they have to perform additional tasks. Spare workload capacity is an important commodity for pilots because they are often required to perform several tasks concurrently. For example, co-pilots often perform navigational tasks, communicate via multiple radios, monitor aircraft systems, and assist the pilot with controls of flight tasks (e.g., maintain air space surveillance) within the same time interval. Mission performance is reduced if pilots are task saturated and have little or no spare capacity to perform other tasks. Design of the UH-60M crew station should help ensure that pilots can maintain adequate spare workload capacity while performing flight and mission tasks.

### **1.3 Assessment of Crew Situational Awareness (SA)**

SA can be defined as the pilot's mental model of the current state of the flight and mission environment. A more formal definition is "the perception of the elements in the environment within a volume of time and space, the comprehension of their meaning, and the projection of their status in the near future" (Endsley, 1988). It was important to assess SA during EUD2 because it had a direct impact on pilot and system performance. Good SA should increase the probability of good decision and good performance by air crews when they perform flight and missions task in the UH-60M.

An individual air crew member's mental picture of the pilotage and related mission tasks is a broad definition of SA. This picture is constructed from continuous flight instrument and exterior scene information. Integration of the interior and exterior stimuli with previous learned knowledge is used to direct air crew behavior, define information-gathering needs and patterns, and anticipate future events. Symbology used by the air crew during normal flight and extreme attitudes was evaluated in order to ensure that pilots could rapidly understand the symbology and control the aircraft accordingly. Symbols and information pertaining to excessive pitch, roll, and yaw attitudes as well as high and low speed cues and positional cueing during hover were examined. Transition flight conditions were evaluated with regard to adequate information presentation. Proper SA will help prevent a hazardous flight condition from developing.

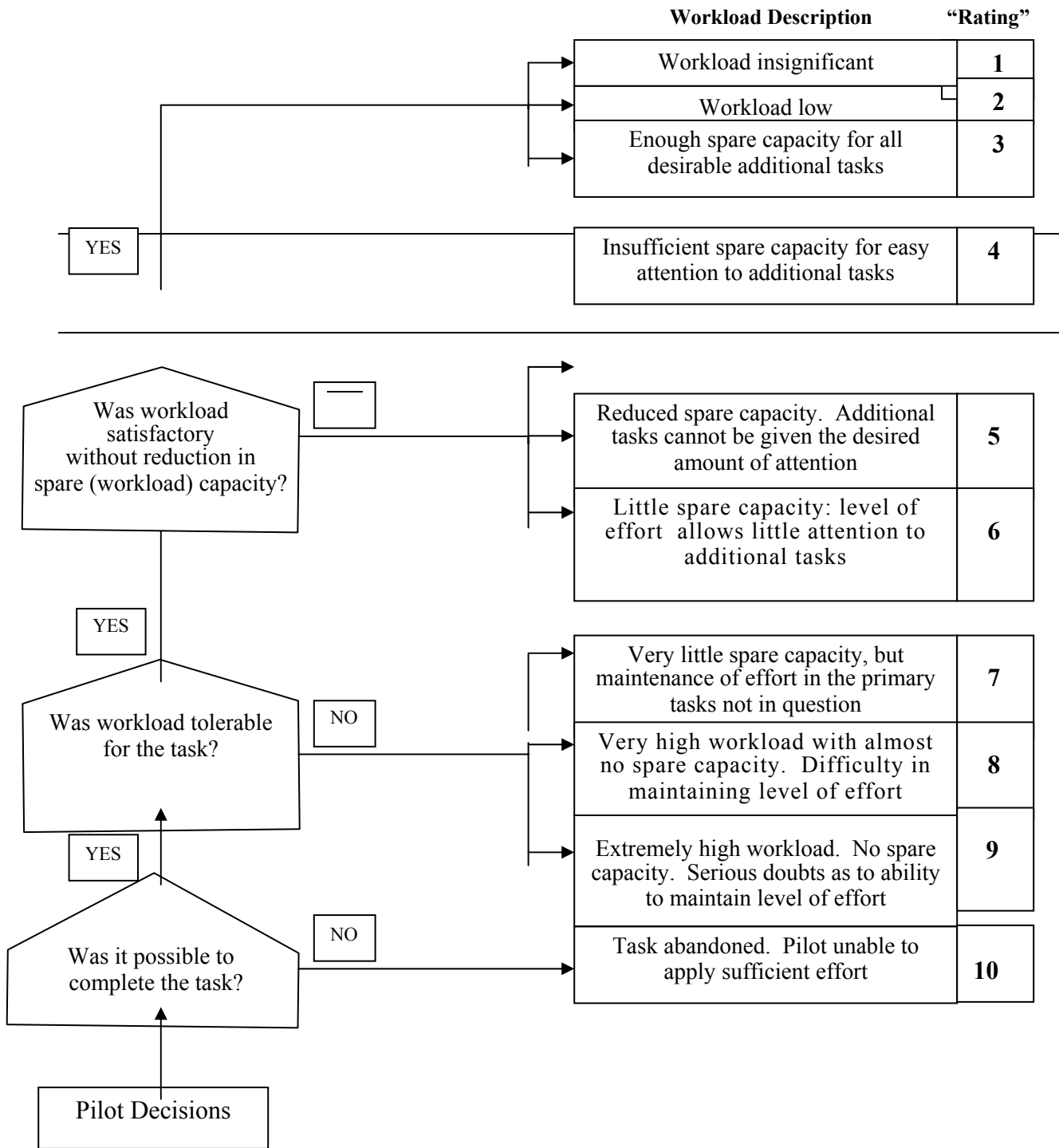

Figure 1. Bedford workload rating scale (BWRS).

### **1.3.1 SA Rating Technique**

The Situational Awareness Rating Technique (SART) is a multi-dimensional rating scale for operators to report their perceived SA. The SART was developed as an evaluation tool for the design of air crew systems (Taylor, 1989), and it examines the three key areas of SA: understanding, supply, and demand. These areas are further segregated into the 10 total dimensions (see appendix C). From the ratings given on each of the dimensions, SA is calculated by the equation  $SA = U - D + S$  in which U is summed understanding, D is summed demand, and S is summed supply. Taylor proposed that SA depends on the pilot's understanding (U) (e.g., quality of information he receives) and the difference between the demand (D) (e.g., complexity of mission) on the pilot's resources and the pilot's supply (S) (e.g., ability to concentrate). When demand exceeds supply, there is a negative effect on understanding and an overall reduction of SA. The SART is one of the most thoroughly tested rating scales for estimating SA (Endsley, 2000). It is simple, quick, and easy to use.

### **1.4 Assessment of the UH-60M Crew Station PVI**

The crew station PVI impacts crew workload and SA during a mission. A crew station that is designed to augment the cognitive and physical abilities of crews will minimize workload, enhance SA, and contribute to successful mission performance. To assess the PVI, the pilots reported any problems that contributed to high workload and low SA at the end of each mission trial. They also completed a comprehensive questionnaire (appendix D) at the end of each trial. The PVI questionnaire addressed usability characteristics of the UH-60M crew station.

### **1.5 Assessment of Simulator Sickness**

Simulator sickness has been defined as a condition when pilots suffer physiological discomfort in the simulator but not while flying the actual aircraft (Kennedy, Lilienthal, Berbaum, Balzley, & McCauley, 1989). It is generally believed that simulator sickness is caused by a mismatch either between the visual and vestibular sources of information about self-motion or between the sensory information (e.g., acceleration cues) presented by the simulator and the sensory information presented by the primary aircraft that the pilot operates. When the sensory information presented by the simulator does not match the aircraft, the pilot's nervous system reacts adversely to the sensory mismatch and the pilot begins to experience discomfort. Characteristics of simulator sickness include nausea, dizziness, drowsiness, and several other symptoms (Kennedy et al., 1989). It is important to assess simulator sickness because the discomfort felt by pilots can be a distraction from flight tasks. Pilot distraction is one of the operational consequences of simulator sickness listed by Crowley (1987). If pilots are distracted by the discomfort they feel during missions, their performance is likely to suffer. Additionally, the discomfort could influence the perceived levels of workload and SA that the pilots experienced during a mission.

### **1.5.1 Simulator Sickness Questionnaire (SSQ)**

The SSQ (appendix E) was administered to the pilots to estimate the severity of physiological discomfort that they experienced during missions and help assess whether they were being distracted by the discomfort. The SSQ (Kennedy, Lane, Berbaum, & Lilienthal, 1993) is a checklist of 16 symptoms that are categorized into three subscales: oculomotor (e.g., eyestrain, difficulty focusing, blurred vision), disorientation (e.g., dizziness, vertigo), and nausea (e.g., nausea, increased salivation, burping). The three subscales are combined to produce a total severity score; this is an indicator of the overall discomfort that the pilots experienced during the mission.

### **1.6 UH-60M EUD2 Simulation Procedure**

The EUD2 missions were derived from the Objective Force Aviation Concept of Operations (now referred to as Future Force). The missions, described in further detail in section 2.5, were prepared by Directorate of Combat Development (DCD) at Fort Rucker, Alabama, to reflect expected mission scenarios against a threat projected to exist in 2015. Three separate mission vignettes were developed: air movement-casualty evacuation (CASEVAC), air assault, and long range surveillance detachment (LRSD) deep insertion. Scenarios were run on the Fort Benning, Georgia, terrain database. All missions originated from Lawson Army Airfield at Fort Benning.

#### **1.6.1 Tactical Steering Committee**

A tactical steering committee (TSC) observed each mission and rated crew workload, crew SA, crew coordination, and mission success (see appendix F). The TSC provided an independent assessment of the workload and SA levels experienced by the crews. They also helped identify whether problems with crew workload or crew SA contributed to lack of mission success.

One TSC member was the UH-60M user representative from DCD, Fort Rucker. The other TSC member was a UH-60 program analyst with DCD at Fort Rucker who is also a retired Chief Warrant Officer 5 (CW5) and Master Army aviator. He has substantial experience with utility helicopter and Army aviation missions. Both TSC members were very knowledgeable of the UH-60M crew station. TSC personnel observed each mission from the battle master station in the Advanced Prototyping, Engineering, and eXperimentation (APEX) Laboratories where they could observe crew station displays and the outside world visual representation given to the air crews. They also listened to all audio communications between crew members and outside sources during the missions. A large projection map provided real-time status of the location of the UH-60M aircraft on the terrain database.

### **1.7 UH-60M Black Hawk System Description**

The UH-60 Black Hawk mission is to project and sustain the force by providing air assault, general support, command and control, and aeromedical evacuation capabilities to the war fighter. Lessons learned in conflicts through the 1990s and early 2000s, as well as emerging Future Force doctrine, highlight the operational deficiencies of the current UH-60A/L helicopter.

The operational requirements document for recapitalization and improvement of the UH-60 fleet (approved in January 2001) includes a list of capability shortfalls. As a result, the need exists for an improved version of the existing UH-60 helicopter to meet evolving war-fighting concepts and to ensure that the system is equipped and capable of meeting operational requirements, beginning in the year 2006 and beyond.

The UH-60 Black Hawk modernization program was established to meet the new requirements for supporting the Future Force. This includes increased lift, range, reliability, maintainability, survivability, and digitized capability for the future battlefield. The program is also designed to address the challenges of the aging fleet, such as decreasing operational readiness and increasing operating, support, and maintenance costs. The UH-60M, manufactured by Sikorsky Aircraft Corporation (SAC), has additional improvements in airframe, electrical system, main rotor blades, flight control computer, crew station, and avionics. Airframe improvements include refurbishment or replacement of cabin components and refurbishment of tail cone, stabilator, vertical pylon, airframe tuning devices, troop seats, and crew seats.

The UH-60M crew station and avionics improvements represent the most significant changes in the Black Hawk configuration (see figure 2). The modernization program will produce a fully digital “glass” crew station that is designed to enhance battlefield SA and decrease pilot workload. The crew station has undergone the transformation from analog to digital through the integration of four multi-function displays (MFDs). These MFDs increase tactical and flight SA by displaying selectable pages for the primary flight instruments, navigational system, dynamic digital map, communications, and engine instrument caution advisory system (EICAS). Additionally, the FMS was integrated to provide an improved user interface for control of all voice, navigational and digital communications, as well as enhanced fault management and system status reporting (Robinson & Hamilton, 2003).

The new crew station also has improved navigational systems and an improved data modem running the JVMF software that provides an interface to the tactical internet. The crew station has an improved flight control system, which can be coupled through the FD/DCP. This system enables an autopilot feature for “hands off” flight. The crew station also adds an MFSC for each pilot. This device gives the pilot and co-pilot cursor control for MFD page navigation. This capability will provide standard computer cursor control functionality for navigation, selection, and interaction with the various pages. This control interface enhances crew station control of the digital map, allowing pilots to interactively select icons, modify routes, and send spot reports via JVMF without leaning forward to select bezel buttons on the MFD displays. The MFSC has future potential use on the HH-60M medical evacuation (MEDEVAC) variant for controlling the forward looking infrared, which is used for nighttime operations as well as search and rescue efforts.



Figure 2. Artist's rendering of the UH-60M Black Hawk crew station (courtesy of SAC).

### **1.7.1 Aviation & Missile Research Development, & Engineering Center (AMRDEC) APEX Labs**

To conduct EUD2, the UH-60M PM directed the use of AMRDEC's APEX laboratories at Redstone Arsenal, which offers the appropriate virtual prototyping capabilities for the process. The APEX mission is to provide modeling and simulation (M&S) support of weapons system design early in the acquisition process. This is accomplished through several means including human-in-the-loop simulators, distributed simulation experimentation, and constructive simulation development. The APEX labs are high-level architecture (HLA) and distributed interactive simulation (DIS) compliant and have the capability to connect to the Army's battle labs and other distributed simulation facilities through the Defense Research and Engineering Network. This capability enables geographically dispersed simulations to be linked in a single distributed experiment architecture.

The lab infrastructure is designed to support experimentation through a wide range of technologies. The lab includes a Battlemaster or exercise control station that has access to each simulation "playing" on the network by means of a modular semi-automated forces (ModSAF) terminal, data collection devices, headset communications, and video monitoring. All exercises are conducted from the Battlemaster station to ensure that all players are engaged in the exercise and that all data collection devices are active. The Battlemaster station provided the exercise

controller and subject matter experts (SMEs) with all the information needed to coordinate the scenario-driven events and data collection devices required for the EUD events (see figure 3 and appendix G). The APEX facility has a complete synthetic environment development team that is able to develop custom, correlated terrain databases that were designed to specifically enhance the realism of the immersive environment and support the operational scenarios for each event.



Figure 3. APEX battlemaster station. (At left is the exercise controller; at right is the DCD UH-60M project officer. Behind the curtain at the upper left is the UH-60M crew station.)

### 1.7.2 Battlefield Highly Immersive Virtual Environment (BHIVE)

Another significant component of the APEX labs was the BHIVE. BHIVE was developed in support of weapon system evaluation in an HLA- and DIS-compliant, human-in-the-loop virtual environment. It was designed with a “roll-in/roll-out” capability to allow several types of devices to be integrated into the environment through a standard interface. This capability provides the flexibility to immerse multiple types of crew stations in a realistic and reusable synthetic world.

BHIVE is an enclosed environment that consists of a projection system, three-dimensional surround sound audio, and a plug-and-play interface for the integration of various engineering analysis devices including the UH-60M and AH-64A reconfigurable crew station, AH-1W and Z Cobra crew stations, RAH-66 Comanche crew station, and a tube-launched optically tracked

wire-guided missile simulator mounted on a high mobility multipurpose wheeled vehicle chassis. The projection system consists of a fixed base bi-directional curved screen with three soft edge blended projectors and an image generation system. The screen provides a field of view (FOV) of 40 degrees vertical (111.61 inches) and 150 degrees horizontal (229 inches). The distance from the screen to the pilot and co-pilot is approximately 152 inches. BHIVE also includes a controller station, a video switching rack and reconfigurable video cameras. BHIVE allowed the pilots and human factors engineering (HFE) experts to experiment with crew station layout designs and perform initial SA and workload assessment studies.

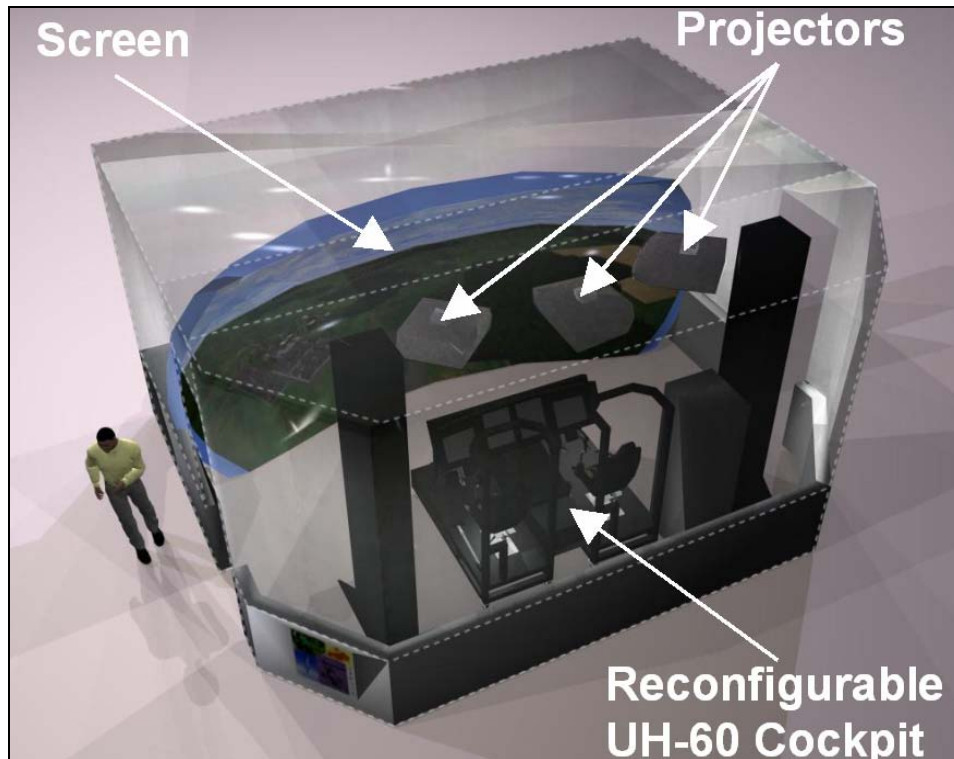

Figure 4. BHIVE EUD2 configuration.

### 1.7.3 The Reconfigurable UH-60M Crew Station

The implementation of the M&S strategy for the crew station design process centered on the design of the reconfigurable crew station. An overarching concern about the UH-60M engineering and analysis crew station was balancing reconfigurability with fidelity. The crew station had to be reconfigurable enough that design changes could be made quickly and yet be realistic enough that the pilots could provide the necessary feedback to human factors experts.

The reconfigurable UH-60 crew station was designed to provide maximum utility and usability throughout the EUD process. The crew station used flat panel liquid crystal displays and touch screen technology to replicate human-machine hardware interfaces for the four MFDs, two FMSs, and other control surfaces within the crew station. This configuration allowed for rapid software prototyping of the look, feel, and function of each crew station component. The crew

station also had integrated 1553 and ARINC 429<sup>1</sup> buses, which provided capability to integrate actual tactical hardware. See figure 5 for a photo of the UH-60M BHIVE crew station, and compare to figure 2.



Figure 5. UH-60M BHIVE crew station used for EUD2. (Note that the MFDs and FMS are replicated with touch screens versus actual hardware; courtesy of AMRDEC and Science Applications International Corporation.)

#### 1.7.4 The Reconfigurable UH-60 Crew Station Software

The software configuration for EUD2 evolved throughout the crew station development process. The flight model used for replicating the six-degree-of-freedom (6-DOF) flight dynamics of the aircraft was based on the FlightLab commercial off-the-shelf (COTS) software. The initial module implemented in FlightLab was the UH-60L model supplied by the vendor, Advanced Rotorcraft Technologies. The APEX software team then migrated the software from this initial drop to the Aviation Combined Arms Tactical Trainer UH-60L flight model, which is currently undergoing accreditation. AMRDEC's Aviation Engineering Directorate provided the development environment for modification of the flight model and the engineering expertise to verify flight model characteristics.

The avionics software was developed with the GLStudio<sup>2</sup> COTS product. This software provided a robust and user-friendly interface for MFD page prototyping. The pages were developed on the basis of input from Army aviators, crew station engineers, and test pilots from SAC, HFE experts from the Army and SAC, and other participants in the Crew Station Working Group process. An example of the MFD page prototyping (primary flight display page) is shown in figure 6.

<sup>1</sup>ARINC 429 is a trademark of Aeronautical Radio, Inc.

<sup>2</sup>GLStudio is a trademark of Distributed Simulation Technology, Inc.



Figure 6. Primary flight display page on an MFD.

## 2. Method

### 2.1 Participants

Participants were four male Army pilots from Fort Rucker and Fort Bragg, North Carolina. From Fort Rucker, one participant was a UH-60 instructor pilot (IP). One participant was a senior UH-60 maintenance test flight examiner pilot with the Directorate of Standardization and Evaluation. One participant was an experiment test pilot with the U.S. Army Aviation Technical Test Center. The participant from Fort Bragg was a UH-60 standardization instructor pilot with the 82d Aviation Brigade. Three of the pilots held the rank of CW3 and one pilot held the rank of CW4. They represented a group of very experienced pilots with total flight hours that ranged from 2,200 to 3,025 hours. Most of their total flight hours were in the UH-60A or UH-60L. All the pilots had previous experience operating the UH-60M simulator at the APEX lab and were somewhat familiar with the new UH-60M components. The relevant demographic characteristics of the pilots are listed in table 1.

Table 1. Pilot demographics (N = 4).

Summary of demographic characteristics	Age (yrs)	Flight hours in UH-60A/L Black Hawk	Total flight hours in Army aircraft	Flight hours with night vision devices
Mean	37.5	2,287	2,694	628
Median	38	2,275	2,275	625
Range	32 to 42	1700 to 2900	2200 to 3025	560 to 700

## **2.2 Data Collection**

The BWRS, SART, SSQ, crew station PVI, and TSC questionnaires (appendices A, C, E, H, and I) were developed in accordance with published guidelines for proper format and content (O'Brien & Charlton, 1996). A pre-test was conducted to refine the questionnaires and to ensure that they could be easily understood and completed by pilots and TSC members.

The pilots and TSC members completed the PVI, workload, and SA questionnaires immediately after each mission. The pilots completed the SSQ before and after each mission. TSC members completed the mission success questionnaire after each mission. Additional data were obtained from the pilots during missions and from pilots and TSC members during post-mission discussions and the final after-action review (AAR). Questionnaire results were clarified with information obtained during post-mission discussions and the daily AARs.

### **2.2.1 Eye Tracker System**

Although the data from the questionnaires were systematically gathered by widely accepted HFE methods, they were still subjective in nature. Complementary objective data were collected through a head and eye tracking system from Polhemus. Their VisionTrak<sup>3</sup> head-mounted, eye-tracking system is a fully integrated solution for eye and target tracking. This system collected pupil size, eye movement, and eye point of regard (gaze). It correlated the raw eye position to the precise position in the scene and collected data in real time from human subjects while allowing complete freedom of head movement. The image being viewed by the subject was identified by crosshairs and instantaneously superimposed over live imagery (see figure 7). Built-in analysis software allowed data to be viewed in tabular or graphical format, including velocity, acceleration, and gazing information.

This system allowed APEX engineers to quickly establish viewing planes that were used to capture specific data regarding critical areas of the crew station for rapid data reduction. Additionally, the APEX team was able to experiment with an eye-tracking system that was integrated into the pilot's existing helmet to add more realism and immersion for the pilot test subject.

### **2.2.2 Audio-Video Collection**

Participant comments, concerns, and actions were recorded for each mission via video-taped simulation runs and AARs. This video capture was time stamped and cataloged for each run to give the participants a permanent record of the events and feedback for each set of crews in each scenario. The APEX manager distributed the data to selected personnel for post-demonstration analysis and documentation. Figure 8 is an image of the quad-screen view of the video collected during EUD2. The video from the pilot camera is shown in the upper left; the video from the over-the-shoulder camera is shown in the upper right; the left side in-board MFD is shown on the lower left (the digital map); and the pilot outboard MFD (showing the primary flight display

---

<sup>3</sup>VisionTrak is a trademark of Polhemus.

[PFD]) on the lower right. The quad view could be modified as required to display any of the other cameras or video input that the exercise controller deemed necessary for data collection.



Figure 7. Eye tracker FOV and data capture viewing planes. (OTW = out the window.)



Figure 8. Quad view of EUD2 audio-video collection on DVD.

### **2.3 Data Analysis**

Pilot responses to the BWRS, SART, SSQ, and PVI questionnaires were analyzed with means and percentages. Their responses to the BWRS, SART, and SSQ were further analyzed with the Wilcoxon Signed Ranks Test (WSRT) to compare pilot ratings between aircraft type (UH-60A/L and UH-60M) and between seating position (left versus right). Because of the small sample size (N=4) of pilots who participated in EUD2, Fisher's Exact Test was used to compute the probability values.

### **2.4 Limitations of Assessment**

As with any simulation environment, numerous limitations are associated with the hardware and software driving the simulation. EUD2 in the BHIVE crew station was certainly no exception; the very nature of the prototyping crew station necessarily limits the functionality of certain components. These limitations will be discussed with this caveat: all participants were very appreciative and vocal in their support for the APEX BHIVE crew station and the capability it provides to design and evaluate crew station design before an aircraft is built.

This UH-60M crew station only had one set of functional flight controls (right seat). Therefore, all flying was done from the right seat. The APEX team installed a "force feedback" system in the right seat and flight controls, thus allowing a replication of the aircraft trim system in the cyclic and collective, as well as simulated vibrations in the seat. The seat shaker had a frequency of 25 Hz with a 0.05-mm amplitude.

All four MFDs were simulated with four touch screens controlled by PCs outside the BHIVE. The PFD and navigational display (ND) were almost fully functional, as was the EICAS page. However, most caution-advisory messages were not available for display, so only a few emergency procedures could be simulated. Bezel buttons were replicated on the touch screen displays. The digital mapping system was rudimentary in the amount of functionality available. Only one map scale was available (1:250,000 joint operations graphic). The participants had the ability to overlay their flight plan information on the digital map (waypoints, landing zones, route lines, and so forth), and several zoom magnifications were available. The JVMF system had two messages available: position report and free text. Data entry for "free text" was made from the FMS.

The FMS was replicated via a touch screen display run from a PC outside the BHIVE. Both FMSs ran from the same PC, so input by the left-seat pilot also showed on the right-side FMS. As many as 15 way points could be entered into a flight plan, and the course information could be overlaid on the ND or DigMap pages of the MFDs. Limited transponder functions were available, and limited radio navigation functions were available (very high frequency [VHF] omnidirectional range-instrument landing system [VOR-ILS]). One real FD/DCP box was installed for EUD2 with limited functionality: localizer and glide slope selection, plus altitude hold.

The interphone communications system had one channel available, so the switching of radio nets (frequency modulation [FM], ultra high frequency [UHF], VHF, high frequency) was simulated.

One MFSC was available to the left-seat pilot for use on his in-board MFD. The MFSC used a software driver for a common three-button computer mouse to replicate its movements and controls on that MFD screen. There was no capability to switch the cursor between MFDs.

## **2.5 Test Schedule and Description of Mission Scenarios**

The formal demonstration of the system occurred over a 3½-day span in May 2003. All participants reported to the APEX labs in the early afternoon of day 0 (Monday). The first author and the APEX manager delivered a series of briefings about the overall intent of the demonstration and the exact functions and limitations of the BHIVE crew station. The UH-60M Project Officer from DCD then delivered an in-depth operations order (OPORD) covering the entire week of flying missions (see appendix J). The participants were then able to fly the UH-60M simulator until they felt comfortable with all the systems.

Two sets of aircrew (four pilots) flew a series of three different scenarios lasting 30 to 60 minutes. The United States Army Aviation Center (USAAVNC) DCD UH-60 user representative from Fort Rucker developed these scenarios in accordance with current UH-60 tactics, techniques, and procedures (TTPs), mixed with projected TTPs and threat in the year 2015. The mission scenarios were (a) LRSD insertion, (b) air movement-CASEVAC, and (c) air assault. The four pilots received crew assignments and a mission briefing at the end of each day for the next day, which allowed them to plan and rehearse at their discretion in the evening or the next morning. See appendix K for the complete text of the air crew briefings for each mission vignette (LRSD insertion, air movement-CASEVAC, and air assault).

The crews flew one mission vignette per day over the course of three days. There was no compelling need to “battle roster” the air crews (i.e., retain the same crew pair for all missions). Each trial had a new crew mix with the crew members in a different seat than in the previous trial. Thus, each pilot flew three missions with a new copilot each time. When pilots were not acting as air crew members in a trial, they were free to plan and rehearse their next mission, but we asked them to remain clear of the APEX lab.

We provided a script of the mission to all involved personnel except the pilots. The scenario was implemented to the ModSAF scenario development tool. ModSAF provided the evaluation personnel with the capability to communicate scenario timelines, scripting, and exercise rehearsals.

Participants completed the pre-mission SSQ just before starting that day’s mission. Each mission concluded with the crews completing the remainder of the questionnaire battery (post-mission SSQ, PVI, SA, and BWRS) while still sitting in the crew station. After that, the primary author and the DCD Project Officer led a crew debriefing and AAR of the mission just flown. At the end of the all the trials, the UH-60M Project Manager ran an in-depth AAR and formally recognized the participants.

---

### 3. Results

---

#### 3.1 Crew Workload

##### 3.1.1 Mean Workload Ratings for ATM Tasks

The mean overall workload rating for all ATM tasks was 2.93 for the UH-60M. The mean overall workload rating for all ATM tasks was 2.62 if the same tasks had been performed in the UH-60A/L (see figure 9). The rating of 2.93 indicates that the pilots typically had “enough workload capacity for all desirable additional tasks” while performing crew duties from either seating position. The difference in workload ratings between the UH-60M and UH-60A/L was not statistically significant (WSRT,  $z = -0.171, p > 0.05$ ). The slightly higher overall score for the UH-60M was because one pilot repeatedly reported higher workload score across several ATM tasks than the other three subjects. This subject’s workload rankings skewed the overall mean for the UH-60M. Unfortunately, this subject sometimes did not give a written reason for the higher reported scores. The range of mean workload ratings for the UH-60A/L was 1.00 to 4.67. The range of mean workload ratings for the UH-60M was 1.00 to 4.00 (see appendix L for full table).

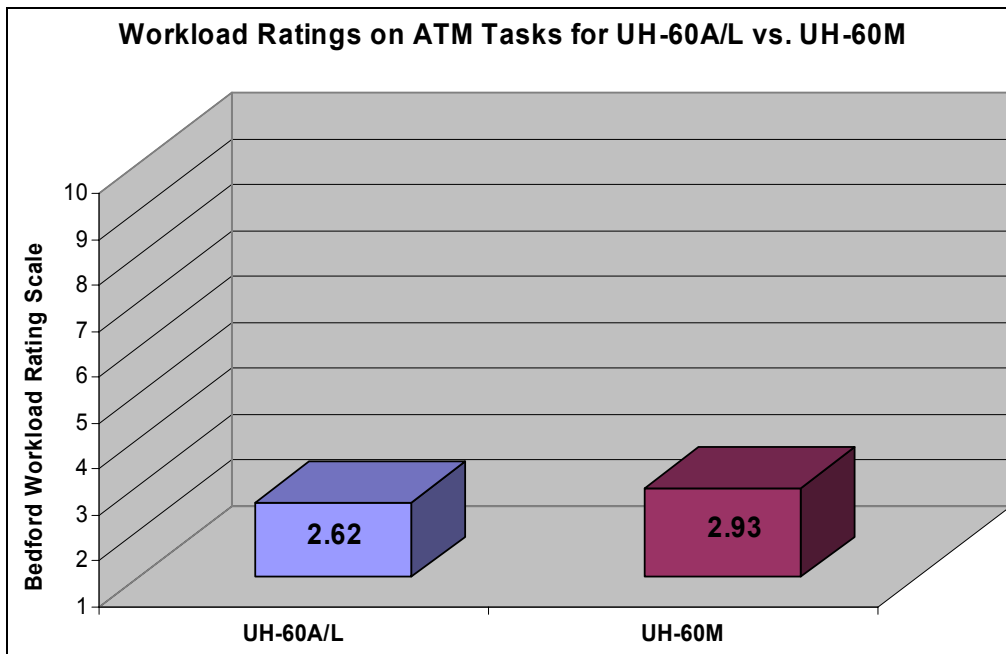

Figure 9. Workload ratings on ATM tasks for UH-60A/L versus UH-60M.

The mean overall workload rating (UH-60M only) for the left seat was 4.00, while the mean for the right seat was 2.49 (see figure 10). The range of mean workload ratings for the UH-60M left seat was 1.00 to 4.67. The range of mean workload ratings for the UH-60M right seat was 1.00 to 4.67 (see appendix L for full table). These results indicate that pilots felt they had “insufficient workload capacity for easy attention to additional tasks” when they performed crew

duties in the left seat. When flying the aircraft in the right seat, pilots in the right seat felt that “workload was low” or that they had “enough workload capacity for all desirable additional tasks”. The difference in overall workload between the two seating positions in the UH-60M failed to reach statistical significance (WSRT,  $z = -1.826$ ,  $p = 0.068$ ).

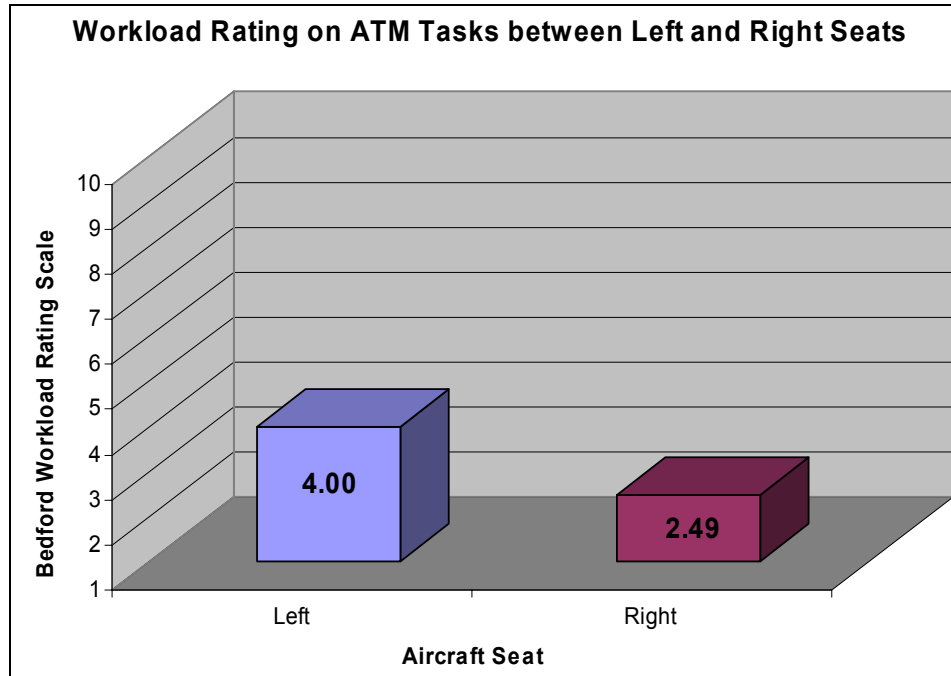

Figure 10. Workload ratings on ATM tasks between left and right seats (UH-60M only).

Several notes should be made regarding the (nonsignificant) difference between overall mean workload ratings between the left and right seats. First, the delineation of flight duties for this demonstration was rather artificial because the only set of working flight controls was from the right seat, and the only FD/DCP available was placed on the left side. This configuration of controls forced the right-seat pilot to do all the flying tasks, while the left-seat pilot performed all JVMF messages, FD/DCP usage, navigation, and aircraft monitoring tasks. This delineation of left and right seat flying duties does not reflect the operational aircraft where either pilot may be on the flight controls at any time (with the non-flying pilot performing other flight and mission tasks) and the assignment of duties can change at any time during the flight.

Second, by observing the mean workload scores between left and right seats for the UH-60M (appendix L), we see that the higher overall mean score for the left is greatly influenced by a small number of ATM tasks. These include tactical communications and reporting (2090 and 2091) and the navigational tasks (1025 and 1026).

Third, the workload score for the left seat was greatly influenced by one subject who repeatedly reported much higher workload scores from the left seat than the other subjects. Again, this difference was not statistically significant.

Therefore, there is no reason to conclude that the left seat pilot will have a higher workload in the production aircraft. Instead, the demonstration illustrates that certain ATM tasks (e.g., tactical communications and reporting, among others) are probably leading to a higher perceived workload. These tasks can be performed from either crew position. Either the pilot in command (PC) or the co-pilot (CP), depending on how the PC delineates seating and flight duties during the crew briefing, could do the tasks. Some PCs might choose to be at the controls from the left seat, while other PCs may wish to sit in the right seat and let the CP be on the controls from the left seat. Either way is perfectly normal and acceptable for this aircraft. Additionally, the pilot on the controls may transfer the flight controls to the other pilots in the middle of a mission. Future simulations and tests of the UH-60M crew station will not have the restrictions on seating and flight duties.

In general, subjects became comfortable when performing most ATM tasks from the UH-60M crew station. Post-mission discussions and comments on the workload and PVI questionnaires indicated that three of the four subjects felt increasingly comfortable with integration between the PFD, ND, and the DigMap (the exception was the pilot already mentioned who repeatedly reported higher workload scores). In contrast, all pilots continued to report higher workload scores for tasks involving JVMF messages. ARL and SAC personnel observed that the left-seat pilot was often solely focused on sending a JVMF message, and only through practice and experience did some of the pilots develop techniques to complete the task without becoming overloaded.

The higher workload for these ATM tasks that are being introduced by the UH-60M crew station requires actions on two fronts. One is greater attention in crew station design to reduce future workload incurred by the JVMF pages and the FD/DCP. The other is that a greater training emphasis will be required on new components during pilot qualifications, particularly the JVMF screens and FD/DCP.

Workload scores exhibited somewhat of a downward trend over the course of the demonstration, indicating a probable learning effect. As the pilots learned the systems and grew more comfortable with crew station, workload ratings on several (but not all) ATM tasks dropped over the three-day demonstration.

### **3.1.2 TSC Ratings for Workload and Crew Coordination**

The TSC provided an overall mean workload rating of 3.71 for pilots sitting in either crew position—a higher rating than the pilots gave themselves. An overall mean rating of 3.71 indicates that the TSC perceived that the pilots typically had “insufficient spare workload capacity for easy attention to additional flight and mission tasks”.

However, the TSC assessed higher workload scores for the left seat (4.50) than the right seat (2.92). This difference was statistically significant (WSRT,  $z = -2.207$ ,  $p < 0.05$ ). Post-mission discussion and comments on the TSC questionnaires indicated a concern that the left-seat pilot was forced to spend too much time and attention on digital messages and overall system

management. In particular, the TSC members were concerned that the JVMF page design and current digital message techniques may have forced the left-seat pilot to focus on those tasks during critical portions of the mission (e.g., approach and landing at the landing zone [LZ]).

The TSC also rated crew coordination on the scale in figure 11, with a mean assessment of 2.33. Scores ranged the entire scale from one to five. The TSC felt that there was a demonstrable improvement in crew coordination over the course of the demonstration, as they reported either “excellent” or “good” crew coordination on the last days of trials. However, comments from the questionnaires show that the TSC felt the CP’s coordination suffered several times whenever he was performing digital message tasks.

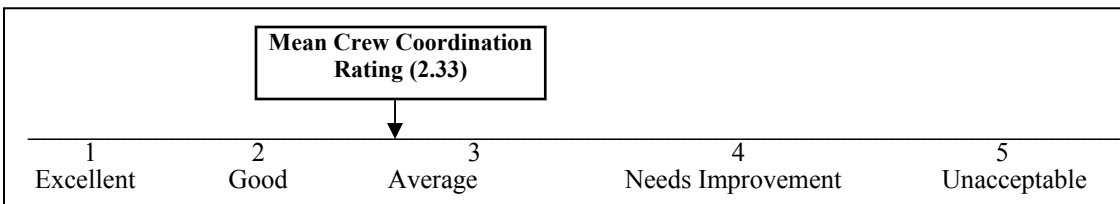

Figure 11. Overall TSC crew coordination ratings.

## 3.2 Crew SA

### 3.2.1 SA Ratings by the Subjects

The overall SART score provided by the pilots was 21.92 for the UH-60M. This score indicates that the pilots felt they had moderate levels of overall SA during the mission. The overall SART score, if the same mission had been performed in the UH-60A/L, was 21.83 (see figure 12). The difference between the overall SART score for the UH-60M versus UH-60A/L was not statistically significant (WSRT,  $z = -0.089$ ,  $p > 0.05$ ). The range of SART scores for the UH-60M was 6 to 33. The range of overall scores had the mission been performed in the UH-60A/L was 15 to 32 (see appendix M).

The mean overall SART score (UH-60M only) for the left seat was 23.67, while the mean overall score for the right seat was 20.17 (see figure 13). The SART score difference between the seating positions was not statistically significant (WSRT,  $z = -0.524$ ,  $p > 0.05$ ). The range of SART scores for the left seat was 17 to 32, while the range for the right seat was 6 to 33. In general, pilots reported moderate levels of SA from either seating position. Like the workload measure, the variability in SA data again stems from the one subject (see appendix M for full table).

The subscale ratings in figures 14 and 15 and tables 2 and 3, which divide the overall SART scores into their subscales, indicate that the pilots typically experienced

- moderate levels of “demand” for both the UH-60M and UH-60A/L,
- higher levels of “supply” in the UH-60M versus the UH-60A/L,
- moderate levels of “understanding” for both aircraft with slightly higher scores for the UH-60A/L,

- higher levels of demand, supply, and understanding for the left seat over the right seat in the UH-60M.

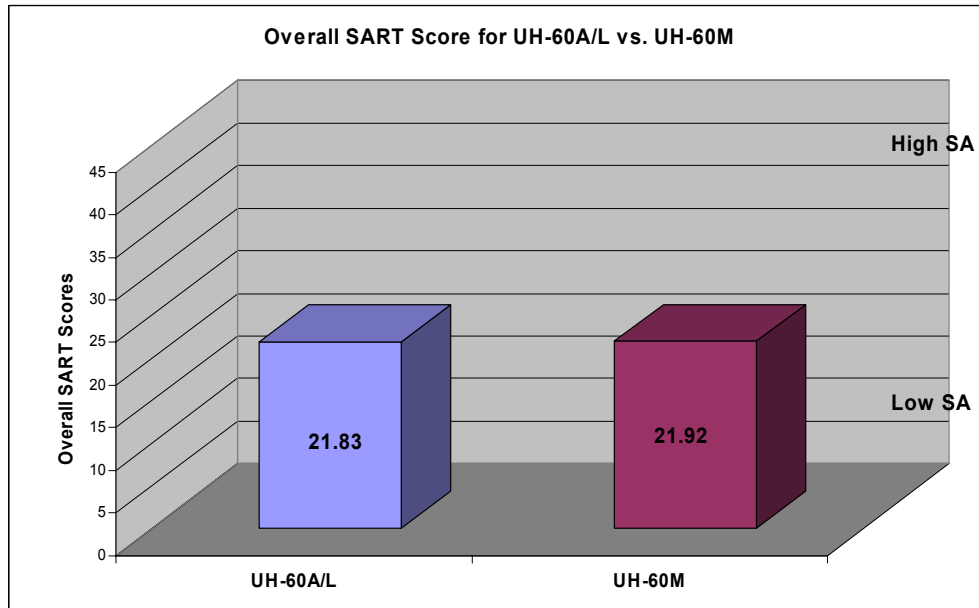

Figure 12. Overall SART scores for UH-60A/L versus UH-60M.

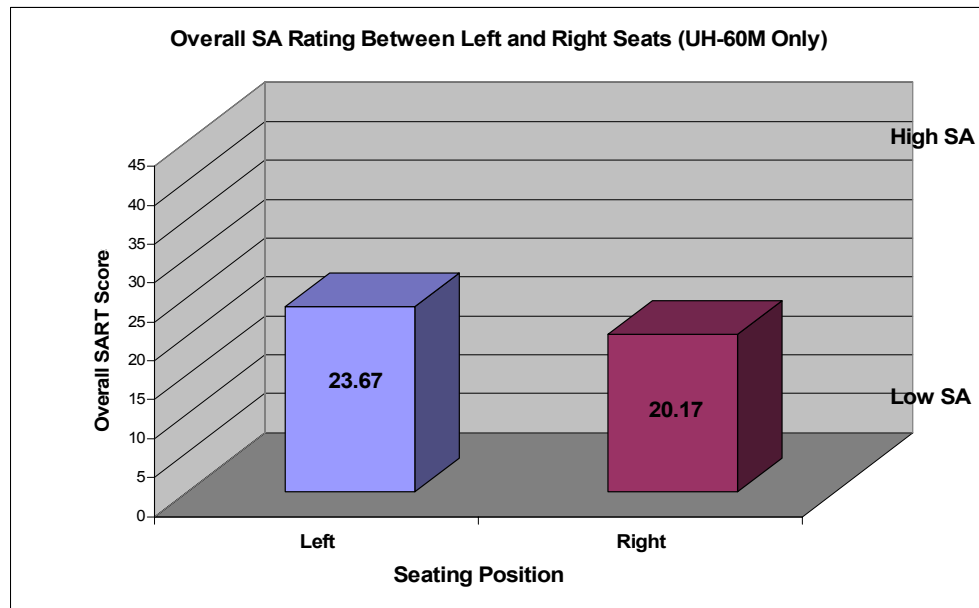

Figure 13. Overall SART scores between left and right seats (UH-60M only).

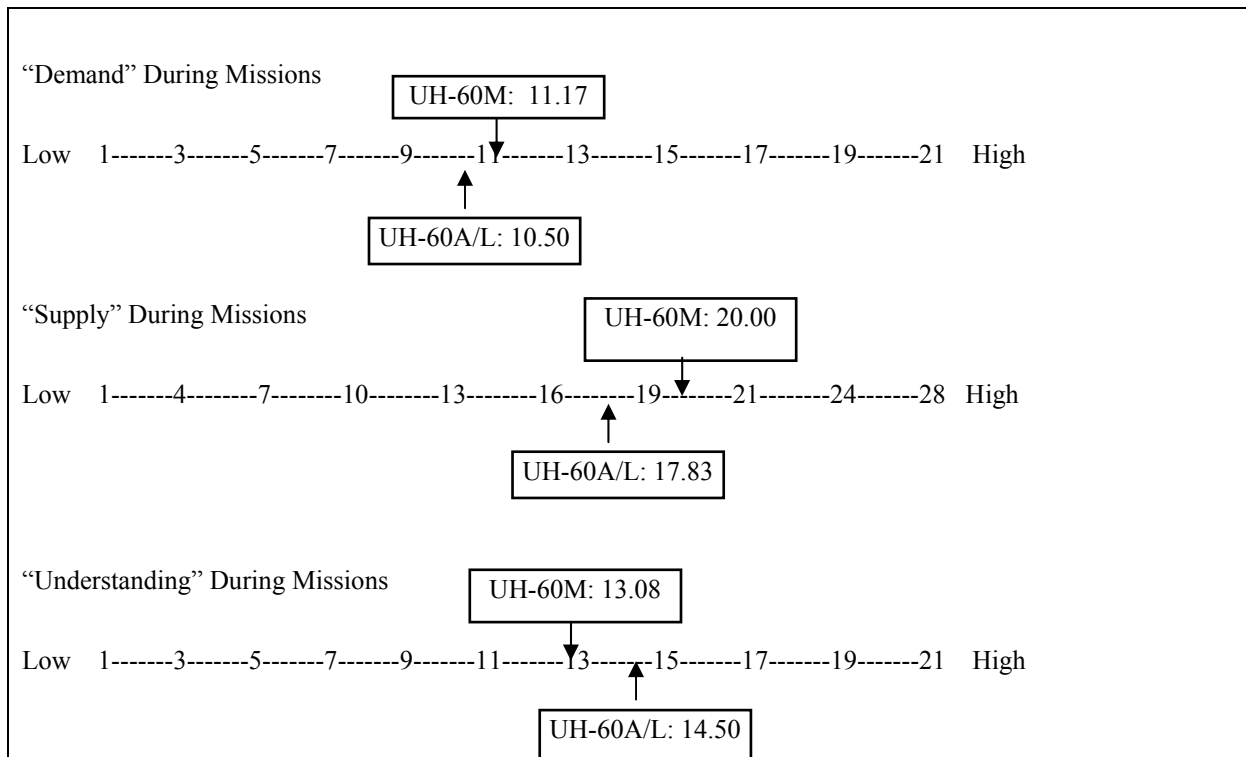

Figure 14. Overall SART subscale ratings between UH-60M and UH-60A/L.

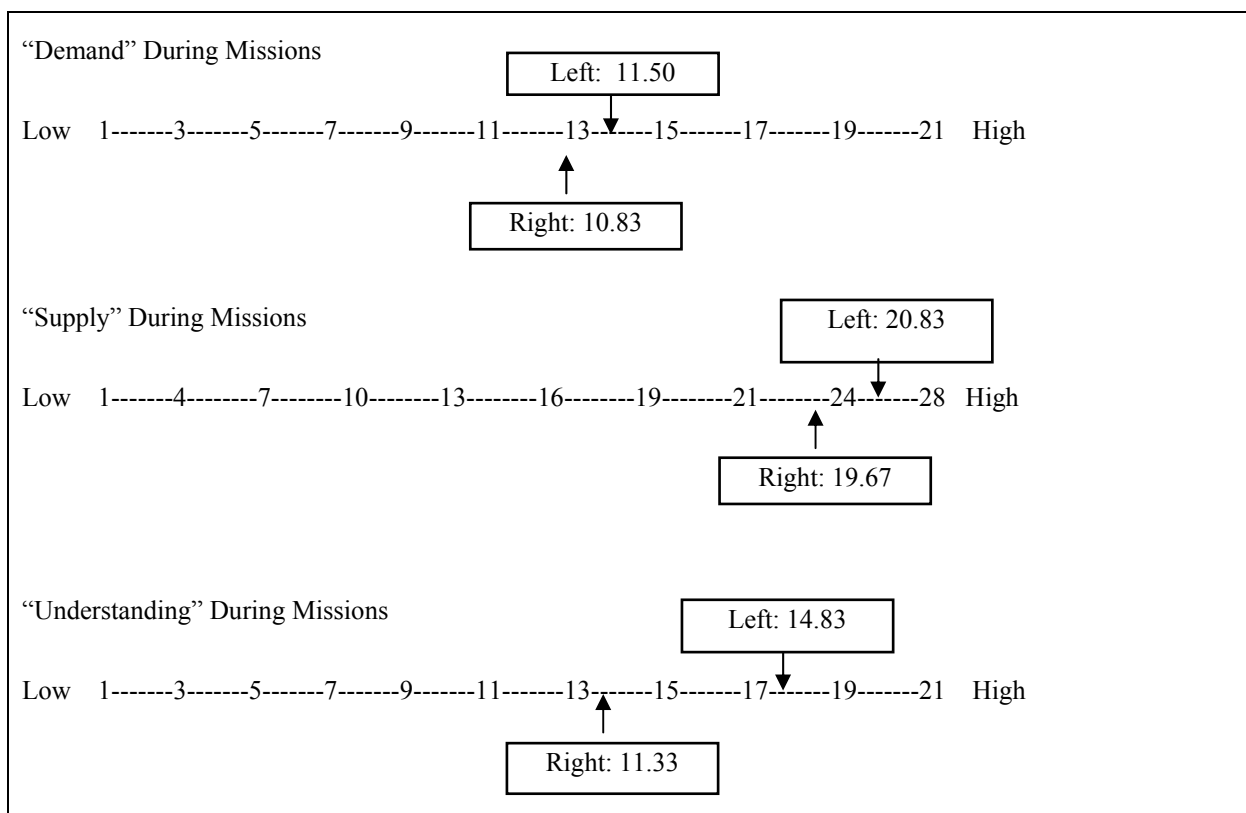

Figure 15. Overall SART subscale ratings between left and right seats (UH-60M only).

Table 2. SART subscale ratings between UH-60A/L and UH-60M.

<b>SART Subscales</b>	<b>UH-60A/L</b>	<b>UH-60M</b>
Demand	10.50	11.17
Instability of Situation	3.75	3.58
Variability of Situation	3.17	3.75
Complexity of Situation	3.58	3.83
Supply	17.83	20.00
Arousal	4.58	5.50
Spare Mental Capacity	4.50	4.58
Concentration	4.83	5.25
Division of Attention	3.92	4.67
Understanding	14.50	13.08
Information Quantity	4.33	4.75
Information Quality	4.83	4.42
Familiarity	5.33	3.92
Mean SART Scores	21.83	21.92
SD	5.61	8.53

SD = standard deviation

Table 3. SART subscale ratings between left and right seats (UH-60M only).

<b>SART Subscales</b>	<b>Left Seat</b>	<b>Right Seat</b>
Demand	11.50	10.83
Instability of Situation	3.33	3.83
Variability of Situation	4.00	3.50
Complexity of Situation	4.17	3.50
Supply	20.33	19.67
Arousal	5.67	5.33
Spare Mental Capacity	4.67	4.50
Concentration	5.33	5.17
Division of Attention	4.67	4.67
Understanding	14.83	11.33
Information Quantity	5.83	3.67
Information Quality	4.83	4.00
Familiarity	4.17	3.67
Mean SART Scores	23.67	20.17
SD	5.85	10.89

### 3.2.2 SA of Battlefield Elements

Pilots reported “intermediate” and “fairly high” levels of SA for a variety of battlefield elements available during the simulations (see table 4). The following scale (1-5) was used:

- 1 = Very high level of SA
- 2 = Fairly high level of SA
- 3 = Intermediate level of SA
- 4 = Fairly low level of SA
- 5 = Very low level of SA

Table 4. Ratings for SA of battlefield elements.

Battlefield Element	Mean	SD
Location of Own Aircraft During Mission	1.73	1.10
Location of Other Aircraft During Mission	3.25	1.39
Location of Cultural Features	2.91	1.38
Route Information	2.33	1.30
Status of Ownship Systems	2.92	1.44

### 3.2.3 TSC SA Ratings

The TSC provided an independent overall SA rating based on the scale in table 5 with a mean rating of 2.58 (of 5). This indicates that they perceived that the crews typically had moderate levels of SA and adequate awareness of the battlefield. All comments on SA from the TSC are recorded in appendix N.

Table 5. Ratings of crew SA.

TSC SA Ratings	
1	Crew was consistently aware of all entities on the battlefield.
2	Crew was aware of the battlefield with minor or insignificant variation between perception and reality.
3	Crew was aware of the battlefield. Variation between reality and perception did not significantly impact mission success.
4	SA needs improvement. Lack of SA had some negative effect on the success of the mission.
5	Lack of SA caused mission failure.

Mean Rating  
2.58  
(SD = 1.24)

## 3.3 Pilot-Vehicle Interface (PVI)

### 3.3.1 MFD Symbology

Pilots were generally comfortable with all symbology used on the MFD pages available for this demonstration. They reported very few difficulties with the PFD, ND, and EICAS pages. There were several recommendations for changes in the digital mapping system. On the DigMap, crews recommended a change in the Ownship symbol since it was too large for the map. During the AAR, the following change was recommended:

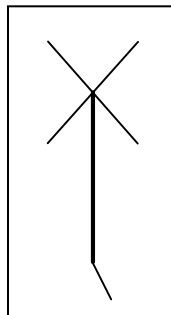

The “X” represents the rotor system of the aircraft, and the point where the “X” crosses should be the present position of the aircraft on the digital map. A standard airplane symbol was discussed, but AAR participants generally preferred a “stick” helicopter rather than the standard airplane symbol.

Several pilots commented on the use of various color schemes on the DigMap. One noted that a black course line was easily confused for a set of high tension power lines. Another noted that certain shades of green (used for way point symbols) could be difficult to read against the map background.

The final symbology comments to be addressed are the use of shapes to depict different types of way points (air control point [ACP], starting point [SP], release point [RP], pickup zone [PZ], LZ). Crews asked for the ability to select the proper shape symbols as per standard TTP (i.e., circle for ACP, square for SP and RP, triangle for PZ and LZ). While the simulation allowed our software engineers to do this in the background, this functionality was not available in the simulated FMS, and it was not known if the function would be available in Army's Aviation Mission Planning System and the production FMS and digital map.

### **3.3.2 JVMF Messages**

Overall, pilots reported multiple concerns with the JVMF message system as it exists now. They reported that, although they generally became more familiar and proficient with it over the course of the demonstration, the JVMF system is not intuitive and was cumbersome to use (see appendix O for PVI comments and appendix C for the PVI questionnaire). The data indicate that sending a position report via digital message was "borderline" in difficulty. In addition, pilots reported that sending a free text message was "somewhat difficult". See appendix O for pilot comments on the JVMF and other PVI issues.

The pilots reported that JVMF message is a "heads down" and time-consuming task. Comments from the TSC show that the attention of left-seat pilots (conducting the message) was often "trapped" in the crew station during critical phases of the mission (e.g., approach to and landing in the LZ). Post-mission discussions revealed that although they see the need for digital messages and like capability, our current method of implementing the JVMF message task needs further design and evaluation work.

Observers inside the BHIVE during the trials noted that the left-seat pilot physically leaned forward and slightly "crouched" his body when he used the JVMF pages—a possible sign of the mental workload and attentional resources he was using. In post-mission discussions, observers and pilots commented that using the MFSC to select from the JVMF menus will probably speed entry, allow them to maintain a more natural posture, and maintain a better "heads out" focus. However, none of the pilots used the MFSC to conduct a JVMF message during missions.

Also related to the JVMF discussion is the method of announcing that a new message has arrived. Several pilots commented that the use of inverse video was not enough to alert them to a new message. Others asked for the ability to discern a new message versus a simple acknowledgment message without having to go into the JVMF in-box. This desire might possibly be met through the use of color coding: yellow inverse video for new message, green inverse video (or another color) for simple acknowledgment.

### 3.3.3 Other PVI Comments

With the exception of the JVMF pages, pilots reported that they were able to “somewhat quickly” navigate through menu selections on the PFD, ND, DigMap, and FMS screens.

The FD/DCP was a new piece of equipment for the pilots, and although they reported being slow with it, all felt that their difficulties were a matter of training and not design.

Cursor control on the MFSC was very intuitive and no pilot reported directional problems. However, further design and evaluation efforts need to be conducted to determine the optimal functionality of the three switches available on the MFSC.

The only problem reported with the flight controls was one case of finger discomfort on the collective trim switch. The cyclic and collective controls in this simulation were not production representative; thus, it is difficult to draw further conclusions. A more in-depth analysis of the new cyclic and collective will be needed during EUD3 and the LUT in the UH-60M systems integration lab (SIL).

There were no reports of problems with symbology clutter on the PFD, ND, or digital map pages. However, enemy and friendly position icons were not available for this demonstration and will likely cause problems with clutter.

### 3.4 Simulator Sickness

Pilots reported very few simulator sickness symptoms during the mission trials. Most of the symptoms involved slight sweating or slight eyestrain from the wearing of the eye tracker device. In effect, the BHIVE posed no problems for simulator sickness and should continue to be very suitable as a simulation environment in the future.

The overall mean total severity score (post mission) for the pilots was 8.10 (see table 6), with a median of 5.61. The range of mean total severity scores for all the pilots was 0 to 29.92. The difference in overall discomfort levels between seating positions (left versus right) was not statistically significant (WSRT,  $\underline{z} = 0.02$ ,  $p = 1.00$ ).

Table 6. Simulator sickness questionnaire (SSQ) ratings.

Condition	Nausea Subscale	Oculomotor Subscale	Disorientation Subscale	Total Severity Score (Mean)	SD
Pre-Mission	6.36	3.16	0	3.74	5.97
Post Mission	13.88	6.89	0	8.10	8.56
- Right Seat (Flying)	12.72	8.84	0	8.73	11.75
- Left Seat (Non-Flying)	14.31	3.79	0	7.48	4.73

#### 3.4.1 Comparison of BHIVE SSQ Scores to Other Helicopter Simulators

To assess whether the SSQ ratings provided by the pilots during EUD2 were similar to or different from ratings obtained in other helicopter simulators, the mean total severity scores for

the BHIVE were compared to the mean total severity scores for several other helicopter simulators (see table 7). The other helicopter simulators were the AH-64A, S-3H, CH-46E, CH-56D, CH-56F, Sikorsky RAH-66 engineering development simulator (EDS), and RAH-66 Comanche portable cockpit (CPC). These simulators typically induced low to moderate levels of simulator sickness symptoms in pilots.

Table 7. Comparison of BHIVE SSQ ratings with other helicopter simulators.

Simulator	Nausea Subscale	Oculomotor Subscale	Disorientation Subscale	Total Severity Score (Mean)
AH-64A*	-----	-----	-----	25.81
SH-3H	14.70	20.00	12.40	18.80
RAH-66 EDS	11.84	14.98	4.54	13.25
CH-53F	7.50	10.50	7.40	10.00
RAH-66 CPC	3.29	12.94	7.89	9.80
<b>UH-60M BHIVE</b>	13.88	6.89	0	8.50
CH-53D	7.20	7.20	4.00	7.50
CH-46E	5.40	7.80	4.50	7.00

\*SSQ subscale data not available.

Kennedy, Lane, Berbaum, and Lilienthal (1993) reported the SSQ scores for the S-3 H, CH-46E, CH-56 D, and CH-56F helicopter simulators. Johnson (1997) reported the SSQ scores for the AH-64A simulator. Durbin, Havir, Kennedy, and Pomranky (2003) reported the SSQ scores for the RAH-66 EDS. Durbin, Havir, Kennedy, and Schiller (2003) reported the SSQ scores for the RAH-66 CPC. The S-3H, CH-46E, CH-56D, and CH-56F helicopter simulators were motion-based (6-DOF) simulators with cathode ray tube displays that presented the OTW scene to pilots. The EDS was a motion-based (6-DOF) simulator with the OTW scene presented to the pilots on the Kaiser ProView 50<sup>4</sup> helmet-mounted display (HMD) (28 degrees [V] x 49 degrees [H] FOV). The AH-64A simulator used hydraulically actuated pneumatic seats to simulate motion. The OTW scene was presented to the AH-64A pilots on a 40-degree horizontal by 30-degree vertical HMD.

### 3.5 Eye Tracker

During this demonstration, a VisionTrak eye and head tracker from Polhemus was used during several of the trials to measure visual gaze and help assess mental workload. We were able to collect data from three of the six trials, but there were several technical limitations of the system.

First, only one eye- and head-tracking device was available, so it was worn by the flying pilot in the right seat. This limitation will likely be remedied for the UH-60M LUT in the SIL when two eye-tracking devices will be available. Second, the eye-tracking device was mounted into an HGU<sup>5</sup>-56/P flight helmet, and although that helmet was extra large, it did not fit any of the pilots. In addition, the physical mount of the device on the helmet proved incompatible with several of the subjects' cranial shape.

<sup>4</sup>ProView<sup>50</sup> is a trademark of Kaiser.

<sup>5</sup>Not an acronym

Ultimately, we reverted to another eye-tracking device (run by the same computer) that was mounted in a simple headband that the pilot wears in flight. The difficulties with the helmet-mounted eye tracker must be remedied for the LUT in the SIL because the use of the headband-mounted eye tracker is not acceptable for that operational test. The third technical limitation was the available FOV with the system (see figure 16). The ability of the eye-tracking system to map a person's visual gaze depends on the FOV of an independent camera mounted up and behind the crew station. In our case, the camera could not be mounted far enough back to take in the entire OTW visual scene and only a portion of the interior crew station. With this limitation, we decided to gather visual gaze data from three of the four MFDs nearest the right seat pilot, as well as a roughly 60 degree by 40 degree OTW view.



Figure 16. FOV with the eye tracker camera.

In general, the flying pilot did not suffer from excessive visual workload or cognitive capture from the MFDs. Figure 17 depicts the visual fixations within the FOV of the eye tracker camera. Fixations for each named element are displayed as a percentage of the total mission time. For instance, 71.74% of the time spent in visual fixation was OTW, while 9.28% was spent fixating on the right-side outboard MFD. Also note that approximately 8% of visual activity was spent in visual search without fixation. Table 8 further outlines the results of the eye tracker.

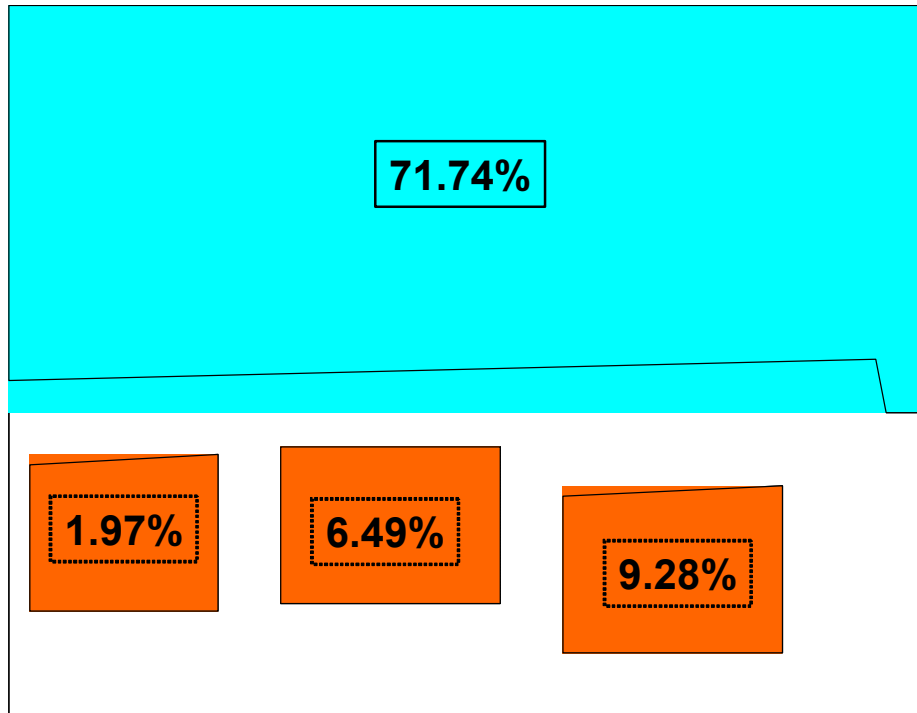

Figure 17. Composite of visual gaze data. (Note that an additional 2.54% of fixations occurred outside the named viewing elements, while the remaining 7.98% of mission duration was without visual fixation [i.e., visual search].)

Table 8. Composite results of eye tracker.

Viewing Element	Number of Fixations	Percent of Total Fixations	Total Fixation Duration (sec)	Percent of Mission Duration
OTW	9077	69.21	4937.92	71.74
MFD1	2177	16.60	638.68	9.28
MFD2	1001	7.63	446.36	6.49
MFD3	318	2.42	135.62	1.97
Other Area	543	4.14	174.73	2.54
<b>Total</b>	<b>13116</b>	<b>100</b>	<b>6333.31</b>	<b>92.02</b>
		<b>No Fixations</b>	<b>549.24</b>	<b>7.98</b>

## 4. Summary

### 4.1 Summary of Crew Workload

UH-60M mean workload scores were comparable to the UH-60A/L.

Several tasks new to the UH-60M crew station induced higher workload, particularly the JVMF message. Action is required to reduce the workload required for these tasks.

The TSC perceived that the pilots experienced moderate levels of overall workload, with statistically nonsignificantly higher scores for the left seat versus the right (mostly because of JVMF message and overall system management).

Workload scores displayed a learning curve, generally improving over the course of the three-day demonstration.

#### **4.2 Summary of Crew SA**

Pilots reported slightly higher SA for the UH-60M than if they had flown the same missions in the UH-60A/L.

Pilots reported slightly higher SA from the left seat versus the right. While performing tasks in the left seat, the pilots had better awareness of ownship systems and location than when performing tasks in the right seat.

Significant gains in SA were provided by the digital map systems. However, gains were offset by JVMF message tasks.

SA was not fully tested during EUD2. The addition of threat, friendly, and other icons on the digital map will be required for us to truly understand overall battlefield SA with this aircraft.

#### **4.3 Pilot-Vehicle Interface**

Pilots were generally comfortable with all symbology used on the MFD pages available for this demonstration. They reported very few difficulties with the PFD, ND, and EICAS pages. There were several recommendations for changes in the digital mapping system, including the ownship symbol.

Crews asked for the ability to select the proper shape symbols for the different types of way points as per standard TTP (i.e., circle for ACP, square for SP-RP, triangle for PZ-LZ).

Overall, pilots reported many concerns with the JVMF message system as it exists now. They reported that although they generally became more familiar and proficient with it over the course of the demonstration, it was not intuitive and was cumbersome to use.

As a group, from questionnaire comments and post-mission discussions, the pilots reported that JVMF message is currently a “heads down” and time-consuming event. Comments from the TSC show that the attention of left-seat pilots (performing the message tasks) was often “trapped” in the crew station during critical phases of the mission (e.g., approach to and landing in the LZ).

With the exception of the JVMF pages, pilots reported that they were able to “somewhat quickly” navigate through menu selections on the PFD, ND, DigMap, and FMS screens.

The FD/DCP was a new piece of equipment for the subjects, and although they reported being slow with it, all felt that their difficulties were a matter of training and not design.

Cursor control on the MFSC was very intuitive and no pilot reported directional problems. However, design and evaluation work is needed to determine the exact functionality of the three switches available.

#### **4.4 Simulator Sickness**

Simulator sickness was not a problem during EUD2. The BHIVE-simulated crew station environment induced very few reports of simulator sickness symptoms over the course of six trials.

BHIVE did not induce simulator sickness and should be very suitable as a simulation environment in the future.

#### **4.5 Eye/Head Tracker**

In general, the flying pilot did not suffer from excessive visual workload or cognitive capture from the MFDs.

Approximately 71.74% of the time spent in visual fixation was OTW; 20.28% was spent fixating inside the crew station. Approximately 8% of visual activity was spent in visual search without fixation.

---

### **5. Recommendations**

---

The following recommendations are made to enhance the overall effectiveness and suitability of the UH-60M as it continues its development:

- Address and resolve the workload and PVI issues concerning the digital map and JVMF systems.
- Integrate friendly and threat symbols into the UH-60M BHIVE simulation to fully test and evaluate SA provided by the crew station.
- Continue to assess the crew station during future simulations and tests to evaluate pilot and system performance and assess new functionality that is integrated into the UH-60M design. Data from the workload, SA, and SSQs, plus the data from the eye tracker, should be collected again during future UH-60M crew station evaluations, including EUD3 and the LUT. This procedural continuity will allow direct comparison after further design and development of the UH-60M crew station to check for continued improvements in workload, SA, and PVI.

---

## 7. References

---

- Crowley, J. S. Simulator sickness: A problem for army aviation. *Aviation Space and Environmental Medicine* **1987**, 58, 355-357.
- Donelson, S. M.; Gordon, C. C. *Anthropometric Survey of U.S. Army Personnel: Pilot Summary Statistics, 1988*; Technical Report Natick/TR-91/040; Natick, MA: U.S. Army Natick Research, Development, and Engineering Center. (ADA241952). Retrieved 30 June 2003 from <http://handle.dtic.mil/100.2/ADA241952> 1991.
- Durbin, D. B.; Havir, T. J.; Kennedy, J. S.; Pomranky, R. A. *Assessment of the RAH-66 Comanche pilot-crew station interface for the force development and test exercise I*; ARL-TR-3027; U.S. Army Research Laboratory, Human Research and Engineering Directorate: Aberdeen Proving Ground, MD. Retrieved 14 January 2004 from <http://www.arl.army.mil/arlreports/2003/ARL-TR-3027.pdf>, 2003.
- Durbin, D. B.; Havir, T. J.; Kennedy, J. S.; Schiller, E. W. *Assessment of crew workload for the manned and unmanned (MUM) IV concept experimentation program (CEP)*; ARL-TR-3097; U.S. Army Research Laboratory, Human Research and Engineering Directorate: Aberdeen Proving Ground, MD, 2003.
- Endsley, M. R. Design and evaluation for situation awareness enhancement. *Proceedings of the Human Factors Society 32<sup>nd</sup> Annual Meeting*, Vol. 1, 92-101, 1988.
- Endsley, M. R. *Situation awareness analysis and measurement*. Mahwah, NJ: Lawrence Erlbaum Associates, 2000.
- Johnson, D. M. *Learning in a synthetic environment: The effect of visual display, presence, and simulator sickness*; U.S. Army Research Institute for the Behavioral and Social Sciences: Alexandria, VA (ADA328285). Retrieved 30 August 2003 from <http://handle.dtic.mil/100.2/ADA328285>, 1997.
- Kennedy, R. S.; Lane, N. E.; Berbaum, K. S.; Lilienthal, M. G. Simulator sickness questionnaire: An enhanced method for quantifying simulator sickness. *International Journal of Aviation Psychology* **1993**, 3, 203-220.
- Kennedy, R. S.; Lilienthal, M. G.; Berbaum, B. A.; Balzley, B. A.; McCauley, M. E. Simulator sickness in U.S. navy flight simulators. *Aviation Space and Environmental Medicine* **1989**, 60, 10-16.

- Nikonchuk, W. *UH-60 early user demonstration #1 study report for Blackhawk utility helicopter recapitalization/upgrade program*; Systems Simulation & Development Directorate, Aviation & Missile Research, Development, & Engineering Center: Redstone Arsenal, AL, 2001.
- O'Brien, T. G.; Charlton, S. G. *Handbook of human factors testing and evaluation*. Mahwah, NJ: Lawrence Erlbaum Associates, 1996.
- Robinson, K. W.; Hamilton, H. S. UH-60M Blackhawk update. *Army Aviation* **2003 May**, 52 (5), 26-28, 39.
- Roscoe, A. H. *The airline pilots view of flight deck workload: A preliminary study using a questionnaire*; Technical Memorandum No. FS (B) 465. Bedford, UK: Royal Aircraft Establishment. ADA116314, 1982.
- Roscoe, A. H.; Ellis, G. A. A Subjective Rating Scale For Assessing Pilot Workload In Flight: A Decade Of Practical Use. Royal Aerospace Establishment, Bedford, UK, 1990.
- Taylor, R. M. Situational awareness rating technique (SART): The development of a tool for aircrew systems design. *Proceedings of the NATO Advisory Group on Aerospace Research and Development (AGARD) Symposium on Situational Awareness in Aerospace Operations*. AGARD-CP-478, 3/1 - 3/17). Neuilly Sur Seine, France: NATO – AGARD, 1989.

## Appendix A. Bedford Workload Rating Scale (BWRS) Questionnaire

1. PIN \_\_\_\_\_ 2. Date (DD/MMM/YY): \_\_\_\_ / \_\_\_\_ / **03**
3. Mission ID number \_\_\_\_\_
4. Right Seat \_\_\_\_\_ Left Seat \_\_\_\_\_ (Check one)

### Workload

5. Rate the workload for the flight and mission tasks you performed *in comparison to your experiences in the UH-60A/L*. Use the scale provided on the last page of this questionnaire. For example, if on task 1026 (Perform Electronically Aided Navigation) you normally feel your workload would be a '5,' indicate that in the column under UH-60A/L. With that in mind, make a workload judgment for task 1026 in the UH-60M. Place the workload rating in the blank next to each flight and mission task. If you did not perform a task during the mission that you just completed, place an X in the non-applicable (N/A) column.

Task No.	Flight and Mission Tasks	UH-60A/L Workload	UH-60M Workload	N/A
1014	Maintain Airspace Surveillance			
1016	Perform Hover Power Check			
1017	Perform Hovering Flight			
1018	Perform VMC Takeoff			
1023	Perform Fuel Management Procedures			
1025	Navigate by Pilotage and Dead Reckoning			
1026	Perform Electronically Aided Navigation			
1028	Perform VMC Approach			
1029	Perform a Roll-on Landing			
1068	Perform Emergency Procedures			
1076	Perform Radio Navigation			
1077	Perform Holding Procedures			
1079	Perform Radio Communication Procedures			
1081	Perform Nonprecision Approach			
1082	Perform Precision Approach			
1083	Perform Inadvertent IMC Procedures			
1084	Perform Command Instrument System Operations			
1095	Operate Aircraft Survivability Equipment			
1135	Perform Instrument Maneuvers			
1136	Perform Go-Around			
1146	Perform VMC Flight Maneuvers			
1150	Select Landing Zone/Pickup Zone			
2008	Perform Evasive Maneuvers			
2009	Perform Multi-Aircraft Operations			
2044	Perform Actions on Contact			
2078	Perform Terrain Flight Mission Planning			
2079	Perform Terrain Flight Navigation			
2081	Perform Terrain Flight			
2083	Negotiate Wire Obstacles			
2086	Perform Masking and Unmasking			
2090	Perform Tactical Communication Procedures			
2091	Transmit Tactical Reports			



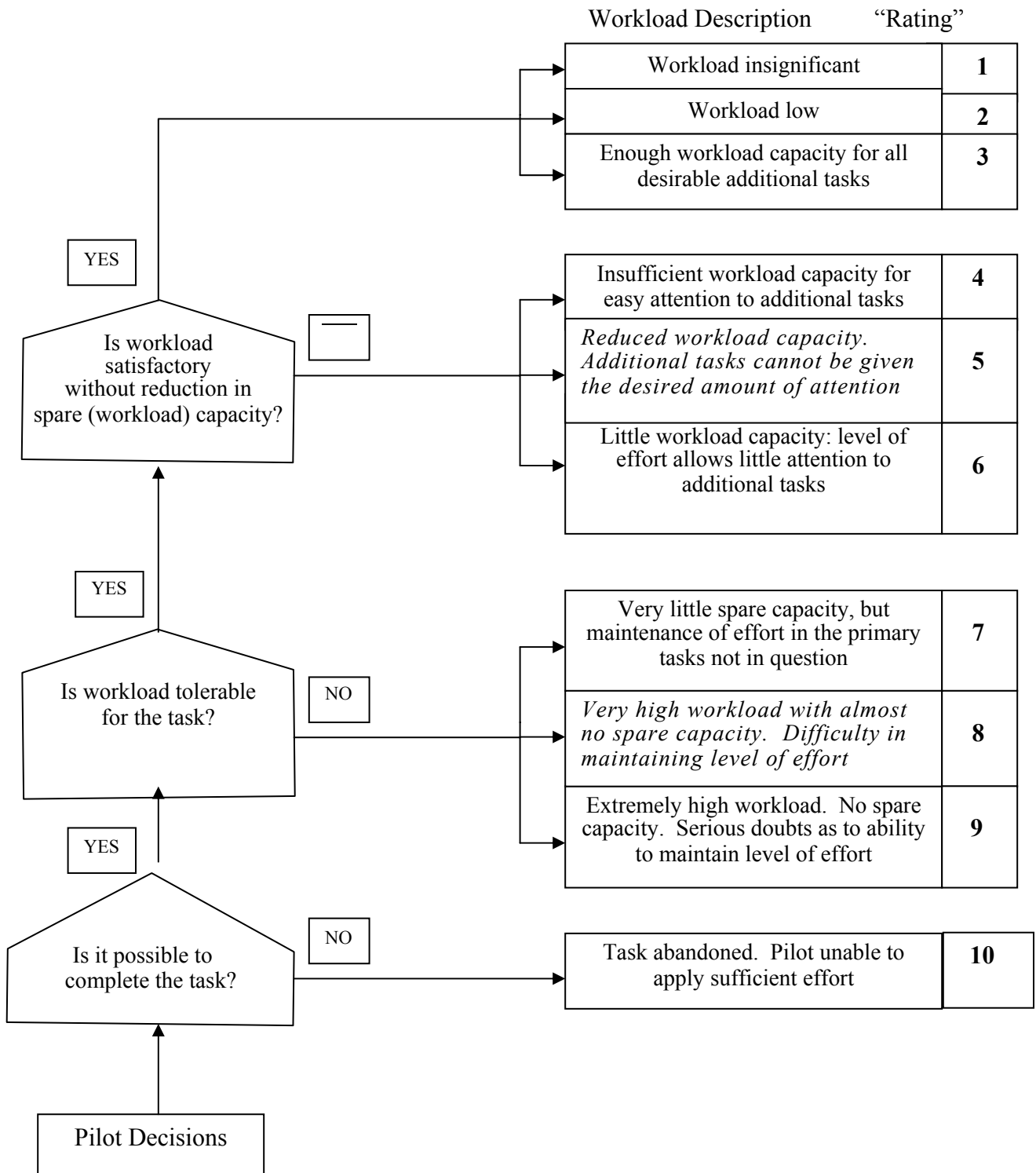

INTENTIONALLY LEFT BLANK

---

## Appendix B. UH-60 Black Hawk Air Crew Training Manual (ATM) Tasks

---

<b>Task No.</b>	<b>Flight and Mission Tasks</b>
1014	Maintain Airspace Surveillance
1017	Perform Hovering Flight
1018	Perform VMC Takeoff
1023	Perform Fuel Management Procedures
1025	Navigate by Pilotage and Dead Reckoning
1026	Perform Electronically Aided Navigation
1028	Perform VMC Approach
1029	Perform a Roll-on Landing
1068	Perform Emergency Procedures
1076	Perform Radio Navigation
1077	Perform Holding Procedures
1079	Perform Radio Communication Procedures
1080	Perform Procedures for Two-Way Radio Failure
1081	Perform Nonprecision Approach
1082	Perform Precision Approach
1083	Perform Inadvertent IMC Procedures
1084	Perform Command Instrument System Operations
1135	Perform Instrument Maneuvers
1146	Perform VMC Flight Maneuvers
1150	Select Landing Zone/Pickup Zone
2008	Perform Evasive Maneuvers
2009	Perform Multi-Aircraft Operations
2044	Perform Actions on Contact
2078	Perform Terrain Flight Mission Planning
2079	Perform Terrain Flight Navigation
2081	Perform Terrain Flight
2083	Negotiate Wire Obstacles
2086	Perform Masking and Unmasking
2090	Perform Tactical Communication Procedures
2091	Transmit Tactical Reports

INTENTIONALLY LEFT BLANK

---

## Appendix C. SA Rating Technique (SART) Questionnaire

---

Pin # \_\_\_\_\_

Date (DD/MM/YY): \_\_\_/\_\_\_/ **03**

Mission ID Number: \_\_\_\_\_

Right Seat \_\_\_\_\_ Left Seat \_\_\_\_\_ (Check one)

### **Situation Awareness**

SA1. Situation Awareness is defined as “timely knowledge of what is happening as you perform your right or left seat tasks during the mission.”

<b>Situation Awareness Rating Technique (SART)</b>	
DEMAND	
Instability of Situation	Likelihood of situation to change suddenly.
Variability of Situation	Number of variables which require your attention
Complexity of Situation	Degree of complication (number of closely connected parts) of the situation
SUPPLY	
Arousal	Degree to which you are ready for activity; ability to anticipate and keep up with the flow of events
Spare Mental Capacity	Amount of mental ability available to apply to new tasks
Concentration	Degree to which your thoughts are brought to bear on the situation; degree to which you focused on important elements and events
Division of Attention	Ability to divide your attention among several key issues during the mission; ability to concern yourself with many aspects of current and future events simultaneously
UNDERSTANDING	
Information Quantity	Amount of knowledge received and understood
Information Quality	Degree of goodness or value of knowledge communicated
Familiarity	Degree of acquaintance with the situation

---

*Assuming you had just performed this mission in a UH-60A/L, rate the level of each component of situation awareness that you had. Circle the appropriate number for each component of situation awareness (e.g., complexity of situation).*

---

DEMAND

Instability of situation: Low 1-----2-----3-----4-----5-----6-----7 High  
Variability of situation: Low 1-----2-----3-----4-----5-----6-----7 High  
Complexity of situation: Low 1-----2-----3-----4-----5-----6-----7 High

---

SUPPLY

Arousal: Low 1-----2-----3-----4-----5-----6-----7 High  
Spare mental capacity: Low 1-----2-----3-----4-----5-----6-----7 High  
Concentration: Low 1-----2-----3-----4-----5-----6-----7 High  
Division of attention: Low 1-----2-----3-----4-----5-----6-----7 High

---

UNDERSTANDING

Information quantity: Low 1-----2-----3-----4-----5-----6-----7 High  
Information quality: Low 1-----2-----3-----4-----5-----6-----7 High  
Familiarity: Low 1-----2-----3-----4-----5-----6-----7 High

---

---

For the mission that you just completed *in the UH-60M*, rate the level of each component of situation awareness that you had. Circle the appropriate number for each component of situation awareness (e.g., complexity of situation).

---

DEMAND

Instability of situation: Low 1-----2-----3-----4-----5-----6-----7 High  
Variability of situation: Low 1-----2-----3-----4-----5-----6-----7 High  
Complexity of situation: Low 1-----2-----3-----4-----5-----6-----7 High

---

SUPPLY

Arousal: Low 1-----2-----3-----4-----5-----6-----7 High  
Spare mental capacity: Low 1-----2-----3-----4-----5-----6-----7 High  
Concentration: Low 1-----2-----3-----4-----5-----6-----7 High  
Division of attention: Low 1-----2-----3-----4-----5-----6-----7 High

---

UNDERSTANDING

Information quantity: Low 1-----2-----3-----4-----5-----6-----7 High  
Information quality: Low 1-----2-----3-----4-----5-----6-----7 High  
Familiarity: Low 1-----2-----3-----4-----5-----6-----7 High

SA2. Rate the level of situational awareness you had for each of the battlefield elements during the mission by placing an X in the appropriate column for each battlefield element. Keep in mind that the simulation facility may be limited in its ability to display some of these elements; in the case, please place “N/A” somewhere in the row for that battlefield element.

Battlefield Elements	Very High Level of Situation Awareness	Fairly High Level of Situation Awareness	Intermediate Level of Situation Awareness	Fairly Low Level of Situation Awareness	Very Low Level of Situation Awareness
Location of Enemy Units					
Location of Friendly Units					
Location of Non-Combatants (e.g., Civilians)					
Location of My Aircraft During Mission					
Location of Other Aircraft Related to the Mission					
Location of Cultural Features (e.g., bridges)					
Route Information (ACPs, BPs, EAs, RPs, etc.)					
Status of My Aircraft Systems (e.g., fuel consumption)					

Describe any instances when you feel you had low situational awareness during the mission:

---



---



---



---



If you answered “Yes” to any of the questions, please describe a) the problems you experienced, b) how much the problems degraded your performance, and c) any recommendation you have for improving the design of the various functional components.

---



---



---



---



---



---



---

**PV2.** On average, how quickly were you able to navigate through menu screens on the:

**Primary Flight / Navigation Displays (PFD/ND)** (Circle one)

1	2	3	4	5
Very Quickly	Somewhat Quickly	Borderline	Somewhat Slowly	Very Slowly

**Digital Map System (DMS)** (Circle one)

1	2	3	4	5
Very Quickly	Somewhat Quickly	Borderline	Somewhat Slowly	Very Slowly

**Flight Management System (FMS)** (Circle one)

1	2	3	4	5
Very Quickly	Somewhat Quickly	Borderline	Somewhat Slowly	Very Slowly

**Engine Instrument Caution Advisory System (EICAS)** (Circle one)

1	2	3	4	5
Very Quickly	Somewhat Quickly	Borderline	Somewhat Slowly	Very Slowly

**Joint Variable Message Format (JVMF)**

1	2	3	4	5
Very Quickly	Somewhat Quickly	Borderline	Somewhat Slowly	Very Slowly

If you answered “Borderline,” “Somewhat Slowly,” or “Very Slowly” to any of the questions, list the component and why navigation was slow (e.g., ‘navigating the menu system on the FMS was a slow process due to having to page through several screen displays’).

---

---

---

---

---

---

---

---

**PV3.** How often did you forget the steps required for navigating through the menu screens to accomplish a task?

**Primary Flight / Navigation Displays (PFD/ND)** (Circle one)

1	2	3	4
Never	Seldom	Frequently	Always

**Digital Map System (DMS)** (Circle one)

1	2	3	4
Never	Seldom	Frequently	Always

**Flight Management System (FMS)** (Circle one)

1	2	3	4
Never	Seldom	Frequently	Always

**Engine Instrument Caution Advisory System (EICAS)** (Circle one)

1	2	3	4
Never	Seldom	Frequently	Always

**Joint Variable Message Format (JVMF)**

1	2	3	4
Never	Seldom	Frequently	Always

If you answered “Frequently” or “Always” to any of the questions, list the component and the tasks for which you forgot how to navigate through the menu screens (e.g., “I often forgot the steps for navigating through the menu screens on the FMS to change frequencies on the UHF radio”).

---



---

**PV4.** Please rate the intuitiveness of the following aspects of the Multifunction Switch Controller (MFSC) (a.k.a. potato grip):

**PV4-1.** When you actuated the directional control, did the cursor move in the direction you expected?

1	2	3	4	5
Very Intuitive	Somewhat Intuitive	Neither Intuitive nor Confusing	Somewhat Confusing	Very Confusing

**PV4-2.** When you actuated one of the three switches, did the expected action occur on the MFD?

1	2	3	4	5
Very Intuitive	Somewhat Intuitive	Neither Intuitive nor Confusing	Somewhat Confusing	Very Confusing

If you answered “Neither Intuitive nor Confusing,” “Somewhat Confusing,” or “Very Confusing,” please describe any problem with either the cursor control or switches, exactly what you were trying to accomplish on the MFD, and what actually happened on the MFD.

---



---



---



---

**PV5.** Did you have any difficulty using any of the switches on the collective or the cyclic grips?

**Collective Grip**                      Yes \_\_\_\_\_                      No \_\_\_\_\_

**Cyclic Grip**                        Yes \_\_\_\_\_                      No \_\_\_\_\_

If you answered “Yes” for either flight control, please list which flight control and switch(es), and the problems you experienced (e.g., confuses two switches due to similar shape, switch too hard to reach).

---



---

**PV6.** Was there any symbology depicted on the following displays/pages that was difficult to quickly and easily understand?

**Primary Flight Displays (PFD)**    Yes \_\_\_\_\_    No \_\_\_\_\_  
**Navigation Displays (ND)**        Yes \_\_\_\_\_    No \_\_\_\_\_  
**EICAS**                                Yes \_\_\_\_\_    No \_\_\_\_\_  
**Digital Map System (DMS)**        Yes \_\_\_\_\_    No \_\_\_\_\_  
**Aircraft Survivability Equip (ASE)** Yes \_\_\_\_\_    No \_\_\_\_\_

If you answered “Yes” to any of the questions, please describe a) the display/page, b) the symbology that was difficult understand, c) how the symbology may have degraded your performance, and d) any recommendation you have for improving the design of the various functional components.

---

---

---

---

---

---

---

**PV7.** Did you experience any problems with symbology clutter on the following displays that made it difficult to understand all the elements of information available to you?

<b>PFD – Full</b>	Yes _____	No _____
<b>PFD – Arc</b>	Yes _____	No _____
<b>PFD – Hover</b>	Yes _____	No _____
<b>ND – Full</b>	Yes _____	No _____
<b>ND – Plan</b>	Yes _____	No _____
<b>Digital Map</b>	Yes _____	No _____

If you answered “Yes” for any of these displays, please indicate which display and what symbols were cluttering the display to make it difficult to understand. Please include any recommendation you might have to alleviate the difficulty.

---

---

---

---

---

---

---

**PV8.** Did you experience any sort of hand discomfort while using the MSFC, collective, or cyclic grips?

<b>MFSC</b>	Yes _____	No _____
<b>Collective</b>	Yes _____	No _____
<b>Cyclic</b>	Yes _____	No _____

If you answered “Yes” for any of these controls, please list which control became uncomfortable, a rough description of how your hand was uncomfortable, what tasks you were trying to accomplish, and approximately how long it took for your hand to become uncomfortable.

---

---

---

---

---

---

---

**PV9.** For the JVMF reports that you sent, how would you rate the ease/difficulty of sending the following reports:

**Position Report**

1	2	3	4	5
Very Easy	Somewhat Easy	Borderline	Somewhat Difficult	Very Difficult

**Free Text Message**

1	2	3	4	5
Very Easy	Somewhat Easy	Borderline	Somewhat Difficult	Very Difficult

If you answered “Borderline,” “Somewhat Difficult,” or “Very Difficult,” please indicate which type of message you sent, the exact difficulties you encountered, and any recommendations to alleviate the problem.

---

---

---

---

---

---

---

**PV10.** How would you rate your ability to detect the following occurrences based on the characteristics of the flight displays?

**JVMF Message (MFD)**

1	2	3	4	5
Very Easy	Somewhat Easy	Borderline	Somewhat Difficult	Very Difficult

**Caution / Advisory (MFD)**

1	2	3	4	5
Very Easy	Somewhat Easy	Borderline	Somewhat Difficult	Very Difficult

**Warning (Master Warning Panel)**

1	2	3	4	5
Very Easy	Somewhat Easy	Borderline	Somewhat Difficult	Very Difficult

**Entry into Operational Limits (per Chp 5) on the Power Pod**

1	2	3	4	5
Very Easy	Somewhat Easy	Borderline	Somewhat Difficult	Very Difficult

If you answered “Borderline,” “Somewhat Difficult,” or “Very Difficult,” please indicate which annunciation you had difficulty detecting, why you may have had difficulty detecting it, and any recommendations to make the annunciation more noticeable or salient.

---



---



---

---

## Appendix E. Simulator Sickness Questionnaire (SSQ) Pre- and Post-Mission

---

1. PIN #: \_\_\_ \_\_\_ \_\_\_ \_\_\_      2. Date (DD/MMM/YY): \_\_\_ \_\_\_ - \_\_\_ \_\_\_ \_\_\_ - **03**

3. Mission ID Number: \_\_\_\_\_

4. Seat you will fly from: Right Seat \_\_\_\_\_ Left Seat \_\_\_\_\_ (Check one)

5. Please indicate the severity of symptoms that apply to you right now by circling the appropriate word.

Symptom	0	1	2	3
a. General discomfort	None	Slight	Moderate	Severe
b. Fatigue	None	Slight	Moderate	Severe
c. Headache	None	Slight	Moderate	Severe
d. Eyestrain	None	Slight	Moderate	Severe
e. Difficulty focusing	None	Slight	Moderate	Severe
f. Increased salivation	None	Slight	Moderate	Severe
g. Sweating	None	Slight	Moderate	Severe
h. Nausea	None	Slight	Moderate	Severe
i. Difficulty concentrating	None	Slight	Moderate	Severe
j. Fullness of head	None	Slight	Moderate	Severe
k. Blurred vision	None	Slight	Moderate	Severe
l. Dizzy (eyes open)	None	Slight	Moderate	Severe
m. Dizzy (eyes closed)	None	Slight	Moderate	Severe
n. Vertigo*	None	Slight	Moderate	Severe
o. Stomach awareness**	None	Slight	Moderate	Severe
p. Burping	None	Slight	Moderate	Severe

---

\* Vertigo is a loss of orientation with respect to vertical upright.

\*\* Stomach awareness is a feeling of discomfort just short of nausea.

6. Are you in your usual state of health and fitness?                      **YES**      **NO**

7a. Have you been ill in the past week?                                      **YES**      **NO**

    b. If yes, are you fully recovered?                                      **YES**      **NO**      **N/A**

1. PIN #: \_\_\_ \_\_\_ \_\_\_ \_\_\_      2. Date (DD/MMM/YY): \_\_\_ \_\_\_ - \_\_\_ \_\_\_ \_\_\_ - **03**

3. Mission ID Number: \_\_\_\_\_

4. Seat you will fly from: Right Seat \_\_\_\_\_ Left Seat \_\_\_\_\_ (Check one)

5. Please indicate the severity of symptoms that apply to you right now by circling the appropriate word.

Symptom	0	1	2	3
a. General discomfort	None	Slight	Moderate	Severe
b. Fatigue	None	Slight	Moderate	Severe
c. Headache	None	Slight	Moderate	Severe
d. Eyestrain	None	Slight	Moderate	Severe
e. Difficulty focusing	None	Slight	Moderate	Severe
f. Increased salivation	None	Slight	Moderate	Severe
g. Sweating	None	Slight	Moderate	Severe
h. Nausea	None	Slight	Moderate	Severe
i. Difficulty concentrating	None	Slight	Moderate	Severe
j. Fullness of head	None	Slight	Moderate	Severe
k. Blurred vision	None	Slight	Moderate	Severe
l. Dizzy (eyes open)	None	Slight	Moderate	Severe
m. Dizzy (eyes closed)	None	Slight	Moderate	Severe
n. Vertigo*	None	Slight	Moderate	Severe
o. Stomach awareness**	None	Slight	Moderate	Severe
p. Burping	None	Slight	Moderate	Severe

\* Vertigo is a loss of orientation with respect to vertical upright.

\*\* Stomach awareness is a feeling of discomfort just short of nausea.

---

## Appendix F. TSC Questionnaire

---

1. Mission Trial \_\_\_\_\_ 2. Date (DD/MMM/YY): \_\_ \_\_ / \_\_ \_\_ \_\_ / **03**

TSCWL1. Place the workload rating in the blank next to each crewmember using the rating scale on the previous page.

Crewmembers	Overall Workload Rating For This Mission
Left Seat	
Right Seat	

If you assigned a workload rating of '6' or higher for either crew member, explain why:

---



---



---



---



---



---



---



---

TSCWL2. Rate the effectiveness of aircrew coordination as defined by the USAAVNC Aircrew Coordination ETP and TC 1-210.

1	2	3	4	5
Excellent	Good	Average	Needs Improvement	Unacceptable

---



---



---



---

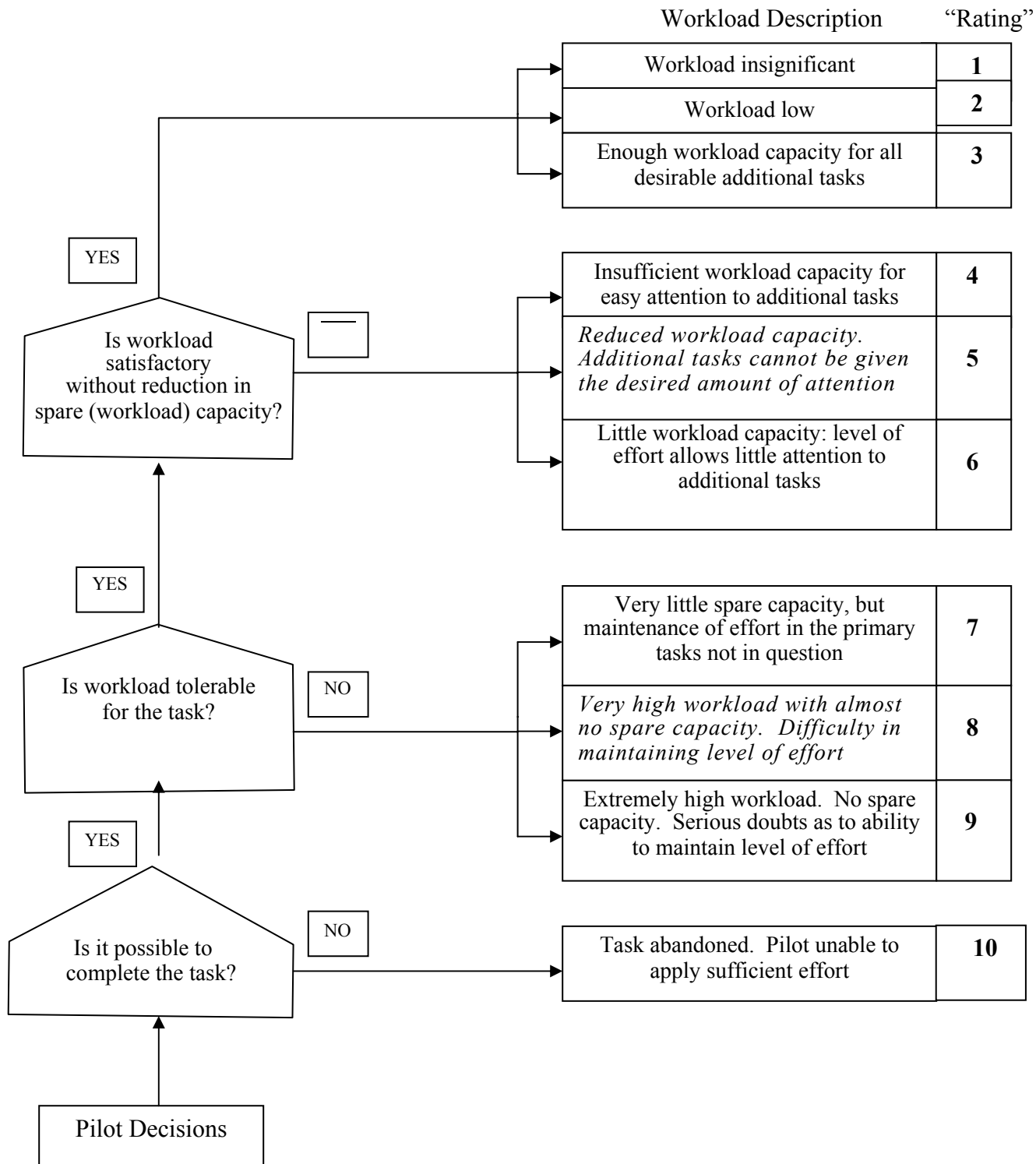



**TSC MISSION SUCCESS QUESTIONNAIRE**

TSC MS1. Did the UH-60M crew complete their mission objectives?

Yes \_\_\_\_\_ No \_\_\_\_\_

If no, why weren't the mission objectives completed?

---

---

---

---

---

---

---

---

---

---

TSC MS2. Was the mission successful?

Yes \_\_\_\_\_ No \_\_\_\_\_

If no, what caused the mission to fail?

---

---

---

---

---

---

---

---

---

---

# Appendix G. EUD2 APEX Lab System Diagrams

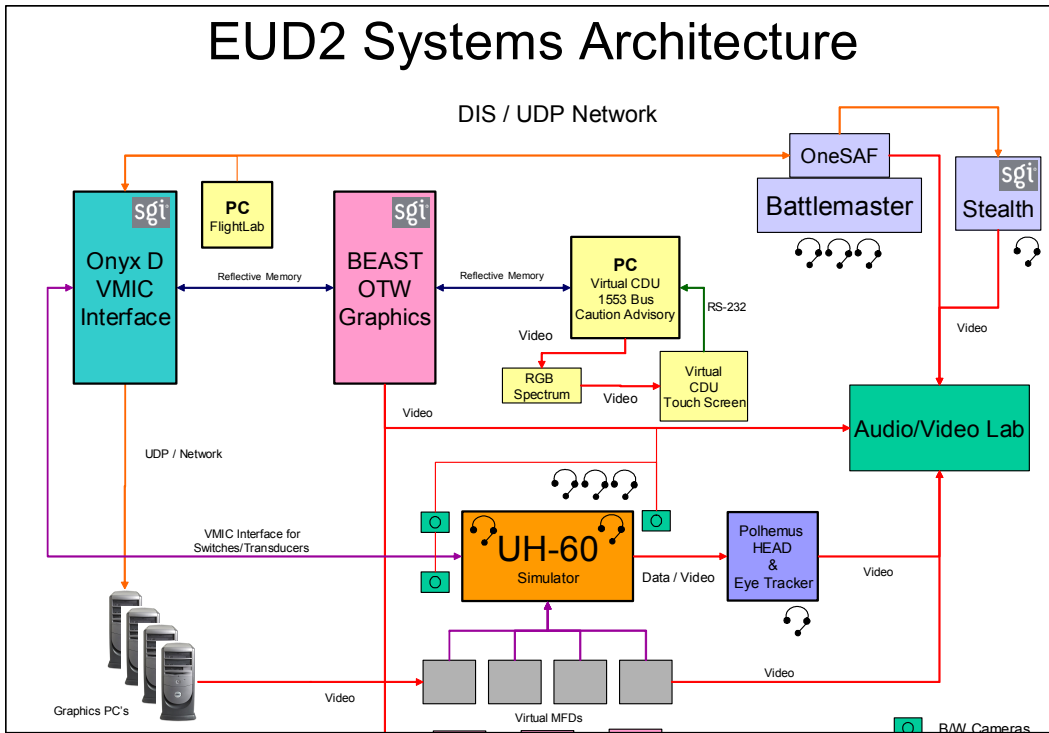

## EUD2 Data Collection Elements

### Data Elements

DIS PDU  
Logger

Polhemus  
HEAD



### Audio/Video Elements

TELEX  
Comms

Center Out the Window Channel

BW Cameras

Stealth



Virtual MFDs

ModSAF

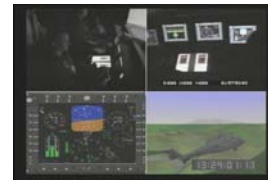

INTENTIONALLY LEFT BLANK

---

## Appendix H. Results of Eye Tracker System

---

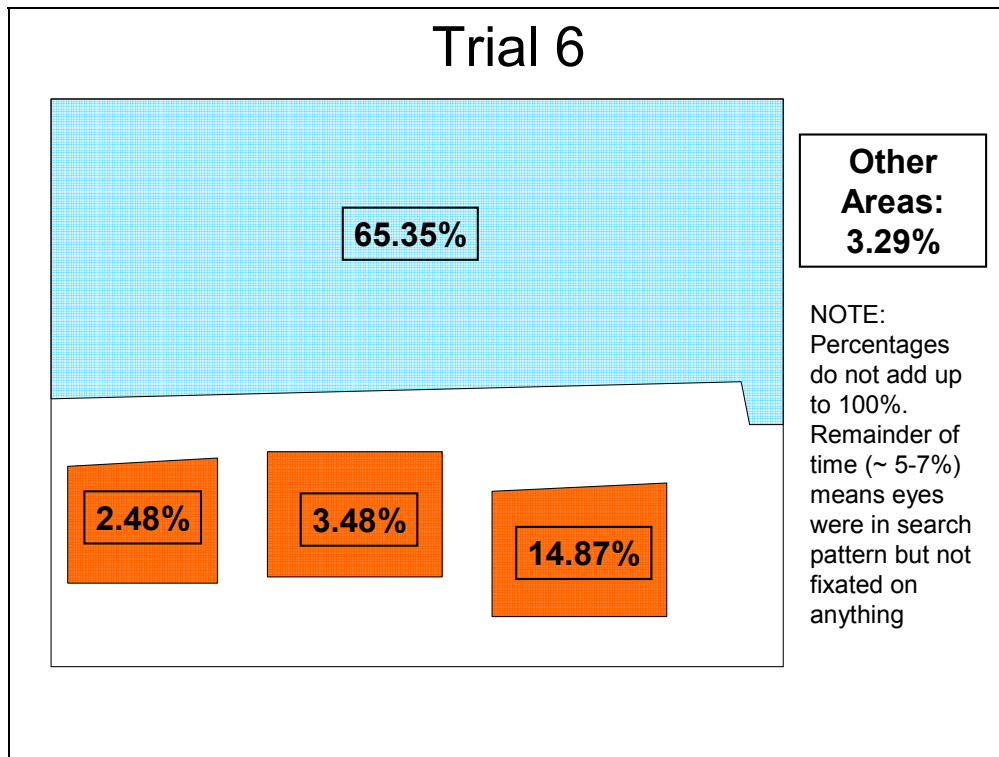
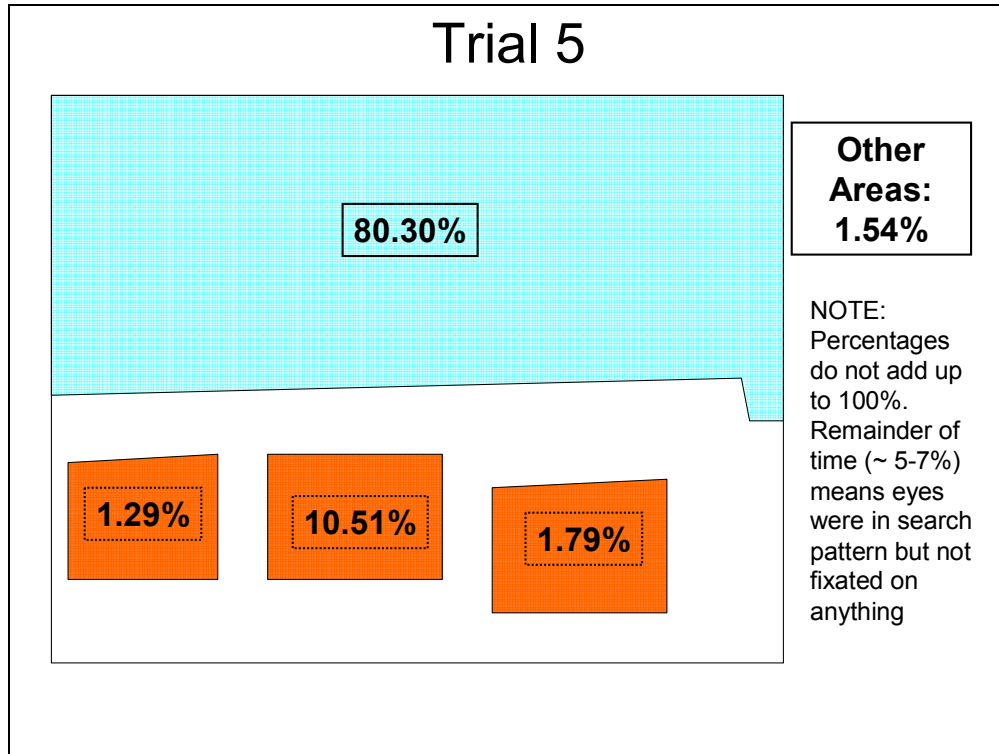

INTENTIONALLY LEFT BLANK

## Appendix I. Demographic/Anthropometric Questionnaire

Control #	_____
Analyst PIN:	_____

1. Personal Identification Number (PIN): \_\_\_\_\_ (Last name initial + Last Four)

2. Date of Birth: \_\_\_\_\_ (DD/MMM/YY)      3. Rank: \_\_\_\_\_      4. Date of Rank: \_\_\_\_\_ (DD/MMM/YY)

5. Basic Service Entry Date: \_\_\_\_\_ (DD/MMM/YY)

6. Current Unit: \_\_\_\_\_      7. Current Job Title: \_\_\_\_\_

8. Primary Military Occupational Specialty (PMOS):

9. How many months in this PMOS? \_\_\_\_\_

10. What is your primary aircraft? \_\_\_\_\_      11. Secondary aircraft? \_\_\_\_\_

12. Flight activity category (FAC): 1   2   3      13. Readiness Level (RL): 1   2   3

14. Anthropometric Data (collected in accordance with Donelson & Gordon, 1991)

Measurement	Raw Data	Percentile
Interpupillary Breadth		
Thumb Tip Reach		
Hand Breadth		
Hand Length		
Thumb Breadth		
Hand Circumference		
Sitting Eye Height		
Stature		

15. Handedness:     Right  
                            Left  
                            Ambidextrous

16. Sight Correction while flying (check if yes):

17. Correction type:  Glasses

Contacts

NA

18. Place a check mark by the aircraft you are qualified to fly, indicate instructor pilot qualification experience and annotate approximate flight hours for each aircraft.

Aircraft	Qualified		PI Hours	PC Hours	IP/IE/SP Hours	NVG Hours
	Yes	No				
AH-64A (Apache)						
AH-64D (Apache Longbow)						
AH-1(Cobra)						
AH-6/OH-6 (Cayuse)						
OH-58A/C (Kiowa)						
OH-58D (Kiowa Warrior)						
UH-1 (Iroquis)						
UH-60 (Blackhawk)						
CH-47 (Chinook)						
Other:						

---

## Appendix J. EUD2 Operations Order

---

COPY \_\_\_ OF \_\_\_ COPIES  
TF 1-3  
AL-FORTE ABDUL BANNING  
120900S MAY 03

OPERATIONS ORDER 1-23-04 (OPERATION IRAQI FREEDOM)

References:

Time Zone Used Through out Order: Sierra.

Task Organization:

TF 1-3 AVN

A / 1-3 AVN (AH-64 x 8)

B / 1-3 AVN (AH-64 x 8)

A / 2-3 AVN (UH-60 x 15 (OPCON) (BDE level Task Org, not mission level)

D / 3-7 CAV (OH-58D x 8) (OPCON)

E / 3-7 CAV (OH-58D x 8) (OPCON)

D / 1-3 AVN (AVUM)

### 1. SITUATION

a. Enemy Forces. See Annex B (Intelligence).

b. Friendly Forces.

(1) 3d ID

(a) Mission: 3d ID defends in sector NLT 141200S MAY 03, from PL HELEN to PL PAULA to block westward advance of Iraqi forces and prevent penetration of PL HELEN. O/O, 3d ID counterattacks in zone to reestablish the international border along PL SHERRY (admin: off map to the East).

(b) Commanders Intent: The purpose is to halt Iraqi 4<sup>th</sup> MID (IFV) offensive operations and reestablish the international border. We are the CORPS main effort. Key tasks: BCTs must aggressively occupy battle positions and establish hasty defense. The aviation task force must conduct thorough reconnaissance and security operations IOT to establish conditions for the division's transition from defensive to offensive operations. Reestablish international border with less than 30% casualties.

(c) Concept of Operation: 1<sup>st</sup> and 2d BDE will LD PL HELEN at Division H-hour (NLT 130900S MAY 03) to occupy BPs and TAA Bill and TAA Gary respectively and establish hasty defense. O/O 3d ID attacks to destroy the Jurkovian 1<sup>st</sup> Army front by engaging the first echelon forces (4<sup>th</sup> MID) with 1<sup>st</sup> and 2d BDEs (frontal attack). 1<sup>st</sup> BDE is the Division's main effort and 2d BDE is the supporting effort, 3d BDE, the Division's reserve exploits either success to destroy the 4<sup>th</sup> MID second echelon forces.

(2) 3d AVN BDE

(a) Mission: NLT 140600S MAY 03, 3d AVN BDE conducts reconnaissance and security operations to provide time for 3d ID's offensive preparation and prevent penetration of PL LISA. O/O attack to destroy enemy 1<sup>st</sup> echelon REPUBLICAN GUARD.

(b) Commander's Intent: The purpose of our mission is to buy time for the 3d ID to establish in sector and support follow-on offensive operations. We will prevent enemy ground forces from interrupting the Division's movement/counterattack. We will accomplish this by conducting aggressive

reconnaissance and security, inserting Division LRSD assets, and conducting deep attacks against enemy artillery. Retain 70% combat power for future operations.

(3) 1st CAV DIV, to the north, defends in sector from PL HELEN to PL PAULA. The DIV is conducting an area defense with two BNs forward and one BN in reserve. The BDE is currently at 70% strength after the Iraqi offensive, and it is doubtful they could contain another IRAQI attack larger than brigade size. Although the unit suffered some early defeats, the morale is high and they are expected to fight tenaciously against any further IRAQI aggression.

(4) 4<sup>th</sup> ID (M), to the south, is conducting security operations in sector while building the combat power to go on the offensive. The 4<sup>th</sup>'s AVN BDE is currently conducting a covering force mission from PL HELEN to PL PAULA. The division will defend with two BDEs forward and maintain one BDE in reserve. The 4<sup>th</sup> ID will commence its attack (the CORPS supporting effort) along with the 3d ID IAW the CORPS order. The 4<sup>th</sup> ID (M) is at 95% strength.

(5) 1<sup>st</sup> BDE, 3d ID is to our front in the northern sector, vic AA BOB continuing to build combat power. 2d BDE, 3d ID is to our front in the southern sector, vic AA GOMER continuing to build combat power. 3d BDE, 3d ID is also to our rear, vic AA CORY building combat power and is the Division Reserve. 1<sup>st</sup> and 2d BDE are currently at 90% strength while 3d BDE is currently at 75% strength

c. Attachments and Detachments. None

2. MISSION. NLT 131700S MAY 03, TF 1-3 conducts LRSD insertions to locate REPUBLICAN GUARD and provide early warning of enemy movement for the Division. NLT 140600S MAY 03, conducts route and area reconnaissance from PL HELEN to PL PAULA to ensure conditions are set for follow on movement through sector. Upon completion of the reconnaissance, TF 1-3 establishes a screen along PL PAULA to provide early warning of enemy southern movement into sector. O/O attacks to destroy 110<sup>th</sup> and 121<sup>st</sup> REPUBLICAN GUARD to set the conditions for the Division attack to reestablish the international border.

### 3. EXECUTION

Commander's Intent: Purpose, We will conduct reconnaissance and security operations to allow the division time to occupy sector and establish hasty defense and will attack the 1<sup>st</sup> echelon REPUBLICAN GUARD to set the conditions for the division's attack to reestablish the international border. Key tasks are insertion of LRSD Teams, area recon of TAAs and PAAs, route recon of MSRs, screen of PL PAULA, and destruction of at least (70%) of the REPUBLICAN GUARD. Endstate is the TF postured with no less than 70% combat power remaining to support the Division's offensive operations in reestablishing the international border (PL SHERRY).

a. Concept of Operation.

(1) Maneuver. This is a three-phase operation.

(a) Phase I: Reconnaissance & Surveillance. Begins when A/2-3, the main effort, inserts one LRSD team, NLT 131700S MAY 03. 3-47 FA provides ingress and egress SEAD. Phase I ends with successful insertion of the LRSD team, acft refueled in FARP TEXACO (admin: AA RAVEN) and postured for follow on missions in AA RAVEN.

(b) Phase II: Recon and Security. 140600S MAY 03, D/3-7 ACT, the main effort (1<sup>st</sup> BDE AO), and E/3-7 ACT, the supporting effort (2d BDE AO), LD PL HELEN to conduct area and route recon. Upon establishment of PL Paula, conduct a screen to allow the division early warning of any enemy movement west into sector. 4-17 FA BN provides DS fires. Phase II ends upon completion of RECON AND SURVEILLANCE with 1<sup>st</sup> and 2d BDE scouts and both ACTs returned to TAA SCOTT.

(c) Phase III: Deliberate Attack on the 4<sup>th</sup> MID REPUBLICAN GUARD. O/O (NET 142200S MAY 03), A/1-3, the main effort and B/1-3, the supporting effort conduct a deliberate attack to destroy at least 70% of the 110<sup>th</sup> and 121<sup>st</sup> REPUBLICAN GUARD vic EA THUNDER and EA LIGHTNING, respectively. 3-47 FA provides SEAD and reinforcing fires. A/1-3 has priority for planning and execution of 3 CAS sorties. This phase ends when the REPUBLICAN GUARD are destroyed both companies are rearmed/refueled at FARP TEXACO and returned to TAA SCOTT.

(2) Fires. Refer to Annex D (Fire Support). We will use DS, reinforcing and CAS to neutralize and disrupt the 4<sup>th</sup> MID second echelon regiments as well as counterbattery fires.

(3) Intelligence. See Annex B (Intelligence).

(4) Engineer. No assets available.

(5) Air Defense. Priority of GS protection during phase I and II is to TF 1-3 location in TAA SCOTT and FARP TEXACO. During phase III priority is to silent FARPs SHELL and EXXON. Air defense warning (ADW) is YELLOW; weapons control status (WCS) is TIGHT, changing to HOLD during deep attacks.

(6) Electronic Warfare. No assets available.

b. Tasks to Maneuver Units.

(1) A Company, 1-3.

(a) Phase II: BPT conduct hasty attacks against company size or larger penetrations of PL PAULA.

(b) Phase III: O/O (NET 142200S MAY 03), attack to destroy at least 38 artillery systems of the 110<sup>th</sup> Republican Guard in EA THUNDER.

(c) Phase III: ingress route HAWK and egress route FALCON.

(d) Submit any changes to Routes, and ABFs to BN S3 for coordination with brigade NLT 131800S MAY 03.

(2) B Company, 1-3.

(a) Phase I: OPCON x 4 AH-64s to A/2-3 AVN. Direct coordination is authorized.

(b) Phase III: O/O (NET 142200S MAY 03), attack to destroy at least 26 artillery systems of the 121<sup>st</sup> Republican Guard in EA LIGHTNING.

(c) Phase III: ingress route CONDOR and egress route EAGLE.

(d) Submit any changes to Routes, and ABFs to BN S3 for coordination with brigade NLT 131800S MAY 03.

(3) A Company, 2-3.

(a) Provide 1 UH-60 CASEVAC throughout operation prepositioned at HHC, TF 1-3.

(b) Phase I: NLT 131700S MAY 03, insert LRSD team 1, ingress route FALCON and egress route HAWK. LRSD team 1, Primary LZ ANN vic GA163908.

(c) Upon completion of insertion, assume REDCON 4 in AA RAVEN.

(d) Provide 1 UH-60 stand-by DART/PR throughout operations.

(4) D Troop, 3-7 CAV.

(a) LD PL HELEN at 140600S MAY 03.

(b) Conduct route recon MSR BLACK to ensure no enemy or obstacles exist along the route able to influence friendly movement along the route.

(c) Conduct area recon of TAA BILL, PAAs A-1, B-1, A-2, B-2, 12, and FARP SHELL ensuring no more than squad sized enemy elements are able to influence friendly forces once

established in each area.

(d) Establish a screen along PL PAULA NLT 140900S MAY 03 to provide early warning of enemy movement south.

(e) Report all recon information on TF 1-3 O/I.

(f) O/O conduct battle handover with 1<sup>st</sup> BDE scouts along PL PAULA.

(5) E Troop, 3-7 CAV.

(a) LD PL HELEN at 140600S MAY 03.

(b) Conduct route recon MSR RED to ensure no enemy or obstacles exist along the route able to influence friendly movement along the route.

(c) Conduct area recon of TAA GARY, PAAs A-3,B-3, 22, and FARP EXXON ensuring no more than squad sized enemy elements are able to influence friendly forces once established in each area.

(d) Establish a screen along PL PAULA NLT 140900S MAY 03 to provide early warning of enemy movement south.

(e) Report all recon information on TF 1-3 O/I.

(f) O/O conduct a battle handover with 2d BDE scouts along PL Paula.

c. Tasks to Combat Support Units.

(1) HHC.

(a) Provide base security and QRF for TAA SCOTT.

(b) BPT move TAC as required.

(c) Establish base FARP TEXACO vic FA889800, NLT 131000S MAY 03.

(d) B/P to move base FARP TEXACO to TAA SCOTT vic GA064837, NLT 140600S MAY 03.

(e) B/P to conduct silent FARP operations in support of Phase III at FARP SHELL vic GA077897 and /or FARP EXXON vic GA175835.

(f) Provide medic support to DART as per SOP.

(2) D Company, 1-3. Provide DART personnel as per SOP.

(3) Intelligence. See Annex B (Intelligence)

(4) Fire Support. See Annex D (Fire Support)

(a) Air support.

1. Three (3), CAS sorties for planning in Phase II.

2. Three (3), CAS sorties for planning in Phase III.

3. CAS aircraft on station one hour after request is made.

d. Coordinating instructions.

(1) OPORD and task Organization effective upon receipt.

(2) CCIR:

(a) PIR

- (1) Any 2S1s, ZSU 23/4s or 2S6s (SA-19s) along any air routes.
- (2) 10 or more BTRs in EA THUNDER.
- (3) 10 or more tanks in EA THUNDER or EA LIGHTNING.

(b) EEFI

- (1) Location of TAA and FARPs.
- (2) Location of Air Corridors.

(c) FFIR

- (1) More than 2 aircraft NMC prior to launch.
- (2) Loss of any aircraft.
- (3) Company at 25% hellfire.

(3) H-Hour for the LSRD insertion is wheels down in the LZ NLT 1700 hours.

(4) MOPP level: Zero.

(5) ROE. Report and be prepared to maintain contact with any identified enemy prior to PL LISA. Prior to PL PAULA - engage only those targets positively identified as enemy. Pass PL PAULA - engage any target not identified as friendly.

(6) Target Priorities – Phase I and II; ADA, C2, Armor, IFV/APCs. Phase III; Artillery (2S1s and 2S3s), ADA, C2.

(7) IFF Procedures: IFF ON and OFF: PL PAULA. Expect BN TOC clearance at PL LISA on ingress to ensure passage of lines coordination and PL TAMMY on egress. ADA WCS will also be adjusted.

(8) Abort criteria is the loss of any three aircraft during any phase.

(9) Routes: See Annex C, Operations Overlay.

(10) Altitudes: Coordinating altitude 200' RW, 400' FW.

(11) Companies conduct internal rehearsals.

(12) Companies develop DAPP and forward to BN.

(13) Submit route timing and adjustments for SEAD planning to BN FSO NLT 121800S MAY 03, for LRSD insertion and NLT 131800S MAY 03, for deliberate attack.

(14) Hellfire codes IAW SOP.

(15) Submit reports IAW the Div TSOP.

4. SERVICE SUPPORT. See Annex I (Service Support).

5. COMMAND AND SIGNAL

a. Command.

(1) Phase I and II; 1-3 Battalion commander will be in the C2 aircraft vic. ROZ 1a, Phase III; with B/1-3.

- (2) TOC will remain at, AA RAVEN vic FA886802.
- (3) TAC CP will move forward to TAA SCOTT vic GA064837 after Phase II is complete.
- (4) ALOC will remain at AA RAVEN.
- (5) Succession of command is: Bn Cdr, XO, S3, Cdr A/1-3, Cdr B/1-3.

b. Signal.

- (1) SOI index KTV 1600C in effect:

(a) Callsigns:

UNIT	CALLSIGN
BN CMD	RAVEN
HHT	COLT
A CO 1-3	ARROW
B CO 1-3	BUSTER
D CO 1-3	WITCHDOCTOR
A CO 2-3	EUD
D / 3-7 CAV	STETSON
E / 3-7 CAV	SABER
FSO	REDLEG 9
FARP/ADMIN	GOURD

(b) FREQUENCY/RADIO/NET:

BN CMD - 2 (UHF-AM)  
 O/I - 3 (VHF-AM)  
 FSO - 1 (FM)  
 Internal nets - 4 & 5

- (2) Messenger schedule and routes TBD.

ACKNOWLEDGE:

DUWRIGHT  
LTC

OFFICIAL:

WOUNDTITE  
S3

ANNEXES:

Annex B	Intelligence Estimate
Appendix 1	Enemy Situation Template
Annex C	Operations Overlay
Appendix 1	Maneuver Overlay
Tab A	Maneuver Sketch
Annex D	Fire Support
Appendix 1	Fire Support Overlay
Annex I	Service Support
Annex O	Airspace Command and Control (A2C2)

---

## Appendix K. Air Crew Mission Briefings

---

**INTRODUCTION** This briefing is for mission number 1, LRSD Insertion on the evening of 13 MAY 03.

**TIME HACK:** "IN ONE MINUTE IT WILL BE \_\_\_\_ HOURS LOCAL"  
"IN 30 SECONDS IT WILL BE \_\_\_\_ HOURS LOCAL - HACK"  
"IN 15 SECONDS IT WILL BE \_\_\_\_ HOURS LOCAL - HACK"  
"10 SECONDS"  
" 5, 4, 3, 2, 1 - HACK, the time is \_\_\_\_\_ Local"

**Roll Call** - (use crew card)

This briefing is classified: UNCLASSIFIED.

Operations Order # 1-23-04

Map References: JOG NI1612, Ed. 2, 16 OCT 89.

The Time Zone used throughout is Sierra, Central Standard Time

**TASK ORGANIZATION:** A/2-3 AVN (UH-60 x2) OPCON to TF 1-3 AVN.  
3<sup>rd</sup> ID LRSD (Gimlet) Team 1 (5 pax and equip)

### **Mission Overview:**

#### **I. SITUATION:**

##### **A. Enemy Forces:**

(1) Weather and NOTAMS: Weather is currently 900' and 1 ½ miles visibility due to low lying clouds and fog caused by the current temp being so close to the current dew point. Outlook for the mission looks the same with no change anticipated until tomorrow morning. No NOTAMS currently posted or anticipated through the duration of the mission. Flight lead will confirm with Flight OPS prior to takeoff. Hazards map posted in OPS has the most updated information on the hazards in the Al Forte Abdul Banning area.

(2) Enemy Forces (S2): No change.

(3) AAA Threat (S2):

Known enemy locations:

Northern sector:		Southern sector:	
x1 SA-9	GA 195949	x1 SA-9	GA 221813
x1 ZSU-23-4	GA 218942	x1 SA-9	GA 219831
x1 ZSU-23-4	GA 223945	x1 ZSU-23-4	GA 229832

Templated enemy locations (reported but not confirmed):

Northern sector:		Southern sector:	
x1 SA-9	GA 897850	x1 SA-9	GA 153815
x1 ZSU-23-4	GA 857857	x1 ZSU-23-4	GA 880810
x1 ZSU-23-4	GA 936843		
x1 SA-16	GA 895752		
x1 SA-16	GA 995727		

Known locations have been neutralized and do not pose any threat.

It has also been confirmed that the Command Security Outposts (CSOP) have SA-16s, not SA-7s.

(4) Terrain. No change.

**B. Friendly Forces:**

(1) Mission of Higher: NLT 131700S MAY 03, TF 1-3 AVN conducts LRSD insertions (Gimlet Elements) to provide early warning of enemy movement for the Division.

(2) Mission of Supported Brigade/Battalion: NLT 131700 MAY 03, 1<sup>st</sup> Team, LRSD, 3<sup>rd</sup> ID inserts vic. LZ ANN to confirm/deny the 4<sup>th</sup> ID's most dangerous COA and to provide early warning of enemy movement along AA1 west of PL PAULA.

**C. Attachments/Detachments:**

3<sup>rd</sup> ID LRSD CO (-), Team 1 "gimlet (5 person team)

**D. CCIR (COMMANDERS CRITICAL INFORMATION REQUIREMENTS):**

**Priority Information Requirements (PIR):**

a. Where are the enemy ADA systems that can affect the air movement and landing phase of the insertion?

b. What is the disposition/strength of the enemy forces vic. the LZs?

c. Where are the enemy forces in the rear area that can affect our AA?

**Friendly Forces Information Requirements (FFIR):**

a. Loss of any aircraft to maintenance or enemy action.

b. Loss of any key leader; loss of personnel that results in effective loss of aircrew.

c. Reduction of on hand class III/IV to less than 50% of the total FARP capacity.

**Essential Elements of Friendly Information (EEFI):**

a. Where are the LZs, FARP's, and air routes?

b. Where is TF RAVEN AA?

**II. MISSION:** A Company (-), 2-3 AVN REGT conducts LRSD insertion of LRSD Team 1 (Team Ranger) NLT 131700 S MAY 03 IOT provide Divisional reconnaissance and early warning of attacking 4<sup>th</sup> MIR along the most dangerous course of action axis on the Ingress Route and egress Route as depicted. LRSD Team 1 (Gimlet), Primary LZ ANN.

**III. EXECUTION.**

**A. Commanders Intent:**

Purpose: To successfully insert Gimlet elements vic. LZ ANN (Alt. LZ PEG). This is a two aircraft operation. Key tasks are the coordinated flight effort and the insertion. Endstate is Gimlet Element in position, un-compromised, and communication established with 3<sup>rd</sup> ID (M) TOC.

**Mission Intent (Concept of the Operation)**

1. Scheme of Maneuver: This operation will be conducted in five phases. Phases 2 and 3 are time driven; Phases 1, 2 and 5 are event driven.

Phase 1: Consists of pre-mission planning, aircraft preparation, pre-mission tasks and the OPORDER.

Phase 2: Consists of aircraft loading, take off, ingress route.

Phase 3: Consists of LZ recon, landing, and Gimlet aircraft exit.

Phase 4: Consists of Take off, Egress route , and landing at AA/PZ RAVEN (LAWSON).

Phase 5: Consists of shutdown and debriefing.

### **Scenario Phases in Detail.**

#### **Phase I:**

##### **Pre-mission planning, aircraft preparation, pre-mission tasks and the OPORDER.**

Preflight, run up/hit check, will be completed IAW the time-flow.

The commo check will be conducted IAW the time-flow and will be initiated by the lead aircraft. The order for the commo check will be the aircraft, AND Raven Operations.

The radios will first be checked on S/C Red: FM1, UHF, VHF, FM2. For example, EUD 1 on 1, 1 on 2, 1 on 3, 1 on 4. Next will be FH Red on FM1, FM2, VHF. FH/Secure will be last and executed identically to FH Red.

In the Setup Page, verify the IDM Init is Operational

Aircraft will run-up and make flight up calls as per the time flow.

Doors will be closed for the entire mission; light signals will be as per the serial's SOP.

## **Phase II:**

##### **En route from AA/PZ RAVEN (LAWSON) to LZ ANN:**

The flight will depart on time per the Time Flow.

Departure heading is 134° direct to SP 2 and following the ingress route to LZ ANN.

The formation will be staggered right, 45 degrees, 3-5 rotor disk separation. Weapons tight.

The flight will accelerate to 100 knots ground speed to the SP.

Altitude will be 200 ft AGL.

Upon reaching the RP lead will start a descent for landing, and slow back to 80 kts GS to facilitate an on time landing at the LZ .

Flight Lead Crew Chief will announce 2 minutes to landing and the direction of landing to the Gimlet Elements.

Machine Gun's will be extended for operations.

The approach direction into the LZ will be 037° degrees.

Flights will monitor the ABN on UHF, flight internal and the Gimlet internal nets on FMs.

## Phase III

**LZ recon, landing, and Gimlet personal depart the aircraft.**

**Action at the LZ:**

Weapons will be weapons free.

The flight will land as BRIEFED INTO the LZ, with lead touching down at the forward portion of the LZ.

Gimlet will unload both sides.

Phase IV

**Take off, depart on the Egress route , and landing at AA/PZ RAVEN (LAWSON).**

After personnel are clear, and trail has called clear, Flight Lead will takeoff from the direction of landing and once clear of the trees continue to climb and begin a slow left turn to 283° accelerating to 100 kts on the egress route.

EUD 2 will remain on Gimlet internal frequency until ACP 10 to facilitate extraction should the team become compromised within their first 10 minutes on the ground.

Landing at the AA/PZ Raven (Lawson) , 330 degree's.

**Phase V:**

Consists of a debrief after all UH-60's have landed back at the AA and update briefing for follow on missions.

**Contingencies plan for the mission:**

1. Go-Arounds: At the LZ will be to the left.  
Detailed execution: If lead determines a flight go-around is necessary he will call "flight go-around" on primary internal. He will then go around for another approach. He will make a traffic pattern as briefed and land to his assigned spot.
2. Weather abort criteria: Less than 500' ceilings and ½ mile visibility. The maximum weather delay is 24 hours.
3. Aircraft abort criteria: As per current maintenance directives and operators manuals.
4. Mission abort-criteria: minimum number of aircraft is 2 UH-60s before and throughout this mission.
5. ADA abort-criteria: ADA that denies the use of both the primary and alternate routes.
6. Enemy abort-criteria in the LZ: any compromise of Team Ranger will require an immediate extraction contingency.
7. Bump plan: Enroute- Broken aircraft will call "Lame duck", and if time permits, the nature of the problem. The trail aircraft will follow the downed aircraft. If there are no injuries, key pax will be escorted to the trail aircraft and bump the pax from that A/C. The trail aircraft will

then rejoin the flow to the LZ. If there are injuries, contact ASS 6 for further guidance. If the enemy situation requires E&E, downed aircrew pickup points are all SPs, RPs, and ACPs, 1 hour to 1½ hours before BMNT or 1-1½ hours after EENT

8. Alternate LZs: If an alternate LZ is to be used, Flight Lead/AMC will transmit the codeword "FLOP". And provide the received location of the LZ.

9. Lead change procedures: per serial SOP.

10. NVG Failure: IAW the serial SOP. N/A

11. Commo Failure: IAW the serial SOP.

12. IIMC: Lead will exhaust all alternatives to avoid IMC conditions, by altering route, returning to an airfield or landing if appropriate. In the unlikely event that IMC conditions are encountered the inadvertent aircraft will call codeword Blind- alley, base heading, airspeed, altimeter setting, and altitude he is climbing to. If subsequent aircraft cannot maintain VMC, the flight will execute altitudes and headings as per their serial IIMC card. The climb airspeed is 80 knots and the rate of climb is 1000 feet per minute. The primary recovery airfield is Lawson. Lead will make the initial call to ATC on VHF guard and all other aircraft will report in chalk order. Tactical call-signs will be used. Upon entering IMC all aircraft will turn position lights bright and formation lights on and anti-collision lights on. Any aircraft that finds VMC will remain VMC and report these conditions to lead and ATC. Anti-collision light can be turned off while IMC if Flicker Vertigo is encountered.

**13. Fuel Requirements: as per your serial kneeboard card.**

**E. Coordinating instructions:**

1. CSAR and E&R plan will be IAW SOP.
2. Deception Plan: See Phases IV and V of this briefing.
3. FARP procedures: At the end of the mission at AA/PZ Raven (Lawson).
4. ACLs: 5
5. MOPP level: Available
6. ROE:
  - At LZ: Weapons free
  - All enroute segments: Weapons tight
7. Rock drill: conducted after this OORDER.
8. Debrief place and time: here 1 hour after last aircraft shutdowns.

**IV. SERVICE AND SUPPORT**

**A. Supply:**

- (1) Class I: Individual responsibility.
  - (2) Class III: Fuel requirements are in the handout.
- Bingo fuel at the LZ is 500 lbs to fly a direct return route to the AA.

**B. Uniform:** Per AR 95-1.

**C. ALSE:** IAW the ARs.

**D. Maintenance support:** At AA/PZ Raven (Lawson).

**E. MEDEVAC:**

If an aircraft goes down resulting in damage an immediate request for MEDEVAC will be made to AA/PZ RAVEN (Lawson). Trail will follow any aircraft down and the aircraft directly in front of trail will follow trail aircraft down. The aircraft that is following the broke aircraft will render immediate aid. Internal MedEvac may be performed.

## **V. COMMAND AND SIGNAL**

**A. Command:**

- (1) Commander's location: AA/PZ RAVEN (Lawson).
- (2) AMC location: C2 Bird, ROZ 1a.
- (3) Flight Lead location: Chalk 1.
- (4) Ground Force Commander location: AA BOB.
- (5) AATFC location: N/A
- (6) Succession of command: EUD 1 THEN EUD 2.

**B. Signal:**

- 34.500/ 724.
- (1) Frequencies and callsigns are posted. The primary internal net is FM secure:
  - (2) Prowords and codewords are in accordance with the TACSOP.
  - (3) Signals: as previously briefed.
  - (4) C/S EUD 1 will have transponder responsibility; all others will maintain transponders in the standby mode. Squawk is 1200.
  - (5) Data messages (free text and Position Reports) will be given as assigned in the execution checklist.

This concludes the briefing. Questions please.

The next event is:

**MISSION BRIEFING PACKET – LRS D INSERTION**

Table of Contents

**TEAM EUD**

**LRS D  
13 MAY 2003**



**TABLE OF CONTENTS**

- 2. TIME SCHEDULE**
- 3 & 4 CREW AND COMMO CARD**
- 5. PZ/AA DIAGRAM (RAVEN)**
- 6-9 ROUTE CARD**
- 10. LZ DIAGRAM (ANN)**
- 11. AIR MOVEMENT TABLE**
- 12. FUEL CARD/IMC PROCEDURES**
- 13. LAWSON ILS 33**
- 14-16 EXECUTION CHECKLIST**
- 17. AREA MAP (JOG)**

Time Schedule

TIME	EVENT
0830 / 1330	BRIEFING
0835 / 1335	PREFLT, RUNUP, PROGRAM FMS AND NAV
0845 / 1345	HIT CHECK
0850 / 1350	COMMO CHECK
0900 / 1400	UPDATE BRIEF ON ABN
0910 / 1410	RUNUP
0915 / 1415	TAXI FOR LINE UP
0920 / 1420	REPOSITION TO PZ
0925 / 1425	REPOSITION FOR TAKE OFF
0930 / 1430	TAKE OFF
0943 / 1443	LZ
0956 / 1456	AA

Air Movement Table

Lift	Serial	Load	Lifted Unit	Pax/Equip	PZ	LZ	Loading	Lift-Off	RP	Landing	Remarks
1	1	1-5	GIMLET	5	RAVEN	6	0920/1420	0930/1430	0942/1442	0943/1443	



Fuel Card

<b>FUEL REQUIREMENTS</b>				
FROM	TO	LEG	REQ T/O FUEL	REFUEL LOCATION
AA	LZ	22	1000	AA
LZ	AA	22	500	AA
<b>CRUISE BURN RATE:</b>			<b>800</b>	PER HOUR
<b>BINGO FUEL</b>				
AT		BINGO FUEL		DESTINATION
LZ		500		AA
<b>FUEL CONTINGENCIES</b>				
ACP	HDG	ETE	GRID	FUEL REQUIRED
	DIST	ETA		REFUEL SITE
DIRECT BENNING	245		PER TDH	
	18.1			BENNING
<b>IMC RECOVERY AIRFIELD</b>				
NAVAID	FREQUENCY		APPROACH	
LSF VOR	114.8			
LSF LOC	110.7		ILS RWY 33, OM: JUMPR	

Execution Checklist – Pilot

**EXECUTION CHECKLIST**

LINE	EVENT	NET	FROM	TO	ACTUAL	COMMENT
#					TIME	
10	PZ CONT. PZ IS CLEAR FOR OPERATIONS	CAN	PZ RAVEN	ASS 6	0910 / 1410	DATA: (FREE TEXT) PZ CLEAR
20	PRJ/ALT RT DECISION	CAN	ASS 6	EUD 1	0911 / 1411	DATA: (FREE TEXT) PRIMARY ROUTE DECISION AND PZ CLEAR AT THIS TIME.
30	C2 BIRD LIFTS OFF. WITH ASSAULT 6 ABOARD	CAN	C 2	RAVEN OP'S AND EUD 1	0913 / 1413	DATA: (POSITION REPORT)
40	ATK 1: DEPARTS AS BRIEFED	CAN	ATK 1	ASS 6 AND EUD 1	0914 / 1414	DATA: (POSITION REPORT)
50	EUD 1 REQUEST HOVER INSTRUCTIONS FOR PZ OP'S , DIRECT TO RUNWAY 15	APEX GROUND	EUD 1	APEX GROUND	0915 1415	VOICE
60	APEX GRND: EUD 1 AND FLT, HOVER TAXI FOR PZ OP'S , THEN PROCEED TO RUNWAY 15 AND CONTACT TWR	APEX GROUND	APEX GROUND	EUD 1	0915 / 1415	VOICE
70	EUD 1: APEX GRND , EUD 1 ROGER.	APEX GROUND	EUD 1	APEX GROUND	0915 /1415	VOICE
80	EUD 1: APEX TWR, EUD 1 SHORT OF RUNWAY15, REQUEST HOVER TAXI ONTO THE RUNWAY.	APEX TWR	EUD 1	APEX TWR	0925 / 1425	VOICE
90	APEX TWR: EUD 1 AND FLT HOVER TAXI ONTO RUNWAY 15 , ADVISE WHEN READY FOR DEPART	APEX TWR	APEX TWR	EUD 1	0926 / 1426	VOICE

YOU GOT MAIL

C2 AIRCRAFT ICON FOR 30 SECONDS

ATK AIRCRAFT ICON FOR 30 SEC'S.

100	EUD 1: EUD 1 ROGER.	APEX TWR	EUD 1	APEX TWR	0927 / 1427	VOICE
110	EUD 1 REQUEST DEPARTURE/ TAKE OFF INSTRUCTION	APEX TWR	EUD 1	APEX TWR	0928 / 1428	VOICE
120	APEX TWR: EUD 1 AND FLT, APEX TWR, WIND 060/10, CLEARED FOR TAKE OFF.	APEX TWR	APEX TWR	EUD 1	0930 / 1430	VOICE
130	EUD 1: EUD 1 DEPARTS	CAN	EUD 1	ASS 6	0930 / 1430	DATA (POS. REPORT)
140	EUD 1: REPORT RP.	CAN	EUD 1	ASS 6	0942 / 1442	DATA (POS. REPORT)
150	ASS. 6: SENDS REQUESTED ACKNOWLEDGEMENT FROM EUD 1	CAN	ASS 6	EUD 1	0943 / 1443	DATA (ACKNOWLEDGEMENT)
160	EUD 1: REPORT ARRIVAL AT THE LZ	CAN	EUD 1	ASS 6	0943 / 1443	DATA (POS. REPORT)
170	EUD 1: REPORT DEPARTING THE LZ AT THE SP.	CAN	EUD 1	ASS 6	0944 / 1444	DATA (POS. REPORT)
180	EUD 1: REPORT LEFT BASE FOR LANDING 15, DIRECT TO THE FARP.	APEX TWR	EUD 1	APEX TWR	0948/1448	VOICE
190	EUD 1: ARRIVES PARKING EOM, AAR	CAN	EUD 1	ASS 6	0955 / 1444	DATA (POS. REPORT)

RECEIVES MESSAGE ACK'ED ON THE SND STATUS PAGE

Execution Checklist – Controllers Only

180A	EUD 1 GOES IMC	CAN	EUDI	ASS 6 ???	0950 / 1450	VOICE
180B	EUD 1 RECOVERS ILS RWY 33, VECTORS FROM APPROACH CONTROL	N/A	N/A	N/A		N/A

**INTRODUCTION This briefing is for mission number 2, Air Movement on the day of 14 MAY 03.**

**TIME HACK:** "IN ONE MINUTE IT WILL BE \_\_\_\_ HOURS LOCAL"  
"IN 30 SECONDS IT WILL BE \_\_\_\_ HOURS LOCAL - HACK"  
"IN 15 SECONDS IT WILL BE \_\_\_\_ HOURS LOCAL - HACK"  
"10 SECONDS"  
" 5, 4, 3, 2, 1 - HACK, the time is \_\_\_\_\_ Local"

**Roll Call** - (use crew card) and Packet Inventory

This briefing is classified: UNCLASSIFIED.

Operations Order # 1-3-04 , AIR MOVEMENT

Map References: JOG NI1612, Ed. 2, 16 OCT 89.

The Time Zone used throughout is Sierra, Central Standard Time

TASK ORGANIZATION: A/2-3 AVN (UH-60 x 5) OPCON to TF 1-3 AVN.

**Mission Overview:**

**I. SITUATION:**

**A. Enemy Forces:**

(1) Weather and NOTAMS: Weather is currently at 2000', unlimited visibility, and partly cloudy skies. Outlook for the mission shows no change. Winds are out of the west at 10 kts. for flight altitudes. No change to NOTAMS or hazards. Place OP1 (designated NFA) graphics around LRSD location vic. LZ PEG.

(2) Enemy Forces (S2):

a. The 2d Iraqi Div. is anticipated to be 24 hours out from reinforcing the 1<sup>st</sup> Iraqi Div. It is very possible to see lead elements consisting of no larger than company size starting to move south. These elements will be configured as the lead for Iraqi Divisions.

b. Vehicle movement and troop activity has been reported along PL Paula .

(3) AAA Threat (S2): No change.

(4) Terrain (S2): No change.

**B. Friendly Forces:**

1 Mission of Higher: NLT 140600S MAY 03, TF 1-3 AVN conducts area and route reconnaissance from PL HELEN to PL PAULA. O/O establishes screen along PL PAULA IOT allow the division early warning of any enemy movement west into the Division sector.

2 Mission of Supported Brigade/Battalion: 1<sup>st</sup> and 2<sup>nd</sup> BCT, 3<sup>rd</sup> ID will LD PL HELEN NLT 130900 MAY 03 IOT occupy BP's and TAA BILL and TAA GARY respectively and establish hasty defensive positions. O/O 3<sup>rd</sup> ID attacks to destroy the Iraqi Jurkovician, 1<sup>st</sup> Iraqi Div. front by engaging the first-echelon (4<sup>th</sup> MID) in a frontal attack.

**C. Attachments/Detachments: None.**

#### **D. Commander's Critical Information Requirements (CCIR):**

##### **Priority of Information Requirements (PIR):**

- a. Where are the enemy ADA systems that can affect the air movement and landing phases of the air assault?
- b. What is the disposition/strength of the enemy forces vic the LZs?
- c. Where are the enemy forces in the rear area that can affect our AA?

##### **Friendly Forces Information Requirements:**

- a. Loss of any aircraft to maintenance or enemy action.
- b. Loss of any key leader; loss of personnel that results in effective loss of aircrew.
- c. Reduction of on hand class III/V to less than 50% of the total FARP capacity.

#### **F. Essential Elements of Friendly Information (EEFI):**

- a. Where are the PZs, LZs, FARPs, and air routes?
- b. Where is TF RAVEN AA?

**II. MISSION:** A Company, 2-3 AVN conducts Battalion Air Movement of fuel, supplies and personnel from AA/PZ RAVEN to LZ SHELL NLT 140630 MAY 03, and LZ EXXON NLT 140730 MAY 03 IOT support the establishment of FARP's SHELL and EXXON, respectively.

#### **III. EXECUTION.**

##### **A. Commanders Intent:**

Purpose: To successfully insert Class III/V and personnel to establish temporary jump FARPS to support 3-7 CAV's security and reconnaissance mission along PL PAULA. This is a company level Air Movement by no-less-than 5 aircraft to input the supplies for FARP establishment. The company will conduct one turn to FARP SHELL then return to the PZ to upload and conduct another turn into FARP EXXON. The endstate is both jump FARPS supplied with enough material to facilitate their establishment NLT 140830 MAY 03.

##### **Mission Intent (Concept of the Operation)**

1. Scheme of Maneuver: This operation will be conducted in four phases. Phases 1-3 are time driven, Phase 4 is event driven.

Phase 1: Consists of pre-mission planning, aircraft preparation, pre-mission tasks and the OORDER.

Phase 2: Consists of the Air Movement from the PZ / AA RAVEN (Lawson) to LZ SHELL and return to the PZ/AA Raven (Lawson).

Phase 3: Consists of the Air Movement from the PZ /AA RAVEN (Lawson) to LZ EXXON and return to the PZ/AA Raven (Lawson).

Phase 4: Debrief.

##### **Scenario Phases in Detail.**

Phase II: Air Movement to LZ SHELL

**From PZ/AA Raven (Lawson):**

Ground will direct the flight to the PZ , EUD 1 will contact PZ Raven for External lift operations.

Flights will monitor the ABN on UHF, CAN and conduct digital traffic (company freq. ) on FM nets. Flight internal will be on the CAN. For the mission.

**Actions at the PZ/AA Raven (Lawson):**

The touchdown point for each serial lead will be the departure end of the PZ's

The Passengers and equipment will conduct a hot load. (3 minute Load Time).

**Enroute from PZ/AA Raven (Lawson) to LZ SHELL**

IAW the Time flow EUD 1 and EUD 2 gives the beacon call, EUD 1 will call APEX GROUND for serial 1 to taxi out and hover out of the PZ to runway 15. EUD 1 Will then contact APEX Tower for I Line-Up, Stagger Right formation on the active runway, 1 rotor disk separation.

The flight will depart on time per the Time Flow.

After take off formation will be staggered right, 3-5 disk separation and we will accelerate to 100 kts GS and climb to 100 ft AGL.

At the RP, The flight will decelerate to 80 kts GS. Crew Chiefs will announce one minutes to landing and the direction of landing. Machine Gun's will be extended for operations .. This will acilitates an on-time landing into LZ SHELL.

**Action at the LZ SHELL:**

The flight will land with lead positioning as far forward as possible.

Weapons will be weapons hold.

Aircraft will release the load (fuel blivets) at the desired location, and then reposition to the left rear of each load for Class V/Troop unloading.

Troops will unload both sides.

Trail aircraft will advice lead when the flight is BEACON

**En route from LZ SHELL to the PZ/AA Raven (Lawson):**

The flight will depart on time per the Time Flow along the egress Route.

Departure heading is 360° with a slow immediate left turn to the SP and following the Egress route.

The formation will be staggered right, 45 degrees, 3-5 rotor disk separation. Weapons tight.

The flight will accelerate to 100 kts GS.

Altitude will be 100 ft AGL.

Upon reaching the RP lead will start a descent for landing, and slow back to 80 kts GS to facilitate an on-time landing at PZ/AA Raven (Lawson). Contact Lawson Tower extended left base for landing direct to the PZ for Load #2.

The approach direction into the PZ/AA Raven (Lawson) will be 150 degrees.

### **Phase III: Air movement to LZ EXXON:**

#### **Actions at PZ/AA Raven (Lawson):**

The touchdown point for each serial lead will be the depart end of the PZ

The formation will land straight trail.

The Passengers will conduct a hot load. (3 minute Load Time).

EUD 1 will request hover taxi instruction from the PZ to the runway from Ground.

EUD 1 will request from APEX tower to reposition on runway 15 for flight departure.

#### **En route from PZ/AA Raven (Lawson) to LZ EXXON**

The flight will depart on time per the Time Flow.

After take off formation will be staggered right, 3-5 disk separation and we will accelerate to 100 kts GS and climb to 100 ft AGL.

At the RP, The flight will decelerate to 80 kts GS. Crew Chiefs will announce 1 minutes to landing and the direction of landing. Machine Guns will be extended for operations .. This facilitates an on-time landing into LZ EXXON.

#### **Action at the LZ EXXON:**

The flight will land with lead touching down as far forward as possible.

Weapons will be weapons hold.

Aircraft will set down the A22 bags (Class V) at the desired location, reposition the aircraft for troops unloading at the left rear of each load..

Trail aircraft will advice lead when the flight is beacon

#### ***En route LZ EXXON to PZ/AA Raven (Lawson):***

Takeoff heading is 320 deg to follow the Egress route .

The flight will accelerate to 100 knots.

Altitude will be 100 AGL.

Landing and shut down will be at the PZ/AA Raven (Lawson) EOM. After FARP operations.

On extended base to runway 15, EUD 1 will request land direct to the FARP.

## **Phase IV:**

Consists of a debrief after all UH-60's have landed back at the AA/parking. and update briefing for follow on missions.

### **Contingencies plan for the mission:**

1. Go-Arounds: At the PZ AND LZ will be to the right. Detailed execution: If lead determines a flight go-around is necessary he will call "flight go-around" on primary internal. He will then lead the flight around for another approach. If any other aircraft requires an individual go-around, he will announce his call sign and the code word "go-around" on internal. He will then clear the flight to the left or right as appropriate and climb straight ahead until clear of the flight. He will make a traffic pattern as briefed and land to his assigned spot.

2. Weather abort criteria: Less than 500' ceilings and ½ mile visibility. The maximum weather delay is 24 hours.

3. Aircraft abort criteria: As per current maintenance directives and operators manuals.

4. Mission abort criteria: minimum number of aircraft is 5 UH-60s before and throughout this mission.

5. Minimum Force to secure the LZ is 55 troops.

6. ADA abort criteria is ADA that denies the use of both the primary and alternate routes.

7. Enemy abort criteria in the LZ: more than a company size force defending the LZ or Armor in the LZ.

8. Bump plan:

a. Enroute- Broken aircraft will call "Lame Duck", chalk # and if time permits, the nature of the problem. The trail aircraft will follow the downed aircraft. If there are no injuries, key pax will be escorted to the trail aircraft and bump the pax from that A/C. The trail aircraft will then rejoin the flow to the LZ. Bumped pax will be sequence to the LZ following the last scheduled lift. If there are injuries, contact AMC for further guidance. If the enemy situation requires E&E, downed aircrew pickup points are all SPs, RPs, and ACPs, 1 hour to 1½ hours before BMNT or 1-1½ hours after EENT

9. Alternate routes: None

10. Alternate LZs: There are no alternate LZ's for this mission.

11. Lead change procedures: per serial SOP.

12. Lame duck procedures: any aircraft in a lame duck situation will call Lame Duck, call sign, and if time permits, the nature of the problem. Actions for lame duck aircraft are as follows: Consider External Load jettisoned: Trail Acft Mark position of impact for possible recovery or Destruction.

a. At the PZ- the crew-chief of the broken aircraft will escort all pax off the aircraft and over to PZ control. A decision will be made whether to launch the spare aircraft, which will be lined on the North side of the runway as briefed. The DART team will assist in removing the A/C from the PZ prior to lift If Flight Lead or AMC breaks, they will bump the copilot of the spare aircraft.

b. Enroute- If chalk 3 goes down trail aircraft will follow affected aircraft down to ensure a safe landing is made and cross load PAX. The serial commander will notify the AMC and the TAC and execute the bump plan if pax are on board. The situation will be relayed to the AMC. The

AMC will notify the TAC in order to launch the DART to coordinate for recovery of the aircraft and crew.

c. At the LZ-The aircrew will make every attempt to clear the aircraft to the departure left or right edge of the LZ. The aircraft will remain position and formation lights on bright if able. Notify the AMC for recovery.

13. NVG Failure: IAW the serial SOP. N/A.

14. Commo Failure: IAW the serial SOP. Commo failure aircraft will return to parking upon their next return to the PZ.

15. IIMC: Lead will exhaust all alternatives to avoid IMC conditions, by altering route, returning to an airfield or landing if appropriate. In the unlikely event that IMC conditions are encountered the inadvertent aircraft will call codeword Blind- alley, base heading, airspeed, altimeter setting, and altitude he is climbing to. If subsequent aircraft cannot maintain VMC, the flight will execute altitudes and headings as per their serial IIMC card. The climb airspeed is 80 knots and the rate of climb is 1000 feet per minute. The primary recovery airfield is LAWSON. Lead will make the initial call to ATC on VHF guard and all other aircraft will report in chalk order. Tactical call-signs will be used. Upon entering IMC all aircraft will turn position lights bright and formation lights on and anti-collision lights on. Any aircraft that finds VMC will remain VMC and report these conditions to lead and ATC. Anti-collision light can be turned off while IMC if Flicker Vertigo is encountered.

**16. Fuel Requirements: as per your serial kneeboard card.**

17. CasEvac plan. The next to the last aircraft of the serial for all lifts is identified as the CasEvac aircraft. CasEvac is coordinated on ABN and its location is PZ/AA RAVEN (LAWSON).

#### **E. Coordinating instructions:**

1. CSAR and E&R plan : PER LOCAL SOP
2. Deception Plan:
3. FARP procedures: at PZ/LZ Raven (Lawson)
4. ACLs: departing the PZ to SHELL = Fuel Blivet and fare kit.  
PZ to EXXON = A22 bag (Class V)
5. MOPP level: NONE
6. ROE:  
  
At PZ: Weapons hold  
At LZ: Weapons tight  
At Farp: Weapons hold  
All enroute segments: Weapons tight
7. Rock drill: None
8. Debrief place and time: here 1 hour after last aircraft shutdowns.

#### **IV. SERVICE AND SUPPORT**

##### **A. Supply:**

- (1) Class I: Individual responsibility.

- (2) Class III: Fuel requirements are in the handout.
- (3) Take-off fuel at the PZ is 2200 pounds to FARP site.
- (4) Take-off fuel at PZ second turn is 1800 pounds to FARP.
- (5) Bingo fuel at the LZ is 400 lbs to fly a direct return route to the AA.

**B. Uniform:** as per AR 95-1.

**C. ALSE:** IAW the ARs.

**D. Maintenance support:** .

**E. MEDEVAC:**

If an aircraft goes down resulting in damage an immediate request for MEDAVAC will be made to AA RAVEN. Trail will follow any aircraft down and the aircraft directly in front of trail will follow trail aircraft down. The aircraft that is following the broke aircraft will render immediate aid. Internal MedEvac will not be performed.

## **V. COMMAND AND SIGNAL**

**A. Command:**

- (1) Commander's location: Chalk 3
- (2) AMC location: C2 Bird, ROZ 1A
- (3) Flight Lead location: Chalk 1
- (4) Ground Force Commander location: AA BOB and AA GOMER
- (5) AATFC location: N/A.
- (6) Succession of command: EUD 1 THEN EUD 2

**B. Signal:**

- 724. (1) Frequencies and callsigns are posted. The primary internal net is FM-34.500 /
- (2) Prowords and codewords are in accordance with the TACSOP.
- (3) Signals: as previously briefed.
- (4) C/S EUD 1 will have transponder responsibility; all others will maintain transponders in the standby mode. Squawk is 1200.

This concludes the briefing. Questions please.

## MISSION BRIEFING PACKET – AIR MOVEMENT

### Table of Contents

# TEAM EUD

## AIR MOVEMENT 14 MAY 2003



### TABLE OF CONTENTS

- 2. TIME SCHEDULE
- 3 & 4 CREW AND COMMO CARD
- 5. PZ/AA DIAGRAM (RAVEN)
- 6-7 ROUTE CARD (LIFT 1)
- 8. LZ DIAGRAM (SHELL)
- 9-10 ROUTE CARD (LIFT 2)
- 11. LZ DIAGRAM (EXXON)
- 12. AIR MOVEMENT TABLE
- 13. FUEL CARD/IMC PROCEDURES
- 14. LAWSON ILS 33
- 15-17 EXECUTION CHECKLIST
- 18. AREA MAP (JOG)

Time Schedule

TIME	EVENT
0830 / 1330	BRIEFING
0835 / 1335	PREFLT, RUNUP, PROGRAM FMS AND NAV
0845 / 1345	HIT CHECK
0850 / 1350	COMMO CHECK
0900 / 1400	UPDATE BRIEF ON ABN
0910 / 1410	RUNUP
0915 / 1415	TAXI FOR LINE UP
0920 / 1420	REPOSITION TO PZ TO PICK UP LOADS
0925 / 1425	REPOSITION FOR TAKE OFF
0930 / 1430	TAKE OFF
0943 / 1443	LZ
0954 / 1454	AA
0955 / 1455	PICKUP LOADS
1000 / 1500	TAKE OFF
1010 / 1510	LZ
1026 / 1526	AA

Air Movement Table

Lift	Serial	Load	Lifted Unit	Pax/Equip	PZ	LZ	Loading	Lift-Off	RP	Landing	Remarks
1	1	1-5	TF 1-3	FUEL BLADDER	AA	SHELL	0920/1420	0930/1430	0940/1440	0943/1443	
2	1	6-10	TF 1-3	A22 BAG'S	AA	EXXON	0955/1455	1000/1500	1009/1509	1010/1510	



Fuel Card

<b>FUEL REQUIREMENTS</b>				
<b>FROM</b>	<b>TO</b>	<b>LEG</b>	<b>REQ T/O FUEL</b>	<b>REFUEL LOCATION</b>
AA	LZ SHELL	22	1400	AA
LZ	AA	22	1100	AA
AA	LZ EXXON	22	800	AA
LZ	AA	22	400	AA
<b>CRUISE BURN RATE: 800 PER HOUR</b>				
<b>BINGO FUEL</b>				
AT		BINGO FUEL		DESTINATION
LZ		400		AA
<b>FUEL CONTINGENCIES</b>				
ACP	HDG	ETE	GRID	FUEL REQUIRED
	DIST	ETA		REFUEL SITE
DIRECT BENNING	245		PER TDH	
	18.1			BENNING
<b>IMC RECOVERY AIRFIELD</b>				
NAVAID	FREQUENCY		APPROACH	
	LSF VOR	114.8		
LSF LOC	110.7		ILS RWY 33, OM: JUMPR	

Execution Checklist – Pilot

**AIR MOVEMENT EXECUTION CHECKLIST**

LINE	EVENT	NET	FROM	TO	ACTUAL	COMMENT
#					TIME	
10	PZ CONT. PZ IS CLEAR FOR OPERATIONS	CAN	RAVEN OP'S	ASS 6	0910 / 1410	DATA: (FREE TEXT) PZ CLEAR
20	PRI/ALT RT DECISION	CAN	ASS 6	EUD 1	0911 / 1411	DATA: (FREE TEXT) PRIMARY ROUTE DECISION AND PZ CLEAR AT THIS TIME.
30	C2 BIRD LIFTS OFF. WITH ASSAULT 6 ABOARD	CAN	ASS 6	RAVEN OP'S AND EUD 1	0916 / 1416	DATA: (POSITION REPORT)
40	ATK 1: DEPARTS AS BRIEFED	CAN	ATK 1	ASS 6 AND EUD 1	0920 / 1420	DATA: (POSITION REPORT)
50	EUD 1 REQUEST HOVER INSTRUCTIONS FOR PZ OP'S , DIRECT TO RUNWAY 15	APEX GROUND	EUD 1	APEX GROUND	0922 / 1422	VOICE
60	APEX GRND: EUD 1 AND FLT, HOVER TAXI FOR PZ OP'S , THEN PROCEED TO RUNWAY 15 AND CONTACT TWR	APEX GROUND	APEX GROUND	EUD 1	0922 / 1422	VOICE
70	EUD 1: APEX GRND , EUD 1 ROGER.	APEX GROUND	EUD 1	APEX GROUND	0922 / 1422	VOICE
80	EUD 1: APEX TWR, EUD 1 SHORT OF RUNWAY 15, REQUEST HOVER TAXI ONTO THE RUNWAY.	APEX TWR	EUD 1	APEX TWR	0925 / 1425	VOICE
90	APEX TWR: EUD 1 AND FLT HOVER TAXI ONTO RUNWAY _15 , ADVISE WHEN READY FOR DEPART	APEX TWR	APEX TWR	EUD 1	0926 / 1426	VOICE

YOU GOT MAIL

C2 AIRCRAFT ICON FOR 30 SECONDS

ATK AIRCRAFT ICON FOR 30 SEC'S.

100	EUD 1: EUD 1 ROGER.	APEX TWR	EUD 1	APEX TWR	0927 / 1427	VOICE
110	EUD 1 REQUEST DEPARTURE/ TAKE OFF INSTRUCTION	APEX TWR	EUD 1	APEX TWR	0928 / 1428	VOICE
120	APEX TWR: EUD 1 AND FLT, APEX TWR, WIND 060/10, CLEARED FOR TAKE OFF.	APEX TWR	APEX TWR	EUD 1	0930 / 1430	VOICE
130	EUD 1: EUD 1 DEPARTS	CAN	EUD 1	ASS 6	0930 / 1430	DATA (POS. REPORT)
140	REDLEG 6: SEAD COMP. 1 MINUTE PRIOR TO RP	CAN	REDLEG 6	EUD1 AND ASS 6	0940 / 1440	DATA (FREE TEXT) SEAD COMPLETE
150	EUD 1: SEND ENEMY TANK MOVING , NORTH OF THE RP (020 DEG), 3.0 KM'S.	CAN	EUD 1	ASS 6	0940 / 1440	DATA (FREE TEXT) REPORT 1 T 54, MOVING NORTH, 020 DEG'S FROM THE RP, 3.0 KM'S,
160	EUD 1: REPORT RP.	CAN	EUD 1	ASS 6	0940 / 1440	DATA (POS. REPORT)
170	ASS. 6: SENDS REQUESTED ACKNOWLEDGEMENT FROM EUD 1	CAN	ASS 6	EUD 1	0941 / 1441	DATA (ACKNOWLEDGEMENT)
180	EUD 1: REPORT DEPART THE LZ	CAN	EUD 1	ASS 6	0946 / 1446	DATA (POS. REPORT)

RECEIVE FREE TEXT STATING SEAD COMPLETE

EUD 1 RECEIVES MESSAGE ACK'ED ON THE SND STATUS PAGE

190	EUD 1: REPORT LEFT BASE FOR LANDING 15, DIRECT TO THE PZ.	APEX TWR	EUD 1	APEX TWR	0948/1448	VOICE
200	APEX TWR: EUD 1 AND FLT, APEX TWR, WIND 060/10, CLEARED FOR LANDING.	APEX TWR	APEX TWR	EUD 1	0950 / 1450	VOICE
210	EUD 1: ARRIVES AT THE PZ/AA	CAN	EUD 1	ASS 6	0954 / 1454	DATA (POS. REPORT)
220	EUD 1 REQUEST HOVER TAXI TO RWY 15 FOR DEPARTURE	APEX TWR	EUD 1	APEX TWR	0958 / 1458	VOICE
230	APEX TWR: CLEAR TO HOVER TAXI ONTO RWY 15, ADVISE WHEN READY FOR DEPARTURE	APEX TWR	APEX TWR	EUD 1	1000 / 1500	VOICE
240	APEX TWR: EUD 1 AND FLT, APEX TWR, WIND 060/10, CLEARED FOR TAKE OFF.	APEX TWR	APEX TWR	EUD 1	1000 / 1500	VOICE
250	EUD 1: EUD 1 DEPARTS	CAN	EUD 1	ASS 6	1000 / 1500	DATA (POS. REPORT)
260	EUD 1: REPORT RP.	CAN	EUD 1	ASS 6	1009 / 1509	DATA (POS. REPORT), TURN ACK ON!
270	ASS. 6: SENDS REQUESTED ACKNOWLEDGEMENT FROM EUD 1	CAN	ASS 6	EUD 1	1010 / 1510	DATA (ACKNOWLEDGEMENT)
280	EUD 1: REPORT ARRIVAL AT THE LZ	CAN	EUD 1	ASS 6	1010 / 1510	DATA (POS. REPORT)

EUD 1  
RECEIVES  
MESSAGE  
ACK'ED ON  
THE SND  
STATUS  
PAGE

290	EUD 1: REPORT DEPARTED LZ AND AT THE SP	CAN	EUD 1	ASS 6	1016 / 1516	DATA (POS. REPORT)
300	EUD 1: REPORT LEFT BASE FOR LANDING 15, DIRECT TO THE FARP.	APEX TWR	EUD 1	APEX TWR	1024 / 1524	VOICE
310	APEX TWR: EUD 1 AND FLT, APEX TWR, WIND 060/10, CLEARED FOR LANDING.	APEX TWR	APEX TWR	EUD 1	1024 / 1524	VOICE
320	EUD 1 REQUEST HOVER TAXI TO RWY 15 FOR DEPARTURE	APEX TWR	EUD 1	APEX TWR	1025 / 1525	VOICE
330	EUD 1: ARRIVES PARKING EOM, AAR	CAN	EUD 1	ASS 6	1026 / 1526	DATA (POS. REPORT)

## Execution Checklist – Controllers Only

140A	ASS 6: HOLDS THE FLIGHT AT ACP 3, REQUEST ACKNOWLEDGEMENT FROM EUD 1	CAN	ASS 6	EUD 1	0936 / 1436	DATA (FREE TEXT) HOLD ACP 3, LZ NOT CLEAR
140B	EUD 1: SEND ACKNOWLEDGEMENT	CAN	EUD 1	ASS 6	0937 / 1437	DATA (FREE TEXT) ACKNOWLEDGED.
140C	ASS 6: RELEASES EUD 1 FROM ACP 3	CAN	ASS 6	EUD 1	0939 / 1439	DATA: (FREE TEXT) PROCEED TO THE LZ
290A						EUD 1 HAS A HYDRAULIC FAILURE IN ROUTE BACK TO THE LZ.

**INTRODUCTION This briefing is for mission number 3, Air Assault on 15 MAY 03.**

**TIME HACK:** "IN ONE MINUTE IT WILL BE \_\_\_\_\_ HOURS LOCAL"  
"IN 30 SECONDS IT WILL BE \_\_\_\_\_ HOURS LOCAL - HACK"  
"IN 15 SECONDS IT WILL BE \_\_\_\_\_ HOURS LOCAL - HACK"  
"10 SECONDS"  
" 5, 4, 3, 2, 1 - HACK, the time is \_\_\_\_\_ Local"

**Roll Call** - (use crew card)

This briefing is classified: UNCLASSIFIED.

Operations Order # 1-3-04

Map References: JOG NI1612, Ed. 2, 16 OCT 89.

The Time Zone used throughout is Sierra, Central Standard Time

TASK ORGANIZATION: A/2-3 AVN (UH-60 x 15) OPCON to TF 1-3 AVN.

**Mission Overview:**

**I. SITUATION:**

**A. Enemy Forces:**

(1) Weather and NOTAMS: Weather is currently at 2000', unlimited visibility, and partly cloudy skies. Outlook for the mission shows no change. Winds are out of the west at 10 kts. for flight altitudes. No change to NOTAMS or hazards. Place OP1 (designated NFA) graphics around LRSD location vic. LZ ANN.

(2) Enemy Forces (S2):

a. The 2d ID is 12 hours out from reinforcing the 1<sup>st</sup> ID. The 1<sup>st</sup> ID is expected to resume offense as soon as the 2d ID arrives and is refueled, As anticipated the 4<sup>th</sup> ID is moving in extra 2S3 BN forward from the REAR to reinforce the 110<sup>th</sup> Infantry Brigade to support the mains effort.

b. Expect the 4<sup>th</sup> MID to resume offensive operations in 6 hours (NLT) with their battalion reconnaissance elements. Also expect the most probable enemy course of action to move on the main access roads.

c. There has been an increase of SPF activity in rear areas.

(3) PZ/AA RAVEN (LAWSON)A Threat (S2):

Southern sector:		Northern sector:	
x1 SA-8	GA260850	x1 SA-8	GA127977
x1 SA-8	GA271862	x1 SA-8	GA165958
x1 ZSU-23-4	GA260893	x1 ZSU-23-4	GA113960
x1 ZSU-23-4	GA299890	x1 ZSU-23-4	GA160960

(4) Terrain (S2): No change.

**B. Friendly Forces:**

1 Mission of Higher: NLT 152200S MAY 03, TF 1-3 AVN conducts hasty attacks in support of 1BCT and 2BCT's movement to contact in zone IOT destroy remnants of the 4<sup>th</sup>

MID.

2 Mission of Supported Brigade/Battalion: 1<sup>st</sup> and 2<sup>nd</sup> BCT, 3<sup>rd</sup> ID attack to destroy the Iraqi Jurkovician 1<sup>st</sup> Army front by engaging the first-echelon (4<sup>th</sup> MID) in a frontal attack.

**C. Attachments/Detachments:** None.

**D. Commander's Critical Information Requirements (CCIR):**

**Priority of Information Requirements (PIR):**

a. Where are the enemy ADA systems that can affect the air movement and landing phases of the air assault?

b. What is the disposition/strength of the enemy forces vic the LZs?

c. Where are the enemy forces in the rear area that can affect PZ/AA RAVEN (LAWSON)?

**Friendly Forces Information Requirements:**

a. Loss of any aircraft to maintenance or enemy action.

b. Loss of any key leader; loss of personnel that results in effective loss of aircrew.

c. Reduction of on hand class III/V to less than 50% of the total FARP capacity.

**F. Essential Elements of Friendly Information (EEFI):**

a. Where are the, LZs, FARPs, and air routes?

**II. MISSION:** A Company, 2-3 AVN conducts Battalion Air Assault of reserve personnel of 3BCT from PZ/AA RAVEN (LAWSON) to LZ DUCK NLT 150900 MAY 03 IOT reinforce 2 BCT in the southern sector.

**III. EXECUTION.**

**B. Commanders Intent:**

Purpose: To successfully insert personnel to reinforce the 2BCT effort in the southern sector of the Division AO. This is a company level Air Assault by no-less-than 5 aircraft conducting two turns into the LZ. The primary route is the INGRESS ROUTE. The endstate is 1-302 IN, 3BCT successfully air assaulted into LZ DUCK with all troops and equipment.

**Mission Intent (Concept of the Operation)**

1. Scheme of Maneuver: This operation will be conducted in four phases. Phases 1-3 are time driven, Phase 4 is event driven.

Phase 1: Consists of pre-mission planning, aircraft preparation, pre-mission tasks and the OORDER.

Phase 2: Consists of the Air Assault from PZ/AA RAVEN (LAWSON) to LZ DUCK and return to the PZ/AA RAVEN (LAWSON).

Phase 3: Consists of turn 2 of the Air Assault from the PZ/PZ/AA RAVEN (LAWSON) to LZ DUCK and return to the PZ/AA RAVEN (LAWSON).

Phase 4: Debrief.

**Scenario Phases in Detail.**

## Phase I

Preflight, run up/hit check, will be completed IAW the time-flow.

The comms check will be conducted IAW the time-flow and will be initiated by the lead aircraft.

The radios will first be checked on S/C Red: FM1, UHF, VHF, FM2. For example, EUD 1 on 1, 1 on 2, 1 on 3, 1 on 4. Next will be FH Red on FM1, FM2, VHF. FH/Secure will be last and executed identically to FH Red. In the Setup Page, verify the IDM Init is operational.

Aircraft will run-up and make flight up calls as per the time flow.

Doors will be open for the entire mission, light signals will be as per the serial's SOP.

IAW the Time flow EUD 1 will call ground for serial 1 to taxi out and hover out of parking to Line-Up, Stagger Right formation on the active runway, 1 rotor disk separation.

## Phase II: Air Movement to LZ DUCK

### From PZ/AA Raven (Lawson):

Ground will direct the flight to the PZ , EUD 1 will contact PZ Raven for in troop pick up.

Flights will monitor the  
ABN on UHF,  
CAN – digital traffic  
Flight internal will be on the CAN.  
ATC - VHF  
For the mission.

### Actions at the PZ/AA Raven (Lawson):

The touchdown point for each serial lead will be the departure end of the PZ's

The Passengers and equipment will conduct a hot load. (3 minute Load Time).

### Enroute from PZ/AA Raven (Lawson) to LZ DUCK

IAW the Time flow EUD 1 and EUD 2 gives the beacon call, EUD 1 will call APEX GROUND for serial 1 to taxi out and hover out TO THE PZ . EUD 1 Will then contact APEX Tower for I Line-Up, Stagger Right formation on the active runway, 1 rotor disk separation.

The flight will depart on time per the Time Flow.

After take off formation will be staggered right, 3-5 disk separation and we will accelerate to 100 kts GS and climb to 100 ft AGL.

At the RP, The flight will decelerate to 80 kts GS. Crew Chiefs will announce one minutes to landing and the direction of landing. Machine Gun's will be extended for operations .. This will Facilitates an on-time landing into LZ DUCK.

### Action at LZ DUCK:

The flight will land with lead positioning as far forward as possible.

Weapons will be weapons hold.

Troops will unload both sides.

Trail aircraft will advise lead when the flight is BEACON,

**Enroute from LZ DUCK to the PZ/AA Raven (Lawson):**

The flight will depart on time per the Time Flow along the egress Route.

Departure heading is 040 with a slow immediate left turn to the SP and following the Egress route.

The formation will be staggered right, 45 degrees, 3-5 rotor disk separation. Weapons tight.

The flight will accelerate to 100 kts GS.

Altitude will be 100 ft AGL.

Upon reaching the RP lead will start a descent for landing, and slow back to 80 kts GS to facilitate an on-time landing at PZ/AA Raven (Lawson). Contact Lawson Tower extended left base for landing direct to the PZ for Load #2.

The approach direction into the PZ/AA Raven (Lawson) will be 150 degrees.

**Phase III: Air movement to LZ DUCK:**

**Actions at PZ/AA Raven (Lawson):**

The touchdown point for each serial lead will be the depart end of the PZ

The formation will land straight trail.

The Passengers will conduct a hot load. (3 minute Load Time).

EUD 1 will request hover taxi instruction from the PZ to the runway from Ground.

EUD 1 will request from APEX tower to reposition on runway 15 for flight departure.

**En route from PZ/AA Raven (Lawson) to LZ DUCK**

The flight will depart on time per the Time Flow.

After take off formation will be staggered right, 3-5 disk separation and we will accelerate to 100 kts GS and climb to 100 ft AGL.

At the RP, The flight will decelerate to 80 kts GS. Crew Chiefs will announce 1 minutes to landing and the direction of landing. Machine Guns will be extended for operations .. This facilitates an on-time landing into LZ duck

**Action at the LZ DUCK:**

The flight will land with lead touching down as far forward as possible.

Weapons will be weapons hold.

Aircraft will set down the A22 bags (Class V) at the desired location, reposition the aircraft for troops unloading at the left rear of each load..

Trail aircraft will advise lead when the flight is beacon

*En route LZ DUCK to PZ/AA Raven (Lawson):*

Takeoff heading is 320 deg to follow the Egress route .

The flight will accelerate to 100 knots.

Altitude will be 100 AGL.

Landing and shut down will be at the PZ/AA Raven (Lawson) EOM. After FARP operations.

On extended base to runway 15, EUD 1 will request land direct to the FARP.

#### **Phase IV:**

Consists of a debrief after all UH-60's have landed back at the AA/parking. and update briefing for follow on missions.

#### **Contingencies plan for the mission:**

1. Go-Arounds: per ATC at the pz and to the right at the lz
2. Weather abort criteria: Less than 500' ceilings and ½ mile visibility. The maximum weather delay is 24 hours.
3. Aircraft abort criteria: As per current maintenance directives and operators manuals.
4. Mission abort criteria: minimum number of aircraft is 5 UH-60s before and throughout this mission.
5. Minimum Force to secure the LZ is 55 troops per lift.
6. ADA abort criteria is ADA that denies the use of both the primary
7. Enemy abort criteria in the LZ: any ADA that denies the use of the LZ
8. Bump plan: Per the TacSop
9. Alternate routes: None
10. Alternate LZs: None
11. Lead change procedures: per serial SOP.
12. Lame duck procedures: Per the Tac Sop
12. Commo Failure Per the TacSop
15. IIMC: Lead will exhaust all alternatives to avoid IMC conditions, by altering route, returning to an airfield or landing if appropriate. In the unlikely event that IMC conditions are

encountered the inadvertent aircraft will call codeword Blind- alley, base heading, airspeed, altimeter setting, and altitude he is climbing to. If subsequent aircraft cannot maintain VMC, the flight will execute altitudes and headings as per their serial IIMC card. The climb airspeed is 80 knots and the rate of climb is 1000 feet per minute. The primary recovery airfield is LAWSON. Lead will make the initial call to ATC on VHF guard and all other aircraft will report in chalk order. Tactical call-signs will be used.

**16. Fuel Requirements: as per your serial kneeboard card.**

17. CasEvac plan.

**E. Coordinating instructions:**

1. CSAR and E&R plan : PER LOCAL SOP
2. Deception Plan:
3. FARP procedures: at PZ/LZ Raven (Lawson)  
ACLs: departing the PZ to DUCK = 55 for both lifts.
5. MOPP level: NONE
6. ROE:  
  
At PZ: Weapons hold  
At LZ: Weapons tight  
At Farp: Weapons hold  
All enroute segments: Weapons tight
7. Rock drill: None
8. Debrief place and time: here 1 hour after last aircraft shutdowns.

**IV. SERVICE AND SUPPORT**

**A. Supply:**

- (1) Class I: Individual responsibility.
- (2) Class III: Fuel requirements are in the handout.
- (3) Take-off fuel at the PZ is 2200 pounds to FARP site.
- (4) Take-off fuel at PZ second turn is 1800 pounds to FARP.
- (5) Bingo fuel at the LZ is 400 lbs to fly a direct return route to the AA.

**B. Uniform:** as per AR 95-1.

**C. ALSE:** IAW the ARs.

**D. Maintenance support:** .

**E. MEDEVAC:**

If an aircraft goes down resulting in damage an immediate request for MEDAVAC will be made to AA RAVEN. Trail will follow any aircraft down and the aircraft

directly in front of trail will follow trail aircraft down. The aircraft that is following the broke aircraft will render immediate aid. Internal MedEvac will not be performed.

## **V. COMMAND AND SIGNAL**

### **A. Command:**

- (1) Commander's location: Chalk 3
- (2) AMC location: C2 Bird, ROZ 1A
- (3) Flight Lead location: Chalk 1
- (4) Ground Force Commander location: AA BOB and AA GOMER
- (5) AATFC location: N/A.
- (6) Succession of command: EUD 3, EUD 1, Eud 5, Eud 2, Eud 4

### **B. Signal:**

- (1) Frequencies and callsigns are posted.
- (2) Prowords and codewords are in accordance with the TACSOP.
- (3) Signals: as previously briefed.
- (4) C/S EUD 1 will have transponder responsibility; all others will maintain transponders in the standby mode. Squawk is mode 1: 21 for the duration, mode 2: 2331. Mode 3: 4312.

This concludes the briefing. Questions please.

**MISSION BRIEFING PACKET – AIR ASSAULT**

Table of Contents

**TEAM EUD**

**AIR ASSAULT  
15 MAY 2003**



**TABLE OF CONTENTS**

- 2. TIME SCHEDULE**
- 3 & 4 CREW AND COMMO CARD**
- 5. PZ/AA DIAGRAM (RAVEN)**
- 6-9 ROUTE CARD (LIFT 1)**
- 10. LZ DIAGRAM (DUCK)**
- 11. AIR MOVEMENT TABLE**
- 12. FUEL CARD/IMC PROCEDURES**
- 13. LAWSON ILS 33**

Time Schedule

<b>TIME</b>	<b>EVENT</b>
0830 / 1330	BRIEFING
0835 / 1335	PREFLT, RUNUP, PROGRAM FMS AND NAV
0845 / 1345	HIT CHECK
0850 / 1350	COMMO CHECK
0900 / 1400	UPDATE BRIEF ON ABN
0910 / 1410	RUNUP
0915 / 1415	TAXI FOR LINE UP
0920 / 1420	REPOSITION TO PZ TO PICK UP LOADS
0925 / 1425	REPOSITION FOR TAKE OFF
0930 / 1430	TAKE OFF
0941 / 1441	LZ
0949 / 1449	AA
0950 / 1450	PICKUP LOADS
0955 / 1455	TAKE OFF
1006 / 1506	LZ
1014 / 1514	AA

Air Movement Table

<b>Lift</b>	<b>Serial</b>	<b>Load</b>	<b>Lifted Unit</b>	<b>Pax/Equip</b>	<b>PZ</b>	<b>LZ</b>	<b>Loading</b>	<b>Lift-Off</b>	<b>RP</b>	<b>Landing</b>	<b>Remarks</b>
1	1	1-5	GIMLET	55 PAX	AA	DUCK	0920/1420	0930/1430	0940/1440	0940/1440	
2	1	6-10	GIMLET	55 PAX	AA	DUCK	0950/1450	0955/1455	1005/1505	1006/1506	



Fuel Card

<b>FUEL REQUIREMENTS</b>				
FROM	TO	LEG	REQ T/O FUEL	REFUEL LOCATION
AA	LZ DUCK	22	1400	AA
LZ	AA	22	1100	AA
AA	LZ DUCK	22	800	AA
LZ	AA	22	400	AA
<b>CRUISE BURN RATE:</b>			<b>800</b>	PER HOUR
<b>BINGO FUEL</b>				
AT		BINGO FUEL		DESTINATION
LZ		400		AA
<b>FUEL CONTINGENCIES</b>				
ACP	HDG	ETE	GRID	FUEL REQUIRED
	DIST	ETA		REFUEL SITE
DIRECT	245		PER TDH	
BENNING	18.1			BENNING
<b>IMC RECOVERY AIRFIELD</b>				
NAVAID	FREQUENCY		APPROACH	
LSF VOR	114.8			
LSF LOC	110.7		ILS RWY 33, OM: JUMPR	

Execution Checklist – Pilot

**EXECUTION CHECKLIST**

LINE	EVENT	NET	FROM	TO	ACTUAL	COMMENT
#					TIME	
10	PZ CONT. PZ IS CLEAR FOR OPERATIONS	CAN	PZ RAVEN	ASS 6	0910 / 1410	DATA: (FREE TEXT) PZ CLEAR
20	PRI/ALT RT DECISION	CAN	ASS 6	EUD 1	0911 / 1411	DATA: (FREE TEXT) PRIMARY ROUTE DECISION AND PZ CLEAR AT THIS TIME.
30	C2 BIRD LIFTS OFF. WITH ASSAULT 6 ABOARD	CAN	ASS 6	RAVEN OP'S AND EUD 1	0916 / 1416	DATA: (POSITION REPORT)
40	ATK 1: DEPARTS AS BRIEFED	CAN	ATK 1	ASS 6 AND EUD 1	0920 / 1420	DATA: (POSITION REPORT)
50	EUD 1 REQUEST HOVER INSTRUCTIONS FOR PZ OP'S , DIRECT TO RUNWAY 15	APEX GROUND	EUD 1	APEX GROUND	0922 / 1422	VOICE
60	APEX GRND: EUD 1 AND FLT, HOVER TAXI FOR PZ OP'S , THEN PROCEED TO RUNWAY 15 AND CONTACT TWR	APEX GROUND	APEX GROUND	EUD 1	0922 / 1422	VOICE
70	EUD 1: APEX GRND , EUD 1 ROGER.	APEX GROUND	EUD 1	APEX GROUND	0922 / 1422	VOICE
80	EUD 1: APEX TWR, EUD 1 SHORT OF RUNWAY 15 REQUEST HOVER TAXI ONTO THE RUNWAY.	APEX TWR	EUD 1	APEX TWR	0925 / 1425	VOICE
90	APEX TWR: EUD 1 AND FLT HOVER TAXI ONTO RUNWAY 15 , ADVISE WHEN READY FOR DEPART	APEX TWR	APEX TWR	EUD 1	0926 / 1426	VOICE

YOU GOT MAIL

C2 AIRCRAFT  
ICON FOR 30 SECONDS

ATK AIRCRAFT  
ICON FOR 30 SEC'S.

100	EUD 1: EUD 1 ROGER.	APEX TWR	EUD 1	APEX TWR	0927 / 1427	VOICE
110	EUD 1 REQUEST DEPARTURE/ TAKE OFF INSTRUCTION	APEX TWR	EUD 1	APEX TWR	0928 / 1428	VOICE
120	APEX TWR: EUD 1 AND FLT, APEX TWR, WIND 060/10, CLEARED FOR TAKE OFF.	APEX TWR	APEX TWR	EUD 1	0930 / 1430	VOICE
130	EUD 1: EUD 1 DEPARTS	CAN	EUD 1	ASS 6	0930 / 1430	DATA (POS. REPORT)
140	REDLEG 6: SEAD COMP. 1 MINUTE PRIOR TO RP	CAN	REDLEG 6	EUD1 AND ASS	0940 / 1440	DATA (FREE TEXT) SEAD COMPLETE
150	EUD 1: REPORT RP.	CAN	EUD 1	ASS 6	0940 / 1440	DATA (POS. REPORT)
160	ASS. 6: SENDS REQUESTED ACKNOWLEDGEMENT FROM EUD 1	CAN	ASS 6	EUD 1	0941 / 1441	DATA (ACKNOWLEDGEMENT)
170	EUD 1: REPORT DEPART THE LZ	CAN	EUD 1	ASS 6	0942 / 1442	DATA (POS. REPORT)
180	EUD 1: REPORT LEFT BASE FOR LANDING 15, DIRECT TO THE FARP.	APEX TWR	EUD 1	APEX TWR	0948/1448	VOICE

SEAD COMPLETE MESSAGE SENT.

EUD 1 RECEIVES MESSAGE ACK'ED ON THE SND STATUS PAGE

190	EUD 1: ARRIVES AT THE PZ/ AA	CAN	EUD 1	ASS 6	0949 / 1449	DATA (POS. REPORT)
200	EUD 1 REQUEST HOVER TAXI TO RWY 15 FOR DEPARTURE	APEX TWR	EUD 1	APEX TWR	0958 / 1458	VOICE
210	APEX TWR: CLEAR TO HOVER TAXI ONTO RWY 15, ADVISE WHEN READY FOR DEPARTURE	APEX TWR	APEX TWR	EUD 1	1000 / 1500	VOICE
220	APEX TWR: EUD 1 AND FLT, APEX TWR, WIND 060/10, CLEARED FOR TAKE OFF.	APEX TWR	APEX TWR	EUD 1	1000 / 1500	VOICE
230	EUD 1 REQUEST DEPARTURE/ TAKE OFF INSTRUCTION	APEX TWR	EUD 1	APEX TWR	0953 / 1453	VOICE
240	EUD 1: EUD 1 DEPARTS	CAN	EUD 1	ASS 6	0955 / 1455	DATA (POS. REPORT)
250	EUD 1: REPORT RP.	CAN	EUD 1	ASS 6	1005 / 1505	DATA (POS. REPORT)
260	EUD 1: REPORT ARRIVAL AT THE LZ	CAN	EUD 1	ASS 6	1006 / 1506	DATA (POS. REPORT)

270	EUD 1: REPORT DEPARTING THE LZ	CAN	EUD 1	ASS 6	1006 / 1506	DATA (POS. REPORT)
280	EUD 1: REPORT LEFT BASE FOR LANDING 15, DIRECT TO THE FARP.	APEX TWR	EUD 1	APEX TWR	1024 / 1524	VOICE
290	APEX TWR: EUD 1 AND FLT, APEX TWR, WIND 060/10, CLEARED FOR LANDING.	APEX TWR	APEX TWR	EUD 1	1024 / 1524	VOICE
300	EUD 1: ARRIVES PARKING EOM, AAR	CAN	EUD 1	ASS 6	1014 / 1514	N/A

Execution Checklist – Controllers Only

270A	1 HYD SYSTEM FAIL.					HYDRAULIC FAILURE:
------	--------------------	--	--	--	--	--------------------

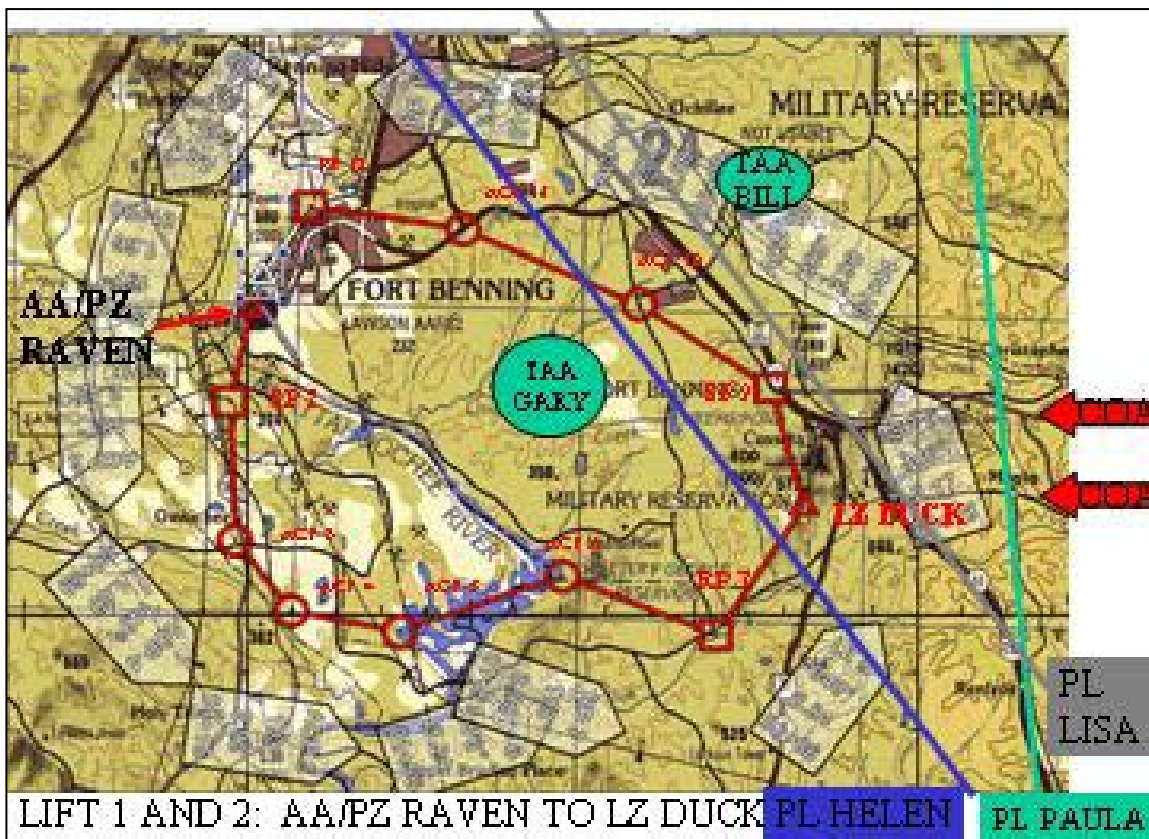
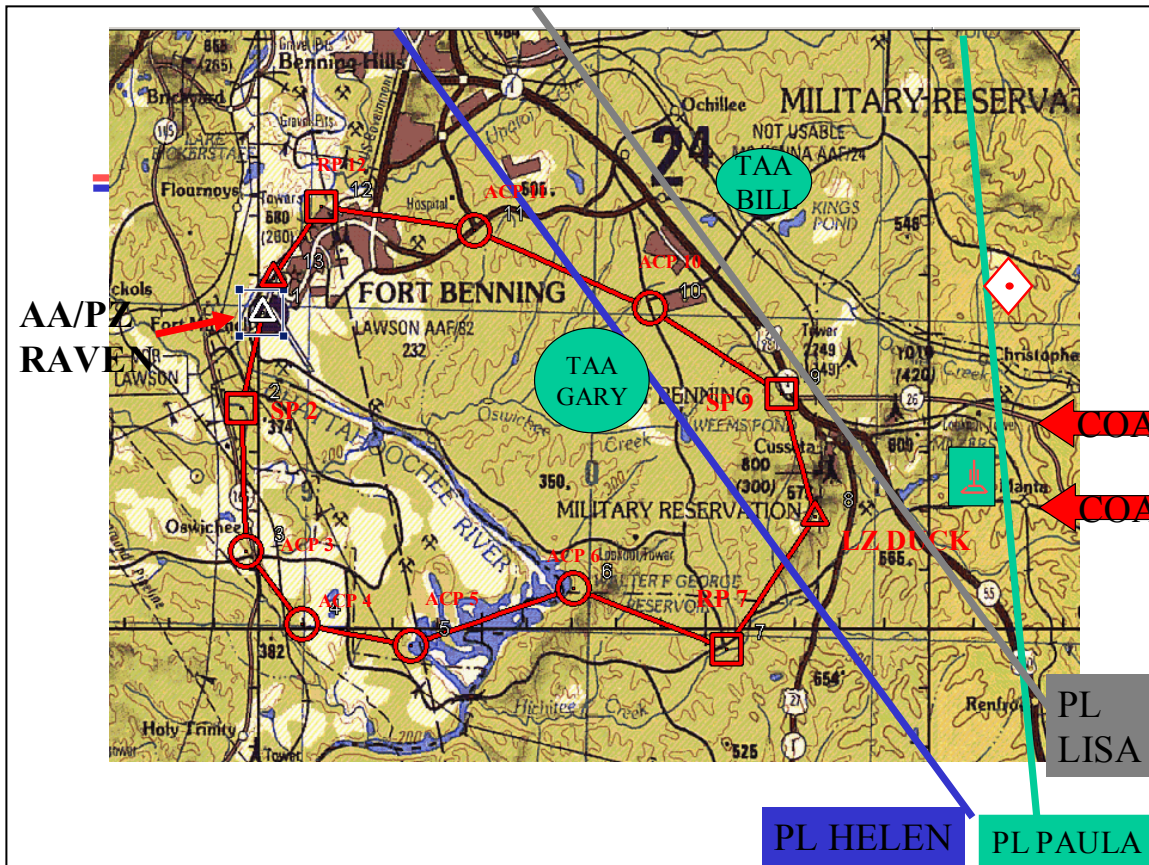



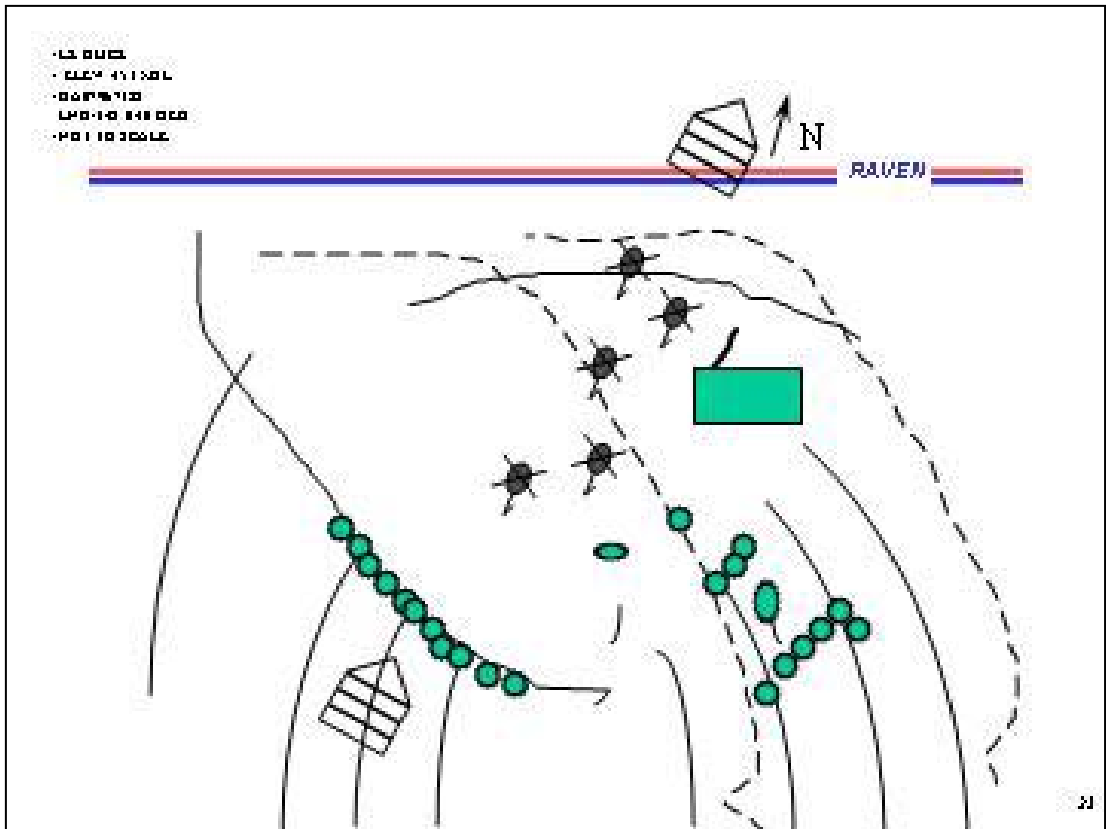

---

## Appendix L. Summary of Crew Workload Ratings and Comments

---

<b>Task No.</b>	<b>Flight and Mission Tasks</b>	<b>UH-60A/L Workload</b>	<b>UH-60M Workload</b>
1014	Maintain Airspace Surveillance	2.00	2.90
1017	Perform Hovering Flight	1.30	1.40
1018	Perform VMC Takeoff	1.67	2.00
1023	Perform Fuel Management Procedures	2.27	1.67
1025	Navigate by Pilotage and Dead Reckoning	3.50	3.18
1026	Perform Electronically Aided Navigation	3.45	2.64
1028	Perform VMC Approach	1.67	3.25
1068	Perform Emergency Procedures	2.86	2.50
1076	Perform Radio Navigation	2.83	4.14
1077	Perform Holding Procedures	1.00	3.17
1079	Perform Radio Communication Procedures	2.70	1.00
1080	Perform Procedures for Two-Way Radio Failure	2.60	2.60
1081	Perform Nonprecision Approach	1.75	2.80
1082	Perform Precision Approach	4.67	1.50
1083	Perform Inadvertent IMC Procedures	2.00	4.00
1084	Perform Command Instrument System Operations	2.40	2.88
1135	Perform Instrument Maneuvers	1.50	3.20
1146	Perform VMC Flight Maneuvers	1.56	1.50
1150	Select Landing Zone/Pickup Zone	2.36	1.56
2008	Perform Evasive Maneuvers	2.14	2.73
2009	Perform Multi-Aircraft Operations	2.29	2.00
2044	Perform Actions on Contact	2.78	2.14
2078	Perform Terrain Flight Mission Planning	3.00	2.56
2079	Perform Terrain Flight Navigation	3.64	2.64
2081	Perform Terrain Flight	2.56	2.22
2083	Negotiate Wire Obstacles	2.14	1.43
2086	Perform Masking and Unmasking	1.00	1.00
2090	Perform Tactical Communication Procedures	3.00	3.89
2091	Transmit Tactical Reports	3.38	4.00

**If you gave a workload rating of '6' or higher for any task in the UH-60M, explain why the workload was high for the task.**

(1026) I do not like the Auto/Early feature during navigation that causes the nav needle to go to the next waypoint when within close proximity of landing area. Could be very confusing in a high stress multi-ship NVG flight. (C5700, Right Seat, Trial 1)

(1023) In the A/L, total fuel including aux fuel is available with any button presses. In the 60M, the EICAS page must be brought up to see aux fuel. (B4069, Right Seat, Trial 2)

(1026) DigMap makes electronic aided navigation trivial (B4069, Right Seat, Trial 2)

(1076) Radio nav could be easier in the 60M if nav aids appeared on the digmap (B4069, Right Seat, Trial 2)

(1083) DigMap gives awareness of known obstacles and aircraft location (B4069, Right Seat, Trial 2)

(1084) Lack of training on the FDDCP to bring up desired information on the PFD (B4069, Right Seat, Trial 2)

(2044, 2090, 2091) Spot reports generate more workload when they are sent JVMF versus voice (B4069, Right Seat, Trial 2)

(2079) DigMap makes it easy (B4069, Right Seat, Trial 2)

(No task associated) FDDCP: need a class on its use and functions (M7273, Left Seat, Trial 2)

(1079) Having all freqs pre-programmed into the FMS made this task easier (B4069, Left Seat, Trial 3)

(1084) Familiarity with the FDDCP is making this easier with time (B4069, Left Seat, Trial 3)

(2044, 2090, 2091) The head-down nature of free text reports makes for a high workload. This should get better once additional features, such as spot reports, implemented.

Did not feel I could divert my time from cockpit (C5700, Left Seat, Trial 4)

Sim is not good enough for this [task] (C5700, Left Seat, Trial 4)

(1026, 1084) Did not understand how to operate the FDDCP (C5700, Left Seat, Trial 4)

(1079) Sim is barrier to using equipment (C5700, Left Seat, Trial 4)

(1150) Sim limitation (C5700, Left Seat, Trial 4)

(2079) Sim limitation (C5700, Left Seat, Trial 4)

(2090, 2091) JVMF was too hard to do (C5700, Left Seat, Trial 4)

(C5700, Left Seat, Trial 4) Asked other crewmember to do fuel check

(2044, 2091) JVMF is cumbersome (B4069, Left Seat, Trial 6)

## Appendix M. Summary of Crew SA Ratings and Comments

Reported Raw Scores on SART

ACFT TYPE	TRIAL	SEAT	Inst	Varia	Compl	Arou	Spare	Conc	Divi	Quant	Qual	Famil	DEMAND	SUPPLY	UNDER	SA
UH-60A/L	1	Left	6	3	4	3	5	6	3	6	6	6	13	17	18	22
UH-60M	1	Left	4	6	6	7	6	3	3	6	6	2	16	19	14	17
UH-60A/L	1	Right	4	4	4	5	5	5	4	2	4	6	12	19	12	19
UH-60M	1	Right	6	6	7	6	2	6	6	1	2	2	19	20	5	6
UH-60A/L	2	Left	3	2	3	4	4	4	3	5	5	6	8	15	16	23
UH-60M	2	Left	3	3	3	5	5	6	5	5	5	5	9	21	15	27
UH-60A/L	2	Right	4	3	3	6	5	5	5	2	3	3	10	21	8	19
UH-60M	2	Right	4	3	3	6	6	5	5	4	5	3	10	22	12	24
UH-60A/L	3	Left	4	4	5	6	4	5	3	2	3	5	13	18	10	15
UH-60M	3	Left	4	4	5	6	5	6	4	4	3	4	13	21	11	19
UH-60A/L	3	Right	2	2	2	3	2	4	4	3	3	2	6	13	8	15
UH-60M	3	Right	2	2	2	3	2	2	1	2	2	2	6	8	6	8
UH-60A/L	4	Left	4	4	4	4	4	4	4	6	6	6	12	16	18	22
UH-60M	4	Left	3	2	3	5	6	6	5	6	6	6	8	22	18	32
UH-60A/L	4	Right	3	2	3	5	6	6	5	6	6	6	8	22	18	32
UH-60M	4	Right	3	3	3	5	5	6	5	5	6	5	9	21	16	28
UH-60A/L	5	Left	5	4	4	5	6	6	6	6	6	6	13	23	18	28
UH-60M	5	Left	2	5	4	5	4	4	4	7	7	7	11	17	21	27
UH-60A/L	5	Right	2	2	3	5	6	6	5	5	5	5	7	22	15	30
UH-60M	5	Right	3	2	2	6	6	6	6	5	6	5	7	24	16	33
UH-60A/L	6	Left	3	3	4	3	2	2	2	7	7	7	10	9	21	20
UH-60M	6	Left	4	4	4	6	2	7	7	7	2	1	12	22	10	20
UH-60A/L	6	Right	5	5	4	6	5	5	3	2	4	6	14	19	12	17
UH-60M	6	Right	5	5	4	6	6	6	5	5	3	5	14	23	13	22

DEMAND = Instability + Variability + Complexity

SUPPLY = Arousal + Spare Mental Capacity + Concentration  
+ Division of Attention

UNDERSTANDING = Information Quantity + Information  
Quality + Familiarity

- Especially during IMC portion of flight (C5700, Trial 1, Right Seat)
- Location of enemy/friendly forces did not appear on digmap; therefore, SA on them didn't change since the update brief (B4069, Trial 2, Right Seat)
- (Sim problem) It seemed that the device moved much more quickly across the ground which drew my attention away from other tasks (M7273, Trial 2, Left Seat)
- I believe some training on the FDDCP would be helpful in the future (M7273, Trial 2, Left Seat)
- The difference between the ND and DigMap led me to question the information quality (B4069, Left Seat, Trial 3)
- Not having the enemy/friendly forces depict on the DigMap lowered SA. Ditto for other aircraft (B4069, Left Seat, Trial 3)
- (Sim problem) Problems with flight model (varying airspeeds and faulty FPS Trim) had me tied up almost entirely. Continued my primary task (flying) to meet +/- 30 sec standard on the LZ, but at the cost of all other awareness. (W4407, Trial 3, Right Seat)
- Just about the whole mission I felt 'out of it'. (C5700, Left Seat, Trial 4)
- Info Quality: Acft position on ND was inaccurate (B4069, left seat, trial 6)  
Friendly/enemy positions not implemented on digmap (B4069, left seat, trial 6)

---

## Appendix N. Summary of TSC Comments

---

### Workload

- CP overly focused inside performing comm management during critical phase (landing). Training is a factor (familiarity with message processing), but JVMF system and TTP must be simplified (Obs 1, Trial 1)
- JVMF reversionary not clear [enough] to get attention (Obs 2, Trial 1)
- FDDCP functionality not clear enough (Obs 2, Trial 1)
- FMS – localizer select (freq) not clear on how to input (Obs 2, Trial 1)
- Workload not an issue at either position (Obs 1, Trial 3)
- System management and messaging duties took all of CP’s attention (Obs 1, Trial 4)
- Left seater wasn’t trained on how FMS operating, shooting workload up (Obs 2, Trial 4)
- ND map didn’t give accurate data, causing confusion on location during the mission. Tactical SA lost. Right seat was unable to provide proper crew coordination (Obs 2, Trial 4)
- First fully successful execution of doctrinal Air Assault in the fully digital cockpit. Now [that] we know it can be done we need to work improvement of system to enhance SA. #1 issue – how to keep CP ‘heads up’ while doing digital messaging (Obs 1, Trial 5)
- Discounting overweight rotor-droop resulting in crash [occurred 2 min after T/O from PZ], overall good mission. Reaffirms Trial 5 data that this cockpit is effective in today’s Air Assault environment (Obs 1, Trial 6)

### Crew Coordination

- CP focused inside during LZ landing doing position reporting [JVMF] (Obs 1, Trial 1)
- Mission went like clockwork (Obs 1, Trial 1)
- Messaging tasks still have a tendency to pull CP inside during critical tasks (landing at LZ) but can be a non-issue with TTP on “inside-outside” duties and good crew coordination (Obs 1, Trial 3)
- When CP got busy his aircrew coordination stopped (Obs 1, Trial 4)
- No ACC achieved because of tactical SA confusion by the displayed info (Obs 2, Trial 4)

### SA

- SA was not challenging. Simple mission. Increased SA requirement (threat, environment, etc.) would likely have been a problem. Need to do more to keep both pilots ‘heads up and outside’ (Obs 1, Trial 1)
- Something drove the P to take off the wrong direction (Obs 2, Trial 1)
- FMS functionality for inputting points hard (Obs 2, Trial 1)
- Position report needs to be more automatic (Obs 2, Trial 1)
- FDDCP needs more training, no SA available (Obs 2, Trial 1)
- Unable to sequence the next waypoint when not within the parameters (Obs 2, Trial 2)
- Acknowledgement of arrival at the RP (from Assault 6) was not intuitive. Message status was checked in the inbox, not xmit status page (Obs 2, Trial 2)
- ILS unable to capture, turned approach into LOC only (Obs 2, Trial 2)
- P\* had some difficulties managing aircraft airspeed and attitude. Suspect P\* misinterpreting rate-of-turn indicator for slip indicator. Problem ID’ed early in PFD development may need to be

re-looked. Management of airspeed and attitude may be an issue related to APEX integration (Obs 1, Trial 3)

- JVMF functionality caused confusion of message sent or not (Obs 2, Trial 3)
- JVMF functionality caused free text to not be transmitted with data (Obs 2, Trial 3)
- I still think flying pilot confused on turn needle and trim indicator (Obs 2, Trial 3)
- CP understanding of display features (Obs 1, Trial 4)
- No SA available or incorrect data provided causing confusion (Obs 2, Trial 4)
- APEX-related: lack of nav cueing due to APX limitations. No effect of mission execution. Aircrew was able to transition to digmap and visual nav w/o any degradation to mission (Obs 1, Trial 5)
- Perceived location not able to be validated without the use of a better scale map (1:50,000 and below). (Obs 2, Trial 5)
- Not having HSI indication drove the non-flying pilot back to the paper time, distance, and heading kneeboard packet. A clock on the instrument panel was needed to support this task. We need to capture a clock on the PFD page (Obs 2, Trial 5)
- CP opted to not display PFD. This may have delayed recognition of rotor droop and timely corrective action (Obs 1, Trial 6)
- Power pod [displayed] on pilot side only, nonflying pilot had no SA of engines at a critical time (Obs 2, Trial 6)

### **Mission Successful**

- Unable to complete ILS (Obs 2, Trial 1)

---

## Appendix O. Summary of Pilot Ratings and Comments About the PVI

---

### *PVI*

- Getting used to symbology and learning new crosscheck on PFD. Did not have good situational awareness during instrument recovery. Did not know where I was in space. (C5700, Trial 1)
- Everything I checked YES to was because I am not proficient with the equipment. Instead of reaching forward to JVMF I would like to be able to sit back with my hand on the MFSC and scroll and click. Reaching up to touch things brings me in the cockpit too much. I can continue to scan outside while using the MFSC. I think TQ #'s need to be bigger, or it may just take awhile to get used to. The barometric Altimeter is different than any altimeter out there. The other things will just take time to get proficient. (W4407, Trial 1)
- During the limitation's brief were told that the FMS direct function didn't work and that the system would be set to Auto-Early. During the mission, the FMS did not update to the next waypoint. (B4069, Trial 2)
- Since the FDDCP was installed just last night we received no training on it and our lack of understanding showed during the mission. (B4069, Trial 2)
- On the PFD page the fuel did not change. (M7237, Trial 2)
- Need a tactical map for ID of LZ in objective area. (M7237, Trial 2)
- Need to be able to get back onto FLT plan if the NAV is off slightly to get the system to work. (M7237, Trial 2)
- FDDCP (I need a class on its use!) (M7237, Trial 2)
- NAV display did not match DIGMAP or outside view. JVMF free text area remained from one MSG to the next unless manually cleared. (B4069, Trial 3)
- The ND page did not show the aircraft's correct position in relation to the course and was opposite of the DIGMAP. (M7273, Trial 4)
- While trying to fly direct to the second LZ after entering "Direct To" I received correct distance and bearing info but incorrect bearing pointer info. (M7273, Trial 4)
- Most of the JVMF problems were simulator related, but overall use was ridiculous and terrible. The word sucks comes to mind. (C5700, Trial 4)
- JVMF: Forgot how to do free text (W4407 – Trial 5 – Left Seat)
- Radio Nav: simulation problem (W4407 – Trial 5 – Left Seat)
- FDDCP: was unfamiliar with a few switches when arming it to FMS (W4407 – Trial 5)
- FDDCP: I think [the difficulties are] still just a training issue (M7237 – Trial 5 – Right Seat)
- The aircraft symbol on the ND was displaced right making it appear as if we were right of course when we weren't (B4069 – Trial 6 – Left Seat)
- The caution/advisory pop-up window did not appear on the DigMap or ND pages (B4069 – Trial 6 – Left Seat)
- On the JVMF page, there is no Return or Back key to allow you to send another message once one is sent without leaving the JVMF page then returning to it (B4069 – Trial 6 – Left Seat)
- When entering free text on a JVMF position report, the Enter key did not send the text up to the MFD (B4069 – Trial 6 – Left Seat)
- When a JVMF message is set-up but not sent, the FMS is stuck on free text entry (B4069 – Trial 6 – Left Seat)

- The FMS will not navigate to the last item in the flight plan (B4069 – Trial 6 – Left Seat)
- The DigMap show different symbols for the waypoints (i.e. RP, LZ, ACP), but there is no way it should know which was which. (B4069 – Trial 6 – Left Seat)

### **PV2**

- Symbology changes made crosscheck slow (C5700, Trial 1)
- FMS is good, just take some time to get proficient. JVMF is confusing on what I am sending or receiving once again it's proficiency. (W4407, Trial 1)
- I just need practice on the use of the FMS/JVMF messaging; my speed increased greatly w/ each use. (M7237, Trial 2)
- Will the DIGMAP have label and how did it know what symbols to use for each point. (M7237, Trial 2)
- The ability to use the MFSC to select the JVMF drop down list items will speed entry. (B4069, Trial 3)
- I thought it was easier to recognize JVMF traffic from the right seat vs. my flight yesterday in the left. (M7273, Trial 4)
- See previous response to JVMF. (C5700, Trial 4)
- The JVMF page isn't laid out intuitively like the other pages. It's as if it were cut and pasted from a ground system (B4069 – Trial 6 – Left Seat)

### **PV3**

- JVMF is just gonna take awhile to get used to. (W4407, Trial 1)
- Overall not used to the buttons, and often they seemed to have simulator related problems. (C5700, Trial 4)
- JVMF is not intuitive but my use of it is getting better as I get more experience with it (B4069 – Trial 6 – Left Seat)

### **PV5**

- Did not use. (C5700, Trial 4)

### **PV6**

- ND – Aircraft symbol too big (C5700, Trial 1)
- DMS –Aircraft symbol too big (C5700, Trial 1)
- Everything is too small! (W4407, Trial 1)
- The DIGMAP showed different symbols for LZ's, ACP, and RP's. How did it know which was which. We did not enter anything to differentiate them. (B4069, Trial 2)
- On the DMS the course line was not as identifiable as I thought it would be and could be misinterpreted as a set of wires. Might see if the course could be outlined or change color. (M7273, Trial 4)
- The green on the DIGMAP was difficult to read i.e. SP7, LZ4, etc...(M7273, Trial 4)
- I don't know how the DigMap knew which waypoints were RPs and which were ACPs and LZs (B4069 – Trial 6 – Left Seat)

### **PV7**

- ND-Plan: Very busy page with the ACPs bunched together (W4407 – Trial 5 – Left Seat)

### **PV8**

- Collective: finger used for trim on collective (C5700 – Trial 6 – Right Seat)

### **PV9**

- I need a little more time to learn this system. (W4407, Trial 1)
- Free text entry was difficult in that I am not yet familiar with the FMS keypad layout. That should improve with time; however, free text entry will remain a heads down time consuming event. (B4069, Trial 3)
- This is sorry in my opinion. This needs a key dedicated to it. Too many pages and buttons to accomplish this task. (C5700, Trial 4)
- Free-Text JVMF Message: it takes quite a lot of time and steps, and keeps you inside the cockpit too long (W4407 – Trial 5 – Left Seat)
- JVMF page is not intuitive and free text is a time consuming, head-down function (B4069 – Trial 6 – Left Seat)

### **PV10**

- Power Pod NR symbol way too big (C5700, Trial 1)
- Would really like TGT reading on PWR Pod (C5700, Trial 1)
- JVMF took awhile to notice! (W4407, Trial 1)
- Again everything was too small. (W4407, Trial 1)
- JVMF: If pilot is distracted with other tasks, the JVMF label changing to inverse video is easy to miss. (B4069, Trial 2)
- Power Pod not directly in front of me need to work into my scan. (W4407, Trial 3)
- The JVMF symbol turning inverse video is not a sufficient annunciator of an arriving message. Also, there is no distinction between incoming messages and acknowledgements so you don't know which to check. (B4069, Trial 3)
- Non flying on Power Pod C /A and Master. Never knew if I really sent my message on any that I sent. (C5700, Trial 4)
- Inverse video is not sufficient annunciation (B4069 – Trial 6 – Left Seat)
- DigMap and ND caution pop-ups were not working; we missed an overtorque occurrence that led to a low rotor and eventual crash (B4069 – Trial 6 – Left Seat)
- C/A – not used to layout (C5700 – Trial 6 – Right Seat)
- Power Pod – unknown when limits were exceeded (C5700 – Trial 6 – Right Seat)

INTENTIONALLY LEFT BLANK

---

## Acronyms

---

AAR	after-action review
ACP	air control point
AMRDEC	Aviation & Missile Research, Development, and Engineering Center
APEX	Advanced Prototyping, Engineering, and eXperimentation
ARL	U.S. Army Research Laboratory
ATM	air crew training manual
BHIVE	battlefield highly immersive virtual environment
BWRS	Bedford Workload Rating Scale
CASEVAC	casualty evacuation
COTS	commercial off-the-shelf
CP	co-pilot
CPC	Comache portable cockpit
CPT	Captain
CW3	Chief Warrant Officer 3
CW4	Chief Warrant Officer 4
CW5	Chief Warrant Officer 5
DCD	Directorate of Combat Development
DigMap	digital mapping system
DOF	degrees of freedom
DIS	distributed interactive simulation
EDS	engineering development simulator
EICAS	engine instrument caution advisory system
EUD	early user demonstration
FD/DCP	flight director/digital control panel
FM	frequency modulation
FMS	flight management system
FOV	field of view
HFE	human factors engineering
HLA	high-level architecture
HMD	helmet-mounted display
ILS	instrument landing system
IMC	instrument meteorological conditions
JVMF	joint variable message format

LRSD	long range surveillance detachment
LUT	limited user test
LZ	landing zone
M&S	modeling and simulation
MEDEVAC	medical evacuation
MFD	multi-function display
MFSC	multi-function slew controller
ModSAF	Modular Semi-Automated Forces
ND	navigational display
OPORD	operations order
OTW	out the window
PFD	primary flight display
PIC	pilot in command
PM	project manager
PMO	Project Manager's Office
PVI	pilot-vehicle interface
PZ	pickup zone
RP	release point
SA	situational awareness
SAC	Sikorsky Aircraft Corporation
SAIC	Science Applications International Corporation
SART	situational awareness rating technique
SIL	systems integration lab
SMEs	subject matter experts
SP	starting point
SSQ	simulator sickness questionnaire
TSC	tactical steering committee
TTP	tactics, techniques, and procedures
UH	utility helicopter
USAAVNC	United States Army Aviation Center
VMC	visual meteorological conditions
VOR	VHF omnidirectional range
WSRT	Wilcoxon Signed Ranks Test

<u>NO. OF COPIES</u>	<u>ORGANIZATION</u>	<u>NO. OF COPIES</u>	<u>ORGANIZATION</u>
* 1	ADMINISTRATOR DEFENSE TECHNICAL INFO CTR ATTN DTIC OCA 8725 JOHN J KINGMAN RD STE 0944 FT BELVOIR VA 22060-6218 *pdf file only	1	ARMY RSCH LABORATORY - HRED ATTN AMSRD ARL HR MG R SPINE BUILDING 333 PICATINNY ARSENAL NJ 07806-5000
1	DIRECTOR US ARMY RSCH LABORATORY ATTN IMNE ALC IMS MAIL & REC MGMT 2800 POWDER MILL RD ADELPHI MD 20783-1197	1	ARMY RSCH LABORATORY - HRED ATTN AMSRD ARL HR MH C BURNS BLDG 1002 ROOM 117 1ST CAVALRY REGIMENT RD FT KNOX KY 40121
1	DIRECTOR US ARMY RSCH LABORATORY ATTN AMSRD ARL CI OK TL TECH LIB 2800 POWDER MILL RD ADELPHI MD 20783-1197	1	ARMY RSCH LABORATORY - HRED AVNC FIELD ELEMENT ATTN AMSRD ARL HR MJ D DURBIN BLDG 4506 (DCD) RM 107 FT RUCKER AL 36362-5000
1	ARMY RSCH LABORATORY - HRED ATTN AMSRD ARL HR M DR M STRUB 6359 WALKER LANE SUITE 100 ALEXANDRIA VA 22310	1	ARMY RSCH LABORATORY - HRED ATTN AMSRD ARL HR MK MR J REINHART 10125 KINGMAN RD FT BELVOIR VA 22060-5828
1	ARMY RSCH LABORATORY - HRED ATTN AMSRD ARL HR MA J MARTIN MYER CENTER RM 2D311 FT MONMOUTH NJ 07703-5630	1	ARMY RSCH LABORATORY - HRED ATTN AMSRD ARL HR MV HQ USAOTC S MIDDLEBROOKS 91012 STATION AVE ROOM 111 FT HOOD TX 76544-5073
1	ARMY RSCH LABORATORY - HRED ATTN AMSRD ARL HR MC A DAVISON 320 MANSCEN LOOP STE 166 FT LEONARD WOOD MO 65473-8929	1	ARMY RSCH LABORATORY - HRED ATTN AMSRD ARL HR MY M BARNES 2520 HEALY AVE STE 1172 BLDG 51005 FT HUACHUCA AZ 85613-7069
1	ARMY RSCH LABORATORY - HRED ATTN AMSRD ARL HR MD T COOK BLDG 5400 RM C242 REDSTONE ARSENAL AL 35898-7290	1	ARMY RSCH LABORATORY - HRED ATTN AMSRD ARL HR MP D UNGVARSKY BATTLE CMD BATTLE LAB 415 SHERMAN AVE UNIT 3 FT LEAVENWORTH KS 66027-2326
1	COMMANDANT USAADASCH ATTN ATSA CD ATTN AMSRD ARL HR ME MS A MARES 5800 CARTER RD FT BLISS TX 79916-3802	1	ARMY RSCH LABORATORY - HRED ATTN AMSRD ARL HR M DR B KNAPP ARMY G1 MANPRINT DAPE MR 300 ARMY PENTAGON ROOM 2C489 WASHINGTON DC 20310-0300
1	ARMY RSCH LABORATORY - HRED ATTN AMSRD ARL HR MI J MINNINGER BLDG 5400 RM C242 REDSTONE ARSENAL AL 35898-7290	1	ARMY RSCH LABORATORY - HRED ATTN AMSRD ARL HR MJK MS D BARNETTE JFCOM JOINT EXPERIMENTATION J9 JOINT FUTURES LAB 115 LAKEVIEW PARKWAY SUITE B SUFFOLK VA 23435
1	ARMY RSCH LABORATORY - HRED ATTN AMSRD ARL HR MM DR V RICE BLDG 4011 RM 217 1750 GREELEY RD FT SAM HOUSTON TX 78234-5094	1	ARMY RSCH LABORATORY - HRED ATTN AMSRD ARL HR MT DR J CHEN 12350 RESEARCH PARKWAY ORLANDO FL 32826-3276

<u>NO. OF COPIES</u>	<u>ORGANIZATION</u>	<u>NO. OF COPIES</u>	<u>ORGANIZATION</u>
1	ARMY RSCH LABORATORY - HRED ATTN AMSRD ARL HR MQ M R FLETCHER US ARMY SBCCOM NATICK SOLDIER CTR AMSRD NSC SS E BLDG 3 RM 341 NATICK MA 01760-5020	1	US ARMY AVIATION & MISSILE CMD ATTN AMSA RD SS AV W NIKONCHUK BLDG 5400 SSDD AV REDSTONE ARSENAL AL 35989-0001
			<u>ABERDEEN PROVING GROUND</u>
1	ARMY RSCH LABORATORY - HRED ATTN AMSRD ARL HR MS MR C MANASCO SIGNAL TOWERS RM 303A FORT GORDON GA 30905-5233	1	DIRECTOR US ARMY RSCH LABORATORY ATTN AMSRD ARL CI OK (TECH LIB) BLDG 4600
1	ARMY RSCH LABORATORY - HRED ATTN AMSRD ARL HR MU M SINGAPORE 6501 E 11 MILE RD MAIL STOP 284 BLDG 200A 2ND FL RM 2104 WARREN MI 48397-5000	1	US ATEC RYAN BLDG APG-AA
1	ARMY RSCH LABORATORY - HRED ATTN AMSRD ARL HR MF MR C HERNANDEZ BLDG 3040 RM 220 FORT SILL OK 73503-5600	1	DIRECTOR US ARMY RSCH LABORATORY ATTN AMSRD ARL CI OK TP S FOPPIANO BLDG 459
1	ARMY RSCH LABORATORY - HRED ATTN AMSRD ARL HR MW E REDDEN BLDG 4 ROOM 332 FT BENNING GA 31905-5400	1	DIRECTOR US ARMY RSCH LABORATORY ATTN AMSRD ARL HR MR F PARAGALLO BLDG 459
1	ARMY RSCH LABORATORY - HRED ATTN AMSRD ARL HR MN R SPENCER DCSFDI HF HQ USASOC BLDG E2929 FORT BRAGG NC 28310-5000	1	DIRECTOR US ARMY RSCH LABORATORY ATTN AMSRD ARL HR MB J HAWLEY BLDG 459
1	DR THOMAS M COOK ARL-HRED LIAISON PHYSICAL SCIENCES LAB PO BOX 30002 LAS CRUCES NM 88003-8002	1	DIRECTOR US ARMY RSCH LABORATORY ATTN AMSRD ARL HR MR T HADUCH BLDG 459
1	TSM UTILITY/CARGO USAAVNC CDR US ARMY AVIATION CTR ATTN ATZQ TSM L (CW3 J D SMITH) BDLG 4506 JOKER ST (DCD) FT RUCKER AL 36362-5000	1	DIRECTOR US ARMY RSCH LABORATORY ATTN AMSRD ARL HR SE S HILL BLDG 459
1	PRODUCT MGR UH-60M ATTN SFAE AV UH M (LTC R LUNN) PROJECT EXECUTIVE OFC AVIATION REDSTONE ARSENAL AL 35898-5000		
1	CDR US ARMY AVIATION RDEC ATTN AMSRD AMR AE S C (A MANCE) BLDG 4488 REDSTONE ARSENAL AL 35898-5000		