



AFRL-ML-TY-TR-2004-4557



Optimization of an Innovative Biofiltration System As a VOC Control Technology For Aircraft Painting Facilities

Final Report—SERDP Project CP 1104

Kerry A. Kinney
University of Texas at Austin
J.J. Pickle Research Campus
1000 Burnet Road
Austin, TX 78758-4423

William M. Moe
Dept. of Civil & Environmental Engineering
Louisiana State University
Baton Rouge, LA 70803-6405

Approved for Public Release; Distribution Unlimited

**AIR FORCE RESEARCH LABORATORY
MATERIALS & MANUFACTURING DIRECTORATE
AIR EXPEDITIONARY FORCES TECHNOLOGIES DIVISION
139 BARNES DRIVE, SUITE 2
TYNDALL AFB, FL 32403-5323**

NOTICES

USING GOVERNMENT DRAWINGS, SPECIFICATIONS, OR OTHER DATA INCLUDED IN THIS DOCUMENT FOR ANY PURPOSE OTHER THAN GOVERNMENT PROCUREMENT DOES NOT IN ANY WAY OBLIGATE THE US GOVERNMENT. THE FACT THAT THE GOVERNMENT FORMULATED OR SUPPLIED THE DRAWINGS, SPECIFICATIONS, OR OTHER DATA DOES NOT LICENSE THE HOLDER OR ANY OTHER PERSON OR CORPORATION; OR CONVEY ANY RIGHTS OR PERMISSION TO MANUFACTURE, USE, OR SELL ANY PATENTED INVENTION THAT MAY RELATE TO THEM.

THIS TECHNICAL PAPER HAS BEEN REVIEWED AND IS APPROVED FOR PUBLICATION. COPIES ARE ALSO AVAILABLE FROM WWW.SERDP.ORG

/s/

JOSEPH D. WANDER, Ph.D
Program Manager

/s/

JIMMY L. POLLARD., Colonel, USAF
Chief, Airbase Technologies Division

This report is published in the interest of scientific and technical information exchange and does not constitute approval or disapproval of its ideas or findings.

Do not return copies of this report unless contractual obligations or notice on a specific document requires its return.

REPORT DOCUMENTATION PAGE			Form Approved OMB No. 0704-0188	
Public reporting burden for this collection of information is estimated to average 1 hour per response, including the time for reviewing instructions, searching existing data sources, gathering and maintaining the data needed, and completing and reviewing the collection of information. Send comments regarding this burden estimate or any other aspect of this collection of information, including suggestions for reducing this burden, to Washington Headquarters Services, Directorate for Information Operations and Reports, 1215 Jefferson Davis Highway, Suite 1204, Arlington, VA 22202-4302, and to the Office of Management and Budget, Paperwork Reduction Project (0704-0188), Washington, DC 20503.				
1. AGENCY USE ONLY (Leave blank)	2. REPORT DATE 20 Apr 2004	3. REPORT TYPE AND DATES COVERED Final Report May 1998–April 2004		
4. TITLE AND SUBTITLE Optimization of an Innovative Biofiltration System as a VOC Control Technology for Aircraft Painting Facilities Final Report—SERDP Project CP 1104		5. FUNDING NUMBERS Contract Nos: F08637-01-C-6002 and F08637-98-C-6005 PE: 63716D		
5. AUTHORS Kerry A. Kinney and William M. Moe				
6. PERFORMING ORGANIZATION NAME(S) AND ADDRESS(ES) U of Texas Louisiana State University 10000 Burnet Road, PO Box 8029 Dept. of Civil & Environ. Eng. Austin, TX78758-4423 Baton Rouge, LA 70803-6405		7. PERFORMING ORGANIZATION REPORT NUMBER		
8. SPONSORING/MONITORING AGENCY NAME(S) AND ADDRESS(ES) AFRL/MLQL 139 Barnes Drive, Suite 2 Tyndall AFB, FL 32403-5323		9. SPONSORING/MONITORING AGENCY REPORT NUMBER AFRL-ML-TY-TR-2004-4557		
11. SUPPLEMENTARY NOTES Technical monitor: Dr Joe Wander, AFRL/MLQL, 850-283-6240 [DSN 523-6240]				
12a. DISTRIBUTION/AVAILABILITY STATEMENT Public release authorized. Distribution unlimited.		12b. DISTRIBUTION CODE A		
ABSTRACT (Maximum 200 words) Each year, painting operations at DoD maintenance facilities emit large quantities of volatile organic compounds (VOCs) into the atmosphere. The goal of this research project was to assess the feasibility of using biofilters to remove VOCs from gas emissions exiting paint spray booths. Several bioreactor designs and operating strategies were investigated and performance of an integrated biofiltration system was evaluated first at the laboratory and then at the pilot scale. Results indicate that numerous bioreactor configurations are capable of achieving paint VOC removal efficiencies in excess of 90%. Regardless of the particular bioreactor configuration investigated or the microbial inocula utilized, aromatic hydrocarbons were consistently found to be the most slowly degraded in the biofilters. Biofilm establishment and nutrient supply rates also strongly influenced (continued on p. ii)				
14. SUBJECT TERMS Aircraft painting; air pollution; biofilter; bioreactor; <i>Cladosporium</i> ; <i>Exophiala</i> ; fungal degradation; fungi; <i>Phanerochaete</i> ; VOCs		15. NUMBER OF PAGES 179		
		16. PRICE CODE		
17. SECURITY CLASSIFICATION OF REPORT UNCLASSIFIED	18. SECURITY CLASSIFICATION OF THIS PAGE UNCLASSIFIED	19. SECURITY CLASSIFICATION OF ABSTRACT UNCLASSIFIED	20. LIMITATION OF ABSTRACT UL	

NSN 7540-01-280-5500
(Rev 2-89)

Computer Generated

STANDARD FORM 298

Prescribed by ANSI Std Z39-18
298-102

13. ABSTRACT (CONTINUED)

the performance of the biofiltration systems. Once a robust biofilm was established in the bioreactors, however, these systems could effectively treat complex VOC mixtures even during intermittent feed conditions expected to occur in full-scale painting operations. A slip-feed system was found to be useful for maintaining microbial activity particularly in the pilot-scale bioreactor treating actual paint emissions on an intermittent schedule. The study results indicate that biofiltration systems are feasible for treating emissions from DoD paint spray booths and can be used to effectively meet a variety of potential treatment goals.

EXECUTIVE SUMMARY

Painting operations at Department of Defense maintenance facilities emit large quantities of volatile organic compounds (VOCs) into the atmosphere each year. Most or all of these VOCs are classified as hazardous air pollutants (HAPs) because they are known or suspected to be detrimental to human health. In addition, VOC emissions can contribute to formation of ground-level ozone, a problem facing many urban areas across the country. A need therefore exists to develop an efficient and environmentally friendly system to treat paint booth emissions and to meet increasingly stringent environmental regulations. While conventional air pollution control technologies can be effective for paint spray booth applications, they are often energy intensive, create undesirable byproducts and may not be cost effective for treating the intermittent, high volumetric flow rates and low contaminant concentrations associated with booth operations.

In this research project, the feasibility of using biofiltration, a promising biological treatment method, was assessed for its potential to effectively remove VOCs from waste gas emissions exiting paint spray booths. Although multiple bioreactor configurations are possible, the basic principle of biofiltration involves passing a contaminated air stream through a reactor containing biologically active packing material. Contaminants migrate from the air stream into a biofilm immobilized on a support medium, in which they are converted by microorganisms into innocuous products including carbon dioxide, water, and additional biomass. Because biofilter systems can achieve pollutant destruction at ambient temperatures and have low pressure drops, they require much less energy to operate than many abiotic control technologies (*e.g.*, thermal or catalytic oxidation). In addition, biofilters are well suited for treating air streams contaminated with low concentrations of VOCs, such as those emitted from painting operations. Paint spray booth off-gases pose a challenge to biofilter technology, however, because they are characterized by complex mixtures of VOCs, intermittent operation, and very high volumetric flow rates. The overall goal of this project was to develop and optimize an innovative biofiltration system capable of reliable and efficient VOC removal for this particular waste stream.

To achieve this goal, several bioreactor designs and operating strategies were investigated to assess their potential for improving biofilter performance for paint spray booth applications. Systems tested included (1) biofilters with enhanced design features such as a slip-feed system and directionally switching operation (2) a conventional biotrickling filter, (3) a foam/intermittent biotrickling filter, (4) a biotrickling filter/biofilter hybrid, (5) a sequencing batch bioreactor, and (6) fungal biofilters. Following assessment of individual design and operation features, performance of an integrated biofiltration system treating paint emissions was examined under operating conditions expected in full-scale systems. The integrated system was experimentally tested, first at the laboratory scale using a surrogate VOC mixture and then at the pilot scale during application of actual MIL-SPEC paint. Finally, an engineering assessment of the technical and economic feasibility of biofiltration technology for paint spray booth applications was completed.

Results from laboratory-scale experiments indicate that numerous bioreactor configurations are capable of achieving VOC removal efficiencies in excess of 90%. Regardless of the particular bioreactor configuration investigated or the microbial inocula utilized to seed the system (*i.e.*,

fungal or bacterial), aromatic hydrocarbons were consistently found to be the most slowly degraded.

In addition to the particular bioreactor configuration and operating strategy utilized, biofilm establishment and nutrient supply rates strongly influenced performance of the biofiltration systems. Unlike abiotic control technologies, all of the bioreactors required a start-up period before sufficient biomass was established on the synthetic packing materials to achieve high VOC removal efficiencies. Factors that favored rapid start-up and stable long-term performance included inoculation of the packing material with a diverse microbial community capable of degrading the major pollutants in the waste gas stream, a large supply of readily-available nitrogen, and proper humidification of the influent gas stream.

Once a robust biofilm was established in the bioreactors, experimental results indicate that these systems can effectively treat complex VOC mixtures even during the intermittent feed conditions expected to occur in full-scale painting operations. A slip-feed system was found to be a useful tool for maintaining microbial activity in the bioreactor during extended shut-down periods and during start-up. This was particularly true for the pilot-scale bioreactor treating actual paint emissions on an intermittent schedule typical of DoD paint booth operations. Because paint booths typically operate intermittently, the ability to maintain biomass activity during periods of no contaminant loading is an important consideration.

Technical and economic assessment of biofiltration technology indicates that these systems are feasible for treating emissions from DoD paint spray booths and can achieve high VOC removal efficiencies even at empty-bed contact times as low as 15 seconds. The technology can be used to effectively meet a variety of potential treatment goals including high removal efficiencies when long empty-bed contact times are employed (*e.g.*, 1 minute) or moderate removal efficiencies if shorter contact times are utilized. The latter case, for instance, may be appropriate for meeting annual VOC emission reduction goals. Maintaining consistently high removal efficiencies in systems with short gas-phase residence times would likely be more difficult to achieve. Finally, an economic evaluation of biofiltration technology indicates that these systems can be economically feasible for paint booth applications. The economic analysis suggests that biofiltration systems can be less expensive than conventional thermal technologies primarily because of the low operating costs associated with these biological treatment systems.

PREFACE

The research project reported herein represents a collaborative effort among researchers at the University of Texas at Austin and Louisiana State University. The authors of this report gratefully acknowledge the contributions of the graduate and post-graduate researchers who contributed to this project, including Jungsu Park, Sherry Kazenski and JiHyeon Song at the University of Texas at Austin as well as Congna Li, Bing Qi, and Jorge Atoche at Louisiana State University. The authors would also like to acknowledge Robert Montgomery for his assistance with the pilot-scale tests.

The research project was funded in part by the Department of Defense's Strategic Environmental Research and Development Program and managed through a contract with the U.S. Air Force at Tyndall AFB (Contract # F08637-98-C-6005). Dr. Robert Holst is the SERDP Compliance Program Manager and Mr. Bradley Smith is the Executive Director of SERDP. Dr. Joseph Wander at Tyndall AFB was the Technical Manager of the project for the Air Force.

The research project also benefited from other funding that supported the Principal Investigator's research program. This funding included support provided by the Environmental Protection Agency for biofilter optimization (Grant No. R826168-01-0) as well as matching funds provided by BioReaction Industries for the investigation of a hybrid bioreactor system. The project also benefited from the donation of packing media for the pilot-scale testing by Honeywell-PAI.

TABLE OF CONTENTS

CHAPTER 1: PROJECT OBJECTIVES.....	1
CHAPTER 2: BACKGROUND.....	2
2.1 Painting Operations.....	2
2.2 Overview of Biofiltration Technology.....	6
2.2.1 Basic Types of Biofiltration Systems	6
2.2.2 Mechanisms of VOC Removal	10
2.2.3 Microorganisms	10
2.2.4 Bioreactor Performance—VOC Removal	11
2.2.5 Other Key Operating Parameters.....	12
2.2.6 Previous Applications of Biofiltration Technology	14
2.3 Previous Paint Spray Booth Studies	15
2.4 Challenges Facing Biofilters for Paint Booth Applications.....	16
2.4.1 Effect of VOC Mixtures on Pollutant Degradation	16
2.4.2 Effect of Unsteady-State Booth Operation on Biofilter Performance	17
CHAPTER 3: EXPERIMENTAL APPROACH.....	19
CHAPTER 4: EVALUATION OF BIOFILTER DESIGN FEATURES.....	22
4.1 Directionally Switching Operation	22
4.1.1 Methods.....	22
4.1.2 Results.....	24
4.2 Evaluation of a Slip-feed System.....	28
4.2.1 Methods.....	29
4.2.2 Results.....	29
4.3 Nitrogen Requirements and Recycling Estimates.....	32
4.3.1 Methods.....	32
4.3.2 Results.....	33
CHAPTER 5: BIOTRICKLING FILTER EVALUATION	37
5.1 Methods.....	37
5.1.1 Experimental Biotrickling Filter	38
5.1.2 Synthetic Waste Gas	38
5.1.3 Bioreactor Startup and Operating Conditions.....	39
5.1.4 Elimination Capacity Tests	40
5.1.5 VOC Interactions in the Column	40
5.1.6 Serum Bottle Studies.....	41
5.1.7 Analytical Methods	41
5.2 Results.....	42
5.2.1 Elimination Capacity	42
5.2.2 VOC Removal.....	47
5.2.3 VOC Interactions	54
5.2.4 Directionally Switching Operation	60
5.2.5 Summary and Conclusions	61
CHAPTER 6: EVALUATION OF A BIOTRICKLING FILTER/ BIOFILTER HYBRID	64
6.1 Methods.....	64
6.2 Results.....	66

6.3	Summary and Conclusions	71
CHAPTER 7: ASSESSMENT OF FUNGAL BIOFILTERS.....		73
7.1	Initial Screening of Fungi for Their Ability to Degrade Paint VOCs.....	73
7.1.1	Methods.....	73
7.1.2	Results.....	75
7.2	Evaluation of a Fungal Biofilter During Continuous Loading	76
7.2.1	Methods.....	77
7.2.2	Results.....	79
7.3	Evaluation of a Fungal Biofilter During Intermittent Loading	83
7.3.1	Methods.....	84
7.3.2	Results.....	85
CHAPTER 8: SEQUENCING BATCH BIOFILTER (SBB) OPERATION.....		93
8.1	Methods.....	95
8.2	Results.....	99
CHAPTER 9: INTEGRATED LABORATORY-SCALE EVALUATION OF AN INTERMITTENT, FOAM BIOTRICKLING FILTER.....		104
9.1	Materials and Methods.....	105
9.1.1	Inoculum Development.....	106
9.1.2	Analytical Methods	106
9.2	Results.....	107
9.2.1	Effect of Sequential vs. Continuous Feed Strategy	107
9.2.2	Nitrogen Limitation Experiments	111
9.2.3	Transient-Loading Experiments.....	113
9.2.4	DGGE Analysis of the Bioreactor Microbial Community	115
9.2.5	Empty-Bed Contact Time and Elimination capacity (<i>EC</i>) Tests	117
9.3	Summary and Conclusions	120
CHAPTER 10: PILOT-SCALE EVALUATION OF BIOFILTRATION TECHNOLOGY		121
10.1	Materials and Methods.....	121
10.1.1	Paint-Thinner Mixture	123
10.1.2	Inoculation	124
10.1.3	Bioreactor Operation.....	124
10.1.4	Analytical Techniques	125
10.2	Results.....	126
10.2.1	Bioreactor Start-up Period	126
10.2.2	Phase I: Baseline Paint Spraying Experiments: (Day 1–Day 8).....	126
10.2.3	Phase II: Paint Spraying Experiments (No MIAK Slip Feed; Days 11–15).....	129
10.2.4	Phase III: Paint Spraying Experiments (MIAK Slip Feed Provided; Days 28– 38).....	129
10.2.5	Biofilter Response as a Function of VOC Concentration.....	131
10.3	Summary and Conclusions	133
CHAPTER 11: ENGINEERING ASSESSMENT AND DESIGN RECOMMENDATIONS..		135
11.1	Technical Considerations.....	135
11.1.1	VOC Removal Efficiency	136
11.1.2	Bioreactor Size Requirements and Gas-Phase Residence Time	137
11.1.3	Bioreactor Startup and Biofilm Establishment	139
11.1.4	Bioreactor Response to Transient VOC Feed Conditions	140

11.1.5	Bioreactor Operational Stability and Maintenance Requirements.....	141
11.2	Economic Evaluation.....	144
11.2.1	Catalytic and Thermal Oxidation of Paint Booth Emissions.....	144
11.2.2	Biofiltration of Paint Booth Emissions.....	146
REFERENCES	149

LIST OF FIGURES

Figure 2-1. Paint Spray Booth at Ft. Hood Army Base, Texas.....	3
Figure 2-2. Painter with Protective Equipment and Supplied Air Line.....	4
Figure 2-3. Particulate Filtration System at DoD Paint Spray Booth: (a) Particulate and Paint Overspray Pre-filtration System at End of Paint Booth and (b) Bank of High- Efficiency Particulate Filters Located in Ceiling of Paint Booth.	4
Figure 2-4. Diagram of a biofilter (Van Groenestijn and Hesselink 1994).	8
Figure 2-5. Diagram of a Biotrickling Filter (Van Groenestijn and Hesselink 1994).	8
Figure 2-6. Diagram of a Bioscrubber (Van Groenestijn and Hesselink 1994).....	9
Figure 2-7. Biodegradation Processes and Biological Reactions Occurring in a Biofilter.....	10
Figure 3-1. Experimental Scope.....	19
Figure 4-1. Schematic Diagram of Biofiltration Apparatus Used in Study Phases 2, 3, 7 and 8. (1) Oil Filter, (2) Pressure Regulator, (3) Nebulizer for Study Phase 2; Humidifier for Phases 3 7, and 8, (4) VOC Syringe Pump, (5) Mixing Chamber, (6) Packing Media, (7) Gas Sampling Port, (8) Packing Media Sampling Port, (9) Nutrient Solution Recirculation System (Used During Study Phases 3, 7 and 8 Only), (10) Drain.....	23
Figure 4-2. Overall Toluene Removal Efficiencies (Filled) and Pressure Drop (Empty) as a Function of Time for (a) the UD and (b) the 3-day DS biofilter.	25
Figure 4-3. Overall Toluene Removal Efficiencies at (a) 1-Day, (b) 3-Day, and (c)7-Day Switching Frequencies (SFs).	27
Figure 4-4. Schematic of the Experimental Bioreactor System in Each Operational Mode.	30
Figure 4-5a. Bioreactor Re-acclimation after a Weekend Shutdown Period.....	31
Figure 4-5b. Bioreactor Re-acclimation after a Week Shutdown Period	31
Figure 4-6. (a) Toluene and <i>p</i> -Xylene Removal Efficiencies across the Biofilter Column, and (b) Average Media Nitrogen Levels ($\text{NH}_4^+ + \text{NO}_3^-$) Normalized by COD Content.....	34
Figure 5-1. Total VOC Elimination Capacities as a Function of VOC Mass Loading Rate and Gas-phase Residence Time in the Biotrickling Filter	43
Figure 5-2. Inset from Figure 5-1: Total VOC Elimination Capacities as a Function of VOC Mass Loading Rate and Gas-phase Residence Time in the Biotrickling Filter	43
Figure 5-3. Methyl <i>n</i> -Propyl Ketone Elimination Capacity at Three Different Residence Times in the Biotrickling Filter.....	45
Figure 5-4. Toluene Elimination Capacity at Three Different Residence Times in the Biotrickling Filter.....	45
Figure 5-5. <i>n</i> -Butyl Acetate Elimination Capacity at Three Different Residence Times in the Biotrickling Filter.....	45
Figure 5-6. Xylene Elimination Capacity at Three Different Residence Times in the Biotrickling Filter.....	46
Figure 5-7. Ethyl 3-Ethoxypropionate Elimination Capacity at Three Different Residence Times in the Biotrickling Filter.....	46
Figure 5-8. Total VOC Removal Efficiencies in the Biotrickling Filter	48
Figure 5-9. Total VOC Concentration Profile in the Biotrickling Filter on Day 17 of Operation. Bioreactor Operating Conditions: Top-feeding, Liquid Recirculation Rate =2.7 L/min, Gas-phase Residence Time = 1.5 min.	49

Figure 5-10.	Individual VOC Concentration Profiles in the Biotrickling Filter on Day 17 of Operation. Bioreactor Operating Conditions: Top-feeding, Liquid Recirculation Rate =2.7 L/min, Gas-phase Residence Time = 1.5 min.....	50
Figure 5-11.	Effect of Gas-phase Residence Time on Methyl <i>n</i> -Propyl Ketone Degradation. Bioreactor Operating Conditions: Inlet Concentration = 110 ppm _v , Top-feeding, Liquid Recirculation Rate =2.7 L/min.	51
Figure 5-12.	Effect of Residence Time on Toluene Degradation. Bioreactor Operating Conditions: Inlet Concentration = 20 ppm _v , Top-feeding, Liquid Recirculation Rate =2.7 L/min.....	51
Figure 5-13.	Effect of Residence Time on <i>n</i> -Butyl Acetate Degradation. Bioreactor Operating Conditions: Inlet Concentration = 20 ppm _v , Top-feeding, Liquid Recirculation Rate =2.7 L/min.....	52
Figure 5-14.	Effect of Residence Time on Xylene Degradation. Bioreactor Operating Conditions: Inlet Concentration = 18 ppm _v , Top-feeding, Liquid Recirculation Rate =2.7 L/min.	52
Figure 5-15.	Effect of Residence Time on Ethyl 3-Ethoxypropionate Degradation. Bioreactor Operating Conditions: Inlet Concentration = 32 ppm _v , Top-feeding, Liquid Recirculation Rate =2.7 L/min.	53
Figure 5-16.	Effect of Residence Time on Total VOC Degradation. Bioreactor Operating Conditions: Total Inlet Concentration = 200 ppm _v , Top-feeding, Recirculation Rate =2.7 L/min.....	53
Figure 5-17.	Degradation of the Paint VOC Mixture in a bottle system.	55
Figure 5-18.	Methyl <i>n</i> -propyl ketone (MPK) degradation in the Bottle Studies.	56
Figure 5-19.	Toluene Degradation in the Bottle Studies.	56
Figure 5-20.	Xylene Degradation in the Bottle Studies.	57
Figure 5-21.	Effects of Different Mixture Conditions on Toluene Removal Profiles in the Biotrickling Filter. Bioreactor Operating Conditions: Top-feeding, Liquid Recirculation Rate = 2.7 L/min, Gas Residence Time = 1 min.	58
Figure 5-22.	Effects of Different Mixture Conditions on Xylene Removal Profiles in the Biotrickling Filter. Bioreactor Operating Conditions: Top-feeding, Liquid Recirculation Rate = 2.7 L/min, Gas Residence Time = 1 min.	59
Figure 5-23.	Biomass Distribution in the Biotrickling Filter on Day 27 of Operation in Directionally Switching Mode.	60
Figure 5-24.	Typical Concentration Profile for Top-Feeding Operation , Day 39	61
Figure 5-25.	Typical Concentration Profile for Bottom-feeding Operation, Day 35	61
Figure 6-1.	Schematic Diagram of Biotrickling Filter/ Biofilter Hybrid Used in Study Phase 4: (1) Air Blower, (2) Flow Meter, (3) Liquid Sump, (4) Plastic Packing in Biotrickling Filter, (5) Compost-Based Packing in Biofilter Unit, (6) Gas Sampling Port, (7) Waste Line, (8) Nutrient Recirculation System (Taken from Song and Kinney, 2003).....	65
Figure 6-2.	(a) Total VOC Removal Efficiencies and (b) Average Biofilter Media Nitrogen Levels Measured at the Beginning and the End of Each Nitrogen-limited Experiment (Taken from Song and Kinney, 2003). Error Bars Indicate Standard Deviations.	67

Figure 6-3.	VOC Removal Profiles Determined along the Hybrid Bioreactor Column During the Nitrogen-limited Experiments (NL1, NL2, NL3, and NL4). MPK: Methyl Propyl Ketone; EEP: Ethyl 3-Ethoxypropionate; NBA: <i>n</i> -Butyl Acetate; TOL: Toluene; XYL: <i>p</i> -Xylene. (Taken from Song and Kinney, 2003).....	68
Figure 6-4.	Maximum Elimination Capacities of the Five-component VOC Mixture as well as Methyl Propyl Ketone (MPK) and Toluene in the Mixture as a Function of Initial Media Nitrogen Level. (Taken from Song and Kinney, 2003)	69
Figure 6-5.	Elimination Capacity Curves for (a) Methyl Propyl Ketone (MPK), and (b) Toluene and <i>p</i> -Xylene When Present as the Sole VOC or as Part of the Five-component Paint VOC Mixture. (Taken from Song and Kinney, 2003).....	70
Figure 7-1.	Schematic Diagram of Laboratory Biofilter Apparatus. (Taken from Moe and Qi, 2004).	77
Figure 7-2.	Overall VOC Elimination Capacity (<i>EC</i>) and Removal Efficiency (<i>RE</i>) During Period S (Days 0–51), Period I (Days 52–74), Period II (Days 75–92), Period III (Days 93–152), and Period IV (Days 153–158). (taken from Qi <i>et al.</i> , 2004).	80
Figure 7-3.	Removal Efficiencies for Individual Compounds During Period S, I, II, III, IV. (taken from Qi <i>et al.</i> , 2004).	81
Figure 7-4.	VOC removal profiles along the biofilter height during Period IV experiments (EBRT of 15 seconds). (taken from Qi <i>et al.</i> , 2004).....	82
Figure 7-5.	Typical VOC Concentrations in the Biofilter Influent During an 8-hr VOC Loading Period of “Daytime Operation”. Time 0 Corresponds to Start of the 8-hr VOC Loading Period. The Arrow Denotes the End of the 8-hr Loading Cycle. (Taken from Moe and Qi, 2004).....	85
Figure 7-6.	Typical Removal Efficiency for Each of the Four VOCs (Top, Data from Day 13), and Typical Effluent CO ₂ Concentration (Bottom, Data from Day 15) During Period 1. Time 0 in the Graphs Corresponds to the Start of the 8-hr VOC Loading Period, and Arrows Denote the End of the 8-hr Loading Cycle. (Taken from Moe and Qi, 2004).	86
Figure 7-7.	Typical VOC Removal Efficiency During the 8-hr VOC Loading Periods During a Typical Week Following a Weekend Shutdown (Period 2). The First Day after the 2-Day VOC Shutdown (Top). The Third Day after the 2-Day VOC Loading Shutdown (Middle). The Fifth Day after the 2-Day VOC Loading Shutdown (Bottom). (Taken from Moe and Qi, 2004).	88
Figure 7-8.	Typical VOC Removal Efficiency during the 8-hr VOC Loading Periods During a Typical Week Following a 9-Day Shutdown During Period 3. (Top) The First Day after the 9-Day VOC Shutdown. (Middle) The Third Day after the 9-Day VOC Loading Shutdown. (Bottom) The Fifth Day after the 9-Day VOC Loading Shutdown. (Taken from Moe and Qi, 2004).....	90
Figure 8-1.	Cycle for One Biofilter in a Periodically Operated Multiple-reactor Biofilter System (Taken from Moe and Li, 2004).....	93
Figure 8-2.	Schematic Diagram of the Laboratory-scale Sequencing Batch Biofilter (SBB) Apparatus. The Continuous-Flow Biofilter (CFB) Was Identical Except That the Components Inside the Dashed Line Were Omitted.....	96

Figure 8-3.	Average Loading Rate for Toluene (▲) and MEK (x) and Removal Efficiency for Toluene (◆) and MEK (○) in the CFB (a) and SBB (b) During Normal Operation of Phase 1. For Comparison Purposes, Data Depicted in the Figure for the SBB Are Average Daily Loading Rates Rather Than Loading Rates During FEED Periods (Taken from Atoche and Moe, 2004).	99
Figure 8-4.	Phase 2 Shock-loading Experiments. Influent Contaminant Concentrations in the CFB (a) and the SBB (d). Effluent Contaminant Concentrations in the CFB (b) and the SBB (e). Instantaneous Removal Efficiency in the CFB (c) and the SBB (f). Constituents Included Are: Toluene (◆), MEK (○), CO ₂ (x), and Total of Both VOCs (▲). (Taken from Atoche and Moe, 2004).....	100
Figure 9-1.	VOC Removal During the Start-up Period (from Day 0 to 63) in Sequentially and Continuously Fed Columns. The Arrow on Each Figure Indicates the Day When the Nutrient Spraying Interval Was Increased to 30 Minutes, Twice a Day.	108
Figure 9-2.	VOC Removal Profiles across the CFC Biofilter on Day 48. (C _o : VOC Concentration at the Inlet, C: VOC Concentration at Each Sampling Point, D: Bed Depth to Each Sampling Point, D _o : Total Packed-bed Depth from Inlet to Outlet).....	109
Figure 9-3.	Total Inorganic Nitrogen Concentration and Biomass Quantity (COD) in the SFC and CFC biofilters During the Start-up Period.	110
Figure 9-4.	Paint Mixture Removal Profile Across the SFC on (a) Day 72 and (b) Day 80: (a) One Day and (b) Nine Days after Switching from the Methyl Propyl Ketone/ Toluene Feed to the Surrogate Paint Mixture Feed.	111
Figure 9-5.	Effect of Nitrogen on VOC Removal Efficiencies. The Arrow Indicates When the Nitrogen Supply to the Bioreactors Was Resumed.....	113
Figure 9-6.	VOC Removal Efficiencies Observed During Transient Loading Experiments....	114
Figure 9-7.	DGGE Gel Images of PCR Products from the Bacterial Population (a) and Fungal Population (b) in Biofilm Samples Collected from the Sequentially Fed Column (SFC) and the Continuously Fed Column (CFC) on Day 58 and Day 269 of Bioreactor Operation.....	116
Figure 9-8.	VOC Removal Profiles in the Continuously Fed Column (I) and the Sequentially Fed Column (II) at a 30-sec and 15-sec EBCT. The Total Inlet VOC Concentration Is Indicated at the Top of Each Figure.	119
Figure 9-9.	Elimination Capacity of the Continuously Fed and Sequentially Fed Columns As a Function of VOC Loading Rate at a 15-sec and 30-sec EBCT.	120
Figure 10-1.	Photograph of the Pilot-scale Bioreactor.	121
Figure 10-2.	Schematic Diagram of the Pilot-scale Bioreactor.	122
Figure 10-3.	Paint Booth System Used in Pilot-scale Tests (Left: Paint Kettle; Right: Paint Spray Duct).....	122
Figure 10-4.	Removal of Paint VOCs in the Bioreactor During the Third Day of Painting Operations.	127
Figure 10-5.	Overall VOC Removal Efficiencies in the Biofilter When No MIAK Slip Feed Was Provided During the Booth Off-Period.....	129
Figure 10-6.	VOC Removal During the Phase III Paint Spraying Experiments.....	130
Figure 10-7.	VOC Removal Profile across the Bioreactor Treating a 14-ppmv Inlet Concentration on Day 31 of Operation.....	132

Figure 10-8. VOC Removal Profile across the Bioreactor Treating VOCs with a Total Inlet Concentration of 128 ppm_v on Day 32 of Operation. 133

Figure 11-1. Cost of Catalytic Oxidation and Thermal Oxidation Units As a Function of the Cost of Natural Gas and Paint Booth Off-gas Flow Rates..... 145

Figure 11-2. Cost of Catalytic Oxidation and Thermal Oxidation of Paint Spray Off Gas Stream As a Function of Gas Flow Rate..... 146

LIST OF TABLES

TABLE 2-1. VOLATILE ORGANIC COMPOUNDS EMITTED FROM PAINT SPRAY BOOTHS AT DOD FACILITIES.	5
TABLE 2-2. CLASSIFICATION OF BIOREACTORS FOR WASTE GAS TREATMENT (Ottengraf, 1987).	7
TABLE 2-3. INDUSTRIES USING BIOFILTRATION IN EUROPE (Leson, 1991).	14
TABLE 2-4. ABBREVIATED LIST OF CHEMICALS TREATABLE BY BIOFILTRATION.	15
TABLE 3-1. EXPERIMENTAL PHASES AND TASKS.	20
TABLE 4-1. BIOFILTER OPERATING CONDITIONS AND NITROGEN SUPPLY.	33
TABLE 4-2. NITROGEN MASS BALANCE DURING PHASE III (DAYS 50-76).	35
TABLE 5-1. PROPERTIES OF VOCS PRESENT IN THE SURROGATE PAINT MIXTURE.	39
TABLE 5-2. INLET VOC CONCENTRATIONS IN THE SURROGATE PAINT MIXTURE.	39
TABLE 5-3. BIOTRICKLING FILTER OPERATING CONDITIONS.	40
TABLE 5-4. DEGRADATION RATE CONSTANTS FOR METHYL <i>n</i>-PROPYL KETONE, TOLUENE, AND XYLENE.	57
TABLE 6-1. HYBRID BIOREACTOR OPERATING CONDITIONS AND NITROGEN SUPPLY.	66
TABLE 7-1. SUMMARY OF GROWTH OBSERVATIONS FOR FUNGI GROWING ON VOCS (TAKEN FROM Qi <i>et al.</i>, 2002).	76
TABLE 7-2. BIOFILTER TARGET LOADING DURING CONTINUOUS-LOADING CONDITIONS.	78
TABLE 7-3. BIOFILTER TARGET LOADING FOR INTERMITTENT LOADING STUDIES	84
TABLE 8-1. SUMMARY OF BIOFILTER OPERATING CONDITIONS DURING “NORMAL” LOADING (Atoche and Moe, 2004)	97
TABLE 8-2. SUMMARY OF BIOFILTER OPERATING CONDITIONS DURING “SHOCK” LOADING (Atoche and Moe, 2004).	98
TABLE 10-1. PHYSICAL AND CHEMICAL PROPERTIES OF THE PAINT AND THINNER USED IN THE PILOT-SCALE STUDY.	123
TABLE 10-2. PROPERTIES OF THE VOCS FOUND IN THE PAINT AND THINNER USED IN THE PILOT-SCALE STUDY.	124
TABLE 10-3. COMPOSITION OF THE SURROGATE VOC FEED DURING START-UP PERIOD.	125
TABLE 10-4. SPECIATED VOC REMOVAL ON THE SIXTH HOUR OF PAINTING OPERATIONS ON DAY 3.	127
TABLE 10-5. AVERAGE VOC REMOVAL EFFICIENCY DURING THE 6-HOUR PAINTING PERIOD ON DAY 4 OF PAINTING OPERATIONS.	128
TABLE 10-6. VOC REMOVAL TWO-HOURS AFTER RESUMING PAINTING OPERATIONS FOLLOWING A WEEKEND SHUTDOWN.	128
TABLE 10-7. AVERAGE VOC REMOVAL EFFICIENCY DURING THE 6-HOUR PAINTING PERIOD ON DAY 31 OF OPERATION.	131

TABLE 10-8. AVERAGE VOC REMOVAL EFFICIENCY DURING THE 6-HOUR PAINTING PERIOD ON DAY 32 OF OPERATION.....	132
TABLE 11-1. CATALYTIC AND THERMAL INCINERATION OPTIONS FOR PAINT BOOTH CASE STUDIES.....	145
TABLE 11-2. TOTAL ANNUAL COST OF THE CATALYTIC AND THERMAL INCINERATION OPTIONS.....	145
TABLE 11-3. DESIGN PARAMETERS AND COST ESTIMATES FOR THE BIOFILTRATION TREATMENT OPTION.....	147

LIST OF ACRONYMS

BTEX	Benzene, Toluene, Ethylbenzene, and Xylene
CA	Cellular automaton model
CAAA	Clean Air Act Amendments
CFB	Continuous-Flow Biofilter
cfm	Cubic feet per minute
COD	Chemical Oxygen Demand
DGGE	Denaturing gradient gel electrophoresis
DoD	Department of Defense
DS	Directionally switching
EBRT	Empty-bed residence time
EC	Elimination capacity
EEP	Ethyl 3-ethoxypropionate
EPA	Environmental Protection Agency
FID	Flame Ionization Detector
FISH	Fluorescent <i>in-situ</i> hybridization
fpm	Feet per minute
GC	Gas Chromatography
g/m³	Grams per cubic meter
g/m³/h	Grams per cubic meter per hour
HAP	Hazardous Air Pollutant
HCMM	Hydrocarbon minimal medium
ID	Internal diameter
<i>K_La</i>	Mass transfer coefficient
MEK	Methyl ethyl ketone
mg/L	Milligrams per liter
mg/kg	Milligrams per kilogram
MIBK	Methyl isobutyl ketone
MPK	Methyl <i>n</i> -propyl ketone
m/s	Meters per second
NBA	<i>n</i> -Butyl acetate
NET	National Emission Trends database

NFPA	National Fire Protection Association
O&M	Operation and maintenance
OSHA	Occupational Safety and Health Administration
PELs	Permissible Exposure Limits
PM	Particulate matter
PM₁₀	Particulate matter with diameter of 10 microns or less
ppm_v	Parts per million by volume
psi	Pounds per square inch
RE	Removal efficiency
v/v	Volume per volume
SBB	Sequencing Batch Biofilter
scfm	Standard cubic feet per minute
SERDP	Strategic Environmental Research and Development Program
SF	Switching Frequency
UD	Unidirectional
UHP	Ultra high purity
VPB	Vapor-phase bioreactor
VOC	Volatile Organic Compound

CHAPTER 1: PROJECT OBJECTIVES

The Clean Air Act Amendments of 1990 require the reduction of emissions of volatile organic compounds (VOCs) and hazardous air pollutants (HAPs) from a variety of sources including painting operations. Even with the development of alternative, low-VOC coatings, VOCs continue to be emitted from aircraft, tank, automobile and parts painting operations at Department of Defense (DoD) facilities across the country. Most currently available VOC control technologies are energy intensive and costly to implement for the low contaminant concentrations associated with paint booth ventilation systems. They also often generate hazardous byproducts that require further treatment. A cost-effective and efficient air pollution control technology is therefore needed to ensure that painting facilities are compliant with increasingly stringent VOC control requirements.

The primary objective of the project described in this report was to develop an innovative biofiltration system to control VOC emissions from paint spray booth operations at DoD maintenance facilities. Although biofiltration is an environmentally friendly technology that holds great promise for this application, several challenges need to be overcome. Specifically, off-gas streams from painting operations are characterized by complex VOC mixtures including both hydrophobic and hydrophilic compounds, frequent shutdown and restart events, high volumetric flow rates, and relatively low contaminant concentrations. The overall goal of this project was therefore to develop and optimize an innovative biofilter system specifically for this application so that reliable and efficient bioreactor operation can be achieved.

To achieve this goal, several bioreactor designs and operating strategies were investigated to assess their potential to improve biofilter performance for paint spray booth applications. Systems tested included (1) biofilters with enhanced design features such as a slip-feed system and directionally switching operation (2) a classic biotrickling filter, (3) a foam/intermittent biotrickling filter, (4) a biotrickling/biofilter hybrid, (5) a sequencing batch bioreactor and (6) fungal biofilters. Another key objective of the project was to better understand the underlying fundamental parameters that control pollutant removal in biofilter systems at both the laboratory and pilot scale. To this end, the performance of an integrated biofilter system treating paint emissions was examined under realistic operating conditions first at the lab scale and then at the pilot scale.

The final objective of the project was to provide an engineering assessment of the technical and economic feasibility of biofiltration technology for paint booth applications based on the results of the lab- and pilot-scale tests as well as an economic evaluation of the process. Given the breadth of bioreactor technologies examined and the lab- and pilot-scale tests conducted, the research conducted has provided a solid foundation for the transition of biofiltration technology to full-scale application at paint booths across the country.

CHAPTER 2: BACKGROUND

Surface coating facilities such as painting operations face stringent environmental regulations requiring control of emissions of volatile organic compounds (VOCs) and hazardous air pollutants (HAPs). Paint spray booths, in particular, emit large quantities of such VOCs as toluene, xylene, and methyl ethyl ketone. Many of these components are classified as HAPs in the 1990 Clean Air Act Amendments (CAAA) because they are known or suspected to cause adverse human health effects. Even VOCs that are not among the 188 HAPs listed in the CAAA can cause negative human health impacts. For instance, many VOCs react photochemically with nitrogen oxides in the atmosphere to form tropospheric (low-level) ozone that can contribute to respiratory dysfunction in humans.

Although conventional VOC control technologies such as thermal incineration and adsorption to activated carbon can be effective at reducing emissions from surface-coating operations, they generate undesirable byproducts, are energy intensive, and may not be cost effective when treating high-flow air streams contaminated with low concentrations of pollutants. Biofiltration is an attractive alternative for low-concentration waste gas streams because of its low energy consumption, relatively moderate operating cost, and minimal byproduct generation. In biofiltration, contaminants present in an air stream are transferred into a biofilm immobilized on a solid packing support media and then are converted by microorganisms into such products as carbon dioxide, water, and additional biomass. Biofiltration technology has been used to treat relatively low concentrations of odorous compounds and volatile chemicals from off-gas streams in wastewater treatment plants, composting operations, rendering plants, and chemical manufacturing facilities. To date, however, there have been only limited studies of biofiltration for treatment of off-gas streams from paint booth operations. Paint booths are a particularly challenging application because they emit a complex mixture of VOCs and they operate intermittently. Section 2.1 of this report summarizes paint booth operations and the emissions that can be expected from these facilities. An overview of biofiltration technology is provided in Section 2.2. Previously reported studies regarding the application of biofiltration to paint booths are described in Section 2.3, and challenges facing biofilters employed for this application are summarized in Section 2.4.

2.1 Painting Operations

Equipment maintenance operations are one of the greatest sources of VOC emissions at U.S. Air Force installations and paint spray booths are considered the largest emissions source within this category (McMinn 1992; Whitfield 1993). According to the National Emission Trends (NET) database from U.S. EPA, total estimates of annual emissions of VOCs into the air from stationary and mobile sources in the U.S. were approximately two million tons nationally in 1999. Annual emissions of VOCs from coating and allied facilities were estimated to be 26,500 tons. Commonly used organic solvents include aromatics, acetates, ethers, and ketones, and nearly a hundred types of solvents are used (Hsu, 2000). The use of conventional VOC control processes such as wet scrubbing and activated carbon are limited for this application due to the low water solubility of some of the solvents and the high disposal costs of activated carbon. Thus, the search continues for an attractive treatment technology for these waste gas streams.

Equipment painted at DoD maintenance facilities ranges from airplanes and helicopters to tanks, trucks, and miscellaneous parts. Figure 2-1 provides a picture of one such painting operation at Ft. Hood, Texas, where tanks, helicopters, automobiles, and miscellaneous equipment are painted.



Figure 2-1. Paint Spray Booth at Ft. Hood Army Base, Texas.

At DoD facilities, paint booths typically operate 4 to 8 hours per day during the week and shut down on weekends and holidays. However, high-throughput facilities may operate three shifts per day and on weekends when required (Ayer and Proffitt, 1998). Ventilation rates through paint booths vary greatly depending on the size of the booth; however, air flow rates on the order of 10,000 to 40,000 scfm are common with even higher (*e.g.*, 100,000 scfm) ventilation rates possible for some large painting operations. The ventilation rate through a particular paint booth is constrained by health and safety requirements as established by OSHA and the National Fire Protection Association (NFPA-33) which generally require that a minimum air velocity be maintained through the booth and that the VOC concentration in the booth remains below 25% of the lower explosive limits (NFPA 33). If the concentration of any hazardous component in the booth air is expected to be above Permissible Exposure Limits (PELs) set to protect worker health, painting personnel are required to wear protective equipment, which may include full chemical protective clothing and supplied air lines (see Figure 2-2). Use of personal protective equipment is allowed only after material and process options to lower concentrations of air toxics have been exhausted.

Conventional paint booths are designed such that the ambient air is pre-filtered, heated if necessary, and then passed through the painting area. The air contaminated with paint overspray and particulate matter (PM) is then passed through a series of downstream filters (see Figure 2-3) before being exhausted to the ambient air or sent to a VOC control system. PM₁₀ control efficiencies of greater than 99% are possible with these filtration systems; however, greater PM breakthrough can occur if the filters are not properly sealed or maintained (Ft. Hood, 2000). Efficient removal of particulate matter is important because excessive particulate breakthrough will generally decrease performance of downstream VOC control units such as biofilters or even catalytic oxidizers.

A wide variety of paints, primers and thinners are used at DoD maintenance facilities. The range of paint products used at even a single paint booth can be quite variable. For instance, over a one-month period during 2004, painting personnel

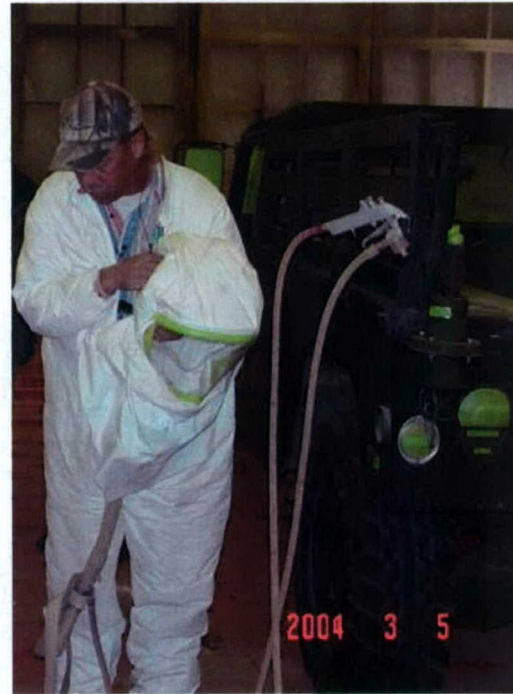

Figure 2-2. Painter with Protective Equipment and Supplied Air Line.

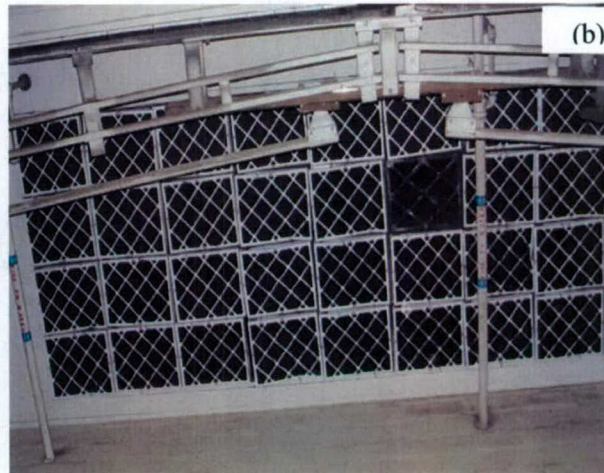
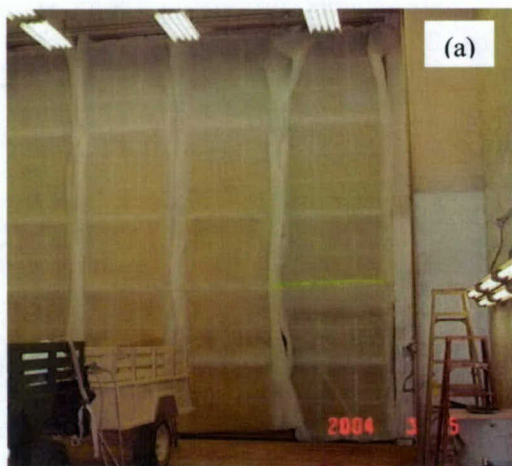

Figure 2-3. Particulate Filtration System at DoD Paint Spray Booth: (a) Particulate and Paint Overspray Pre-filtration System at End of Paint Booth and (b) Bank of High-Efficiency Particulate Filters Located in Ceiling of Paint Booth.

used six different paints, two different primers as well as a thinner product to paint vehicles and helicopter parts at a single paint booth at Ft. Hood, Texas (Ft. Hood, 2004). Although the composition and VOC content of each paint product varies, several VOCs are commonly found

in the paints, primers and thinners used at DoD facilities (see Table 2-1). As noted in the table, several of these VOCs are classified as HAPs by the Environmental Protection Agency.

TABLE 2-1. VOLATILE ORGANIC COMPOUNDS EMITTED FROM PAINT SPRAY BOOTHS AT DOD FACILITIES⁽¹⁾.

acetone	methyl amyl ketone	toluene (HAP)
butanol	methyl cyclohexane	ethyl 3-ethoxypropionate
butyl acetate	methyl ethyl ketone (HAP) ⁽²⁾	<i>o, m, p</i> -xylenes (HAP)
ethylbenzene (HAP)	methyl isobutyl ketone (HAP)	trimethylbenzene
<i>n</i> -heptane	methyl pentyl ketone	
methyl acetate	methyl propyl ketone	

⁽¹⁾ Tyndall, 1999; Webster, 1998 a,b; Ft. Hood, 2001, 2003; Anniston, 2000.

⁽²⁾ Hazardous Air Pollutant

Because most DoD painting operations are dynamic in nature (with paint guns frequently turned on and off as necessary), the concentration of VOCs in the waste gas exiting a paint booth can vary over an order of magnitude in a short period (*i.e.*, within 15 minutes to an hour). Also, after painting application is completed, VOCs continue to be emitted from the booth at a lower concentration as the paint cures (MSE Technology, 2002). The total VOC concentrations from conventional booths generally range from a few parts per million by volume (ppm_v) to 300 ppm_v (as carbon) (MSE Technology, 2002; Wander, 1999; Webster, 1998a,b). Thus, paint spray booths generate waste gas streams that are characterized by high volumetric flow rates but relatively low and dynamically varying VOC concentrations. Such waste streams can be very expensive to treat using conventional methods such as incineration, particularly as the cost of natural gas increases (Smith and Brown, 1993; Ayer, 1997; Ayer and Propper, 1998, Deviny *et al.*, 1999; Garner and Barton, 2002).

A relatively recent development in paint booth design has the potential to greatly reduce the volumetric flow rate of the waste gases that must be treated. Paint booths can be designed to operate in a recirculation mode such that a portion of the filtered air exiting the booth is routed back to the intake blowers. The VOC concentration in the booth increases as a result of this recirculation, and a much smaller flow rate of air is continuously vented from the booth to the VOC control system or to the atmosphere. As a result of the decrease in gas flow rate exiting the system, the cost of the VOC control system can be greatly reduced. For example, the flow rate of waste air exiting a paint booth at Ft. Hood was reduced from approximately 38,000 cfm to approximately 20,000 cfm by retrofitting the booth to operate in a recirculating mode. The peak VOC concentration increased from approximately 200 to 300 ppm_v as carbon to 750 ppm_v as carbon as a result of this modification. A ventilated mobile platform may be installed in booths that are operated in recirculating mode to reduce painters' exposure to higher VOC concentrations (MSE Technology, 2002). *****

Whether paint spray booths are operated in a conventional manner or in recirculation mode, there is often a need to remove VOCs in the exiting gas stream. In the US, recently proposed or promulgated regulations impose new limits on VOC emissions from painting operations including those associated with manufacturing automobiles (US EPA, 2002a), metal furniture (US EPA, 2002b), large appliances (US EPA, 2001), and miscellaneous metal parts (US EPA,

2002c). Because the regulations applicable at a particular facility depend on what is being painted as well as regulations promulgated at the state or local levels, treatment objectives for VOC control technologies vary from facility to facility. Additionally, it is likely that some facilities will be primarily concerned with keeping total HAP emissions at a level less than 10 tons/year of any single HAP or 25 tons/year for a combination of all HAPs in order to avoid classification as a major source under the Clean Air Act Amendments.

2.2 Overview of Biofiltration Technology

As noted earlier, biofiltration technology has the potential to be an effective treatment process for the VOC-laden waste gases exiting paint spray booths at DoD maintenance facilities. Conceptually, the biofiltration process can be divided into three basic steps. First, a pollutant in the gas phase is passed through a biologically active packed bed. The pollutant then diffuses into the biofilm immobilized on the packing medium. Finally, microorganisms growing in the biofilm oxidize the pollutant as a primary substrate or co-metabolite and in the process convert contaminants into the benign end products of carbon dioxide, water and additional biomass (Swanson and Loehr, 1997; Madigan 2000).

Historically, biofiltration has been most commonly applied to remove odorous compounds such as H₂S from air emissions at wastewater treatment plants. Since the 1980s, however, biofiltration has also been used to eliminate VOCs in gases emitted from a wide range of processes (van Groenestijn and Hesselink, 1995; Leson and Winer, 1991). This technology is attractive for many reasons including its ability to convert pollutants into such inert products as CO₂ and H₂O at ambient temperatures. Another advantage of biofilters is that they do not generate secondary contaminant problems and thus are an environmentally friendly treatment method. Biofilters and biotrickling filters can be a more cost-effective option than conventional air pollution control methods for high-volume, low-concentration gas streams containing readily biodegradable contaminants (van Lith *et al.*, 1997). Finally, because these systems operate at ambient temperatures and do not require high-temperature media regeneration systems, they have lower energy requirements than competing technologies.

The following subsections provide an overview of the various types of biofilters in current use, the mechanisms for VOC removal in these systems, key performance and operating parameters, and current applications of this technology.

2.2.1 Basic Types of Biofiltration Systems

Three primary bioreactor configurations are available to treat stationary sources of air pollution such as those emitted from paint spray booths. These various reactor configurations are generally referred to as biofilters, bioscrubbers, and biotrickling filters (Ottengraf, 1987; van Groenestijn and Hesselink, 1994). Each technology operates under different conditions as summarized briefly in Table 2-2.

TABLE 2-2. CLASSIFICATION OF BIOREACTORS FOR WASTE GAS TREATMENT (Ottengraf, 1987).

Reactor Type	Microorganisms	Aqueous Phase
Biofilter	Fixed	Stationary
Biotrickling Filter	Fixed	Flowing
Bioscrubber	Suspended	Flowing

Biofilters (Figure 2-4) are the simplest and oldest of the three vapor-phase bioreactors and involve passing a contaminated air stream through a reactor containing biologically-active packing material. The contaminants are transferred from the air stream into a biofilm immobilized on the support media and are converted by the microorganisms into carbon dioxide, water, and additional biomass. Moisture is typically supplied to the biofilm in a humid inlet waste gas stream. Packing media used in biofilter beds can be broadly categorized as either “natural” or “synthetic”. Natural media include wood chips, peat, and compost, with compost by far the most widely used. Synthetic media include activated carbon, ceramic pellets, polystyrene beads, ground tires, plastic media, and polyurethane foam (Moe and Irvine, 2000, 2001). Natural organic packing media generally contain a supply of nutrients (*i.e.*, nitrogen, phosphorus, and other elements necessary for microbial growth) as a naturally occurring component of the packing itself. When a synthetic support medium is used, nutrients must be added for microbial growth. Nutrients may be mixed with the packing material before biofilter assembly or added in solution sprayed on or mixed with the packing material after construction. If a biofilter requires additional nutrients, a nutrient solution may be sprayed on to the reactor’s packing medium; however, a continuous flowing liquid stream is not present (Devinny *et al.*, 1999; van Groenestijn and Hesselink, 1994).

Biotrickling filters (Figure 2-5) are similar to biofilters with the exception that there is a liquid nutrient medium continuously recirculating through the column. To facilitate recirculation of the liquid phase, rigid synthetic media (*e.g.*, plastic media, polyurethane foam, or lava rock) is used as the packing medium. Microorganisms grow primarily as a fixed film on inert packing media; however, organisms also present in the liquid phase both because they can grow suspended in the liquid and because the flowing liquid imparts a sufficient shear force to detach biomass from the solid support media. The air and liquid streams can move either co-currently or counter-currently depending on the operating conditions. Contaminants are transferred from the air stream into the liquid phase and biofilm for subsequent degradation (Devinny *et al.*, 1999; van Groenestijn and Hesselink, 1994).

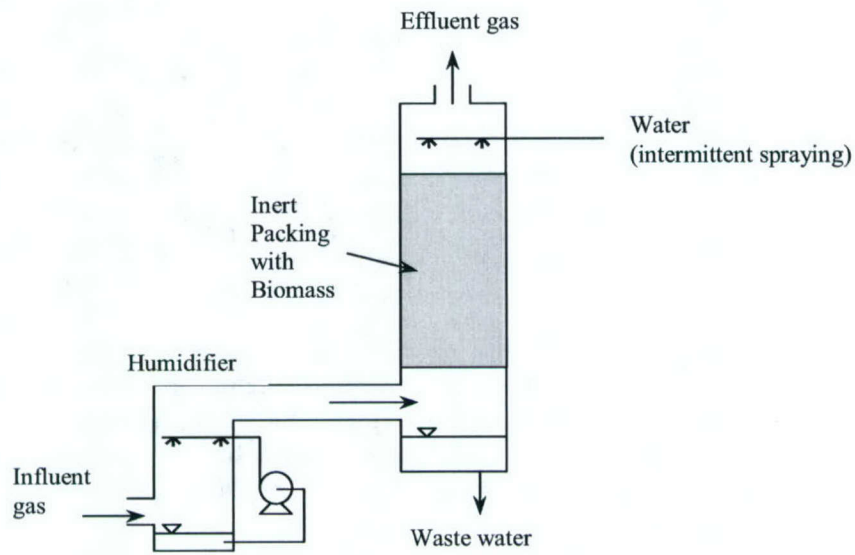

Figure 2-4. Diagram of a Biofilter (Van Groenestijn and Hesselink 1994).

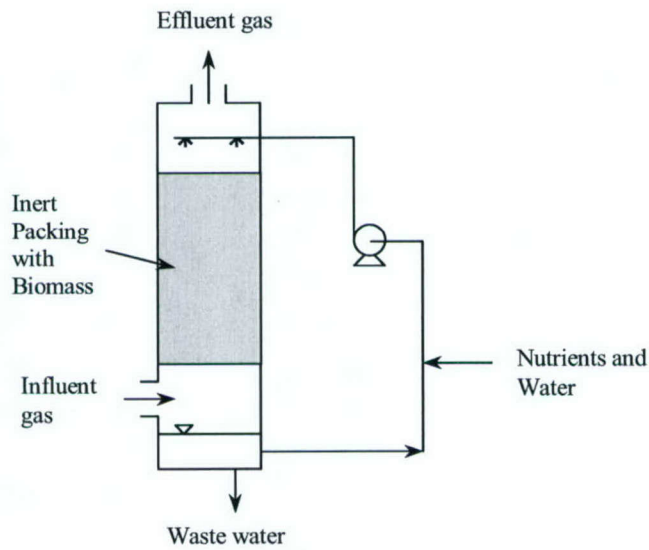

Figure 2-5. Diagram of a Biotrickling Filter (Van Groenestijn and Hesselink 1994).

In comparison to conventional biofilters, biotrickling filters offer the advantages of increased operator control over such key parameters as nutrient concentrations and pH , as well as the opportunity to wash degradation by-products out of the reactor (Devinny *et al.*, 1999; van Groenestijn and Hesselink, 1994). A potential disadvantage of biotrickling filter operation, however, is that clogging of the pore space can occur if the biotrickling filter is treating high VOC loads and is provided excess nutrients (Webster *et al.*, 1998a; 1998b; Sabo *et al.*, 1998, Cox and Deshusses, 1997; Sorial *et al.*, 1995). An additional disadvantage to biotrickling filter operation compared to “classic” biofilters is the need to manage the liquid stream. Furthermore, the specific surface area in biotrickling filters is generally lower than in biofilters (Ottengraf, 1987); therefore, biotrickling filters may have more difficulty treating poorly soluble compounds.

Bioscrubbers (Figure 2-6) combine physical–chemical treatment with biological treatment using two separate reactors to accomplish treatment. In the first reactor, the contaminated air stream is contacted with water in a reactor packed with inert media, resulting in contaminant transfer from the air phase to the liquid phase. The liquid is then directed into an activated sludge reactor where the contaminants are biologically degraded (van Groenestijn and Hesselink, 1994; Ottengraf, 1987). The separate activated sludge tank allows the reactor to treat higher concentrations of compounds than biofilters can handle. In addition, since compound transfer and degradation occur in separate reactors, optimization of each reactor can take place separately. As with biotrickling filters, bioscrubbers offer greater operator control over nutrient supply, acidity, and the build up toxic by-products. A potential disadvantage of bioscrubbers over biofilters, however, is that slower growing microorganisms may be washed out of the system and disposal of excess sludge is required (Kok, 1992).

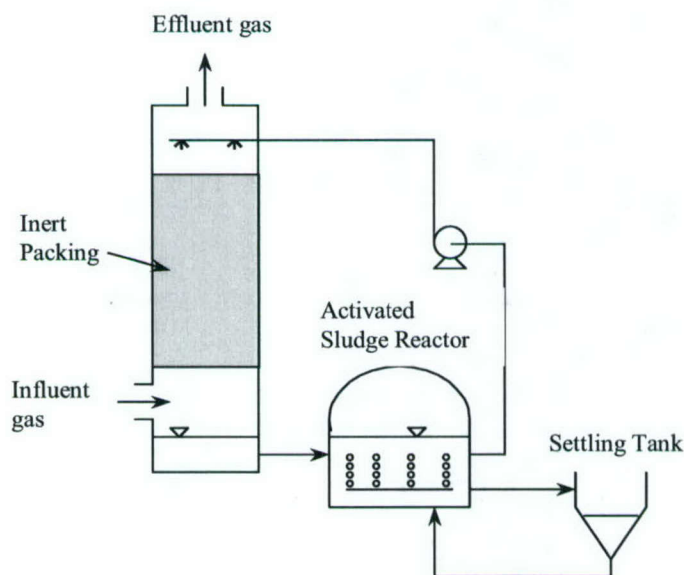

Figure 2-6. Diagram of a Bioscrubber (Van Groenestijn and Hesselink 1994).

2.2.2 Mechanisms of VOC Removal

Conceptually, biodegradation of pollutants in the biofilm of a biofilter or biotrickling filter consists of two steps: (1) mass transfer of the target pollutant from the gas phase to the liquid biofilm phase containing microorganisms, and (2) biological degradation of the pollutants as carbon and energy sources for the microorganisms within the biofilm. Figure 2-7 illustrates the mass transfer and biodegradation processes occurring at the microscale level.

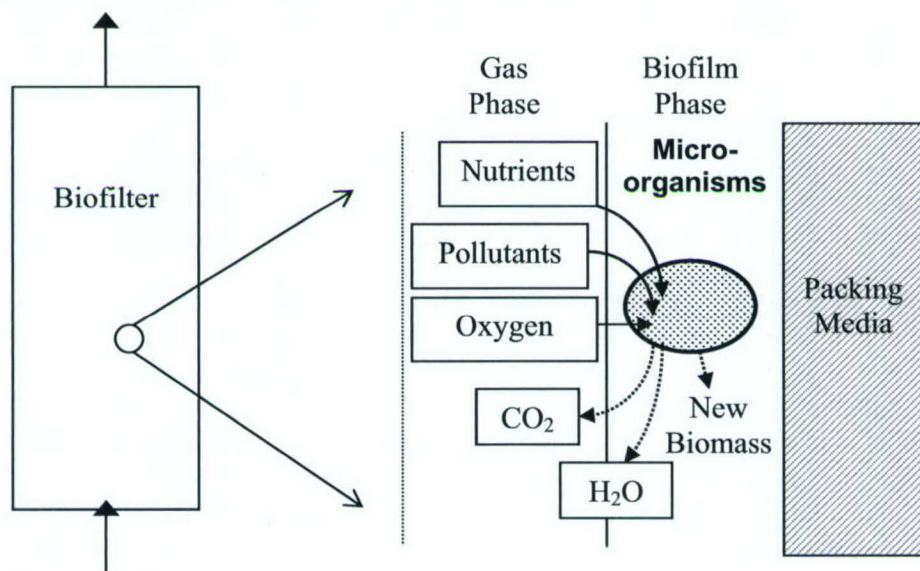

Figure 2-7. Biodegradation Processes and Biological Reactions Occurring in a Biofilter.

For biodegradation to occur in a biofiltration system, the pollutant must be transferred to the biofilm phase. Less-soluble substances need a large gas/liquid surface area to obtain sufficient pollutant mass transfer for efficient destruction in vapor-phase bioreactors.

2.2.3 Microorganisms

Once VOCs are transferred into the biofilm phase, biodegradation is controlled by the substrate utilization kinetics of microorganisms capable of degrading the pollutants. Although both bacteria and fungi have been found in biofilters treating VOC-contaminated streams, the focus of most studies to date has been on the degradation capabilities of the bacterial populations that are commonly found in biofiltration systems. Recently, however, fungal biofilters have been investigated since they have the potential advantages over bacterial bioreactors. Fungal biofilters may be more tolerant of fluctuating inlet concentrations and low moisture content and pH levels (Kraakman *et al.*, 1997; Cox *et al.*, 1993a; Cox *et al.*, 1997; Pakula and Freeman 1996; Majcherczyk *et al.*, 1989; Kraakman *et al.*, 1997). They generally have lower minimum nutrient requirements than bacterial biofilters and can maintain high removal efficiencies even under nutrient-depleted conditions (Woertz *et al.*, 2001; Weber and Hartmans 1996). For selected VOCs, fungal vapor-phase bioreactors have also achieved elimination capacities more than two times greater than those reported for high-efficiency bacterial systems (Song and Kinney 2000;

Wu *et al.*, 1999) and up to seven times greater for those reported for typical bacterial systems (Smith *et al.*, 1996; Pedersen and Arvin 1997; Sabo *et al.*, 1993).

Following inoculation with a mixed microbial culture, biofilters often contain microbial populations capable of utilizing a broad range of VOCs as energy and nutrient sources. However, if the inoculum is not pre-acclimated to the pollutant mixture, a microbial population capable of degrading the target VOCs may not be present initially in the packing media in sufficient numbers for efficient pollutant removal, and a long start-up period may result. Inoculation with a pre-acclimated culture can accelerate the start-up process and allow more stable operation. In field applications, activated sludge from a wastewater treatment plant or seeding materials from another biofilm can be used as an inoculant (van Groenestijn and Hesselink, 1994). Pure or mixed cultures of specialized microorganisms have been used in numerous studies to reduce the acclimation period and enhance pollutant removal efficiency (Leson and Winer, 1991; Smith *et al.*, 1996; Pedersen *et al.*, 1997; Sun *et al.*, 1998).

Although numerous investigations have focused on the pollutant-degrading capacities of specific microorganisms and the physiological characteristics of these microorganisms, most biofiltration systems contain undefined mixed cultures. The microbial community in a biofilter treating even a single chemical can contain dozens of interacting microbial species. For instance, in a biotrickling filter treating styrene, significant diversity was observed in a study of population dynamics conducted using a denaturing gradient gel electrophoresis (DGGE) method (Tresse, 2002). In this study, the biofilm community was found to be more complex than the suspended cell community. In addition, only 50 % of the bands representing the inoculum were present in the established biomass. This suggests that biomass established in the column was subjected to further enrichment in the biofilter, even though the inoculum was already adapted to styrene. Similarly, Stoffels (1998) observed two significant shifts in the bacterial community structure in a trickle-bed bioreactor using fluorescent *in-situ* hybridization (FISH). One significant shift occurred followed the transfer of the original inoculum from the wastewater to the fermentor. Another significant shift was observed when the fermentor culture was transferred to the trickle-bed bioreactor (Stoffels, 1998). In another study, *Pseudomonas putida*, *Pseudomonas putida* biotype A, *Rhodococcus* sp., and *Arthrobacter paraffineus* were individually incubated with toluene and mixed before biofilter inoculation (Jorio, 1988). When toluene and xylene were present together, toluene biodegradation was inhibited by the presence of xylene in the biofilter. Several weeks after start-up, none of the inoculating strains remained dominant in the biofilm. However, all strains isolated from the biofilm were positive in at least one physiological property related to the degradation of aromatic organic molecules (Jorio, 1998). These results suggest that while inoculation of a bioreactor system may enhance startup of the system, the microbial population within a biofilter will likely evolve with time.

2.2.4 Bioreactor Performance—VOC Removal

Bioreactor performance can be quantified and evaluated using several parameters. It would be preferable to choose a single parameter that would be easy to determine and would accurately predict bioreactor performance and the kinetics of biodegradation processes in vapor-phase bioreactors. However, it is inevitable that several parameters are required to obtain a clear understanding of a biofilm system and biodegradation processes (Murphy *et al.*, 1995). One of the most simple and widely used parameters used to evaluate bioreactor performance is overall

pollutant removal efficiency (RE), which is defined as the fraction of the inlet pollutant removed in a biofilter. However, RE can vary with inlet pollutant concentration, air residence time, and microbial activity. In addition, RE is a function of operational period and biomass quantity in biofilters. Consequently, this parameter is most useful when comparing results obtained under a given operating condition in vapor-phase bioreactors.

Pollutant elimination capacity (*EC*) is another commonly used parameter to assess bioreactor performance. *EC* is defined as follows:

$$EC = \frac{Q(C_{in} - C_{out})}{V} \quad (\text{g - pollutant/m}^3 \text{ - hr}) \quad (2-1)$$

where, C_{in} is the inlet concentration (g/m^3), C_{out} is the outlet concentration (g/m^3), Q is the gas flow rate (m^3/hr), and V is the bioreactor volume (m^3).

EC curves are determined by sequentially increasing the inlet concentration stepwise for several hours until quasi-steady state is reached (Deshusses and Johnson, 2000). Several VOC loadings are applied to a bioreactor, and the corresponding *EC*s are calculated using equation 2-2 above. Two parameters determined from the *EC* curves developed in this manner are commonly used as an indicator of bioreactor performance: (1) maximum *EC*, and (2) critical loading. Maximum *EC* is the point where an *EC* curve has its highest value, while critical loading is defined as the point at which the *EC* starts to deviate from the 100% removal line (Deshusses and Johnson, 2000). These two parameters are very useful to evaluate bioreactor performance under various conditions. However, it should be recognized that these parameters are not normalized by the quantity of microorganisms in a bioreactor. Therefore, the *EC* of a bioreactor varies with time of operation and is a function of biomass quantity, nutrient supply, and other operating parameters. Care should be given when interpreting *EC* data, particularly when biomass quantity significantly varies with operational period. Nevertheless, previous studies have shown that the major contaminants found in paint booth off gas streams (e.g., methyl ethyl ketone, methyl isobutyl ketone, ethyl acetate and toluene) can be efficiently degraded in biofilters (Deshusses, 1995; Shi *et al.*, 1995; Corsi and Seed, 1995; Kinney, 1996a). For instance, relatively high pollutant elimination capacities of 44 and 45 grams-pollutant/ m^3 -media/hr have been reported for biofilters treating methyl ethyl ketone and toluene, respectively (Deshusses, 1995; Corsi and Seed, 1995).

2.2.5 Other Key Operating Parameters

Many factors influence performance, treatment costs, and long-term stability of bioreactors for air pollution control. These factors include moisture content, pH, and bed temperature (Devinny *et al.*, 1999). Nutrient availability is also critical to biofilm establishment and maintenance, factors that directly affect performance. Packing media characteristics also play a major role in bioreactor start-up and performance. The following sections briefly discuss the bioreactor operating parameters that are of particular interest to the design and operation of bioreactors for paint spray booth applications.

Packing Media. While inert packing is typically used in biotrickling filters, many biofilters utilize such organic packing materials as compost, peat, or wood chips, which can compact and

degrade over time. A decline in performance eventually results, and the packing media must be periodically replaced. Inert packing materials are much more durable and recent advancements in design have enabled shorter start-up periods and allowed extended periods of stable operation (Song and Kinney, 1999; Song and Kinney, 2000; Moe and Irvine, 2001). An advantage of inert packing materials is that they allow a higher degree of control over such key operating parameters as nutrient delivery and biomass distribution and removal. Additional desirable packing media characteristics include: (1) high porosity to allow biofilm accumulation without a concomitant increase in head loss, (2) high surface area to facilitate mass transfer, (3) an open structure that can be cleaned easily to remove excess biomass, (4) a lightweight material that is durable and does not compact over time, and (5) an inexpensive packing that is readily available and well characterized.

Moisture. Moisture contents of 20–70% by weight are generally recommended for biofilter operation in cases where “natural” packing media (*e.g.*, compost) are used, with optimal moisture contents centering at 30–50% (van Groenestijn and Hesselink, 1994; Mueller, 1998). For synthetic packing media, the optimum moisture content will vary from one medium to the next, and in general, the appropriate moisture content must be experimentally determined.

pH. The ideal *pH* range varies by microbial species, but a neutral *pH* range is typically recommended (Madigan *et al.*, 2000). Fungi have been found to function well at a low *pH*, and can sometimes control the *pH* to more acidic conditions. Hence, maintaining a basic liquid *pH* can help to limit fungal infiltration of bioreactors. Acidification due to the accumulation of acidic degradation by-products is a common cause of *pH* reductions and inhibition of microbial activity (Neal, 1998). The addition of buffers in the form of phosphate, lime, or ammonium hydroxide in the liquid can help to control *pH* (Barshter *et al.*, 1993; Madigan *et al.*, 2000). The *pH* of leachate and/or recirculating liquid medium should be measured regularly and controlled to achieve optimal substrate removal (Barnes *et al.*, 1995; Davidova *et al.*, 1997; Lee *et al.*, 1995).

Pressure Drop. Pressure drop is a macroscopic parameter that should be monitored to ensure stable performance of biofiltration systems. Pressure drops are generally low across biofiltration systems (*e.g.*, less than 1 inch water column per 3 feet of packed-bed depth). However, if biomass clogging occurs, the pressure drop across the bioreactor can increase very rapidly.

Nutrients. Microorganisms require such nutrients as nitrogen, phosphorus, potassium, sulfur, and trace metals in addition to a carbon source to form new cell material. Nitrogen typically makes up 12 to 13% of dry cell mass, and phosphorus typically makes up 2 to 3% of the dry cell mass (Metcalf and Eddy, 1992). When nitrogen demand for biomass growth exceeds the nitrogen available in the biofilm, the biofilm becomes nitrogen limited and a decline in biofilter performance is generally observed (Rihn *et al.*, 1997; Morgenroth *et al.*, 1996; Moe and Irvine, 2001; Holubar *et al.*, 1999; Morales *et al.*, 1998). A few attempts have been made to determine the minimum media nitrogen level needed to maintain high contaminant removal efficiencies in compost biofilters (Song *et al.*, 2003). Corsi and Seed (1995) reported that a media nitrogen level of 200 mg/kg was needed to maintain BTX removal rates of greater than 30 g/m³/h in a compost biofilter. In contrast, Gribbins and Loehr (1998) reported that a media nitrogen level of 1000 mg/kg was required in a compost biofilter to effectively remove toluene at the same loading rate. Bioreactors that are packed with synthetic media require an external supply of nitrogen to

maintain performance. Biofilters packed with compost-based material, on the other hand, generally contain sufficient nutrients for initial operation although nutrient supplementation may be required to maintain performance.

Residence Time. The empty-bed contact time, or residence time, is defined as the empty-bed filter volume divided by the air flow rate. Residence time can have a large impact on removal efficiencies. Bioreactor performance typically decreases with decreased residence times and faster air flow rates (Wright *et al.*, 1998; Kozliak *et al.*, 2000; Deshusses and Hamer, 1993). Lower residence times are desirable, however, as they yield smaller reactor sizes and reduced capital costs.

2.2.6 Previous Applications of Biofiltration Technology

Biofiltration has been applied to control odors from wastewater treatment plants and industrial processes for more than five decades (Carlson, 1966). More recently, biofiltration applications have been expanded to treat VOC-laden waste gases emitted by industry (Ottengraf, 1986, van Groenestijn, 1994; Swanson and Loehr, 1997). Biofiltration is also commonly used for odor control in Europe and Japan (Allen, 1993).

TABLE 2-3. INDUSTRIES USING BIOFILTRATION IN EUROPE
(Leson, 1991).

Chemical Operations	Coffee Roasting
Composting Facilities	Chemical Storage
Coca Roasting	Landfill Gas Extraction
Film Coating	Fish Frying
Slaughter Houses	Investment Foundries
Flavors and Fragrances	Tobacco Processing
Print Shops	Pet Food Manufacturing
Waste Oil Recycling	Industrial and Municipal Wastewater Treatment Plants

All of these sources typically emit large volumes of off-gases that contain only low concentrations of the target organic compounds. Table 2-4 presents an abbreviated list of chemicals that can be treated by biofiltration (Barnes *et al.*, 1995; Barshter *et al.*, 1993; Ergas *et al.*, 1995; Hodge *et al.*, 1991; Morgenroth *et al.*, 1995; Mueller, 1998; Ottengraf and VanDenOever, 1983).

TABLE 2-4. ABBREVIATED LIST OF CHEMICALS TREATABLE BY BIOFILTRATION.

Acetate	Dimethyl sulfide	Methyl propyl ketone
Acetone	Ethanol	Methyl mercaptan
Ammonia	Ethylbenzene	Nitrogen oxide
Benzene	2-Ethylhexanol	Nitrogen dioxide
Butanol	Hexane	Pentane
Butylaldehyde	Hydrogen sulfide	Styrene
Butyl acetate	Indole	Tetrachloroethylene
Carbon monoxide	Isopropyl alcohol	Thiophene
Mono-, Di-, Tri-chloromethane	Methane	Toluene
Diethylamine	Methanol	Trichloroethene
Dimethyl disulfide	Methyl ethyl ketone	Xylene

2.3 Previous Paint Spray Booth Studies

A few studies have been conducted to evaluate the performance of biofiltration systems treating paint booth emissions. Kim *et al.* (2000) investigated the feasibility of using a biological treatment process for gaseous VOCs emitted from automotive painting operations. A comparison of the biological VOC removal process to vapor-phase adsorption followed by thermal oxidation indicated that the biological process was an order of magnitude more cost effective in capital cost and a factor of two more cost effective in O&M cost. In this study, biological processes achieved similar overall VOC removals comparing to adsorption/ thermal oxidation (33 to 36 % VOC removal by the biological process and 27 to 42 % VOC removal by the carbon adsorption/thermal oxidation). Even though all of the hydrophilic solvents were captured in a bench-scale activated sludge reactor and biologically degraded, the hydrophobic compound removal was very poor (Kim, 2000).

A few other studies have been conducted to investigate biofilters and biotrickling filters treating paint VOCs (Webster, 1998; Hsu, 2000; Boswell, 2001). Boswell *et al.* (2000) described a full-scale biofilter used to treat the off-gas stream from a paint production unit at a paint manufacturing facility. The VOC mixture was dominated by toluene, xylene, methyl ethyl ketone (MEK), acetone and ethylbenzene. They achieved approximately 60% overall VOC removal with the biofilter and demonstrated that the capital cost of the biofilter was significantly less than that of a thermal oxidizer. Also, operating costs were less than 10% of a comparably sized regenerative oxidizer (Boswell, 2000). Hsu *et al.* (2000) demonstrated that a pilot-scale biofilter could achieve up to 95% overall VOC removal when the major organic compounds were xylene, toluene, methyl ethyl ketone (MEK), isopropyl alcohol, and *iso*-butanol. Annual construction and operation costs of the biofilters were estimated to be approximately 40% less than those for the activated carbon adsorption and catalytic thermal oxidation (Hsu, 2000).

Most studies showed reliable performance of a biofilter and biotrickling filter in terms of overall VOC removal. However, the hydrophobic components of the VOC mixture seem to limit the overall removal achievable in a biofilter. In a study reported by Webster (1998), a pilot-scale biotrickling filter was set up to treat off-gases from paint spray booths. Three different packing

materials were tested: (1) a 50/50 (v/v) polyurethane foam/plastic random packing mix, (2) plastic random packing alone, and (3) a structured, straight-channel packing. The primary VOC contaminants were toluene, MEK, xylene, and *n*-butyl acetate (NBA). After a 5-day start-up period, MEK and NBA were removed with greater than 98 % removal. However, toluene and xylene removal was much lower, with average contaminant removal efficiencies of 78% and 69%, respectively, in the optimal packing material (a mixture of polyurethane foam cubes and random dump pack) among the three media tested. For the least-efficient packing material, a straight-channel packing, only 32 % and 28 % removal of toluene and xylene were achieved, respectively (Webster, 1998). Thus, while biofiltration seems to be a promising technology, additional optimization of the technology is required.

2.4 Challenges Facing Biofilters for Paint Booth Applications

While biofiltration has the potential to be an effective treatment method for VOCs emitted from painting operations, several challenges must be addressed for successful application of this technology. These challenges include the presence of VOC mixtures in the paint off-gas stream and the dynamic and intermittent nature of the emissions. The following sections provide an overview of how these factors may affect biofilter performance.

2.4.1 Effect of VOC Mixtures on Pollutant Degradation

Although many waste gas constituents have been successfully treated using biological methods when they are present as individual compounds or simple mixtures, complex mixtures can be problematic when biological treatment processes are applied (Ottengraf *et al.*, 1987). Complex kinetic inhibition and/or repression often exist in systems where multiple contaminants are present. Consequently, achieving consistent removal of all compounds can be problematic even when the compounds are easily removed when present as single contaminants. In treatment of mixtures of VOC contaminants, numerous researchers have reported that one or more compounds are not degraded until after other compounds have been degraded to very low concentrations. This frequently results in a spatial separation of zones for degradation of different compounds as a function of height in a biofilter bed. For example, during the operation of several laboratory-scale biofilters and biotrickling filters for treatment of a simulated paint spray booth waste stream, Kazenski and Kinney (2000) observed that degradation of toluene and *p*-xylene did not occur until after methyl *n*-propyl ketone, ethyl 3-ethoxypropionate, and *n*-butyl acetate reached very low concentrations. Similar results have been reported by others (Deshusses *et al.* 1995, 1999; Webster *et al.*, 1998; Mohseni and Allen, 1998; Kazenski and Kinney, 2000; Atoche and Moe, 2004; Qi and Moe, 2004).

Because DoD paint spray operations generate waste gas streams containing a complex mixture of readily degradable (*e.g.*, ethyl acetate) and relatively recalcitrant compounds (*e.g.*, ethylbenzene), substrate competition or inhibition may occur during the biodegradation of these mixtures in biofilters. If not properly accounted for in design and operation, this may lead to one or more undegraded target compounds' being emitted from a biofilter or it may result in a requirement for unacceptably large biofilter to ensure adequate removal of the most slowly degraded compound. Although BTEX compound interactions have been studied extensively for pure and mixed microbial species, few studies have been conducted to investigate substrate interactions among VOCs mixtures found in paint. To effectively apply biofiltration technology

to treatment of off-gas streams from paint spray operations, the substrate interactions that occur in biofilters degrading paint VOC mixtures need to be understood.

The positive or negative effects of VOC mixtures on biofilter performance will vary with pollutant concentration and the microbial species involved in the degradation. The complexity increases as the number of VOC substrates involved in the biodegradation process increase. Nevertheless, VOC emissions from paint booths are variable but contain a mixture of ketones, a few aromatic hydrocarbons and acetate species. Thus, understanding the response of various biofilter configurations to this type of mixture is key to optimizing a biofiltration system for treating paint booth emissions.

2.4.2 Effect of Unsteady-State Booth Operation on Biofilter Performance

Under steady feed conditions, vapor-phase bioreactors have proven to be an effective technology for removing odors and volatile organic compounds from waste gas streams (van Groenestijn and Hesselink 1994; Wani *et al.*, 1997). However, when these systems are subjected to dynamic feed conditions or shutdown-and-restart situations as would be expected at paint booth facilities, reliable performance is more difficult to maintain.

Loss of biomass activity during shutdown periods is one common reason for poor bioreactor performance. Several studies have demonstrated that a substantial reduction in the pollutant-degrading capacity of the biomass can occur under carbon-deprived conditions (Martin and Loehr, 1996; Wani *et al.*, 1998; Wright *et al.*, 1998; Jenkins and Heald, 1996; Choi *et al.*, 1998). In one study, a biofilter required 9 to 24 hours to recover full degradation activity after a four-day shutdown (Martin and Loehr, 1996). In general, the longer the shutdown period, the greater the re-acclimation period required before full removal efficiency was restored. Such periodic bioreactor shutdowns are common for paint booths that operate only during the day, and the slow recovery of bioreactor systems is an obstacle that must be overcome for these biological systems (Deshusses *et al.*, 1996; Choi *et al.*, 1998; Shi *et al.*, 1995). Even though the re-acclimation period following process shutdowns is often much shorter than the initial start-up period (Martin and Loehr, 1996; Mohseni and Allen, 1998; Moe and Qi, 2004), the contaminant removal efficiency during the re-acclimation period can be low (Choi *et al.*, 1998). Thus, a method to improve the transient response of biofilters upon restart may be required for successful use of biofilters to treat the emissions from paint booth facilities.

Another potential difficulty is the unsteady-state nature of contaminant loading within the interval when contaminants are generated (*i.e.*, variation with the interval when painting is conducted). Emissions from most DoD painting operations are characterized by dynamically varying VOC concentrations. If not properly accounted for in design and operation of biofilters, the sometimes severe variations in VOC concentration may result in dynamic "shock" loads that exceed biological reaction capacities and result in contaminant emission from biofilter systems. Contaminant emissions during short-term, unsteady-state loading conditions have been reported for a number of biofilter applications treating a wide variety of different compounds (Boyette *et al.*, 1995; Chang and Yoon, 1995; Martin and Loehr, 1996; Kinney *et al.* 1996; Mohseni *et al.*, 1998; Deshusses *et al.*, 1999; Irvine and Moe, 2001; Moe and Li, 2004; Atoche and Moe, 2004). Although not necessarily a concern in cases where treatment goals are based on a total pounds per year emissions limit or where removal efficiency is averaged over long time periods (*e.g.*, a monthly basis), excessive contaminant emissions during transient loading conditions may be

problematic in cases where air pollution control regulations require a specified removal efficiency (*e.g.*, 90%) on a continuous basis. In such cases, a biofilter unable to maintain high removal efficiency during short-term periods of shock loading may not meet regulatory compliance even if it is able to achieve the required removal efficiency during “normal” operations over long time periods.

This is of particular concern when biofilters are applied to waste gas streams containing complex mixtures of VOCs. Although problems associated with inhibition or other complex kinetics can sometimes be overcome by designing biofilters with sufficiently deep beds or sufficiently long residence times to allow for complete degradation of different compounds at different locations in the bed, such solutions can be problematic for the unsteady-state conditions frequently encountered in industrial painting operations. This effect can be readily observed in data reported by Deshusses *et al.* (1999) for a mixture of ethyl acetate and toluene. Presence of ethyl acetate was found to inhibit degradation of toluene. Consequently, toluene degradation occurred only in sections of the biofilter column furthest from the inlet where ethyl acetate concentrations were low. When the inlet ethyl acetate concentration was sufficiently high that it was present throughout the entire height of the biofilter column, toluene passed through the column almost completely undegraded in spite of the presence of toluene-degrading microorganisms. During transient periods of elevated contaminant loading (*i.e.*, a “shock load”) when the contaminant loading rate exceeds the biological reaction capacity for the most readily degraded compounds, essentially no degradation of less readily degraded compounds can occur. Such results are especially problematic when the less readily degraded compounds (*e.g.*, toluene or benzene) pose larger health risks or are subject to more stringent regulatory controls than the more readily degraded compounds.

Thus, a detailed understanding of biofilter performance during a variety of unsteady-state loading conditions is required in order to design systems capable of reliable operation under conditions expected at DoD painting facilities.

CHAPTER 3: EXPERIMENTAL APPROACH

The primary objective of this project was to evaluate and improve biofiltration technology for application to paint spray booth emissions at DoD facilities. To this end, multiple bioreactor configurations and design features were investigated as summarized schematically in Figure 3-1. Both single-VOC and surrogate paint-VOC mixtures were investigated first under simplified operating conditions and then under operating conditions more representative of real-world installations, including discontinuous contaminant loading typical of paint spray booths. The research progressed from a series of lab-scale investigations of biofiltration technology to a pilot-scale evaluation of a biofiltration unit treating actual paint spray emissions. Finally, an engineering and economic evaluation of the biofiltration process was completed to delineate the economic feasibility of this technology for a range of conditions.

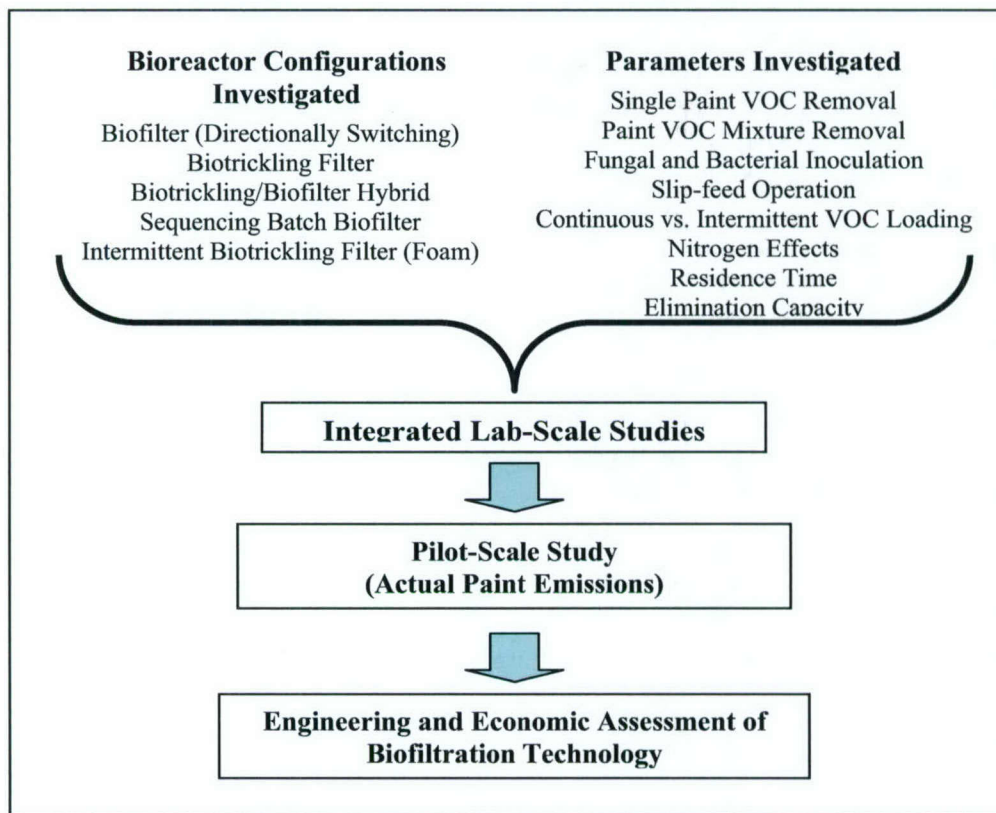

Figure 3-1. Experimental Scope.

The major study phases and tasks associated with this project are delineated in more detail in Table 3-1. The project was divided into nine major phases. Several of the project phases were conducted simultaneously as part of ongoing projects at the University of Texas at Austin and Louisiana State University. After an initial start-up, the Phase 2 experiments focused on understanding how design features such as use of a slip-feed system and directionally switching operation can improve the performance of a biofilter system. During Phase 3, a biotrickling filter was evaluated for its ability to treat a five-component surrogate paint mixture. Because

paint VOC mixtures generally contain hydrophilic, relatively biodegradable VOCs that are readily removed in biotrickling filters and hydrophobic VOCs that may be more easily removed in biofilters, a hybrid bioreactor which combined a biotrickling filter module with a biofilter module was investigated in Phase 4. At the request of SERDP, a fifth study phase was added to the project to evaluate the capabilities of a fungal bioreactor for paint spray booth off-gas streams. As part of this study phase, several fungal species were screened for their ability to degrade paint VOCs, and the performance of a fungal-based system was evaluated. The next study phase (Phase 6) investigated the feasibility of using a sequencing batch bioreactor to treat the dynamically varying VOC concentrations typical of DoD painting operations.

Based on results from the first six study phases, an intermittent biotrickling filter containing polyurethane foam packing media was designed and experimentally tested during Phase 7. As part of the integrated assessment of this bioreactor design at the lab scale, two different VOC-feeding strategies were investigated to determine if they could overcome the limitations observed in previous bioreactor experiments. In addition, DGGE, a molecular tool, was used to monitor how the diversity of microbial community was affected by bioreactor operation. Finally, the response of the lab-scale system to intermittent VOC feed conditions and shorter residence times was investigated. Based on results of these laboratory-scale experiments, a pilot-scale intermittent biotrickling filter was then constructed and tested during Phase 8. The pilot system was first subjected to loading with a surrogate paint mixture and then to intermittent paint emissions expected at an actual paint spray booth. Finally, during Phase 9, the engineering and economic feasibility of biofiltration technology for paint spray booths was evaluated.

TABLE 3-1. EXPERIMENTAL PHASES AND TASKS

Phase 1. Experimental Start-up

Task

- 1.1 Literature search and review
- 1.2 Development of complete experimental plan
- 1.3 Start-up experiments

Phase 2. Evaluation of Biofilter Features

Task

- 2.1 Analysis of the directionally switching system
- 2.2 Evaluation of the slip-feed system
- 2.3 Nitrogen requirements and recycling estimates

Phase 3. Evaluation of Biotrickling Filter

Task

- 3.1 Bioreactor startup and nitrogen effects
- 3.2 Paint mixture degradation
- 3.3 Effect of directionally switching operation
- 3.4 Elimination capacity and residence time experiments

Phase 4. Evaluation of Biotrickling/Biofilter Hybrid

Task

- 4.1 Nitrogen-limited vs nitrogen-rich conditions
 - 4.2 Effect of paint VOC mixtures on elimination capacity
-

TABLE 3-1. EXPERIMENTAL PHASES AND TASKS (CONTINUED)

Phase 5. Assessment of Fungal Bioreactors

Task

- 5.1 Assess paint VOC degradation capabilities (*E. lecanii-corni*)
- 5.2 Assess paint VOC degradation capabilities (other fungi)
- 5.3 Evaluate use of fungi on foam packing material
- 5.4 Evaluate fungal bioreactor operating regime

Phase 6. Evaluation of Sequencing Batch Bioreactors

Task

- 6.1 Assess packing material properties
- 6.2 Evaluate response to dynamic VOC load conditions

Phase 7. Integrated Lab-Scale Evaluation of an Intermittent, Foam Biotrickling Filter

Task

- 7.1 Bioreactor startup and nitrogen effects
- 7.2 Effect of paint VOC mixtures on bioreactor performance
- 7.3 Sequential- vs. continuous-feed experiments
- 7.4 Molecular monitoring results
- 7.5 Intermittent feed response
- 7.6 Elimination capacity and gas-phase residence time experiments

Phase 8. Evaluation of the Integrated System, Pilot Scale

Task

- 9.1 Design and construction of pilot-scale system
- 9.2 Surrogate paint mixture experiments
- 9.3 Actual paint emissions, on/off operation

Phase 9. Engineering Assessment

Task

- 9.1 Summary of Recommended Design and Operating Features
 - 9.2 Economic Analysis of Process
-

The following chapters provide a description of the materials and methods employed in this research project as well as the results associated with each project phase identified above. A significant fraction of the work outlined in Table 3-1 above has been published and thus the detailed methods are provided in the references cited in the appropriate chapter. In cases where the research has not yet been published in peer-reviewed journal papers, additional details are provided in the appendices and the major results of the work are summarized within the appropriate chapter.

CHAPTER 4: EVALUATION OF BIOFILTER DESIGN FEATURES

Biofilters are the simplest and most common type of vapor-phase bioreactor in use today. While the inherent simplicity of the basic biofilter design (see Figure 2-4) is an attractive feature, it can limit the control that operators have over biofilter performance. For instance, unreliable performance can occur after extended periods of operation, due to excess biomass accumulation and inactivation of the pollutant-degrading microorganisms. These problems are most profound when the bioreactors are continuously subjected to high VOC loading rates for extended periods. Another potential challenge facing biofiltration of paint booth emissions is the intermittent nature of the emissions, since paint booths typically do not operate at night or on weekends. Finally, a key issue of importance to basic biofilter systems is the minimum supply of nitrogen required as a nutrient to maintain pollutant degradation while preventing excessive biomass growth. To address these issues, two design enhancements were incorporated into the basic biofilter design and were investigated for their ability to improve biofilter performance: (1) directionally switching operation to improve biomass distribution and activity, and (2) a slip-stream feed system to maintain high biomass activities during paint booth shutdown periods. Additionally, a series of experiments were conducted to estimate the minimum nitrogen levels required to maintain pollutant degradation. The following sections summarize the key results from each of these experiments and discuss their importance for the development of biofiltration for paint spray booths. The experiments described below were conducted in conjunction with an EPA-funded study, and the results have been published in several publications as noted below.

4.1 Directionally Switching Operation

One promising method to improve biomass distribution and maintain high removal efficiency for continuous long-term use is to operate the bioreactor in a directionally switching (DS) mode. In DS operation, the contaminant inlet is periodically switched between the top and bottom of the reactor column. It was hypothesized that DS operation could improve the distribution and activity of the biomass in a biofilter and extend stable operation. To test this hypothesis, a detailed study of the effect of directionally switching operation on bioreactor performance was conducted in conjunction with an EPA-funded study. Toluene was used as the model VOC throughout this study and the bioreactor was packed with inert silicate pellets. The effect of DS operation on biomass accumulation and activity was determined in this study as a function of key DS operating parameters: (1) directionally switching vs. unidirectional operation, (2) directional-switching frequency, (3) contaminant loading rate, and (4) gas-phase residence time. The results of this work are summarized below.

4.1.1 Methods

The experimental bioreactor consisted of a stainless steel column (16.2 cm I.D.) packed with porous silicate pellets (R-635, Celite, Calif.) as illustrated in Figure 4-1. This basic bioreactor configuration was used in this study phase as well as in subsequent study phases (3, 7 and 8) after slight modifications. The total height of the packing was 100 cm, which was divided equally into four sections. Filtered compressed air was split into two streams. Pure toluene was injected into one air stream using a syringe pump (Model 200, KD Scientific, Mass.) and the other stream was saturated with a nutrient-laden aerosol generated by a nebulizer (Heart™, VORTRAN Medical Technology Inc., Ariz.). The two air streams were combined and supplied

to the top or bottom of the bioreactor column depending on the feed direction. In unidirectional (UD) operation, the combined stream was fed to the bottom of the reactor. In directionally switching (DS) operation, the gas flow direction through the bioreactor was switched by reversing the inlet and outlet valves every switching frequency cycle. The inlet toluene concentration was maintained at 200 ppm_v (0.76 g/m³), which yielded a constant loading rate of 45.8 g-toluene/m³-h at an empty-bed contact time of 1 minute.

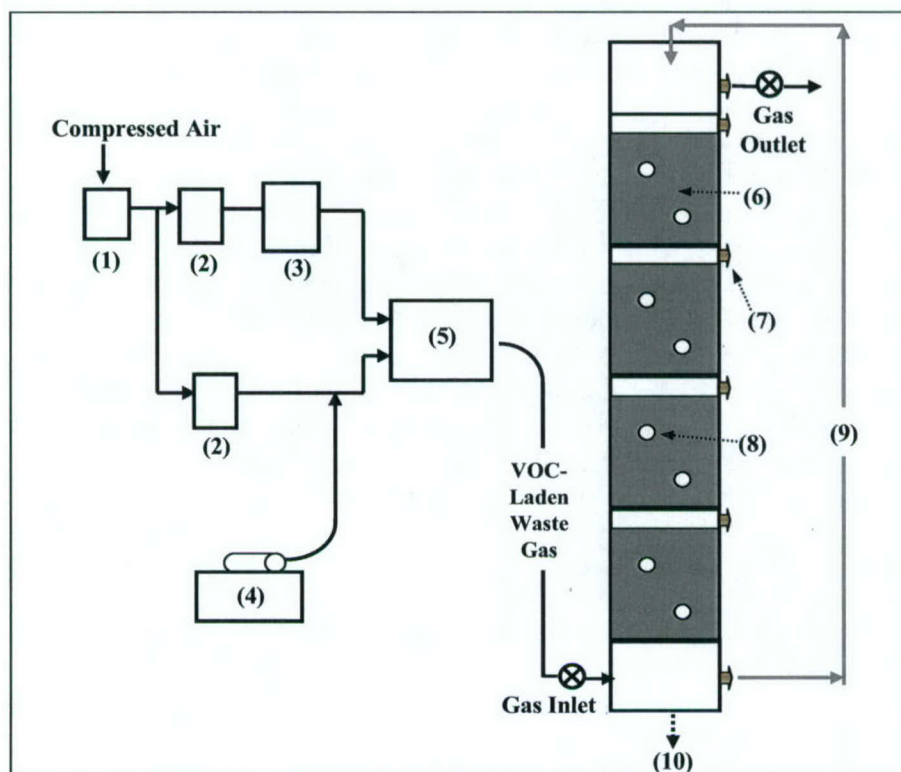

Figure 4-1. Schematic Diagram of Biofiltration Apparatus Used in Study Phases 2, 3, 7 and 8. (1) oil Filter, (2) Pressure Regulator, (3) Nebulizer for Study Phase 2; Humidifier for Phases 3, 7, and 8, (4) VOC Syringe Pump, (5) Mixing Chamber, (6) Packing Media, (7) Gas Sampling Port, (8) Packing Media Sampling Port, (9) Nutrient Solution Recirculation System (Used During Study Phases 3, 7 and 8 Only), (10) Drain.

The aerosol system supplied approximately 400 mL/day of a hydrocarbon minimal medium (HCMM) to the bioreactor. The HCMM consisted of 2.72 g/L KH₂PO₄, 1.42 g/L Na₂HPO₄, 1.32 g/L (NH₄)₂HPO₄, 10.1 g/L KNO₃ and trace metals used by Ridgway *et al.* (1990). To enhance biofilm formation during the initial start-up phase of each SF experiment, an additional 2.64 g/L of (NH₄)₂SO₄ was added to the HCMM for 6 days. After 6 days at the elevated ammonium dose, the original HCMM was used for the remainder of each experiment.

The initial consortium of toluene-degrading microorganisms that was used to inoculate the bioreactor was obtained from a mixed culture grown in another toluene-degrading bioreactor in our laboratory. Three bacterial species, *Rhodococcus rhodochrous*, *Rhodococcus erythropolis*,

and *Alcaligenes xylosoxydans*, were identified using the BIOLOG™ system (performed by Microbe Inotech Laboratories, Inc., St. Louis, Missouri). One unidentified strain was also found to be present.

Details of the analytical methods utilized in this study phase are described in the publications resulting from this work (Song and Kinney, 2000, 2001). To summarize, toluene analyses were performed with a gas chromatograph (Series 6890, Hewlett–Packard, Calif.) equipped with a flame ionization detector (Hewlett–Packard, Calif.). Toluene concentration profiles along the bioreactor column and overall removal efficiencies were determined on a daily basis. At the end of each SF experiment, bioreactor elimination capacities (*ECs*) were determined by increasing the inlet concentration stepwise at 2-hour increments (Deshusses and Johnson 2000). Five or six different loadings were applied, and *ECs* were calculated using the overall toluene removal efficiency observed at each loading.

Packing medium samples were periodically collected and analyzed for chemical oxygen demand (COD), dehydrogenase activity, and bacterial enumeration. The appropriate amount of homogenized sample was added to a COD vial (Hach, Loveland, Colo.), and the COD was measured according to the closed reflux, colorimetric method (APHA et al., 1992). The INT (2-[4-iodophenyl]-3-[4-nitrophenyl]-5-phenyltetrazolium chloride) assay procedure used to measure dehydrogenase activity was a modification of procedures employed by Anderson *et al.* (1988) and Blenkinsopp and Lock (1990). The details of this method have been described elsewhere (Song and Kinney, 1999). Bacterial populations were enumerated by the spread plate method. R2A media (Difco, Detroit, Mich.) was used to count total heterotrophic bacteria expressed as colony-forming units (CFUs), and HCMM agar was used for the enumeration of toluene-degrading bacteria. The R2A plates were incubated without toluene at room temperature, and the HCMM plates were maintained in a sealed container in which toluene vapor was supplied by an open beaker.

4.1.2 Results

Directionally switching operation promoted a more uniform distribution of active biomass along the column and yielded stabler performance than did unidirectional operation (see Song and Kinney, 2000). As shown in Figure 4-2, the biofilter that was operated in a unidirectional fashion eventually clogged near the inlet, causing a rapid rise in pressure drop and a subsequent drop in pollutant removal efficiency. Directionally switching operation, on the other hand, greatly extended bioreactor operation (see Figure 4-2), but biomass slowly continued to accumulate within the bioreactor even at the 3-day switching frequency. Directionally switching operation offered no significant advantage with respect to overall biomass accumulation; rather, it promoted a more uniform distribution of biomass along the DS bioreactor, which yielded stabler performance.

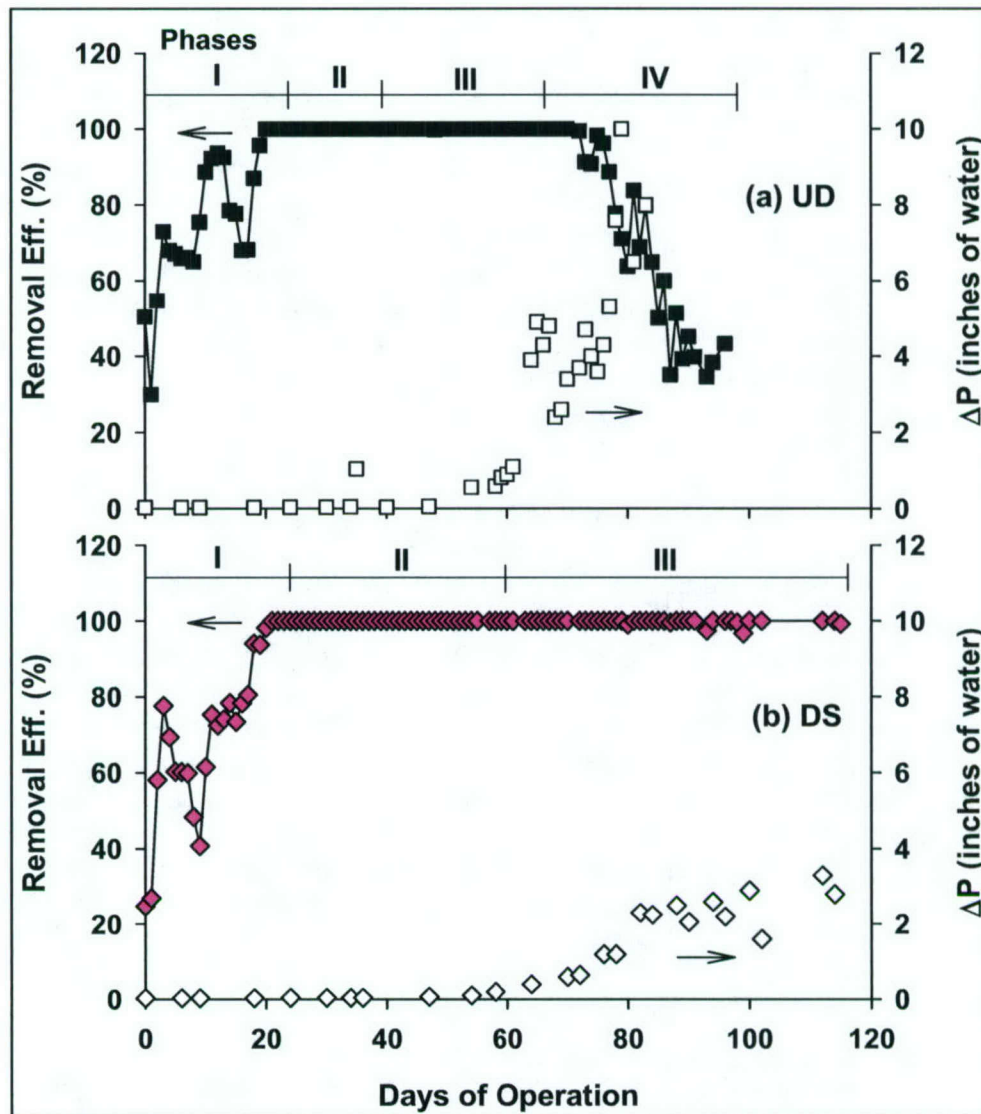

Figure 4-2. Overall Toluene Removal Efficiencies (Filled) and Pressure Drop (Empty) As a Function of Time for (a) the UD and (b) the 3-Day DS Biofilter. During Phase I of Operation, Both Biofilters Were Nitrogen Limited. Following Nitrogen Addition, Biofilter Performance Stabilized in Both Systems.

Biofilm analyses conducted throughout the study indicated that the DS bioreactor also supported a higher population of toluene-degrading microorganisms than did the UD bioreactor, and the dehydrogenase activity assay results indicate that the total microbial population was more active in the DS bioreactor (Song and Kinney, 2000). Nevertheless, a supplemental biomass-removal mechanism such as backwashing would be required to operate a bioreactor packed with silicate pellets for extended periods. These results suggest that a more open packing material should be used to enable easier biomass removal. Also, the additional complexity associated with DS operation will have to be considered when determining whether or not to operate a bioreactor in DS mode.

Since the first set of experiments that indicated that DS operation can improve the stability of bioreactors, a second series of experiments was conducted to determine the optimum switching frequency. Three switching frequencies were investigated: a 1-day, a 3-day and a 7-day switching frequency. The switching frequency experiments revealed that the 3-day switching frequency yielded the stablest bioreactor performance by distributing active biomass more evenly along the column and minimizing the decrease in pollutant-degrading activity with increasing operation time (Figure 4-3). The 1-day frequency yielded unstable operation and the 7-day switching frequency yielded only moderate stability (Song and Kinney, 2001).

A series of experiments was also conducted to determine the effects of contaminant loading rate on bioreactor performance and stability. Three loading rates were examined ranging from 45 g/m³/hr (the maximum loading rate typically seen in field applications) to 136 g/m³/hr (the loading rate corresponding to the maximum contaminant elimination capacity determined for this system). Results indicate that increasing the loading rate caused a faster decline in pollutant removal efficiency. Also, the effect of contaminant loading rate on performance was strongly influenced by the nitrogen supply to the system. In systems that are operated under nitrogen-limited conditions to prevent excess biomass accumulation, relatively small increases in pollutant loading can have a dramatic effect on pollutant removal efficiency if the nitrogen supply to the biofilm is not increased proportionally. The ratio of supplied contaminant carbon to nitrogen was found to be a key parameter that must be monitored to maintain bioreactor performance (Song, 2001, 2002)

Another series of experiments were conducted to determine the effect of varying gas-phase residence time on bioreactor performance (while holding the contaminant loading rate constant). Results indicate that, at a moderate contaminant loading rate of 45 g/m³/hr, residence times of 1 minute and 1.5 minute had very little effect on pollutant removal but reducing the residence time to 0.5 minute resulted in a linear toluene removal profile across the bed and the entire bed depth was required to achieve pollutant removal. These results suggest that lowering the residence time will more evenly distribute contaminant degradation and biomass accumulation) along the column. However, if the bioreactor were subjected to a spike in inlet concentration, breakthrough would likely occur in a system that is operated such that the entire bed depth is required for contaminant removal (Song, 2001).

All of the results described above have been documented in detail in a dissertation entitled, "Control and Characterization of Biomass Activity and Distribution in Vapor Phase Bioreactors for VOC removal"(Song, 2001) and have been published in the papers noted below. The overall research conclusions that are of most importance to the SERDP project are as follows:

- Changes in biofilm characteristics with respect to biomass distribution, activity, and composition change with operating time and strongly affect overall bioreactor performance. As a result, it is suggested that biomass parameters be monitored throughout bioreactor operation to predict if and when bioreactor failure may occur;
- Directionally switching operation improves bioreactor performance but biomass accumulation still occurs slowly in a system that is continuously supplied a VOC waste gas feed. Thus, a supplemental biomass removal mechanism should be applied periodically to the bioreactor to ensure stable long-term performance.

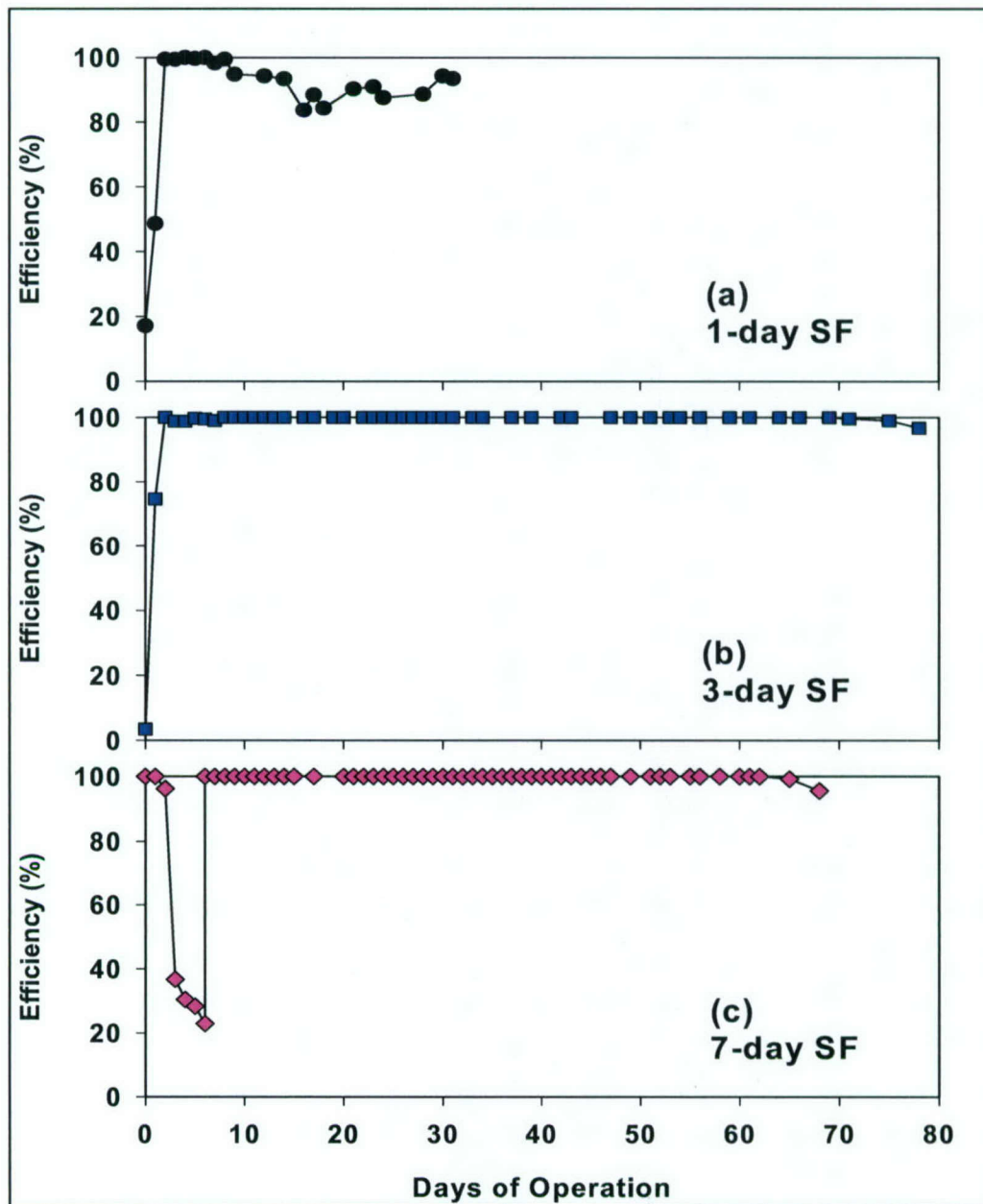

Figure 4-3. Overall Toluene Removal Efficiencies at (a) 1-Day, (b) 3-Day, and (c) 7-Day Switching Frequencies (SFs).

Active Biomass Modeling. Although not explicitly listed as a milestone in this project, it was requested that we develop a biofilter model that considers the effect of biomass accumulation and biomass activity on bioreactor operation. With additional support from an EPA-funded project, we have developed a model that can be used to simulate bioreactor performance over extended periods of operation. This model incorporates two unique features to simulate changes in pollutant removal efficiency and biomass accumulation: (1) total biomass is divided into two microbial components, active and inactive biomass, and (2) biomass growth and biofilm

thickness changes are simulated by means of a cellular automaton (CA) approach. The CA approach, a differential discrete algorithm, numerically allows the excess quantity of biomass in each numerical element to move toward the biofilm surface as biomass accumulates. This model is unique in that it has been used to successfully simulate over 90 days of biofilter operation whereas most biofilter models developed to date can predict only short-term operation (*i.e.*, not more than a few days). The model can handle both unidirectional and directionally switching operation and, once calibrated, simulate the biomass accumulation and decline in biodegradation activity that occur with increasing operating time. The model has been developed and calibrated for a directionally switching bioreactor treating toluene, and the results of this study have been published in *Environmental Science & Technology* (Song and Kinney, 2002). Model predictions imply that the decline in bioreactor performance observed over extended continuous operation at high VOC loading rates was caused by a decline in the active biomass fraction and a decrease in the biofilm specific surface area. This CA model provides insight into biomass accumulation during complex bioreactor operation and improves our capability to predict long-term VPB performance. However, to simulate long periods of operation, the CA model becomes relatively complex and, as a result, it has been developed for single-substrate conditions only. As such, it was not possible to include VOC mixtures in the model simulations and maintain the numerical stability of the model.

Resulting Publications

- Song, J. and Kinney, K.A. (2000) Effect of Vapor-Phase Bioreactor Operation on Biomass Accumulation, Distribution, and Activity, *Biotechnology and Bioengineering*, 68(5), 508–516.
- Song, J. and Kinney, K. A. (2001) Effect of Directional Switching Frequency on Toluene Degradation in a Vapor-Phase Bioreactor, *Applied Microbiology and Biotechnology*, 56, 108–113.
- Song, J. and Kinney, K.A. 2002. “A Model to Predict Long-Term Performance of Vapor-Phase Bioreactors: A Cellular Automaton Approach,” *Environmental Science & Technology*, 36 (11): 2498–2507.

4.2 Evaluation of a Slip-feed System

Under steady feed conditions, vapor-phase bioreactors have proven to be an effective technology for removing odors and volatile organic compounds from waste gas streams (van Groenestijn and Hesselink 1994; Wani *et al.*, 1997). However, when these systems are subjected to dynamic feed conditions or shutdown-and-restart situations, reliable long-term performance can be difficult to maintain. Loss of biomass activity during shutdown periods and the development of inactive zones within the bioreactor during continuous operation are two common reasons for poor bioreactor performance. Several studies have demonstrated that a substantial reduction in the pollutant-degrading capacity of the biomass can occur under carbon-deprived conditions (Martin and Loehr 1996; Wani *et al.*, 1998; Wright *et al.*, 1998; Jenkins and Heald 1996; Choi *et al.*, 1998). One potential method to maintain biomass activity throughout the bioreactor is to use

a slip-feed system in which a small fraction of the inlet feed is redirected to carbon-deprived bioreactor zones during continuous operation (Kinney *et al.*, 1999). It is hypothesized that a low-flow surrogate gas slip stream may also be used to maintain biomass activity during bioreactor shutdown periods. This study was initiated in conjunction with the EPA-funded study to evaluate the ability of a slip-feed system to maintain biodegradation capacities in vapor-phase bioreactors during periods of little or no contaminant feed.

4.2.1 Methods

The study was divided into two experimental phases. The Phase I experiments were conducted to find the optimal slip-feed fraction to maintain high biomass activity in the outlet, carbon-deprived zones of a bioreactor. The Phase II experiments were conducted to determine if a slip-feed system could maintain biomass activity while the main feed system to the bioreactor was shut down. The experimental bioreactor system utilized in this study was identical to the one depicted in Figure 4-1 except that it was modified as necessary to provide a slip feed either to the outlet biofilter section or to the entire biofilter as needed (Figure 4-4).

4.2.2 Results

During the Phase I bioreactor experiments, three different slip-loading rates were examined to find the optimal slip-loading rate needed to maintain biomass activity in the starving bioreactor section. When a slip-feed system was installed to supply either a 1, 5, or 9% (by mass) slip feed to the starving bioreactor section (Figure 4-4b), the initial activity ratio data (a measure of the initial pollutant degrading capabilities of the microbial biofilm) indicate that the biomass had approximately 30% greater activity after 3 days than did the system without the slip feed. Interestingly, the same improvement in biomass activity was observed for all three slip-feed fractions. These results suggest that as long as the biomass in the starving section receives at least some traces of the pollutant, enzyme production for pollutant degradation is not completely inactivated and more rapid recovery in pollutant degradation can occur. This has important implications for maintaining biomass activity during shutdown periods (see discussion below).

Additional studies were conducted to determine whether installation of a slip feed to the outlet bioreactor section improves the overall degradation capacity of the system when it is subjected to a spike load. Results indicate that the benefit of the slip feed for this application is rather slight in a directionally switching bioreactor since the outlet bioreactor section never endures carbon-deprivation conditions for long. However, the benefit of the slip-feed system may be greater for bioreactors operated in a unidirectional mode in which the biofilm near the outlet of the bioreactor receives no VOC loading.

To examine the feasibility of using a slip-feed system during bioreactor shutdown periods, both short-term (2.8 days) and longer-term (7 days) shutdown experiments were conducted during the Phase II experiments. During the shutdown period, the main feed to the bioreactor was disconnected and only a small slip feed was supplied to each section (Fig. 4-4c). In addition, no nutrients were supplied to the bioreactor during the shutdown tests. After the shutdown period, normal contaminant loading started again and the contaminant removal efficiency was monitored until 95% removal of the contaminant was achieved. To provide a basis for comparison, a shutdown experiment was also performed without the slip-feed system to determine how the bioreactor's recovery compared to that of a bioreactor equipped with the slip-feed system.

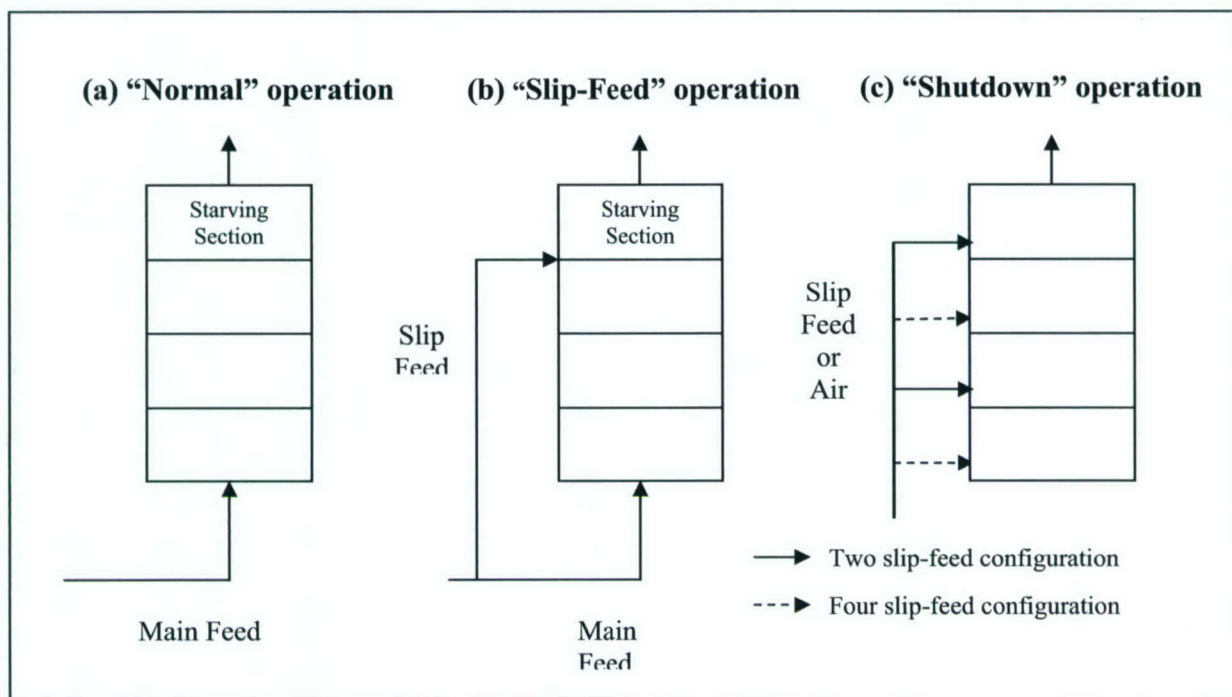

Figure 4-4. Schematic of the Experimental Bioreactor System in Each Operational Mode.

Figures 4-5(a) and 4-5(b) show the toluene removal efficiencies as a function of time after bioreactor restart following a weekend and week-long shutdown period, respectively. When only humidified air was supplied to the bioreactor column during the weekend shutdown period, the toluene removal efficiency was only 24% one hour after the bioreactor restarted, and the bioreactor required over 13 hrs to reach a removal efficiency of 90%. Comparatively, the bioreactor supplied with four slip-feed streams during the weekend shutdown period had a toluene removal efficiency of 64.8% within one hour and achieved 90% removal after 4 hrs of operation. Similarly, during the weeklong shutdown experiments, re-acclimation time to reach 90% toluene removal in the bioreactor supplied with four slip feeds was 12.5 hrs but almost 36 hrs in the system without the slip-feed system. The recovery pattern was similar in all the shutdown/restart experiments except that the bioreactors with the slip-feed system recovered much faster. As a result, the mass of pollutant that was released during the reacclimation period was much lower when the bioreactor was provided with a slip feed suggesting that the slip-feed system is an effective method to maintain pollutant-degrading activity during the shutdown periods typically encountered in paint booth operation. Additional slip-feed experiments were conducted during the pilot-scale evaluation of the biofiltration technology as described in Chapter 10.

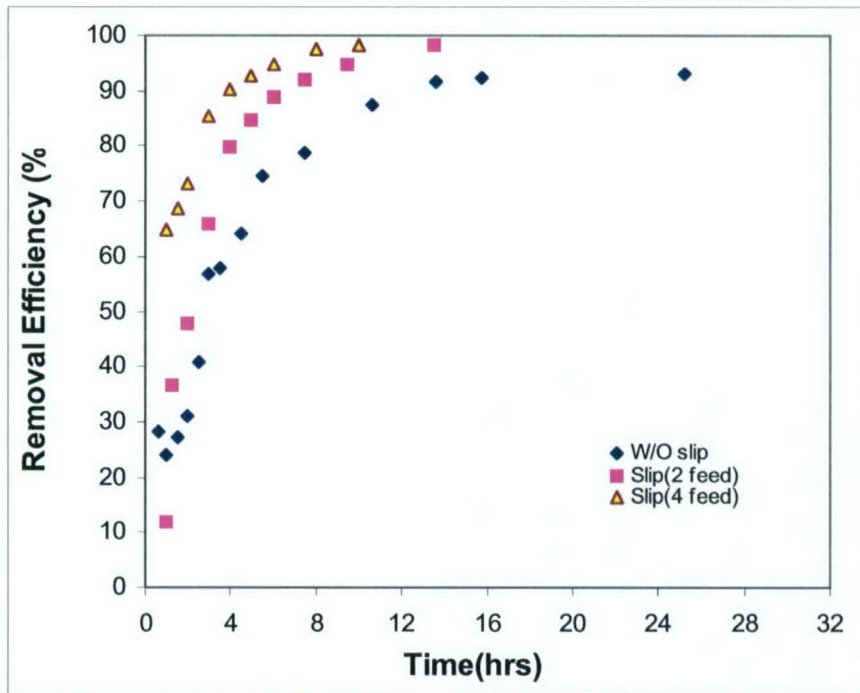

Figure 4-5a. Bioreactor Re-acclimation after a Weekend Shutdown Period

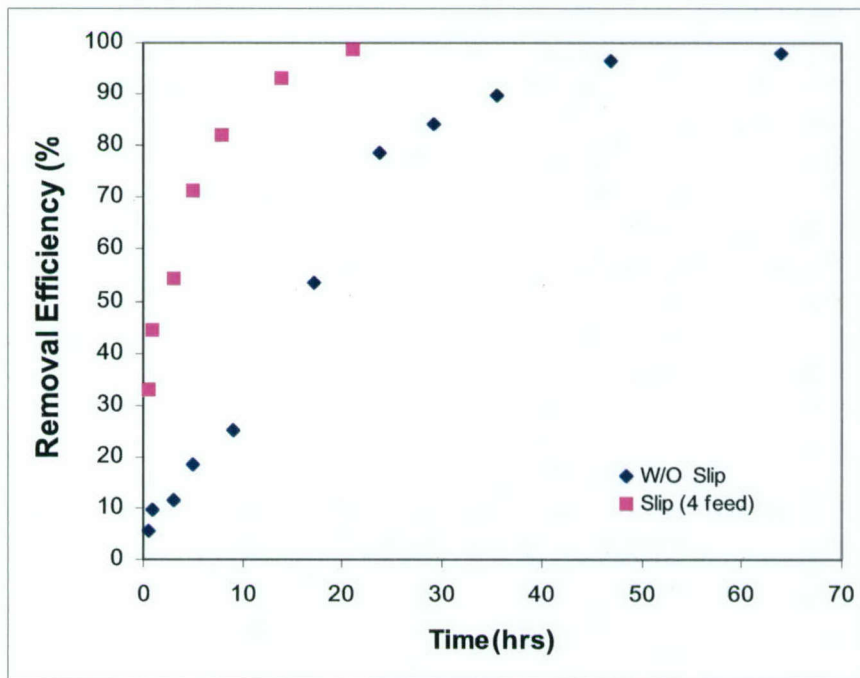

Figure 4-5b. Bioreactor Re-acclimation after a Week Shutdown Period

Resulting Publications

- Park, J. and Kinney, K.A. (2001). "Evaluation of a Slip Feed System for Vapor-Phase Bioreactors," *Journal of Environmental Engineering*, **127** (11), pp. 979–985.

4.3 Nitrogen Requirements and Recycling Estimates

In bioreactors containing synthetic packing media, external nitrogen must be added to maintain effective VOC removals (Devinny *et al.*, 1999; Moe and Irvine, 2001). In such systems, an excess quantity of inorganic nitrogen is commonly supplied to achieve high contaminant elimination capacities. While greater nitrogen levels can enhance VOC removal efficiencies, they add to the cost of biofilter operation, and excess nitrogen availability can lead to biofilter clogging at high VOC-loading rates. Consequently, an estimate of the minimum quantity of nitrogen that must be added to achieve effective VOC removals would be useful to optimize biofilter operation. To determine how much nitrogen must be added to a biofilter, one must first estimate how much of the nitrogen in the biofilm is recycled for use by the microorganisms and how much is lost due to other mechanisms. Based on carbon and nitrogen balances, the external nitrogen supply needed to meet the nitrogen demand of the biofilm can then be estimated. In this study conducted in conjunction with an EPA-funded effort, a series of experiments and mass balance analyses were performed to determine the effect of nitrogen supply on biofilter performance and to estimate nitrogen utilization rates in a lab-scale biofilter treating toluene and *p*-xylene. The results of this work have been published in *Water Research* (Song, *et al.*, 2003).

4.3.1 Methods

Experiments were conducted using the same lab-scale biofilter described earlier in Section 4.1.1. However, the biofilters were operated in a unidirectional fashion such that the gas stream was supplied to the top of the biofilter for an empty-bed residence time of 1 minute. The packing media was then inoculated with microorganisms capable of degrading toluene, *p*-xylene, and methyl *tert*-butyl ether (MTBE) prior to startup of the biofilter column. The MTBE degraders were obtained from an MTBE-treating biofilter at the University of California at Davis (Hanson, 1999), and the toluene and *p*-xylene degraders were obtained from activated sludge collected from the South Austin Wastewater Treatment Plant. The inocula were mixed together and then recirculated through the packed bed for 6 hours.

Following inoculation, the biofilter was operated for a 76-day period using the aerosol system to adjust media nitrogen levels. The operational period was divided into three phases based on VOC and nutrient loading conditions as indicated in Table 4-1. During Phase I (days 0–25), a mixture of three VOCs (toluene, *p*-xylene and MTBE) and various nutrient solutions were supplied to the biofilter. From days 26 to 49 (Phase II), only toluene and one nutrient solution were supplied to the biofilter. The loading rate of toluene was increased to 47.3 g/m³/hr and the loading of *p*-xylene and MTBE were discontinued during Phase II. From days 50 to 76 (Phase III), nitrogen addition via the aerosol system was discontinued, while the loading rate of toluene was held constant. For the Phase III experiments, the aerosol system was replaced with a bubble humidification system consisting of a 2-L heated flask filled with deionized water.

The form of nitrogen supplied to a biofilter can affect performance with ammonia usually resulting in greater biomass yields. While increased biomass yields are desirable in many biological treatment systems, in a packed-bed system such as a biofilter, excess biomass can lead to rapid clogging and system failure. For this reason, most (83% to 100%, by mass) of the nitrogen supplied to the biofilter during the Phase I and Phase II experiments was in the form of nitrate to reduce biomass yields and prevent clogging. However, increased levels of ammonium were supplied during the initial start up of the biofilter (days 0–9), when enhanced biomass yields were desirable to aid in the establishment of the biofilm in the bioreactor (see Table 4-1).

TABLE 4-1. BIOFILTER OPERATING CONDITIONS AND NITROGEN SUPPLY.

		Aerosol Capture Experiment	Biofilter Experiment				
			Phase I			Phase II	Phase III
			Days 0–9	Days 10–13	Days 14–25	Days 26–49	Days 50–76
Aerosol Delivery System		On	On	On	On	On	Off ¹⁾
VOCs		None	Toluene (20.3 g/m ³ /hr) <i>p</i> -Xylene (21.0 g/m ³ /hr) MTBE (5.0 g/m ³ /hr)			Toluene (47.3 g/m ³ /hr)	Toluene (47.3 g/m ³ /hr)
Supplied C/N ratio		n/a	33.8 ²⁾	17.2 ²⁾	13.2 ²⁾	19.8	-
Nutrient Solution (g/L)	KNO ₃	15	0.5	10.1	10.1	10.1	
	NH ₄ Cl	7.5	-	-	-	-	
	(NH ₄) ₂ SO ₄	-	2.38	-	2.38	-	
	Phosphate & Trace metals ³⁾	-	Yes	Yes	Yes	Yes	-

¹⁾ The aerosol system was replaced with a bubble humidification system to maintain the moisture levels in the biofilter.

²⁾ MTBE was excluded from this ratio because it was not degraded in the biofilter and was treated as a tracer component of the waste gas stream.

³⁾ The phosphate buffer contained 2.74 g/L KH₂PO₄, 1.32 g/L (NH₄)₂HPO₄, and 1.42 g/L Na₂HPO₄; the chemical composition of the trace metal solution has been reported previously [2].

4.3.2 Results

After an initial adjustment period (Phase I), toluene alone was fed to the biofilter at a constant loading rate of 47.3 g/m³/hr, and nitrogen addition via the aerosol system was reduced slightly to 1.05 g-N/day (a supplied C/N ratio of 19.8) to stabilize biofilter operation and achieve pseudo-steady-state conditions during Phase II. Toluene removal efficiencies of greater than 99% were achieved throughout Phase II, while the normalized media nitrogen level decreased from 0.07 to 0.03 mg-N/mg-COD by day 49 even though nitrogen was supplied at a constant rate (see Figure 4-6(b)). This decline was due to the nitrogen demand of new biomass which was continuously

accumulating in the biofilter at a near-constant rate of approximately 710 mg-COD/kg/day throughout this period. These results imply that high VOC removal efficiencies can be achieved

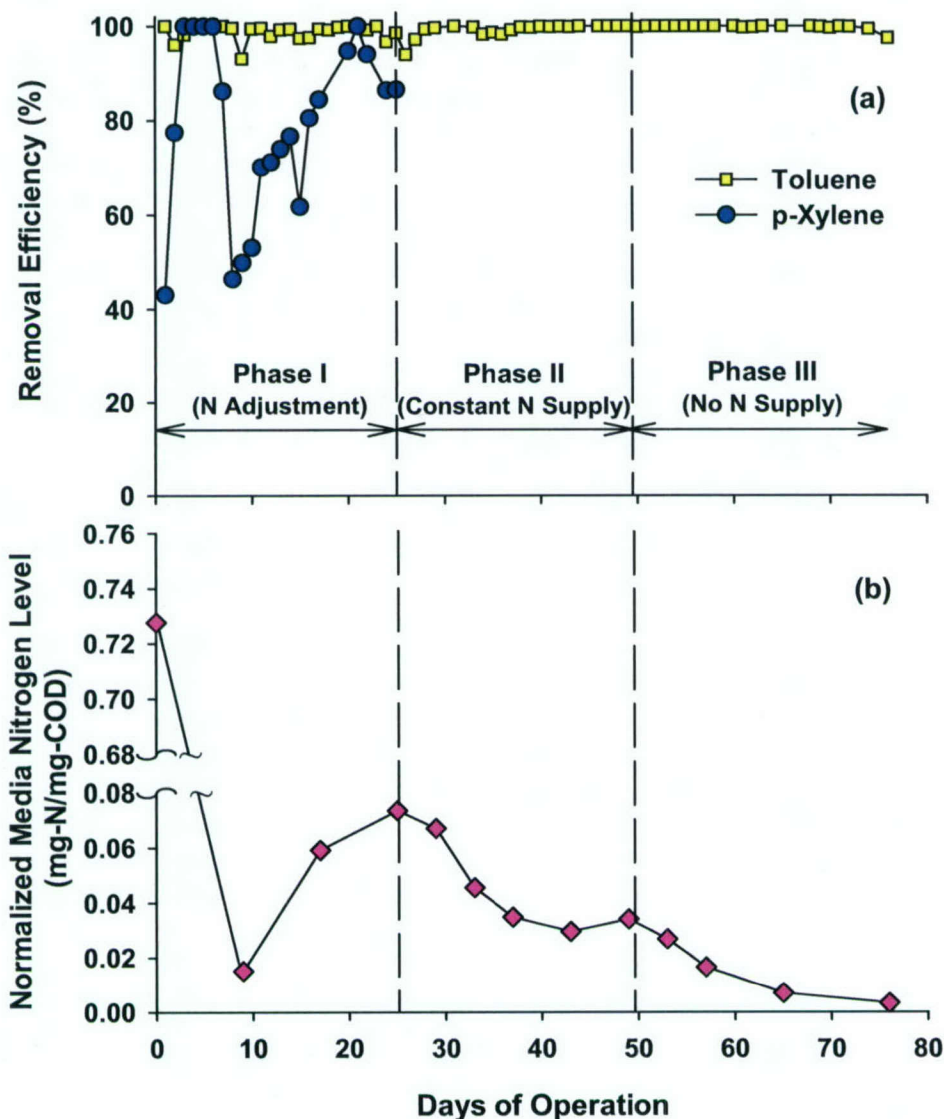

Figure 4-6. (a) Toluene and *p*-Xylene Removal Efficiencies across the Biofilter Column, and (b) Average Media Nitrogen Levels ($\text{NH}_4^+ + \text{NO}_3^-$) Normalized by COD Content in the Biofilter Media. Although MTBE Was Supplied to the Biofilter during Phase I, no MTBE Degradation Was Observed.

at this loading rate when the normalized media nitrogen level is maintained above 0.03 mg-N/mg-COD. However, these high removal efficiencies would not be sustainable at this carbon/nitrogen-loading condition, since the normalized media nitrogen levels were continuously declining. This decline in available nitrogen occurred even though the supplied C/N ratio was

held constant indicating that the normalized media nitrogen levels is a more sensitive measure of the quantity of nitrogen actually available for use by microorganisms in the biofilm.

During Phase III, external nitrogen addition was discontinued and the effect of nitrogen depletion on biofilter performance was determined as the normalized media nitrogen level decreased from an average value of 0.03 to 0.01 mg-N/mg-COD (Figure 4-6(b)). The most significant reductions in media nitrogen level occurred in the front half of the column, where most of the toluene degradation initially took place. As nitrogen was depleted, less toluene degradation occurred in the front half of the column and the removal shifted from an exponential curve to a linear degradation profile (Figure 4-7). The decline in normalized media nitrogen levels was consistent with the gradual decline in overall biofilter performance throughout Phase III. These results suggest that the normalized media nitrogen level is a useful parameter to determine whether VPBs are operating under nitrogen-limited conditions.

Nitrogen Balance. Using experimental data collected during Phase III, an attempt was made to quantify the amount of nitrogen recycled in the biofilm. In a biofilter packed with synthetic media that contain no organic nitrogen source, nitrogen recycling occurs in the biofilm surrounding the packing media. To determine the amount of nitrogen recycled, a mass balance was performed on the free inorganic nitrogen in the biofilm. The mass balance approach used in this study is similar to the one utilized by Gribbins and Loehr (1998) for natural compost media and is described in detail in Song *et al.* (2003).

Table 4-2 summaries results of nitrogen mass balances over three sequential periods of Phase III: days 50–57, days 58–65, and days 66–76. The results suggest that the amount of nitrogen recycled in the biofilm to meet microbial nitrogen demands (N_{recycled}) can be significant. Between days 50 and 57, for instance, calculations indicate that nitrogen recycling may have supplied up to 56% of the total microbial nitrogen demand (*i.e.*, $N_{\text{recycled}}/N_{\text{uptake}} \approx 56\%$). The nitrogen balance indicates that the quantity of N_{recycled} and its relative fraction of the total demand increased as the media nitrogen levels decreased in the biofilm, implying that organic nitrogen recycled may be an important nitrogen source under nitrogen-limited conditions.

TABLE 4-2. NITROGEN MASS BALANCE DURING PHASE III (DAYS 50–76).

Parameters	Days 50–57	Days 58–65	Days 66–76
$\Delta N_{\text{media}}^1$ (mg-N/day)	-729	-475	-160
N_{uptake}^2 (mg-N/day)	1371	1311	1378
N_{leachate}^1 (mg-N/day)	131	96	45
N_{recycled}^3 (mg-N/day)	774	933	1264

1) Measured.

2) Calculated using a biomass yield coefficient of 0.3 mg- C_{biomass} /mg- C_{toluene} determined from a carbon mass balance and assuming a biomass formula for bacterial cells of $C_5H_7O_2N$.

The nitrogen mass balance utilized above provides a quantitative estimate of the nitrogen demand and recycling rates in a biofilter, which is an important step toward optimization of biofilter operation. However, definitive quantification of the nitrogen balance will require further study to verify the assumptions used for a given biofilter operation. Despite its limitations, the mass balance approach employed in these experiments provides a first estimate of the relative quantities of nitrogen utilized and recycled in a VPB. Since recycling of the nitrogen provides less than 100% of the nitrogen demand, nitrogen addition to the packing media is necessary to achieve effective long-term biofilter operation. Both the normalized media nitrogen level and the amount of nitrogen potentially recyclable within the biofilm should be considered when determining the minimum amount of nitrogen that must be added to a biofilter

Specific conclusions that are important for the development of biofiltration for paint booth operations include the following:

- Overall biofilter performance is a strong function of available media nitrogen levels normalized by total biomass in a VPB packed with the synthetic media. For the range of operating conditions investigated in this study, normalized media nitrogen levels of greater than 0.03 mg-N/mg-COD were required in the biofilm to avoid severe nitrogen-limited conditions and a decline in biofilter performance.
- Nitrogen availability can have a substantial effect on VOC substrate interactions under nitrogen-limited conditions. This will be important to consider when treating paint VOC mixtures.
- Nitrogen recycling supports growth of new microbial components in the biofilm phase as readily available nitrogen is released when the cells die and lyse. Carbon and nitrogen balances indicate that the fraction of microbial demand met by recycled nitrogen can be substantial. However, at high VOC loading rates, the nitrogen recycled in the biofilm is finite, and readily available nitrogen must be added to the packing media to ensure effective long-term biofilter operation.

Resulting Publications

- Song, J., Ramirez, J. and Kinney, K.A. 2003. "Nitrogen Utilization in a Vapor Phase Biofilter," *Water Research*, **37**(18): 4497–4505.

CHAPTER 5: BIOTRICKLING FILTER EVALUATION

A series of experiments were conducted in this phase of the research project to assess the feasibility of using biotrickling filters to treat paint spray booth off-gas streams. Because an aqueous nutrient solution is continuously recirculated, biotrickling filters are well suited for treating soluble VOCs that are readily transferred into the aqueous phase. Pollutant biodegradation occurs in the biofilm phase attached to the synthetic packing material as well as in the aqueous phase that recirculates through the bioreactor. Many of the components found in paint spray booth emission are relatively soluble and biodegradable and thus biotrickling filters have the potential to be effective for this application. To assess this potential, a series of experiments were conducted using a laboratory-scale biotrickling filter to treat a five-component paint mixture. Specific objectives of the experiments included the following:

- Defining the operating range of a biotrickling filter treating surrogate paint emissions;
- Investigating the effect of multiple paint VOCs on pollutant degradation; and
- Evaluating directionally switching operation in a biotrickling filter containing a polypropylene pall ring packing material.

To meet these objectives, a series of bioreactor column experiments and batch studies were conducted. The surrogate paint VOC mixture used in the study was based on information found in the literature (Webster *et al.*, 1998a; Webster *et al.*, 1998b) and emissions data from an actual paint spray booth (Wander, 1999). After achieving a total VOC removal efficiency of 95% in a biotrickling filter packed with polypropylene pall rings, the effect of residence time, liquid recirculation, and multiple VOCs on bioreactor performance was investigated. Directionally switching operation was assessed for its ability to aid in the even distribution of biomass within a biotrickling filter, and a biomass removal experiment was conducted. Finally, batch-fed serum-bottle experiments were conducted to further study the effects of inhibition by determining the degradation rate of each contaminant individually and as part of the paint VOC mixture.

The following sections summarize the key results of these experiments and more details can be found in the master's thesis entitled, "Biofiltration for Paint Spray Booth Applications" (Kazenski, 2000).

5.1 Methods

As noted above, the primary objectives of these experiments were to assess the feasibility of using a biotrickling filter to treat waste gas streams from paint spray booths and to define the operating regime for such systems. To accomplish these objectives, the study investigated performance of a biotrickling filter packed with polypropylene pall rings. Additionally, a series of serum-bottle studies were conducted to corroborate and further investigate results obtained during the bioreactor column experiments.

Several parameters were monitored throughout the study to assess performance of the bioreactor system. VOC gas concentrations were measured along the length of the reactor to evaluate the degradation capability of the reactor and biomass concentrations were measured to assess biofilm

establishment and biomass accumulation in the reactor. Daily operating parameters such as air flowrate and pH of the recirculating liquid medium were also monitored to maintain consistent operation.

A description of the experimental bioreactor system and how it was operated is presented below. The laboratory experiments performed throughout this phase of the study as well as the procedures used to measure VOC concentrations and other operating parameters are also described.

5.1.1 Experimental Biotrickling Filter

The experimental system used in this phase of the project was identical to the biofilter apparatus shown in Figure 4-1 except that the reactor was operated as a biotrickling filter with a continuously recirculating liquid medium. The middle four sections of the bioreactor were packed with 1.6-cm (5/8-inch) diameter polypropylene pall rings (Koch-Glitsch, Inc.) to a height of 25 cm per section. Each packed section was separated by an 8-cm gas sampling plenum. Pall rings (approx. surface area/volume = $340 \text{ m}^2/\text{m}^3$) were selected for evaluation because they have a more open structure that may enable longer operation before biomass accumulation causes clogging.

A system of Tygon™ tubing was installed to supply the liquid medium to the top of the column and to direct the liquid draining from the column back into the reservoir. A peristaltic pump (Cole-Parmer, Models #7553-70 and #7529-00, Vernon Hills, Ill.) was used to force the liquid to the top of the column. The recirculating nutrient solution consisted of 1g/L KH_2PO_4 , 1 g/L K_2HPO_4 , 0.5 g/L $(\text{NH}_4)_2\text{HPO}_4$, 1 g/L KNO_3 , 1 g/L NaCl , 0.0294 g/L $\text{CaCl}_2 \cdot \text{H}_2\text{O}$, 0.40 g/L $\text{MgSO}_4 \cdot \text{H}_2\text{O}$ and 1ml/L of a trace metal solution used by Ridgway *et al.* (1990).

5.1.2 Synthetic Waste Gas

Paint spray booth emissions contain a wide variety of VOCs. Five chemicals comprising high contaminant fractions in an operating automotive paint spray booth were chosen as a representative paint VOC mixture (Wander, 1999). Properties of the paint VOCs evaluated in this study are provided in Table 5-1.

A compressed air stream was split into two streams to supply a synthetic waste gas stream to the experimental bioreactor. Pure chemicals were injected into one air stream using a syringe pump (Cole-Parmer, 74900 Series). A second air stream was passed through a humidifier and then mixed with the chemical-laden air stream in a polyvinyl chloride (PVC) mixing chamber (see Figure 4-1). The mixed air stream with a total VOC concentration of approximately 200 ppm_v was then supplied to the bioreactor (see Table 5-2). To evaluate the ability to evenly distribute biomass growth along the entire length of the column, the bioreactor was operated in a direction-switching mode. In this mode of operation, the direction of the contaminated air feed through the bioreactor was reversed every three days.

TABLE 5-1. PROPERTIES OF VOCs PRESENT IN THE SURROGATE PAINT MIXTURE ⁽¹⁾.

VOC	Formula	Molecular Weight (g/mol)	Density (g/mL)	Henry's Constant (atm/mol · m ³)	Solubility (g/100mL)
methyl <i>n</i> -propyl ketone	C ₅ H ₁₀ O	86.13	0.8095	7.2927 x 10 ⁻⁵	4.3
<i>n</i> -butyl acetate	C ₆ H ₁₂ O ₂	116.16	0.8820	2.5732 x 10 ⁻⁴	0.68
ethyl 3-ethoxypropionate	C ₇ H ₁₄ O ₃	146.19	0.9500	6.4991 x 10 ⁻⁴	2.9
toluene	C ₇ H ₈	92.15	0.8996	6.3522 x 10 ⁻³	0.0526
<i>p</i> -xylene	C ₈ H ₁₀	106.17	0.8660	6.1547 x 10 ⁻³	0.0175

⁽¹⁾ Chemfinder; Yaws, 1999

TABLE 5-2. INLET VOC CONCENTRATIONS IN THE SURROGATE PAINT MIXTURE.

VOC	Percent of Total Inlet Conc. (% by volume)	Inlet Conc. (ppm _v)
methyl <i>n</i> -propyl ketone	54	110
<i>n</i> -butyl acetate	10	20
ethyl 3-ethoxypropionate	16	32
toluene	10	20
<i>p</i> -xylene	10	18
Total	100	200

5.1.3 Bioreactor Startup and Operating Conditions

The experimental conditions for the biotrickling filter study are summarized in Table 5-3. The bioreactor inoculation cultures were grown at 23 °C in 250-mL glass Boston round bottles containing 100 mL of nutrient medium. The bottle was sealed with a Teflon-lined septum and screw cap, and a total concentration of 100 mg VOC-carbon per liter was added to the bottles as a neat liquid. Each VOC in the chemical mixture was provided in the same mass ratio as would be present in the gas phase during bioreactor operation (see Table 5-2).

After the culture was able to fully degrade the supplied chemical mixture, it was transferred to a large batch carboy system containing the nutrient medium described in Section 5.1.1 above. When the culture had again established a turbid biomass solution and was able to degrade repeated VOC injections, the culture was recirculated through the bioreactor column using the nutrient recirculation system described above. After inoculation, the bioreactor was supplied a waste gas stream contaminated with a total of 200 ppm_v VOCs for the remainder of the experiment. The gas-phase empty-bed residence time (EBRT) in the bioreactor was initially set at 1.5 minutes in an effort to aid in biofilm development. After an effective biofilm developed, the EBRT was decreased to 1 minute and then 30 seconds.

TABLE 5-3. BIOTRICKLING FILTER OPERATING CONDITIONS.

Parameter	Experimental Conditions
Contaminants (inlet conc.)	methyl <i>n</i> -propyl ketone (110 ppm _v), ethyl 3-ethoxypropionate (32 ppm _v), <i>n</i> -butyl acetate (20 ppm _v), toluene (20 ppm _v), <i>p</i> -xylene (18 ppm _v)
Total inlet VOC concentration (ppm _v)	200
Inlet loading (g C/m ³ -hr)	21 g C/m ³ -hr at 3.2 L/min gas flow, 31 g C/m ³ -hr at 19.8 L/min gas flow 46 g C/m ³ -hr at 29.7 L/min gas flow
Liquid medium recirculation rate	2.7 L/min
Nutrient delivery method	Recirculating liquid medium
Air flowrate (L/min)	13.2, 19.8, and 29.7
Empty-bed contact time (min)	1.5, 1, and 0.5
Directionally switching operation	Switching Frequency = 3 days
Inoculation source	Activated sludge from S. Austin Wastewater Treatment Plant
Days of operation	53

5.1.4 Elimination Capacity Tests

To define the operating envelope for a biotrickling filter treating a paint VOC mixture, a series of elimination capacity tests were performed at three different reactor residence times; 1.5 minutes, 1 minute, and 30 seconds. At each residence time, the inlet concentration was varied both above and below the 200 ppm_v total inlet VOC baseline concentration. The contaminant ratio was maintained at each adjusted concentration. At each contaminant concentration tested, the bioreactor was given 2 hours to acclimate to the adjusted concentration before a concentration profile along the column was measured. Between each change in concentration, the inlet VOC concentration was returned to 200 ppm_v for a 4-hour period and a concentration profile along the column was measured to ensure that degradation patterns had returned to normal. All elimination capacity tests were performed with the inlet air stream entering at the top of the column. The elimination capacity of the biotrickling filter at each pollutant loading was calculated using Equation 2-2 by determining the mass of pollutant removed per unit volume of reactor per unit time.

5.1.5 VOC Interactions in the Column

A series of tests were performed in the column to investigate the possible inhibitory effects of the paint VOC mixture on biodegradation rates. During these tests, the inlet chemical mixture was varied by removing one or more of the constituents or by varying the concentration ratio of the constituents. The effect of each change in inlet gas stream composition was determined by measuring the concentration profiles along the length of the bioreactor column. Prior to measuring the VOC concentration profile, the column was given 4 to 5 hours to acclimate to the

altered mixture. All column VOC interaction tests were performed at a residence time of 1 minute and with the nutrient recirculation system in operation.

5.1.6 Serum Bottle Studies

A series of bottle studies were conducted to verify observed favored degradation patterns in the biotrickling filter and to investigate possible inhibitory effects of the paint VOCs in the mixture. All studies were conducted using the same ratio of VOC concentrations as supplied to the bioreactor (see Table 5-2).

Bottle preparation. Bottle studies were conducted in 250-mL Boston round bottles (Fisher Scientific) containing 100 mL of the nutrient medium described in Section 5.1.1. All bottles were cleaned by washing with soap and then with acid prior to use. Bottles containing the nutrient medium were autoclaved at 121°C and 15 psi for 20 minutes. The bottles were sealed with Teflon®-lined septa and a screw cap. Each bottle study was conducted in triplicate with both a killed control and an uninoculated sterile control bottle to measure VOC losses due non-biological causes.

Inoculation. Samples from the inoculum solution for the biotrickling filter were used to grow organisms for the various bottles studies. Organisms were initially grown in a 4-L Nalgene™ carboy containing 2 L of the nutrient medium described earlier. The carboy was sealed and a total concentration of 100 mg VOC-carbon per liter was added to the carboy as a neat liquid. The chemicals were injected in the same proportions as would be seen during bioreactor operation (Table 5-2). After the organisms had degraded two successive feedings of 100 mg VOC-carbon per liter, the inoculum solution was prepared as described below and transferred to the bottles. Degradation was assumed to be complete when no VOCs were detected in gas samples taken from the headspace and analyzed in the GC/FID as described below.

To remove any potential degradation by-products from the cells prior to transfer into the bottle for study, cells were washed using a buffered saline solution. The inoculum suspension from the carboy was transferred to 50-mL vials and centrifuged (Fisher Scientific Centrifric™ Centrifuge) for 5 minutes. After centrifuging, the liquid was decanted and the cell pellet was resuspended in 50 mL of saline solution (4.3 g/L K₂HPO₄, 3.5 g/L KH₂PO₄, and 8.5 g/L NaCl). This process was repeated twice before transferring the cells into a blender (Waring), where they were resuspended in the nutrient medium. The cells and nutrient medium were then blended for 30 seconds to break flocs and ensure an even distribution of cells.

To ensure each bottle was inoculated with the same concentration of cells, the blended inoculum was transferred to 12.5-mL vials and the absorbance was measured using a spectrophotometer (Turner Model 690) at 690 nm. The inoculum concentration was adjusted until the absorbance of all vials was approximately 0.56. The inoculum contained in the vials was then transferred to the prepared Boston round bottles.

5.1.7 Analytical Methods

Gas-Phase Sampling and Analysis. To determine overall removal efficiencies and removal profiles along the biotrickling filter column, gas samples were periodically collected from each gas sampling port using 0.5-mL gas-tight syringes fitted with Mininert™ valves and side-bore

needles (Hamilton 1700 series). The gas samples were immediately analyzed using a gas chromatograph (Hewlett-Packard 6890) equipped with a flame ionization detector (GC/FID) and a 30-m HP-5 capillary column. The GC was calibrated using five gas standards with known concentrations for each chemical to be analyzed. A 0.5-mL sample of each standard was injected onto the GC, and a five-point calibration curve was produced. Calibration curves were determined for each of the five chemicals in the inlet gas stream.

Chemical Oxygen Demand. Chemical Oxygen Demand (COD) was used as a measure of biomass accumulation and biofilm establishment in the bioreactors. Two pall rings were collected from each of the four packed-column sections and placed in 50-mL vials. The vials were filled with ultrahigh-purity (UHP) water and were sonicated (FS6 Fisher Scientific Sonicator) for 3 minutes and shaken vigorously to remove the biomass from the packing media. Two mL of the biomass solution was injected into Hach digestion vials for the 0–1500 mg/L range (Hach vials #21259-15). For COD concentrations exceeding 1500 mg/L, samples were diluted by adding 1 mL of sample and 1 mL of UHP water to each vial. COD analysis was conducted according to Hach Method 8000 for COD determination through colorimetric measurement (Hach Company, 1997). Absorbance was measured at 690 nm using a spectrophotometer (Turner Model 690). A seven-point COD standard curve was developed using a potassium hydrogen phthalate solution prepared according to standard methods (APHA *et al.*, 1992).

Volatile Solids Analysis. Volatile solids concentration in the bottles before the start of the bottle experiments and after degradation of each test chemical(s) was determined following the Hach Method for volatile solids analysis (Hach Company, 1997). An additional bottle was prepared according to the inoculation method discussed previously to provide a sample for initial volatile solids measurement. Samples were analyzed in triplicate.

5.2 Results

The following sections present and discuss the results of the VOC elimination capacity experiments as well as the VOC removal efficiencies observed during the biotrickling filter experiments.

5.2.1 Elimination Capacity

In the design of a full-scale bioreactor, elimination capacity curves are often used to size the reactor (Devinny *et al.*, 1999). Elimination capacity (*EC*) is defined as the mass of contaminant degraded per unit volume of packing media per unit time. The *EC* value is a function of the mass loading, (the mass of contaminant entering the bioreactor per unit volume of packing media per unit time) and the removal efficiency. Elimination capacity curves can be compiled in two ways: 1) by altering the inlet contaminant concentration; or 2) by altering the residence time. While most researchers look at only one of these methods, it is possible that each method will generate different elimination capacity curves. Considering both changes in concentration and changes in residence time incorporates the effect of increased loading on bioreactor performance as well as assessing mass transfer effects on VOC degradation. Hence, the elimination capacity experiment involved sequentially increasing the concentration at three different residence times and measuring the elimination capacity.

Elimination Capacity for Total VOCs. The total VOC elimination capacity curves for each of the three residence times investigated in this study are presented in Figures 5-1 and 5-2. The straight line represents 100% removal of the inlet contaminants. At all three residence times, the total VOC elimination capacity was linear with respect to total VOC loading up to a loading of approximately $75 \text{ g/m}^3\text{-hr}$. Similar elimination capacity curves were measured at each residence time.

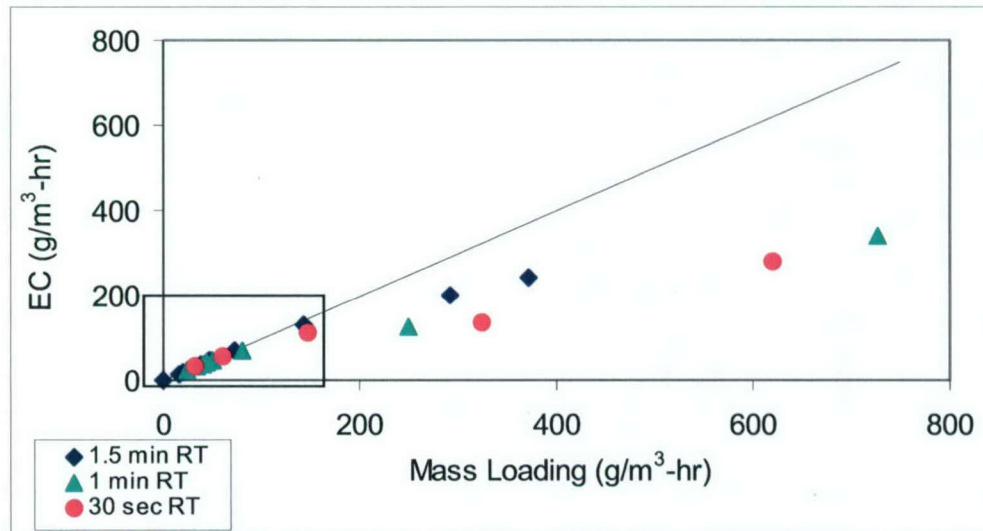

Figure 5-1. Total VOC Elimination Capacities as a Function of VOC Mass Loading Rate and Gas-phase Residence Time in the Biotrickling Filter

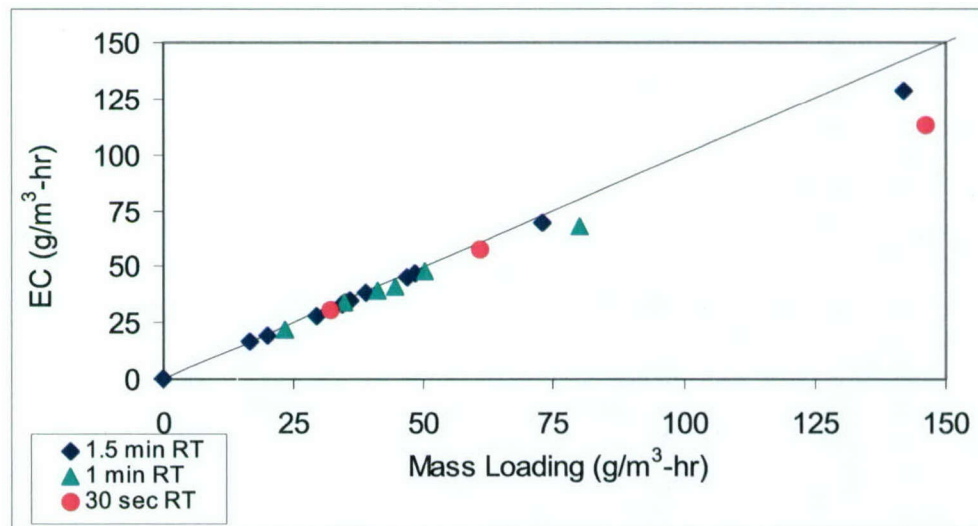

Figure 5-2. Inset from Figure 5-1: Total VOC Elimination Capacities as a Function of VOC Mass Loading Rate and Gas-phase Residence Time in the Biotrickling Filter

During this study, the highest elimination capacities measured ranged from 240 to 340 $\text{g/m}^3\text{-hr}$ for the three residence times. While few elimination capacity studies have been conducted for paint VOC mixtures, the total VOC elimination capacity results from this study compare favorably with elimination capacities reported for BTEX (benzene, toluene, ethylbenzene, and xylene) and other complex mixtures. For example, a perlite-packed biofilter treating a mixture of toluene, ethylbenzene, and *o*-xylene reached an elimination capacity of 70 $\text{g/m}^3\text{-hr}$ at a 57-second residence time (Kennes *et al.*, 1996). A ceramic-packed biofilter treating a complex mixture of petroleum-based VOCs reached maximum elimination capacities of 100 $\text{g/m}^3\text{-hr}$ and 130 $\text{g/m}^3\text{-hr}$ (Klenheinz and Bagley, 1998). It is not surprising that the elimination capacities for the mixture in this study were relatively high given that the main components of the mixture (*i.e.*, methyl *n*-propyl ketone, ethyl 3-ethoxypropionate and *n*-butyl acetate) are readily degraded. Kirchner *et al.* (1987, 1989, 1991) measured elimination capacities up to 500 $\text{g/m}^3\text{-hr}$ for water-soluble VOCs. Lower elimination capacities in the range of 120 to 175 $\text{g/m}^3\text{-hr}$ were measured for aromatics, however (Smith *et al.*, 1998).

Elimination Capacities of Individual Paint Constituents. In addition to generating an elimination capacity curve for the VOC mixture, it is of interest to evaluate the elimination capacity curves for each individual component. This information will assist in determining if a reactor must be designed with removal of a particularly troublesome contaminant in mind. Elimination capacity curves for each of the five paint VOCs in the mixture are presented in Figures 5-3 to 5-7.

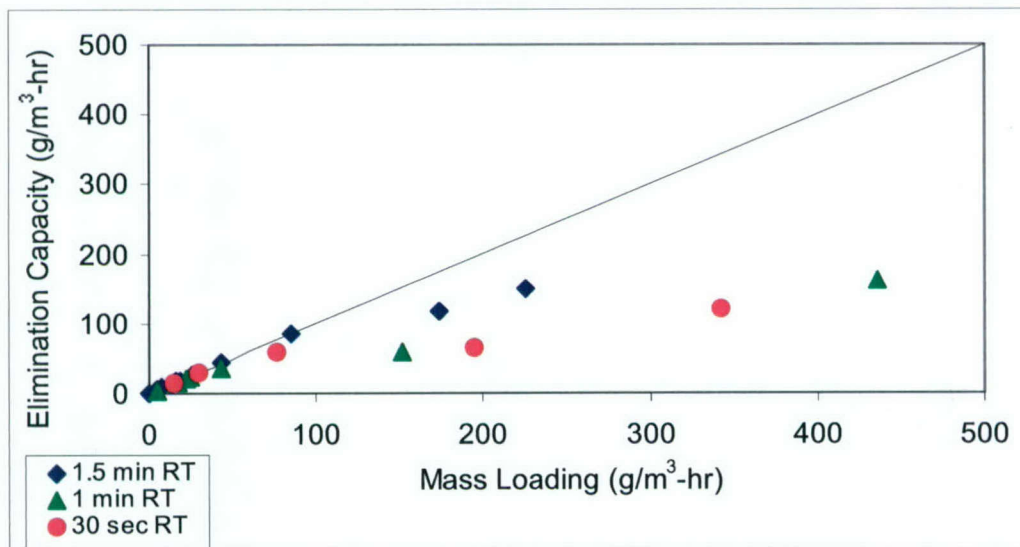

Figure 5-3. Methyl *n*-Propyl Ketone Elimination Capacity at Three Different Residence Times in the Biotrickling Filter

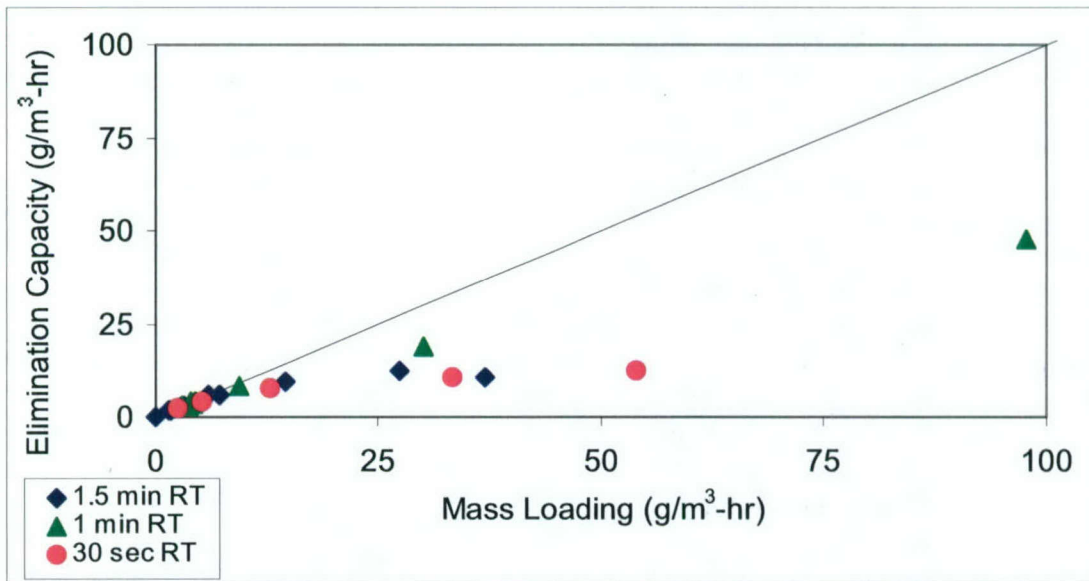

Figure 5-4. Toluene Elimination Capacity at Three Different Residence Times in the Biotrickling Filter.

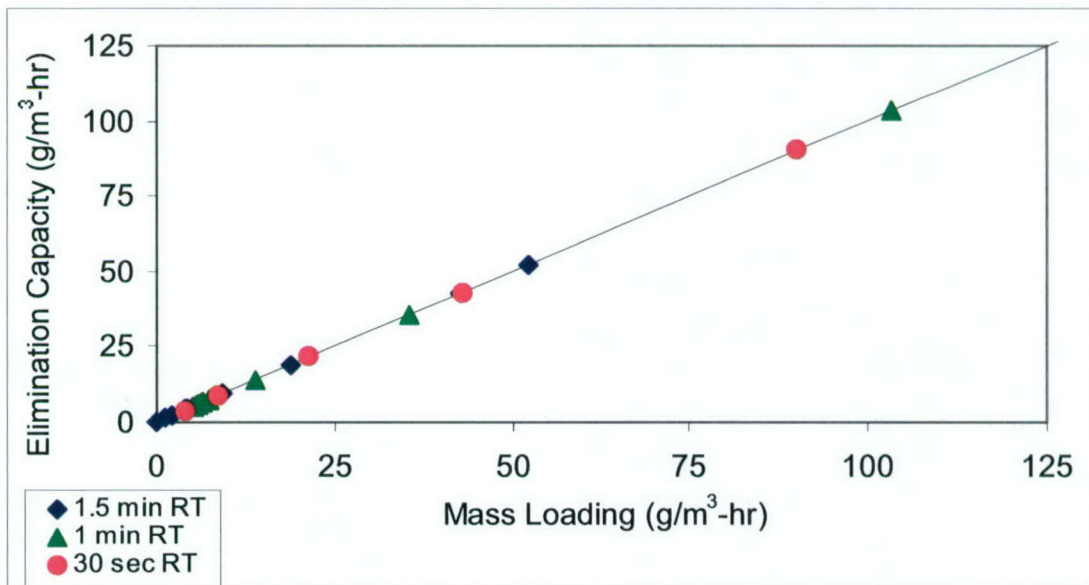

Figure 5-5. n-Butyl Acetate Elimination Capacity at Three Different Residence Times in the Biotrickling Filter.

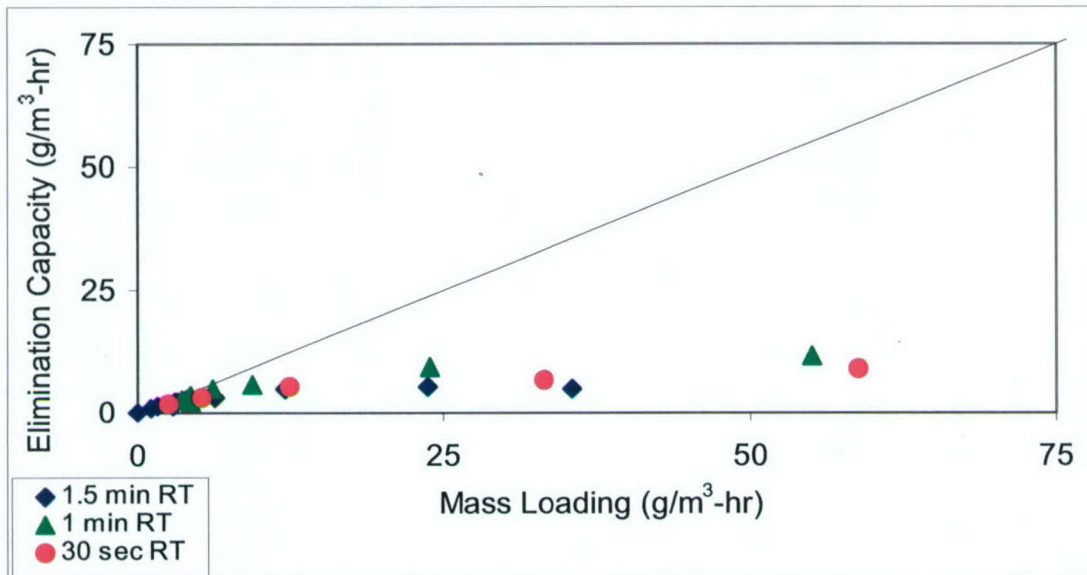

Figure 5-6. Xylene Elimination Capacity at Three Different Residence Times in the Biotrickling Filter.

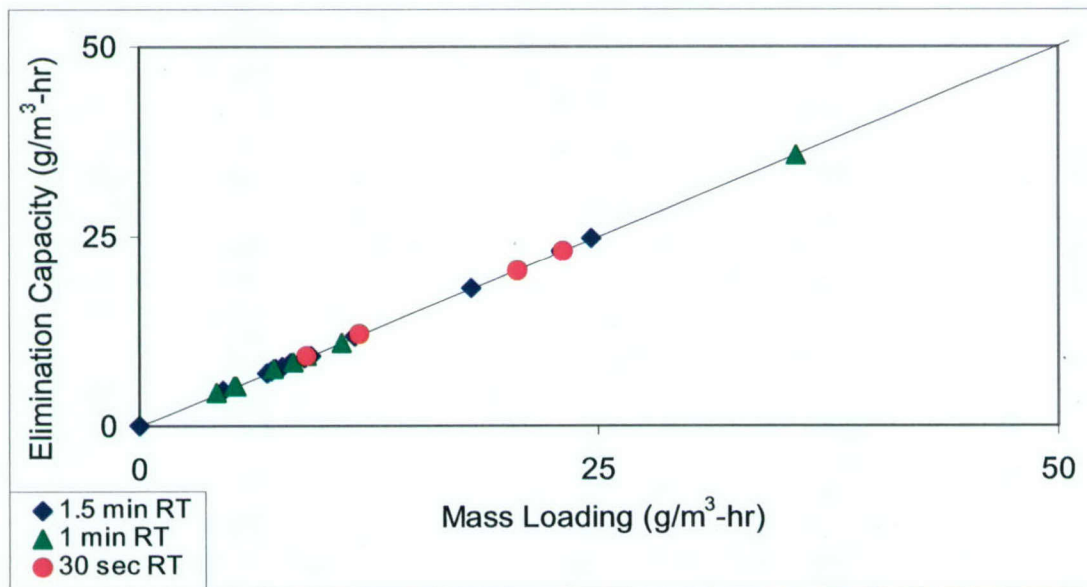

Figure 5-7. Ethyl 3-Ethoxypropionate Elimination Capacity at Three Different Residence Times in the Biotrickling Filter.

The *n*-butyl acetate and ethyl 3-ethoxypropionate elimination capacities were found to be a linear function of mass loading over the range of mass loadings investigated in this study. However, the maximum elimination capacities were not determined for these compounds since 100% removal was observed at all loadings tested. Higher loadings were not tested to minimize chances of having an inhibitory effect on the biofilm. For methyl *n*-propyl ketone, elimination capacities as high as 150 g/m³-hr at a 1.5-minute residence time, 60 g/m³-hr at a 1-minute residence time, and 65 g/m³-hr at a 30-second residence time were observed. The elimination capacity results for the individual components also compare favorably with those reported in the literature. Elimination capacities of 120 g/m³-hr have been reported for methyl ethyl ketone, a compound very similar to one of the main paint constituents in this study—methyl *n*-propyl ketone (Deshusses, 1994). Elimination capacities reported for butyl acetate range from 35 to 40 g/m³-hr (Ottengraf *et al.*, 1983; Johnson and Deshusses, 1997), but elimination capacities as high as 200 g/m³-hr have been reported for ethyl acetate, a compound structurally similar to *n*-butyl acetate (Deshusses and Johnson, 1999).

As can be seen in Figures 5-4 and 5-6, toluene and xylene elimination capacities were much lower than for the other compounds. Xylene reached a maximum elimination capacity of approximately 10 g/m³-hr at all three residence times. Toluene achieved a maximum elimination capacity of approximately 11 g/m³-hr at the 1.5-minute and 30-second residence times. An anomaly was observed at the 1-minute residence time, during which an elimination capacity of 50 g/m³-hr was measured for toluene.

The toluene and xylene elimination capacities reached in this study are generally lower than those reported in the literature. Toluene elimination capacities for compost biofilters have been reported in the range of 15 to 100 g/m³-hr (Don and Feenstra, 1984; Johnson and Deshusses, 1997; Ottengraf and van den Oever, 1983; Seed and Corsi, 1994). Toluene and xylene have also been degraded in a mixture at higher loadings. In a study of toluene and xylene interactions, elimination capacities of 165 g/m³-hr for toluene, 66 g/m³-hr for xylene, and 115 g/m³-hr for both toluene and xylene were reported (Jorio *et al.*, 1998). Cox *et al.* reported elimination capacities of 28 to 47 g/m³-hr for a biotrickling filter treating toluene only (Cox *et al.*, 1997). Therefore, it is known that toluene can be successfully degraded in a biotrickling filter. Hence, there seems to be some operating factor in the biotrickling filter that limited the treatment of toluene and xylene. Whether this limitation was a product of inhibition between the VOCs in the mixture is further discussed in Section 5.2.3.

5.2.2 VOC Removal

The removal efficiencies for the complete VOC mixture as a function of time in the biotrickling filter are presented in Figure 5-8. The start up period for this bioreactor experiment ended on day 17, when 95% total VOC removal was achieved. Following the startup period, the biotrickling filter operated for 54 days and removed 94% to 98% of the 200 ppm_v total VOC inlet concentration. As can be seen in Figure 5-8, overall removal efficiency was not affected by decreasing the EBRT from 1.5 to 1 minute (on Day 30). A slight decrease in total VOC removal efficiency (*i.e.*, from 95%–98% to 92%–94%) was observed when the EBRT was further reduced to 30 seconds (on Day 47). As discussed in detail later in this section, this decline in removal

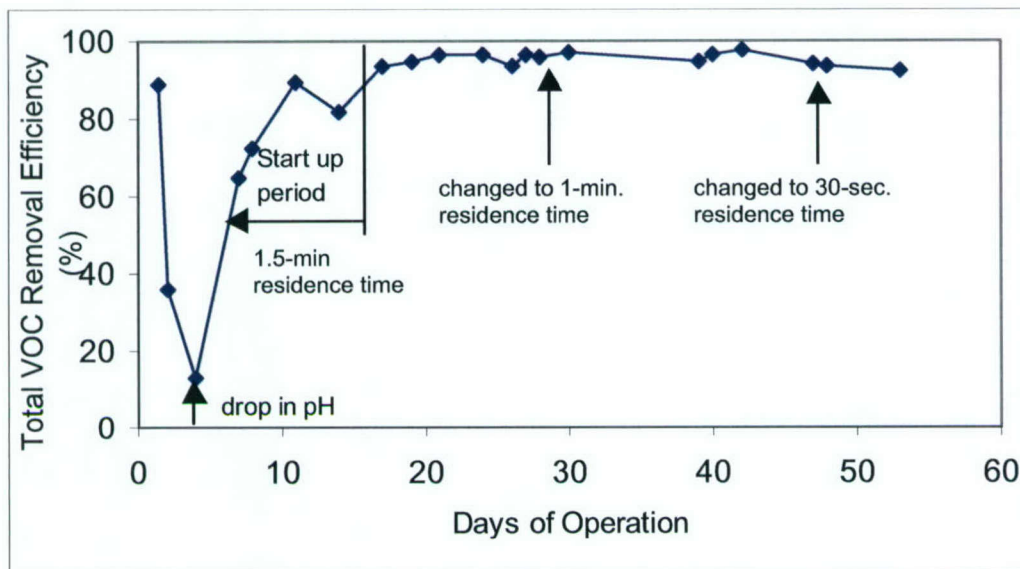

Figure 5-8. Total VOC Removal Efficiencies in the Biotrickling Filter

efficiency was due to a decrease in the toluene and xylene removal efficiencies with decreasing residence time. Toluene removal efficiency dropped from approximately 95% to 75% when the residence time decreased from 1 minute to 30 seconds. Xylene removals fluctuated at both residence times but generally declined from a range of 60% to 80% removal at the one-minute EBRT to 55% to 60% removal at the 30-second EBRT. These results suggest that toluene and xylene are the mixture constituents most sensitive to changes in residence time when the concentration is held constant.

Although the total VOC removal efficiency declined slightly when the EBRT was decreased to 30 seconds, the most significant decline in total VOC removal efficiency was observed on day 4 of operation, when *pH* of the recirculating liquid dropped from 6.4 to 5. The ideal *pH* for most bacteria is between 6 and 8 (Madigan *et al.*, 2000) and low *pH*s can have a negative effect on VOC degradation by bacteria (Webster *et al.*, 1998b). Up to day 4 of operation, the recirculating liquid medium was not replaced or refreshed. To better control *pH* and to reduce the potential for accumulation of degradation by-products, the recirculating liquid medium was replaced with fresh medium every two days for the remainder of the study. In addition, 1.25 mL of NH_4OH was added to each liter of liquid medium for additional buffering capacity. Following these changes, the *pH* of the recirculating liquid medium remained near neutral (approximately 7.6) for the remainder of the study.

A typical total VOC concentration profile along the biotrickling filter on day 17 is presented in Figure 5-9. Although the VOC removal profiles fluctuated during the startup period, they were essentially constant throughout the remainder of the study and reflected the profile shown in Figure 5-9.

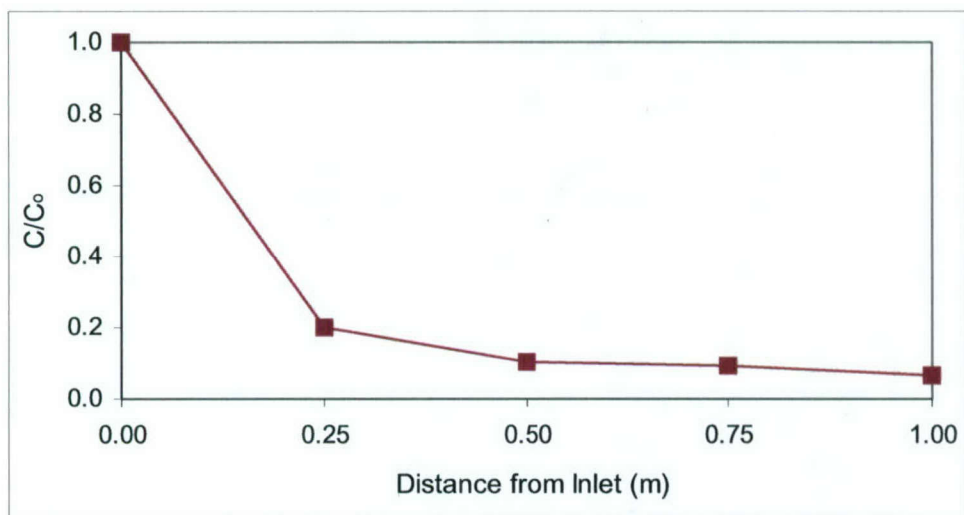

Figure 5-9. Total VOC Concentration Profile in the Biotrickling Filter on Day 17 of Operation. Bioreactor Operating Conditions: Top-feeding, Liquid Recirculation Rate = 2.7 L/min, Gas-phase Residence Time = 1.5 min.

As can be seen in Figure 5-9, the majority of the pollutants were degraded in the first 25 cm of the packed-bed depth and removal rates were lower in the remainder of the packed bed. As discussed in detail below, the steep removal profile in the first 25-cm section results from the nearly complete removal of methyl *n*-propyl ketone, ethyl 3-ethoxypropionate and *n*-butyl acetate in this section. The flat removal profiles from the 25-cm to 100-cm bed depths resulted from the relatively poor removal of toluene and xylene, which required the entire one meter of packed-bed depth to be removed.

Individual Contaminant Degradation Profiles. Typical concentration profiles for each of the five individual paint constituents are presented in Figure 5-10 for day 17 of bioreactor operation. All of the *n*-butyl acetate and ethyl 3-ethoxypropionate were degraded in the first section of the reactor, as well as 97% of the methyl *n*-propyl ketone. Toluene and xylene were not fully degraded and required greater bed depths for removal. Throughout the experiment, toluene and xylene removal efficiencies limited the overall VOC removal efficiency. *n*-Butyl acetate and ethyl 3-ethoxypropionate removal efficiencies reached 100% within 18 hours of operation and were maintained at this level throughout the duration of the experiment. Methyl *n*-propyl ketone removal efficiencies increased to 98% after pH was controlled (starting on day 4) and remained at this level for the remainder of the experiment. Toluene and xylene degradation were much slower to improve with toluene reaching 94% removal efficiencies on day 17 and xylene removal efficiencies reaching 60% on day 17. The low xylene removal observed in this study is consistent with results previously reported in the literature. For example, Corsi and Seed (1995) observed poor xylene degradation in a biofilter treating a mixture of benzene, toluene, and xylene. Kennes *et al.* (1996) found that *o*-xylene was more poorly degraded than other aromatic hydrocarbons. Alvarez and Vogel (1991) also observed that *p*-xylene was degraded most slowly in a mixture containing benzene, toluene and xylene.

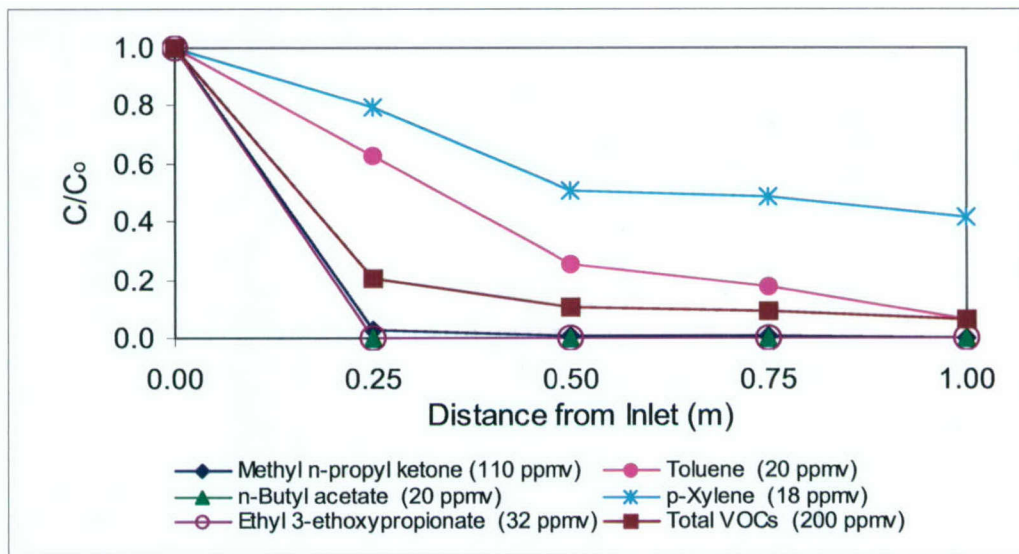

Figure 5-10. Individual VOC Concentration Profiles in the Biotrickling Filter on Day 17 of Operation. The Inlet Concentration for Each Constituent Is Provided in the Legend. Bioreactor Operating Conditions: Top-feeding, Liquid Recirculation Rate = 2.7 L/min, Gas-phase Residence Time = 1.5 min.

Effect of Residence Time on Performance. Contaminant removal profiles at each residence time in the biotrickling filter are presented for each chemical as well as for the total VOC mixture in Figures 5-11 through 5-16. To simplify representation in the graphs, each contaminant removal profile was derived by calculating the average of the normalized concentration values at each point (distance from the inlet) over the duration of steady-state bioreactor operation at each residence time. These average steady-state concentrations do not take into account the concentrations observed during the fluctuating degradation that occurred during the 17-day startup period.

Inspection of Figures 5-11 through 5-16 reveals that the greatest effect of residence time is encountered when changing from the 1-minute residence time to the 30 second residence time. This effect is most pronounced for toluene and xylene, but is also observed in the first 25 cm of packed-bed depth for methyl *n*-propyl ketone. Given that the performance of the bioreactor varied slightly throughout the experiment, it was important to determine whether or not the observed differences in performance were statistically significant. To assess the statistical variation between the three cases, a standard *t*-test was performed (Larson and Marx, 1986, Harnett and Horrell, 1998). A *t*-test for two means was conducted to compare the 1.5-minute residence time and the 1-minute residence time data. Since limited concentration profiles were measured at the 30-second residence time, only one concentration profile under conditions matching those for the other two residence times is available. Hence, a single value *t*-test was performed to assess the statistical difference between bioreactor performance at the 1-minute and 30-second residence times. The *t*-test was conducted with a level of significance of 0.01. The results indicate that decreasing the residence time from 1.5 minutes to 1 minute at a constant

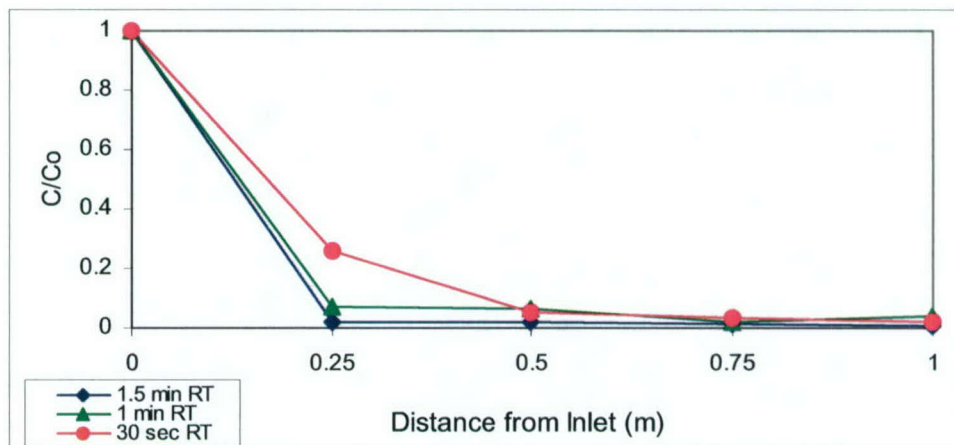

Figure 5-11. Effect of Gas-phase Residence Time on Methyl *n*-Propyl Ketone Degradation. Bioreactor Operating Conditions: Inlet Concentration = 110 ppm_v, Top-feeding, Liquid Recirculation Rate = 2.7 L/min.

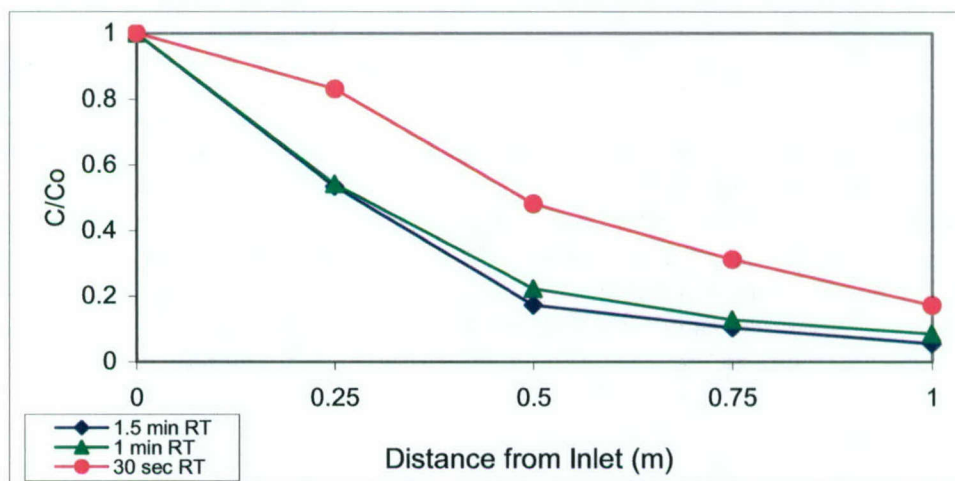

Figure 5-12. Effect of Residence Time on Toluene Degradation. Bioreactor Operating Conditions: Inlet Concentration = 20 ppm_v, Top-feeding, Liquid Recirculation Rate = 2.7 L/min.

inlet VOC concentration of 200 ppm_v did not have a significant effect on the rate of degradation in the bioreactor for any of the chemicals in the paint VOC mixture (Kazenski, 2000). However, there is a statistical difference between the removal profiles at 1 minute and those at 30 seconds. This decrease in residence time increased the bed depth required to degrade the bulk of the chemicals (*i.e.*, 50-cm bed depth for 30-seconds residence time versus a 25-cm depth for the 1-minute residence time), especially for toluene and xylene.

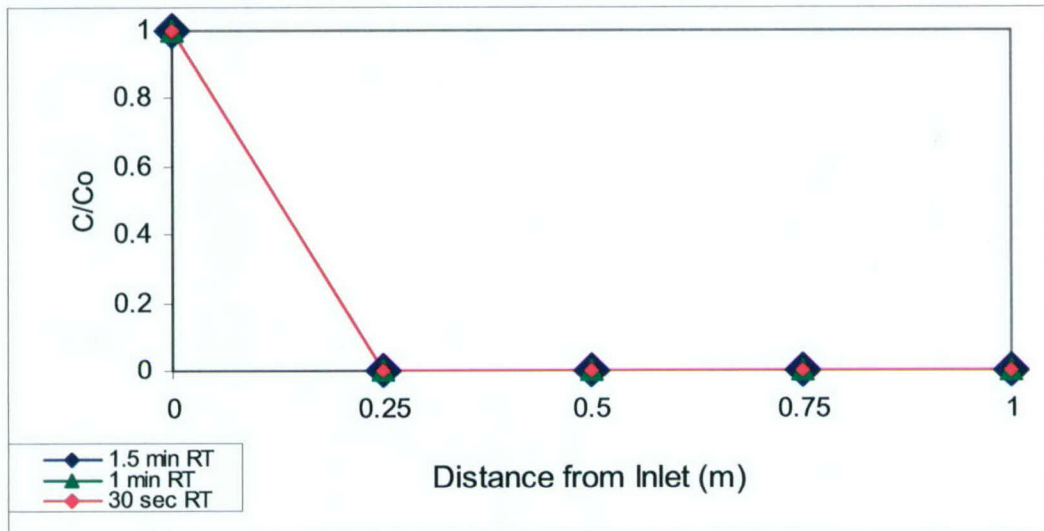

Figure 5-13. Effect of Residence Time on *n*-Butyl Acetate Degradation. Bioreactor Operating Conditions: Inlet Concentration = 20 ppm_v, Top-feeding, Liquid Recirculation Rate = 2.7 L/min.

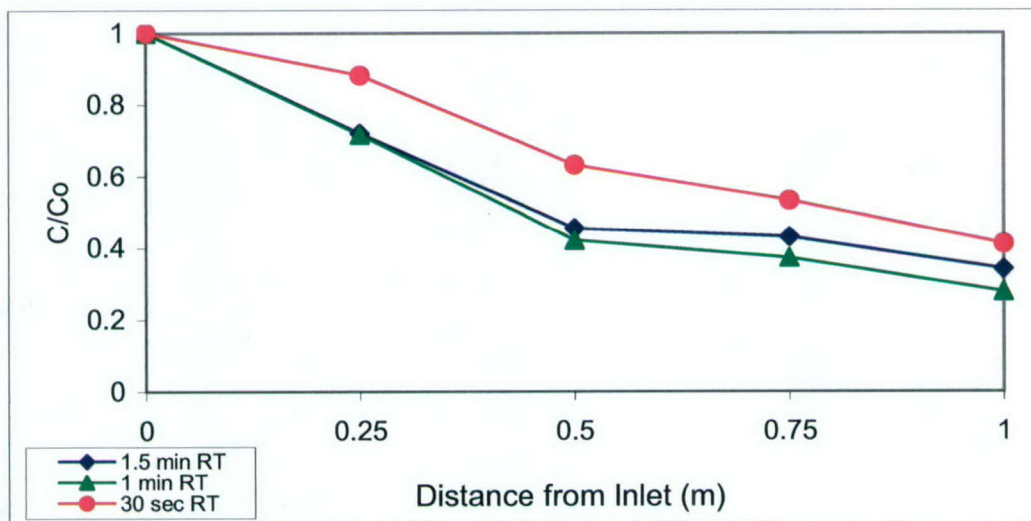

Figure 5-14. Effect of residence Time on Xylene Degradation. Bioreactor Operating Conditions: Inlet Concentration = 18 ppm_v, Top-feeding, liquid Recirculation Rate = 2.7 L/min.

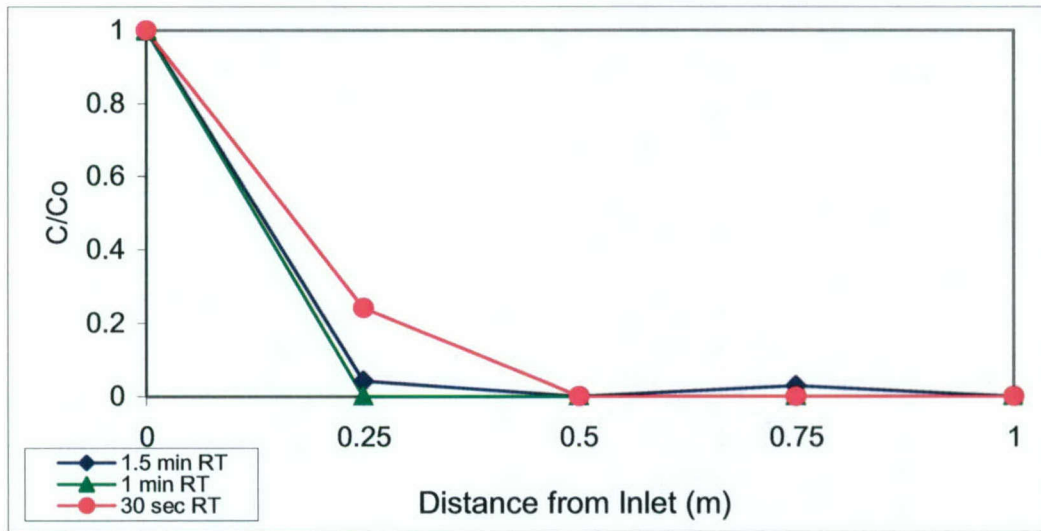

Figure 5-15. Effect of Residence Time on Ethyl 3-Ethoxypropionate Degradation. Bioreactor Operating Conditions: Inlet Concentration = 32 ppm_v, Top-feeding, Liquid Recirculation Rate = 2.7 L/min.

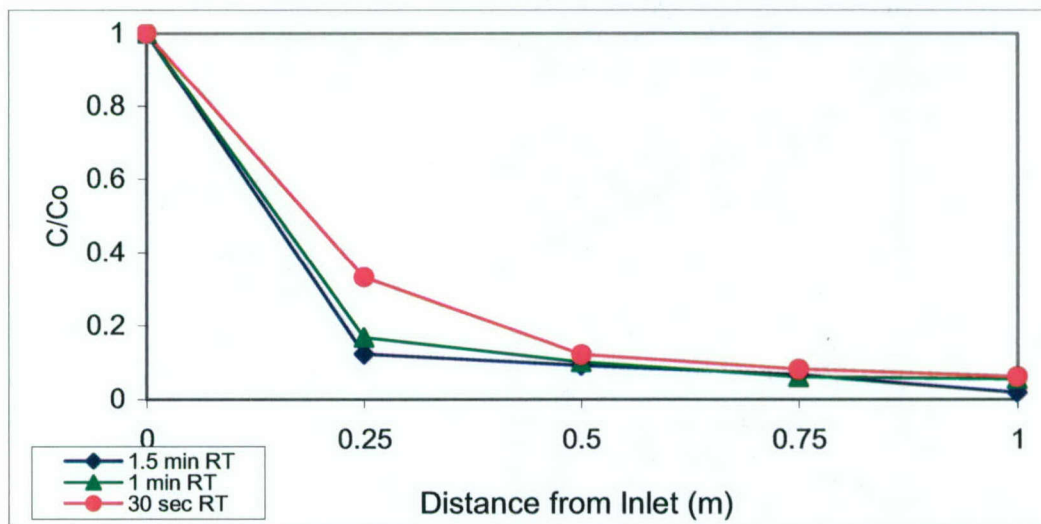

Figure 5-16. Effect of Residence Time on Total VOC Degradation. Bioreactor Operating Conditions: Total Inlet Concentration = 200 ppm_v, Top-feeding, Recirculation Rate = 2.7 L/min.

As noted above, when the EBRT was decreased from 1 minute to 30 seconds, the greatest change in removal profiles was observed for xylene and toluene. The xylene concentrations were much higher at the 25 and 50-cm packed-bed depths for the 30 second residence time. Toluene also required a greater bed depth for degradation at the 30 second residence time with concentrations

after the first 50 cm depth higher at the 30-second residence time than at the 1-minute residence time. For both toluene and xylene, the concentrations after 75-cm and 1-m packed-bed depths are statistically the same at the 30-second residence time as at the 1-minute residence time, despite the seeming increase shown in Figures 5-12 and 5-14. Since the overall VOC removal efficiencies were not significantly affected by the decrease in residence time, additional studies are required to determine the minimum residence time for the reactor.

Biotrickling filters have the disadvantage that the VOCs must be absorbed into the liquid phase, which can become the rate-limiting step for compounds with low water solubility (Severin *et al.*, 1993). At the 1.5-minute residence time, the majority of the contaminants were transferred into the liquid biofilm and biodegraded within the first 25 cm of the packed-bed depth. At lower residence times, contaminants penetrated further into the column. Compounds with low water solubilities (*e.g.*, toluene and xylene) may be more affected by mass transfer limitation in a biotrickling filter than are highly soluble compounds that readily absorb in the liquid. Regardless of the exact cause of the increase in the length of the zone of contaminant removal, the increase in bed depth required to treat the VOC mixture has both positive and negative implications for bioreactor operation. If the entire packed-bed depth is required to remove the inlet contaminant concentration during normal operation, the bioreactor has less available capacity for responding to a spike in contaminant concentration during unsteady-state loading. On the other hand, utilization of a larger fraction of the bed depth could help to distribute biomass more evenly throughout the bioreactor since the carbon source is more evenly distributed through the column.

5.2.3 VOC Interactions

The presence of multiple chemicals in an inlet waste gas stream increases complexity of the biodegradation processes (Ottengraf *et al.*, 1986). A number of relationships between pairs of chemicals or with the BTEX mixture have been investigated (Jorio *et al.*, 1998; Deshusses *et al.*, 1999; Paca *et al.*, 1998; Romstad *et al.*, 1998; Morales *et al.*, 1998; Corsi and Seed, 1995); however, little previous research has been conducted using paint VOC mixtures. To gain a better understanding of the system, experiments were conducted to evaluate the potential effects of the multiple constituents present in the paint VOC mixture utilized.

Degradation Order. The first VOC interaction investigated was the chemical degradation order. The column profiles presented in Section 5.2.2 indicate that there is a specific degradation order for this particular mixture. Analysis of the concentration profiles along the length of the bioreactor revealed that the five paint VOC constituents were degraded in the following order: *n*-butyl acetate, ethyl 3-ethoxypropionate, methyl *n*-propyl ketone, toluene, and *p*-xylene. Such a specific degradation order can be the result of kinetic and mass transfer differences between pollutants, competition between pollutant-degrading organisms, toxicity effects, and differences in distribution of the microbial populations within the bioreactor. Furthermore, aromatic compounds are generally more difficult to degrade than compounds with a straight-chain structure, and organisms typically degrade the compounds that generate the greatest quantities of energy (Madigan *et al.*, 2000). While little work has been done with paint VOC mixtures, a preferred degradation order of toluene, benzene, and then xylene was observed in a previous biofilter treating an aromatic hydrocarbon mixture (Corsi and Seed, 1995).

To confirm this degradation order, a series of bottle studies were performed. Chemical concentrations as a function of time for *n*-butyl acetate, methyl *n*-propyl ketone, toluene, and xylene in the bottle study are presented in Figure 5-17.

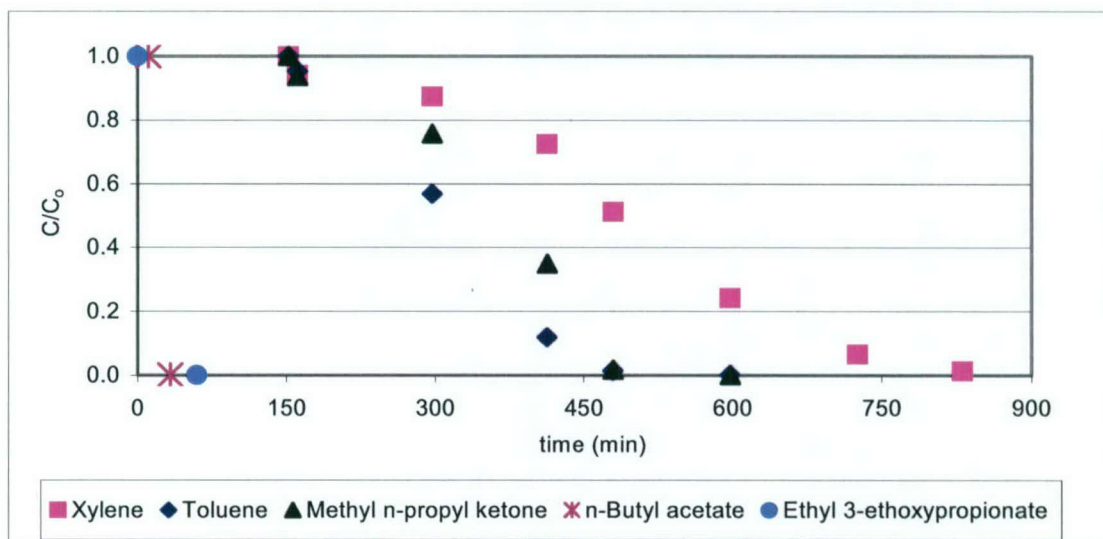

Figure 5-17. Degradation of the Paint VOC Mixture in a Bottle System.

As shown in the figure, *n*-butyl acetate was fully degraded in less than 30 minutes. Liquid chromatography analysis was performed for ethyl 3-ethoxypropionate. Problems with samples and equipment prohibited consistent sampling, but samples measured after 1 hour had non-detectable concentrations of the ethyl 3-ethoxypropionate. The remaining contaminants were degraded in the following order: methyl *n*-propyl ketone and toluene, followed by xylene. The degradation order observed in the bottle study was similar to that observed in the column except that in the bottle studies, the methyl *n*-propyl ketone and toluene required the same amount of time to be fully degraded, whereas in the bioreactor column, methyl *n*-propyl ketone removal was accomplished much more quickly than toluene removal. These results suggest that mass transfer may play a key role in determining the degradation order observed in the column. The more water-soluble compounds are degraded before the less soluble compounds.

VOC Interactions – Bottle Studies. There are many possible effects of contaminant mixtures on contaminant degradation, both positive and negative. These possible effects include competitive inhibition, cometabolism, or diauxic relationships. A preliminary investigation into the interactions between the five chemicals in the representative paint VOC mixture utilized in this study was conducted.

Data from the bottle studies can be used to determine if the degradation rates of a particular chemical are affected by the presence of the other chemicals in the mixture. To acquire this information, a series of bottle studies was conducted in which the concentration of each chemical was measured over time in bottles containing only one chemical and in bottles containing the complete mixture. The concentrations of chemicals supplied to the bottles mirrored the ratios of concentrations found in the column and totaled 100 mg VOC carbon per liter. Cultures used in

all of the bottle studies were initially incubated with all five chemicals to avoid the enhancement of degradation capabilities for the individual chemicals. Individual chemical bottles were supplied with the same initial concentration for the component as would be supplied as part of the mixture. Figures 5-18 through 5-20 present the normalized concentrations with respect to time measured for methyl *n*-propyl ketone, toluene, and xylene both individually and as part of the five chemical mixture.

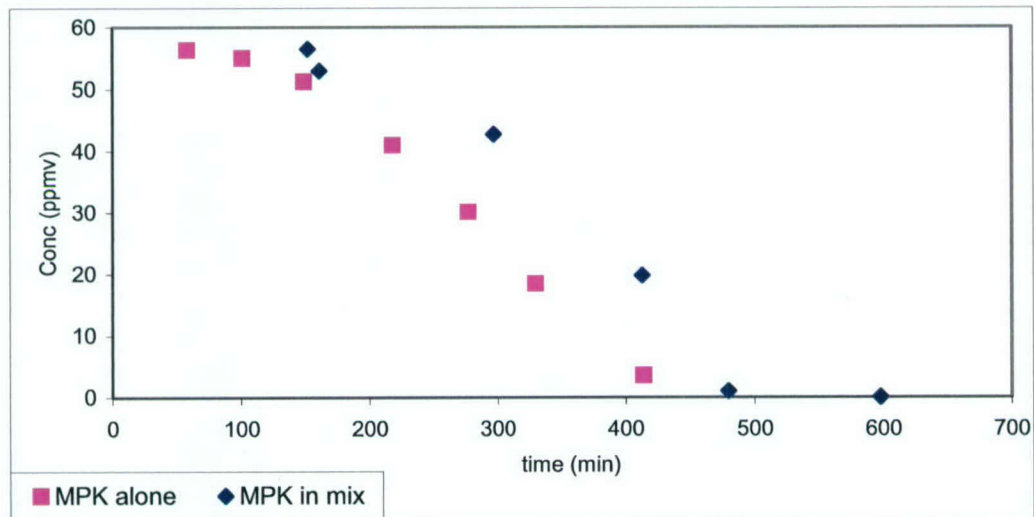

Figure 5-18. Methyl *n*-Propyl Ketone (MPK) Degradation in the Bottle Studies.

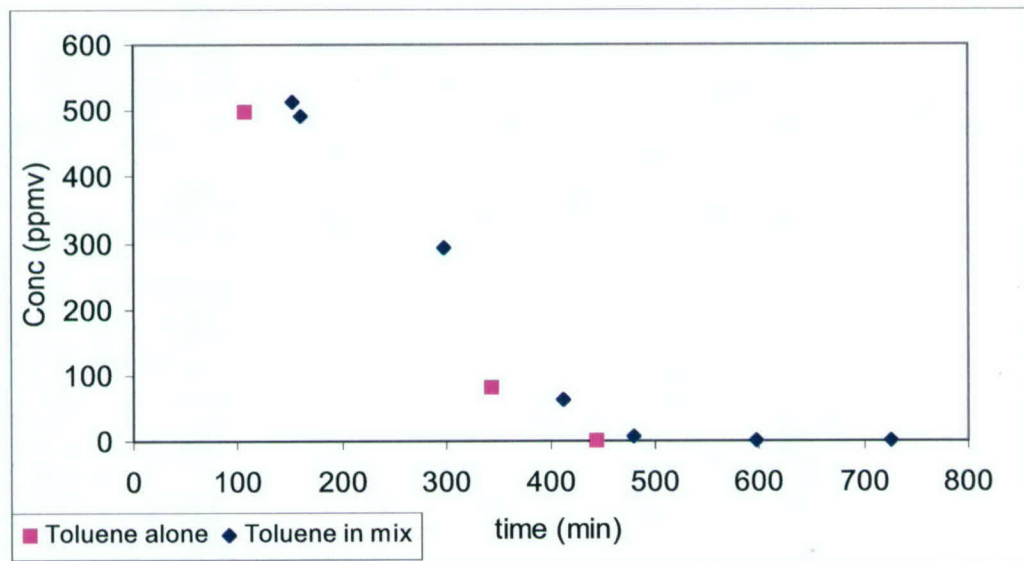

Figure 5-19. Toluene Degradation in the Bottle Studies.

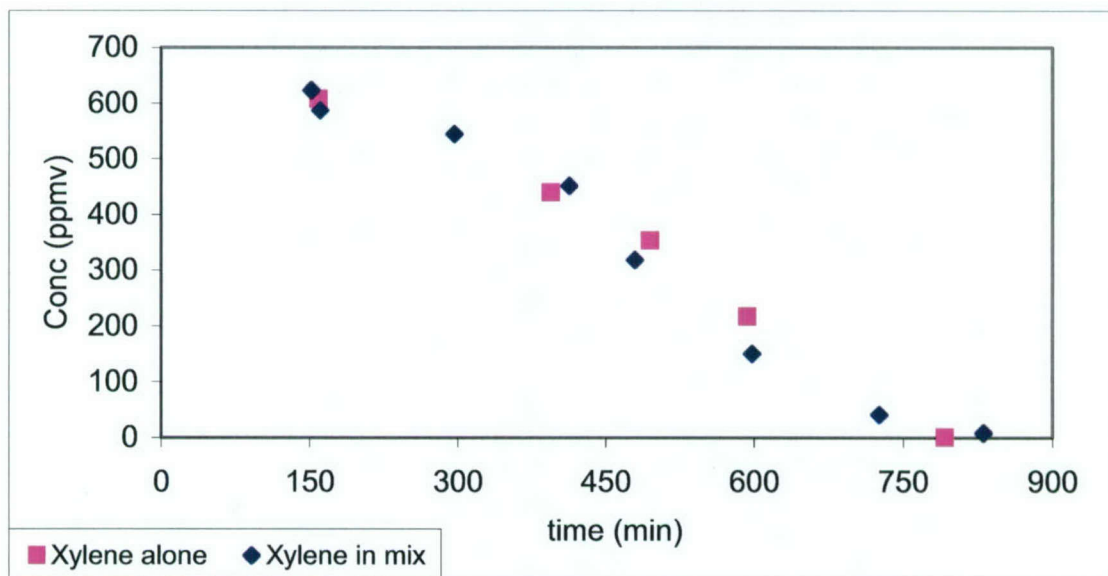

Figure 5-20. Xylene Degradation in the Bottle Studies.

To determine the degradation rate for the compound alone and as part of the mixture, a zero-order degradation rate was determined by fitting a straight line to the plot of $C - C_o = -kt$, where C is the concentration in the bottle headspace measured at time t , C_o is the initial headspace concentration, and k is the slope of the line and the determined rate constant. Again, the *n*-butyl acetate and ethyl 3-ethoxypropionate were degraded too rapidly to allow effective determination of a degradation rate. This is not of great concern, however, since no difficulties in removing these two constituents were encountered in the bioreactor. Effects of any potential degradation by-products for the *n*-butyl acetate and ethyl 3-ethoxypropionate would still be determined from results of the bottle studies containing the full VOC mixture. Table 5-18 summarizes the determined degradation rate constants (k values).

TABLE 5-4. DEGRADATION RATE CONSTANTS FOR METHYL *n*-PROPYL KETONE, TOLUENE, AND XYLENE.

<i>Chemical</i>	Alone		in Mixture	
	k	R^2	k	R^2
Methyl <i>n</i> -propyl ketone	0.184	0.997	0.161	0.935
Toluene	1.53	0.979	1.58	0.989
Xylene	0.969	0.981	1.05	0.952

Table 5-4 indicates that the mixture had little or no effect on degradation rate. The determined degradation rates for each constituent are essentially the same for the individual chemical bottle studies and the mixture bottle studies. Despite numerous reports in the literature regarding

inhibitory effects between toluene and xylene (Jorio *et al.*, 1998; Chang *et al.*, 1992; Lee *et al.*, 1993), these results suggest that there is no significant inhibition due to the presence of multiple chemicals.

VOC Interactions—Biotrickling Filter Studies. Toluene and xylene were the most difficult compounds to degrade in the biotrickling filter. Therefore, interaction studies in the bioreactor column were focused on determining the effect of the other paint constituents on toluene and xylene removal efficiencies. To evaluate the effects of each paint VOC constituent on toluene and xylene removal in the bioreactor, a series of experiments were conducted in which a single contaminant was removed from the contaminant mixture and the resulting concentration profiles along the column were measured. Concentrations of the remaining constituents were maintained at approximately the typical inlet concentration. Concentration profiles for toluene at each of the different mixture conditions are presented in Figure 5-21. The average concentration profile presented in the figure for comparison is an average of the normalized contaminant concentrations for the complete mixture over the duration of bioreactor operation at the 1-minute residence time. An average concentration profile was used to better distinguish which effects are actually a deviation from the norm and not an isolated event. The following chemical abbreviations are used in the figure legend: methyl *n*-propyl ketone (MPK); *n*-butyl acetate (NBA); and ethyl 3-ethoxypropionate (EEP).

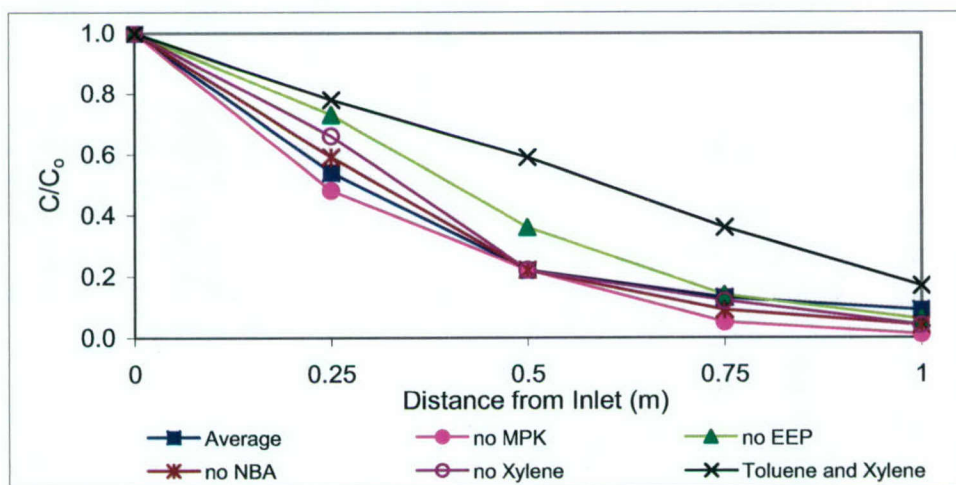

Figure 5-21. Effects of Different Mixture Conditions on Toluene Removal Profiles in the Biotrickling Filter. Bioreactor Operating Conditions: Top-feeding, Liquid Recirculation Rate = 2.7 L/min, Gas Residence Time = 1 min.

To assess the statistical variation between the removal profiles shown in Figure 5-21, a single-value *t*-test was performed to compare the average toluene removal profile with the removal profile measured at each of the conditions. The results of this analysis indicate that the only significant change in removal profiles occurred for the case in which only toluene and xylene were supplied to the bioreactor.

Concentration profiles for *p*-xylene at each of the different mixture conditions investigated in this study are presented in Figure 5-22. As with toluene, the overall removal efficiencies are

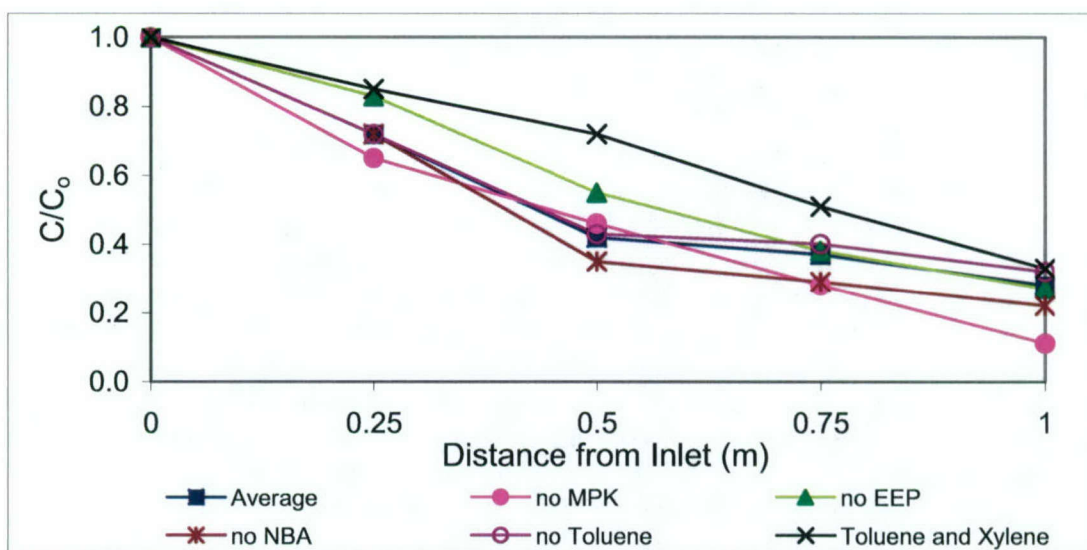

Figure 5-22. Effects of Different Mixture Conditions on Xylene Removal Profiles in the Biotrickling Filter. Bioreactor Operating Conditions: Top-feeding, Liquid Recirculation Rate = 2.7 L/min, Gas Residence Time = 1 min.

similar for each case examined with the exception of a possible decrease in performance when only toluene and xylene were supplied to the bioreactor. As with the toluene data, it was necessary to assess the statistical variation between the removal profiles shown in Figure 5-22. Therefore, a single-value *t*-test was performed to compare the average xylene removal profile in the five-component paint VOC mixture with the removal profile measured at each of the conditions. The results indicate that the only significant change in removal profiles occurred for the case in which only toluene and xylene were supplied to the bioreactor

The poor toluene and xylene removals observed in the bioreactor suggest that the microbial populations of toluene- and xylene-degrading organisms may not have been well developed in the bioreactor. Since the bioreactor typically had the highest total VOC elimination capacities in the first section, well above the loading of the toluene and xylene, it is expected that the toluene and xylene should have been degraded within the first section. However, poor toluene and xylene removals were observed in this first section even when all other paint VOCs were removed from the inlet gas mixture. These results suggest that the poor removals are not simply due to the presence of the other paint VOCs but rather due to a limited microbial population of toluene and xylene degraders. As toluene and xylene were present in low concentrations relative to the straight-chain, soluble components of the mixture, it is possible that the microbial population capable of degrading the toluene and xylene was simply much smaller than the population capable of degrading the other constituents. The presence of the paint VOC constituents may have had some effect on the biomass growth of the toluene and xylene degraders. Chang *et al.* (1993) determined that the presence of *p*-xylene reduced cell yield for a BTX-degrading culture.

5.2.4 Directionally Switching Operation

To investigate the effectiveness of directionally switching operation in a biotrickling reactor treating a mixture of chemicals, we operated the biotrickling filter in directionally switching mode from day 1 to day 36 of operation. COD samples were periodically collected from each of the four packed sections of the bioreactor to assess biomass accumulation. Figure 5-23 depicts the biomass distribution in the biotrickling filter on day 27 of directionally switching operation.

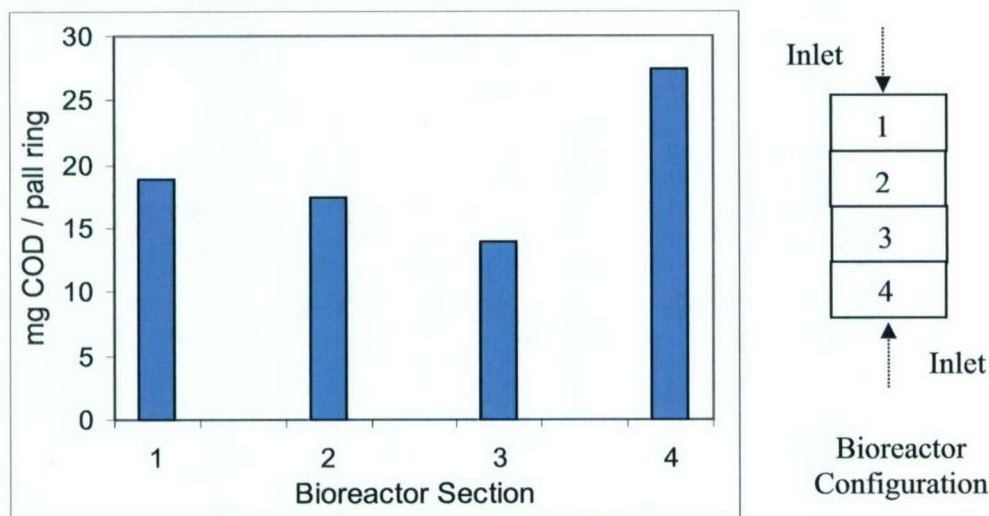

Figure 5-23. Biomass Distribution in the Biotrickling Filter on Day 27 of Operation in Directionally Switching Mode.

In Figure 5-23, the biomass concentrations are greatest in the top and bottom sections of the column. These results indicate that directionally switching operation can effectively distribute the biomass in a biotrickling reactor. This is the first example of successful directionally switching operation in a biotrickling filter.

Oftentimes, organisms degrading a particular component of a mixture can be spatially segregated within a column (*e.g.*, if methyl *n*-propyl ketone is degraded only in the inlet section, microorganisms within that section may be primarily ketone degraders that may not readily degrade a different contaminant). To determine the effect of directionally switching operation on bioreactor performance, concentration profiles along the length of the column were collected in both top-feeding and bottom-feeding modes. Figures 5-24 and 5-25 present concentration profiles for each compound in top-feeding and bottom-feeding modes at a 1-minute EBRT.

As can be seen from the data in Figures 5-24 and 5-25, overall bioreactor performance was not drastically affected by directionally switching operation at the 1-minute residence time. However, the direction of feed did have some effect on the shape of the toluene and xylene removal profiles even though overall removal was unaffected. Similar results were obtained for the 1.5-minute and the 30-second gas residence times.

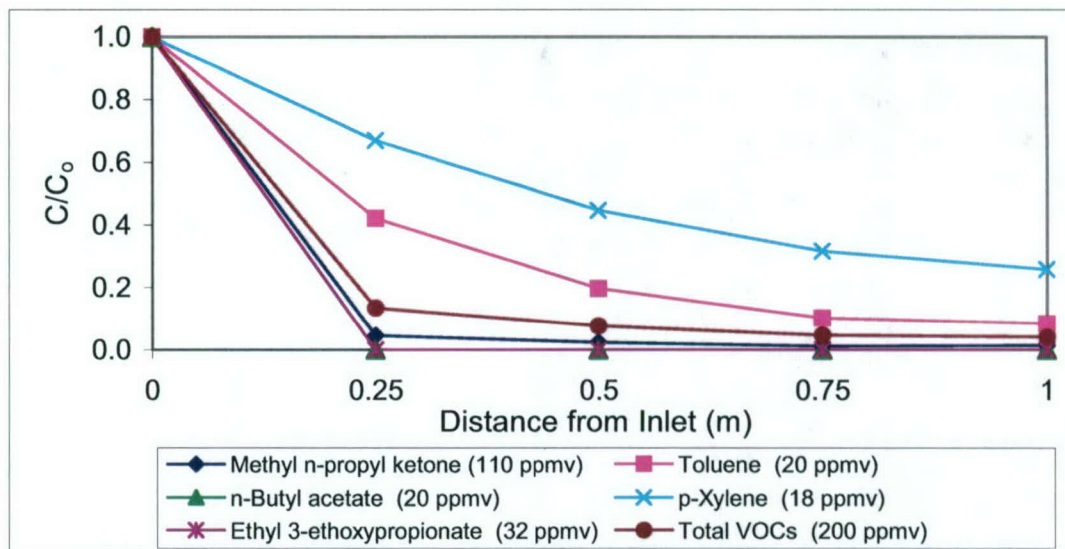

Figure 5-24. Typical Concentration Profile for top-Feeding Operation , Day 39

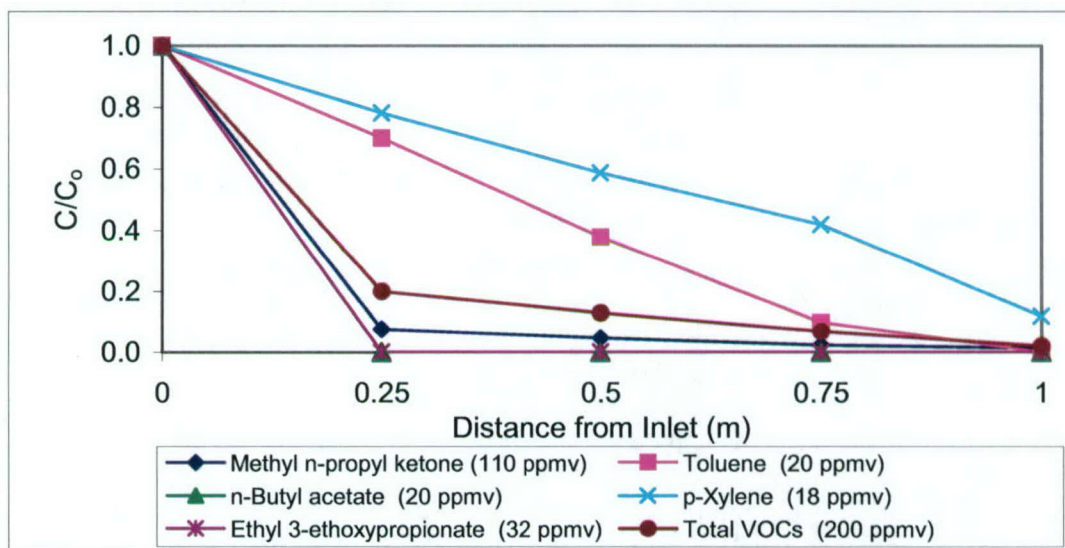

Figure 5-25. Typical Concentration Profile for Bottom-Feeding Operation, Day 35

5.2.5 Summary and Conclusions

Results of the biotrickling filter experiments indicate that biotrickling filters are feasible for paint spray booth applications within the range of operating conditions examined. Once a biofilm was successfully established on the pall ring packing material, the biotrickling filter was most efficient at removing the highly soluble components of the waste gas stream. Toluene and xylene required a greater bed depth for removal, and the elimination capacities of these compounds in the biotrickling filter were generally lower than those reported in the literature for other systems. Results of the laboratory-scale tests suggest that a microbial population capable of degrading aromatic hydrocarbons was never well established in the biotrickling filter. This

likely occurred because the other components of the VOC mixture were more readily degradable and were present in much greater concentrations in the bioreactor. There was thus no selective pressure that favored development of a robust aromatic hydrocarbon degrading population within the biotrickling filter. This may have been further exacerbated by mass transfer limitations. Nevertheless, overall high VOC removals were achieved since toluene and xylene made up a relatively small fraction of the simulated waste gas stream.

One advantage of a biotrickling filter is that pH and nutrient levels in the bioreactor can be adjusted readily. This allows greater control over the operating conditions within the biotrickling filter and more flexibility to respond to operational problems. This feature became important during the bioreactor start-up period, when initial removals were quite low until the pH and nutrient supply were adjusted. Despite this advantage of biotrickling filter design, the need to continuously recirculate nutrient solution through the bed at a high rate to ensure that the nutrient solution is well distributed in the packing material would increase operating cost of the system. In addition to increased pumping costs, the results of the lab-scale tests suggest that the nutrient solution should be refreshed on a fairly frequent basis (e.g., two to three times per week); a factor which would also add to the cost of the system. Finally, to minimize liquid hold-up in such a system, a relatively open packing material such as pall rings must be utilized. While the open structure utilized in these studies minimized biomass clogging, it also reduced the surface area per unit volume of packing and essentially reduced the biologically active area in the bioreactor. This in turn may have reduced the contaminant elimination capacity of the system, particularly for aromatic hydrocarbons in the waste gas stream. Despite these potential disadvantages, biotrickling filters remain a viable option for treating paint spray booth emissions.

Other specific observations relevant to the application of biotrickling filters for paint spray booth applications are summarized below:

- Elimination capacities comparable to those reported in the literature can be achieved in a biotrickling filter treating a mixture of methyl *n*-propyl ketone, *n*-butyl acetate, ethyl 3-ethoxypropionate, toluene, and *p*-xylene. The elimination capacities were found to be a linear function of mass loading for *n*-butyl acetate and ethyl 3-ethoxypropionate at loads up to 103 g/m³-hr and 36 g/m³-hr, respectively. Methyl *n*-propyl ketone reached elimination capacities in the range of 120 to 160 g/m³-hr, while toluene and xylene maximum elimination capacities hovered at 10 g/m³-hr and 12 g/m³-hr, respectively. Total VOC elimination capacities ranged from 240 g/m³-hr to 340 g/m³-hr as a result of the elimination capacities of methyl *n*-propyl ketone, *n*-butyl acetate, and ethyl 3-ethoxypropionate, the components that made up 80% of the inlet loading.
- Biotrickling filters packed with polypropylene pall rings can successfully treat a five-chemical paint VOC mixture. A maximum removal efficiency of 98% was achieved in a biotrickling filter with a recirculating liquid stream treating a mixture of five paint VOCs. Reducing the gas residence time in the reactor at the 200 ppm_v total VOC inlet concentration had little effect on overall removal efficiencies, but did affect the concentration profiles along the column. Ethyl 3-ethoxypropionate and *n*-butyl acetate were fully degraded, and 98% removal efficiency of methyl *n*-propyl ketone was achieved. Only 94% of the toluene and 60 to 80% of the xylene was removed. Thus toluene and xylene limited the overall removal efficiency for the complete mixture.

- Residence times of 1.5 minute, 1 minute, and 30 seconds had little effect on overall removal efficiency or elimination capacity under the conditions tested. When elimination capacity tests were performed by changing the concentration at each of the three residence times (1.5 minutes, 1 minute, and 30 seconds), the resulting elimination capacity curves were similar. Changing the residence time while holding the total VOC inlet concentration steady at 200 ppm_v had no effect on overall removal efficiencies, but an increased bed depth was required to degrade each of the components between the 1-minute and 30-second residence times.
- Contaminants in the five-component mixture representative of paint VOCs were degraded in a specific order. The following degradation order was observed in the biotrickling filter: *n*-butyl acetate, ethyl 3-ethoxypropionate, methyl *n*-propyl ketone, toluene and then *p*-xylene.
- Toluene and xylene removal limited overall removal achieved in the biotrickling filter. This poor removal may have been due to a limited microbial population in the biotrickling filter capable of degrading these constituents.

Resulting Publications

- Kazenski, S. L. *Biofiltration for Paint Spray Booth Applications*” Thesis, Masters of Science in Engineering, The University of Texas at Austin, May 2000. Research Supervisor: Dr. Kerry A. Kinney.

CHAPTER 6: EVALUATION OF A BIOTRICKLING FILTER/ BIOFILTER HYBRID

Results of the biotrickling filter experiments indicate that biotrickling filters are quite efficient at removing the soluble components of a surrogate paint VOC mixture but less efficient at removing the relatively insoluble aromatic hydrocarbons. One potential solution to this problem is to devise a hybrid bioreactor that combines a biotrickling filter in series with a biofilter. Biotrickling filters are well suited to removing hydrophilic compounds whereas biofilters are generally more effective for relatively hydrophobic compounds that do not generate acidic products (Van Groenestijn *et al.*, 1993). Deviny and Chitwood (2000) recently demonstrated the feasibility of such a hybrid system for a waste gas stream containing H₂S and VOCs. The primary purpose of the current study phase described in this chapter was therefore to assess the performance of a biotrickling filter/biofilter hybrid system for treating a mixture of paint VOCs.

Along with bioreactor configuration, substrate interactions among the VOCs present in a paint mixture are another important factor that must be considered to achieve successful bioreactor operation. Previous studies have indicated that the presence of a readily degradable compound can inhibit the removal of the other recalcitrant compound, but the removal of the readily degradable compound is not substantially affected by the presence of the recalcitrant compound (Deshusses *et al.*, 1999; Lu *et al.*, 2001; Mohseni and Allen, 2000). In addition, the effect of packing media nitrogen levels on VOC-substrate interactions has not been examined. Thus, the effect of substrate, interactions and nitrogen availability were also examined in this phase of the research. The results described below have been published in *Environmental Progress* (Song and Kinney, 2003).

6.1 Methods

Two identical hybrid bioreactors were used in this study (Song and Kinney, 2003). Each column consisted of a stainless steel column (26 cm i.d.) that was divided into two modules (Figure 6-1). The first (bottom) module contained channelized plastic packing material and was operated as a biotrickling filter with an empty volume of 16.2 L. A spray nozzle (TF, BETE Fog Nozzle, Inc., Mass.) was used to continuously recirculate a buffered nutrient solution at a flow rate of 7.5 L/min through this module. The sump at the base of the biotrickling filter module had a volume of 6 L, and 2 L of the recirculating solution was replaced daily with fresh nutrient solution (1.36 g/L KH₂PO₄, 0.71 g/L Na₂HPO₄, 0.66 g/L (NH₄)₂HPO₄, 3.03 g/L KNO₃). The second (top) module of the column was operated as a biofilter with a total packed-bed volume of 29.7 L. This module was subdivided into four identical sections and packed with a compost-based balled media in an open plastic structure (Bio·Reaction Industries, LLC, Tualatin, Oregon) to an overall bed height of 56 cm. Both bioreactors were operated over a 90-day period to establish stable operation prior to conducting the experiments described below.

Bioreactor Operation. A series of experiments were conducted under nitrogen-limited (NL) conditions in one hybrid bioreactor column and nitrogen-rich (NR) conditions in the second, identical column. Table 2 summarizes the bioreactor operating conditions and VOC and nutrient loading conditions used throughout this study. During the nitrogen-limited experiments, the hybrid bioreactor column was rinsed four times (day 0 for Experiment NL1, day 25 for Experiment NL2, day 48 for Experiment NL3, and day 72 for Experiment NL4) with 10 L of a

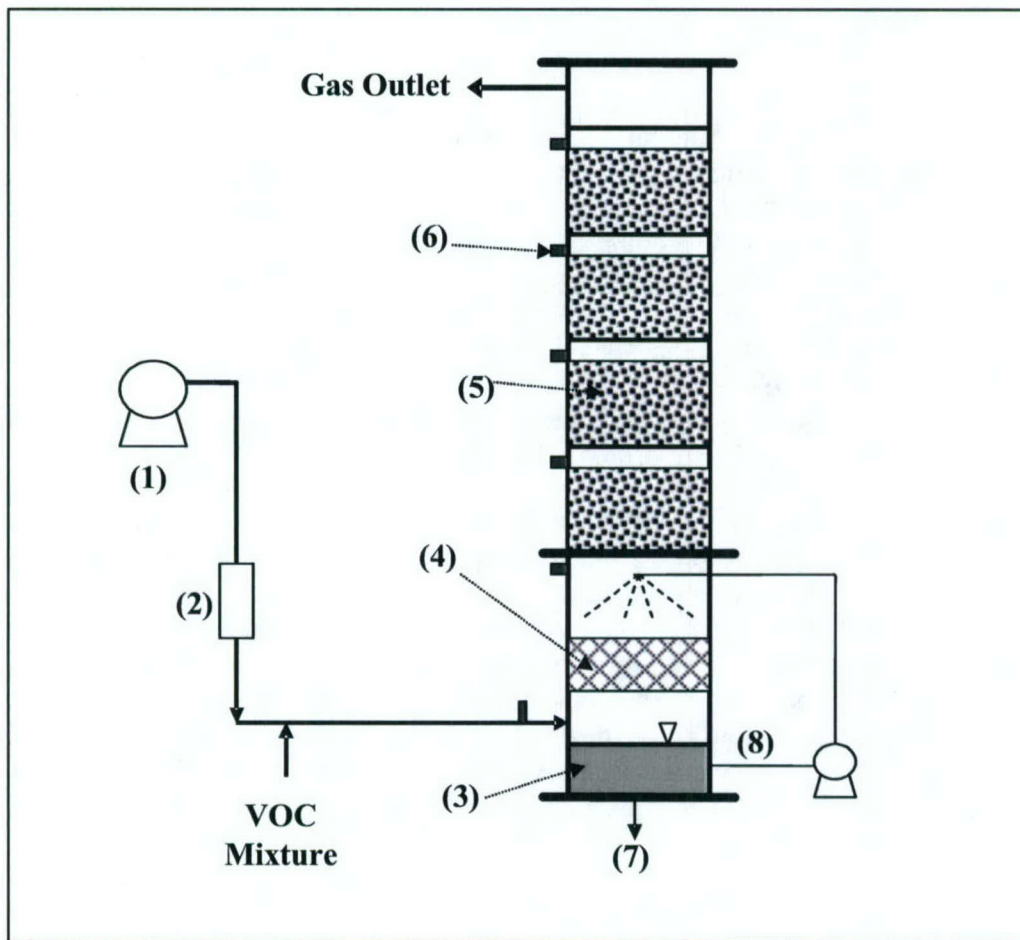

Figure 6-1. Schematic Diagram of Biotrickling Filter/ Biofilter Hybrid Used in Study Phase 4: (1) Air Blower, (2) Flow Meter, (3) Liquid Sump, (4) Plastic Packing in Biotrickling Filter, (5) Compost-based Packing in Biofilter Unit, (6) Gas Sampling Port, (7) Waste Line, (8) Nutrient Recirculation System (Taken from Song and Kinney, 2003).

phosphate buffer solution containing various nitrogen concentrations. After allowing the excess nutrient solution to drain from the column, the initial nitrogen content of the biofilter packing was determined and the VOC feed to the column was resumed. No additional nutrient adjustment was made to the biofilter packing for the remainder of each three-week nitrogen experiment.

During the nitrogen-rich experiments conducted in the second, identical hybrid bioreactor, a phosphate buffer medium containing high nitrogen concentration (see Table 6-1) was manually sprayed over the top of the column once every three days throughout the 75-days of operation. In this way, a supplied C/N ratio of 15 or greater was provided to the reactor to maintain nitrogen-rich conditions as demonstrated by Smith *et al.* (1996) in a biofilter. This bioreactor column was operated over a range of inlet VOC loadings by decreasing the gas-phase residence time (NR2 and NR3) as indicated in Table 6-1.

TABLE 6-1. HYBRID BIOREACTOR OPERATING CONDITIONS AND NITROGEN SUPPLY.

Parameter		Nitrogen-Limited Experiments				Nitrogen-Rich Experiments		
		NL1	NL2	NL3	NL4	NR1	NR2	NR3
Duration (day)		21	19	20	16	24	27	27
Total VOC Inlet Conc. (ppm _v)		112				113	110	54
Gas-Phase Residence Time (s)		46				46	23	23
VOC Loading (g/m ³ /hr)		32				32	64	32
Nutrient Solution ^{1,2}	KH ₂ PO ₄ (g/L)	1.36	1.36	1.36	1.36	-		
	Na ₂ HPO ₄ (g/L)	1.42	0.71	0.71	0.71	14.2		
	(NH ₄) ₂ HPO ₄ (g/L)	-	0.66	0.66	0.66	-		
	(NH ₄) ₂ SO ₄ (g/L)	-	-	1.54	3.08	-		
	KNO ₃ (g/L)	-	3.03	10.1	20.2	50.5		
	NH ₄ NO ₃ (g/L)	-	-	-	-	40.4		

¹ Each nutrient solution contained phosphate and nitrogen salts as delineated above as well as trace metals.

² Ten liters of nutrient solution were manually sprayed over the top of the hybrid bioreactor at the beginning of each nitrogen-limited experiment. During the nitrogen-rich experiments, 0.5 L of a highly concentrated nitrogen solution was sprayed over the top of the column once every three days.

To determine the effect of initial media nitrogen levels on paint VOC removals, the nitrogen concentration in the biofilter packing media was adjusted four times (Experiments NL1, NL2, NL3 and NL4) while the inlet VOC loading was held constant at 32 g/m³/hr (see Table 6-1).

6.2 Results

Figure 6-2 summarizes the overall VOC removal efficiencies measured throughout each experiment as well as the actual media nitrogen levels in the biofilter module measured at the beginning and the end of each experiment. The average initial nitrogen levels of the compost packing media following the rinse at the beginning of Experiments NL1, NL2, NL3 and NL4 were approximately 12 (s.d. ±6), 90 (±11), 340 (±52), and 750 (±162) mg-N/kg, respectively.

Figure 6-3 illustrates the removal profiles of each VOC along the bioreactor column in Experiments NL1, NL2, NL3, and NL4. At the lowest available-nitrogen condition (12 mg-N/kg), ethyl 3-ethoxypropionate (EEP) was completely removed in the first half of the bioreactor column. Most of the *n*-butyl acetate (NBA) and approximately 75% of the methyl propyl ketone (MPK) were degraded in the biofilter, but they penetrated throughout the entire column. Moreover, virtually no toluene or *p*-xylene was removed from the mixture under this severely nitrogen-limited condition (Figure 6-3(a)).

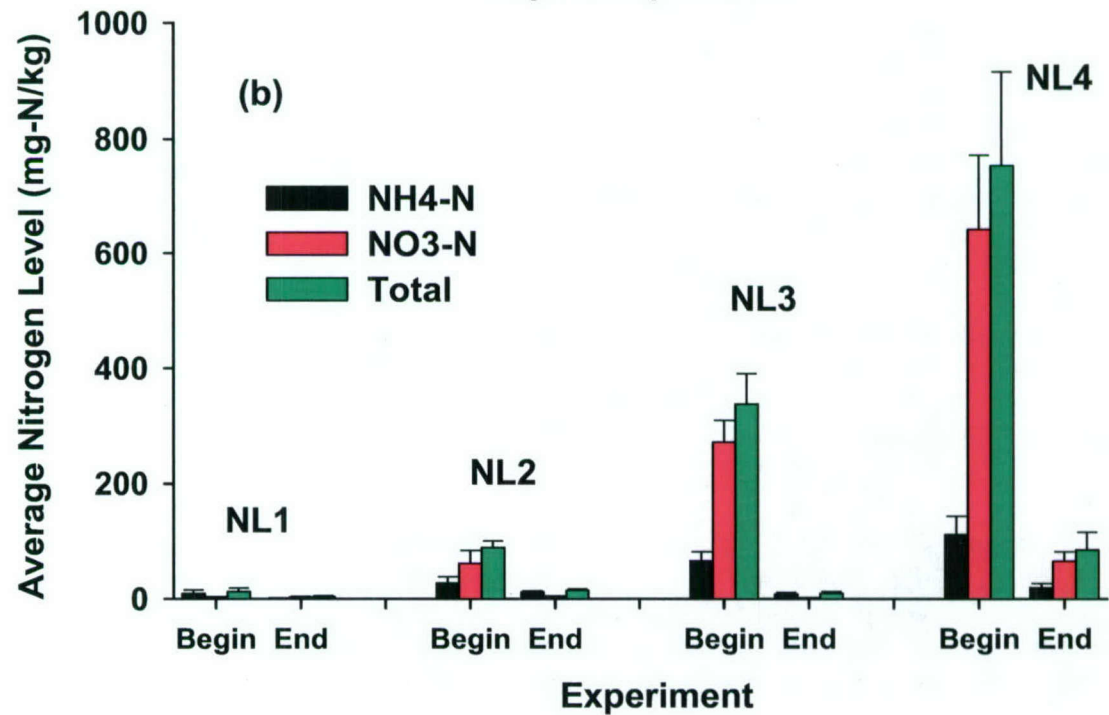
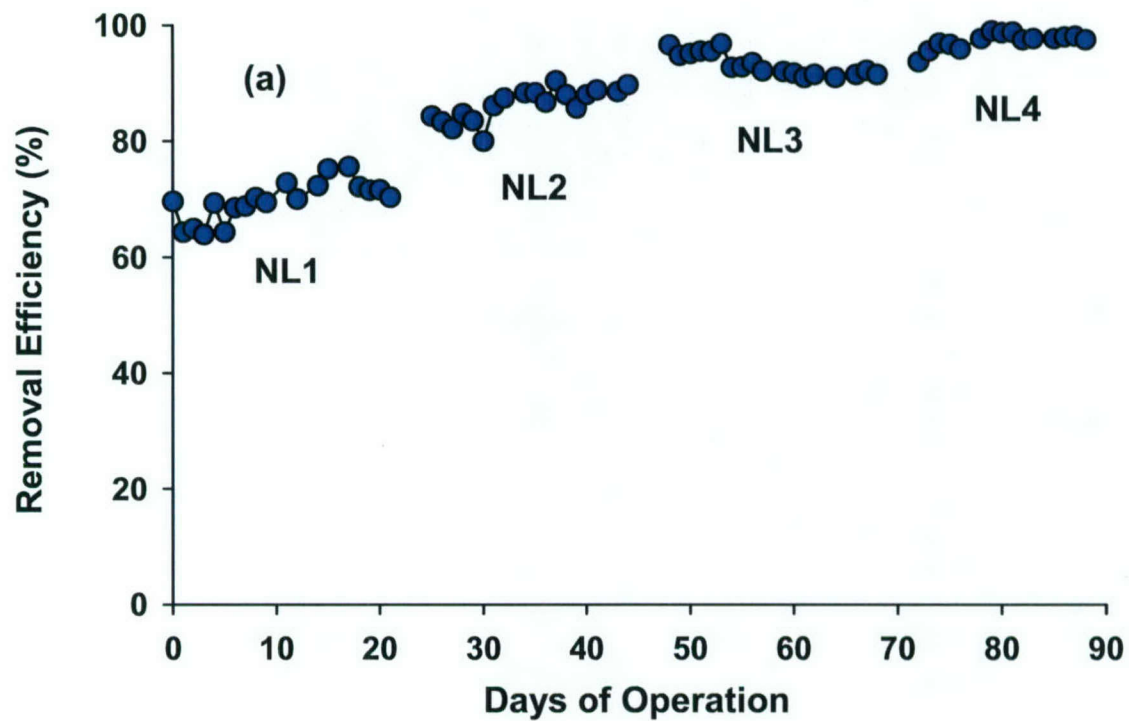

Figure 6-2. (a) Total VOC Removal Efficiencies and (b) Average Biofilter Media Nitrogen Levels Measured at the Beginning and the End of Each Nitrogen-Limited Experiment (Taken from Song and Kinney, 2003). Error Bars Indicate Standard Deviations.

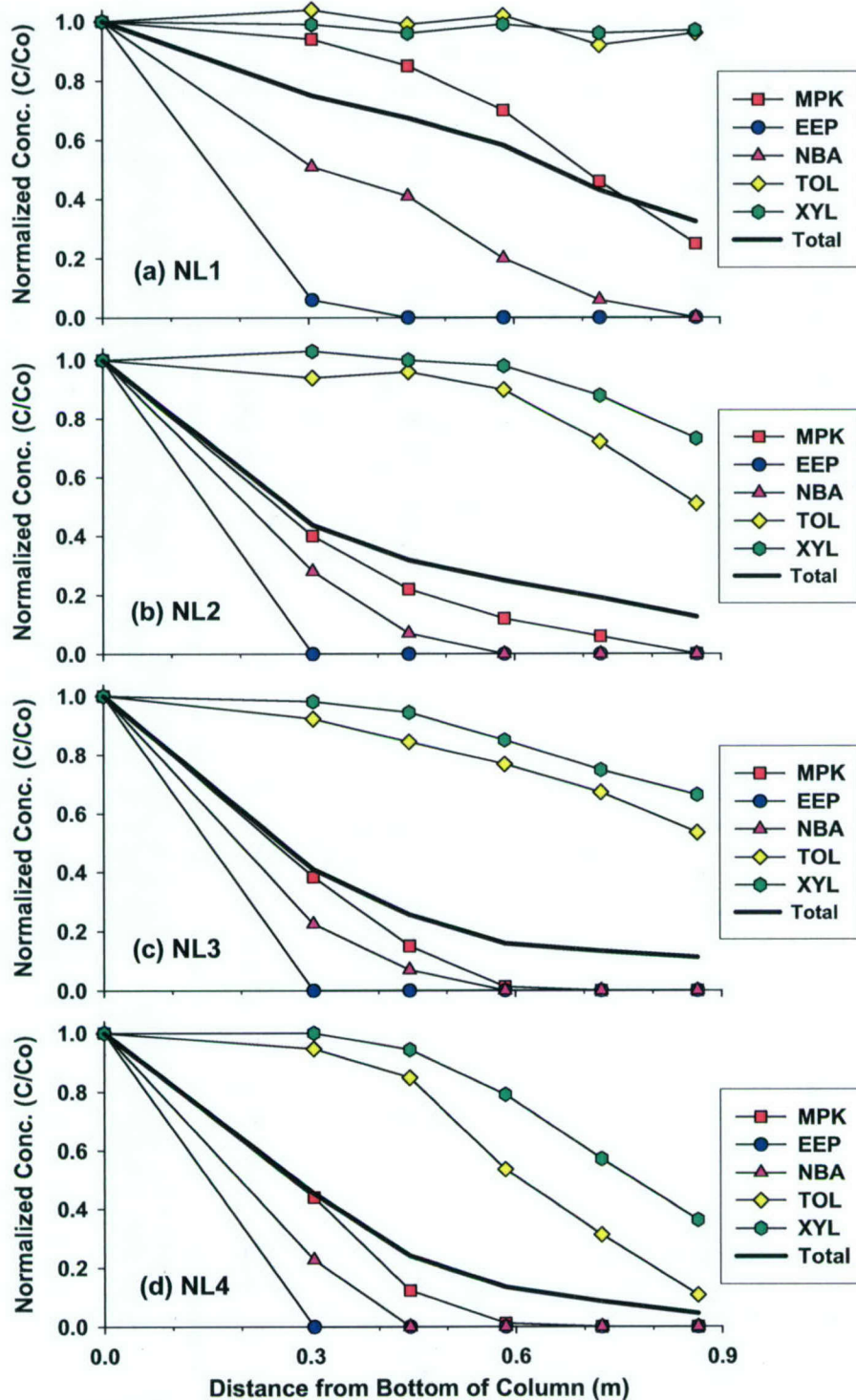

Figure 6-3. VOC Removal Profiles Determined along the Hybrid Bioreactor Column during the Nitrogen-limited Experiments (NL1, NL2, NL3, and NL4). MPK: Methyl Propyl Ketone; EEP: Ethyl 3-Ethoxypropionate; NBA: *n*-Butyl Acetate; TOL: Toluene; XYL: *p*-Xylene. (Taken from Song and Kinney, 2003)

Increasing the nitrogen availability to 90 and 340 mg-N/kg improved the biodegradation of NBA and MPK substantially. It was also found that MPK and NBA were primarily degraded in the front portion of the hybrid bioreactor. The removal of toluene and xylene also improved with increasing nitrogen availability but to a much lesser extent (Figures 6-3(b) and (c)) indicating that the nitrogen concentration in the biofilter module was still too low to remove the toluene and *p*-xylene constituents completely.

To investigate substrate interactions further, the total *EC*s for the five-component paint mixture were measured in each nitrogen-limited experiment by increasing the total VOC loading rate to the bioreactor. As shown in Figure 6-4, the maximum *EC* determined during experiment NL1 (the media nitrogen level of 12 mg-N/kg) was approximately 40 g-VOC/m³/hr. When the media nitrogen level was increased to 90 mg-N/kg (NL2), the maximum *EC* doubled to approximately 80 g-VOC/m³/hr. This increase in maximum *EC* was mostly due to an increase in the *EC* of MPK since the *EC*s for the aromatic compounds did not change substantially with the increase in media nitrogen level. These results indicate that under severely limiting nitrogen conditions, the available nitrogen is primarily utilized by the microorganisms responsible for the removal of the readily degradable VOCs.

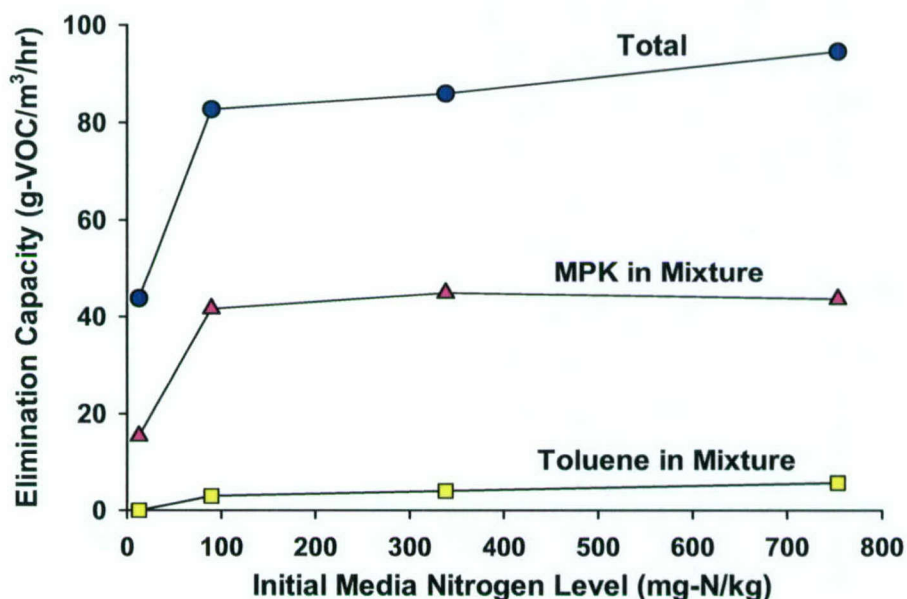

Figure 6-4. Maximum Elimination Capacities of the Five-component VOC Mixture As Well As Methyl Propyl Ketone (MPK) and Toluene in the Mixture As a Function of Initial Media Nitrogen Level. (Taken from Song and Kinney, 2003)

Consequent increases in media nitrogen levels to 340 mg/kg and 750 mg/kg (NL3 and NL4) resulted in only slight increases in total *EC*. These results are comparable to experimental results reported by Gribbins and Loehr, who found that increases in media nitrogen level up to 1500 mg-N/kg had a significant effect on toluene *EC* but further increases in media nitrogen level above that value had little effect on toluene removal in the compost biofilter (Gribbins and Loehr, 1998). In the current study, however, the biodegradation capacity of MPK did not

improve for media nitrogen levels between 90 and 750 mg-N/kg. These results indicate that the slight increase in nitrogen availability from 12 to 90 mg-N/kg was sufficient for the microbial populations responsible for MPK degradation to reach their maximum capacity. In contrast, the increase in the *EC* for toluene and *p*-xylene throughout these experiments was less substantial than that observed for MPK, implying that increases in media nitrogen levels up to 750 mg-N/kg were not sufficient to enhance microbial populations for aromatic VOC degradation.

Substrate inhibitions between the paint VOCs were examined further by determining the *EC*s for individual VOC constituents during experiment NL4. Figure 6-5 illustrates the individual *EC* curves for MPK, toluene and *p*-xylene. The maximum *EC* measured when MPK was the

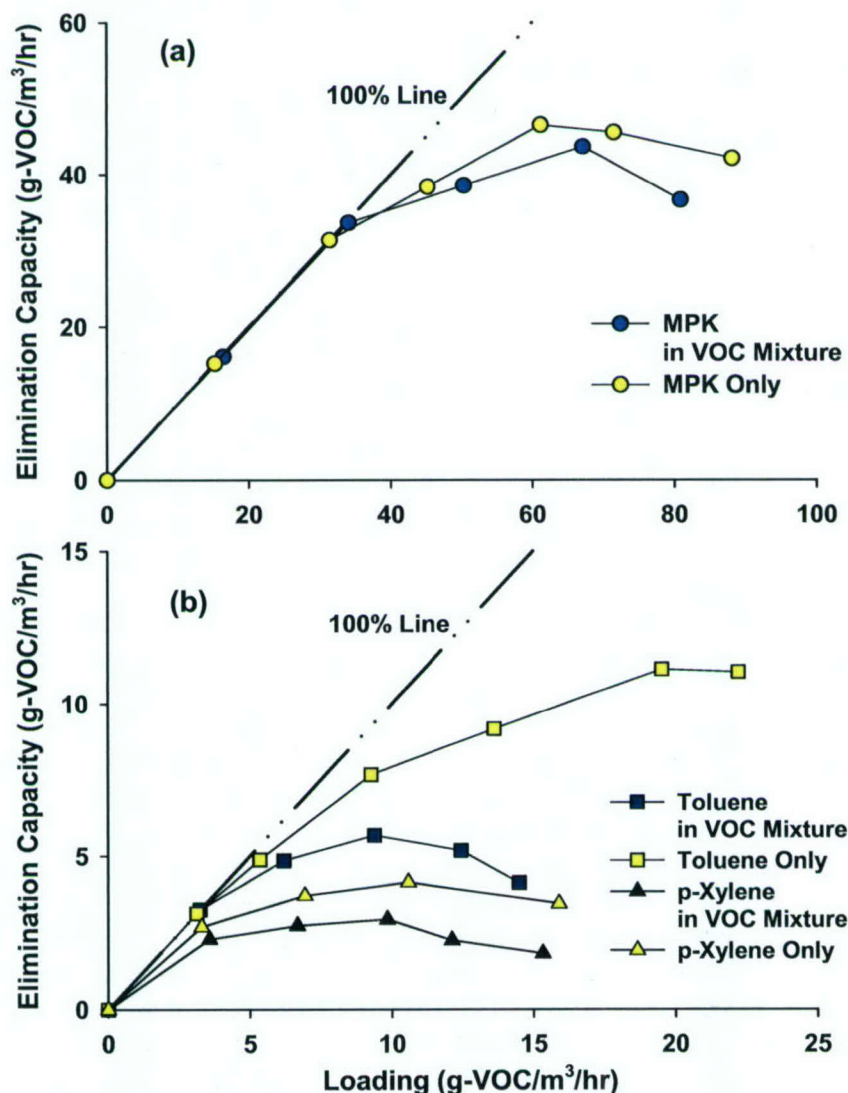

Figure 6-5. Elimination Capacity Curves for (a) Methyl Propyl Ketone (MPK), and (b) Toluene and *p*-Xylene When Present As the Sole VOC or As Part of the Five-component Paint VOC Mixture. (Taken from Song and Kinney, 2003)

sole VOC present was not significantly different from that determined when the entire five-component mixture was present (see Figure 6-5(a)). In contrast, the maximum *EC* measured when toluene alone was present was more than double that measured when the entire VOC mixture was present (Figure 6-5(b)). When only toluene was present in the waste gas stream, the toluene *EC* increased as the toluene loading increased. The toluene *EC* curve when the entire mixture was present, however, clearly shows a decline at higher loading rates indicating substrate inhibition effects. The *EC* curves determined for *p*-xylene alone and *p*-xylene in the VOC mixture followed the same trends observed for toluene. These experimental results confirm that the biodegradation of toluene and *p*-xylene was severely inhibited by the presence of other readily degradable constituents (*e.g.*, MPK), but the degradation of the MPK, NBA or EEP were not substantially influenced by the presence of the aromatic compounds.

The effect of substrate inhibition was also investigated under nitrogen-rich conditions that did not limit microbial growth in the biofilm. The main difference between the removal profiles observed under the nitrogen-rich conditions and those observed under the nitrogen-limited conditions is that more than 80% of the soluble constituents introduced into the column were removed in the first biotrickling filter module (front 0.3 m) under nitrogen-rich conditions. Active, exponential removal of toluene was observed only along the biofilter module, and greater than 90% of *p*-xylene was removed as a linear function of the bed depth in the biofilter module. Greater than 99% overall removal of the VOC paint mixture was obtained under nitrogen-rich conditions (data not shown, see Song and Kinney, 2003) at a 46-second gas-phase residence time. VOC removals of greater than 90% were also achieved at a gas-phase residence time as low as 23 seconds under these conditions. Although the nitrogen-rich conditions improved the removal of the aromatic hydrocarbons and thus the overall VOC removal efficiency achievable in the system, it also led to rapid biomass clogging of the biotrickling filter module at the 62 g/m³/hr loading investigated in this study. Thus, a balance must be struck between improving aromatic hydrocarbon removal in the system and preventing excess biomass accumulation, at least at high VOC loading rates.

6.3 Summary and Conclusions

Results of this phase of the study indicate that VOCs commonly found in paint emissions can be removed efficiently in a hybrid bioreactor but the biodegradation of the aromatic hydrocarbon constituents controls the overall removal efficiency achievable in the system. The hydrophilic components of the surrogate paint VOC mixture were readily degradable in the hybrid system even when the nitrogen level in the biofilter module was relatively low. However, removal of the recalcitrant VOCs toluene and *p*-xylene was much more sensitive to nitrogen availability, and virtually no degradation occurred at very low media nitrogen levels (*e.g.* 12 mg-N/kg packing media). Substrate interactions between MPK and the aromatic hydrocarbons also played a role in the observed VOC degradation patterns. Short-term elimination capacity tests indicate that the removal capacity of the hybrid system for aromatic hydrocarbons was reduced when NBA, MPK and EEP were also present in the waste gas stream. Even under nitrogen-rich conditions, the degradation of toluene and *p*-xylene was inhibited by the presence of MPK but, once the MPK was degraded, the remaining aromatic hydrocarbons were degraded efficiently when sufficient nitrogen was available.

Despite the successful performance of the hybrid bioreactor treating paint spray emissions, several potential problems were identified with the hybrid bioreactor configuration investigated (Figure 6-1). First, in the experimental hybrid system, the biofilter column was placed directly atop the biotrickling filter module. As a result, when nutrients were provided to the biofilter module, excess nutrient solution penetrated to the lower biotrickling filter portion of the system. The excess nutrients in the lower biotrickling filter module led to rapid biomass clogging in this module at high VOC loading rates. This problem is easily remedied by completely separating the biotrickling filter module from the biofilter module. Two separate modules will add to the complexity and cost of the system but will allow the operators to optimize the operating conditions in each bioreactor module separately. Thus, a concentrated nutrient solution could be applied to the biofilter packing material to overcome nitrogen limitations without affecting the operation of the biotrickling filter. Also, should excess biomass need to be periodically removed from the biotrickling filter, this could be accomplished without disturbing the downstream biofilter. The biofilter module itself can be packed with an inexpensive compost-based material and should be much less prone to clogging since it would be treating only the relatively low levels of hydrophobic pollutants that are not degraded in the biotrickling filter.

As noted earlier, most of the soluble VOC removal occurred in the biotrickling filter portion of the hybrid bioreactor. However, some methyl propyl ketone penetrated the biotrickling filter and entered the downstream biofilter. The experimental results indicate that the presence of methyl propyl ketone reduced the removal of toluene and xylene in the downstream biofilter. Thus, the size of the biotrickling filter should be increased as necessary to remove approximately 80 to 90% of the ketone constituents in the waste gas stream. This design should minimize the substrate inhibitions observed in the downstream biofilter unit and improve the removal of the aromatic hydrocarbons in the system.

Publications Resulting from Research

- Song, J., Kinney, K.A. John, P. 2003. "Influence of Nitrogen Supply and Substrate Interactions on the Removal of Paint VOC Mixtures in a Hybrid Bioreactor," *Environmental Progress*, **22**(2): 137-144.

CHAPTER 7: ASSESSMENT OF FUNGAL BIOFILTERS

Currently, most biofilter applications utilize undefined mixed cultures generally thought to consist primarily of bacteria. In spite of many successful applications, several researchers have reported that biofilters exhibit diminished treatment performance and dramatically decreased contaminant elimination capacity upon excessive drying or decrease in pH of the biofilter packing media (Severin *et al.*, 1995; Agathos *et al.*, 1997; Auria *et al.*, 1998, 2000). Recent studies have revealed that some fungal species are not only tolerant of low moisture content and acidification of biofilter packing media, they are also able to rapidly degrade a wide range of organic chemicals commonly found in industrial waste gas emissions (Braun-Lüllemann *et al.*, 1995; Woertz *et al.*, 2001a; Christen *et al.*, 2001; García-Peña *et al.*, 2001; Qi *et al.*, 2001). To assess the merits of operating biofilters dominated by fungal populations, a series of experiments were conducted. In the first stage of research, described in Section 7.1, a screening study was conducted to assess the ability of various fungal species to degrade VOCs found in paint spray booth off gases. In the second stage of research, described in Section 7.2, a fungal biofilter was subjected to various continuous loading conditions that involved progressively higher contaminant loading rates. In the third stage of research, described in Section 7.3, a fungal biofilter was subjected to a variety of discontinuous loading conditions expected to occur in paint spray booth applications.

7.1 Initial Screening of Fungi for Their Ability to Degrade Paint VOCs

Biofilter success obviously depends on the biodegradability of contaminants present. Although many fungal species have been tested for their ability to degrade nonvolatile compounds including polynuclear aromatic hydrocarbons (PAHs) and other recalcitrant compounds (Bumpus *et al.*, 1985; Aitken and Irvine, 1990; Wariishi *et al.*, 1991; and Haught *et al.*, 1995), relatively few accounts of fungal degradation of VOCs appear in the literature. As the initial step in testing a fungal-based biofilter system, five fungal species were screened to test their ability to degrade a variety of VOC contaminants. Fungal cultures inoculated on ceramic support media were provided VOCs via the vapor phase as their sole carbon and energy sources. Compounds tested included aromatic hydrocarbons (benzene, ethylbenzene, toluene, and styrene), ketones (methyl ethyl ketone, methyl isobutyl ketone, and methyl propyl ketone), and others (*n*-butyl acetate, ethyl 3-ethoxypropionate). Experiments were conducted using three pH values ranging from 3.5 to 6.5. Fungal ability to degrade each VOC was determined by observing presence or absence of visible growth on the ceramic support media during a 30-day test period.

7.1.1 Methods

Fungal species, *Cladosporium resinae* (ATCC 34066), *Cladosporium sphaerospermum* (ATCC 200384), *Exophiala lecanii-corni* (CBS 102400), *Mucor rouxii* (ATCC 44260), and *Phanerochaete chrysosporium* (white rot fungus) (ATCC 24725), were streaked in pure culture on agar petri plates (10 g/L malt extract, 5 g/L yeast extract, and 15 g/L agar). Media and laboratory instruments contacting the fungi were sterilized by autoclaving at 120 °C and 15 psi for 30 minutes, and aseptic technique were employed throughout the studies.

The agar petri dishes were incubated at 30 ± 1 °C for seven days, at which time appreciable growth was observed in all cultures. Then, 5.0 mL of a sterile nutrient solution prepared by adding the following constituents to deionized water was added to each dish grown with fungi: NH_4NO_3 1.25 g/L, KH_2PO_4 1.0 g/L, $\text{MgSO}_4 \cdot 7\text{H}_2\text{O}$ 0.5 g/L, $\text{CaCl}_2 \cdot 2\text{H}_2\text{O}$ 0.02 g/L, $\text{CuCl}_2 \cdot 2\text{H}_2\text{O}$ 0.17 mg/L, $\text{CoCl}_2 \cdot 6\text{H}_2\text{O}$ 0.24 mg/L, $\text{ZnSO}_4 \cdot 7\text{H}_2\text{O}$ 0.58 mg/L, $\text{MnSO}_4 \cdot \text{H}_2\text{O}$ 1.01 mg/L, $\text{Na}_2\text{MoO}_4 \cdot 2\text{H}_2\text{O}$ 0.24 mg/L, $\text{NiCl}_2 \cdot 6\text{H}_2\text{O}$ 0.10 mg/L, $\text{FeSO}_4 \cdot 7\text{H}_2\text{O}$ 1.36 mg/L, and streptomycin sulfate 4.5 mg/L. The agar surface of each dish was gently scraped using a sterile loop, and the dishes were shaken for 30 sec. The resulting fungal suspension was removed from each agar petri dish and transferred into a centrifuge tube containing 10 mL of fresh nutrient solution. The centrifuge tubes were then vortexed for 2 min before being centrifuged for 2 min at 3000 g. The supernatant was decanted, 10 mL of fresh nutrient solution was added, and the rinse was repeated twice. Finally, the fungi were resuspended in 30 mL of fresh nutrient medium.

One milliliter of the fungal suspension was transferred to a glass petri dish (1.5 cm x 10.0 cm) containing five ceramic pellets (R-635 Celite®, Lompoc, California) that were previously heated to 550°C in a muffle furnace to remove organic contaminants. Five mL of nutrient solution prepared as described above but subsequently adjusted to an initial pH value of 3, 5, or 7 (using 10% NaOH (w/v) or 1.0 M HCl) prior to autoclaving was also added to each petri dish. After inoculation, the petri dishes were gently shaken to distribute the fungal suspension over the surface of all pellets. Three short segments of sterile Teflon™ tubing (approximately 0.5 cm in length) cut lengthwise were fixed around the edge of each petri dish to support the dish cover and provide a gap of approximately 1 mm for diffusion of VOCs.

Dishes inoculated with fungi were then placed in an airtight glass desiccator that had been sanitized by surface treatment with an ethanol solution (75% ethanol and 25% sterile deionized water (v/v)) and allowed to air dry in a laminar flow hood supplied with HEPA-filtered air. The glass desiccators contained two additional uncovered glass petri dishes below the ceramic support plate. One dish contained a 0.85% (w/v) sterile NaCl solution to control relative humidity, and the other dish was used as a surface to evaporate VOC. To add the VOC to the gas headspace inside the desiccator, 100 µL of VOC (neat) was added to the evaporation dish prior to sealing. The desiccators were then incubated at ambient laboratory temperature (23 ± 2 °C). Each desiccator was unsealed, and 100 µL of VOC was added every two days for the remainder of the experiment. Each VOC was tested separately. The VOCs tested included methyl ethyl ketone, toluene (99.9%, Fisher Scientific, Fair Lawn, N.J.), ethyl 3-ethoxypropionate, *n*-butyl acetate, methyl isobutyl ketone (4-methyl-2-pentanone), methyl propyl ketone (2-pentanone), *p*-xylene, benzene, styrene (99%, Aldrich Chemical Co. Inc., Milwaukee, Wisconsin), and ethylbenzene (Sigma Chemical Co., St. Louis, Missouri).

Each of the five fungal species was tested with each VOC at three different pH values. Because the inoculation procedure involved addition of 1.0 mL of fungal suspension (pH 5.0) to 5.0 mL of nutrient solution adjusted to pH 3.0, 5.0, or 7.0, the pH after inoculation was approximately 3.5, 5.0, or 6.5, respectively. Each treatment was repeated in triplicate. Thus, a total of nine dishes were used for each VOC and fungal species combination tested. Time was measured in days from the time inoculated plates were placed in the glass desiccator.

Additionally, two controls without VOC addition were adopted for each pH and fungus combination tested. The first control (arbitrarily named Control 1) consisted of replicate dishes

that were prepared and incubated in a desiccator exactly as described above except that no carbon source (VOC) was added to the desiccator. This was used to determine if the fungi grew in the absence of VOC constituents (e.g., by utilizing endogenous carbon reserves, degrading streptomycin, etc.). The second control (arbitrarily named Control 2) consisted of replicate dishes that were prepared and incubated in a desiccator exactly as described above except that 1.0 mL of nutrient medium containing 5.0 g/L glucose was added to each dish prior to incubation. This was used to confirm that a viable culture was used in the inoculation.

At two-day intervals, the petri dishes were examined for visible growth of fungi. When heavy visible growth was readily apparent, incubation was stopped and the cultures were recorded as being capable of utilizing the compound as the sole carbon and energy source under the conditions tested. In the cases where no visible growth was observed, experiments were continued for a minimum of 30 days. When no visible growth was observed even after 30 days of incubation, the culture was recorded as not being capable of utilizing the compound as the sole carbon and energy source under the conditions tested. Because the experimental conditions imposed on the fungal cultures in this study match the conditions expected in a biofilter application (e.g., static, attached-growth conditions and supply of both ammonia and nitrate nitrogen), this technique may prove valuable for rapidly determining whether particular fungal species can degrade VOCs under conditions expected to exist in biofilter applications. It should be noted, however, that the method described herein does not assess whether the VOCs were mineralized or whether they were biotransformed into intermediate metabolites that were not fully mineralized by the pure cultures. Further study is necessary to unequivocally reach such conclusions.

7.1.2 Results

For all of the fungal species tested, no visible growth was observed in any of the Control 1 petri dishes, to which no glucose or VOC was added. On the other hand, visible growth was observed in all of the Control 2 petri dishes, to which glucose but no VOC was supplied. These results indicate that a viable fungal culture was inoculated into each of the treatments and that the inoculated culture was not capable of producing visible growth in the absence of VOC. Thus, any visible growth observed on petri dishes where fungal inocula were supplied with VOC was taken to be a direct indication of growth on that VOC as a sole carbon and energy source.

A summary of fungal ability to utilize the VOCs under the conditions tested in this study appears in Table 7-1. Results indicate that the fungi *Exophiala lecanii-corni* and *Cladosporium sphaerospermum* can effectively utilize all ten compounds tested. This suggests that *Exophiala lecanii-corni* and *Cladosporium sphaerospermum* are promising candidates for use in fungal-based biofilters to treat gas streams contaminated by a wide range of VOCs. *Phanerochaete chrysosporium* was able to degrade all VOCs tested except for styrene under the conditions imposed. *Cladosporium resinae* was able to degrade both organic acids, all of the ketones, and some of the aromatic compounds (ethylbenzene and toluene); however, it was not able to grow utilizing benzene or styrene under the conditions tested. With the VOCs tested, *Mucor rouxii* produced visible growth only when supplied with *n*-butyl acetate or ethyl 3-ethoxypropionate. Maximum growth for most fungi was observed at a pH of approximately 5.0.

TABLE 7-1. SUMMARY OF GROWTH OBSERVATIONS FOR FUNGI GROWING ON VOCs (TAKEN FROM Qi *et al.*, 2002).

	<i>Cladosporium resinae</i>	<i>Cladosporium sphaerospermum</i>	<i>Exophiala lecanii-corni</i>	<i>Mucor rouxii</i>	<i>Phanerochaete chrysosporium</i>
No carbon source	–	–	–	–	–
Glucose	+	+	+	+	+
Ethyl 3-ethoxypropionate	+	+	+	+	+
<i>n</i> -Butyl acetate	+	+	+	+	+
Methyl ethyl ketone	+	+	+	–	+
Methyl propyl ketone	+	+	+	–	+
Methyl isobutyl ketone	+	+	+	–	+
Benzene	–	+	+	–	+
Toluene	+	+	+	–	+
Ethylbenzene	+	+	+	–	+
Styrene	–	+	+	–	–
<i>p</i> -Xylene	–	+	+	–	–

Resulting Publications

- Qi, B.; Moe, W.M.; and Kinney, K.A., (2002) Biodegradation of Volatile Organic Compounds by Five Fungal Species, *Applied Microbiology and Biotechnology*, **58**(5), 684–689.

7.2 Evaluation of a Fungal Biofilter During Continuous Loading

Based on results from the fungal screening study reported in Section 7.1, *Cladosporium sphaerospermum* and *Exophiala lecanii-corni* were identified as particularly promising species for use in biofilters treating paint VOCs. Because further studies to evaluate biofilters containing *Exophiala lecanii-corni* were already underway, a decision was made to conduct column reactor experiments to assess the ability of *Cladosporium sphaerospermum* to treat a mixture of gas-phase contaminants representative of those found in paint spray booth off-gases. In these studies, a biofilter inoculated with the fungus *Cladosporium sphaerospermum* was operated over a period lasting more than 250 days. During the first 180 days of biofilter operation, the biofilter was subjected to various continuous loading conditions that involved progressively higher contaminant loading rates. During the remainder of the experiment, the biofilter was subjected to a variety of discontinuous loading conditions (see Section 7.3 for a description of discontinuous loading experiments).

7.2.1 Methods

Experiments employed a multi-section glass biofilter column as shown in Figure 7-1. The biofilter consisted of five sections each with an inner diameter of 9.9 cm and a height of 25 cm plus a top and bottom. Each column section was filled with 25 cm of packing medium providing a total bed depth of 125 cm and a total packed-bed volume of approximately 9.6 L. Perforated stainless steel support plates placed between each section supported the packing medium. Septum-filled monitoring ports allowed collection of gas samples at various spatial locations. Glass marbles were placed in the bottom of the column to evenly distribute airflow. Liquid

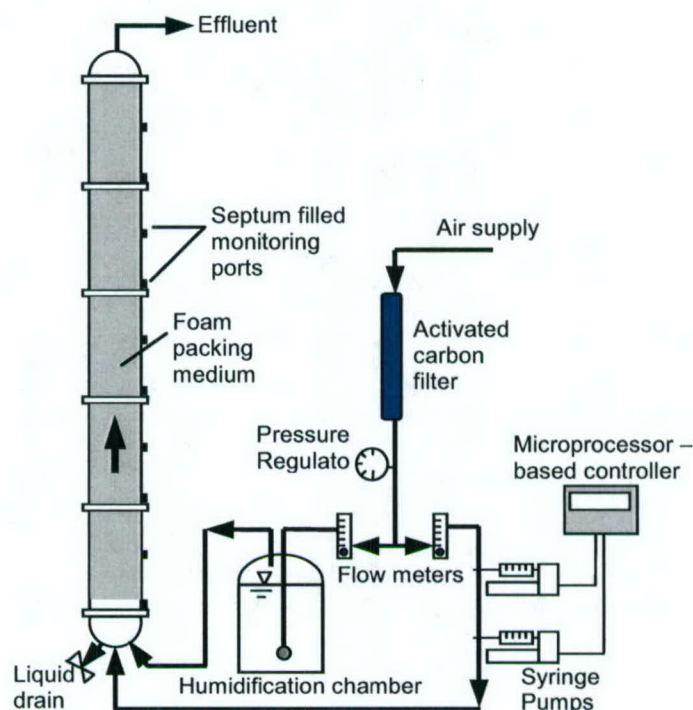

Figure 7-1. Schematic Diagram of Laboratory Biofilter Apparatus. (Taken from Moe and Qi, 2004).

Packing medium for the column consisted of reticulated polyurethane foam cubes approximately 1.25 cm per side. Each of the biofilter column's five sections contained approximately 75 g of foam medium (dry mass basis), and the resulting porosity of the wet medium in the column was approximately 0.95 at start-up.

Approximately 95% of the influent air stream passed through an aeration stone submerged in a 20-L glass carboy filled with deionized water and heated with electrical heating tape. The remaining 5% of airflow was directed through a separate rotameter to control the flow rate to two injection ports for VOC volatilization. VOC volatilization into the influent air was accomplished using two syringe pumps in conjunction with glass gas-tight syringes. Methyl propyl ketone and methyl ethyl ketone were combined in one syringe, and toluene and *n*-butyl acetate were combined in another. Small pieces of glass wool placed inside the injection ports facilitated rapid volatilization of the test contaminants. To minimize contaminant sorption to the experimental

apparatus, all surfaces contacting the VOC contaminated air stream were made of glass, Teflon™, or Viton™.

Following inoculation with a pure culture of *Cladosporium sphaerospermum*, the biofilter was supplied with a VOC mixture comprising *n*-butyl acetate, methyl propyl ketone, methyl ethyl ketone, and toluene at target concentrations of 124 mg·m⁻³ (26.3 parts per million by volume (ppm_v)), 174 mg·m⁻³ (49.6 ppm_v), 50.5 mg·m⁻³ (17.2 ppm_v), and 44.6 mg·m⁻³ (11.9 ppm_v), respectively. Thus, the total target VOC concentration was 393 mg·m⁻³ (105 ppm_v). Five distinct periods of biofilter operation (identified as periods S, I, II, III, and IV) as summarized in Table 7-2 were studied. Time was recorded in days from the start of contaminant addition. Period S comprised a 51-day start-up period during which the empty-bed residence time (EBRT) was 2.0 min and inlet relative humidity was 45%. From day 52 to 74 (Period I), relative humidity was increased to near 100% by increasing the proportion of gas flow passing through the humidification system to 95%, but the EBRT remained at 2.0 min and the contaminant loading rate remained unchanged. From day 75 to day 92 (Period II), the EBRT was reduced to 1.0 min (the gas flow rate was doubled), and the contaminant loading rate was increased proportionally to maintain the same influent contaminant concentration (*i.e.*, the contaminant loading rate also doubled). From day 93 to day 152 (Period III), the EBRT was reduced to 30 sec, and the contaminant loading rate was increased proportionally to maintain the same influent contaminant concentration. From day 153 to day 180 (Period IV), the EBRT was reduced to 15 sec and the contaminant loading rate was again increased proportionally to maintain the same influent contaminant concentration. During Periods I to IV, the influent gas flow was maintained near 100% relative humidity.

TABLE 7-2. BIOFILTER TARGET LOADING DURING CONTINUOUS-LOADING CONDITIONS.

Parameter	Startup	Phase I	Phase II	Phase III	Phase IV
Days of operation	0-51	52-74	75-92	93-152	153-180
Empty-bed Residence Time (min)	2	2	1	0.5	0.25
Relative humidity (%)	45	100	100	100	100
Methyl ethyl ketone loading rate (g·m ⁻³ ·h ⁻¹)	1.5	1.5	3.0	6.0	12.0
Methyl propyl ketone loading rate (g·m ⁻³ ·h ⁻¹)	5.2	5.2	10.5	20.9	41.8
Toluene loading rate (g·m ⁻³ ·h ⁻¹)	1.3	1.3	2.7	5.4	10.7
<i>n</i> -Butyl acetate loading rate (g·m ⁻³ ·h ⁻¹)	3.7	3.7	7.5	14.9	29.8
Total VOC loading rate (g·m ⁻³ ·h ⁻¹)	11.7	11.7	23.7	47.2	94.3

During Phases I, II, III, and IV of operation, nutrients were added to the biofilter approximately once per week by filling the column with 10 L of nutrient solution and draining by gravity. During the start-up period (Period S), the nutrient addition procedure was conducted on days 8, 16, 21, 29, and 43. The nutrient solution contained the same constituents as the nutrient solution used to initially grow the fungal inoculum except for glucose, which was not added. The concentration of streptomycin sulfate remained the same as the previous solution (4.5 mg·L⁻¹), but the concentration of all other constituents was increased to five times that of the previous solution. Although nutrient addition to full-scale biofilters containing inert packing medium is normally accomplished by spraying nutrient solutions over the medium and allowing it to trickle

through the packed bed, a fill-and-drain method similar to that described here has proven convenient and adequate for avoiding nutrient limitations in laboratory-scale systems (Woertz *et al.*, 2002; Moe and Li, 2004).

Gas samples were collected from monitoring ports using glass, gas-tight syringes equipped with Luer-Lok™ valves. VOC concentrations were then measured using a Hewlett–Packard 6890 series gas chromatograph equipped with a DB-624 Special Analysis Column and flame ionization detector (FID). Calibration was performed using certified gas standards (BOC Gases, Port Allen, Louisiana). On-line measurement of CO₂ concentrations was achieved by passing a portion of the influent or effluent gas stream through a model 130 Genie membrane filter (A+ Corporation, Prairieville, Louisiana) to remove excess moisture prior to analysis by a California Analytical Instruments (Orange, California) model 1312 photoacoustic multigas monitor. The instrument was calibrated using various certified CO₂ calibration gas standards (BOC Gases, Port Allen, Louisiana). Data reported are the average of concentrations measured at approximately 50-sec intervals over 15-min time periods.

7.2.2 Results

After 10 hours of operation following initial startup of the biofilter (when the earliest samples were collected), 98%, 100%, 92%, and 3% of the influent methyl ethyl ketone, methyl propyl ketone, *n*-butyl acetate, and toluene were removed, respectively. This corresponds to an overall removal efficiency of 86% on a mass basis. Abiotic sorption studies conducted in the biofilter column packed with wet polyurethane foam packing medium but without inoculation with biomass revealed that complete contaminant breakthrough would have occurred within one hour in the absence of biological activity. Following the initial period of relatively high contaminant removal observed on the first day of operation, treatment performance subsequently declined reaching 25% removal efficiency by day 6. Following nutrient addition procedures on day 8, performance improved with overall removal efficiency initially increasing to 39%; however, performance subsequently decreased again. As shown in Figure 7-2, this same general pattern of improved performance immediately following nutrient addition followed by diminished treatment performance was observed throughout the startup period during which the influent relative humidity was approximately 45%. A visual inspection of the column revealed that the packing media wetted during the nutrient addition procedure underwent substantial drying during the interval between nutrient additions. Drying of the packing medium was closely correlated with diminished treatment performance.

Removal efficiency for each of the four constituents of the VOC mixture is depicted in Figures 7-3 (a–d). As shown in the figures, the removal efficiency for *n*-butyl acetate was somewhat higher than for the other compounds during the initial period of operation.

On day 52, the start of Period I, a nutrient addition was performed and the proportion of air passing through the humidification system was increased to provide near 100% relative humidity in the influent air prior to its entering the biofilter; however, the total air flow entering the biofilter remained constant as did the VOC loading rate. Approximately four hours after the column began operation under the new humidification condition (when the earliest samples were collected), 100%, 98%, 100%, and 67% of the influent methyl ethyl ketone, methyl propyl ketone, *n*-butyl acetate, and toluene, were removed, respectively.

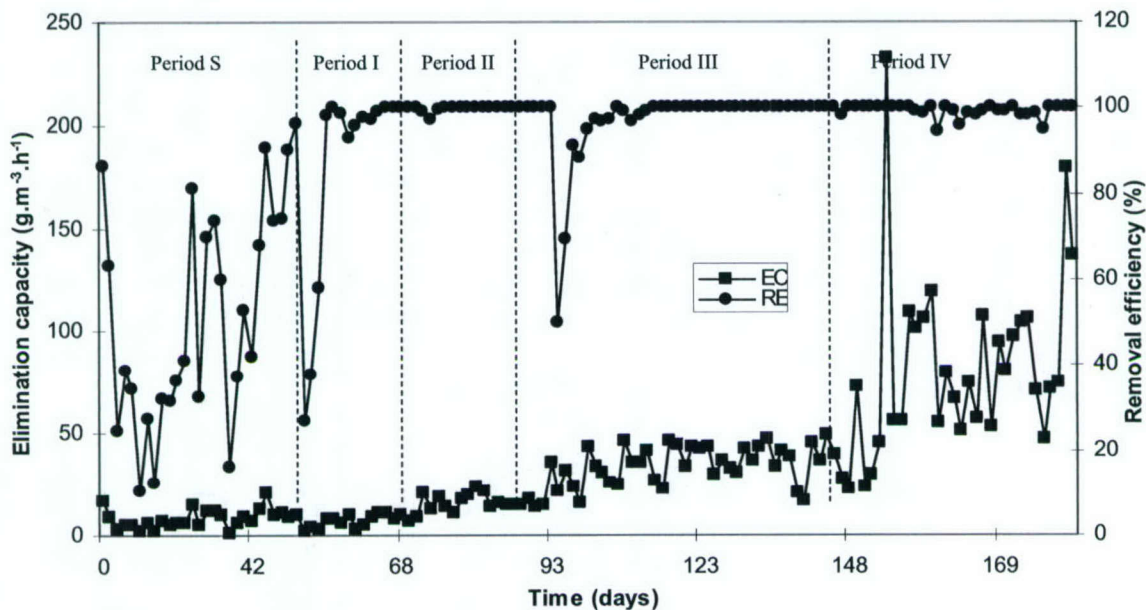

Figure 7-2. Overall VOC Elimination Capacity (*EC*) and Removal Efficiency (*RE*) during Period S (Days 0–51), Period I (Days 52–74), Period II (Days 75–92), Period III (Days 93–152), and Period IV (Days 153–158). (Taken from Qi *et al.*, 2004).

Aside from a temporary decrease in treatment performance observed from days 54 to 56, the removal efficiency for methyl ethyl ketone, methyl propyl ketone, and *n*-butyl acetate was consistently high, averaging greater than 99% removal. The percentage of toluene removed in the biofilter also increased, but at a less rapid rate. Average removal eventually increased to greater than 99% by day 66, fourteen days after the relative humidity of the influent gas stream was increased to near saturation. The biofilter's overall VOC removal efficiency increased to over 98% on day 57 and remained stable with an average removal efficiency greater than 98% from day 58 to day 74 (the remainder of Period I). Because toluene comprised only about 11% of the mass of the VOCs entering the biofilter, high overall VOC removal efficiency (*e.g.*, greater than 98%) was possible even when toluene removal was somewhat lower (*e.g.*, 80%).

Although it has been demonstrated that fungi are generally more tolerant of dry condition than bacteria (Cox *et al.*, 1996), the dramatic increase in biofilter performance following the increase in relative humidity of the influent gas stream indicates that the system's capacity for degrading the influent VOCs was limited by lack of moisture. Because the salinity of the aqueous phase also increased as water evaporated from the system during the time interval between nutrient additions during the 51-day start-up period (*i.e.*, the mass of solutes remained the same while the volume of water decreased), it is possible that high salinity rather than lack of adequate moisture was the more direct cause of diminished performance. In either case, it is clear from these data that moisture control is critical for maintaining high contaminant removal rates in fungal biofilters supplied with concentrated nutrient solutions. Previous recommendations that inlet gas streams should contain near 100% relative humidity to maintain media moisture content in biofilters (Corsi *et al.*, 1995; Gostomski *et al.*, 1997; Deviny *et al.*, 1999) apparently apply to

those containing fungi. Although a regular nutrient addition into the biofilter increased the moisture in the biofilter temporarily, this apparently did not supply enough water activity to maintain consistently high removal efficiency.

On day 75, at the beginning of Period II, the gas flow rate entering the biofilter was increased by a factor of two. The EBRT was reduced to 60 sec while the target influent VOC concentrations remained unchanged. Thus, the organic loading rate to the biofilter increased by a factor of two. The biofilter quickly adapted to the new condition. As shown in Figure 7-3, one day following the increase in loading rate, 76% of the influent toluene was removed, and the removal of the other three constituents was greater than 99%. The toluene removal increased to 96% the following day and was greater than 99% for the remainder of Phase II. In terms of overall VOC removal efficiency, as shown in Figure 7-2, the biofilter removed 97% of the influent contaminant loading one day following the increase in loading rate and removed greater than 99% of the contaminant loading during the remainder of Period II.

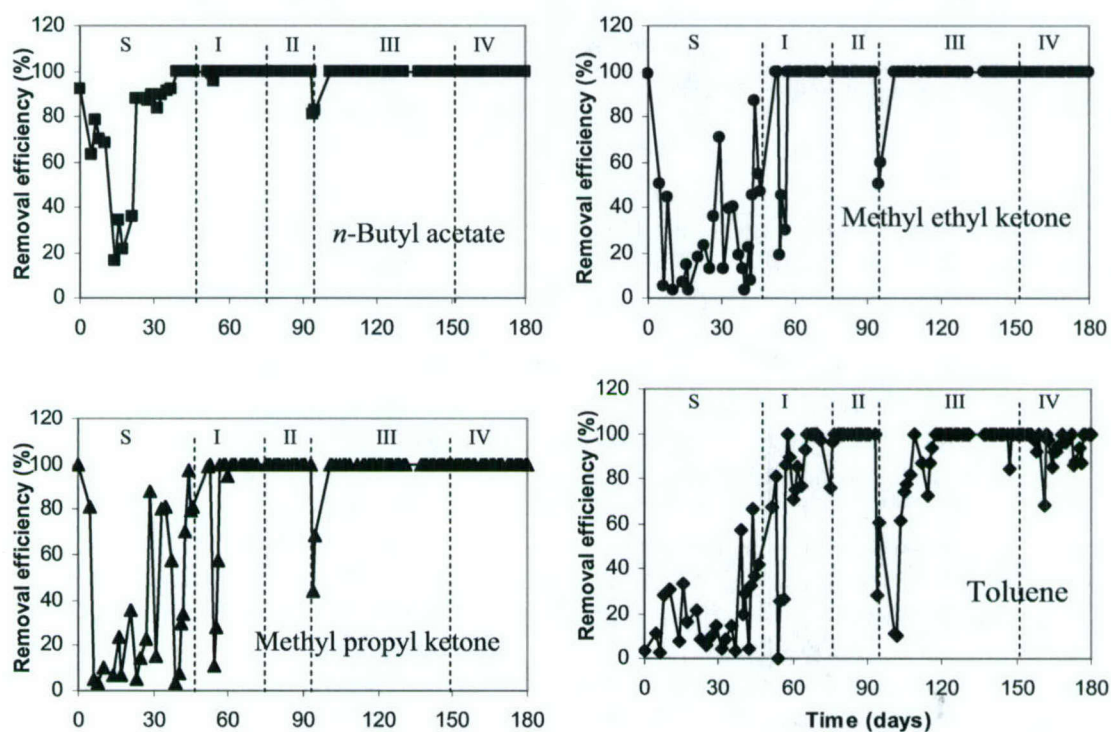

Figure 7-3. Removal Efficiencies for Individual Compounds during Period S, I, II, III, IV. (Taken from Qi *et al.*, 2004).

The contaminant removal profiles along the height of the biofilter bed (see Figure 7-4) are consistent with those reported by other researchers for laboratory-scale biofilters and biotrickling filters treating simulated paint spray booth waste gas streams. For example, Kazenski and Kinney (2000), Park *et al.* (2002) and Song *et al.* (2002) all reported that ethyl 3-ethoxypropionate was most quickly degraded followed by *n*-butyl acetate, then methyl *n*-propyl ketone in laboratory-scale bioreactors treating simulated paint spray booth off-gases. In their

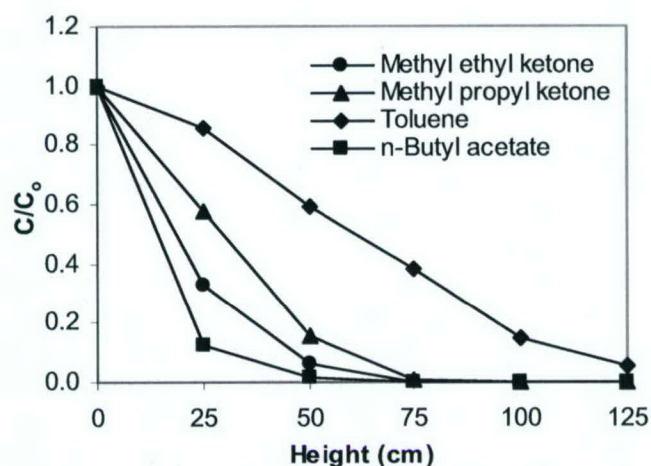

Figure 7-4. VOC Removal Profiles along the Biofilter Height during Period IV Experiments (EBRT of 15 Seconds). (Taken from Qi *et al.*, 2004).

studies, toluene removal generally did not occur until after the other components reached relatively low concentrations. Similar results were reported by Webster *et al.* (1998) for bench-scale and pilot-scale biotrickling filters treating a mixture of toluene, xylene, methyl ethyl ketone, and *n*-butyl acetate. A mass transfer limitation brought about because of the high Henry's Law constant and low solubility of toluene (in contrast to that of ketones and esters) has been hypothesized as reason for its low removal rate near the inlet of biofilters treating VOC mixtures; however, experiments demonstrating that toluene can be rapidly removed when other constituents (*e.g.*, ethyl acetate or ketones) are absent (Deshusses *et al.*, 1999; Park *et al.*, 2002; Song *et al.*, 2002) suggest that substrate inhibition or catabolic repression likely occurs in systems treating mixtures of ketones or esters and toluene. The data from the study described herein suggest that such effects apparently occur in systems dominated with fungi as well.

Most biofilters reported in the literature for treatment of paint VOCs, presumably containing primarily bacteria rather than fungi because of their inoculum source and neutral *pH*, have operated at EBRTs ranging from 40 sec to 2 min with loading rates in the range of 6–40 $\text{g}\cdot\text{m}^{-3}\cdot\text{h}^{-1}$ (Kazenski and Kinney, 2000; Webster *et al.*, 1998; Park *et al.*, 2002; Song *et al.*, 2002). The fungal biofilter in this study exhibited stable long-term performance with high VOC removal efficiency (> 99%) at very low EBRTs (15 sec) and high loading rates (92 $\text{g}\cdot\text{m}^{-3}\cdot\text{h}^{-1}$). The results indicate that fungal biofilters are a feasible alternative for treating paint spray booth off-gases, and that such systems may offer the advantage of higher degradation rates than bacterial systems. This is consistent with previous reports that fungi are capable of high degradation rates when supplied with single-component VOC waste gas streams (Woertz *et al.*, 2001).

Although the column was initially inoculated with only *Cladosporium sphaerospermum*, several additional species of airborne fungi were found growing attached to the packing medium by the end of experiment. On the basis of partial 28S rRNA gene sequences of fungi isolated as described in Qi *et al.* (2004), the additional fungal species were tentatively identified as *Penicillium brevicompactum*, *Exophiala jenselmei*, *Fusarium oxysporum*, *Fusarium nygamai*, *Talaromyces flavus*, and *Fonsecaea pedrosi*. These additional fungal species presumably entered the biofilter via the air introduced into the system on a continuous basis or via the

nutrient solution that was added approximately once per week. Because fungal spores from several of these species are commonly found in both indoor and outdoor air, introduction of fungal species via the influent air would not be surprising. Evidence of fungal species being introduced into biofilters through airborne sources is also supported by previously reported biofilter experiments. These results indicate that it would be difficult and likely unnecessary to maintain specific species in full-scale fungal biofilters treating paint spray booth emissions.

Overall, results demonstrate that fungal biofilters can be successfully employed to biodegrade mixtures of *n*-butyl acetate, methyl ethyl ketone, methyl propyl ketone, and toluene from waste gas streams representative of paint spray booth off-gases. When the influent gas stream was properly humidified, the system exhibited stable long-term performance with an average total VOC removal greater than 98% even when operated with an EBRT as low as 15 seconds and a loading rate of $92 \text{ g}\cdot\text{m}^{-3}\cdot\text{h}^{-1}$. When the influent gas stream contained relatively low moisture content (*e.g.*, 45% relative humidity), lower treatment performance was observed. The pattern of VOC removal in the fungal biofilter was similar to that previously observed for bacterial systems. VOC concentration profiles measured along the height of the biofilter revealed that *n*-butyl acetate was most readily degraded, followed by methyl ethyl ketone, methyl propyl ketone, and then toluene.

Results also indicate that it would be difficult and perhaps unnecessary to maintain pure cultures or defined mixed cultures in full-scale fungal biofilters treating paint spray booth emissions. Although the column was initially inoculated with only *Cladosporium sphaerospermum* several additional species of airborne fungi including *Penicillium brevicompactum*, *Exophiala jenselmei*, *Fusarium oxysporum*, *Fusarium nygamai*, *Talaromyces flavus*, and *Fonsecaea pedrosi* were found growing attached to the packing medium by the end of experiment. Growth of diverse fungal species may help to develop a stable and efficient microbial population capable of achieving high VOC removal rates in biofilters.

Resulting Publications

- Qi, B.; Moe, W.M.; and Kinney, K.A. (2004) "Treatment of Paint Spray Booth Off-Gases in a Fungal Biofilter," *Journal of Environmental Engineering*, ASCE, **131**(2): 180–189.

7.3 Evaluation of a Fungal Biofilter During Intermittent Loading

Biological treatment processes used to remove and degrade VOC emissions from painting operations are almost always subjected to transient loading conditions because of the inherently unsteady-state nature of contaminant-generating processes. Following the steady-loading experiments summarized in section 7.2 (and described in detail in Qi *et al.*, 2004), the previously described fungal biofilter was used to study the transient response to various periods of no contaminant loading. The biofilter, operated with an empty-bed residence time of 15 seconds, was supplied with a four-component mixture of *n*-butyl acetate, methyl ethyl ketone, methyl propyl ketone, and toluene at target influent concentrations of $124 \text{ mg}/\text{m}^3$, $50.5 \text{ mg}/\text{m}^3$, $174 \text{ mg}/\text{m}^3$, and $44.6 \text{ mg}/\text{m}^3$, respectively. This corresponds to a total VOC loading rate of $94.3 \text{ g}/(\text{m}^3\cdot\text{h})$. Biofilter performance was evaluated over a 94-day period for three loading conditions

intended to simulate processes generating contaminated gases only during daytime operation, daytime operation with weekend shutdown periods, and with long-term (9-day) shutdown. Results indicate that fungal biofilters can be an effective alternative to conventional abatement technologies for treating solvent contaminated off-gases even under discontinuous loading conditions.

7.3.1 Methods

Following steady-loading experiments summarized in section 7.2 (and described in detail in Qi *et al.*, 2004), in the studies described herein, the biofilter was subjected to three different loading conditions during which the influent VOC supply was intermittently turned off and on to assess transient responses of the fungal biofilter following periods of no loading. During all three loading conditions, the biofilter was maintained at an EBRT of 15 sec and influent VOC target concentrations identical to those described in section 7.2. Thus, the target VOC loading rate was 41.8 g/(m³·h) methyl propyl ketone, 29.8 g/(m³·h) *n*-butyl acetate, 10.7 g/(m³·h) toluene, and 12.0 g/(m³·h) methyl ethyl ketone (a total of 94.3 g/(m³·h) accounting for all VOCs). Time was measured in days from the start of intermittent loading.

During the first loading condition tested (arbitrarily named Period 1), as summarized in Table 7-3, the system was operated for 24 days with contaminant loading 8 hours per day, 7 days per week, to simulate diurnal loading conditions expected where VOC contaminated off-gases are generated during only a portion of each day. During time intervals when no VOCs were added, the biofilter continued to receive humidified air at the same flow rate as it did during periods in which VOCs were supplied.

TABLE 7-3. BIOFILTER TARGET LOADING FOR INTERMITTENT LOADING STUDIES

	Period 1.	Period 2.	Period 3.
Purpose	Assess system performance when subjected to daytime operation	Assess system performance when subjected to daytime operation combined with weekend shut-down	Assess system performance when subjected to daytime operation combined with long-term (9 days) shut-down
Days of operation	0–24	25–65	66–94
VOC loading schedule	7 days per week: 8 hr/day on 16 hr/day off	5 days per week: 8 hr/day on 16hr/day off 2 days per week: 24 hr/day off	5 days: 8 hr/day on 16hr/day off 9 days: 24 hr/day off 5 days: 8 hr/day on 16hr/day off

During the second loading condition (Period 2), the system was operated with contaminant loading 8 hours per day, 5 days per week, to simulate loading conditions where off-gases are generated during only a portion of each day and no contaminants are generated during weekend shutdown periods. The weekend shutdown consisted of a period of 64 hours of no VOC loading

once per week. The biofilter was subjected to this daytime operation with weekend shutdown loading condition for a total of 21 days (three weekend shut-down periods).

The third loading condition (Period 3) simulated loading following extended shutdown for re-tooling or other long-term process interruption. The biofilter was operated as in Period 2 (loading for 8 hours per day for 5 days) for one week, and then the VOC flow was terminated for 9 days before the loading restarted for another 5 days of daytime operation. This loading period was carried out over the course of 28 days (two long-term shutdown tests).

During all three periods described above, nutrients were added to the biofilter column once per week by filling the column with 10 L of low-*pH* (*pH* 5.0) nutrient solution amended with streptomycin sulfate (to minimize bacterial growth) as described by Qi *et al.* (2003) and draining by gravity. Although nutrient addition to full-scale biofilters containing inert packing medium is normally accomplished by spraying nutrient solutions over the medium and allowing it to trickle through the packed bed, this fill-and-drain method has proven convenient and adequate for avoiding nutrient limitations in laboratory-scale systems (Woertz *et al.*, 2002; Moe and Li, 2003).

7.3.2 Results

During Period 1 (days 0–24), the biofilter received contaminant loading for a period of 8 hours per day, 7 days per week. Typical influent VOC concentrations during the 8-hour period of VOC loading during this “daytime operation” are depicted in Figure 7-5. Time 0 in the figure denotes the start of the 8-hour loading period.

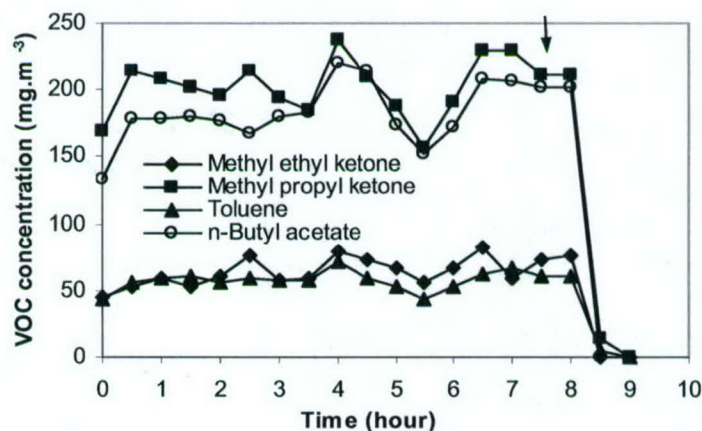

Figure 7-5. Typical VOC Concentrations in the Biofilter Influent during an 8-hr VOC Loading Period of “Daytime Operation”. Time 0 Corresponds to Start of the 8-hr VOC Loading Period. The Arrow Denotes the End of the 8-hr Loading Cycle. (Taken from Moe and Qi, 2004).

Initial experiments in which VOCs were measured at more closely spaced intervals (data not shown) indicated that the influent VOC concentrations rapidly increased after the syringe pumps turned on, and stable influent concentrations were generally reached within 15 min. Consistent with this, as shown in the figure, the influent concentrations of the four of contaminants rapidly

increased to near the target loading concentrations within 5 min (when the first samples were collected) following the syringe pumps' being turned on at the start of the 8-hour VOC loading period. As shown in the figure, influent VOC concentrations fluctuated somewhat during the loading period but were relatively close to the target values. Immediately after the syringe pumps turned off at the end of the 8-hour loading cycle, influent VOC concentrations rapidly decreased, reaching very low concentrations after 30 min and were not detected after one hour. Thus, the experimentally observed loading conditions closely matched the target loading conditions.

As shown in the top graph of Figure 7-6, the pattern of VOC removal during the 8-hour VOC loading period began with essentially complete removal when the biofilter restarted. After 30 min of VOC loading (when the next samples were collected), approximately 20% of the influent toluene concentration was detected in the effluent. This breakthrough of toluene continued at approximately the same rate throughout the remainder of the loading period and then decreased to below the detection limit within 30 min after the loading period ended. No methyl ethyl ketone, methyl propyl ketone, or *n*-butyl acetate were detected in the effluent during or after the 8-hour loading period. No unidentified peaks (other than the four model VOCs) were detected in the GC analysis.

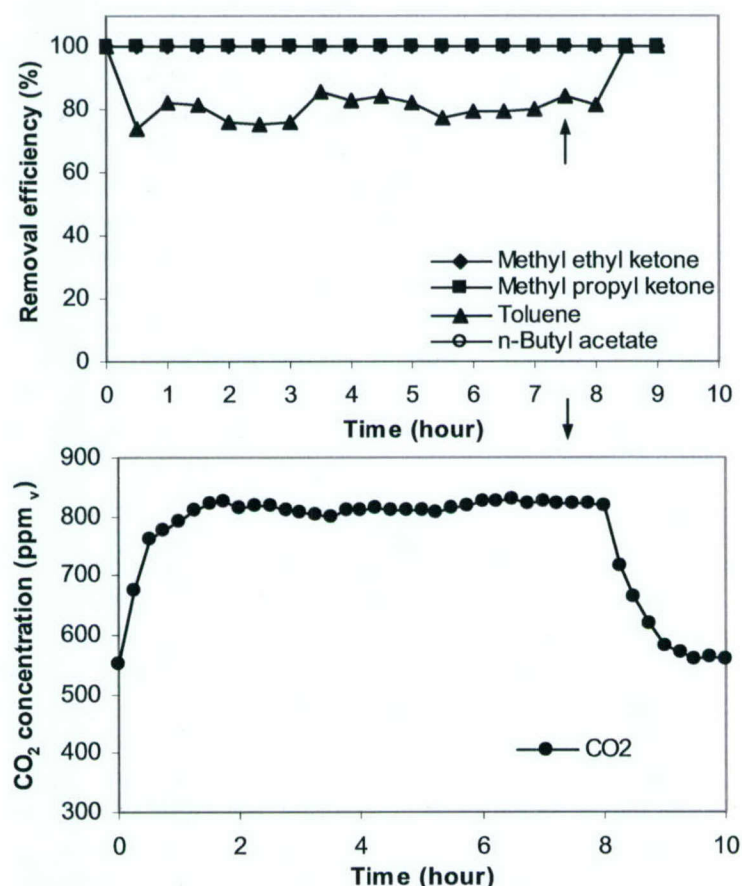

Figure 7-6. Typical Removal Efficiency for Each of the Four VOCs (Top, Data from Day 13), and Typical Effluent CO₂ Concentration (Bottom, Data from Day 15) during Period 1. Time 0 in the Graphs Corresponds to the Start of the 8-hr VOC Loading Period, and Arrows Denote the End of the 8-hr Loading Cycle. (Taken from Moe and Qi, 2004).

Effluent CO₂ concentrations during the 8-hour loading period of a typical day are shown in the bottom graph of Figure 7-7. As shown in the figure, the effluent CO₂ concentration rapidly increased from approximately 555 parts per million by volume (ppm_v) to 800 ppm_v during the first hour of VOC loading and then remained stable until VOC loading stopped. Then, the effluent CO₂ concentration rapidly decreased back to a level of approximately 560 ppm_v within 1.5 hours. Although influent CO₂ concentrations fluctuated somewhat and were not measured on a sufficiently frequent basis to allow calculation of a complete carbon balance, the pattern of CO₂ production is consistent with that expected from biodegradation and further demonstrates that the fungal population was able to rapidly recover its biodegradation capacity following the period of no VOC loading.

Overall daily VOC removal efficiency (calculated on a mass basis including all four compounds) during daytime operation (Period 1) ranged from 96% to 99% with an average of 98% on a mass basis). These data nicely demonstrate that high VOC removal efficiency can be achieved by fungal biofilters treating discontinuously generated VOC mixtures even when operated at a high loading rate and low residence time. Because toluene comprised only about 11% of the mass of VOCs entering the biofilter, high overall VOC removal efficiency (*e.g.*, 98%) was possible even when toluene removal was somewhat lower (*e.g.*, 80%).

During Period 2 (days 25–65), the biofilter received contaminant loading for a period of 8 hours per day, 5 days per week to simulate conditions expected from painting operations operating during only business hours and with weekend shutdown. Figure 7-7 shows the typical pattern of VOC removal during the 8-hour VOC loading period of the first, third, and the fifth day following resumption of contaminant loading after the weekend shut-down period. As shown in the top graph of Figure 7-7, during the first day of VOC loading following the weekend shutdown, no *n*-butyl acetate was observed in the effluent. Methyl ethyl ketone and methyl propyl ketone were both observed in the effluent from 1.0 hour after the start of contaminant loading until 2.5 hours of contaminant loading, reaching minimum removal efficiencies of 70% and 64%, respectively, before performance improved to 100% removal 2.5 hours into the loading period. Toluene removal reached a minimum of 1% two hours into the loading cycle before subsequently increasing to a stable level of approximately 55% removal for the remainder of the 8-hour loading period.

The high overall removal efficiency (approximately 99% on a mass basis accounting for all four constituents) observed immediately (5 min) after the start of VOC loading following the 2-day shutdown can be attributed in part to VOC sorption to the packing medium, biomass, and aqueous phase. The subsequent decrease to 82% removal after 30 min, however, indicates that the contaminant loading rate exceeded the rate of removal by sorption and biodegradation during this initial time interval. The pattern of a lag in contaminant breakthrough following an increase in contaminant loading rate because of sorption to packing media, biomass, and aqueous phase has been observed previously for other biofilters (Moe and Li, 2003). The subsequent increase in performance to 96% removal two hours after VOC loading started demonstrates that the microbial population was able to rapidly recover its high biodegradation rate following the 2-day period of no loading. The average daily total VOC removal observed on the first day following the weekend shutdown was 94% (average of the three replicate experiments).

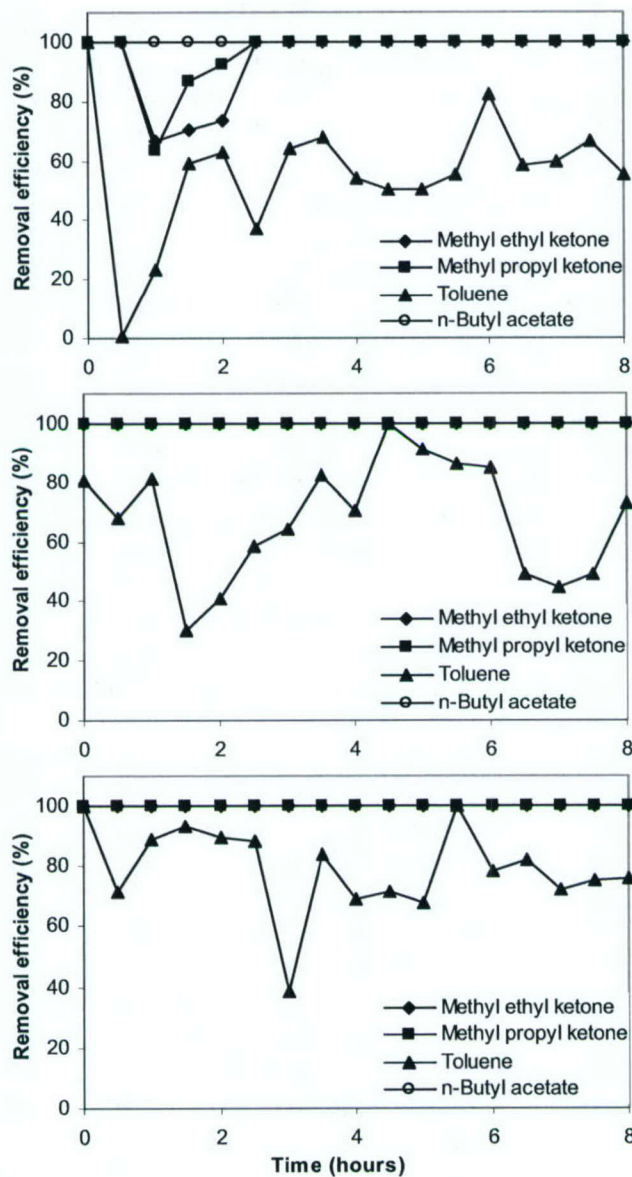

Figure 7-7. Typical VOC Removal Efficiency during the 8-hr VOC Loading Periods during a Typical Week Following a Weekend Shutdown (Period 2). The First Day after the 2-Day VOC Shutdown (Top). The Third Day after the 2-Day VOC Loading Shutdown (Middle). The Fifth Day after the 2-Day VOC Loading Shutdown (Bottom). (Taken from Moe and Qi, 2004).

In the third and fifth days following resumption of contaminant loading, as shown in Figure 7-7, VOC removal was relatively stable with complete removal of *n*-butyl acetate, methyl ethyl ketone and methyl propyl ketone. Toluene removal was more variable than the other compounds, but because it comprised only about 11% of the influent contaminant loading, variation in overall VOC removal efficiency caused by variation in toluene removal was relatively minor, less than 5%. Average toluene removal was 68% in the third day and 79% in the fifth day following the

two-day shutdown. Average total VOC removal was 97% for both the third and fifth days. Effluent CO₂ concentrations during the 8-hour loading period were similar to those observed during Period 1 with a rapid increase during the first hour of VOC loading, relatively stable concentration until VOC loading stopped, and then rapid decrease (data not shown). Overall VOC removal efficiency during weeks that included weekend shutdown (Period 2) was 96%, slightly lower than that of daytime operation without weekend shutdown (Period 1).

Results obtained from weekend shutdown experiments (Period 2) indicate that less than 2.5 hours was required before overall VOC removal efficiency returned to higher than 95% following the initial performance decline on the first day of operation following the 2-day shutdown. Although a direct comparison is difficult because of differences in contaminant types and loading rates, the rapid recovery observed in the fungal biofilter described herein compares quite favorably to previously reported results for biofilters containing bacteria or undefined mixed cultures subjected to 2-day shutdown periods. For example, one day was needed for a biotrickling filter treating styrene (Webster *et al.*, 1999), and between 10 and 24 hours was required for biofilters treating toluene (Park and Kinney, 2001; Cox *et al.*, 2002).

The overall performance decline observed during the re-acclimation period of the fungal biofilter described here was substantially smaller than that report for other biofilters described above. It is not possible from the data collected to unequivocally conclude that the predominance of fungi in this biofilter (rather than bacteria, in most previously reported biofilters) led to the system's ability to quickly return to high degradation rates following shutdown periods. It is interesting to note, however, that in the only other report of fungal biofilter performance following shutdown periods, a toluene-degrading biofilter reported by Woertz *et al.* (2001), recovery to high removal efficiency was much more rapid than for other toluene-degrading biofilters reported in the literature (Park and Kinney, 2001; Cox *et al.*, 2002).

During Period 3 (days 66–94), the biofilter was subjected to two separate shut-down periods lasting 9 days each. During the week before and after each of the long-term shutdown periods, the biofilter was operated with contaminant loading for 8 hours per day, 5 days per week. Removal efficiency for each of the four VOCs during the first day following resumption of contaminant loading after one of the 9-day shutdown periods is presented in Figure 7-8 (top) along with data from the third day (middle) and fifth day (bottom).

During the first day of VOC loading, *n*-butyl acetate was detected in the effluent, with removal as low as 64% before it recovered to 100% within 3.5 hours. Likewise, methyl ethyl ketone and methyl propyl ketone removal efficiency decreased to minimum values of 59% and 42%, respectively, and then recovered to 100% after 3.5 hours. Toluene removal was relatively stable, averaging 42% during the first day. The apparently higher toluene removal observed immediately following resumption of contaminant loading during Period 3 (in comparison to Period 2) cannot be readily explained aside from potential experimental error and the fact that the interval between sample collection may have been insufficient to detect the maximum effluent toluene concentration. Removal efficiency averaged over the duration of the loading period in the first day was 93% for *n*-butyl acetate, 92% for methyl ethyl ketone, and 89% for methyl propyl ketone. In terms of total VOC removal (considering all four VOCs), it reached a minimum of 65% two hours after the start of contaminant loading, but it recovered to 95% after

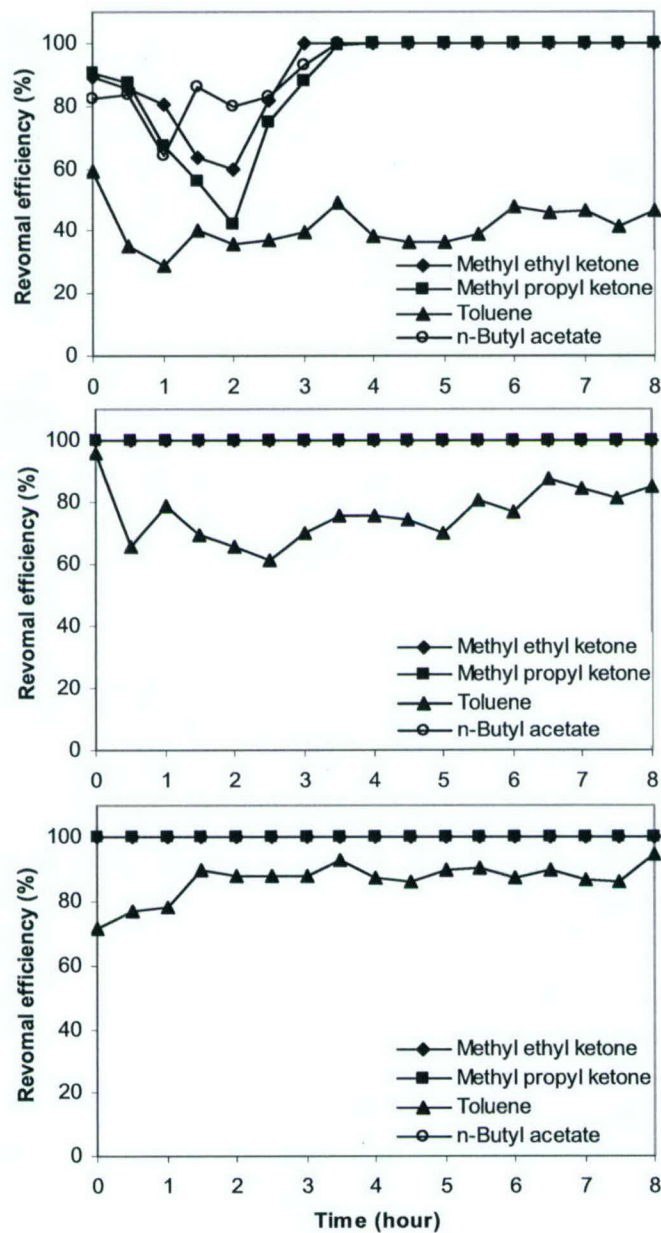

Figure 7-8. Typical VOC Removal Efficiency during the 8-hr VOC Loading Periods during a Typical Week Following a 9-Day Shutdown during Period 3. (Top) The First Day after the 9-Day VOC Shutdown. (Middle) The Third Day after the 9-Day VOC Loading Shutdown. (Bottom) The Fifth Day after the 9-Day VOC Loading Shutdown. (Taken from Moe and Qi, 2004).

only 3.5 hours. Total VOC removal averaged over the first day following resumption of contaminant loading was 80% in replicate 1 (*i.e.*, the first 9-day shut-down test) and 90% in replicate 2 (*i.e.*, the second 9-day shut-down test).

During the third and fifth days, no methyl ethyl ketone, methyl propyl ketone, or *n*-butyl acetate was detected in the biofilter effluent. Toluene removal efficiency on the third day (Figure 7-8, middle) was approximately 60% at the start of the loading period but gradually increased to approximately 80% at the end of the 8-hour loading period. In the fifth day (Figure 7-8, bottom), toluene removal was relatively stable, averaging 85%, comparable to that observed during Period 1. For the third day and the fifth days following resumption of contaminant loading, the average total VOC removal was 97% and 98%, respectively, in both replicates. Effluent CO₂ concentrations during the 8-hour loading periods were similar to those observed during Period 1 with a rapid increase during the first hour of VOC loading, relatively stable concentration until VOC loading stopped, and then rapid decrease (data not shown).

The overall total VOC removal efficiency during the week following the 9-day shutdown was 94%, slightly lower than that observed when the biofilter was subjected to daytime operation 7 days per week (Period 1) or daytime operation combined with weekend shutdown (Period 2). The rapid recovery following the 9-day shutdown periods in this study is consistent with the rapid recovery of a fungal biofilter reported by Woertz *et al.* (2001), who found that a biofilter containing the fungus *Exophiala lecanii-corni* was able to recover to 96% removal efficiency within one hour after an 8.5-day shutdown in a system treating toluene-contaminated air. Cox *et al.* (2002) reported that the reacclimation time for toluene removal using a biotrickling filter subjected to continuous loading (rather than intermittent loading as was used in the experiments described herein) after a 9-day starvation period was approximately 15 hours to recover to 60% removal and more than 30 hours to reach 70% removal (the maximum observed in their system).

From biofilter performance observed in Periods 1, 2, and 3, it can be concluded that the longer VOC loading was shut down, the larger the decline in removal efficiency following restart, and the longer the reacclimation time required to recover. Removal efficiency for *n*-butyl acetate and both ketones recovered very rapidly in all loading conditions tested—16-hour shutdown (Period 1) causing no noticeable adverse effect—and just 3.5 hours was needed for the system to return to greater than 99% removal after a 9-day shutdown (Period 3). The short reacclimation period for these compounds suggests that fungi in the system can quickly recover their metabolic and enzymatic activity following starvation periods. Even if there was a net decrease in the number of metabolically active microorganisms, the decrease was not large enough to have a noticeable long-term effect on removal of the ketones or *n*-butyl acetate.

In somewhat of a contrast to this, toluene removal was adversely impacted to a greater extent and for a longer duration by the interruption in VOC loading than were the other compounds. Toluene removal was adversely impacted for at least 3 days following both the 2-day (Period 2) and 9-day (Period 3) shutdown periods. This may have been caused by a variety of factors. Because the ketones and *n*-butyl acetate were observed in the biofilter effluent during the interval immediately following resumption of contaminant loading, they were obviously present along the entire length of the column. The fungi may have preferentially used these compounds rather than toluene because of complex inhibition and/or catabolic repression effects related to the presence of multiple constituents. Because contaminant concentration profiles were not measured along the column length during the recovery period, it is not known how far these other compounds penetrated the column other than when they were observed at the biofilter outlet during the first 3.5 hours, so more complete evaluation of potentially inhibitory effects is not possible from the data collected. Another potential explanation for the longer reacclimation

period for toluene is that there may have been a net decrease in the number of fungi capable of toluene degradation during the course of the shut-down period, and it may have taken a period of several days for them to increase in number. Regardless of the exact cause, toluene removal eventually recovered, demonstrating that the system was robust in its ability to recover following long-term periods of no VOC loading.

Resulting Publications

- Moe, W.M.; and Qi, B. (2004) "Performance of a Fungal Biofilter Treating Paint Solvent Mixtures during Intermittent Loading," *Water Research*, **38**(9), 2258–2267.

CHAPTER 8: SEQUENCING BATCH BIOFILTER (SBB) OPERATION

Emissions from most DoD painting operations are characterized by dynamically varying VOC concentrations. If not properly accounted for in design and operation of biofilters, the sometimes severe variations in VOC concentration may result in dynamic “shock” loads that exceed biological reaction capacities and result in contaminant emission from biofilter systems. Contaminant emissions during short-term unsteady-state loading conditions have been reported for a number of biofilter applications treating a wide variety of different compounds (Boyette *et al.*, 1995; Chang and Yoon, 1995; Martin and Loehr, 1996; Kinney *et al.* 1996; Mohseni *et al.*, 1998; Deshusses *et al.*, 1999; Irvine and Moe, 2001; Li and Moe, 2003). Although not necessarily a concern in cases where treatment goals are based on a total pounds per year emissions limit or where removal efficiency is averaged over long time periods (*e.g.*, a monthly basis), excessive contaminant emissions during transient loading conditions may be problematic in cases where air pollution control regulations require a specified removal efficiency (*e.g.*, 90%) on a continuous basis. In such cases, a biofilter unable to maintain high removal efficiency during short-term periods of shock loading may not meet regulatory compliance even if it is able to achieve the required removal efficiency during “normal” operations over long time periods.

A design variation that has the potential to improve biofilter performance during transient loading conditions is a combination of a biofilter with an adsorption processes in a hybrid system that utilizes batch operating strategies. Terminology proposed for this new operating strategy is Sequencing Batch Biofilter (SBB) operation. Implementation of the SBB operating strategy utilizes one or more biofilters packed with medium containing powdered activated carbon (PAC) or other sorptive material and is operated with three distinct periods that comprise one complete cycle: FEED, REACT, and IDLE (see Figure 8.1).

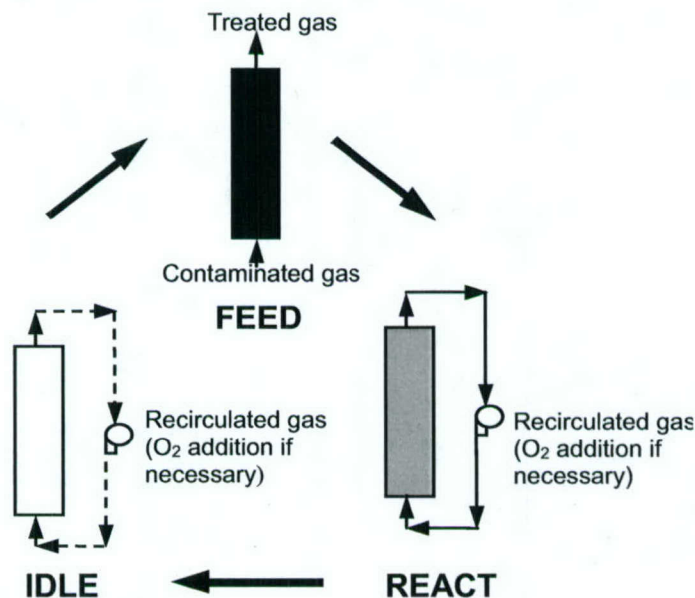

Figure 8-1. Cycle for One Biofilter in a Periodically Operated Multiple-reactor Biofilter System (Taken from Moe and Li, 2004).

During the FEED period, contaminated air enters the biofilter, and treated air exits. Contaminant removal is achieved by a combination of biodegradation, bioaccumulation of intracellular storage compounds, contaminant adsorption to the packing medium or biofilm, and contaminant absorption in the aqueous phase. Microbes degrade a portion of the incoming organics during this portion of the cycle, and the sorption capacity of the system is "filled." During transient loading periods, the system's sorption capacity can provide the important role of temporarily storing contaminants when their loading rate exceeds the biological reaction capacity. Because biodegradable contaminants can be accumulated in the biofilter, there can be a reduction in the empty-bed residence time (EBRT) without contaminant breakthrough. This facilitates a separation in time between when the contaminants enter the biofilter and when they are degraded, an advantage in treating unsteady-state waste streams, and it can result in a system comparable in size to or smaller than a conventional continuous-flow biofilter system.

At some point before contaminant breakthrough occurs, the influent contaminated air is diverted to a second biofilter and the first biofilter is operated in a batch REACT mode with air or pure oxygen addition and/or recirculation as necessary to maintain aerobic conditions in cases where oxygen is the desired electron acceptor. The task of biotransformation initiated during the FEED period is completed during REACT. As the contaminant concentration in the gas, liquid, and solid phases is lowered due to microbial degradation, contaminant mass initially adsorbed to the packing medium will desorb, providing additional substrate for the microorganisms. It is expected that recirculating air through the filter medium during REACT will allow electron donors and electron acceptors to be more uniformly distributed throughout the filter medium and thus allow for more spatially homogenous growth of microorganisms than would be expected in continuous-flow system, where excess microbial growth near the biofilter inlet can cause clogging.

During IDLE, the period between FEED and REACT, the biofilter awaits the beginning of a new cycle. The biofilter's excess capacity is measured by the total time in IDLE because the time could be easily reallocated to REACT (or FEED) if necessary, thus providing appreciable operational flexibility in full-scale operations.

In applications where there is an intermittent discharge of contaminated gases (*e.g.*, during an eight-hour work day), it may be possible to use a single biofilter, while in cases where a continuous contaminated gas flow is generated, multiple units installed in parallel and operated in sequence will be necessary. In multiple biofilter systems, the length of time for one biofilter to complete REACT and IDLE will be set equal to the total FEED time of all other biofilters in the system. For example, if a biofilter can be loaded for two hours before an unacceptably large contaminant breakthrough is reached during FEED, but four hours are needed for REACT and IDLE, then the system will require three biofilters (*i.e.*, as the other two biofilters are in FEED [2 hours each, 4 hours total], the third biofilter would be in REACT and IDLE [4 hours]). This can also be expressed as shown in Equation 8.1 below.

$$(n-1) t_{\text{feed}} = t_{\text{react}} + t_{\text{idle}} \quad (8.1)$$

where: n = number of biofilters in the system, and
 t = time devoted to a specific period of operation

Such a system is similar in concept to use of Granular Activated Carbon–Sequencing Batch Biofilm Reactors (GAC-SBBRs) used for treatment of wastewaters containing volatile or inhibitory compounds. In the GAC-SBBR process, granular activated carbon (GAC) placed in the SBR adsorbs a fraction of the influent contaminants during the FILL period. During the REACT period, microorganisms growing attached to the GAC or other support surfaces biologically regenerate the activated carbon to allow reuse in the process (Chozick and Irvine, 1991; Kolb and Wilderer, 1995, 1997; Ha *et al.*, 2000).

In support of the SERDP research project described in this report, column reactor experiments were conducted to assess whether periodic loading and subsequent batch operation can improve performance of biofilters for removing and destroying VOCs associated with painting operations. Initial experiments were conducted using a biofilter containing a novel packing medium, polyurethane foam manufactured in the laboratory to include powdered activated carbon, to treat a waste gas stream containing methyl ethyl ketone (Li and Moe, 2003). These studies demonstrated the proof-of-concept that sequencing batch operation is technically feasible and that it allows implementation of active control strategies that can improve biofilter performance during transient loading conditions (Li and Moe, 2003). Subsequent studies used biofilter columns containing media comprised of commercially available polyurethane foam coated with activated carbon. These subsequent studies demonstrated that there can be considerable advantage to sequencing batch operation for handling short-term variations in waste gas concentrations for single-component (MEK) or multi-component (MEK + toluene) waste gas stream (Moe and Li, 2004; Atoche and Moe, 2004).

8.1 Methods

Experiments conducted to assess the technical feasibility and potential merits of SBB operation utilized laboratory-scale systems with the general configuration shown in Figure 8.2. In addition to the basic components utilized in other continuous-flow biofilter experiments described previously, SBB biofilters contained additional components shown inside the dashed line in Figure 8.2 to allow gas recirculation. Solenoid valves with stainless steel bodies and flow tubes (Asco Valve Inc., N.J.) were used to turn air flow on and off as needed. A diaphragm pump with stainless steel heads and Teflon™ diaphragm (Air Dimensions Inc., Florida) was used to recirculate air through the biofilter during REACT periods (with gas flow exiting the bottom of the biofilter and then being reintroduced at the top). A 500-mL gas-scrubbing bottle was placed between the bottom recirculation outlet of the biofilter and the diaphragm pump to drain condensation. A microprocessor controller (Chron-Trol Corp., San Diego, California) was used to turn components on and off. During FEED periods, only the syringe pumps and air flow valves 1, 2, and 5 (see Fig. 1) were switched on. During REACT periods, only the diaphragm pump and valves 3 and 4 were switched on to recirculate air in the closed system. Flexible Teflon™ tubing (Cole-Parmer, Vernon Hills, Ill.) was used to connect the various components. In some experiments, a second biofilter, operated as a conventional CFB, was identical to the SBB except that valves and other components associated with gas recirculation were omitted.

Packing material used in the SBB consisted of either polyurethane foam cubes that were manufactured to include activated carbon as an integral part of the medium (Li and Moe, 2003) or polyurethane foam cubes that contained an activated carbon coating (Moe and Li, 2004; Atoche and Moe, 2004). In the case of the carbon-coated packing medium, foam of cubes

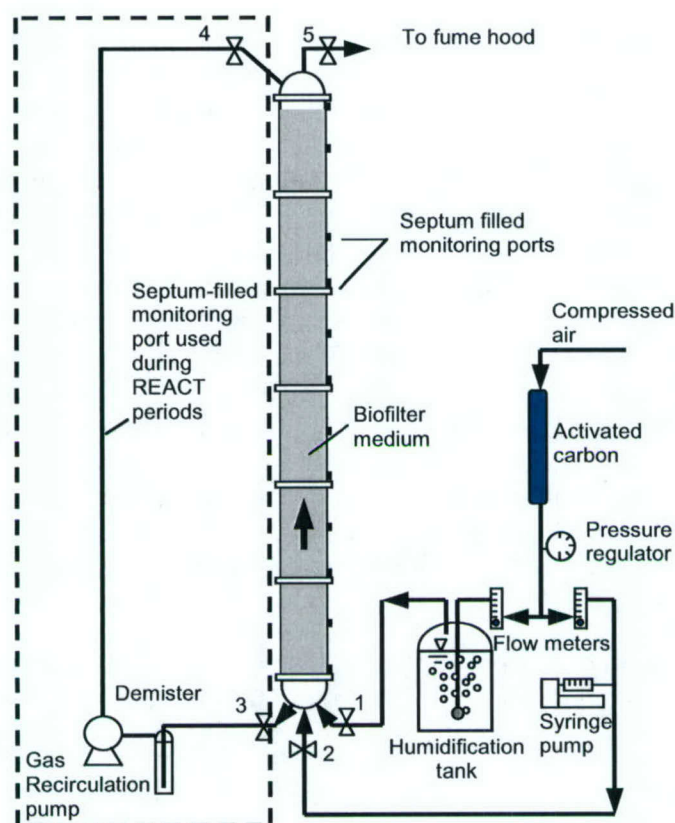

Figure 8-2. Schematic Diagram of the Laboratory-scale Sequencing Batch Biofilter (SBB) Apparatus. The Continuous-flow Biofilter (CFB) Was Identical Except That the Components Inside the Dashed Line Were Omitted.

supplied by the vendor in a size approximately 5.0 cm per side were cut into cubes approximately 1.25 cm per side prior to use. Packing material used in the CFB consisted of polyurethane cubes identical to those used in the SBB except that the cubes did not contain an activated carbon coating.

Specific experimental protocols and operating conditions for experimental evaluation of SBB operation are described in Li and Moe (2003), Moe and Li (2004), and Atoche and Moe (2004). Additional experiments conducted to characterize microbial populations in SBB and continuous-flow biofilters are described in Li and Moe (2004).

In one particular set of experiments, described in detail in Atoche and Moe (2004), one biofilter was operated as an SBB and the other was operated as a CFB (*i.e.*, conventional biofilter). As summarized in Table 8.1, there were three distinct periods of operation (arbitrarily named Phases 1, 2, and 3) that involved progressively higher contaminant loading rates. During all three phases of testing, the influent contaminant concentration and mass of contaminants loaded per day were identical for both biofilters. As further described below, the biofilters differed, however, in terms of the fraction of time in which contaminants were loaded to the systems and the overall operating strategy employed.

During Phase 1 (days 0 to 137), the operating strategy employed in the SBB consisted of 1.0 hr FEED and 2.0 hr REACT (total cycle length 3.0 hr, eight cycles per day). During FEED periods, the empty-bed residence time (EBRT) was set at 30 sec, and target influent concentrations for MEK and toluene were 80 and 28 ppm_v, respectively, during “normal” (steady loading) operation. This corresponds to a loading rate of 28.2 g m⁻³ h⁻¹ for MEK (grams of MEK supplied per cubic meter of packed bed volume per hour) and 12.7 g m⁻³ h⁻¹ toluene (total VOC loading rate of 40.9 g m⁻³ h⁻¹), and simulates the loading condition experienced by one biofilter in a set of three biofilters constructed in parallel and operated in sequence to treat a continuous gas flow. During REACT periods, gas was recirculated within the closed system. Because the SBB received contaminated air during only one-third of the cycle length, average MEK and toluene loading rates considering the entire cycle length were 9.4 g m⁻³ h⁻¹ and 4.2 g m⁻³ h⁻¹, respectively. During Phase 1, the EBRT in the CFB was set at 90 sec. The CFB was continuously supplied with a gas stream containing target influent concentrations of 28 ppm_v toluene and 80 ppm_v MEK during “normal” operation. This corresponds to a loading rate of 9.4 g m⁻³ h⁻¹ MEK and 4.2 g m⁻³ h⁻¹ toluene, identical to the SBB averaged over the total cycle length. The CFB loading simulates the loading experienced by a conventionally operated continuous-flow biofilter identical in size to the SBB.

TABLE 8-1. SUMMARY OF BIOFILTER OPERATING CONDITIONS DURING “NORMAL” LOADING (Atoche and Moe, 2004)

Continuous Flow Biofilter (CFB)	Phase 1	Phase 2	Phase 3
Days of operation	0–137	138–172	173–295
EBRT (seconds)	90	60	30
Influent MEK concentration (ppm _v)	80	80	89
MEK loading rate (g m ⁻³ h ⁻¹)	9.4	14.1	31.4
Influent Toluene concentration (ppm _v)	28	30	30
Toluene loading rate (g m ⁻³ h ⁻¹)	4.2	6.8	13.6
Total VOC loading rate (g m ⁻³ h ⁻¹)	13.6	20.9	45
Sequencing Batch Biofilter (SBB)			
Days of operation	0–137	138–172	173–295
EBRT (seconds)	30	30	15
Influent MEK concentration (ppm _v)	80	80	89
MEK loading rate during FEED (g m ⁻³ h ⁻¹)	28.2	28.2	62.7
Influent toluene concentration (ppm _v)	28	30	30
Toluene loading rate during FEED (g m ⁻³ h ⁻¹)	12.7	13.6	27.2
Total VOC loading rate during FEED (g m ⁻³ h ⁻¹)	40.9	41.8	89.9
Length of FEED Period (hr)	1.0	1.0	1.0
Length of REACT Period (hr)	2.0	1.0	1.0
Number of cycles per day	8	12	12

During Phase 2 (days 138 to 172), the FEED period in the SBB remained 1.0 hr while the REACT period was decreased from 2.0 hr to 1.0 hr. The EBRT remained 30 sec and target influent concentrations were 80 ppm_v MEK and 30 ppm_v toluene. This simulates the loading condition experienced by one biofilter in a set of two biofilters constructed in parallel and operated in sequence to treat a continuous gas flow. During Phase 2, the CFB had an EBRT of 60 sec and target influent concentrations of 80 ppm_v and 30 ppm_v for MEK and toluene,

respectively. This corresponds to a loading rate of $14.1 \text{ g m}^{-3} \text{ h}^{-1}$ MEK and $6.8 \text{ g m}^{-3} \text{ h}^{-1}$ toluene (total VOC loading rate of $20.9 \text{ g m}^{-3} \text{ h}^{-1}$) for the CFB on a continuous basis and for the SBB averaged over the total cycle length. During Phase 3 (days 173 to 295), EBRTs were adjusted to 15 sec and 30 sec for the SBB and CFB, respectively. FEED and REACT periods in the SBB remained one hour each. For both reactors, the target influent concentrations were 89 ppm_v MEK and 30 ppm_v toluene.

To assess biofilter response to uncontrolled variation in influent contaminant concentration (*i.e.*, “shock loading”), each biofilter was periodically subjected to a loading condition during which influent MEK and toluene concentrations were increased to five times that of the normal loading condition for a period of 1.0 hr. The shock loading conditions, summarized in Table 8-2, were conducted 16 times during Phase 1 and five times each during Phases 2 and 3. A minimum of six cycles of “normal” loading occurred between each shock loading experiment. Because the SBB had a higher air flow rate (three times that of the CFB during Phase 1 and twice that of the CFB during Phases 2 and 3) while the influent contaminant concentration and duration of shock loading was identical in the two biofilters, the contaminant loading rate and mass of contaminants entering the SBB during the 1-hr shock loading was higher than the CFB by a factor of three (Phase 1) or two (Phases 2 and 3). Total VOC loading rate to the CFB during shock loading was 68, 105, and $225 \text{ g m}^{-3} \text{ h}^{-1}$ during Phase 1, 2, and 3, respectively. Total VOC loading rate to the SBB was 205, 209, and $450 \text{ g m}^{-3} \text{ h}^{-1}$ during Phase 1, 2, and 3, respectively.

TABLE 8-2. SUMMARY OF BIOFILTER OPERATING CONDITIONS DURING “SHOCK LOADING” (Atoche and Moe, 2004)

Continuous Flow Biofilter	Phase 1	Phase 2	Phase 3
EBRT (sec)	90	60	30
MEK concentration (ppm_v)	400	400	445
MEK loading rate ($\text{g m}^{-3} \text{ h}^{-1}$)	47	71	157
Toluene concentration (ppm_v)	140	150	150
Toluene loading rate ($\text{g m}^{-3} \text{ h}^{-1}$)	21	34	68
Total VOC loading rate ($\text{g m}^{-3} \text{ h}^{-1}$)	68	105	225
Sequencing Batch Biofilter			
EBRT (sec)	30	30	15
MEK concentration (ppm_v)	400	400	445
MEK loading rate ($\text{g m}^{-3} \text{ h}^{-1}$)	141	141	314
Toluene concentration (ppm_v)	140	150	150
Toluene loading rate ($\text{g m}^{-3} \text{ h}^{-1}$)	64	68	136
Total VOC loading rate ($\text{g m}^{-3} \text{ h}^{-1}$)	205	209	450

For shock loading experiments, the instantaneous removal efficiency for each of the test compounds (MEK and toluene) was calculated using Eqn. 8.2. The instantaneous removal efficiency was calculated separately for MEK and toluene, and the total instantaneous removal efficiency was calculated based on the total inlet and outlet concentration of both constituents.

$$\text{Instantaneous Removal Efficiency} = \frac{C_{in} - C_{out}}{C_{in}} \times 100\% \quad (8.2)$$

Where C_{in} is the inlet VOC concentration at time = t (ppm_v), and C_{out} is the outlet VOC concentration at time = t (ppm_v).

To provide a second basis of comparison, the overall removal efficiency associated with each shock loading event was calculated using the mass of each contaminant entering the system during the shock loading period and the mass of each contaminant exiting the system during and after the shock loading event as shown in Eqn. 8.3.

$$\text{Overall Removal Efficiency} = \frac{M_{in} - M_{out}}{M_{in}} \times 100\% \quad (8.3)$$

Where M_{in} is the total mass of VOC entering the system during the 1-hr shock loading period (mg), and M_{out} is the total mass of VOC emitted from the system during and after the shock loading period (mg).

8.2 Results

Selected results from a side-by-side comparison of continuous-flow and sequencing batch operated biofilters packed with polyurethane foam media for treating a waste gas stream containing a mixture of toluene and methyl ethyl ketone are shown in Figures 8-3 and 8-4 (see Atoche and Moe, 2004, for a complete description of results). Figure 8-3 shows a comparison of biofilter performance during “normal loading” operating conditions, and Figure 8-4 shows results from selected shock-loading experiments.

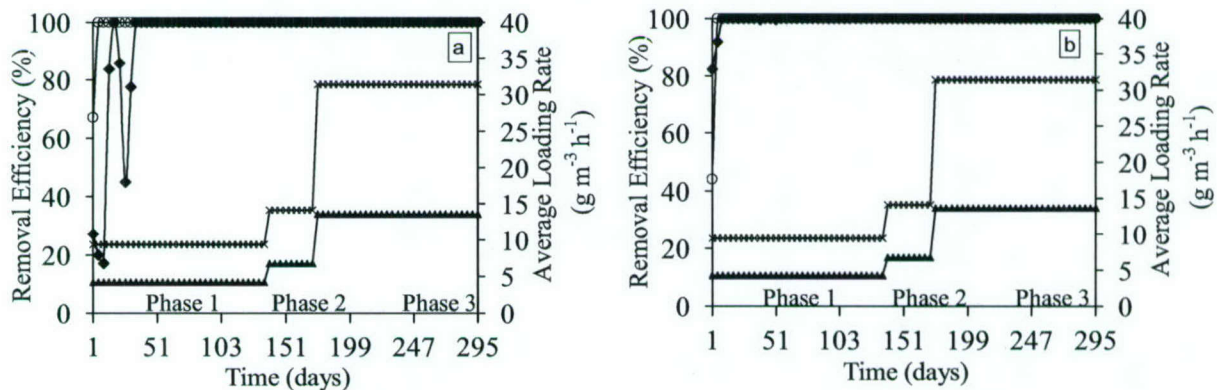

Figure 8-3. Average Loading Rate for Toluene (\blacktriangle) and MEK (\times) and Removal Efficiency for Toluene (\blacklozenge) and MEK (\circ) in the CFB (a) and SBB (b) during Normal Operation of Phase 1. For Comparison Purposes, Data Depicted in the Figure for the SBB Are Average Daily Loading Rates Rather Than Loading Rates during FEED Periods (Taken from Atoche and Moe, 2004).

As shown in Figure 8-3, on the basis of overall performance during “normal” loading, aside from small performance differences during the initial start-up period, both biofilters were essentially identical. Both received the same contaminant loading on a daily basis, and both removed greater than 99% of the influent contaminants mass.

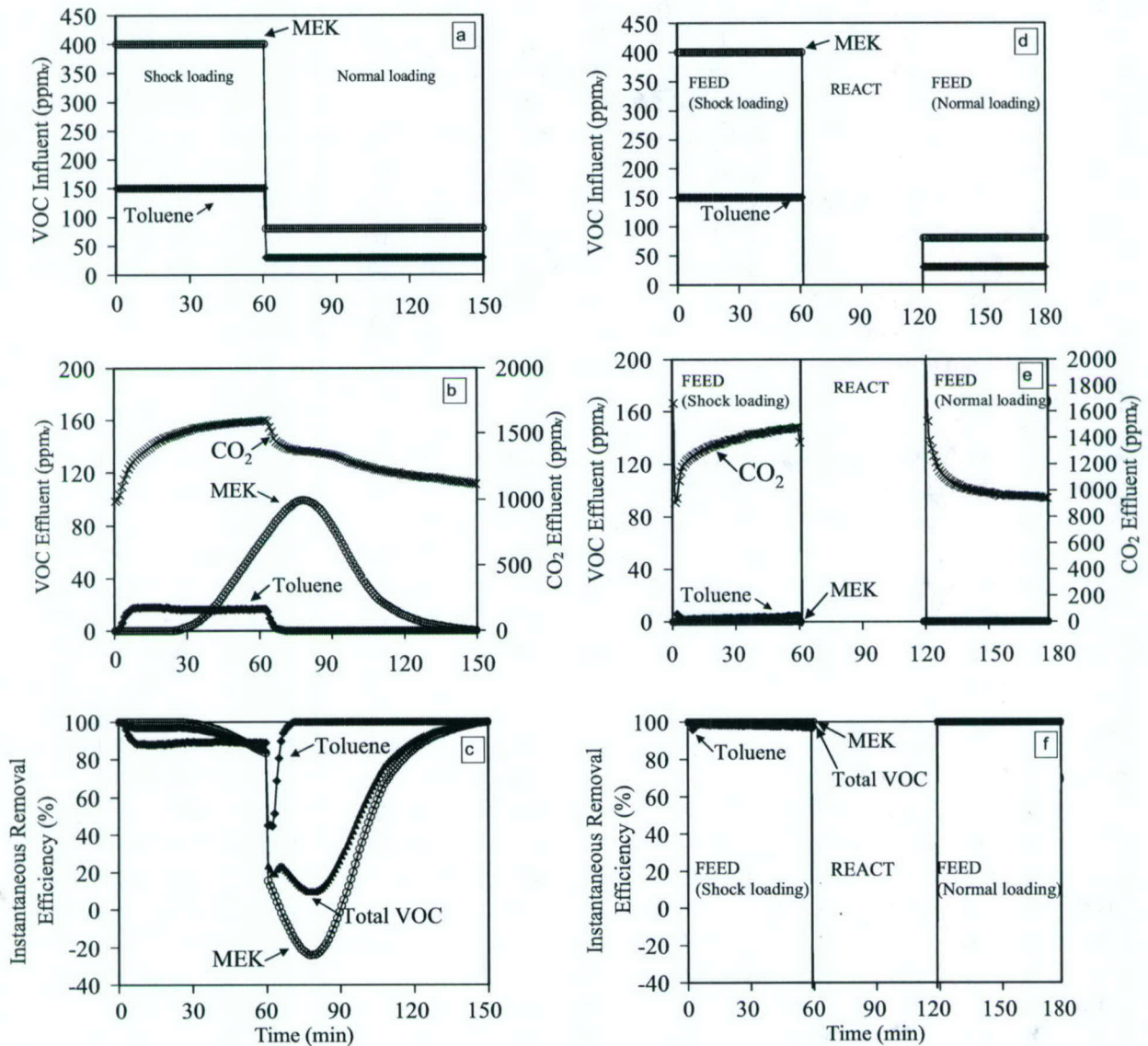

Figure 8-4. Phase 2 Shock-loading Experiments. Influent Contaminant Concentrations in the CFB (a) and the SBB (d). Effluent Contaminant Concentrations in the CFB (b) and the SBB (e). Instantaneous Removal Efficiency in the CFB (c) and the SBB (f). Constituents Included Are: Toluene (♦), MEK (○), CO₂ (x), and Total of Both VOCs (▲). (Taken from Atoche and Moe, 2004)

Biofilter performance differed markedly, however, in terms of performance during “shock-loading” conditions. As an example, results from a shock loading study performed during Phase 2 of operation are shown in Figure 8-4.

As depicted in Fig. 8-4 (a and d), during Phase 2 shock loading conditions, influent MEK and toluene concentrations increased to 400 ppm_v and 140 ppm_v (five times that of normal loading),

respectively for a period of 1.0 hr (with time 0 in the figure corresponding to the start of shock loading). Direct measurement of influent MEK and toluene concentrations during shock loading time periods confirmed that influent VOC concentrations increased to near target loading rates within 5 min of the step increase in concentration at the start of shock loading, and they decreased to near the target loading rate within 4 min of step decrease in concentration at the end of shock loading. For the CFB, effluent toluene, MEK, and CO₂ concentrations as a function of time during and after the shock loading events are depicted in Fig. 8-4b. MEK was first observed in the effluent 50 min after the start of shock loading and increased to a maximum of 99.5 ppm_v approximately 90 min after shock loading began (30 min after shock loading ended and influent VOC concentrations returned to "normal" levels) before gradually decreasing to zero after approximately 45 additional min. Toluene was detected in the effluent starting 2 min after shock loading began and increased to a concentration of 18 ppm_v, where it remained relatively constant until 5 min after shock loading ended.

The effluent CO₂ concentration began to increase rapidly almost immediately after the start of the shock loading period, indicating that the microbial population was able to rapidly increase its degradation rate following the increase in contaminant loading. As MEK and toluene data demonstrate, however, the increase in degradation rate was insufficient to remove all of the influent contaminant loading. Shortly after the shock loading period ended and loading returned to its "normal" level, the effluent CO₂ concentration decreased at a rapid rate and then continued to decrease but at a lower rate during the next 95 min, at which point monitoring was discontinued.

Because of the system's sorptive capacity and consequent peak attenuation, the maximum effluent MEK concentration (48.5 ppm_v) was not reached until after the transient loading condition ended and the influent concentration returned to 80 ppm_v (the "normal" concentration). As shown in Figure 8-4c, this resulted in an average minimum instantaneous MEK removal efficiency of -27% (calculated using Eqn. 8-2). The negative instantaneous removal efficiency reflects the fact that the effluent concentration was higher than the influent concentration, and in this case, the instantaneous removal efficiency for MEK was negative for 24 min. The average minimum instantaneous toluene removal efficiency was 42.4%, and the average combined minimum instantaneous removal efficiency (accounting for total influent and effluent concentrations of both compounds on an instantaneous basis) was only 4.5%. The combined minimum instantaneous removal efficiency was higher than for each compound considered separately because, as shown in the figure, the minimum instantaneous removal efficiency for each compound occurred at different times.

In terms of the mass of contaminant removed by the CFB during Phase 2 shock loading events, average MEK removal was 79.6% and average toluene removal was 88.6% (*i.e.*, 20.4% of the mass of MEK and 11.4% of the mass of toluene entering the system during the shock loading events was emitted from the system, calculated using Eqn. 8-3). The average combined overall removal efficiency for the CFB during the shock loading events conducted in Phase 2 was 82.5%. Collectively, these data demonstrate that poor performance in terms of instantaneous removal efficiency can be observed even in cases where overall contaminant removal is relatively high (*e.g.*, greater than 80%).

Results from Phase 2 shock loading events conducted in the SBB are shown in Figure 8-4e. As shown in the figure, the effluent MEK concentration remained below detection during the entire 60-min shock-loading FEED period, and toluene remained below 3 ppm_v. Following the 60-min FEED period of shock loading, the system entered REACT and gas was recirculated within the closed SBB system. Measurements during the REACT period immediately following shock loading revealed maximum MEK and toluene concentrations of 106 and 0.3 ppm_v, respectively, 3 min after the start of REACT. Toluene decreased below detection after 15 min, and MEK was below detection after 45 min. The CO₂ concentration increased to an average maximum of 16,500 ppm_v at the end of the REACT period, and the O₂ concentration reached a minimum of 17.5%. No MEK or toluene was detected in the SBB effluent during the subsequent FEED period, demonstrating that 1.0 hr of REACT was sufficient time for accumulated organics to be degraded.

In terms of the average overall mass of contaminant removed by the SBB during Phase 2 shock loading events, 100% of the MEK mass and 98.0% of the toluene was removed. This corresponds to an average combined overall removal efficiency of 99.3%. Thus, the SBB exhibited markedly higher overall contaminant removal and higher minimum instantaneous removal efficiency than did the CFB.

These results demonstrated that use of packing media composed of activated-carbon-coated polyurethane foam combined with SBB operation can offer advantages over conventional biofilters in several important measures of performance, namely overall contaminant removal efficiency and minimum instantaneous removal efficiency (Moe and Li, 2004; Atoche and Moe, 2004). During transient periods of elevated contaminant loading, the SBB system was able to accumulate a portion of the contaminants during the FEED period and subsequently degrade the accumulated pollutants during the following REACT period, even after long-term operation. The operational flexibility of the SBB system facilitated selection of operational conditions that led to markedly higher minimum instantaneous removal efficiency than was achieved in the CFB, and implementation of SBB operating strategies may allow expanded use of biofiltration in applications where instantaneous removal efficiency is a concern. Research results also indicate that the SBB operating strategy was able to impact microbial selection and enrichment (Li and Moe, 2004).

Although the results summarized above and described in detail in the publications listed below demonstrated that there can be advantages to SBB operation in treating VOCs associated with painting operations, such systems would be more complicated in terms of both construction and operation. Consequently, this operational configuration was not selected for pilot-scale testing. It should be noted, however, that such operational principles may be useful in some applications.

Resulting Publications

- Atoche, J.C.; and Moe, W.M. (2004) "Treatment of MEK and Toluene Mixtures in Biofilters: Effect of Operating Strategy on Performance During Transient Loading," *Biotechnology and Bioengineering*, **86**(4), 468–481.

- Moe, W.M.; and Li, C. (2004) "Comparison of Continuous and Sequencing Batch Operated Gas-Phase Biofilters for Treatment of MEK," *Journal of Environmental Engineering, ASCE*, **130**(3), 300–313.
- Li, C., and Moe, W.M. (2004) "Assessment of Microbial Populations in Methyl Ethyl Ketone Degrading Biofilters by Denaturing Gradient Gel Electrophoresis," *Applied Microbiology and Biotechnology*, **64**(4), 568–575.
- Li, C.;and Moe, W.M. (2003) "Sequencing Batch Biofilter Operation for Treatment of Methyl Ethyl Ketone (MEK) Contaminated Air," *Environmental Technology*, **24**(5), 531–544.

CHAPTER 9: INTEGRATED LABORATORY-SCALE EVALUATION OF AN INTERMITTENT, FOAM BIOTRICKLING FILTER

For full-scale deployment of biofiltration technology at paint spray booths, it is desirable to design a bioreactor system that is relatively simple to operate in addition to efficiently removing the pollutants found in painting operation emissions. Investigation of the biotrickling filter and biotrickling filter/biofilter hybrid designs conducted in the previous study phases indicated that both of these systems were capable of degrading paint VOC mixtures. However, a continuously recirculating nutrient solution was required, and it was relatively difficult to remove the aromatic constituents of the waste gas stream. In the studies described in this chapter, an intermittent biotrickling filter design was evaluated for its ability to degrade paint VOC mixtures. In the intermittent biotrickling filter design, the nutrient solution is recirculated through a synthetic foam packing material only periodically (as opposed to continuously in a conventional biotrickling filter). As well as reducing pumping costs, such a system will reduce the excess water present on the biologically active packing material and may be more suited to removing hydrophobic constituents present in the waste gas stream. The intermittent biotrickling filter investigated in this phase of the study was packed with a polyurethane foam medium that has several desirable properties including light weight, high surface area per unit volume, and capacity for removing excess biomass via compression.

A series of preliminary experiments were conducted to assess performance of this intermittent biotrickling filter. Although several adjustments had to be made to initially establish an effective biofilm on the packing material, the system was capable of removing greater than 99% of the paint VOC mixture. Based on these preliminary results, the system was selected for further lab-scale evaluation over long-term operation and at conditions that more closely represent those found at DoD paint spray booths. Specific objectives of this study phase included the following:

- Determine the effect that inoculation method and acclimation history have on VOC degradation patterns and microbial populations in the bioreactor;
- Assess how the diversity of the mixed microbial population in the bioreactors changes with operating time;
- Delineate the effect that empty-bed contact time and pollutant concentration have on pollutant removal and establish the elimination capacity of the system as a function of VOC loading rate; and
- Evaluate the capability of the intermittent biotrickling filter to treat paint emissions that are provided on a schedule that mimics actual booth operations (*e.g.*, 6 hours per day, 5 days per week).

In the previous study phases, it was consistently observed that removal of the aromatic hydrocarbons in the paint VOC mixture limited the overall removal efficiency obtained in the system regardless of the particular bioreactor configuration investigated. One goal of the integrated study of the intermittent biotrickling filter was therefore to determine the conditions that favor establishment of a mixed microbial culture capable of degrading aromatic hydrocarbons in the bioreactor. It was hypothesized that a sequential feeding strategy during

bioreactor startup may reduce VOC-substrate interactions in biofilters treating paint VOC mixtures. In this sequential-feed approach, the bioreactor was first supplied with a more recalcitrant compound (toluene), until biomass was established and contaminant removal efficiency increased. Then the more easily degraded compounds were sequentially added to the influent waste gas stream. During preliminary experiments, this strategy was shown to enhance VOC removal in general and aromatic compound degradation in particular. It was unclear from these preliminary experiments, however, whether the sequential-feed method or the development of the inoculum itself was more important for determining the ultimate biodegradation capacity of the biofilter for paint VOC mixtures. Also, it was unclear how the microbial community in the biofilter was affected by long-term bioreactor operation.

To address these questions, the effectiveness of the sequential-feed strategy was evaluated and the response of the intermittent biotrickling filter to dynamic feed conditions was investigated in a laboratory-scale intermittent biotrickling filter system. In addition, the elimination capacity of the bioreactor for the paint VOC mixture was determined, as was the effect of empty-bed contact time. Finally, a molecular technique was used to assess the stability of the microbial community in the bioreactor over nearly one year of operation.

9.1 Materials and Methods

Two identical intermittent biotrickling filters were used in this phase of the study. The design of each bioreactor was identical to the system depicted in Figure 4-1 (see Chapter 4) except that each reactor contained only three packed-bed sections. Each section was packed with polyurethane foam cubes (1.5 cm) to a height of 19 cm. A 12-cm plenum was located between each packed section to allow for gas sampling and redistribution of the contaminant stream between sections. A nutrient solution was periodically sprayed over the top of the column via spray nozzles (BETE Fog Nozzle, Inc., TF type) and recirculated through the column at 2 L/min. During the bioreactor start-up period (Day 0 to Day 63 of operation), the spraying frequency and composition of the nutrient medium were altered several times in an attempt to optimize bioreactor performance.

During the experiment, the two intermittent biotrickling filters were operated in an identical fashion except for the composition of the VOC-contaminated waste gas provided to each. One biofilter (the Continuously Fed Column, CFC) was provided a five-component paint mixture continuously throughout the experiment while the second bioreactor (the Sequentially Fed Column, SFC) was provided the VOCs in a sequential manner (*i.e.*, first toluene, then a toluene-methyl propyl ketone mixture and finally the five-component paint mixture provided to the CFC). The continuously fed column was provided a five-component paint mixture consisting of 110 ppm_v methyl propyl ketone (MPK), 20 ppm_v toluene (Tol), 32 ppm_v *n*-butyl acetate (NBA), 20 ppm_v xylene (Xyl), and 18 ppm_v ethyl 3-ethoxypropionate (EEP) throughout the entire 270 days of the experiment. The sequentially fed column, on the other hand, was supplied with 160 ppm_v toluene only until Day 63 of operation. Once toluene degradation was established in the sequentially fed column, a mixture of 164 ppm_v MPK and 38 ppm_v toluene was supplied from Days 64 to 71. During the remainder of the experiment, the sequential bioreactor was supplied the same five-component surrogate paint mixture that was provided to the continuously fed column. Both biofilter columns were operated at an empty-bed contact time (EBCT) of 1 min. The total VOC-carbon loading to each biofilter was maintained at approximately 33 g-C/m³-hr

throughout the experiment even though the VOC composition of the waste gas varied in the sequentially fed column as a function of operating period.

9.1.1 Inoculum Development

The inoculum for the biofilter experiments described in this chapter was derived from activated sludge from a wastewater treatment facility (Walnut Creek Wastewater Treatment Plant, Austin). To ensure that the bioreactor was inoculated with a diverse culture capable of degrading each of the VOC components of the waste gas, five separate enrichment cultures were grown. Each was supplied with one of the individual VOC compound as the sole carbon and energy source. The enrichment cultures were grown at 23 °C in 250-mL glass Boston round bottles containing 100 mL of nutrient medium (KH_2PO_4 , 1.36g/L; Na_2HPO_4 , 0.71g/L; KNO_3 , 3.13g/L, 0.66g/L; $\text{MgSO}_4 \cdot 7\text{H}_2\text{O}$, 0.05g/L; $\text{CaCl}_2 \cdot 2\text{H}_2\text{O}$, 0.0147g/L; 1mL/L of a trace metal solution. The trace metal solution consisted of the following compounds (mg/L): H_3BO_3 , 2.86; $\text{MnSO}_4 \cdot \text{H}_2\text{O}$, 1.54; $\text{FeSO}_4 \cdot 7\text{H}_2\text{O}$, 2.50; $\text{CuCl}_2 \cdot 2\text{H}_2\text{O}$, 0.027; $\text{ZnSO}_4 \cdot 7\text{H}_2\text{O}$, 0.044; $\text{CoCl}_2 \cdot 6\text{H}_2\text{O}$, 0.041; $\text{NaMoO}_4 \cdot 2\text{H}_2\text{O}$, 0.025; $\text{NiCl}_2 \cdot 6\text{H}_2\text{O}$, 0.020.) A concentration of 100 mg VOC-carbon per liter was added to each bottle as a neat liquid. When each individual culture was able to degrade three sequential injections of a single VOC, the five cultures were mixed together in a carboy containing 5L of the same nutrient medium used in the bottles. This mixed inoculum was then fed a mixture of five paint VOCs. Once this VOC mixture had been degraded, an equal volume of the inoculating culture was recirculated through the packing material in each bioreactor for 12 hrs prior to start-up.

To assess how the inoculation and sequential feed strategy affected the microbial population in the biofilters, biomass samples were collected from the initial inoculation culture as well as from along the height of each biofilter column during operation. This allowed an assessment of the microbial population as a function of spatial location, operating time, and acclimation method (see Section 9.2.4 for further description).

9.1.2 Analytical Methods

VOC gas measurements. Gas samples were periodically collected from each gas sampling port with 0.5-mL gas-tight syringes fitted with a Mininert™ valve and a side-bore needle (Hamilton 1700 series). The samples were analyzed using a Hewlett-Packard Model 6890 Gas Chromatograph (GC) equipped with a flame-ionization detector (FID) and a HP-5 capillary column. The GC was calibrated using five gas standards with known concentrations of each chemical analyzed.

Moisture Content, Pressure Drop and pH. To determine the moisture content in the vapor-phase bioreactor, packing medium samples were periodically collected from each sampling port. Moisture content was determined gravimetrically after drying overnight in a 105 °C oven. Pressure drop across each column was measured periodically by connecting a pressure gauge (Magnehelic, Model 2001C and Magnehelic, Model 2005C) to the top and bottom sampling ports. The pressure difference was measured in inches of H_2O . The pH of leachate drained from each bioreactor column was measured using an Accumet ® pH meter (Fisher Scientific, Model 50, Houston, Texas).

COD. The COD of biofilm samples was measured to monitor biomass accumulation in the bioreactors. In this procedure, two foam cubes from each bioreactor section were removed and placed in a 50-mL vial. The vials were filled with 40 mL of Ultra High Purity (UHP) water. Biomass was removed from the packing material using a sonicator (FS6 Fisher Scientific Sonicator) and vortex mixer. Once biomass was removed from the packing medium, a 2-mL sample from the well mixed vial was removed and added to a COD vial. The COD analyses complied with Hach Method 8000 for COD determinations through colorimetric measurements (The Hach Company, 1997). For the COD standard curve, six standard solutions were prepared using a potassium hydrogen phthalate solution prepared according to standard methods (American Public Health Association 1992) with COD concentrations ranging from 0 to 2000 mg/L COD were prepared and analyzed.

Inorganic Nitrogen (ammonium and nitrate nitrogen). Ammonium and nitrate samples were prepared by adding biofilm sample to 10 mL of deionized water and then homogenizing using a vortexer for 1 minute and a sonicator for 5 minutes. The liquid ammonium concentration was then measured using an ammonium electrode (ORION®, Model 95-12, Boston, Mass.), and nitrate was measured using a nitrate combination electrode (Accumet, Fisher Scientific, N.J.). The electrode probes were calibrated with six-point NH_4Cl and KNO_3 standard solutions. To adjust ionic strength for both samples and standards, 0.4 mL of the ammonium ionic strength adjustment (ISA) solutions (Fisher Scientific, N.J.) was added in ammonium measurements, while 0.4 mL of 2M $(\text{NH}_4)_2\text{SO}_4$ was added for nitrate. The electrode probes were allowed five to ten minutes to stabilize before readings were recorded for each sample.

9.2 Results

9.2.1 Effect of Sequential vs. Continuous Feed Strategy

During the 63-day start-up period, the sequentially fed column (SFC) was provided a toluene-only waste gas feed while the continuously fed column (CFC) was supplied a waste gas contaminated with five-component surrogate paint mixture. The overall VOC removal efficiency in both the SFC and CFC biofilters during the start-up period is shown in Figure 9-1. To prevent shear force from the nutrient spray from washing biomass out of the bioreactors, no nutrients were sprayed over the top of the columns during the first three days of operation. It was expected that the inoculum itself contained sufficient nutrients for the first couple of days of operation. However, within the first 3 days of biofilter operation, VOC removal in both columns declined, suggesting that nutrient limitation was a problem.

Following three days of nutrient-limited conditions, additional nutrients were sprayed daily over the top of the column for 5 minutes per day. Moderate improvements were observed; however, when the nutrient spraying interval was increased to 30 minutes twice per day (60 minutes per day total), a rapid increase in VOC removal was observed. Within 30 days, high VOC removals were achieved and maintained in both columns. Interestingly, the VOC removal efficiency in the CFC biofilter was as high as that achieved in the SFC during this start-up period. These results suggest that the method used to develop the inoculum for the SFC and CFC bioreactors yielded a more diverse and robust microbial culture since the cultures were individually enriched for each VOC present in the paint mixture.

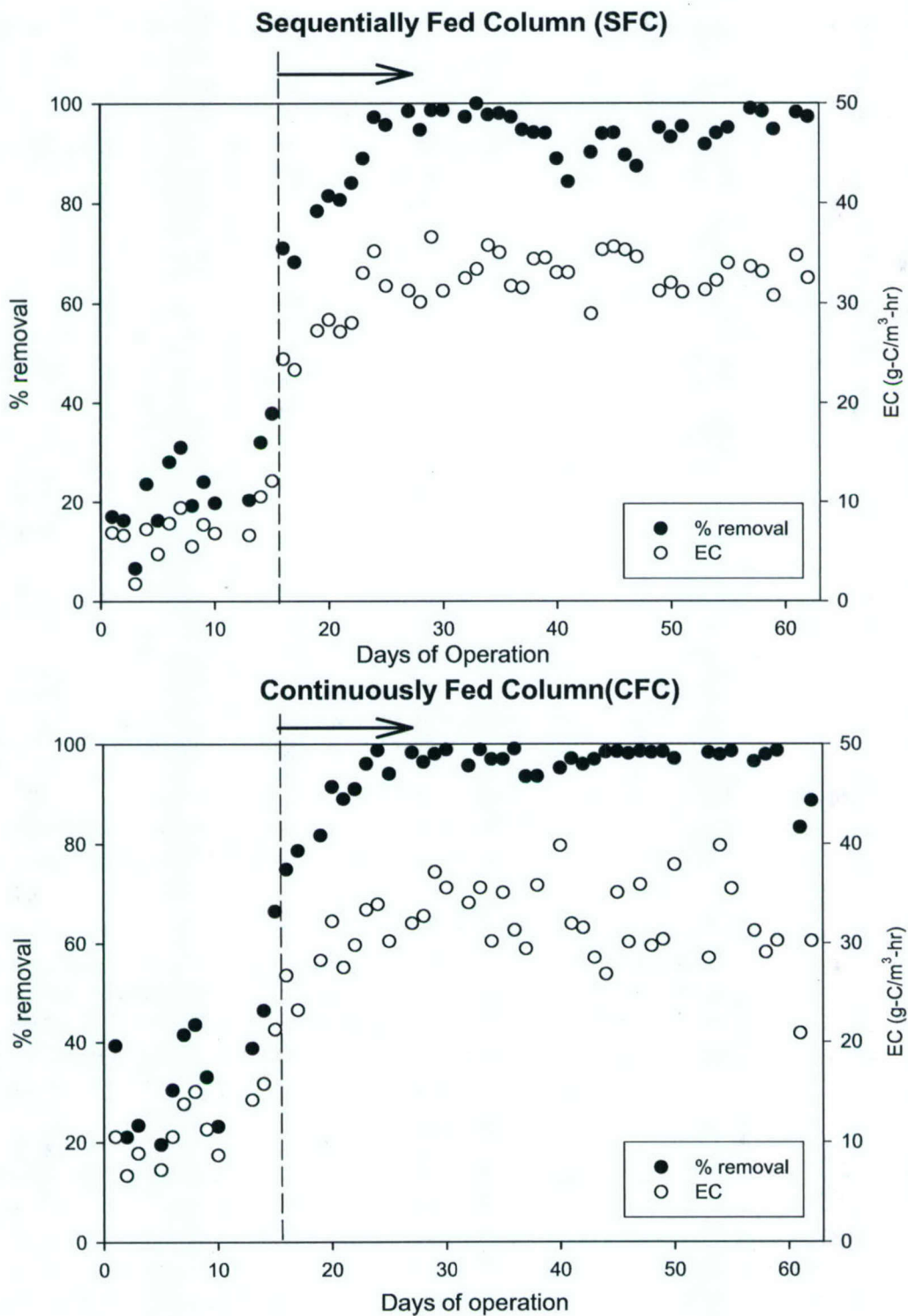

Figure 9-1. VOC Removal during the Start-up Period (from Day 0 to 63) in the Sequentially and Continuously Fed Columns. The Arrow on Each Figure Indicates the Day When the Nutrient Spraying Interval Was Increased to 30 Minutes, Twice a Day.

As was observed in previous experiments, removal of methyl propyl ketone and the aromatic hydrocarbons was poor under nutrient-limited conditions, while almost complete removal of NBA and EEP was achieved in the CFC biofilter. After supplemental nutrients were provided, MPK removal recovered most rapidly. Toluene and xylene removal efficiency improved much more slowly. Figure 9-2 presents the VOC removal profiles across the CFC biofilter on Day 48, when the bioreactor had achieved stable removal of the paint VOC mixture.

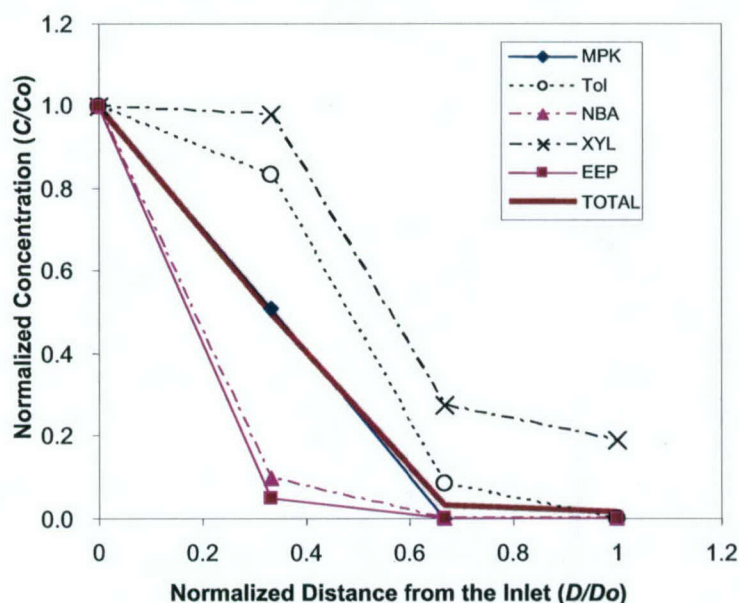

Figure 9-2. VOC Removal Profiles across the CFC Biofilter on Day 48. (C_o : VOC Concentration at the Inlet, C : VOC Concentration at Each Sampling Point, D : Bed Depth to Each Sampling Point, D_o : Total Packed-bed Depth from Inlet to Outlet)

Even though nutrients are a crucial factor for facilitating microbial growth and improving pollutant removal in the biofilter columns, it was difficult to achieve nutrient (nitrogen)-rich conditions in the biofilters during the start-up period (See Figure 9-3). Because biomass establishment on the packing medium immediately after inoculation was poor, little of the nutrient solution provided to the packing material was actually retained in the biofilm. Thus, nutrients (nitrogen in particular) may limit biomass establishment on the packing medium.

Prior to Day 16 of operation, the nutrient solution was sprayed over the column only 5 minutes per day. The biomass quantity retained on the foam packing material as well as the nitrogen available in the biofilm were quite low, and as a result, the VOC removal efficiencies in both columns were low. From Day 16 onward, however, the nutrient spraying interval was increased to 30 minutes and, by Day 41, the quantity of biomass retained on the packing material was substantially greater. Similarly, the nitrogen retained within the packing material also increased; by Day 58 it was five times greater than that available during the first few weeks of operation. As nutrient availability and biomass quantity increased, the VOC removal rapidly increased. These results suggest that establishment of biomass within the column aided nutrient retention within the column and vice versa.

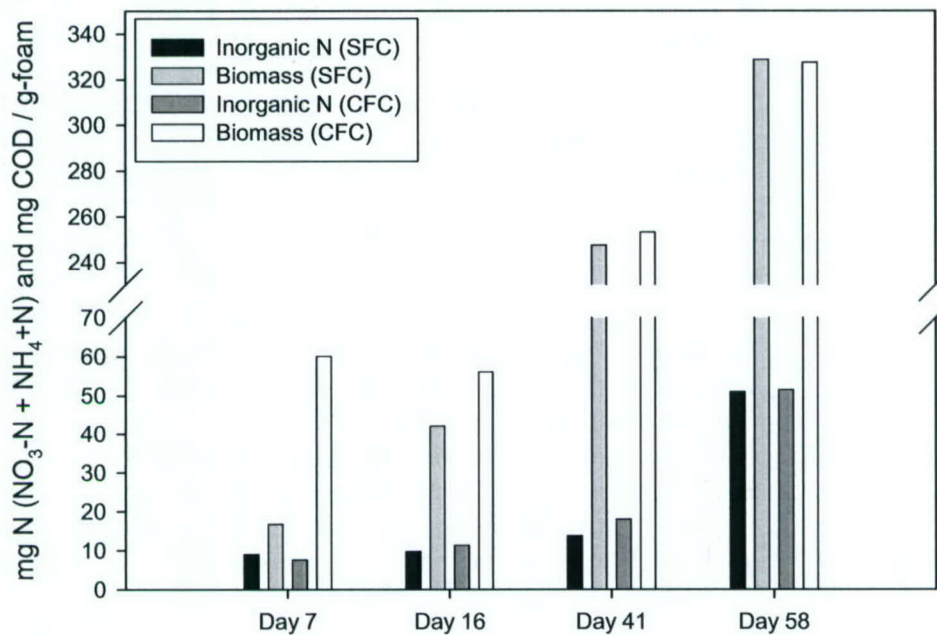

Figure 9-3. Total Inorganic Nitrogen Concentration and Biomass Quantity (COD) in the SFC and CFC Biofilters during the Start-up Period.

The poor VOC removal observed during the start-up period was likely due to a nutrient limitation caused by poor nutrient distribution and retention within the column. The VOC removal efficiency in both intermittent biotrickling filters increased significantly only after the nutrient spraying frequency was increased to 30 min, twice a day. A more concentrated nutrient solution containing 20 g/L KNO_3 and 3.96 g/L $(\text{NH}_4)_2\text{SO}_4$ did not improve performance when a short spraying interval (5 minutes) was employed. Similarly, tripling the ammonium concentration in the recirculating liquid medium had little effect on bioreactor performance at a short spraying interval. These results suggest that the nutrient distribution issue was more likely the important factor affecting VOC removal rather than the concentration of the nutrient solution itself during the start-up period.

MPK/toluene feed experiment (Day 64 to Day 7). After the SFC biofilter achieved steady removal of toluene, a mixture of MPK (164 ppm_v) and toluene (38 ppm_v) was supplied to the column. This pollutant loading rate is equivalent on a carbon basis to the total paint VOC mixture provided to the CFC during this period. Even though the column was initially inoculated with an MPK-degrading culture, the biofilter had not been exposed to MPK for two months prior to switching the feed composition. Regardless, the recovery of MPK removal in the biofilter was quite rapid. MPK and toluene were degraded nearly simultaneously in the biofilter column suggesting that the toluene-degrading microbial culture in the biofilter was able to degrade MPK as well. A longer delay would have been expected before high MPK removal was achieved in the biofilter if different microorganisms were responsible for the MPK and toluene degradation. Following the switch in feed composition, removal of MPK in the column

continued to improve and seven days later, most of the MPK supplied to the column was degraded in the first 25 cm of biofilter depth.

Paint mixture experiment (Day 72 to Day 122). During the remainder of the experimental period, a surrogate paint mixture was supplied to the SFC. The SFC biofilter immediately removed NBA and EEP after switching from the MPK/toluene feed to the five-component paint mixture. In the SFC biofilter, complete removal of MPK and 90% removal of toluene was achieved even in the presence of the other three compounds. Xylene removal efficiency was initially low (~20 %) (Figure 9-4). Ten days following the change in feed composition in the SFC, however, xylene removal efficiency had improved to 94% and then decreased again, while toluene removal remained consistently high. The SFC, which had been supplied only toluene for 63 days following startup, sustained high toluene removal (approx. 80 to 90%) whereas toluene removal in the CFC was lower and less stable (varying between approx. 50 and 85%). Xylene removal in both systems was generally much lower (on the order 20 to 50%). Nevertheless, overall VOC removal in both columns remained at approximately 90% throughout bioreactor operation. Loss of xylene degradation activity observed in the SFC and CFC columns may have been due to adverse effect of high salt concentrations in the nutrient solution recirculated in the columns (see further discussion in Section 9.2.2).

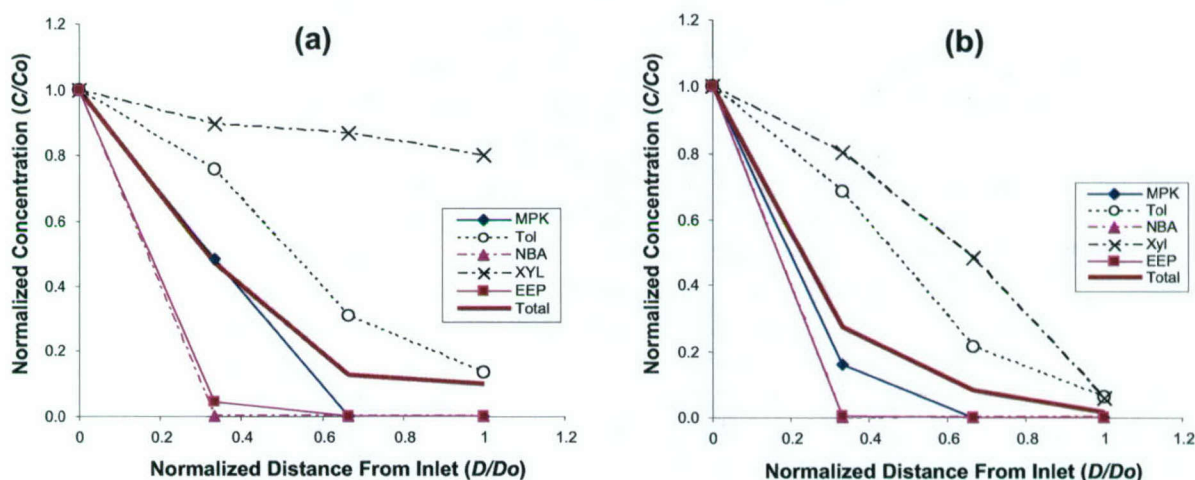

Figure 9-4. Paint Mixture Removal Profile across the SFC on (a) Day 72 and (b) Day 80: (a) One Day and (b) Nine Days after Switching from the Methyl Propyl Ketone/Toluene Feed to the Surrogate Paint Mixture Feed.

9.2.2 Nitrogen Limitation Experiments

After the SFC and CFC bioreactor columns achieved quasi-steady-state removal of the paint VOC mixture under nitrogen-rich conditions, the effect of nitrogen limitation on VOC removal in the biofilter was investigated from day 123 to day 163. On day 123, all nitrogen-containing components were removed from the nutrient media solution. Six days after removal of the nitrogen source from the nutrient solution, the inorganic nitrogen concentration ($\text{NO}_3\text{-N} + \text{NH}_4\text{-N}$) in the packing media quickly dropped. Interestingly, xylene and toluene removal increased right after the nitrogen source was eliminated from the nutrient solution. These results suggest

that the high salt concentration and ionic strength of the nutrient solution may have inhibited activity of the aromatic degrading microorganisms. However, as the inorganic nitrogen available in the biofilm for the microorganisms became severely depleted, toluene and xylene removals gradually decreased. By day 135, the inorganic nitrogen was almost completely depleted from the biofilm in the bioreactors. Even after complete depletion of inorganic nitrogen, MPK breakthrough did not occur for another two weeks, probably because the microorganisms were utilizing recycled organic nitrogen (Song *et al.*, 2003). Finally, after approximately 35 days of biofilter operation under nitrogen-limited conditions, breakthrough of MPK was also observed. However, NBA and EEP were still completely degraded. It is interesting to note that the order of breakthrough of each of the paint VOCs under nitrogen-limited conditions in this experiment was exactly the reverse of the order in which the VOCs were found to be degraded when nitrogen-rich conditions were established in the column during the start-up period.

Minimum Nitrogen Supply (From Day 164 to Day 205). Even though VOC removal efficiency eventually decreased under nitrogen-limited conditions, higher VOC removals were achieved immediately after the nitrogen-containing salts were removed from the nutrient solution at the start of the nitrogen limitation experiments described above. This result suggests that high nutrient concentrations in the nutrient spray solution may have adversely affected microbial activity, possibly due to high ionic strength of the solution. To investigate this possibility and to identify the minimal nitrogen supply necessary to maintain high VOC removal efficiencies, a series of experiments were conducted. In these experiments, nitrogen concentration in the nutrient solution was decreased from 20 g/L KNO_3 to 5 g/L KNO_3 and the spraying frequency was decreased from 30 minutes twice per day to 30 minutes once per day.

Prior to these experiments, the biofilter had been operated under nitrogen-limited conditions for 40 days as described above. As soon as the inorganic nitrogen source was reintroduced to the biofilter on day 164, VOC removal efficiency increased immediately. The VOC removal improved even further when the concentration of the nutrient solution was decreased approximately fourfold to 5 g/L KNO_3 and 3.96 g/L $(\text{NH}_4)_2\text{HPO}_4$ and the spraying interval was reduced to once per day for 30 minutes (Figure 9-5). Xylene removal was the most sensitive to the nitrogen supply, and xylene removal efficiency decreased when the nitrogen levels in the packing media increased (*e.g.*, see Day 182). Unfortunately, the nitrogen level in the biofilm that is detrimental for xylene removal could not be determined in this experiment due to the limited number of sampling points. However, the data do indicate that when the nitrogen supply to the bioreactor was decreased and the nitrogen concentration in the biofilm decreased, xylene removal efficiency began to increase. Interestingly, the SFC had an advantage with respect to xylene removal, ultimately achieving almost 80% xylene removal while the CFC achieved only 35% xylene removal. Thus, acclimation history of the bioreactor column appears to have played a role in the ultimate removal capacity of the system for aromatic hydrocarbons.

As discussed in sections of the report describing previous start-up period experiments, VOC removal efficiency is not solely a function of nutrient level but it is also influenced by the quantity of active biomass established on biofilter packing material. On days 16 and 205, the biofilters had similar inorganic nitrogen levels (as g N/g foam) retained in the packing media. However, the total VOC removal efficiency was approximately 70% on day 16, and greater than 95% on day 205. The major difference between these two sampling points was the quantity of

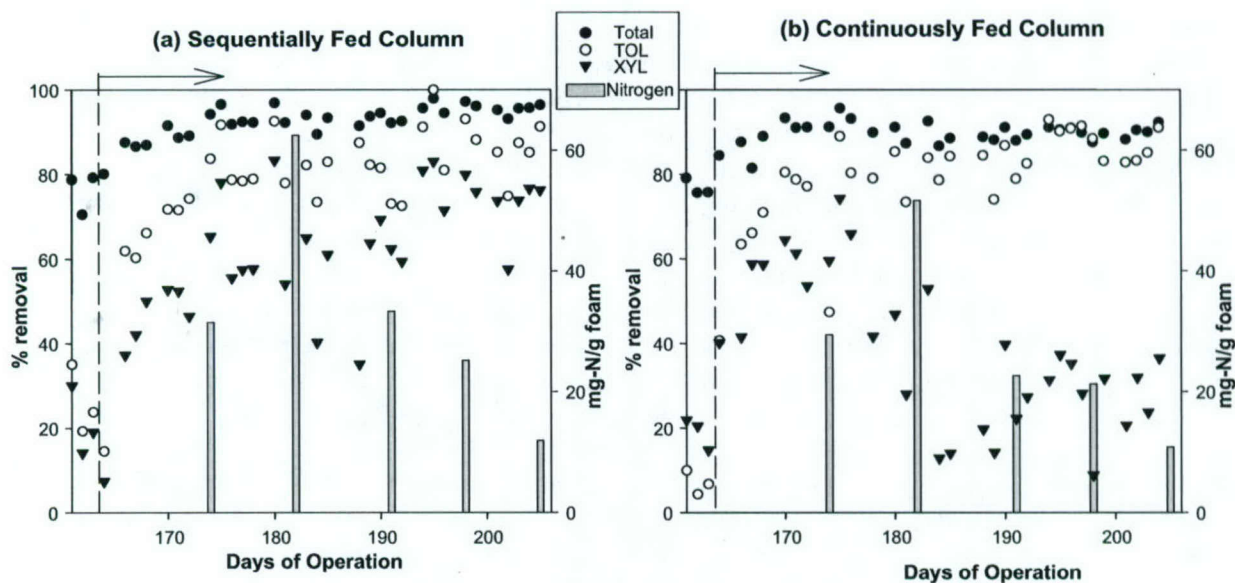

Figure 9-5. Effect of Nitrogen on VOC Removal Efficiencies. The Arrow Indicates When the Nitrogen Supply to the Bioreactors Was Resumed.

biomass established on the foam media in the column. The biomass quantity on day 205 was ten times greater than that present on day 16. More organic nitrogen was likely available for use by the microorganisms even though the inorganic nitrogen availability was similar between the two time periods. As discussed earlier in Chapter 4, as much as 56 % of the nitrogen needed by the microorganisms may be recycled from organic matter within the biofilm (Song, *et al.*, 2003).

9.2.3 Transient-Loading Experiments

Because transient-loading conditions are very common in field applications, biofilter performance needs to be stable even under conditions of frequent shutdown/restart events typical of paint booth operations. In this experiment, the response of the SFC and CFC biofilters to transient loadings was examined. In these experiments, each biofilter was fed VOC-contaminated air for 6 hours per day, 5 days per week, to simulate loading conditions under which paint off-gases are generated during only a fraction of each workday and no contaminants are generated during weekend shutdown periods. During the time intervals when no VOCs were provided to the biofilters, each biofilter continued to receive humidified air at the same flow rate as it did during periods in which VOCs were supplied. In addition to the 18-hour shutdown each day, three different shutdown periods (*i.e.*, weekend, an extended weekend, and a long-term shutdown) were investigated during this experiment. The results of these experiments are summarized in Figure 9-6. Each data point in Figure 9-6 is the average VOC removal efficiency observed over the 6 hours per day when the biofilters were operating. The first day of the transient experiments with the intermittent biotrickling filters is designated as Day 1 in Figure 9-6. Prior to these experiments, the SFC and CFC systems had been continuously operating for more than 200 days.

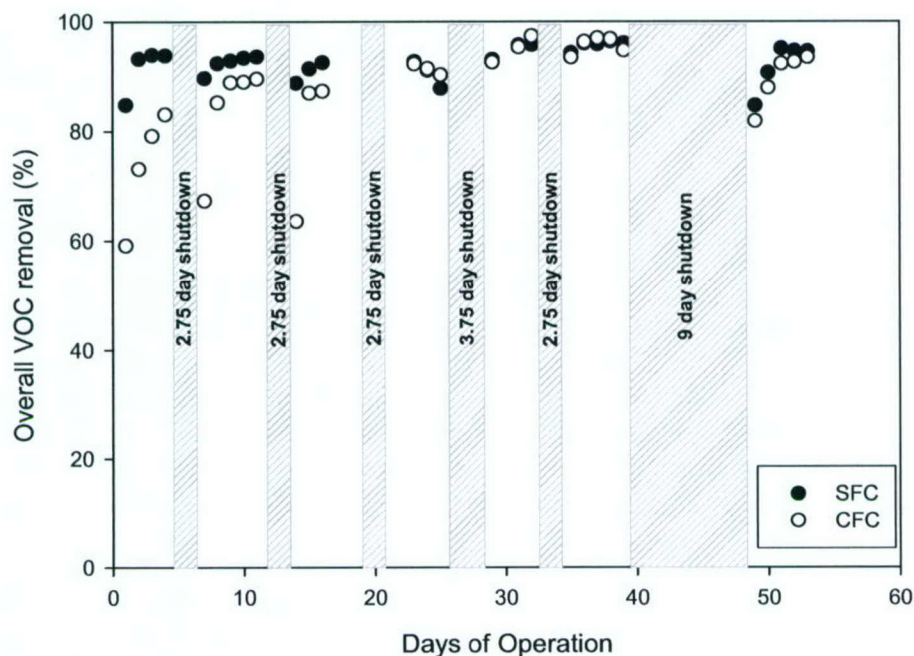

Figure 9-6. VOC Removal Efficiencies Observed during the Transient Loading Experiments.

The results presented in Figure 9-6 indicate that the SFC biofilter was more resilient to transient-loading conditions than the CFC biofilter at the beginning of the transient experiments. The SFC biofilter achieved higher MPK and toluene removals and significantly greater xylene degradation than the CFC biofilter. The higher xylene removal in the SFC was not surprising given that the xylene removal in this reactor was greater than that in the CFC during the continuous feed experiments. It is interesting to note, however, that the SFC recovered MPK and toluene removal much more rapidly following each shutdown period than the CFC even though both the SFC and CFC columns had similar MPK and toluene removal efficiencies prior to the beginning of the transient-feed experiments. This result suggests that the sequential-feeding strategy enriched the microbial population capable of degrading MPK and toluene in the SFC biofilter and provided the SFC with an initial advantage during the transient-feed experiments. However, the differences in the VOC removal efficiencies between the two bioreactor columns became smaller as both columns acclimated to operating under transient-loading conditions. The results of each shutdown experiment are described in further detail below.

Weekend-Shutdown Experiment (2.75 days). The VOC loading to each bioreactor was discontinued for a period of 2.75 days to simulate a weekend shutdown event. Following the shutdown period, the SFC achieved 90% removal of the paint mixture one hour following restart of the VOC feed but the removal efficiency dropped to 50% during the second hour (data not shown). The initially high removal efficiency may have resulted from absorption of MPK during the first hour of operation. After MPK equilibrated with liquid in the column, greater MPK breakthrough was observed over the next hour until the MPK biodegradation rate in the column recovered. An overall removal efficiency of 90% was achieved within 3 hours of restart, similar to results reported by Moe and Qi (2004). In contrast, the recovery of the CFC was not nearly as rapid, and the CFC achieved only 60% VOC removal in the six hours following column restart.

After each bioreactor had been supplied with a VOC feed for 6 hrs, no organic chemical feed was provided to either column for the next 18 hrs. The biofilter was then provided with the surrogate paint VOC mixture again for six hours. The SFC sustained greater than 90 % removal of the paint mixture over the entire six-hour VOC feed period on the second day following the weekend shutdown experiment. The CFC biofilter also recovered its pollutant-degrading capacity, though more slowly, eventually achieving greater than 80 % removal of the paint mixture by the end of the second day.

Extended Weekend Shutdown Experiment (3.75 days). After the biofilters had been operated with intermittent chemical feeding for 25 days (*i.e.*, 6 hrs per day, 5 days per week), the biofilters were subjected to an extended 3.75-day shutdown period. Since both biofilters had been operating under transient-loading conditions for the 25 days prior to this shutdown experiment, the columns were more resilient to shutdown/restart events. Both the SFC and CFC biofilters removed greater than 90 % of the paint mixture immediately after column restart, and this high removal efficiency was maintained throughout the day when the chemical feed was resupplied following shutdown.

Long-Term Shutdown Experiment (9 days). The response of the biofilter to a longer, 9-day shutdown period was also investigated. Such a shutdown period may occur in full-scale applications as a result of system maintenance or changes in painting schedules. Even though the initial VOC removal efficiency was slightly lower (85% and 70% in the SFC and CFCs, respectively) in the long-term shutdown experiment than in the shorter shutdown experiments, both biofilters recovered their pollutant degrading capacity relatively quickly. It is interesting to note that the initial response on day 49 following the 9-day shutdown period was better than that observed on day 7 following the 3-day shutdown period. These results suggest that microbial populations in biofilters can adapt to transient-loading conditions and that the initial response of the biofilters following shutdown periods can improve over time.

9.2.4 DGGE Analysis of the Bioreactor Microbial Community

Biofilm samples were collected periodically from the biofilters to assess how the microbial population community structure changed as a function of acclimation method, spatial location within each column, and operating time. A polymerase chain reaction (PCR) denaturing gradient gel electrophoresis (DGGE) method was used to monitor both the bacterial and fungal populations in the biofilters. Bacterial populations were analyzed using the eubacterial 341f primer with a GC clamp and the universal 907r primer in PCR to amplify small-subunit 16S rDNA gene fragments. The fungal primers NS5 and NS6 were used in PCR to amplify 18S rRNA gene fragments from fungi (Muyzer, 1993; Teske, 1996; and White *et al.*, 1990).

Figure 9-7 presents an image of a DGGE gel containing PCR products originating from both the SFC and the CFC on Days 58 and 269 of bioreactor operation. A DGGE profile of the mixed microbial culture used to inoculate the bioreactors is also provided on each gel for comparison purposes. To compare the microbial populations in a pairwise manner, Dice's coefficients were calculated based on the number of bands common in DGGE lanes (Omar, 2000; Li *et al.*, 2003). A similarity matrix was then developed using the Dice coefficients for the DGGE band patterns on Day 58 and Day 269 for samples collected from each bioreactor section in the SFC and the CFC (data not shown).

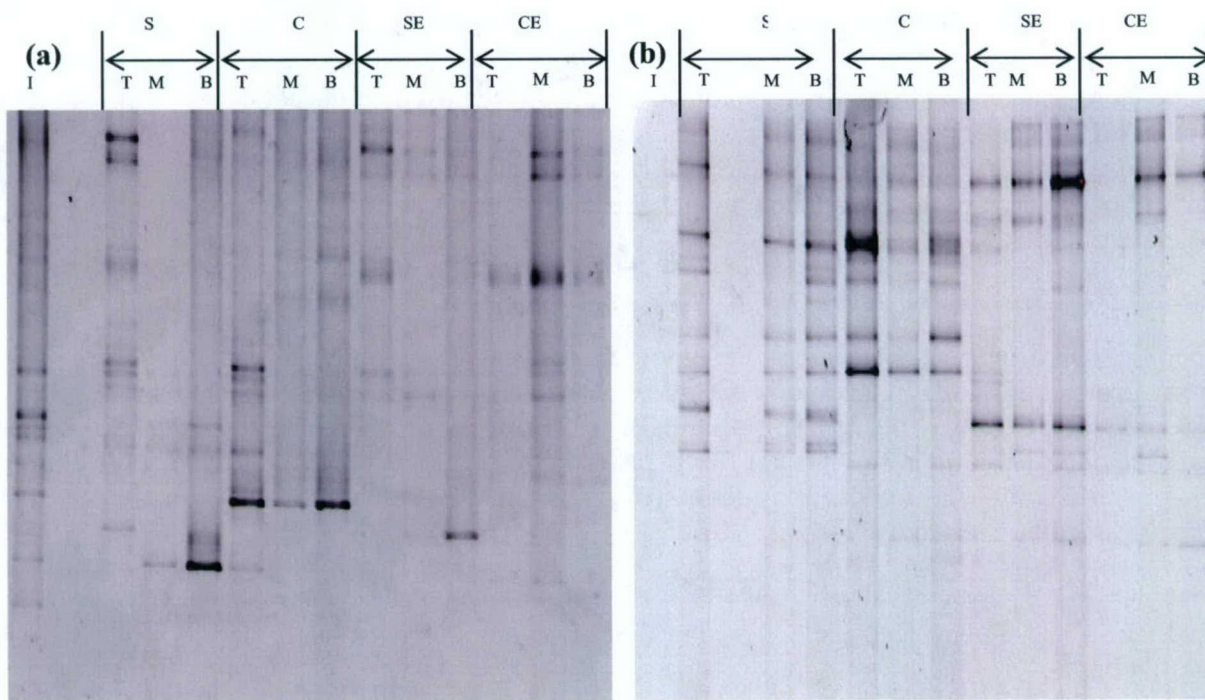

Figure 9-7. DGGE Gel Images of PCR Products from the Bacterial Population (a) and Fungal Population (b) in Biofilm Samples Collected from the Sequentially Fed Column (SFC) and the Continuously Fed Column (CFC) on Day 58 and Day 269 of Bioreactor Operation. (Note: I: Inoculum, S: SFC on Day 58, C: CFC on Day 58, SE: SFC on Day 269, CE: CFC on Day 269, T: Top Biofilter Section, M: Middle Biofilter Section, B: Bottom Biofilter Section)

The DGGE results indicate that appreciable spatial variability occurred in the bacterial population composition within the SFC and CFC bioreactor columns. The fungal population community structure was more uniform as a function of spatial location in the columns. The DGGE analyses reveal that the initial culture used to inoculate the biofilters was diverse and predominantly bacterial (11 bacterial bands versus 1 fungal band detected). However, a substantial shift in composition of the bacterial population occurred after the bioreactors were operated for 58 days. For example, seven of the eleven bacterial bands detected in the inoculation culture were no longer present after 58 days of operation and seven new bacterial bands were observed in the top section of the SFC by this point in time of operation.

Substantial temporal shifts were observed in the bacterial population within the biofilters over the next 200 days of operation while the fungal population was found to be more stable with time. That is, approximately, 46% of the bacterial species detected at the beginning of biofilter operation were also present after nearly one year of operation in the sequentially fed column and only 31% were still present in the continuously fed column. In contrast, 60 to 70% of the fungal species detected via DGGE remained at the end of the experiments in the sequentially fed and continuously fed columns. These results indicate that the feeding strategy employed during the acclimation period provided a selective pressure that shifted the composition of the bacterial

community within the bioreactors over time. The fungal community, on the other hand, appears to have established itself relatively early in the bioreactor operation and apparently was less affected by operational history of the bioreactor column, at least over the conditions tested in this study. Regardless, the stability of VOC removal observed in these intermittent biotrickling filter experiments indicate that a diverse consortia is capable of degrading the paint VOCs and changes in the composition of this population did not appear to have a significant effect on bioreactor operation.

9.2.5 Empty-Bed Contact Time and Elimination capacity (EC) Tests

To assess performance of the intermittent biotrickling filters over a range of operating conditions, a series of EBCT experiments were conducted at several different pollutant concentrations. Due to the mechanical limits of the airflow system available to supply the laboratory-scale biofilter, the shortest EBCT tested in this experiment was 15 seconds. Figure 9-8 summarizes the VOC removal profiles across each bioreactor column at each experimental loading condition tested.

At a 30-sec EBCT, the CFC achieved 100 % overall VOC removal of a 10-ppm_v feed, 95 % removal of a 100-ppm_v feed and 83% removal of a 200-ppm_v feed. At a 15-sec EBCT, the CFC biofilter removed 98 % of a 10-ppm_v VOC feed. When the inlet concentration was increased to 100 ppm_v at a 15-sec EBCT (which yields an inlet loading similar to that when 200 ppm_v was provided at a 30-sec EBCT), the overall VOC removal was approximately 80%. When the biofilter was supplied with 300 ppm_v of VOC at a 15-sec EBCT, approximately 70 % of the inlet VOCs were removed. In terms of overall VOC removal efficiency, these two different EBCT experiments yielded similar VOC removal efficiencies at similar inlet VOC loadings. However, higher inlet concentrations yielded a more exponential degradation pattern (data not shown) due to the increase in the concentration gradient force, which improves pollutant removal in the biofilters. The VOC removal observed in the SFC was quite similar to that observed in the CFC, indicating that at this point in the operation of the biofilters (*e.g.*, 270 days of operation), neither biofilter provided any advantage with respect to VOC removal efficiency at shorter EBCTs.

The elimination capacity of each biofilter as a function VOC load is summarized in Figure 9-9. The data presented in this figure include all the data obtained at the three different EBCTs and the range of VOC concentrations examined in these experiments.

No significant differences in the *EC* curves for the 30-sec and 15-sec EBCTs were observed in the SFC and the CFC for loads up to 70 g-C/m³-hr. These results indicate that the foam intermittent biotrickling filter can successfully treat paint VOC mixtures within the operating range tested in this experiment. Bioreactor performance was acceptable even with low residence time (EBCT 15 sec) for VOC concentrations ranging from 10 to 100 ppm_v.

I. Continuously Fed Column

(a) EBCT: 30 sec

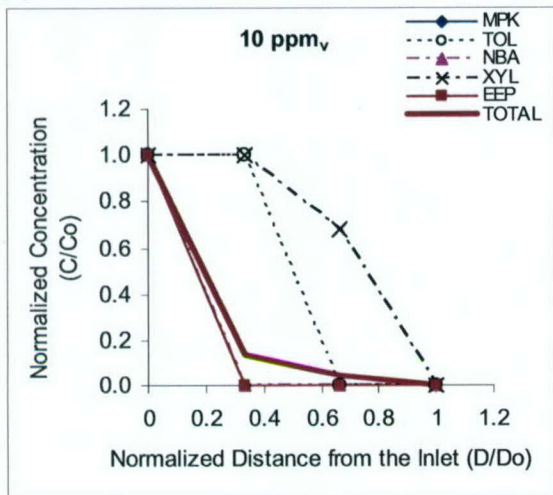

(b) EBCT: 15 sec

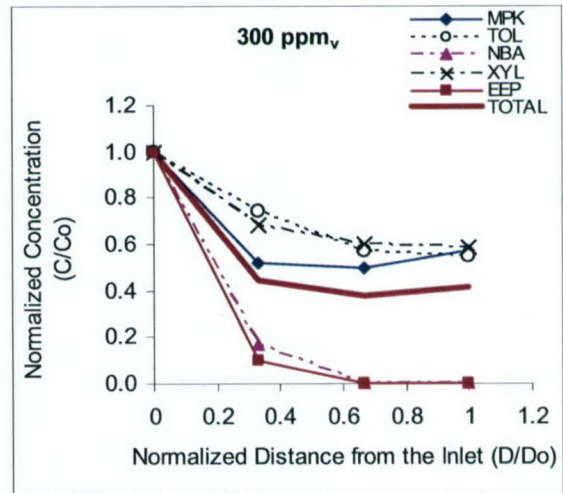
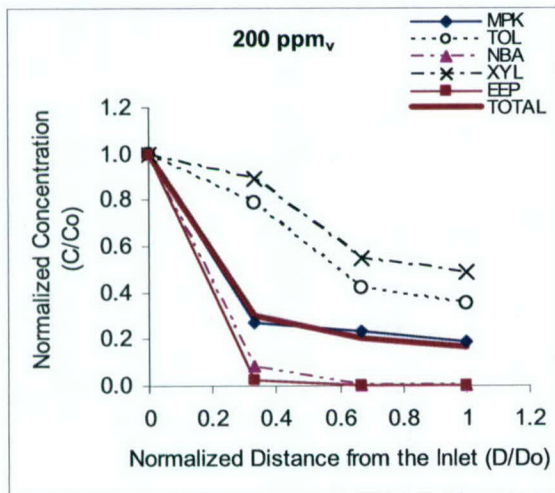
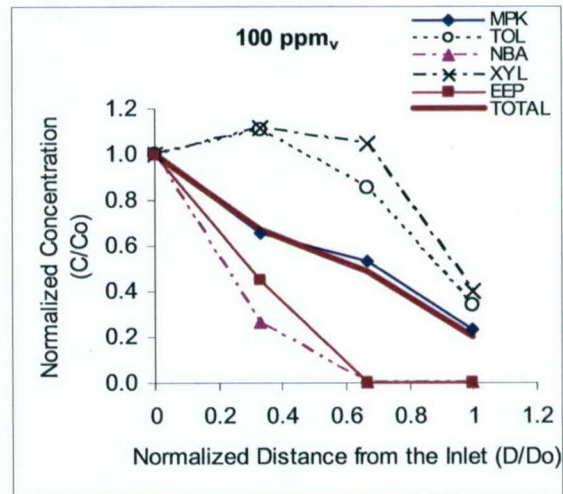
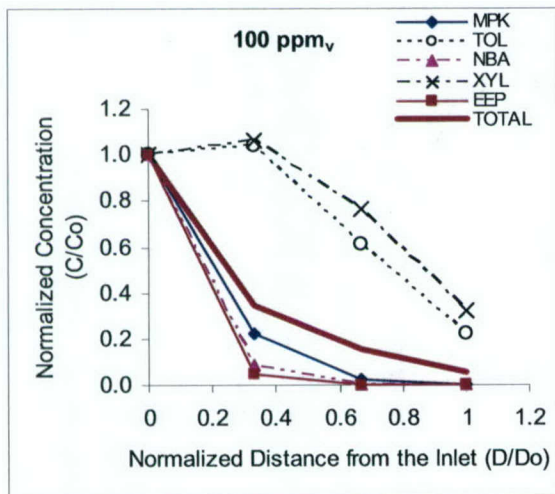
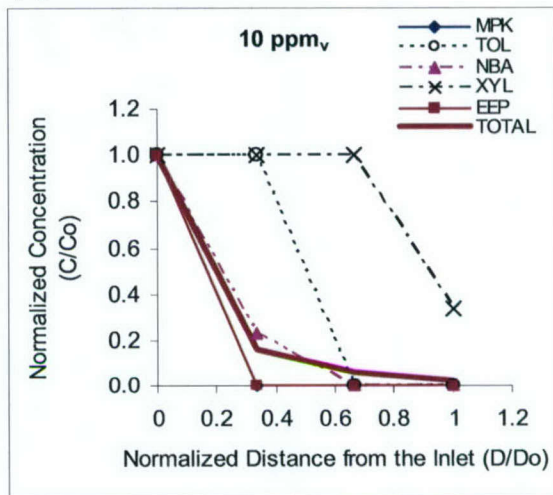

II. Sequentially Fed Column.

(a) EBCT: 30 sec

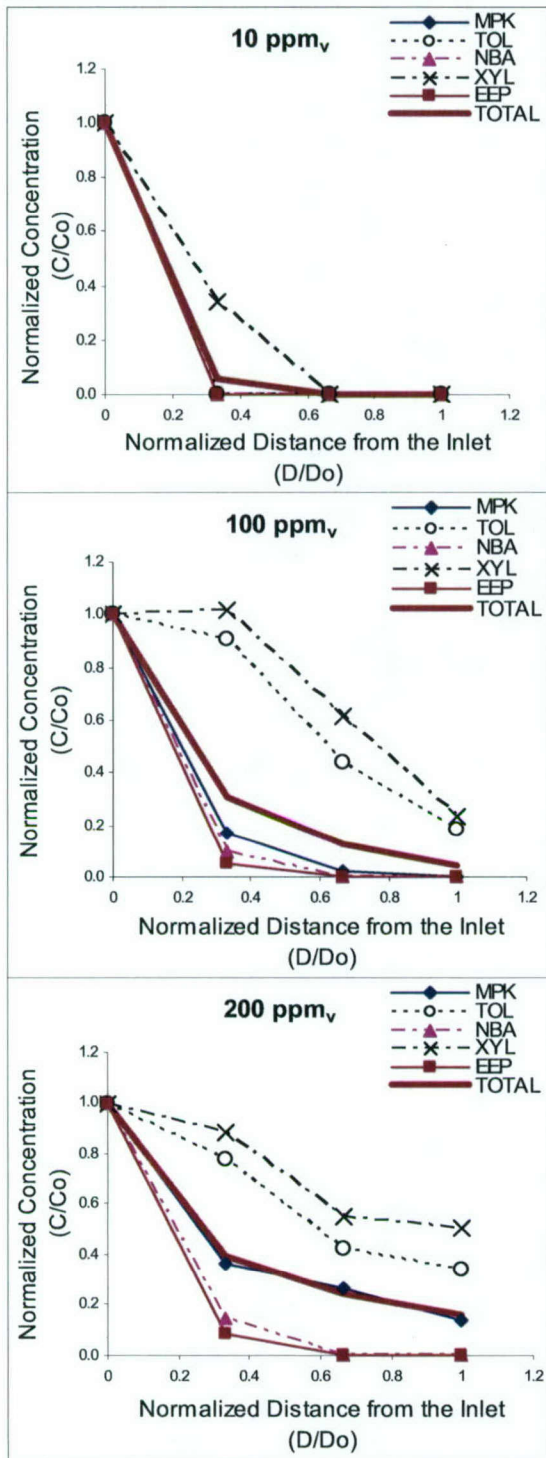

(b) EBCT: 15 sec

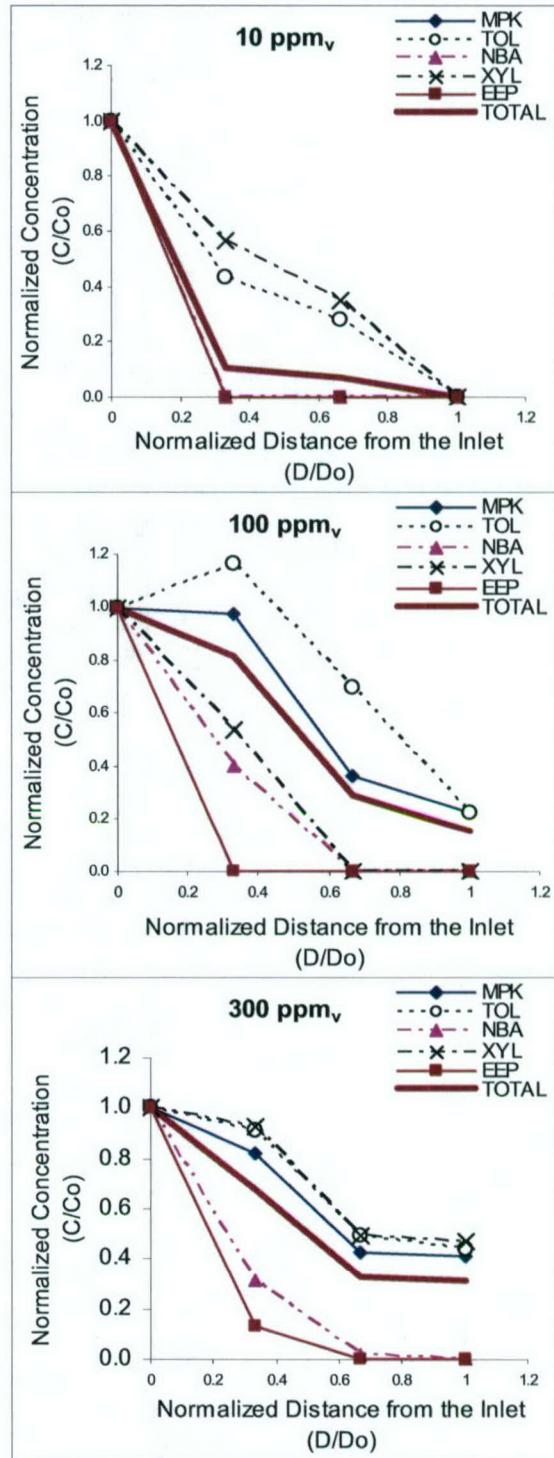

Figure 9-8. VOC Removal Profiles in the Continuously Fed Column (I) and the Sequentially Fed Column (II) at a 30-sec and 15-sec EBCT. The Total Inlet VOC Concentration Is Indicated at the Top of Each Figure.

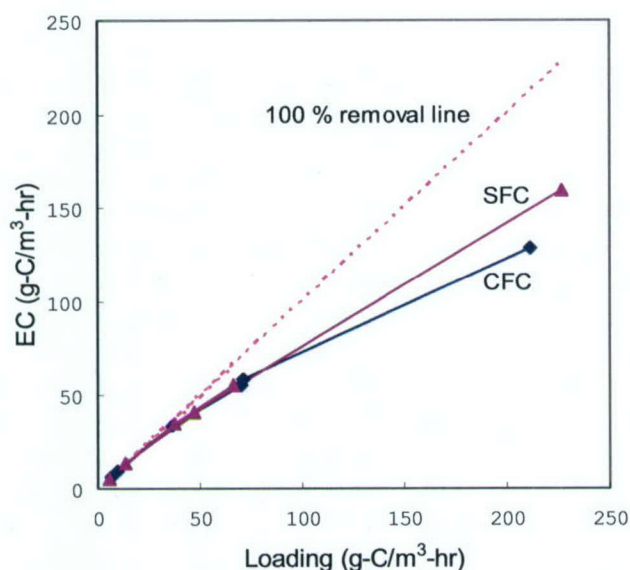

Figure 9-9. Elimination Capacity of the Continuously Fed and Sequentially Fed Columns As a Function of VOC Loading Rate at a 15-sec and 30-sec EBCT.

9.3 Summary and Conclusions

A series of experiments were conducted to assess the long-term performance of an intermittent biotrickling filter and to better understand the effects of inoculation method and acclimation history on VOC degradation patterns. The results indicate that the intermittent biotrickling filter can achieve high paint VOC removal efficiencies but, as observed with other bioreactor configurations investigated, the supply of nutrients must be maintained within an acceptable range to achieve rapid bioreactor start-up. In particular, the nutrient recirculation period must be sufficient to ensure that the nitrogen supply is well distributed through the bioreactor packing material. Nitrogen limitation affected the initial biodegradation capacity in the bioreactors; the aromatic compounds (toluene and xylene) were the most sensitive among the five paint VOC components. The sequential feeding strategy did not appear to provide any initial advantage with respect to VOC removal; however, that system ultimately achieved higher aromatic hydrocarbon degrading capacity.

Analysis of the microbial population indicates that once the microbial community was established in the bioreactors following start up, the intermittent biotrickling filter sustained VOC removals of 90 to 95%. Nevertheless, significant temporal and spatial shifts were observed in the bacterial population within the bioreactors although the fungal population was found to be more stable.

Overall, performance of the biotrickling filter system was found to be acceptable for EBCTs as low as 15 seconds when the VOC concentration ranging from 10 to 100 ppm_v. The intermittent biotrickling filters were also quite resilient to transient-loading conditions and tolerated shutdown periods up to 9 days. These results indicate that an intermittent biotrickling filter has the potential to be an effective treatment system for paint spray booth operations. Pilot-scale evaluation of this bioreactor design is described in the next chapter.

CHAPTER 10: PILOT-SCALE EVALUATION OF BIOFILTRATION TECHNOLOGY

Actual paint spray booth operations generate waste gases containing VOC mixtures that vary in concentration and composition over short time periods. Paint booths at DoD facilities also operate intermittently and typically shut down during evenings and weekends. Paint booth emissions thus pose a real challenge to biofilters since biological treatment systems often have more difficulty treating intermittent waste streams containing complex mixtures of pollutants. The laboratory-scale studies discussed in the previous chapters laid the foundation for determining the capabilities of biofiltration technology to treat paint spray booth emissions. Nevertheless, a series of pilot-scale experiments were necessary to assess the ability of biofiltration technology to treat actual paint emissions under the challenging conditions expected in the field. To this end, performance of a pilot-scale, intermittent biotrickling filter treating actual paint emissions on an intermittent basis was investigated. Scale-up issues such as bioreactor start-up procedures as well as slip-feed design were also addressed in the pilot-scale studies described below.

10.1 Materials and Methods

A pilot-scale bioreactor was constructed for this phase of the study as illustrated in Figures 10-1 and 10-2. The basic design of the pilot-scale bioreactor was based on the intermittent biotrickling filter system used in the previous laboratory-scale study (see Chapter 9). The pilot-scale bioreactor consisted of a stainless steel column with an inner diameter of 0.61 m and a total



Figure 10-1. Photograph of the Pilot-scale Bioreactor.

height of 3.25 m. The column was divided into three sections. The bottom section served as a nutrient sump, the top section housed the nutrient spray distribution system, and the middle section was packed with 444 L of polyurethane foam cubes (5 cm per side). To humidify the air entering the biofilter, a humidifier (0.15 m inner diameter, 1.97 m total height) was constructed. The humidifier was packed with 5/8-in pall rings (total packed volume 22.2 L) through which tap water was continuously recirculated at a rate of 2 gal/min.

A scaled-down paint booth was constructed to feed actual paint spray emissions to the biofilter (see Figure 10-3). The paint booth consisted of a paint spray gun housed in a duct through which air continuously flowed at a rate of 24 scfm. The VOC-laden exhaust stream exiting from the paint booth was pre-filtered

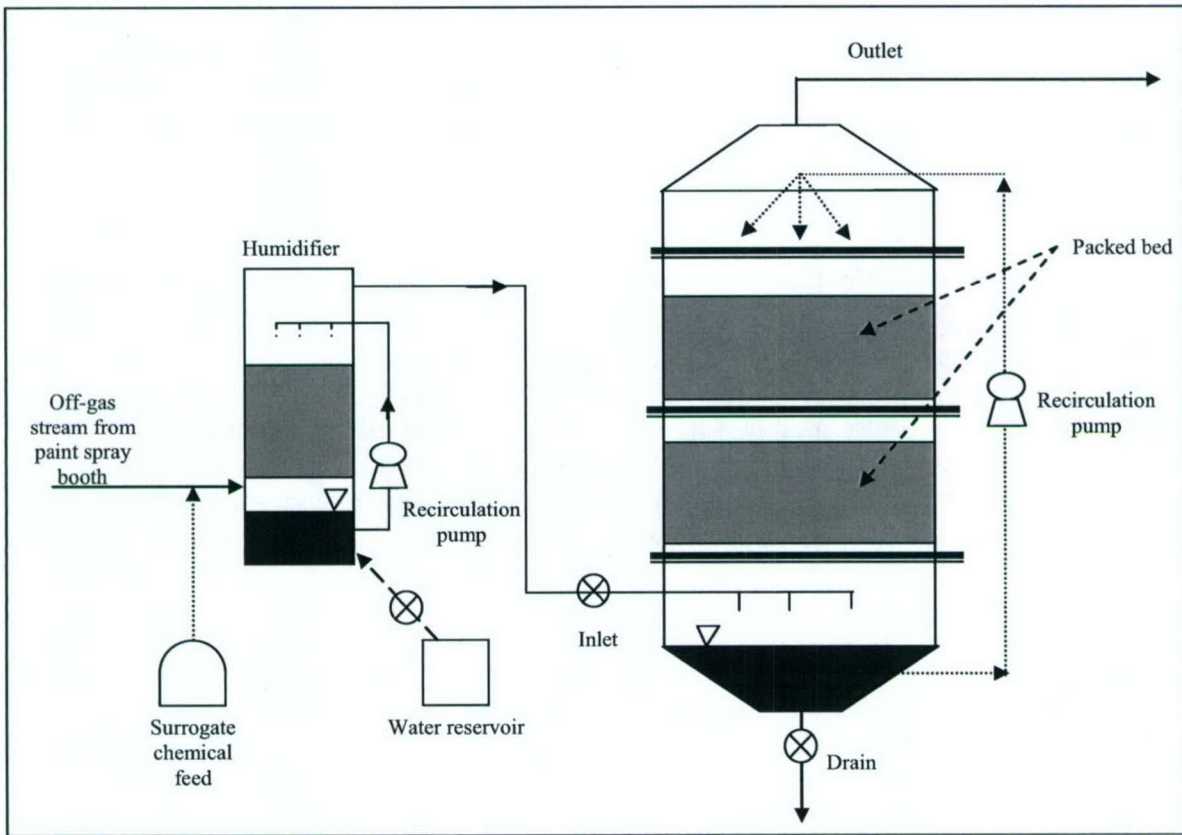

Figure 10-2. Schematic Diagram of the Pilot-scale Bioreactor.

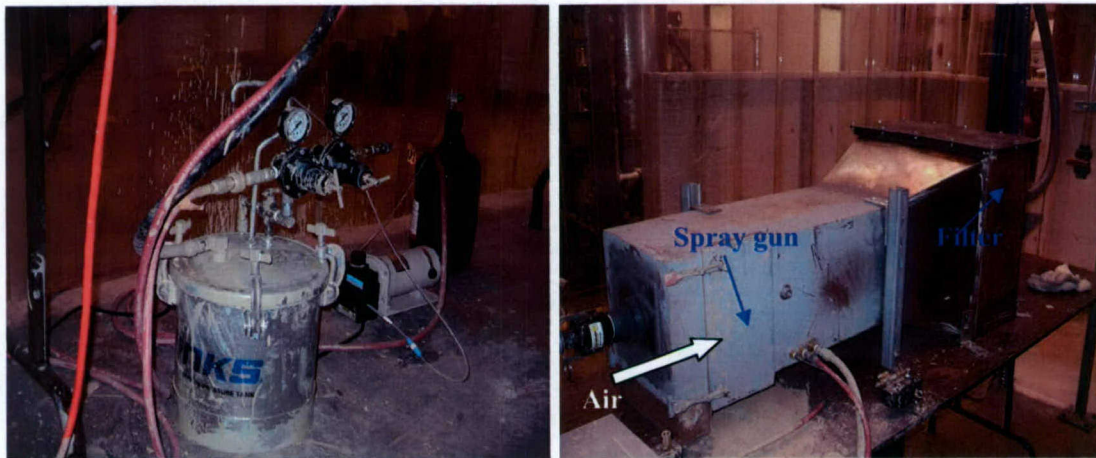

Figure 10-3. Paint Booth System Used in Pilot-scale Tests (Left: Paint Kettle; Right: Paint Spray Duct)

(Chemco, Inc., HI Solids 2 Pad) to remove particulate matter and then ducted to the humidifier unit located immediately upstream of the biofilter. The quantity and rate of paint sprayed through the atomizing paint nozzle was controlled by regulating the pressure of a paint kettle that contained a mixture of paint and paint thinner. The frequency of the paint spray was controlled by a switch that was programmed to supply paint to the paint gun at 10-second intervals when the paint booth was “operating.”

10.1.1 Paint-Thinner Mixture

Several factors were considered when selecting the types of paint used in the pilot-scale study. First, the paint selected had to have an adequate “pot-life”—the time period that the paint could be sprayed from the paint kettle before it hardened and could not be sprayed further. A pot life of at least 6 hours was necessary to feasibly run the pilot test without excessive changes of the paint kettle and cleaning of the paint gun. One paint that was considered for use in the study (MIL-SPEC C-22750) was found to be infeasible because it hardened within 1 to 4 hours of being put in the kettle, and it was expected to irreversibly clog the paint gun. Second, the paint selected needed to be used extensively in DoD maintenance operations and contain the VOCs most commonly found in paint VOC mixtures at such facilities. Discussions with painting personnel at Ft. Hood, Texas, indicated that the tan paint selected for use in this study is a very common paint (Ft. Hood, 2003). Furthermore, inspection of Material Safety Data Sheet (MSDS) information and emission inventory data from Ft. Hood and Anniston Army Depot as well as paint booth emissions data obtained from Tyndall AFB indicated that the major VOCs emitted from paint booths at these facilities are found in the paint selected for study. The third consideration was that the composition of the paint should be one likely to prove challenging to biofiltration technology to assure that adequate performance could be achieved even with unfavorable paint formulations.

The paint selected for testing contained 3.5 lbs VOC per gallon, which is higher than the 1.5 lbs VOC per gallon required in low-VOC paints. Also, the paint thinner selected contained both xylene and toluene, components that were found to be the most recalcitrant to biodegradation in the previous biofilter studies. The paint was mixed with this thinner in a 3:1 ratio to ensure that aromatic hydrocarbon emissions were included in sufficiently high concentrations to challenge the capabilities of the pilot-scale biofilter and also to prevent the scaled-down paint gun from clogging. Table 10-1 summarizes the physical and chemical properties of the paint and thinners used in the pilot-scale study. The VOC composition of the paint and thinner are presented separately in Table 10-2.

TABLE 10-1. PHYSICAL AND CHEMICAL PROPERTIES OF THE PAINT AND THINNER USED IN THE PILOT-SCALE STUDY.

Property	Paint	Thinner
Evaporation rate (<i>n</i> -Butyl acetate = 1)	1.6	5.6
Vapor pressure (mm Hg)	15	74
Vapor density (g/L)	4	4.6
VOC (lb/gal)	3.494	7.424
VOC (g/L)	418.68	889.61
Weight per gallon (lb/gal)	10.1491	7.4329
Specific gravity	1.219	0.892

10.1.2 Inoculation

To establish an effective biofilm within the pilot-scale biofilter during startup, the bioreactor was initially inoculated with microbial cultures capable of degrading the key constituents found in paint VOC emissions. Because of the VOC composition of the paint tested, one microbial culture (initially obtained from another bioreactor treating a mixture of paint VOCs) was grown with 100 mg-C/L methyl isoamyl ketone (MIAK) as the sole carbon and energy source. As shown in Table 10-2, MIAK is the ketone found in the highest fraction in the paint used in the pilot study. Also, because laboratory-scale studies indicated that aromatic compounds are the most difficult components to degrade in the paint VOC mixture, a separate aromatic-degrading culture was developed using leachate derived from a separate laboratory-scale bioreactor treating benzene, toluene, ethylbenzene and *o*-, *m*-, and *p*-xylenes (BTEX).

TABLE 10-2. PROPERTIES OF THE VOCS FOUND IN THE PAINT AND THINNER USED IN THE PILOT-SCALE STUDY.

Paint (Tan 686A zenthane, Mil-C-53039A)					
Compound	CAS #	MW	Density(g/mL)	% (by weight)	
Methyl isoamyl ketone (MIAK)	110-12-3	114.187	0.814	25.325	
Methyl amyl ketone (MAK)	110-43-0	114.187	0.815	1.164	
Methyl isobutyl ketone (MIBK)	108-10-1	100.16	0.7978	4.461	
<i>n</i> -Butyl acetate (NBA)	123-86-4	116.16	0.882	1.261	
Thinner (Type I, MIL-T-81772B)					
Compound	CAS #	MW	Density(g/mL)	% (by weight)	
Toluene	108-88-3	92.15	0.8996	11.787	
Xylene	13330-20-7	318.501	0.862	6.774	
Ethylbenzene (EB)	100-41-4	106.167	0.867	0.986	
<i>n</i> -Butyl acetate (NBA)	123-86-4	116.16	0.882	9.9	
Methoxypropyl acetate (MA)	108-65-6	132.159	0.969	43.427	
Methyl ethyl ketone (MEK)	78-93-3	72.1066	0.805	27.115	

The aromatic-degrading culture was grown up in the presence of 100 mg-C/L each of BTEX as the carbon and energy source. After the MIAK-degrading culture and the aromatic-degrading culture could degrade repeated injections of the VOCs, these two cultures were mixed together and transferred to the sump of the pilot-scale bioreactor. The 40 L of inoculating culture was recirculated through the bioreactor for 12 hrs prior to starting waste gas feed to the bioreactor.

10.1.3 Bioreactor Operation

The pilot-scale bioreactor was operated as an intermittent biotrickling filter as described earlier in Chapter 9. The total gas flow rate through the system was maintained at 24.5 scfm, which corresponds to an empty-bed contact time of 38 seconds in the biotrickling filter column. A nutrient solution (10.1 g/L KNO₃, 1.36 g/L KH₂PO₄, 0.71 g/L Na₂HPO₄, 0.66 g/L (NH₄)₂HPO₄) was intermittently recirculated through the bioreactor at a rate of 8 gal/min using the nutrient spray distribution system located at the top of the foam packing material. The nutrient solution was recirculated through the foam packing for intervals lasting 30 to 40 minutes at a frequency of two to three times per day. Once per week, half of the nutrient solution in the column was

replaced with fresh nutrient solution. The intermittent biotrickling filter was initially fed the surrogate VOC mixture for approximately one month prior to treating the actual paint off-gas stream (See Table 10-3). During the painting experiment, the biofilter was provided a waste gas stream from the paint spray booth for 6 hours per day, 5 days per week. During the time interval (18 hours per day) when no VOCs were supplied to the biofilter, the biofilter received only humidified air at the same air flow rate (off period).

TABLE 10-3. COMPOSITION OF THE SURROGATE VOC FEED DURING START-UP PERIOD.

Day	Average VOC concentration, ppm _v			Total VOC
	Toluene	<i>n</i> -Butyl acetate (NBA)	<i>p</i> -Xylene	
0-20	39	26	41	106
21-25	58		81	140
26-34	112			112

10.1.4 Analytical Techniques

The VOC composition of the inlet and outlet gas stream into the pilot bioreactor was monitored by gas chromatography as described earlier in Section 9.1. Seven major VOC components of the paint waste gas stream were monitored throughout the experiments. Other trace components in the waste gas stream were found to be present at negligible quantities. To confirm the VOC composition, a few gas samples were collected in Suma canisters and sent to a commercial lab (EMSL Analytical, Westmont, N.J.) for analysis by Gas Chromatography/Mass Spectrometry (GC/MS). Results of these analyses indicate that the composition of the waste gas as determined by GC/FID was consistent with that observed by GC/MS analysis and reported in the MSDSs for paint and thinner used in the experiments.

To measure the concentrations of heavy metals that may accumulate in the bioreactor unit during painting operations (*e.g.*, from pigments), liquid samples were collected from the bioreactor sump as well as from the humidifier. The samples were submitted to EMSL Analytical for chromium analysis since chromium was the only heavy metal found in the paint used in this study. Results indicate that the chromium concentration in the humidifier water after nearly one month of painting was only 0.087 mg/L; the chromium concentration in the bioreactor sump was below the detection limit of 0.010 mg/L.

Nitrogen (NO₃⁻-N and NH₄⁺-N) and biomass (COD) concentrations in the bioreactor packing material were determined using the techniques outlined previously in Chapter 9. The pH of the bioreactor leachate was also monitored as described earlier. Finally, the gas flowrate, column pressure drop as well as liquid levels in the bioreactor sump and humidifier unit were also monitored throughout bioreactor operation.

10.2 Results

10.2.1 Bioreactor Start-up Period

To facilitate biomass establishment on the biofilter's foam packing medium prior to transient painting experiments, the pilot-scale biofilter was continuously supplied with a surrogate waste gas stream containing toluene, *p*-xylene, and/or *n*-butyl acetate for the initial 34 days of operation (See Table 10-3). As observed in the laboratory-scale biofilters treating a similar surrogate paint mixture (see Section 9.2), complete removal of *n*-butyl acetate and poor removal of the aromatic compounds was initially observed. That is, only approximately 30% of the inlet xylene was removed and between 30 to 70% of the toluene was degraded. The overall VOC removal efficiencies ranged between 30 and 70% during this period.

The relatively low VOC removal initially observed in the pilot-scale bioreactor was likely due to the fact that insufficient biomass had established itself on the biofilter packing media during this startup period. On day 28, only approximately 35 mg COD/g-foam was present on the foam packing in the pilot bioreactor. In the previous laboratory-scale experiments discussed in Chapter 9, overall VOC removal was only 70% when the biomass quantity on the foam was approximately 50 mg COD/g-foam. Thus, the overall VOC removals initially observed in the pilot reactor are consistent with those expected when relatively low biomass quantities are present in the bioreactor. However, the previous laboratory-scale results also suggested that higher biomass quantities, nutrient hold-up, and ultimately VOC removals would be expected when the ketone components of the waste gas stream were introduced to the bioreactor. Thus, even though removal efficiency of aromatic compounds was relatively low (60% of the inlet toluene and 30% of the inlet *p*-xylene) at the end of the startup period, the actual paint spraying experiment was initiated in the bioreactor because the aromatic compounds constitute only a small fraction of the paint VOC mixtures (less than ~10% by mass).

10.2.2 Phase I: Baseline Paint Spraying Experiments: (Day 1–Day 8)

After the biofilter had been continuously supplied with *n*-butyl acetate, *p*-xylene, and toluene for approximately one month, the biofilter was fed the off-gas stream from actual paint spraying operations for 6 hours per day. Because ketone compounds made up the highest fraction of the waste gas stream and the biofilter had not been pre-acclimated to this compound during the startup phase, the ketone removal efficiency in the bioreactor was low for the first few days of painting operation. To improve the bioreactor performance, fresh nutrients were provided to the column and the system was provided with a supplemental slip feed. The merits of using a supplemental (slip-feed) system to improve bioreactor performance were demonstrated earlier in a laboratory-scale biofilter (see Chapter 4).

In such a slip-feed system, a surrogate carbon source is added to the biofilter during the off period when air but no waste gas VOCs are passing through the biofilter. In the previous slip-feed experiments with laboratory-scale bioreactors, a small quantity of a surrogate carbon source was supplied continuously to the biofilter in the gas phase during the shutdown period. However, this feed method required additional feed lines that add to the complexity of the biofilter system. For this reason, the design of the slip-feed system was modified during the pilot-scale tests. That is, a single spike of a surrogate carbon source was added to the liquid nutrient medium that was recirculated through the biofilter during the booth-off period. In this case, a total of 6 g of methyl isoamyl ketone, MIAK, (as carbon) was injected once as a neat

liquid into the bioreactor sump during the 18-hour period when no paint emissions were provided to the bioreactor. MIAK was selected for the slip feed because it constituted the greatest fraction of the paint off-gas stream.

Figure 10-4 summarizes the VOC removal efficiency observed in the bioreactor over the 6-hour operational period the next day. The biofilter recovered ketone degradation activity and achieved approximately 90% removal of the total VOC mixture by the end of the 6-hour painting period (Figure 10-4 and Table 10-4).

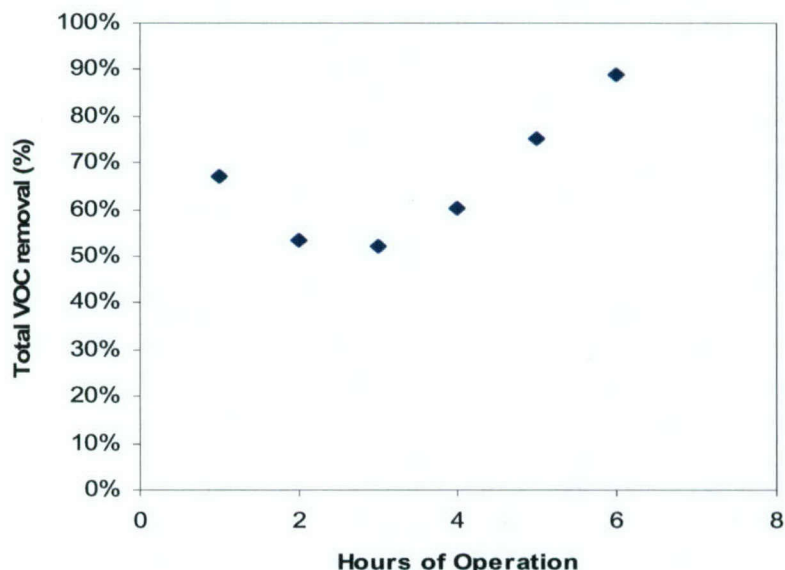

Figure 10-4. Removal of paint VOCs in the bioreactor during the third day of painting operations. (Note: Fresh nutrients and an MIAK spike were added to the bioreactor during the 18-hour off period preceding the beginning of painting operations, denoted as time zero)

Table 10-4. Speciated VOC removal during the sixth hour of painting operations on Day 3.

Compound	Concentration (ppm _v)		% VOC Removal
	Inlet	Outlet	
MEK	15.51	0.00	100.00%
MIBK	5.70	0.77	86.44%
Toluene	4.64	1.52	67.16%
NBA	3.44	0.00	100.00%
MIAK	24.65	2.79	88.69%
<i>p</i> -xylene	2.25	1.24	44.72%
MAK	1.01	0.00	100.00%
Total VOCs	57.21	6.33	88.94%

Table 10-5 summarizes the VOC removals observed on Day 4 (two days after the MIAK spike had been added to the bioreactor). Unlike the Day 3 results shown in Figure 10-4, the VOC removal efficiency during the first and second hour of paint spraying remained stable (data not shown) indicating that the biodegradation capabilities of the bioreactor had improved.

Table 10-5. Average VOC removal efficiency during the 6-hour painting period on Day 4 of painting operations.

Compound	Concentration (ppm _v)		% VOC Removal
	Inlet	Outlet	
MEK	12.69	0.00	100.00%
MIBK	2.51	0.00	100.00%
Toluene	0.68	0.14	79.09%
NBA	2.27	0.00	100.00%
MIAK	11.07	0.00	100.00%
<i>p</i> -xylene	1.45	1.04	27.85%
MAK	0.02	0.00	100.00%
Total VOCs	30.69	1.19	96.14%

During the following weekend (Days 5 and 6), no paint was sprayed; however, a surrogate VOC stream including 8 g-C/m³-hr of *n*-butyl acetate and 4 g-C/m³-hr of toluene was supplied to the column to see if this combination of VOCs could maintain biomass activity during the shutdown period. A single spike of 12 g-C of MIAK liquid was also added to the column sump during the weekend shutdown. Table 10-6 summarizes VOC removals observed in the biofilter two hours after resuming a 200-ppm_v paint spray feed to the biofilter following the weekend shutdown period. Since the biofilter had been supplied with toluene throughout the weekend, higher removals of the aromatic compounds toluene and xylene were observed. However, relatively low removal of the ketone constituents of the waste gas stream was also observed suggesting that the single MIAK spike was insufficient to maintain biomass activity over a weekend shutdown period. The column seemed to require a longer time to recover ketone degradation activity after the weekend shutdown than it did following its daily 18-hour shutdown; however, due to a mechanical clogging problem with the paint spray gun, the system was not further observed on that day. Thus, the length of time needed to fully recover ketone degradation was not determined.

TABLE 10-6. VOC REMOVAL TWO HOURS AFTER RESUMING PAINTING OPERATIONS FOLLOWING A WEEKEND SHUTDOWN.

Compound	Concentration (ppm _v)		% VOC Removal
	Inlet	Outlet	
MEK	47.42	14.57	69.28%
MIBK	18.47	5.12	72.25%
Toluene	6.62	0.48	92.71%
NBA	16.66	0.00	100.00%
MIAK	100.61	38.46	61.77%
<i>p</i> -xylene	16.75	2.45	85.36%
MAK	1.19	0.00	100.00%
Total VOCs	207.72	61.09	70.59%

10.2.3 Phase II: Paint Spraying Experiments (No MIAK Slip Feed; Days 11–15)

Following the weekend shutdown period (Days 9 and 10) when small amounts of toluene and MIAK were provided to the biofilter as a slip stream, the biofilter was operated for six hours per day treating paint spray emissions followed by an 18-hr off period when only air was provided to the biofilter. The response of the biofilter during the paint spray feed period is summarized in Figure 10-5 for Days 11 through 15 of operation. During this period of operation, no MIAK was supplied during the daily off period. As evident in the figure, the biofilter initially had difficulty removing the paint mixture. This likely resulted because it had been provided only a small quantity of MIAK during the weekend shutdown period. In fact, the MIAK spike added to the biofilter sump during the weekend shutdown period was completely consumed within two hours. Nevertheless, the ketone degradation capacity of the bioreactor recovered by the second day following the weekend shutdown, and an overall VOC removal efficiency of 85 % was achieved. However, this removal was not maintained over the next few days of operation (see Figure 10-5) most likely due to the short operating period (*i.e.*, 6 hours per day) that the bioreactor was actually provided a carbon source. These results suggest that it will likely be necessary to employ a slip-feed system to maintain VOC degradation activity in the biofilter during the booth off periods, at least during startup, in applications where higher removal efficiencies are required.

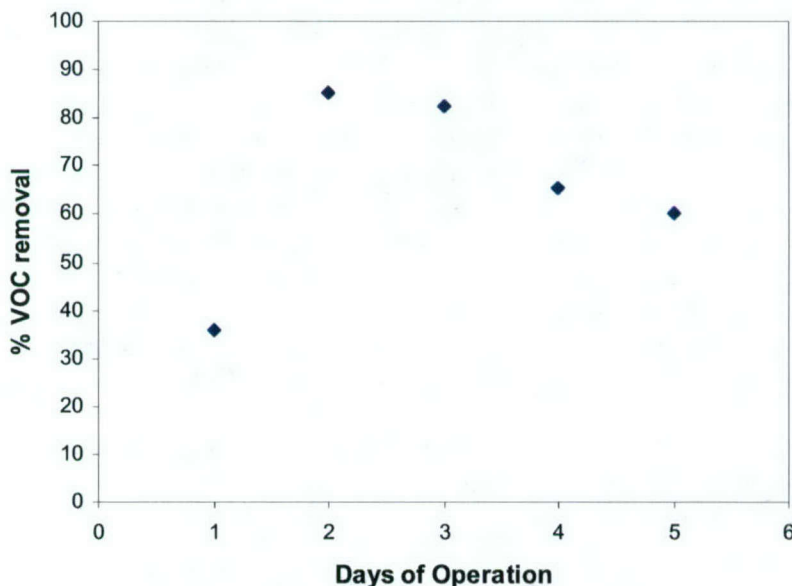

Figure 10-5. Overall VOC Removal Efficiencies in the Biofilter When No MIAK Slip Feed Was Provided during the Booth Off-period.

10.2.4 Phase III: Paint Spraying Experiments (MIAK Slip Feed Provided; Days 28–38)

Due to technical problems in the paint spray booth, the operation of the paint spray booth was discontinued for approximately 10 days following the Phase II experiments described above. During this period, a surrogate paint mixture consisting of toluene, methyl isoamyl ketone

(MIAK), and *p*-xylene was supplied to the biofilter (data not shown). Following this surrogate feeding period, the biofilter was again exposed to the off-gas stream from the paint spray booth for Phase III experiments. The paint spray booth was operated for 6 hours per day, 5 days per week in a manner that mimicked actual paint spray booth operation. Figure 10-6 shows the overall VOC removal efficiency obtained throughout this phase of the experiments.

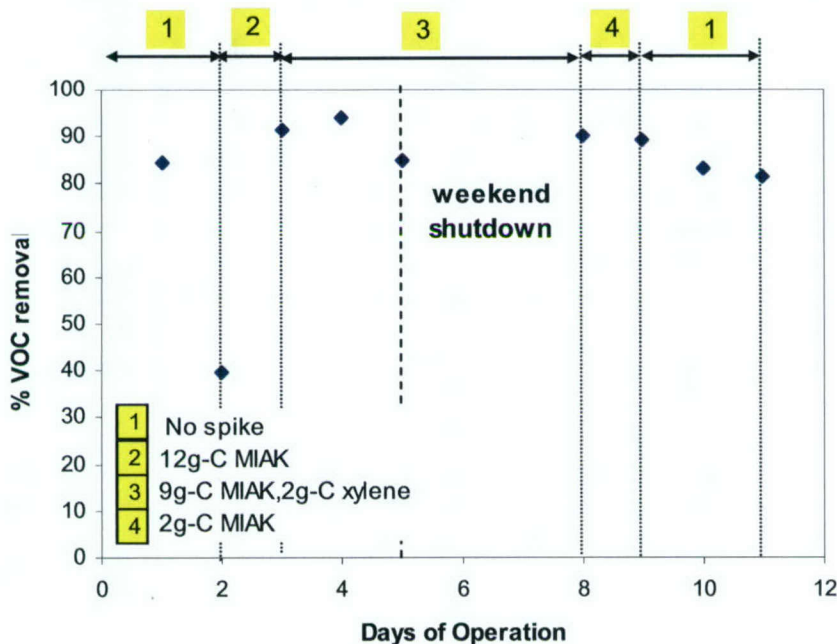

Figure 10-6. VOC Removal during the Phase III paint Spraying Experiments. (Note: the MIAK Provided during the Shutdown Period Is Indicated in the Legend)

As shown in Figure 10-6, the initial response of the biofilter with respect to removal of actual paint VOCs was quite rapid (*i.e.*, ~85% VOC removal). Biofilter performance was not adversely affected by the 18 hours of starvation prior to the painting experiments, since the biofilter had been continuously supplied with a surrogate paint VOC mixture for approximately 10 days prior to the 18-hr starvation period. However, during the next 18-hour off period, the biofilter lost its VOC degradation capacity and the average VOC removal during the next 6 hours of painting (Day 2 in Figure 10-6) was only 40%. The short period of carbon supply (*i.e.*, 6 hours with a carbon source and 18 hours without a carbon source) was insufficient to maintain the VOC degradation activity of microorganisms in the biofilter. To overcome this activity loss in the microbial population, a slip-feed system was introduced during the off period of biofilter operation. As can be seen in Figure 10-6, injection of 12 g-C MIAK liquid into the recirculating nutrient solution during the off period increased the VOC removal efficiency to over 90% when the biofilter was restarted the next day.

The mass of the MIAK spike provided during the off period was varied to determine whether it had a strong effect on the effectiveness of the slip-feed system. Results demonstrated that VOC spikes as low as 2 g were sufficient to maintain microbial biodegradation activity. Biofilter response was rapid when the system was re-exposed to the VOC-laden waste gas stream

following the 18-hour paint booth off period. Interestingly, a daily MIAK spike during the weekend shutdown period was sufficient to maintain VOC degradation activity in the biofilter following the weekend shutdown, while a one-time injection of MIAK spike over the weekend shutdown period during the paint spray experiments in Phase II was not sufficient to maintain VOC degradation activity. This cannot be readily explained aside from the fact that it may have been due to the quantity of active biomass in the system.

The quantity of biomass present in the foam packing material during Phase III experiments (*e.g.*, 140 mg COD/g-foam) was nearly double that present during the Phase II experiments. To determine whether increased biomass alone or the MIAK slip-feed system was responsible for the improvement in the biofilter performance observed during the Phase III experiments, no MIAK spike was provided during the last two days of the experiments. The overall VOC removal efficiency decreased over time after the MIAK spike was discontinued indicating that the MIAK slip-feed system was important to maintain the biodegradation capacity in the biofilter. This result conflicts somewhat with the results obtained in the laboratory-scale biofilter, where a slip-feed system was not required to maintain high VOC removal efficiencies during booth shutdown periods (see Section 9.2.3). One possible reason for this discrepancy is that the biomass quantity in the pilot-scale biofilter at the time of the Phase III experiments was only half of that present in the laboratory-scale system, which had been operating for almost 200 days. The laboratory-scale biofilter experiment also indicated that biomass quantity is strongly related to nutrient retention capacity and overall VOC removal achievable in the system. These results suggest that as additional biomass is established in the pilot-scale biofilter with time, more stable VOC removal can be expected and the external slip feed may not be necessary.

10.2.5 Biofilter Response as a Function of VOC Concentration

Since the quantity of VOCs emitted from the paint spray booth varied greatly depending on even slight changes to the paint spray gun controller, VOC loading to biofilter varied widely during the pilot biofilter experiments. Thus, these emissions mimic the widely varying emissions from actual paint spray booths. Nevertheless, it was of interest to determine how the pilot biofilter responded to high and low concentrations of paint VOCs. Table 10-7 presents the average VOC removal observed in the biofilter when the paint VOC emissions were low (*i.e.*, less than 15 ppm_v total). As evident from the table, nearly all of the VOCs generated from the paint spray booth operation were degraded in the biofilter except for the aromatics toluene and xylene.

Table 10-7. Average VOC Removal Efficiency during the 6-Hour Painting Period on Day 31 of Operation.

Compound	Concentration (ppm _v)		% VOC removal
	Inlet	Outlet	
MEK	4.75	0.00	100.0%
MIBK	1.45	0.00	100.0%
Toluene	0.50	0.17	66.7%
NBA	1.39	0.00	100.0%
MIAK	4.82	0.00	100.0%
<i>p</i> -xylene	1.01	0.67	33.2%
MAK	0.02	0.00	100.0%
Total VOC	13.94	0.84	94.0%

High VOC removals (*i.e.*, greater than 90%) were achieved when the biofilter treated paint spray emissions with low inlet concentrations (*i.e.*, less than 15 ppm_v). Approximately 80% of the total VOCs applied to the biofilter were degraded (see Figure 10-7) in the first section of the biofilter.

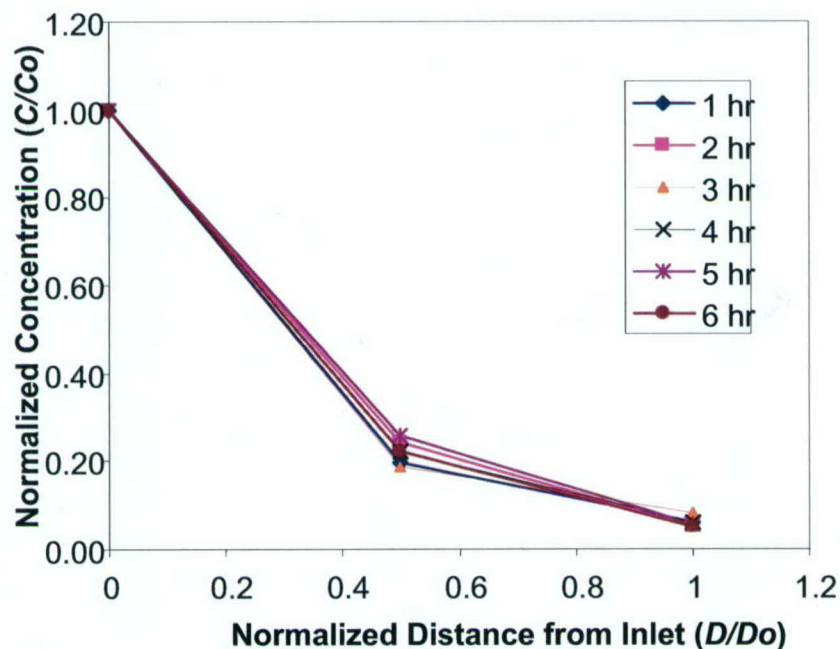

Figure 10-7. VOC Removal Profile across the Bioreactor Treating a 14-ppmv Inlet Concentration on Day 31 of Operation.

The biofilter could also achieve reasonable removal of paint VOCs while treating high concentrations of VOCs (Table 10-8 and Figure 10-8).

TABLE 10-8. AVERAGE VOC REMOVAL EFFICIENCY DURING THE 6-HOUR PAINTING PERIOD ON DAY 32 OF OPERATION.

Compounds	Concentration (ppm _v)		% VOC removal
	Inlet	Outlet	
MEK	43.53	0.45	99.0%
MIBK	13.10	1.60	87.8%
Toluene	3.78	2.25	40.6%
NBA	8.88	0.00	100.0%
MIAK	51.47	8.83	82.8%
<i>p</i> -xylene	7.19	6.18	14.0%
MAK	0.48	0.00	100.0%
Total VOC	128.42	19.31	85.0%

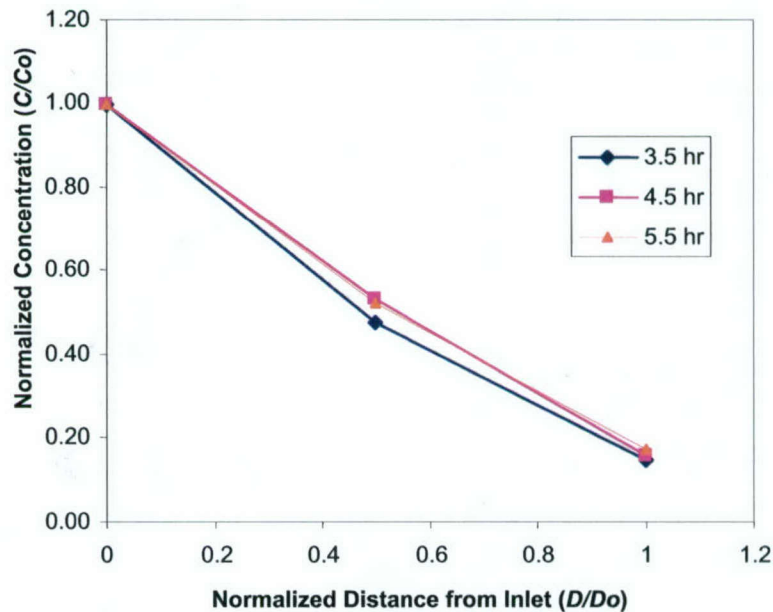

Figure 10-8. VOC Removal Profile across the Bioreactor Treating VOCs with a Total Inlet Concentration of 128 ppm_v on Day 32 of Operation.

These results indicate that within the range of VOC concentrations tested, the biofilter could successfully degrade paint VOC mixtures under realistic feed conditions. Generally, the biofilter could easily degrade mixtures of ketone compounds and acetates without any evidence of strong substrate inhibitions. Just as was observed in the lab-scale tests, however, biodegradation of the aromatic hydrocarbons was much lower than the other VOCs. The ratio of the concentration of the aromatic hydrocarbons to the total of all VOCs in the paint emissions, however, was relatively low and thus the biofilter still achieved high VOC removals overall in spite of the low removal for aromatics.

10.3 Summary and Conclusions

The feasibility of biofiltration for paint spray booth applications was investigated in the pilot-scale bioreactor under realistic feeding conditions. The results observed in this experiment are summarized as follows:

- The off-gas stream from the paint spray booth contained a mixture of ketones, which were successfully degraded in the biofilter
- Degradation of aromatic compounds such as toluene and xylene limited the overall VOC removal obtainable by the biofilter treating paint emissions.

- Until the biofilm is strongly established on the packing media in the biofilter, a surrogate carbon supply (slip stream) is necessary during the off period to maintain the VOC degradation activity of the microorganism in the biofilter under transient feeding conditions.
- Within the VOC concentration ranges tested (10 ppm_v to 200 ppm_v); the biofilter can achieve reasonable VOC removals of greater than 85% under realistic feeding conditions in which the inlet VOC concentrations vary daily and hourly.
- Depending on the treatment goal, the bioreactor can be configured as two separate bioreactor columns in series. The first bioreactor would be inoculated and maintained for the degradation of the ketone constituents of the waste gas stream and the second bioreactor could be inoculated and maintained to sustain the aromatic hydrocarbon degrading population. This segregation of the microbial culture may enhance the aromatic degradation since the slip feed to the bioreactor can be optimized for each bioreactor individually.

CHAPTER 11: ENGINEERING ASSESSMENT AND DESIGN RECOMMENDATIONS

A comprehensive series of laboratory-scale and pilot-scale experiments have been completed to assess the feasibility of biofiltration technology for paint spray booth applications. As described in the previous chapters, multiple bioreactor configurations, design features and microbial inocula have been evaluated. Results of these experiments have laid the foundation necessary to assess the technical and economic feasibility of biofiltration technology for treating VOC emissions associated with painting operations at Department of Defense facilities. The key performance criteria considered for the engineering and economic assessment provided in this chapter include the following:

- VOC removal efficiency;
- Gas-phase residence time and bioreactor size requirements;
- Bioreactor response to transient VOC feed conditions;
- Biomass establishment and bioreactor startup requirements;
- Bioreactor operational stability and maintenance requirements; and
- Economic evaluation of biofiltration technology in comparison to selected abiotic control processes.

An engineering assessment of the technology and summary of recommended design parameters for biofiltration of paint waste gas streams is presented in Section 11.1. A cost analysis conducted to determine the economic feasibility of the recommended design for full-scale systems is presented in Section 11.2.

11.1 Technical Considerations

VOC removal is an important consideration in biofiltration systems, as are the design, operational and maintenance requirements of biofilter units. One consideration that sets biofilters apart from abiotic control technologies is the necessity to establish sufficient biomass in the bioreactor before high pollutant removal rates can be achieved. Similarly, response of these biological systems to intermittent feed conditions must be considered if they are to be used to treat the emissions from paint spray booths.

A wide range of different bioreactor configurations and design features were investigated in this study. These included biofilters, biotrickling filters, and hybrid bioreactor systems. All of the bioreactor configurations investigated proved capable of achieving VOC removal efficiencies in excess of 90%. In addition to the particular bioreactor configuration utilized, several key parameters such as nutrient supply and biofilm establishment were found to control the performance of the biofiltration systems. The following sections identify these key parameters and provide a technical evaluation of biofilter technology for paint booth applications. In addition, recommended design and operating parameters for this application are summarized.

11.1.1 VOC Removal Efficiency

Results of extensive laboratory-scale tests conducted as part of this research project indicate that the VOC mixtures commonly found in paint are biodegradable. Removals as high as 98% were achieved for 10–200 ppm_v inlet VOC concentrations in laboratory-scale bioreactors ranging in design from a classic biotrickling filter to a foam, intermittent biotrickling filter system. Removal efficiencies of 90 to 95% were typical for off-gas streams with total inlet VOC concentrations on the order of 100 to 200 ppm_v and empty-bed contact times on the order of 30 seconds to 1 minute. VOC concentrations of this magnitude would be expected from a paint booth if the paint off-gas stream has been preconcentrated via recirculation of the booth air (see Section 2.1) or via an alternate method. Actual VOC concentrations from paint booths without preconcentration systems are generally expected to be lower (*e.g.*, below 20 to 50 ppm_v) except for occasional peaks that may transiently occur when high volumes of paint are being applied. As the inlet VOC concentration to the bioreactor is lowered, higher VOC removal efficiencies are expected at lower empty-bed contact times. For instance, at a 10 ppm_v total inlet VOC concentration, a VOC removal efficiency of 99% was achieved at empty-bed contact times as low as 15 seconds in the foam, intermittent biotrickling filter (see Figure 9-8).

Regardless of the particular bioreactor configuration investigated or the original inocula utilized (*i.e.*, fungal or bacterial), the following VOC degradation order was consistently observed in the bioreactors: (1) acetate and propionate compounds, (2) ketone species, and (3) aromatic hydrocarbons. Mass transfer limitations due to high Henry's Law constants and low solubility has been hypothesized as a reason for the low removal rate of aromatic hydrocarbons near the inlet of biofilters treating VOC mixtures; however, experiments demonstrating that toluene can be rapidly removed when other constituents (*e.g.*, ethyl acetate or ketones) are absent (Deshusses *et al.*, 1999; Park *et al.*, 2002; Song *et al.*, 2002) suggest that substrate inhibition or catabolic repression likely occurs in systems treating mixtures of ketones or esters and toluene. Such substrate interactions likely played a role in the VOC degradation patterns observed in many of the biofilter configurations evaluated in the current study. These results suggest that the biodegradation of such compounds as toluene and *p*-xylene was inhibited by the presence of other readily degradable constituents (*e.g.*, methyl propyl ketone). Interestingly, the reverse did not appear to be true; that is, the biodegradation of methyl propyl ketone, *n*-butyl acetate and ethyl 3-ethoxypropionate was not substantially influenced by the presence of the aromatic compounds, at least not in the tests conducted with the hybrid bioreactor (Chapter 9).

Since the aromatic hydrocarbon constituents of the waste gas stream were found to be the most difficult to remove, the fraction of the paint off-gas that is composed of aromatic hydrocarbons will ultimately determine the overall removal efficiency achievable in the bioreactor systems. Aromatic hydrocarbons such as toluene and xylene are generally found in paint thinner products. Depending on the type of paint being sprayed and the paint gun being used, the quantity of thinner required (if any) will vary and thus the aromatic hydrocarbon makeup of the waste gas will vary from paint booth to paint booth. Ideally, it would be best to limit usage of paint and thinner products that contain appreciable fractions of aromatic hydrocarbons because these compounds are more slowly degraded than other solvent components. Regardless, effective biofilter treatment of the waste gas stream is still possible. These constituents generally comprise only a small fraction of the paint VOC mixture and they can be degraded in bioreactors even if the degradation rate is slower than for more-readily degraded compounds like ketones.

Although high VOC removals were achieved in all the biofilter configurations evaluated in this study, lower removal efficiencies occurred during bioreactor start-up and during periods of nitrogen limitation or bed drying (see Section 11.1.5 below). As a result of these periods of lower VOC removal efficiency, treatment goals and permit requirements must be considered when deciding whether a biofiltration system is applicable to a particular paint booth. Regulations that require greater than 95% VOC removal at all times, for instance, would be difficult to meet with a biological treatment system such as biofiltration unless a backup system is provided for periods when the bioreactor is not operating optimally. On the other hand, a treatment goal that is based on a moderate VOC removal efficiency (e.g., 75 to 90%) averaged over a monthly (or weekly) period, or one based on the total mass of VOCs removed could be readily achieved using biofiltration technology. Such mass-based treatment goals would apply, for instance, at a facility that would like to keep its total HAP emissions below the 10-tons-per-year single-HAP limit or the 25-tons-per-year mixed-HAPs limit. At some point in the future, paint booths in ozone non-attainment areas of the country may also be able to sell their VOC reductions as emission credits to other facilities.

11.1.2 Bioreactor Size Requirements and Gas-Phase Residence Time

The size of the bioreactor required to treat the waste gas flow from a particular paint booth operation will depend on several factors including waste gas flow rate, paint composition, paint usage rate, pollutant elimination capacity, and treatment goal (e.g., minimum removal efficiency on a continuous basis or average long-term removal rate). Although several approaches can be used to size biofilter units, one approach for sizing units is described below. This approach would be useful for cases where average removal efficiency over long time intervals is the overall treatment objective.

For most paint booth applications, the gas flow rate exiting the booth system (Q_{gas}) will likely be fixed for a given operation. The gas-phase residence time necessary to achieve the removal efficiency required for that particular application will need to be selected and, based on this information, the volume of the bioreactor packed bed can be determined using equation 11-1.

$$V_{bed} = Q_{gas} t_r \quad (11-1)$$

where: t_r = empty-bed contact time (sec);
 V_{bed} = volume of packed bed (m^3); and
 Q_{gas} = volumetric flow rate of gas to be treated (m^3/sec)

The pollutant loading rate to the bioreactor can then be calculated using equation 11-2.

$$L = \frac{C_i Q_{gas}}{V_{bed}} \quad (11-2)$$

where: L = pollutant loading rate (g pollutant / (m^3_{bed} hr));
 C_i = VOC concentration in paint booth waste gas stream (g/m^3); and
 Q_{gas} = volumetric flow rate of gas to be treated (m^3/hr)

Based on the experimental data collected in this study and others, several elimination capacity vs. pollutant loading curves have been generated. Based on the loading calculated in equation 11-2, the elimination capacity that can be expected can be determined from the experimental data. The removal efficiency (η) that is predicted for this pollutant loading rate and packed-bed volume can be determined from equation 11-3.

$$\eta = \left(\frac{EC}{L} \right) * 100\% \quad (11-3)$$

where: η = pollutant removal efficiency (%); and

EC = pollutant elimination capacity (g pollutant degraded / (m³_{bed} hr))

If the pollutant removal efficiency predicted for the system is not acceptable, a longer residence time (corresponding to a larger bioreactor vessel) should be selected and the process repeated. An example of this process is presented in Section 11.2 below.

Results from the laboratory and pilot-scale tests indicate that, depending on the influent VOC concentration, gas-phase residence times on the order of 15 seconds to 1 minute can yield high removal of the paint VOC mixtures (see Figure 9-8, for example). For paint booth emissions containing contaminant concentrations on the order of 10 ppm_v, a gas-phase residence time of 15 seconds was sufficient to achieve overall removal efficiency greater than 90%. Low VOC concentrations such as these will be expected from paint booths with high ventilation rates (*i.e.*, in booths without air recirculation). For VOC concentrations on the order of 100 ppm_v, EBCTs on the order of 30 seconds to 1 minute will often be necessary to achieve removal efficiencies in excess of 90%.

In cases where the treatment goal is based on a total mass emissions rate (*e.g.*, 25 tons per year combined HAPs), then it would likely be possible to achieve the treatment goal using a bioreactor with a much lower removal efficiency. This, of course, will be site specific and will depend on overall paint composition and annual usage rates. If the overall treatment objective can be met using lower removal efficiencies (*e.g.*, in the range of 60–80% removal), a biofilter's EBCT could be reduced to 15 seconds or perhaps lower, even for applications where higher VOC concentrations (>100 ppm_v) occur (*e.g.*, if the waste gas stream from the paint booth has been preconcentrated by retrofitting the booth to operate in recirculating mode). In cases where recirculating booths are employed, the VOC concentration in the waste gas stream will be higher, but the gas flow to be treated will be greatly reduced (*e.g.*, by a factor of 6 to 10). Longer gas residence times required for such an application will not necessarily result in excessively large bioreactor sizes because the gas flow rate to be treated will likely be much smaller.

Several elimination capacity (EC) versus pollutant loading rate (L) curves were developed as a result of this research project (see Figures 5-1, 5-2, 6-5 and 9-9, for example). For a given pollutant loading rate, these curves can be used to estimate the VOC elimination capacity possible in a biofilter system. As the pollutant loading rate increases, the pollutant elimination capacity increases up to a critical point and then eventually levels off at a maximum value (*i.e.*, maximum EC). Generally, designing a bioreactor at the pollutant loading rate corresponding to this maximum elimination capacity is not advisable because such high EC s may not be

sustainable over long-term operation. Also, as further discussed below, excess biomass accumulation can occur at high pollutant loading rates, and such systems have less capacity to handle sudden spikes in inlet concentration (because the actual residence time decreases even though the EBCT remains constant). Instead, a more conservative design approach is to select a pollutant loading rate that will yield an *EC* substantially lower than the maximum achievable (e.g., by a factor of 2) that is sustainable over longer-term operation. This approach readily allows a safety factor to be incorporated into the design. Examining the *EC* curves generated in the various studies conducted over the course of this project suggests that stable removal efficiencies on the order of 85 to >99% for total VOC loads up to 35 to 45 g/m³/hr can be sustainable for the surrogate paint VOC mixtures evaluated.

11.1.3 Bioreactor Startup and Biofilm Establishment

Unlike most abiotic treatment technologies, biological treatment systems such as biofilters can require a significant period of time following startup before consistent VOC removals can be achieved. In this research project, start-up times on the order of two to four weeks or more were generally required to establish the microbial community in the bioreactors to the point that high VOC removal rates could be sustained. Several parameters were found to affect biofilm establishment in these systems, including relative humidity of the inlet waste gas stream, nutrient supply, inoculum source and culture history, packing medium type, and VOC supply. Ensuring that the inlet gas stream is adequately humidified (e.g., >95% relative humidity) prior to entering the bioreactor is necessary to prevent the biofilm in the bioreactor from desiccating and being inactivated. In biotrickling filter systems inoculated with bacterial cultures, nutrient availability is also a key parameter that affects the start up of these systems. Nitrogen availability, in particular, was found to limit biofilm establishment on synthetic bioreactor packing materials evaluated in this study. Thus, a nutrient solution containing a relatively high concentration of readily available nitrogen should be well distributed through the bioreactor packing material during start-up.

Development of a diverse microbial inoculum capable of degrading all of the target pollutants present in the paint VOC mixture is also important for rapid start-up of the bioreactors. Because bioreactors packed with synthetic packing materials do not have an indigenous microbial population, they need to be inoculated with microorganisms capable of degrading the paint VOCs. For bacterial-based systems, activated sludge from a local wastewater treatment plant can be a useful starting point from which to develop an appropriate inoculum. This mixed undefined mixed culture can then be enriched for microbial populations capable of degrading target VOC components of the paint booth off-gas to be treated. Results of our inoculation experiments suggest that enriching the microbial culture separately for each key VOC component may be important for maintaining the diversity and biodegradation capabilities of the microbial population. This approach seemed to improve bioreactor performance during start-up, particularly with respect to removal of aromatic hydrocarbons. Nevertheless, the molecular monitoring (DGGE) results discussed in Chapter 9 and the fungal bioreactor results discussed in Chapter 7 indicate that the composition of the microbial population that ultimately establishes in the bioreactor can shift appreciably over time. Despite the dynamic nature of the microbial population structure, experimental results indicate that mixed microbial systems are able to sustain consistent VOC removals.

A final consideration during bioreactor start-up is the VOC loading that is provided to the bioreactor during the biofilm-establishment phase of operation. A continuous, steady VOC feed during bioreactor start-up may be desirable for establishing growth of biomass on the packing material. A bioreactor that is provided an intermittent VOC feed during startup will generally take longer to achieve high VOC removal efficiency. DoD paint booth emissions are generally intermittent in nature and highly variable in concentration, characteristics posing a challenge during biofilter start-up. One potential solution to this problem is to provide the bioreactor with a steady, surrogate VOC feed during the start-up period to establish biomass on packing material. The bioreactor can then be connected to the actual paint booth to treat the intermittent VOC emissions. This approach was used successfully in the pilot-scale experiments described in Chapter 10. In applying this technique, consideration should be given to the composition of the surrogate feed provided during start-up. It will generally be desirable to include the major VOC components expected in the waste gas stream as well as any difficult to degrade compounds (*e.g.*, aromatic hydrocarbons) that may be present in the waste gas to ensure that the system develops the capability to degrade these components.

11.1.4 Bioreactor Response to Transient VOC Feed Conditions

Once a robust biofilm is established in the bioreactors, these systems are generally relatively resilient to the intermittent VOC feed conditions expected from painting operations. For example, the laboratory-scale intermittent biotrickling filter adapted relatively quickly to a 6-hour-on, 18-hour-off feed schedule (see Figure 9-6) after the biofilm in the system was well established. However, in the pilot-scale system that was operated for a much shorter period of time before intermittent feed conditions were imposed, a slip-feed stream was necessary to maintain paint VOC removal during the daily and weekend shutdown periods.

Previous laboratory-scale experiments with a single-VOC feed stream indicated that a providing a surrogate, slip feed in the gas phase to the bioreactor can help to maintain biomass activity and speed recovery of VOC removal efficiency following restart of the primary VOC feed stream. However, in the pilot-scale system, a much simpler slip-feed system was utilized successfully to maintain VOC degradation capacity of the system. That is, a single liquid injection of the major VOC found in the paint emissions (*i.e.*, methyl isoamyl ketone) was provided to the sump of the bioreactor and recirculated with the nutrient solution during shutdown periods. Following resumption of painting operations (*i.e.*, re-start of contaminant loading), the bioreactor was able to degrade the paint VOC emissions quickly and sustain this degradation throughout the 6-hour booth operating period. Thus, slip-feed operation was found to be a useful tool for maintaining biomass activity in the bioreactor during periods when the primary VOC feed to the bioreactor was discontinued. Because paint booths typically only operate during the day and shut down at least some portion of the weekend, the ability to maintain biomass activity in a biofilter with a slip-feed system represents a potentially important advancement, and it would be beneficial to include the capability to provide a VOC slip feed in biofilter designs considered for paint spray booth applications in case it proves necessary. Results from extended-duration laboratory-scale bioreactor experiments suggest that after a thick biofilm has established on the packing material, use of a slip-feed system can probably be eliminated without adversely affecting bioreactor performance. In predominantly fungal biofilters, a slip feed may not be necessary since the systems tested in this research were found to be relatively resilient when subjected to intermittent feed conditions.

11.1.5 Bioreactor Operational Stability and Maintenance Requirements

Several key parameters should be monitored and controlled to sustain overall performance of a biofiltration system treating paint booth emissions. In addition to monitoring inlet and outlet VOC concentration in the gas stream, several other bioreactor parameters should be monitored. These parameters include *pH*, packing medium moisture content, nitrogen availability, biomass quantity, and pressure drop across the system. Each of these parameters is discussed briefly below.

pH and Moisture Content. For bioreactors that are predominantly bacterial, near-neutral-*pH* conditions are generally desirable. Acidification of the biofilm is not expected unless non-ideal conditions exist in the biofilm such that incomplete biodegradation of the VOC pollutants is occurring and acidic byproducts are formed. In this case, the nutrient solution can be buffered to prevent a drop in *pH*. In fungal bioreactors, however, it may be desirable to operate the system at lower *pH* values (*e.g.*, *pH* 5.0) to provide more optimal growth conditions. The moisture content of the biofilm in the biofiltration system should also be monitored frequently. Drying of the packing media is one of the commonest reasons for bioreactor failure under field conditions, and appropriate moisture content should be maintained. The appropriate moisture content will vary between different types of packing media. Previous recommendations that inlet gas streams should contain near 100% relative humidity to maintain media moisture content in biofilters (Corsi and Seed, 1995; Gostomski *et al.*, 1997; Deviny *et al.*, 1999) are relevant to both bacterial and fungal bioreactors. Although a regular nutrient addition into the intermittent biotrickling filters increases the moisture in the biofilter on a temporary basis, humidification of the inlet gas stream is still required.

Nitrogen Supply. As extensively discussed during earlier chapters, an adequate nitrogen supply must be provided to maintain VOC biodegradation in biofilter systems. In the intermittent biotrickling filter packed with polyurethane foam cubes, recirculating a moderately concentrated nitrogen solution through the packing material for 30 minutes intervals at a frequency of once or twice per day was found to be sufficient to maintain bioreactor performance (see Chapter 9). As biomass accumulates in the bioreactor, the experimental results suggest that the quantity of inorganic nitrogen that must be added to the bioreactor can be reduced since organic nitrogen can be recycled within the biofilm to supply some of the nitrogen requirement. Providing nitrogen in the form of nitrate (as opposed to ammonia) can aid in preventing excess biomass accumulation.

In a conventional biotrickling filter, a spray system located at the top of the bioreactor packing material is sufficient for distributing the nutrients throughout the synthetic packing material. One advantage of biotrickling filters is that *pH* and nutrient levels in the bioreactor can be adjusted readily. This allows one greater control over the operating conditions within the biotrickling filter and more flexibility to respond to operational problems. However, this advantage is balanced by the need to continuously recirculate a nutrient solution through the bed at a high rate to ensure that the nutrient solution is well distributed in the packing material. In addition to increasing pumping costs, the nutrient solution may need to be refreshed on a fairly frequent basis, a factor which would add to the cost of the system. Finally, to minimize liquid hold-up in such a system, a relatively open packing material such as pall rings must be utilized. While the open structure minimizes biomass clogging issues, it also reduces the surface area per

unit volume provided by the packing and essentially reduces the biologically active area in the bioreactor. This in turn can reduce the contaminant elimination capacity of the system.

An alternative to the classic biotrickling filter design is to operate the system as an intermittent biotrickling filter system as described in Chapters 9 and 10. In this system, nutrients are provided only a few times a day when the nutrient solution is recirculated through the packing material. As well as simplifying operation of the bioreactor system and reducing pumping costs, this design minimizes the liquid film on the packing material, which should enhance pollutant mass transfer rates. In addition, it enables one to use a foam-type packing material in the bioreactor. This type of packing material has several advantages over conventional packing materials including a higher surface area per unit volume than a comparable pall-ring packing (e.g., on the order of $600 \text{ m}^2/\text{m}^3$ versus $300 \text{ m}^2/\text{m}^3$ for pall ring material) as well as providing the option to remove biomass via compression if desired.

Nitrogen availability was also found to be important in the experimental hybrid system, which consisted of a biofilter column placed directly atop a biotrickling filter module. Results indicate that VOC removal in the biofilter module increased with increasing inorganic nitrogen availability up to a point (see Figure 6-4). However, a problem was identified with using a stacked system for the hybrid bioreactor. That is, when a concentrated nutrient solution was provided to the top biofilter module, excess nutrient solution penetrated to the lower biotrickling filter portion of the system. The excess nutrients in the lower biotrickling filter module led to rapid biomass clogging in this module at high VOC-loading rates. This problem can easily be remedied by completely separating the biotrickling filter module from the biofilter module and providing a separate sump for each. Two separate modules may increase system cost, but would allow an operator to optimize the operating conditions in each bioreactor module separately. Thus, a concentrated nutrient solution could be applied to the biofilter packing material to overcome nitrogen limitations without adversely affecting operation of the biotrickling filter.

Biomass Accumulation and System Pressure Drop. Biomass accumulation in the bioreactor should be monitored on a regular basis (e.g., monthly) to determine the rate of biomass accumulation in the system. Although biomass accumulation is desired during bioreactor startup, it is desirable to minimize biomass accumulation in the system once a biofilm is well established in the bioreactor. Excessive biomass accumulation can lead to channeling in the reactor, high pressure drops, and ultimately a decrease in removal efficiency. Biomass levels retained on the packing media should be assessed periodically and the biomass quantities in the leachate should be as well. In addition, pressure drop across the bioreactor system should be monitored on a regular basis (e.g., weekly) to ensure that clogging of the packing material due to excess biomass accumulation or a build-up of inert particulate matter is not occurring.

The biomass accumulation rate that occurs in a vapor-phase bioreactor will depend on the pollutant loading rate to the system, nutrient availability, and the endogenous respiration rate of the microbial population in the bioreactor. For paint booth applications in which no pre-concentration system is being employed, excessive biomass accumulation is not likely to be a major factor since the bioreactor will be treating a waste gas stream contaminated only with low VOC concentrations on an intermittent basis (e.g., 6 to 8 hours per day). During the period without a VOC supply, the microorganisms in the bioreactor will undergo endogenous decay which will reduce biomass accumulation. Thus, biomass control measures such as directionally

switching operation are not likely worth the added complexity they would impose for bioreactor operation in these cases. However, if a slip-feed system is employed to maintain biological activity during the booth shutdown periods, care should be taken to provide the minimal amount of VOC necessary so as to minimize excess biomass growth in the system.

At facilities where a biofilter is subjected to a continuous VOC loading greater than 50 g/m³/hr, additional measures may be needed to control biomass accumulation. A continuous VOC loading situation could be expected, for instance, if the waste gas stream from the paint spray booth were concentrated in an activated carbon system prior to being metered to a downstream bioreactor during regeneration. In such a situation, directionally switching operation would be useful to distribute the active biomass more evenly along the bioreactor column and to prevent rapid biomass clogging near the bioreactor inlet. Although directionally switching operation would help maintain bioreactor performance, biomass accumulation would still occur slowly in the system and a supplemental biomass removal mechanism may be needed periodically to ensure stable long-term performance of the system. Possible biomass control measures include chemically rinsing the packing material, using an air sparging system to dislodge biomass, or mechanically compressing the packing material. While perhaps less feasible for extremely large bioreactor vessels, such biomass control measures would be possible in the smaller bioreactor columns that would be used for the lower waste gas flow rates that would be expected after pre-concentration of the waste gas stream.

Residuals Management. Several residual byproducts may be generated as part of the biofiltration process and require periodic disposal. Most of the residuals should be non-hazardous; however, care must be taken when dealing with bioreactor materials that have been in contact with paint emissions. That is, paints used at DoD facilities often contain such heavy metals as chromium and cadmium. Existing particle filtration systems can remove greater than 99% of these particulate emissions and, thus, heavy metals should not penetrate the prefiltration system to the downstream bioreactor. However, if the particle filtration system is not designed or operated properly, breakthrough of the paint pigments and associated heavy metals is possible. Thus, materials that might capture heavy metal emissions from the paint booth should be checked for heavy metal content prior to disposal.

The nutrient solution in the bioreactor will contain inorganic nitrogen as well as biomass that has sloughed off of the packing material. This solution will collect in the sump of the bioreactor and a fraction of it will need to be disposed of periodically. If the particulate control system is operational and no heavy metals are being captured in the bioreactor, this solution can likely be discharged to a sanitary sewer after obtaining any necessary permits and approvals.

Just as with other biological treatment systems, such as wastewater treatment plants, precautions should be employed when handling biological materials from the bioreactor. Immune-compromised individuals should not be involved in bioreactor maintenance or operation. In addition, the stack from the bioreactor should be at sufficient height to prevent direct contact of the exhaust gas from the bioreactor with operating personnel. For added safety, care should be taken to ensure that the exhaust gas stream from the biological treatment system is not located within the capture zone of the air intake for the paint spray booth.

11.2 Economic Evaluation

The costs associated with biofiltration technology will depend on the characteristics of the waste gases emitted from a particular painting operation as well as the treatment goal selected for the process. To examine the economic feasibility of biofiltration technology for painting operations, two illustrative case studies were evaluated. In the first case, the waste gas exiting the paint booth was assumed to have a volumetric flow rate of 4,000 scfm and a total paint VOC concentration of 200 ppm_v. This is intended to be representative of a larger booth (e.g., 40,000 scfm) in which a recirculating booth design has been employed to reduce the volumetric flow rate of the waste gases to be treated. For illustrative purposes, the composition of the waste gas is assumed to be the same as the surrogate VOC waste gas streams examined in the biotrickling filter experiments (see Table 5-2). In the second case examined, the emissions from a 40,000-scfm paint spray booth are to be treated. In this case, the VOC concentration exiting the booth will be considerably lower, and a conservative total VOC concentration of 60 ppm_v has been selected as the design parameter. Again, the relative composition of the waste gas stream is assumed to be identical to the surrogate paint VOC off-gas streams evaluated in the bioreactor experiments (Table 5-2).

To complete the economic analysis, APCEvaluator, a design and economic model developed in conjunction with the Separations Research Program at the University of Texas was employed (Deshpande, 2003). The APCEvaluator model focuses on the treatment of air streams contaminated with relatively dilute concentrations of VOCs and considers air pollution control options such as incineration (catalytic/thermal), biofiltration, and adsorption. The costing module for the model is based on EPA-recommended cost factors for air pollution control equipment (Vatavuk, 1990, EPA, 2002). To maximize the utility of the model for the widest possible range of VOC-control applications, the model has been developed using an Excel interface and, whenever possible, the model inputs allow the greatest level of user flexibility for the design and costing of each air pollution control alternative. Thus, this model is useful as a first step towards understanding what options are feasible for paint booth applications and to determine the factors governing the cost of each system.

Utilizing this model, the costs of two abiotic control technologies—catalytic oxidation and thermal oxidizers—were estimated for each of the paint booth case studies described above. These costs were then compared to cost estimates developed for an intermittent biotrickling filter design for each case study. Results of this analysis are summarized below.

11.2.1 Catalytic and Thermal Oxidation of Paint Booth Emissions

The key parameters used to size and cost a catalytic and thermal oxidizer unit for the two paint booth case studies are summarized in Table 11-1. An enthalpy balance was used to determine the natural gas flow rate required to reach the desired operating temperature, and standard cost factors developed by the Environmental Protection Agency were used to estimate the total capital cost of each system. This capital cost was annualized using the capital recovery factor and combined with the annual operating costs to determine the total annual costs for each system. The resulting cost estimates are summarized in Table 11-2.

TABLE 11-1. CATALYTIC AND THERMAL INCINERATION OPTIONS FOR PAINT BOOTH CASE STUDIES.

Parameter	Catalytic Incineration	Thermal Incineration
Operating Temperature (°F)	550	1290
Heat Exchanger Effectiveness (%) ⁽¹⁾	35	35
Cost of Fuel (\$/MMBTU)	\$6.00	\$6.00
Residence Time (sec)	0.1	0.5
Operating Period (hrs/year)	2920	2920
Total Annual Cost	\$162,889	\$297,240

⁽¹⁾ 70% Heat Exchanger Effectiveness assumed for 40,000-scfm case study.

TABLE 11-2. TOTAL ANNUAL COST ⁽¹⁾ OF THE CATALYTIC AND THERMAL INCINERATION OPTIONS

Case Study	Catalytic Incineration	Thermal Incineration
1 (4,000 scfm)	\$162,889	\$297,240
2 (40,000 scfm)	\$868,235	\$1,528,290

⁽¹⁾ Interest factor = 7%; Equipment life = 10 years

The results presented in Table 11-2 assume a natural gas cost of \$6.00 per million BTU. A sensitivity analysis indicates that the total annual cost of the thermal treatment options are heavily dependent on the cost of natural gas as shown in Figure 11-1. Because catalytic systems operate at a lower temperature (550 °F assumed for this case study), cost of the catalytic units are less sensitive to the cost of fuel than thermal oxidizers. Regardless, at a flow rate of 40,000

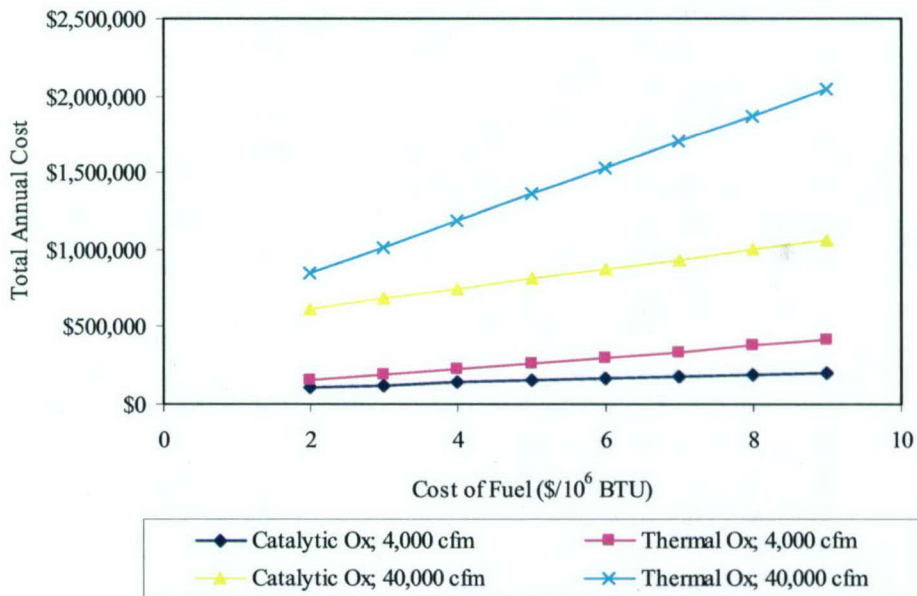

Figure 11-1. Cost of Catalytic Oxidation and Thermal Oxidation Units As a Function of the Cost of Natural Gas and Paint Booth Off-gas Flow Rates.

scfm, both the catalytic and thermal oxidizers are quite expensive, even if extensive heat recovery is employed to preheat the waste gas stream prior to its entering the oxidizer. Thermal oxidizers become more cost competitive at low gas flowrates, as illustrated in Figure 11-2. A combined treatment system that consists of an activated carbon unit linked to a thermal or catalytic oxidizer unit is also a viable abiotic treatment option (Deshpande, 2003). However, the design of an adsorption system for this application involves modeling competitive adsorption effects and, thus, was beyond the scope of this study. Nevertheless, if an adsorption system is used as a flow preconcentrator step, the cost of this system should be included in the overall cost of the treatment option regardless of whether the adsorption system is combined with a thermal technology or a biofiltration unit.

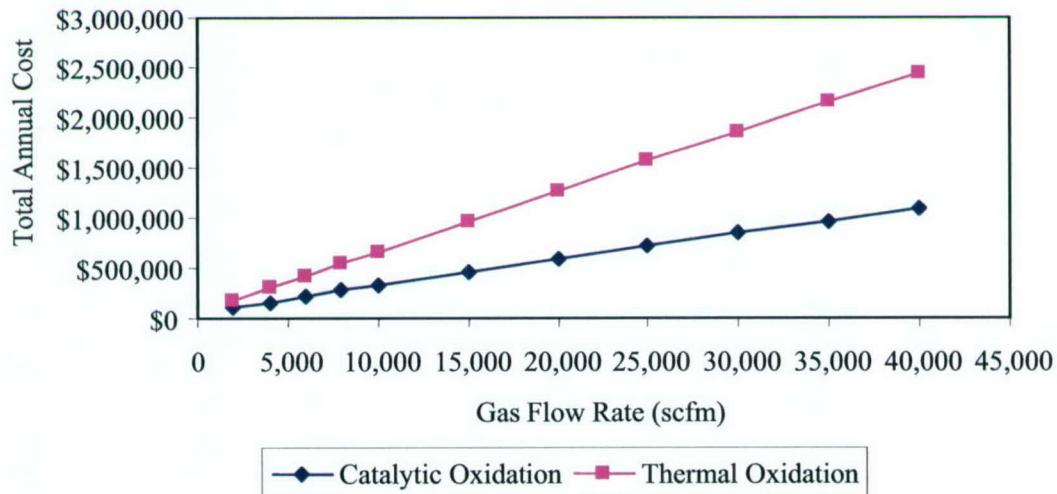

Figure 11-2. Cost of Catalytic Oxidation and Thermal Oxidation of Paint Spray Off Gas Stream As a Function of Gas Flow Rate.

11.2.2 Biofiltration of Paint Booth Emissions

Two biofiltration units were designed to treat paint booth emissions for the 4,000-scfm and 40,000-scfm cases. In each case, the preliminary design process proceeded as follows. A gas-phase residence time based on lab- and pilot-scale results was selected for each paint booth application. Based on this residence time as well as the gas flowrate and the concentration of each pollutant entering the unit, the pollutant loading rate (L) was calculated for each VOC entering the bioreactor using the APCEvaluator model. The elimination capacity for each VOC was then determined by examining the experimentally determined elimination capacity versus loading rate curves. Based on this information, the removal efficiency achievable was estimated using equation 11-3. If this removal efficiency was deemed acceptable, the required volume of the packed bioreactor vessel was calculated and a cost estimate for the system was generated. Because no standard costing procedures are available for biofiltration units, the cost of the bioreactor vessel is based on an estimate of the cost/area of vessel. Since the bioreactor volume requirements would be expensive to accommodate in a tower configuration, the bioreactor vessel was designed as a modular square unit divided vertically into separate 3-foot-high lifts. The

results of the design and cost estimation process for the two illustrative case studies are summarized in Table 11-3 below.

TABLE 11-3. DESIGN PARAMETERS AND COST ESTIMATES FOR THE BIOFILTRATION TREATMENT OPTION.

Parameter	Case Study 1 (4,000 scfm)	Case Study 2 (40,000 scfm)
Gas-Phase Residence Time (sec)	36	15
Bioreactor Volume (ft ³)	3,060	12,750
Cost Vessel/ft ² vessel area	100	100
Packing Media Cost (\$/ft ³)	\$15	\$15
Modular Bioreactor Footprint	18 ft x 18 ft	38ft x 38ft
Bioreactor Packed-Bed Height (ft)	9	9
Total Annualized Cost (TAC)	\$84,737	\$281,644
Total Capital Invest. (TCI)	\$239,703	\$924,771
TAC/scfm	\$21	\$7
TCI/scfm	\$60	\$23

As evident from Table 11-3, the capital cost of the bioreactor units can be comparatively high; however, the total annual costs (which include the annualized capital investment cost) are significantly lower than those estimated for the thermal and catalytic oxidizers (see Table 11-2). The total capital investment cost for the bioreactors per scfm of gas treated ranged from \$23/scfm for the 40,000-scfm unit to \$60/scfm for the 4,000-scfm unit. The \$23/scfm estimate for the total capital investment is within the range of values (*i.e.*, \$20–24/scfm) reported by a private biofiltration company for large units operated at residence times on the order of 20 to 30 seconds (Boswell, 2004). The lower total annual costs for the biofiltration treatment option is significantly lower than for thermal abiotic technologies because the operating costs for the bioreactor units are much lower. Operating costs for the biofiltration option include the costs for nutrients, water, power, and maintenance personnel. Even though it was assumed, for instance, that maintenance labor costs on the order of \$40,000 would be required for the large biofiltration system, the overall operating costs for the system are still low because the energy consumption of the system is so much lower than the thermal technologies. Thus, one potential advantage of biofiltration technology in an era of widely fluctuating energy costs is it reduces the future financial risks associated with using energy-intensive control technologies.

The two case studies examined above indicate that biofiltration systems have the potential to be much less expensive than energy-intensive abiotic control technologies. However, biofilter units for VOC control tend to require much greater sizes and process footprints than the competing abiotic control technologies. As a result, the capital costs for these systems can be substantial. The operating costs for the biofilter systems are significantly lower than those required for the incinerator control option. As a result, for moderate gas flow rates and dilute VOC concentrations, biofiltration can be an attractive treatment option with lower overall costs than the abiotic technologies examined.

A final factor that must be considered when evaluating biofiltration technology for a particular paint booth application is the treatment goals and air permit requirements for that facility. As noted earlier, bioreactor systems can achieve high VOC removal efficiencies but will have periods, particularly during start up, when the VOC removal efficiencies will be much lower. Thus, the financial attractiveness of the technology must be balanced with the capacity of the system to meet air permit requirements.

REFERENCES

- Agathos S.N., Hellin, E., Ali-Khodja, H., Deseveaux, S., Vandermesse, F. and Naveau, H. (1997) "Gas-phase methyl ethyl ketone biodegradation in a tubular biofilm reactor: Microbiological and bioprocess aspects." *Biodegradation*, **8**(4): 251–264.
- Aitken, M.D., and Irvine, R.L. (1990) "Characterization of reactions catalyzed by manganese peroxidase from *Phanerochaete chrysosporium*," *Arch. Biochem. Biophys.*, **276**: 405–414.
- Allen, E.R., and Shavari, P. (1993) "Control of organo-sulfur compound emissions using biofiltration–methyl mercaptan," *Proc. 86th Ann. Meeting of the Air & Waste Manage. Assn.*, Denver, Colorado.
- Alvarez, P.J.J., and Vogel, T.M. (1991), "Substrate interactions with benzene, toluene, and *para*-xylene during microbial degradation by pure cultures and mixed culture aquifer slurries," *Applied Environmental Microbiology*, **57**:2981–2985.
- American Public Health Association (APHA); American Water Works Association; Water Environment Federation. (1992). *Standard methods for the examination of water and wastewater*, 18th Ed., Washington, D.C.
- Anderson, K., Koopman, B., and Bitton, G. (1988) "Evaluation of INT-Dehydrogenase Assay for Heavy Metal Inhibition of Activated Sludge," *Water Research*, **22**:349–353.
- Anniston Army Depot (2000). VOC and HAP Emissions Inventory for Bldg 409, Booths A, B and C, 0/01/00–12/31/00.
- Atoche, J.C., and Moe, W.M. (2004) "Treatment of MEK and toluene mixtures in biofilters: effect of operating strategy on performance during transient loading," *Biotechnology and Bioengineering*, **86**(4): 468–481.
- Auria, R., Aycaguer, A.C., Deviny, J.S. (1998) "Influence of water content on degradation rates for ethanol in biofiltration." *J. Air & Waste Manage. Assn.*, **48**:65–70.
- Auria, R., Frere, G., Morales, M., Acuna, M.E., and Revah S. (2000) "Influence of mixing and water addition on the removal rate of toluene vapors in a biofilter," *Biotechnology and Bioengineering*, **68**:448–455.
- Ayer, J. (1997) "Controlling VOC and air toxic emissions from aircraft refinishing facilities—A new approach," *Proc. 90th Ann. Meeting of the Air & Waste Manage. Assn.*, Abstract No. 98-TA23B.05, Toronto, Canada.
- Ayer, J. and Proffitt, D. (1998) *Demonstration of a paint spray booth emission control strategy using recirculation/partitioning and UV/ozon e pollutant emission control*, EPA/600/SR-98/016.
- Ayer, J., and Propper, R. (1998) "The way to more cost effective VOC control for coating operations: real-time exhaust flow minimization and continuous optimization of control device operation," *Proc. 91st Ann. Meeting of the Air & Waste Manage. Assn.*, Abstract No. 98-TP47A.05, San Diego, California.

- Barnes, J.M., Apel, W.A., and Barrett, K.B. (1995) "Removal of nitrogen oxides from gas streams using biofiltration," *Journal of Hazardous Materials*, **41**:315–326.
- Barshter, D.W., Paff, S.W., and King, A.B. (1993) "Biofiltration: room temperature incineration," *Proc. 86th Ann. Meeting of the Air & Waste Manage. Assn.*, Denver, Colorado.
- Blenkinsopp, S. A. and Lock, M. A. (1990) "The measurement of electron transport system activity in river biofilms," *Water Research*, **24**: 441–445.
- Boswell, J., BioReaction Industries, Personal Communication, June 2004.
- Boswell, J., John, P., Stewart, P., *et al.*, (2000). "Biofiltration of VOCs from Paint Manufacturing." *Proc. 93rd Ann. Meeting of the Air & Waste Manage. Assn.*, Orlando, Florida, Abstract No. 214.
- Boyette, R.A., Williams, T., and Wynne, D. (1995) "Biofiltration demonstration for controlling volatile organic emissions." *Proc. 1995 Conference on Biofiltration*, University of Southern California, eds. D.S. Hodge and F.E. Reynolds, Jr., 325–332.
- Braun-Lüllemann, A., Johannes, C., Majcherczyk, A., Hüttermann (1995) "The use of white-rot fungi as active biofilters." In Hinchee RE, Sayles RD, and Skeen RS (Eds.), *Biological Unit Processes for Hazardous Waste Treatment*, Battelle Press, **3**(9): 235–240.
- Bumpus, J.A., Tien, M., Wright, D., and Aust, S.D. (1985) "Oxidation of persistent environmental pollutants by a white rot fungus." *Science*, **228**:1434–1436.
- Carlson, D.A., and Leiser, C.P. (1966) "Soil beds for the control of sewage odors," *Journal of the Water Pollution Control Federation*, **38**: 829–840.
- Chang, M., Voice, T.C., and Criddle, C.S. (1993) "Kinetics of competitive inhibition and cometabolism in the biodegradation of benzene, toluene, and *p*-xylene by two *Pseudomonas* isolates," *Biotechnology and Bioengineering*, **41**: 1057–1065.
- Chang, A.; and Yoon, H., (1995) "Biofiltration of gasoline vapors." *Proc. 1995 Conference on Biofiltration*, University of Southern California, eds. D.S. Hodge and F.E. Reynolds, Jr., 123–130.
- Chemfinder. (2003). "www.chemfinder.com."
- Choi, D., Devinny, J.S., and Deshusses, M.A. (1998) "Performance of a Pilot-Scale Biotrickling Filter Under Non-Steady State Conditions," *Proc. 1998 Conference on Biofiltration*, University of Southern California, eds. D.S. Hodge and F.E. Reynolds, Jr., 159–168.
- Chozick, R., and Irvine, R.L. (1991). "Preliminary studies on the granular activated carbon–sequencing batch biofilm reactor." *Environmental Progress*, **10**, 282–289.
- Christen, P., Domenech, F., Michelena, G., Auria, R., and Revah, S. (2002). "Biofiltration of volatile ethanol using sugar cane bagasse inoculated with *Candida utilis*." *Journal of Hazardous Materials*, **89**(2–3): 253–265.
- Corsi, R.L., and Seed, L. (1995), "Biofiltration of BTEX: Media, substrate, and loading effects," *Environmental Progress*, **14**(3): 151–158.

- Cox, H.H.J., J.H.M. Houtman, H.J. Doddema and W. Harder. (1993), "Enrichment of fungi and degradation of styrene in biofilters," *Biotechnology Letters*, **15**: 737-742.
- Cox, H.H.J., Magielsen, F.J., Doddema, H.J. (1996) "Influence of the water content and water activity on styrene degradation by *Exophiala jeanselmei* in biofilters," *Applied Microbiology and Biotechnology*, **45**: 851-856.
- Cox, H.H.J. and Deshusses, M.A. (1997), "The Use of Protozoa to Control Biomass Growth in a Biological Trickling Filter for Waste Air Treatment," *Proc. 90th Ann. Meeting of the Air & Waste Manage. Assn.*, Toronto, Canada, Abstract No. 97-RA71C.05.
- Cox, H.H.J., and Deshusses M.A. (2002) "Effect of starvation on the performance and re-acclimation of biotrickling filters for air pollution control," *Environmental Science & Technology*, **36** (14): 3069-3073.
- Davidova, Y.B., Schroeder, E.D., and Chang, D.P.Y. (1997), "Biofiltration of nitric oxide," *Proc. 90th Ann. Meeting of the Air & Waste Manage. Assn.*, Toronto, Canada, Abstract No. 97-WP71B.05.
- Deshpande, S. B. *APCEvaluator: A model to evaluate VOC control options for waste gas streams*, Master's Thesis; Civil Engineering Department, University of Texas at Austin, August 2003.
- Deshusses, M.A., and Hamer, G. (1993), "The removal of volatile ketone mixtures from air in biofilters," *Bioprocess Engineering*, **9**: 141-146.
- Deshusses, M.A. (1994), *Biodegradation of mixtures of methyl ethyl ketone vapours in biofilters for the treatment of waste air*, Ph.D. Thesis, Swiss Federal Institute of Technology, Zurich, 1994.
- Deshusses, M.A., Hamer, G., and Dunn, I. (1995), "Behavior of biofilters for waste air biotreatment. 1. Dynamic model development," *Environmental Science & Technology*, **29**(4): 1048-1058.
- Deshusses, M.A., Johnson, C.T., and Leson, G. (1999), "Biofiltration of high loads of ethyl acetate in the presence of toluene," *J. Air & Waste Manage. Assn.*, **49**: 973-979.
- Deshusses, M. A., and Johnson, C. T. (2000) "Development and validation of a simple protocol to rapidly determine the performance of biofilters for VOC treatment," *Environmental Science & Technology*, **34**: 461-467.
- Devinny, J.S., Deshusses, M.A., and Webster, T.S. (1999), *Biofiltration for Air Pollution Control*. CRC Press.
- Devinny, J.S., and Chitwood, D.E. (2000), "Two-stage biofiltration of sulfides and VOCs from wastewater treatment plants," *Water Science and Technology*, **42**: 411-418.
- Don, J.A., and Feestra, L. (1984), "Odor abatement through biofiltration," in *Proceedings of Characterization and Control of Odouriferous Pollutants in Process Industries*, Le Nueve, Belgium.
- Ergas, S.J., Schroeder, E.D., Change, D.P.Y., and Morton, R.L.(1995) "Control of volatile organic compound emissions using a compost biofilter," *Water Environment Research*, **67**(5): 816-821.

Hodge, D.S., Medina, V.F., Islander, R., and Deviny, J.S. (1991) "Biofiltration of Hydrocarbon Fuel Vapors in Biofiltration," *Environmental Technology*, **12**: 665–662.

Ft. Hood (2000). "Summary of particulate concentrations, emissions, and filter efficiency, Army III Corps—Ft. Hood Paint Booths," July 2000.

Ft. Hood (2001) "2001 Air Emissions Inventory, Fort Hood, Texas," Prepared by Ft. Hood Directorate of Public Works, Environmental Division and TRW Inc.

Ft. Hood (2003). "Fort Hood—Paint Booth Emissions Database, Product Constituent Emissions Monthly Report, May 2003."

Ft. Hood, Personal Communication with Painting Personnel, February, 2004.

García-Peña, E.I., Hernández, S., Favela-Torres, E., Auria, R., and Revah S. (2001). "Toluene biofiltration by the fungus *Scedosporium apiospermum* TB1," *Biotechnology and Bioengineering*, **76**(1): 61–69.

Garner, L.G., and Barton, T.A. (2002) "Biofiltration for abatement of VOC and HAP emissions," *Metal Finishing*, **100**(11–12): 12–18.

Gostomski, P.A., Sisson, J.B., and Cherry, R.S. (1997). "Water content dynamics in biofiltration: the role of humidity and microbial heat generation." *J. Air & Waste Manage. Assn.*, **47**(9): 936–944.

Gribbins, M. J., and Loehr, R.C. (1998) "Effect of Media Nitrogen Concentration on Biofilter Performance." *J. Air & Waste Manage. Assn.*, **48**: 216–226.

Ha, S.R., Qishan, L., and Vinitnantharat S. (2000) "COD removal of phenolic wastewater by biological activated carbon-sequencing batch reactor in the presence of 2,4-DCP," *Water Science and Technology*, **42**(5–6): 171–178.

Harnett, D.L. and Horrell, J.F. (1998) *Data, Statistics, and Decision Models with Excel*, John Wiley & Sons, Inc.

Haught, R.C., Neogy, R., Vonderhaar, S.S., Krishnan, E.R., Safferman, S.I., and Ryan, J. (1995) "Land treatment alternatives for bioremediating wood preserving wastes." *Hazardous Waste & Hazardous Materials*, **12**: 329–343.

Hanson J.R., Ackerman CE, Scow KM. (1999) "Biodegradation of methyl tert-butyl ether by a bacterial pure culture," *Appl. Environ Microbiol.* **65**(11): 4788–92.

Hsu, S.K., Shen, K.P., Lin, S.S., Wang, Y.M., and Chen, H.W. (2000) "Biofilter application for control of volatile organic compounds (VOC) from paint manufacturing industry," *Proc. 93rd Ann. Meeting of the Air & Waste Manage. Assn.*, Salt Lake City, Utah, Abstract No. AE-2b-84.

Holubar, P., Andorfer, C., and Braun, R. (1999) "Effects of nitrogen limitation on biofilm formation in a hydrocarbon-degrading trickle-bed filter." *Applied Microbiology and Biotechnology*, **51**: 536–540.

Irvine, R.L., and Moe, W.M. (2001) "Periodic biofilter operation for enhanced performance during unsteady-state loading conditions." *Water Science and Technology*, **43**(3): 231–239.

- Jenkins, R.O., and Heald, S.C. (1996) "Stability of toluene oxidation by *Pseudomonas* under nutrient deprivation," *Applied Microbiology and Biotechnology*, **46**(4): 388–392.
- Johnson, C.T., and Deshusses, M.A. (1997) "Quantitative structure-activity relationships for VOC biodegradation in biofilters," in *Proceedings of the Fourth International In Situ and On-Site Bioreclamation Symposium*, **5**: 175.
- Jorio, H., Kiared, K., Brzezinski, R., Leroux, A., Viel, G., and Heitz, M. (1998) "Treatment of air polluted with high concentrations of toluene and xylene in a pilot-scale biofilter." *Journal of Chemical Technology and Biotechnology*, **73**(3): 183–196.
- Jorio, H., Bibeau, L., and Heitz, M. (2000) "Biofiltration of air contaminated by styrene: effect of nitrogen supply, gas flow rate, and inlet concentration." *Environmental Science & Technology*, **34**(9): 1764–1771.
- Kazenski, S.L., and Kinney, K.A. (2000) "Biofiltration of paint spray booth emissions: packing media considerations and VOC interactions." *Proc. 93rd Ann. Meeting of the Air & Waste Manage. Assn.*, Salt Lake City, Utah, Abstract No. AE-2b-614.
- Kennes, C., Cox, H.H.J., Doddema, H.J., and Harder, W. (1996) "Design and performance of biofilters for the removal of alkylbenzene vapors," *Journal of Chemical Technology and Biotechnology*, **66**(3): 300–304.
- Kim, B. R., and Adams, J. A. (2000) "Biological removal of gaseous VOCs from automotive painting operations." *Journal of Environmental Engineering*, **126**(8): 745–753.
- Kinney, K. A. (1996) "Spatial distribution of biomass and activity in a directionally switching biofilter," Ph.D. Dissertation, University of California, Davis.
- Kinney, K.A., Schroeder, E.D., Chang, D.P.Y., and Scow, K.M. (1996) "Performance of a directionally switching biofilter treating toluene contaminated air." *Proc. 89th Ann. Meeting of the Air & Waste Mgmt. Assn.*, Nashville, Tennessee, Abstract No. 96-RP87C.05.
- Kinney, K.A., Loehr, R.C., and Corsi, R.L. (1999) "Vapor-phase bioreactors: avoiding problems through better design and operation." *Environmental Progress*, **18**(9): 222–230.
- Kirchner, K., Gossen, C.A., and Rehm, H.J. (1991) "Purification of exhaust air containing organic pollutants in a trickle-bed bioreactor," *Applied Microbiology and Biotechnology*, **35**: 396–400.
- Kirchner, K., Hauk, G., and Rehm, H.J. (1987) "Exhaust gas purification using immobilized monocultures (biocatalysts)," *Applied Microbiology and Biotechnology*, **26**: 579–587.
- Kirchner, K., Schlachter, U., and Rehm, H.J. (1989) "Biological purification of exhaust air using fixed bacterial monocultures," *Applied Microbiology and Biotechnology*, **31**: 629–632.
- Kleinheinz, G.T. and Bagley, S.T. (1998) "Biofiltration for the removal and 'detoxification' of a complex mixture of volatile organic compounds," *Journal of Industrial Microbiology and Biotechnology*, **20**: 101–108.
- Kok, H.J.G. (1992) "Bioscrubbing of air contaminated with high concentrations of hydrocarbons," in A.J. Dragt and J. van Ham, Eds. *Biotechniques for Air Pollution Abatement and Odour Control Policies, Proceedings of an International Symposium*, Maastricht, The Netherlands, October 27–29, 1991, pp. 77–82. Elsevier, Amsterdam.

- Kolb, F.R., and Wilderer, P.A. (1995) "Activated carbon membrane biofilm reactor for the degradation of volatile organic pollutants," *Water Science and Technology*, **31**(1): 205–213.
- Kolb, F.R., and Wilderer, P.A. (1997) "Activated carbon sequencing batch biofilm reactor to treat industrial wastewater." *Water Science and Technology*, **35**(1): 169–176.
- Kozliak, E.I., Ostlie–Dunn, T.L., Jacobson, M.L., Mattson, S.R., and Domack, R.T. (2000) "Efficient steady-state volatile organic compound removal from air by live bacteria immobilized on fiber supports," *Bioremediation Journal*, **4**(1): 81–96.
- Kraakman, N.J. R., van Groenestijn, J.W., Koers, B. and Heslinga, D.C. (1997) "Styrene removal using a new type of bioreactor with fungi," In *Biological Waste Gas Cleaning: Proceedings of an International Symposium*. W.L Prins and J. van Ham, ed. VDI Verlag GmbH. Dusseldorf, Germany. pp. 225–232.
- Larsen, R.J., and Marx, M.L. (1986) *An Introduction to Mathematical Statistics and Its Applications*. Prentice–Hall, Inc.
- Lee, J., Choi, Y., and Kim, H. (1993) "Simultaneous biodegradation of toluene and *p*-xylene in a novel bioreactor: experimental results and mathematical analysis," *Biotechnology Progress*, **9**: 46–53.
- Lee, B.D., Apel, W.A., Barnes, J.M., Walton, M.R., Barrett, K.B., and Cook, L.L. (1995) "Biofiltration using different modes of biodegradation," *Proc. USC–TRG Conf. on Biofiltration*, University of Southern California, Los Angeles, California, October 5–6, 1995.
- Leson, G., and Winer, A.M. (1991) "Biofiltration: An innovative air pollution control technology for VOC emissions." *J. Air & Waste Manage. Assn.*, **41**(8): 1045–1054.
- Li, C., and Moe, W.M. (2003) "Sequencing batch biofilter operation for treatment of methyl ethyl ketone (MEK) contaminated air," *Environmental Technology*, **24**(5): 531–544.
- Li, C., and Moe, W.M. (2004) "Assessment of microbial populations in methyl ethyl ketone degrading biofilters by denaturing gradient gel electrophoresis," *Applied Microbiology and Biotechnology*, **64**(4): 568–575.
- Lu, C., Lin, M., Wey, I., (2001) "Removal of pentane and styrene mixtures from waste gases by a trickle bed air biofilter," *Journal of Chemical Technology & Biotechnology*, **76**(8): 820–826.
- Madigan, M. T., Martinko, J.M., and Parker., J. (2000) *Brock Biology of Microorganisms*. Prentice–Hall, Englewood Cliffs, New Jersey.
- Majcherczyk, A., Braun–Lulleman, A., and Parker, J. (1989) "Biofiltration of polluted air by a complex filter based on white-rot fungi growing on lignocellulosic substrates," *Advances in Biological Treatment of Lignocellulosic Materials*. M.P.Coughlin and M.T. Amaral Collaco, ed, Elsevier Applied Science. London, England, pp. 323–329.
- Martin, F. J., and Loehr, R.C. (1996) "Effects of periods of non-use on biofilter performance." *J. Air & Waste Manage. Assn.*, **46**: 539–546.
- McMinn, B.W., Newman, C.R., McCrillis, R.C., and Kosusko, M. (1992) *VOC Prevention Options for Surface Coating*, EPA/600/A-92/146.

- Metcalf and Eddy, Inc. (1991) *Wastewater Engineering: Treatment, Disposal, and Reuse*. Tchobanoglous, G. and Burton, F.L., eds., Third Edition. McGraw-Hill, Inc., New York.
- Moe, W. M., and Irvine, R.L. (2000a) "Polyurethane foam medium for biofiltration. I: Characterization." *Journal of Environmental Engineering*, **126**(9): 815–825.
- Moe, W. M., and Irvine, R.L. (2000b) "Polyurethane foam medium for biofiltration. II: Operation and performance." *Journal of Environmental Engineering*, **126**(9): 826–832.
- Moe, W. M., and Irvine, R.L. (2001) "Effect of nitrogen limitation on performance of toluene degrading biofilters," *Water Research*, **35**(6): 1407–1414.
- Moe, W.M., and Qi, B. (2004) "Performance of a fungal biofilter treating paint solvent mixtures during intermittent loading," *Water Research*, **38**(9): 2258–2267.
- Moe, W.M., and Li, C. (2004) "Comparison of continuous and sequencing batch operated gas-phase biofilters for treatment of MEK," *Journal of Environmental Engineering*, **130**(3): 300–313.
- Mohseni, M.; Allen, D.G., and Nichols, K.M. (1998) "Biofiltration of α -pinene and its application to the treatment of pulp and paper air emissions." *TAPPI Journal*, **81**(8): 205–211.
- Mohseni, M., and Allen, D.G. (1999) "Transient performance of biofilters treating mixtures of hydrophilic and hydrophobic volatile organic compounds." *J. Air & Waste Manage. Assn.*, **49**: 1434–1441.
- Mohseni, M., and Allen, D.G. (2000) "Biofiltration of mixtures of hydrophilic and hydrophobic volatile organic compounds." *Chemical Engineering Science*, **55**: 1545–1558.
- Morales, M., Revah, S., and Auria, R. (1998) "Elimination of gasoline compounds by biofiltration," *Proceedings of the USC-TRG Conference on Biofiltration*, University of Southern California, eds. D.S. Hodge and F.E. Reynolds, Jr, 33–40.
- Morgenroth, E., Schroeder, E.D., Chang, D.P.Y., and Scow, K.M. (1996) "Nutrient limitation in a compost biofilter degrading hexane," *J. Air & Waste Manage. Assn.*, **46**: 300–308.
- MSE Technology Applications, Inc. (2002) Final Test Report—Mobile Zone Recirculation System, Ft. Hood, Texas, Directorate of Logistics (DOL), Building 88027 Bay 4. Prepared April 2002.
- Mueller, J.C. (1998) "Biofiltration of gases—A mature technology for control of a wide range of air pollutants," report to the National Research Council of Canada and British Columbia Ministry of Advanced Education and Job Training, Project Number: 2-51-797.
- Murphy, R.J., Jones D.E., and Stessel, R.I. (1995) "Relationships of microbial mass and activity in biodegradation of solid waste," *Waste Management and Research*, **13**: 485–497.
- Muyzer, G., de Waal E. C., and Uitterlinden A. G. (1993) "Profiling of complex microbial populations by denaturing gradient gel electrophoresis analysis of polymerase chain reaction-amplified genes coding for 16S rRNA," *Applied and Environmental Microbiology*, **59**(3): 695–700.
- Neal, A.B. (1998) *Biotreatment of VOCs: Biofilters vs. suspended-growth reactors*, Masters of Science Thesis, University of Texas at Austin.

NFPA 33. National Fire Protection Association. NFPA-33-2000, *Standard for Spray Application Using Flammable or Combustible Materials*.

Omar, N.B, and Ampe, F. (2000) "Microbial community dynamics during production of the Mexican fermented maize dough pozol," *Applied and Environmental Microbiology*, **66**(9): 3664–3673.

Ottengraf, S.P.P., and van den Oever, A.H.C. (1983), "Kinetics of organic compound removal from waste gases with a biological filter," *Biotechnology and Bioengineering*, **25**(12): 3089–3102.

Ottengraf, S.P.P. (1986) "Biological elimination of volatile xenobiotic compounds in biofilters," *Bioprocess Engineering*, **1**: 61–69.

Ottengraf, S.P.P. (1987) "Biological systems for waste gas elimination," *Trends in Biotechnology*, **5**: 132–136.

Paca, J., Weigner, P., and Koutsky, B. (1998) "Biofilter characteristics during degradation of xylene and toluene mixture," *Proceedings of the USC–TRG Conference. on Biofiltration*, eds. D.S. Hodge and F.E. Reynolds, Jr. , University of Southern California, Los Angeles, 249–256.

Park, J., and Kinney, K.A. (2001) "Evaluation of a slip feed system for vapor-phase bioreactors," *Journal of Environmental Engineering*, **127**(11): 979–985.

Park, J., Kinney, K.A., and Moe, W.M. (2002) "Investigation of polyurethane foam biofilter: effect of operating mode and nutrient supply." *Proc. 95th Annu. Meeting Air & Waste Mgmt. Assn.*, Baltimore, Maryland, 1191–1201.

Pedersen, A.R., Moller, S., Molin, S. and E. Arvin. (1997) "Activity of toluene-degrading *Pseudomonas putida* in the early growth phase of a biofilm for waste gas treatment," *Biotechnology and Bioengineering*, **54**: 131–141.

Qi, B., Moe, W.M., and Kinney, K.A. (2004) "Treatment of paint spray booth off-gases in a fungal biofilter," *Journal of Environmental Engineering*, ASCE, **131**(2): 180–189.

Qi, B., Moe, W.M., and Kinney, K.A. (2002) "Biodegradation of volatile organic compounds by five fungal species," *Applied Microbiology and Biotechnology*, **58**(5): 684–689.

Ridgway, H. F., Safarik, J., Phipps, D., Carl, P. and Clark, D. (1990) "Identification and catabolic activity of well-derived gasoline-degradation bacteria from a contaminated aquifer," *Applied and Environmental Microbiology*, **56**(11): 3565–3575

Rihn, M.J., Zhu, X., Suidan, M.T., Kim, B.J., and Kim, B.R. (1997) "The effect of nitrate on VOC removal in trickle-bed biofilters," *Journal of Water Resources*, **31**(12): 2997–3008.

Romstad, K., Scarano, J.H., Wright, W.F., and Schroeder, E.D. (1998) "Performance of a full-scale compost biofilter treating gasoline vapor," *Proceedings of the USC–TRG Conf. on Biofiltration*, eds. D.S. Hodge and F.E. Reynolds, Jr., University of Southern California, Los Angeles, California, 25–32.

Sabo, F.; Fischer, K.; Baumeister, R. (1993) "Use of a biofilter for treatment of styrene-containing waste gas from plastic manufacture," *VDI–Berichte, 1034, Fortschritte bei der Thermischen, Katalytischen, Sorptiven und Biologischen Abgasreinigung*, 521–539.

Sabo, F., Schneider, T. and Fischer, K. (1995) "Improvement and application of high efficiency biofilters," *Proceedings of the USC-TRG Conf. on Biofiltration*, eds. D.S. Hodge and F.E. Reynolds, Jr., Los Angeles, California, 217-224.

Sabo, F., Schneider, T., and Bernecker, K. (1998) "Latest developments in biological air pollution control," *Proc. 91st Ann. Meeting of the Air & Waste Mgmt. Assn.*, San Diego, California. Abstract No. TP20C.06.

Severin, B.F., Shi, J., and Hayes, T. (1993) "Destruction of gas industry VOCs in biofilters," presented at *the IGT 6th Annual International Symposium on Gas, Oil, and Environmental Technology*. Colorado Springs, Colorado. November 28-December 1, 1993.

Severin B.F., Shi J., Cybul B.G., Neilson L.M, Furstenberg J.L. (1995) "High-rate low-volume biofilters for industry," Water Environment Federation; Industrial Wastes Technical Conference, Multimedia Pollution Control and Prevention, Pittsburgh, Pennsylvania.

Shi, J., et al. (1995) "Simulation of steady state and dynamic loading of a coating process VOC (ethyl acetate): Treatment by engineered media biofiltration," *Proc. USC-TRG Conf. on Biofiltration*, University of Southern California, Los Angeles, California, 151-159.

Smith, C.M., and Brown, W.E. (1993) "Elimination of VOC emissions from surface coating operations," *J. Air & Waste Manage. Assn.*, **43**: 1015-1019.

Smith, F. L., Sorial, G.A., Suidan, M.T., Breen, A.W., Biswas, P., and Brenner, R.C. (1996) "Development of two biomass control strategies for extended, stable operation of highly efficient biofilters with high toluene loadings." *Environmental Science & Technology*, **30**(5): 1744-1751.

Smith, F.L., Sorial, G.A., Suidan, M.T., Pandit, A., Biswas, P., and Brenner, R.C. (1998) "Evaluation of trickle-bed air biofilter performance as a function of inlet VOC concentration and loading, and biomass control," *J. Air & Waste Manage. Assn.*, **48**: 627-636.

Song, J., (2001) *Control and Characterization of Biomass Activity and Distribution in Vapor Phase Bioreactors for VOC Removal*, Ph.D. Dissertation, University of Texas at Austin, May.

Song, J., and Kinney, K.A. (1999) "A method for enhanced control of biomass activity and distribution in biofilters," *Proc., 92nd Annu. Meeting Air & Waste Mgmt. Assn.*, St. Louis, Missouri. Abstract No. 99-253.

Song, J., and Kinney, K.A. (2000) "Effect of vapor-phase bioreactor operation on biomass accumulation, distribution, and activity: linking biofilm properties to bioreactor performance," *Biotechnology and Bioengineering*, **68**(5): 508-516.

Song, J., and Kinney, K. A. (2001) "Effect of directional switching frequency on toluene degradation in a vapor-phase bioreactor," *Applied Microbiology and Biotechnology*, **56**: 108-113.

Song, J., and Kinney, K.A. (2002) "A model to predict long-term performance of vapor-phase bioreactors: A cellular automaton approach," *Environmental Science & Technology*, **36**(11): 2498-2507.

Song, J., Ramirez, J., and Kinney, K.A. (2003) "Nitrogen utilization in a vapor-phase biofilter," *Water Research*, **37**(18): 4497-4505.

- Song, J., Kinney, K.A., and John, P. (2003) "Influence of nitrogen supply and substrate interactions on the removal of paint VOC mixtures in a hybrid bioreactor," *Environmental Progress*, **22**(2): 137–144.
- Sorial, G.A., Smith F.L., Suidan, M.T., and Biswas, P. (1995) "Evaluation of trickle bed biofilter media for toluene removal," *J. Air & Waste Manage. Assn.*, **45**: 801–810.
- Stoffels, M., Amann, R., Ludwig, W., Hekmat, D., and Schleifer, K.H. (1998) "Bacterial community dynamics during start-up of a trickle-bed bioreactor degrading aromatic compounds," *Applied and Environmental Microbiology*, **64**(3): 930–939.
- Sun, A. K., Hong, J., and Wood, T. K. (1998) "Modeling trichloroethylene degradation by a recombinant *Pseudomonas* expressing toluene *ortho*-monooxygenase in a fixed-film bioreactor," *Biotechnology and Bioengineering*, **59**: 40–51.
- Swanson, W. J., and Loehr, R. C. (1997) "Biofiltration: fundamentals, design and operations principles, and applications." *Journal of Environmental Engineering*, **123**(6): 538–546.
- Teske, A., Wawer, C., Muyzer, G., and Ramsing, N.B. (1996) "Distribution of sulfate-reducing bacteria in a stratified fjord (Mariager Fjord, Denmark) as evaluated by most-probable-number counts and DGGE of PCR-amplified ribosomal DNA fragments," *Applied and Environmental Microbiology*, **62**: 1405–1415.
- Tresse, O., Lorrain, M.J., and Rho, D. (2002) "Population dynamics of free-floating and attached bacteria in a styrene-degrading biotrickling filter analyzed by denaturing gradient gel electrophoresis." *Applied Microbiology and Biotechnology*, **59**: 585–590.
- USEPA (2002) Office of Air Quality Planning and Standards, *EPA Air Pollution Control Cost Manual*, 6th edition. EPA-452/B-02-001.
- US EPA (2002a) *Regulatory Impact Analysis for the Proposed Automobile and Light Duty Truck Coating NESHAP: Final Report*. EPA-452/R-01-013.
- US EPA (2002b) "National emission standards for hazardous air pollutants: Surface coating of large appliances; Final rule." *Federal Register*, 67(141): 48254–48288.
- US EPA (2002c) *National Emission Standards for Hazardous Air Pollutants (NESHAP) for Source Category: Miscellaneous Metal Parts and Products Surface Coating Operations Technical Support Document*. EPA-453/R-02-0006.
- US EPA (2001) *National Emission Standards for Hazardous Air Pollutants (NESHAP) for Source Category: Metal Furniture Surface Coating, Technical Background Information for Proposed Standards*. EPA-453/R-02-0006.
- van Groenestijn, J.W., and Hesselink, P.G.M. (1993) "Biotechniques for air pollution control," *Biodegradation*, **4**: 283–301.
- van Groenestijn, J.W., van Heiningen, W.N.M., and Kraakman, N.J.R. (2001) "Biofilters based on the action of fungi," *Water Science and Technology*, **44**(9): 227–232.
- Van Lith, C., Leson, G., and Michelson, R. (1997), "Evaluating Design Options for Biofilters." *J. Air & Waste Manage. Assn.*, **47**: 37–48.
- Vatavuk, W.M. (1990) *Estimating Costs of Air Pollution Control*, Lewis Publishers, Chelsea, Michigan.

Wander, J. (1999) Tyndall Air Force Base Paint Spray Booth Emission Records (1999), Personal Communication, November, 1999.

Wani, A. H., Lau, A.K, and Branion, R.M.R. (1998) "Dynamic behavior of biofilters degrading reduced sulfur odorous gases." *Proc., 92nd Annu. Meeting Air & Waste Management Association*, San Diego, California. Abstract No. 98-WAA.03P.

Wariishi, H., Valli, K., Gold, M.H. (1991) "In vitro depolymerization of lignin by manganese peroxidase of *Phanerochaete chrysosporium*," *Biochem. Biophys. Res. Commun.*, **176**: 269–275.

Weber, F.J., and Hartmans, S. (1996) "Prevention of clogging in a biological trickle-bed reactor removing toluene from contaminated air," *Biotechnology and Bioengineering*, **50**: 91–97.

Webster, T.S., Togna, A.P., Yang, Y., and Guarini, W.J. (1998a) "From bench- to pilot-scale experimentation: The treatment of volatile organic compound emissions from a paint spray booth application using biological trickling filtration," *Proc., 91st Annu. Meeting Air & Waste Mgmt. Assn.*, San Diego, California. Abstract No. 98-MP20A.04

Webster, T.S., Tongna, A.P., Guarini, W.J., and McKnight, L. (1998b) "Treatment of volatile organic compound emissions from a paint spray booth application using biological trickling filtration." *Proc. USC-TRG Conf. on Biofiltration*, eds. D.S. Hodge and F.E. Reynolds, Jr., University of Southern California, Los Angeles, California, 41–50.

Webster T.S., Cox H.H.J., Deshusses M.A. (1999) "Resolving operational and performance problems encountered in the use of a pilot/full-scale biotrickling filter reactor," *Environmental Progress*, **18**(3): 162–172.

White, T. J., Bruns, T., Lee, S., and Talor, J. (1990) "Amplification and direct sequencing of fungal ribosomal RNA genes for phylogenetics," pp. 315–322. in M. A. Innis, D. H. Gelfand, J.J. Sninsky, and T. J. White eds., *PCR Protocols: A Guide to Methods and Applications*. Academic Press, San Diego, California.

Whitfield, J.K., Howe, G.B., Pate, B.A., and Wander, J.D. (1993), *Using a Flame Ionization Detector (FID) to Continuously Measure Toxic Organic Vapors in a Paint Spray Booth*, EPA/600/A-92/145

Woertz, J.R., K.A. Kinney and P.J. Szaniszlo. (2001) "A fungal vapor-phase bioreactor for the removal of nitric oxide from waste gas streams." *J. Air & Waste Manage. Assn.*, **51**: 895–902.

Woertz, J.R., Kinney, K.A., McIntosh, N.D.F., and Szaniszlo P.J. (2001) "Removal of toluene in a vapor-phase bioreactor containing a strain of the dimorphic black yeast *Exophiala lecanii-corni*," *Biotechnology and Bioengineering*, **75** (5): 550–558.

Woertz, J.R., van Heiningen, W.N.M., van Eekert, M.H.A., Kraakman, N.J.R., Kinney, K.A., and van Groenestijn, J.W. (2002) "Dynamic bioreactor operation: effects of packing material and mite predation on toluene removal from off-gas." *Applied Microbiology and Biotechnology*, **58**(5): 690–694.

Wright, W. F., Schroeder, E.D., Chang, D.P.Y, and Romstad, K. (1997) "Performance of a pilot-scale compost biofilter treating gasoline vapor," *Journal of Environmental Engineering*, **123**(6): 547–555.

Wright, W.F., Schroeder, E.D., and Chang, D.P.Y. (1998) "Characterization of regular transient loading response of a flow-direction-switching vapor-phase biofilter," *Proc. USC-TRG Conf. on Biofiltration*, D.S. Hodge and F.E. Reynolds, Jr., eds. University of Southern California, Los Angeles, California, October 1998.

Wu, G.; Conti, B., Leroux, A., Brzezinski, R., Viel, G., Heitz, M. (1999) "A high performance biofilter for VOC emission control," *J. Air & Waste Manage. Assn.*, **49**(2): 185-192.

Yaws, C.L. (1999), *Chemical Properties Handbook: Physical, Thermodynamic, Environmental, Transport, Safety, and Health Related Properties for Organic and Inorganic Chemicals*, McGraw-Hill Handbooks, New York.