

Reflective display characterization: temporal and spatial visibility measurements of holographic polymer dispersed liquid crystal (HPDLC) display samples *

Frederick M. Meyer,^a Denise L. Aleva,^a Sam J. Longo,^b Terry L. Trissell,^c
Robert F. Schwartz,^c and Darrel G. Hopper^{a **}

^aAir Force Research Laboratory

Mailing Address: AFRL/HECV 2255 H Street, Bldg 248 Rm 300, Wright Patterson AFB OH 45433-7022
Telephone: (937) 255-8821, *Fax:* (937) 255-8366, *E-mail:* frederick.meyer@wpafb.af.mil

^bL3/Link Simulation & Training

Mailing Address: AFRL/HECI 2210 8th Street, Bldg 146 Rm 122, Wright Patt. AFB OH 45433-7511
Telephone: (937) 255-0241, *Fax:* (937) 904-7122, *E-mail:* sam.longo@wpafb.af.mil

^cNorthrop Grumman, Inc.

Mailing Address: AFRL/HECV 2255 H Street, Bldg 248 Rm 108, Wright Patterson AFB OH 45433-7022
Telephone: (937) 255-8163, *Fax:* (937) 255-8709, *E-mail:* robert.schwartz@wpafb.af.mil

ABSTRACT

Holographically formed polymer dispersed liquid crystal (HPDLC) materials meet the requirements for a video rate reflective display. In order to produce a saturated color from a Bragg reflector, the number of index changing layers becomes critical. The fabrication process affects the number of layers forming the reflector, and, as a result, the bandwidth and optical characteristics, including reflection intensity, direction, and spread, of the reflector. The cell thickness and the liquid crystal mixture affect the voltage at which the cell operates and the speed at which the liquid crystal material can switch from the reflective to non-reflective state. The cell designer is forced to work with all of these design parameters simultaneously. This research continues previous work evaluating reflective HPDLC display samples including a method to measure temporal response and refine color reflection characterization.

Keywords: reflective display measurements, temporal response, refresh rate, persistence

1. INTRODUCTION

The Air Force Research Laboratory Display Characterization Laboratory supports research, acquisition, and operational missions. Our focus is the evaluation of current and upcoming display technologies for specific Air Force applications. This requires an understanding not only of the specific display technology and its capabilities and limitations but also the capabilities and limitations of the human visual system, the tasks to be performed and characteristics of the environment which may affect the operator-display interaction. To this end, the Display Characterization Laboratory conducts both display hardware measurements and assessments of human performance using the displays under expected environmental conditions.¹

* Paper to be submitted for publication in *Cockpit Displays IX: Displays for Defense Applications*, Proceedings of SPIE Vol. 4712 and presented at the conference in Orlando FL on 4 April 2002.

Report Documentation Page

Form Approved
OMB No. 0704-0188

Public reporting burden for the collection of information is estimated to average 1 hour per response, including the time for reviewing instructions, searching existing data sources, gathering and maintaining the data needed, and completing and reviewing the collection of information. Send comments regarding this burden estimate or any other aspect of this collection of information, including suggestions for reducing this burden, to Washington Headquarters Services, Directorate for Information Operations and Reports, 1215 Jefferson Davis Highway, Suite 1204, Arlington VA 22202-4302. Respondents should be aware that notwithstanding any other provision of law, no person shall be subject to a penalty for failing to comply with a collection of information if it does not display a currently valid OMB control number.

1. REPORT DATE 2002		2. REPORT TYPE N/A		3. DATES COVERED -	
4. TITLE AND SUBTITLE Reflective Display Characterization: Temporal and Spatial Viewability Measurements of Holographic Polymer Dispersed Liquid Crystal (HPDLC) Display Samples				5a. CONTRACT NUMBER	
				5b. GRANT NUMBER	
				5c. PROGRAM ELEMENT NUMBER	
6. AUTHOR(S)				5d. PROJECT NUMBER	
				5e. TASK NUMBER	
				5f. WORK UNIT NUMBER	
7. PERFORMING ORGANIZATION NAME(S) AND ADDRESS(ES) Air Force Research Laboratory Wright-Patterson AFB, OH 45433				8. PERFORMING ORGANIZATION REPORT NUMBER	
9. SPONSORING/MONITORING AGENCY NAME(S) AND ADDRESS(ES)				10. SPONSOR/MONITOR'S ACRONYM(S)	
				11. SPONSOR/MONITOR'S REPORT NUMBER(S)	
12. DISTRIBUTION/AVAILABILITY STATEMENT Approved for public release, distribution unlimited					
13. SUPPLEMENTARY NOTES The original document contains color images.					
14. ABSTRACT					
15. SUBJECT TERMS					
16. SECURITY CLASSIFICATION OF:			17. LIMITATION OF ABSTRACT UU	18. NUMBER OF PAGES 15	19a. NAME OF RESPONSIBLE PERSON
a. REPORT unclassified	b. ABSTRACT unclassified	c. THIS PAGE unclassified			

Considerable research has been done with HPDLC material to improve its diffraction efficiency and control the bandwidth and direction of its reflective properties as well as its switching speed.² In order to determine whether a technology is useful for an application the appropriate metric must be applied for evaluation. In this case, the temporal response of HPDLC is to be evaluated for use in a video display application. The properties of HPDLC will not be covered due to the large number of references devoted to the material and fabrication of these devices.^{3, 4, 5} The reflective characterizations performed show further refinement of methods to characterize and document reflection patterns by a simple methodology proving that cost and complexity are not always necessary in test equipment.⁶

Is HPDLC capable of video rate? For a display to be considered useful for video application its pixels must meet a minimum switching speed. The speed must be fast enough to provide a visually smooth motion without complex/expensive electronic circuitry. A typical television type display consists of 480 rows by 320 columns.⁷ To avoid image flicker, for television style viewing, the refresh rate should be 60 Hz or higher.⁸ Since we are considering a matrix LCD type display, it will be addressed as rows for this example. Assuming 320 rows will be scanned to refresh the display, the dwell time for each row is $(1/60) / 320 = 52 \mu\text{s}$. Each row will be refreshed or require a persistence of $1/60$ or 16.7 ms. To achieve a useful display electrically, the data will need to remain at the pixel until it is refreshed again, or the pixel must have enough persistence to maintain an average contrast of 10:1.⁷ This paper is primarily concerned with the switching or dwell time for the material. The persistence can be handled by additional electronic circuitry. We are interested in a dwell time of 50 μs or better.

2. HPDLC REFLECTOR TEMPORAL RESPONSE

2.1 Sample Types and Device Structure (Bragg cell)

The temporal response of the material is accessible, since the HPDLC samples are essentially single pixels or the equivalent of a small group of character elements as shown in figure 1.

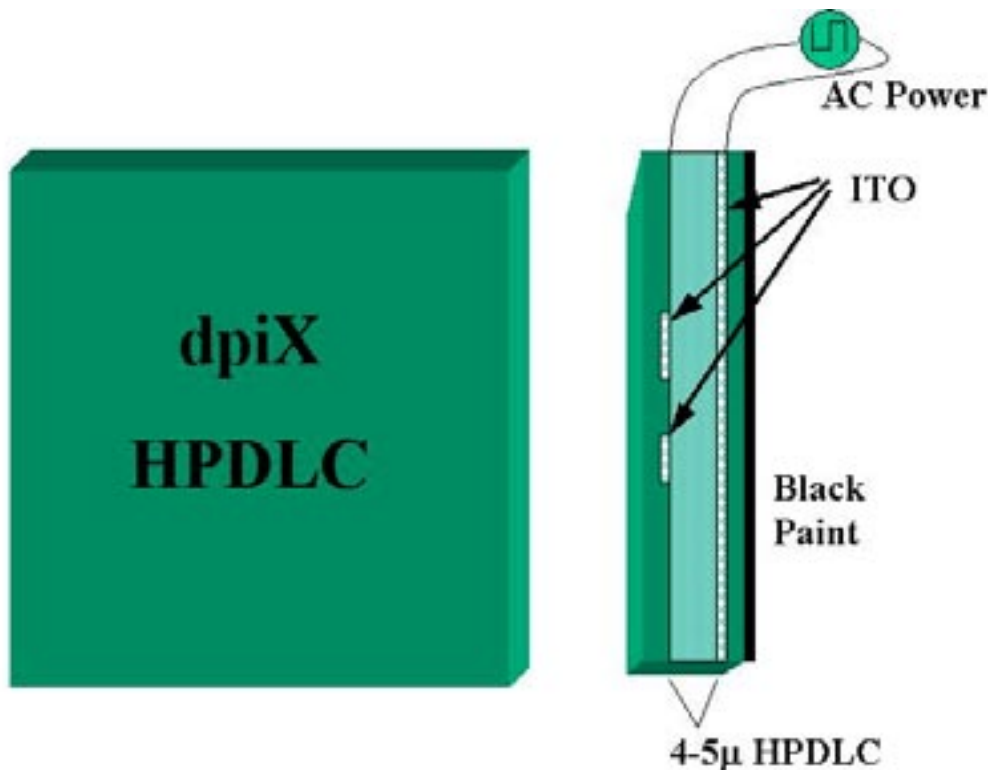

Figure 1. HPDLC display device assembly

2.2 Reflector Temporal Characterization.

2.2.1 Method for Temporal Measurements

The measurement setup is illustrated in Figure 2. The laptop computer was connected to the programmable waveform generator via a GPIB cable. The waveform generator was programmed to output a 1KHz square wave at a periodic rate of 10 Hz at one-thirteenth the amplitude appropriate for the particular sample under test. The waveform generator output was connected to the power amplifier input and the power amplifier output (gain of 13) was connected to the sample. The voltage was monitored by one input of the dual trace oscilloscope. The LS-65-GF light source, with the aperture reduced to 1.5 cm, was set to illuminate the sample at 28 cm from the sample and at an angle of 22.5° from the sample normal.

The PR-1980A photometer was set in the video output mode with the video output from the photometer connected directly to the second channel of the dual trace oscilloscope. The photometer video sensitivity control was set to 1000. The photometer was positioned to pick up a switching character segment of the display at approximately 22.5° opposite the light source at a distance of 127 cm with a two-minute aperture (see Figure 3). The angle was adjusted to pick up the maximum Bragg reflection amplitude. The frustum was placed close to the sample to minimize stray light (see Figure 4).⁹ The delay time in the photometer is approximately 200 ps in this mode (negligible for this data collection). The digital camera was used to photograph the oscilloscope waveforms.

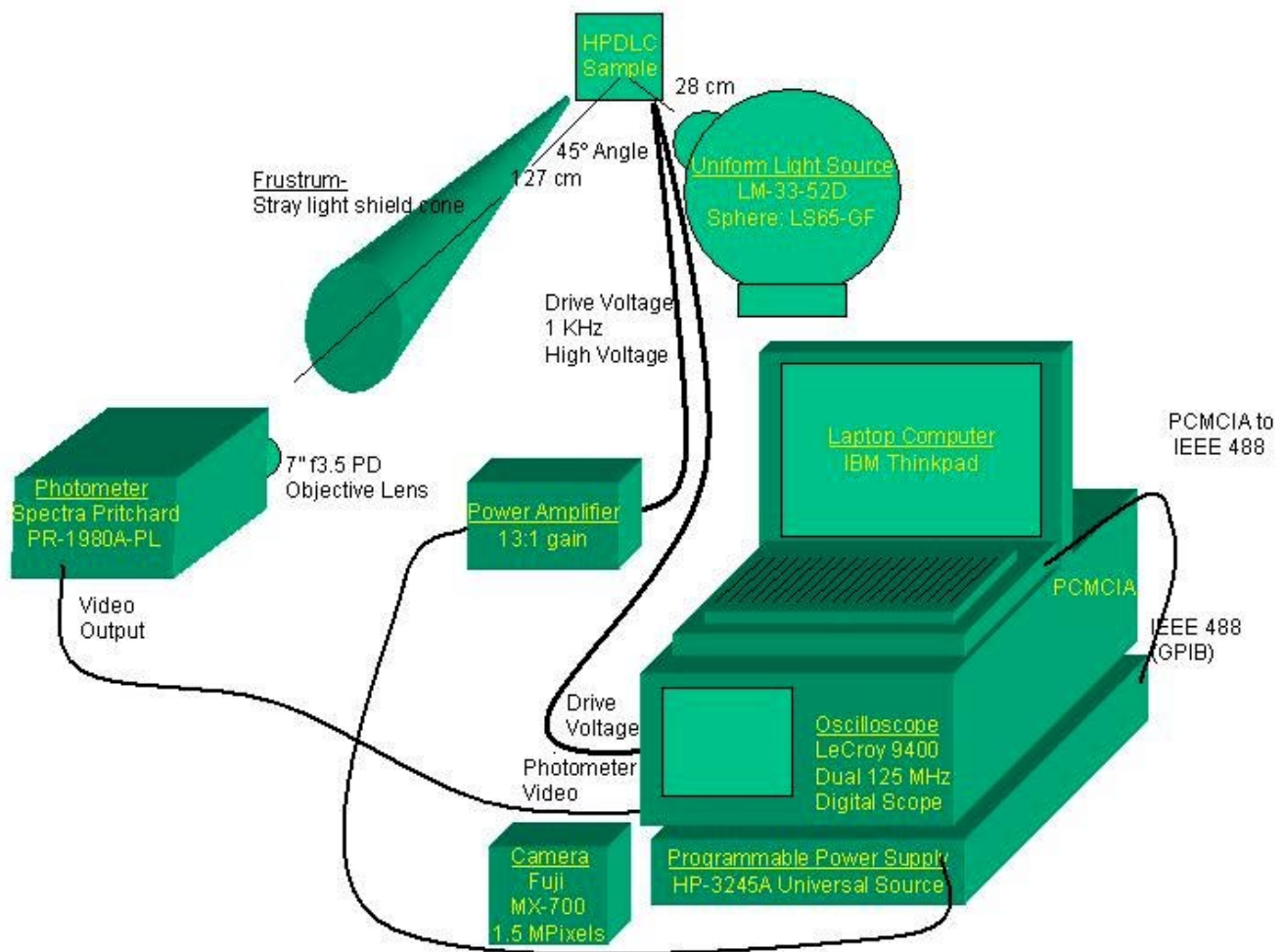

Figure 2. Laboratory test configuration

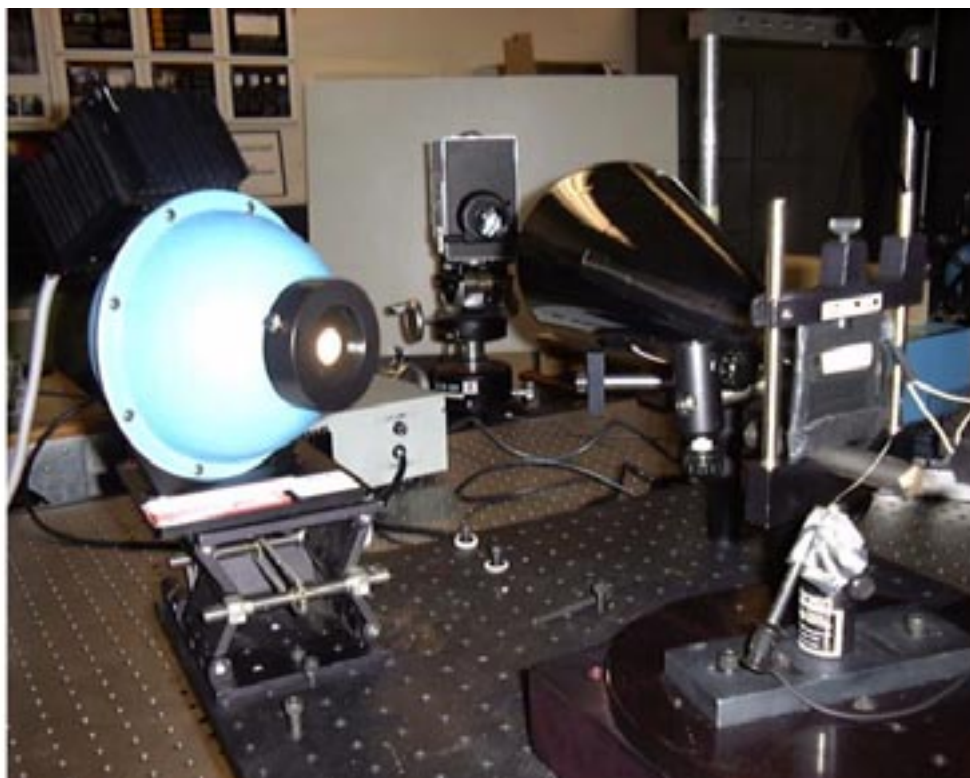

Figure 3. Rear view of sample- front view of light source and photometer

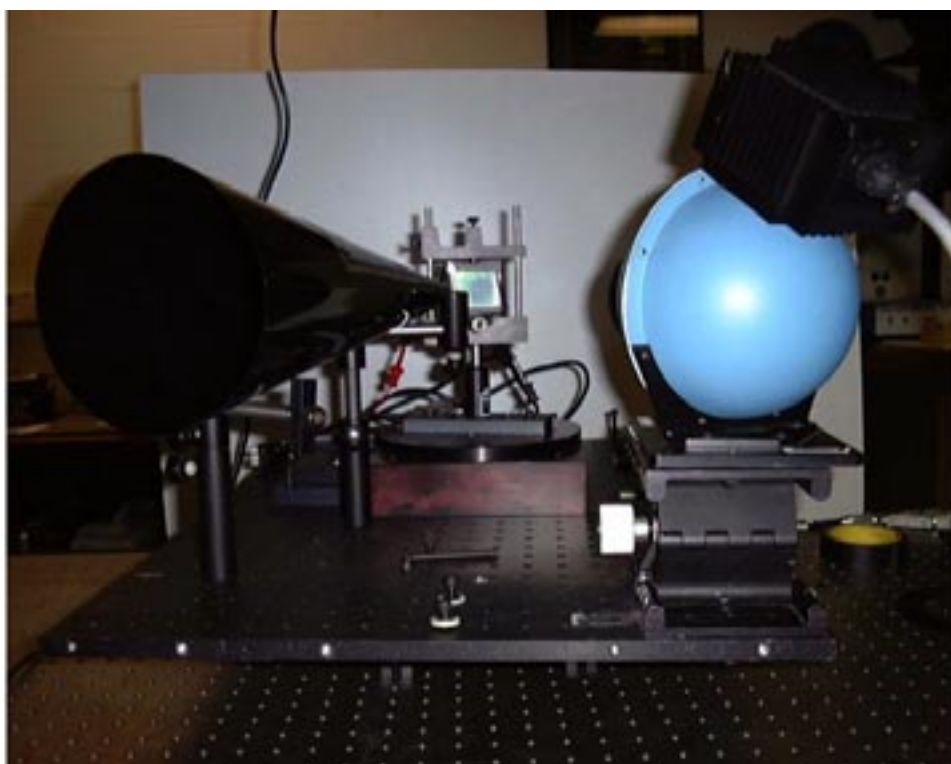

Figure 4. Front view of sample and frustum- rear view of light source

2.2.2 Temporal Data

The data obtained from our measurements and the data reported by dpiX, LLC are shown in Table I and Table II, respectively. Our measured turn on time was very consistent at 50 μ s. Our turn-off time seemed to be affected by the sample temperature as shown in Figures 7, 8, 9, 10, 11, and 12. The initial application of AC power shows a much shorter turn off time than after 50 cycles. Figures 5 and 6 show reference levels for the photometer with zero volts applied to the samples. The top trace, in Figure 5, shows the full reflectance voltage from the photometer, the bottom trace shows the 0 V reference. The top trace in Figure 6 shows the photometer output with the lens covered, the bottom trace shows the 0 V reference. The 0 V reference was adjusted slightly between Figures 7 and 8, and 9, 10, 11, and 12.

Table I. dpiX HPDLC display test articles			
AFRL test results			
Color	Max Driving Voltage	T_{on} (bright to dark)	T_{off} (dark to bright)
Specular Cells			
Red	100	0.05 ms	0.20 ms - 0.50 ms
Green	95	0.05 ms	0.20 ms - 0.50ms
Blue	75	0.05 ms	0.20 ms - 0.30ms
Diffuse Cells			
Red	cell defective		
Green	95	0.05 ms	0.20 ms - 0.25 ms
Blue	110	0.05 ms	0.05 ms
White (red cell)	110	0.05 ms	0.50 ms

Table II. dpiX HPDLC display test articles			
DpiX test results			
Color	Max Driving Voltage	T_{on} (bright to dark)	T_{off} (dark to bright)
Specular Cells			
Red	105	14.80 ms	0.60 ms
Green	95	1.90 ms	1.10 ms
Blue	75	12.10 ms	1.80 ms
Diffuse Cells			
Red	106	2.80 ms	3.20 ms
Green	57	10.30 ms	8.00 ms
Blue	58	0.08 ms	11.30 ms

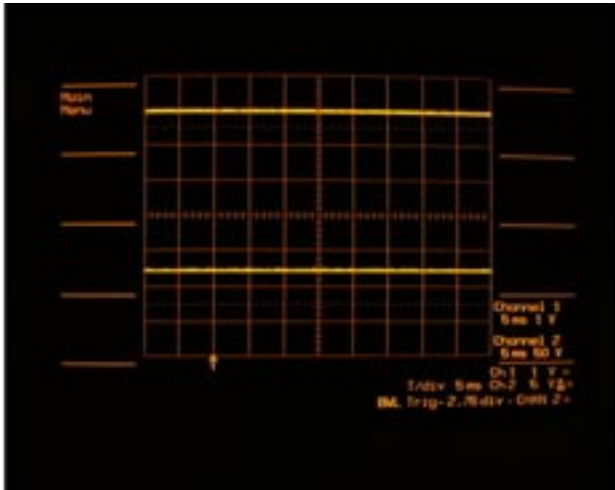

Figure 5. Photometer reference- full reflectance 0 volts

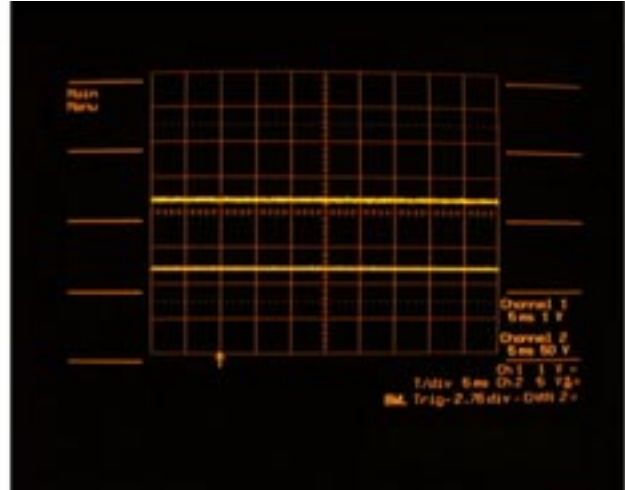

Figure 6. Photometer reference- lens covered 0 volts

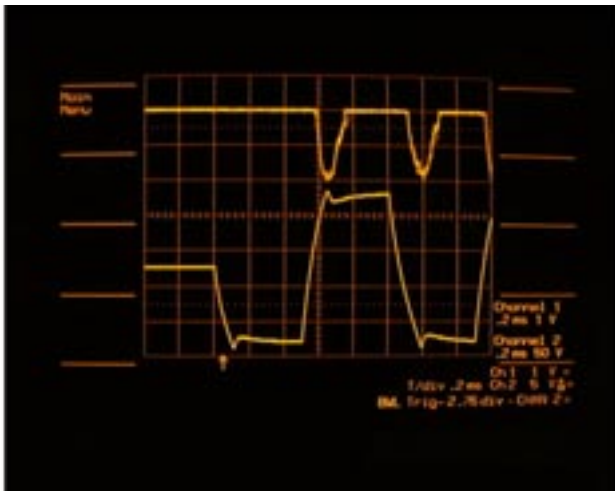

Figure 7. Red Specular turn-on time

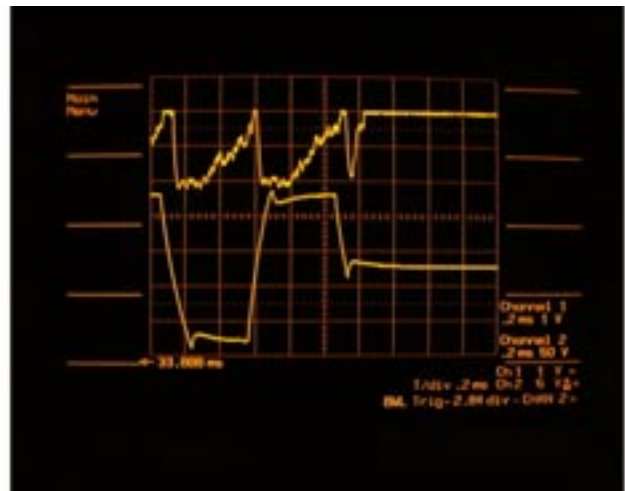

Figure 8. Red Specular turn-off time

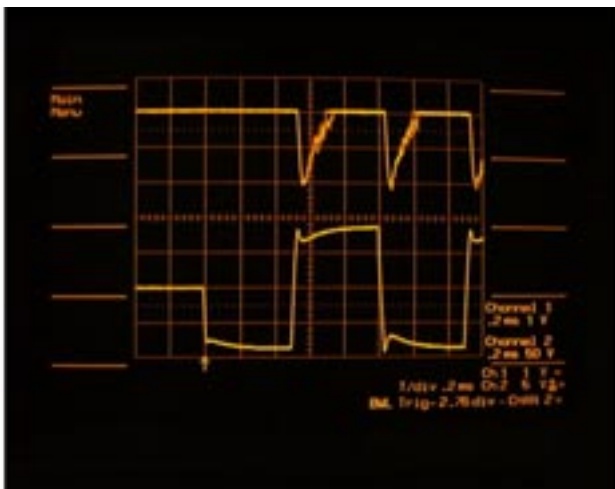

Figure 9. Blue Specular turn-on time

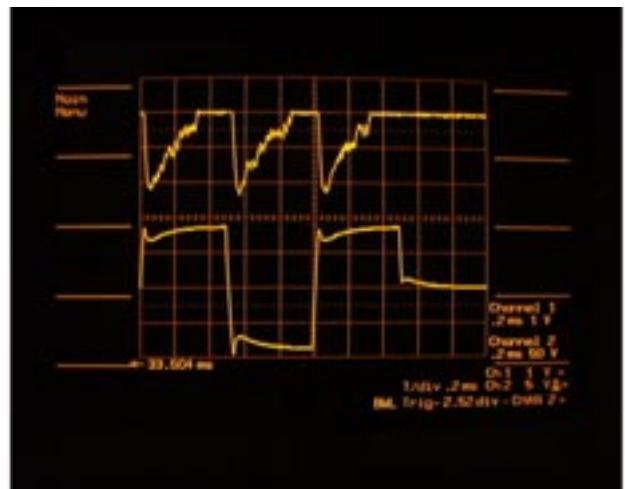

Figure 10. Blue Specular turn-off time

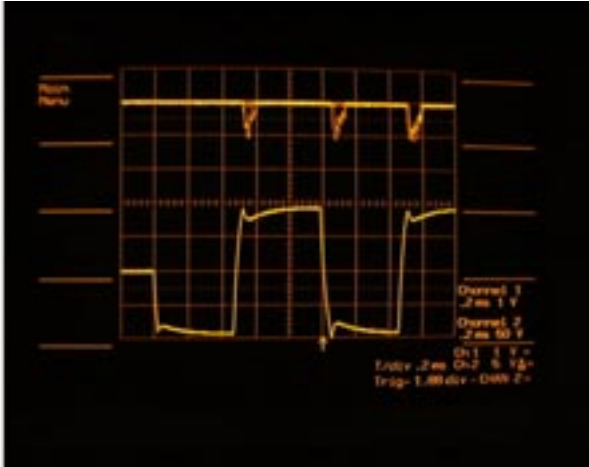

Figure 11. Green Diffuse turn-on time



Figure 12. Green Diffuse turn-off time

3. REFLECTIVE SUBSTRATE REFLECTION CHARACTERISTICS

3.1.1 Reflection Angle and Spread: Alternate Technique

In an earlier paper, Hopper and Meyer (2001) reported results of their attempt to measure the reflection angles of the samples using methodology similar to that for obtaining the bi-directional reflection distribution function as described in the Video Electronics Standards Association (VESA) Flat Panel Display Measurements Standard (1998).⁶ This procedure involved placing the sample on a rotation table along with a light source fixed at -10° off the normal of the sample. The sample and light source were then rotated together and a photometer was used to measure the reflections at one-degree intervals at a sufficient number of angles to span the angular intensity distribution function. Whereas the specular reflection angle from the front glass was at $+10^\circ$, the HPDLC samples were designed to have their peak Bragg plane reflection at about $+20^\circ$ from the sample normal. This procedure worked extremely well for those samples which did, indeed, exhibit peak Bragg plane reflections at or near $+20^\circ$ from the sample normal. However, for some of the samples, the Bragg plane reflections were not where expected.

Limited data was provided by dpiX LLC that was obtained using an ELDIM EZContrast measurement system. While the ELDIM EZContrast measurement system employed by dpiX LLC is ideal for this purpose, the ELDIM system is a very expensive instrument and not available in most laboratories. A simple methodology was devised to get a picture of the reflections from each sample. This methodology also allowed for quantitative measurement of the reflection angle and spread of the samples. This methodology also gives a qualitative view of chromaticity and reflectance variation within a given sample and across samples.

3.1.2 Method

The samples were illuminated with a Labsphere LPS 200 illuminator placed 45 cm from the surface of the sample and at $+10^\circ$ to the sample normal. A sheet of white paper supported by a clipboard was placed approximately 42 cm from the surface of the sample and at the appropriate angle to capture both the specular reflection off the surface of the sample (-10°) and the colored Bragg reflection from within the sample. This set-up is shown in Figure 13.

Each sample was viewed in four orientations: 0° (wires at bottom), 90° (wires left as viewed from back of sample), 180° (wires up) and 270° (wires right as viewed from back of sample). The reflections onto the white paper from the red, green blue and stacked standard and diffuse reflectance samples were photographed with a digital camera.

For all samples listed above, pencil outlines of the reflections were made on the white paper. The distance between the center of the specular reflection from the front surface of the sample and the center of the colored Bragg reflection (standard or diffuse) was measured. The approximate angular distance between the two reflections was calculated by simple geometry; angular distance = \arctan (distance between reflection centers / distance from sample surface to paper). Estimation of spread presented more of a challenge. While the reflection of the standard samples was very well defined, that of the diffuse samples became gradually dimmer as one moves outward from the center of the reflection. For the red and blue diffuse samples the spread was somewhat more of an elliptical pattern than circular and quite dim. Therefore, determination of the outer edge of the spread was somewhat subjective. We also had to take into account the diameter of the incident light beam, as this will affect the spread. Ideally, we would look at spread from a point source. However, as our source produced a collimated beam of light 8 mm in diameter, it was necessary to subtract out the effect of source diameter to get an accurate estimate of spread.

3.1.3 Results

As would be predicted by the construction of the samples, the orientation of the Bragg reflection from within the sample with respect to reflection from the surface of the sample varied with the orientation of the sample. Figure 14 shows the reflections from the four orientations of the red standard reflectance sample. All other samples behaved in a similar manner when rotated.

The digital photographs of the red, green and blue standard reflectance and diffuse reflectance samples are shown in Figures 15-20. The reflections from both the standard reflectance and the diffuse reflectance stacked samples and those from the green, diffuse reflectance clock sample are shown in Figures 21-23.

The distances between the center of the specular reflection from the front surface of the sample and the center of the colored Bragg reflection are listed in Table III along with the spread of the reflection.

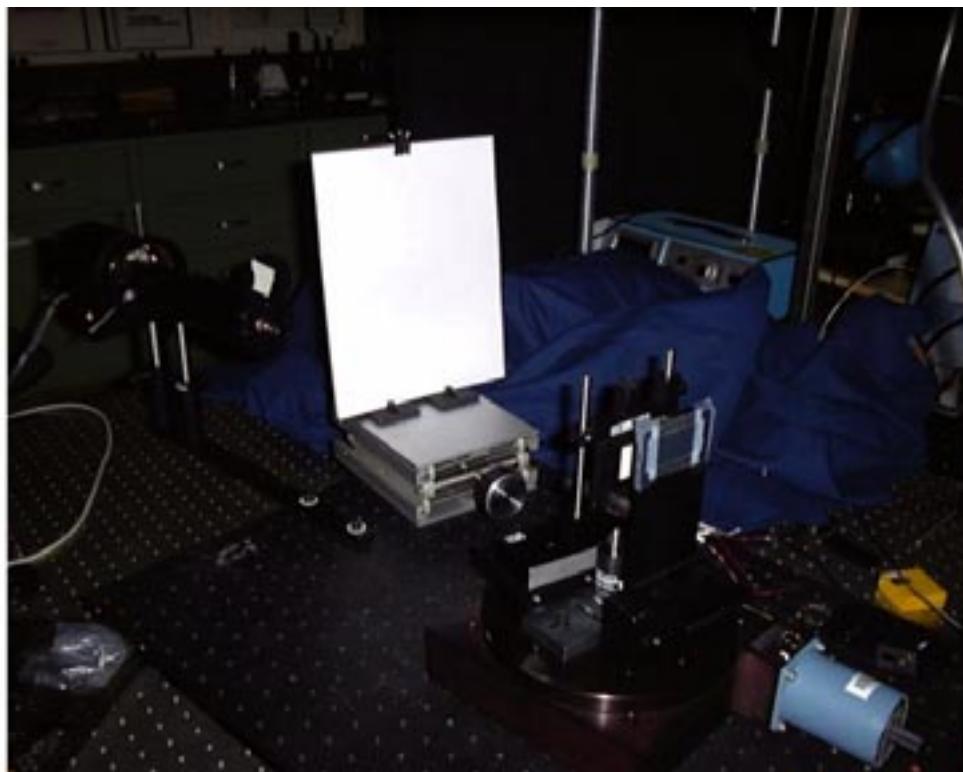

Figure 13. Test set-up for reflection angle evaluation.

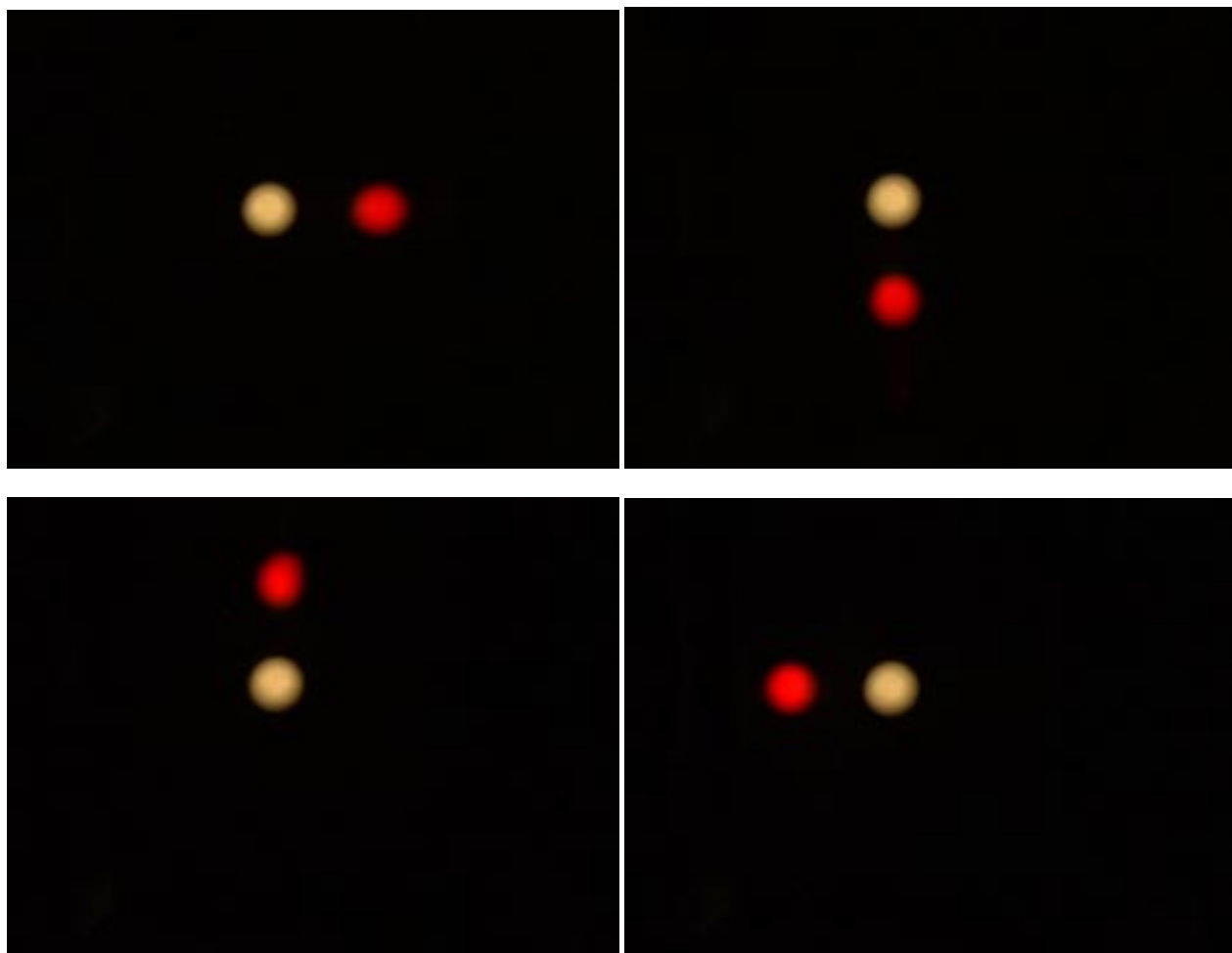
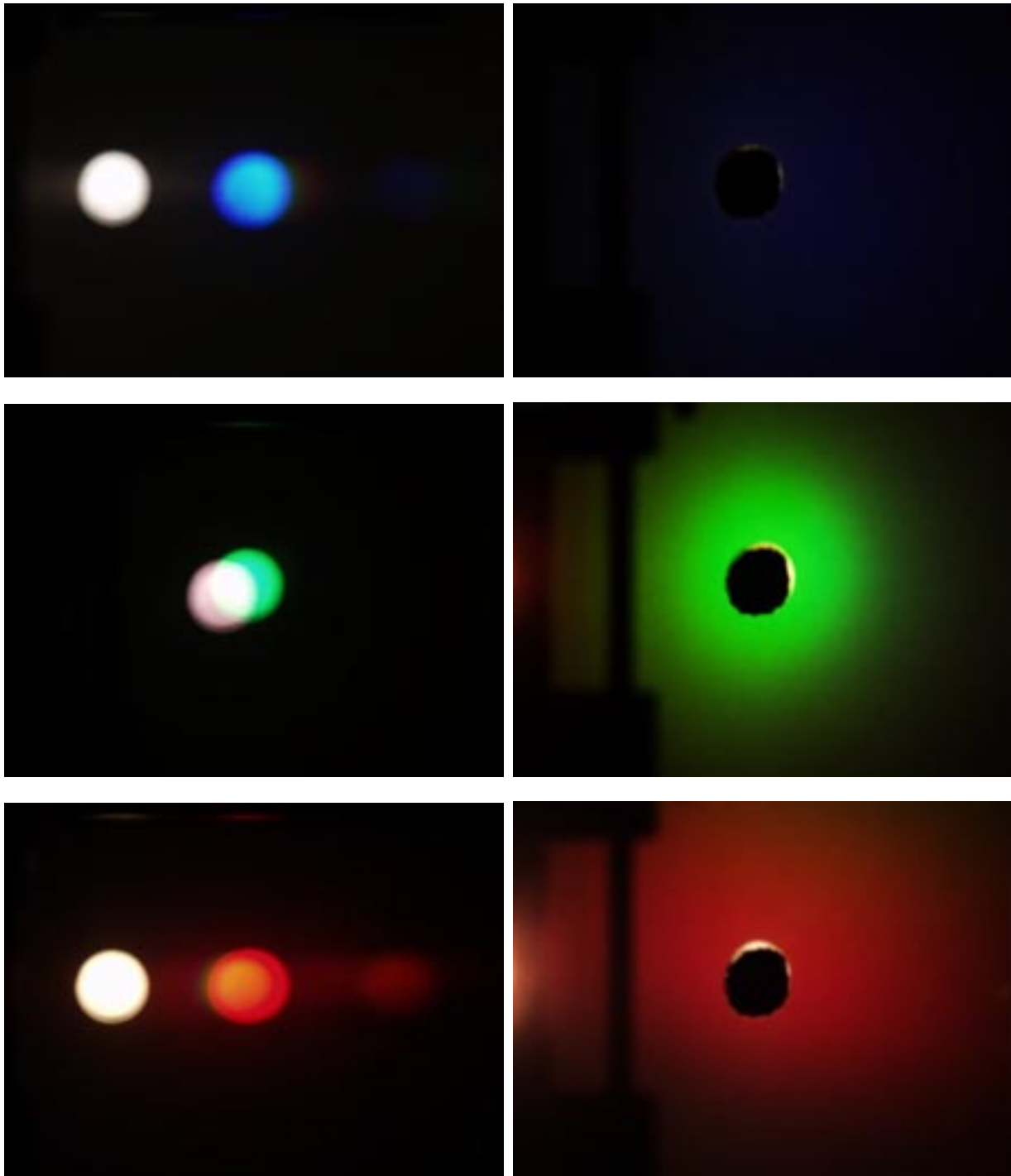
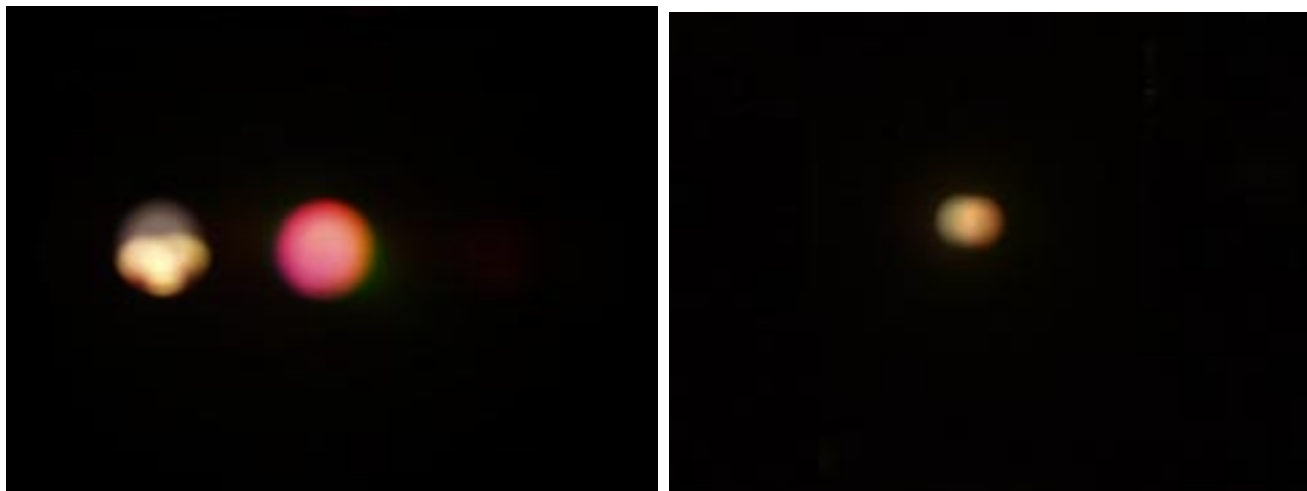

Figure 14. The effect demonstrated by rotating the red standard reflectance sample.



Figures 15 –20. Reflections onto white paper of the blue (top), green (middle) and red (bottom) standard (left) and diffuse (right) reflecting samples. For the standard reflecting samples (left), the specular reflection from the front surface of the sample is to the left of the Bragg plane colored reflection. For the diffuse reflecting samples (right) the specular reflection from the front surface of the sample is located at the black aperture within the diffuse color reflection.



Figures 21 and 22. Reflection onto white paper of the standard reflecting stacked (left) and the diffuse reflecting stacked (right) samples.



Figure 23. Reflections onto white paper of the diffuse reflecting clock sample.

Table III. Approximate angular distance between surface and Bragg reflections for each sample.

Sample	Angular Distance between Reflections (degrees)	Spread of Reflection (degrees)
Red diffuse	1.2	0
Green diffuse	1.0	10
Blue diffuse	2.2	9
Red standard	9.2	<1
Green standard	2.2	<1
Blue standard	9.0	<1
Stacked diffuse	1.2	<1
Stacked standard	9.6	<1
Green diffuse clock	1.0	15

3.2 Reflection Color

Further evaluations were focused on those samples that exhibited enough angular distance between the spectral reflection from the sample surface and the Bragg reflection from within the sample to enable measurement of the Bragg reflections (red diffuse and red, blue and stacked standard). Unless otherwise indicated, all spectral scans and chromaticity and reflectance measurements were conducted using the Instrument Systems Spectro 320 spectroradiometer with a 1.6° measurement aperture.

3.2.1 Method

Spectral response curves and chromaticity coordinates were obtained for the Bragg reflections of the red, blue and stacked standard reflectance samples using the Hoffman LS-65GF sphere illuminator placed at + 10° to the sample normal as the source of illumination. A voltage of 160 V was applied to the various planes of the stacked sample to measure all color combinations achievable. The spectral response curve and chromaticity coordinates of the Bragg reflections of the red diffuse sample were obtained using the Labsphere LPS-200 illuminator placed at +10° to the sample normal as the source of illumination.

3.2.2 Results

The chromaticity coordinates are listed in Table IV. Figure 24 shows the color coordinates of the standard reflectance stacked HPDLC sample in 1976 $u'v'$ color space.

Table IV. Chromaticity coordinates.

Sample	u'	v'
Red standard	0.5045	0.5229
Blue standard	0.1315	0.2043
Red diffuse	0.3941	0.5219
Stacked standard		
White	0.3036	0.4853
Black	0.1798	0.5265
Red	0.3489	0.5221
Green	0.1651	0.5331
Blue	0.2541	0.2783
Cyan	0.1529	0.4442
Magenta	0.3254	0.4627
Yellow	0.3354	0.5254

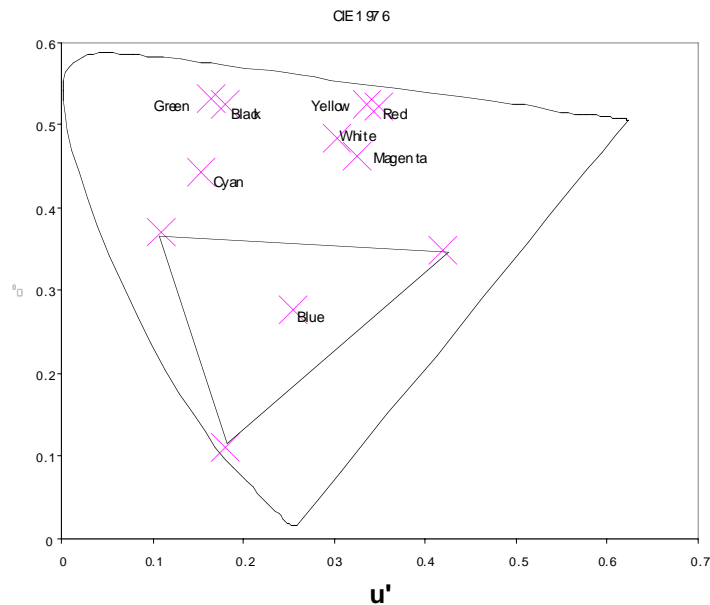

Figure 24. Color coordinates of standard reflectance stacked HPDLC sample in 1976 $u'v'$ color space. The triangle represents the color gamut of a typical CRT.

4. DISCUSSION

The results obtained from testing show that the dwell time (50 μ s) for a 480 x 320 resolution display will be met by the HPDLC response time.⁷ The persistence of 16.7 ms will need to be achieved with an active matrix. The off time (200-500 μ s) is a fraction of the 16.7 ms required for persistence.

The goal of the dpiX LLC effort was to achieve 10° of separation between the surface specular reflection and the Bragg plane reflection. The intensity plots in Figure 25 were provided by dpiX LLC for one standard and one diffuse reflectance sample. It appears that the tic mark at the right side of the 10° circle is the location of the incident light source and that the corresponding high-brightness area on the left side of the 10° circle is the specular reflection from the front surface of the sample. The other high-brightness area at approximately 5° to the right of zero is assumed to be the Bragg plane reflection. This would place this reflection at approximately 15° from the specular. (If the sample were rotated 180°, this reflection should appear at 25° to the left of zero.) This exceeds the goal of 10° separation. A separation of 9-10° was achieved on three of the four standard reflectance samples tested by AFRL. These were the red, blue and stacked standard reflectance samples.

The intensity plot of the diffuse reflectance sample similarly shows the tic mark at the right side of the 10° circle and the corresponding high-brightness area on the left side of the 10° circle. The plot also shows an area centered on zero and having spread of approximately 10°. The intensity of this area decreases from the center outward. This is assumed to be the diffuse Bragg plane reflection. This reflection center is, indeed, shown to be approximately 10° removed from the front surface reflection and would meet the goal of this development effort. However, all diffuse reflectance samples tested by AFRL exhibited 2.3° separation or less.

The color gamut of the stacked standard reflectance sample was found to be quite different from that of a typical CRT display. The chromaticity coordinates in Figure 24 represent the color gamut of the stacked standard reflectance sample. The triangle in the same figure represents the color gamut of a typical CRT. The HPDLC color gamut has little overlap with that of a typical CRT. The HPDLC red is more of an orange-red, the HPDLC green more a yellow-green and the HPDLC blue less saturated than that of the CRT. Therefore, human factors research may be needed to address color recognition and discriminability within this color gamut.

An external light source is required to produce reflection from the Bragg planes. The characteristics of the incident light will affect the chromaticity reflected and the spread of the reflection. The reflections from the diffuse reflecting samples are very dim (Meyer and Hopper, 2001); considerable incident light would be required to make these colors visible.

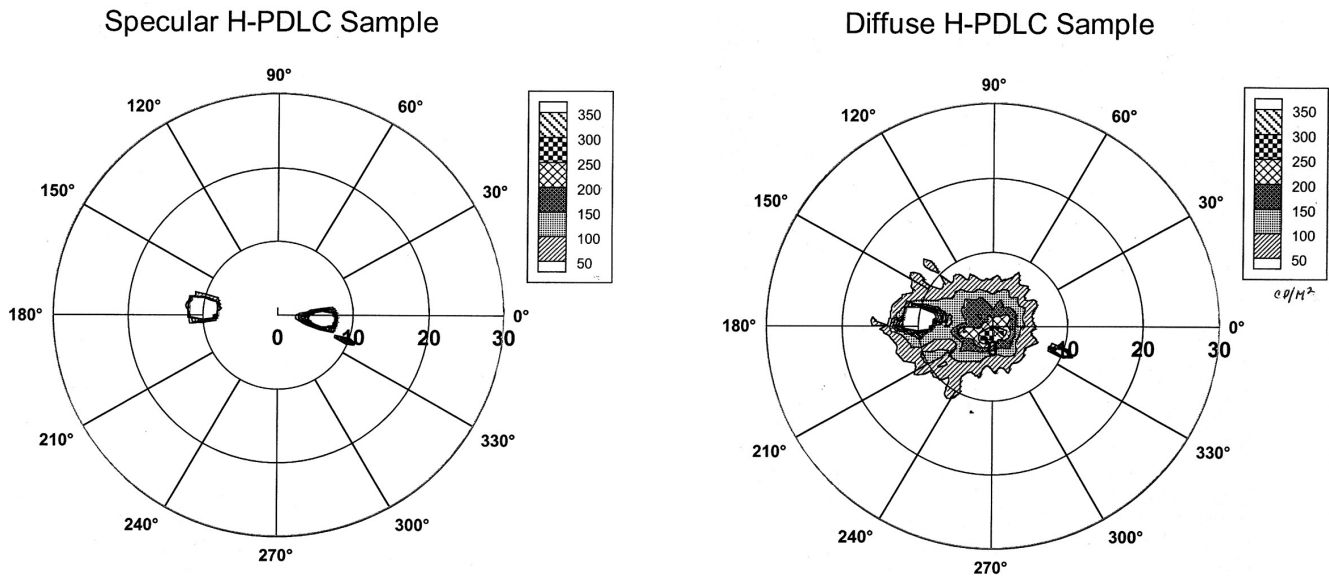

Figure 25. Reflection data provided by dpiX LLC for one specular (standard) reflectance sample (left) and one diffuse reflectance sample (right).

The stacked cell was found to be susceptible to heat damage when voltage was applied. The internal structure seemed to delaminate resulting in interference patterns.

5. SUMMARY

We have tried to show that HPDLC has the electrical and optical properties worth pursuit for display applications.¹⁰ The electrical issues show that the response time and current operating voltages are similar to electroluminescent-type display materials.⁷ Gray scale will need to be addressed by the refresh repetition rate instead of in an analog fashion as with an AMLCD. The optical characteristics have the potential to expand the color gamut of CRTs and do not exhibit the gray scale inversion characteristics of traditional active matrix liquid crystal displays; however, there is color shift.¹¹

There is a clear disparity between our results and those reported by dpiX for, purportedly, the same samples. The dpiX claims for 10° offset, diffuse angle of view, and timing cannot be supported. A different research group should fabricate new samples in order to ascertain if the dpiX fabrication approach is valid.

6. ACKNOWLEDGEMENTS

We thank DARPA for providing the funding to research this technology under contract F33615-96-2-1940. Also, dpiX, LLC for providing samples to test and evaluate. Dr. Tim Bunning with the Air Force Research Laboratory Materials Directorate Polymers Branch and Dr. Vince Tondiglia with Systems Application International Corp. for providing guidance and equipment for completing the timing tests. Finally, Dr. Lee Task provided guidance in conducting the reflection characterizations.

7. REFERENCES

1. T.W. Jackson, R. Daniels, D. G. Hopper, "Flat panel display test and evaluation: procedures, standards and facilities," in *Cockpit Displays IV: Flat Panel Displays for Defense Applications*, Darrel G. Hopper, Editor, Proceedings of SPIE Volume 3057, pp. 514-525 (1997)
2. T. J. Bunning, L. V. Natarajan, R. L. Sutherland, V. Tondiglia, "Switchable Reflective Displays Formed from H-PDLCs," *SID Symposium Digest Volume XXXI*, pp. 121-123 (2000).
3. L. Domash, G. Crawford, A. Ashmead, R. Smith, M. Popovich, J. Story, "Holographic PDLC for Photonic Applications", in *Liquid Crystals IV*, Iam-Choon Khoo, Editor, Proceedings of SPIE Volume 4107, pp. 46-57 (2001)
4. H. Yaun, G. Hu, T. Fiske, A. Lewis, J. E. Gunther, L. D. Silverstein, C. Bowley, G. P. Crawford, L.-C. Chien, and J. R. Kelly, "High Efficiency Color Reflective Displays with Extended Viewing Angle," Proceedings of the 18th International Display Research Conference, p.1136 (1998)
5. T. Fiske, J. Colegrove, A. Lewis, H. Tran, L. Silverstein, G. P. Crawford, and J. R. Kelly, "Advances and applications for color HPDLC reflective technologies," in *Cockpit Displays VII: Displays for Defense Applications*, Darrel G. Hopper, Editor, Proceedings of SPIE Volume 4022, pp. 216-226 (2000).
6. F. Meyer, and D. Hopper, "Holographic polymer dispersed liquid crystal sample characterization," in *Cockpit Displays VIII: Displays for Defense Applications*, Darrel G. Hopper, Editor, Proceedings of SPIE Volume 4362, pp. 255-267 (2001).
7. L. Tannas, *Flat Panel Displays and CRTs*, Van Nostrand Reinhold Company, Inc., New York, 1985. p. 20, 24
8. A. Inglis and A. Luther, *Video Engineering*, McGraw-Hill, New York, 1996, pp. 11
9. VESA, *Flat Panel Display Measurement Standard*, Ver 1.0, (June 9, 1998)
10. S. Qian, J. Colegrove, P. Liu, and X. Quan, "Organic-based Electrically switchable Bragg gratings and their applications in photonics and telecommunications," in *Organic Photonic Materials and Devices III*, Bernard Kippelen and Donald Bradley, Editors, Proceedings of SPIE Volume 4279, 69-77 (2001).
11. M. J. Escuti, P. Kossyrev, C. C. Bowley, S. Danworaphong, G. P. Crawford, T. G. Fiske, J. Colegrove, L. D. Silverstein, A. Lewis, and H. Yaun, "Diffuse H-PDLC Reflective Displays: An Enhanced Viewing-Angle Approach," *SID International Symposium Digest of Technical Papers*. pp 766-769 (2000)