



NAVFAC
Naval Facilities Engineering Command

ENGINEERING SERVICE CENTER
Port Hueneme, California 93043-4370

CONTRACT REPORT
CR-005-001-ENV

COST AND PERFORMANCE REPORT OF
DISSOLVED HYDROGEN ANALYZER

Prepared by

CDM
Bellevue WA 98005

Prepared for:

Naval Facilities Engineering Service Center

January 2005

Approved for public release; distribution is unlimited.



Printed on recycled paper

REPORT DOCUMENTATION PAGE				<i>Form Approved</i> OMB No. 0704-0811	
<p>The public reporting burden for this collection of information is estimated to average 1 hour per response, including the time for reviewing instructions, searching existing data sources, gathering and maintaining the data needed, and completing and reviewing the collection of information. Send comments regarding this burden estimate or any other aspect of this collection of information, including suggestions for reducing the burden to Department of Defense, Washington Headquarters Services, Directorate for Information Operations and Reports (0704-0188), 1215 Jefferson Davis Highway, Suite 1204, Arlington, VA 22202-4302. Respondents should be aware that notwithstanding any other provision of law, no person shall be subject to any penalty for failing to comply with a collection of information, if it does not display a currently valid OMB control number.</p> <p>PLEASE DO NOT RETURN YOUR FORM TO THE ABOVE ADDRESS.</p>					
1. REPORT DATE (DD-MM-YYYY) January 2005		2. REPORT TYPE Final		3. DATES COVERED (From - To) N/A	
4. TITLE AND SUBTITLE COST AND PERFORMANCE REPORT OF DISSOLVED HYDROGEN ANALYZER				5a. CONTRACT NUMBER	
				5b. GRANT NUMBER	
				5c. PROGRAM ELEMENT NUMBER	
6. AUTHOR(S) Carmen Lebron (PI) NFESC; Barbara Sugiyama NFESC; Patrick Evans, Ph.D. (Co-PI) CDM; Mary Trute CDM; Roger Olsen, Ph.D. CDM; John Eisenbeis, Ph.D. CDM; Frank Chappelle, Ph.D. USGS				5d. PROJECT NUMBER	
				5e. TASK NUMBER	
				5f. WORK UNIT NUMBER	
7. PERFORMING ORGANIZATION NAME(S) AND ADDRESSES Commanding Officer Naval Facilities Engineering Service Center 1100 23 rd Avenue Port Hueneme, CA 93043				8. PERFORMING ORGANIZATION REPORT NUMBER CR-05-001-ENV	
9. SPONSORING/MONITORING AGENCY NAME(S) AND ADDRESS(ES) ESTCP 901 N. Stuart St., Suite 303 Arlington, VA 22203-1853				10. SPONSOR/MONITORS ACRONYM(S)	
				11. SPONSOR/MONITOR'S REPORT NUMBER(S)	
12. DISTRIBUTION/AVAILABILITY STATEMENT Approved for public release; distribution is unlimited.					
13. SUPPLEMENTARY NOTES					
14. ABSTRACT <p>Monitored natural attenuation (MNA) is a cost-effective remediation approach that is applicable to many sites and has been embraced by the U.S. Department of Defense (DOD). Monitored natural attenuation can be used to mitigate petroleum hydrocarbon, chlorinated hydrocarbon, and metal-contaminated sites as an alternative to groundwater pump and treat methods.</p> <p>Determination of MNA's technical applicability for a given site is based on sampling and analysis, data evaluation and modeling, and long-term monitoring. Parameters that are evaluated include concentrations of contaminants, electron acceptors, and electron donors. These concentrations in combination with hydrogeologic, soil, and microbial characteristics are used to assess the fate and transport of contaminants and the potential for natural attenuation.</p> <p>This report describes the demonstration of a novel analytical technology: a dissolved hydrogen (DH) analyzer. The report describes demonstration of the DH analyzer at three Department of Defense (DoD) sites as well as supplemental development of the DH analyzer.</p>					
15. SUBJECT TERMS Monitored natural attenuation (MNA), biodegradation, in situ, dissolved hydrogen, dissolved gases					
16. SECURITY CLASSIFICATION OF:			17. LIMITATION OF ABSTRACT	18. NUMBER OF PAGES 33	19a. NAME OF RESPONSIBLE PERSON
a. REPORT U	b. ABSTRACT U	c. THIS PAGE U			19b. TELEPHONE NUMBER (include area code)

Environmental Security Technology Certification Program (ESTCP)

Cost and Performance Report Dissolved Hydrogen Analyzer ESTCP Project Number 200009

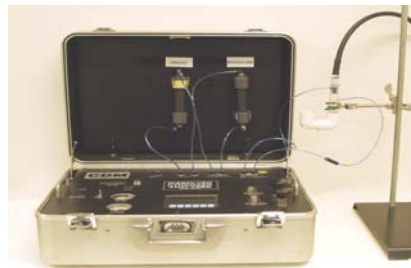

**December 2004
Final**

Table of Contents

1.0 Executive Summary	1
1.1 Background	1
1.2 Objectives of the Demonstration	1
1.3 Regulatory Drivers.....	2
1.4 Demonstration Results	2
1.5 Stakeholder/End-User Issues	2
2.0 Technology Description.....	3
2.1 Technology Development and Application	3
2.2 Process Description.....	3
2.3 Previous Testing of the Technology	6
2.4 Advantages and Limitations of the Technology	6
3.0 Demonstration Design	7
3.1 Performance Objectives	7
3.2 Selection of Test Sites.....	7
3.3 Test Site Descriptions	9
3.3.1 Site 1 – SUBASE Bangor	9
3.3.2 Site 2 – Fort Lewis.....	9
3.3.3 Site 3 – NAS Pensacola	9
3.4 Physical Set-up and Operation.....	9
3.5 Sampling/Monitoring Procedures	10
3.6 Analytical Procedures	10
4.0 Performance Assessment	14
4.1 Performance Data.....	14
4.2 Performance Criteria.....	15
4.3 Data Assessment	18
4.4 Technology Comparison.....	19
5.0 Cost Assessment	20
6.0 Implementation Issues	21
6.1 Cost Observations	21
6.2 Performance Observations	21
6.3 Scale-up.....	21
6.4 Other Significant Observations.....	21
6.5 Lessons Learned.....	21
6.6 End-User Issues	21
6.7 Approach to Regulatory Compliance and Acceptance	22
7.0 References.....	23
8.0 Points of Contact.....	24
Appendix A Bubble Strip Method for Analyzing Dissolved Hydrogen.....	25

List of Figures

- 2-1 Dissolved Hydrogen Analyzer
- 2-2 Dissolved Hydrogen Analyzer Implementation
- 2-3 DH Analyzer Process Flow Diagram
- 3-1 SUBASE Bangor Sample Collection Points
- 3-2 Fort Lewis, Washington Sample Collection Points
- 3-3 NAS Pensacola Sample Collection Points
- 4-1 Site 1 (SUBASE Bangor) Dissolved Hydrogen Data
- 4-2 Site 2 (Ft. Lewis) Dissolved Hydrogen Data
- 4-3 Site 3 (NAS Pensacola) Dissolved Hydrogen Results

List of Tables

- 3-1 Performance Objectives
- 4-1 Performance Criteria
- 4-2 Expected Performance and Performance Confirmation Methods

Acronyms and Abbreviations

AFB	Air Force Base
bgs	below ground surface
CDM	Camp Dresser & McKee Inc.
cDCE	<i>cis</i> -1,2-dichloroethene
CV	Coefficient of variation
DH	dissolved hydrogen
DoD	Department of Defense
EA	EA Engineering, Science, and Technology
EGDY	East Gate Disposal Yard
EPA	Environmental Protection Agency
ESTCP	Environmental Security Technology Certification Program
GLE	gas-liquid equilibration
HRC	Hydrogen Release Compound
H ₂ S	hydrogen sulfide
MGC	Anaeropack TM
mL	milliliter
mL/min	milliliters per minute
MNA	monitored natural attenuation
NAS	Naval Air Station
NATS	Natural Attenuation Test Site
NFESC	Naval Facilities Engineering Service Center
nM	nanomolar
OU8	Operable Unit 8
ppm	parts per million
PVC	polyvinyl chloride
PWIA	Public Works Industrial Area
r ²	correlation coefficient
RABITT	Reductive Anaerobic <i>In Situ</i> Treatment Technology
SBIR	Small Business Innovative Research
TCE	trichloroethene
TEAP	terminal electron acceptor products

USGS	United States Geologic Survey
UST	underground storage tank
VC	vinyl chloride
VDC	volt direct current
VOC	volatile organic compounds

Acknowledgements

This report describes the demonstration of a novel analytical technology: a dissolved hydrogen (DH) analyzer. The report describes demonstration of the DH analyzer at three Department of Defense (DoD) sites as well as supplemental development of the DH analyzer.

Several individuals and organizations contributed to completion of this project and are listed below:

Carmen A. Lebrón (PI)	Naval Facilities Engineering Service Center (NFESC)
Barbara Sugiyama	NFESC
Patrick J. Evans, Ph.D. (Co-PI)	CDM
Mary Trute	CDM
Roger Olsen, Ph.D.	CDM
John Eisenbeis, Ph.D.	CDM
Frank Chapelle, Ph.D.	United States Geological Survey (USGS)

Additionally, the support of personnel at SUBASE Bangor, Ft. Lewis, and NAS Pensacola is gratefully acknowledged.

1.0 Executive Summary

1.1 Background

Monitored natural attenuation (MNA) is a cost-effective remediation approach that is applicable to many sites and has been embraced by the U.S. Department of Defense (DoD). Monitored natural attenuation can be used to mitigate petroleum hydrocarbon, chlorinated hydrocarbon, and metal-contaminated sites as an alternative to groundwater pump and treat methods.

Determination of MNA's technical applicability for a given site is based on sampling and analysis, data evaluation and modeling, and long-term monitoring. Parameters that are evaluated include concentrations of contaminants, electron acceptors, and electron donors. These concentrations in combination with hydrogeologic, soil, and microbial characteristics are used to assess the fate and transport of contaminants and the potential for natural attenuation.

Concentrations of electron acceptors or their reduced products are typically used to:

1. Identify terminal electron accepting processes (TEAP) responsible for contaminant biodegradation that are occurring in specific areas of a contaminant plume, and
2. Quantify assimilative capacity of an aquifer for contaminants of concern.

TEAPs affect *in situ* transformation of many pollutants in part by their impact on dissolved hydrogen (DH) concentrations in groundwater. Identification of TEAPs and DH concentrations can indicate specific degradation patterns of contaminants such as chlorinated hydrocarbons and benzene.

Although DH measurements are proven to be a useful tool to delineate the TEAPs in aquifers, this parameter is not measured in the field due to the expensive analytical equipment that is required. A portable DH analyzer was invented and developed by CDM. Such an analyzer does not exist elsewhere and the only other means available to measure DH in the field at the required low concentrations involves use of the "bubble-strip" method in conjunction with a reduction gas analyzer (Chapelle et al., 1997). This method is difficult to perform, time-consuming, and expensive; therefore, it has not gained widespread acceptance as a field analytical method.

1.2 Objectives of the Demonstration

The main objectives of this demonstration were to:

- Validate the DH analyzer by determining the correlation between the DH analyzer results and those obtained using the standard bubble strip/reduction gas analyzer method.
- Quantify operational costs associate with using the DH analyzer

Performance of the DH analyzer was evaluated based on the following criteria:

- **Accuracy** as demonstrated by a one-to-one correlation between the standard bubble strip method and the novel analyzer.
- **Range** as demonstrated by a response from less than 0.2 nM to greater than 10 nM DH.
- **Precision** as demonstrated by a low coefficient of variation amongst replicate analyses.
- **Sample throughput** as demonstrated by low analysis time relative to the bubble-strip method.
- **Mechanical reliability** as demonstrated by a low incidence of failure.
- **Versatility** as demonstrated by acceptable performance at all three sites.

1.3 Regulatory Drivers

Dissolved hydrogen is referenced in the EPA technical guidance on natural attenuation of chlorinated solvents (EPA, 1998); however, analysis of this analyte is not required at this time and is considered optional by regulatory agencies. Additionally, no method for DH measurement has been approved by any regulatory agency.

1.4 Demonstration Results

At each of the three demonstration sites DH measurements were taken from 10 monitoring wells using the DH analyzer and the reference (bubble strip) method. The correlation coefficients for the two methods for Sites 1, 2, and 3 were 0.80, 0.24, and 0.01, respectively. The variability of correlation of the DH analyzer results to bubble strip method results has been determined to be most likely due to interferences from dissolved gases [primarily methane and hydrogen sulfide (H₂S)] in the groundwater analyzed. Specifically, the ability of the various hydrogen sensors tested to accurately measure gaseous hydrogen was negatively impacted by the presence of other gases that partitioned from groundwater during gas-liquid equilibration (GLE).

The interference of other dissolved gases impacted how the DH analyzer performed against several performance criteria, including accuracy, precision, sensitivity, and range. It was evident that further investigation and testing of hydrogen sensors not susceptible to interference by other dissolved gases would be required for the DH analyzer to be a reliable field instrument. Additionally, the viability, or lack thereof, of the DH analyzer could not be demonstrated at this time because of poor precision (e.g., coefficient of variation of 17 to 67 percent) of the standard reference method (i.e., the bubble strip method). Therefore, ESTCP discontinued further demonstration of the analyzer.

1.5 Stakeholder/End-User Issues

These demonstrations showed that while the DH analyzer is not yet ready for commercialization, with further development it can be a valuable tool for providing accurate field analyses of dissolved hydrogen. This further development needs to focus on development of better sensors, addition of better adsorbents for interfering gas removal, development of leak detection systems, and improvement of mechanical stability.

2.0 Technology Description

2.1 Technology Development and Application

The DH analyzer was largely developed under a Phase II Small Business Innovative Research (SBIR) grant funded by the Air Force and was documented in AGI 1999. The intended use is site characterization and monitoring in MNA applications and enhanced bioremediation projects. During site characterization, DH measurements can indicate the dominant TEAPs in different areas of a given site. Knowledge of these TEAPs can allow scientists, engineers, and regulators to begin to make predictions as to the potential fate of various contaminants of concern. For example, a DH of 0.2 to 0.8 nanomolar (nM) can indicate that iron reduction is dominant. This TEAP may suggest that reduction of *cis*-1,2-dichloroethene (cDCE) to vinyl chloride (VC) or ethene is unlikely to be significant. It may also suggest that oxidative mineralization of cDCE or VC to carbon dioxide may occur. Understanding the potential for these different pathways is one of the first steps to documenting natural attenuation at a site. The DH analyzer can also be used to monitor the progress of a natural attenuation remedy. If reductive dechlorination of trichloroethene (TCE) to ethene is the basis of natural attenuation at a given site, it is likely predicated on maintenance of a methanogenic TEAP. Verification that DH is being maintained within the methanogenic TEAP range (5 to 20 nM) can be accomplished only if DH measurement is practical. In addition to MNA, DH measurement can be used to monitor and assess performance of enhanced anaerobic bioremediation remedies. These remedies include injection of electron donors such as molasses, volatile fatty acids (e.g., via Reductive Anaerobic *In Situ* Treatment Technology or “RABITT”), lactic acid, or commercial products such as Regenesis' Hydrogen Release Compound (HRC[®]). This technology is used to increase DH concentrations and in turn promote reductive dechlorination of chlorinated organics such as TCE. DH measurement can be used to monitor whether these increased DH concentrations are being attained and whether sufficient electron donor is being injected.

2.2 Process Description

The DH analyzer is a field-ready instrument that is enclosed in a protective case (**Figures 2-1 and 2-2**) operates off of a 12-volt DC current power supply and is connected to the discharge of a groundwater extraction pump such as a bladder pump. **Figure 2-3** is a schematic of the DH analyzer. Groundwater is pumped into the analyzer and passes through a gas-liquid equilibration (GLE) device that transfers dissolved hydrogen from groundwater to a carrier gas. The carrier gas is then treated by a series of catalysts to remove interfering gases. The hydrogen in the treated carrier gas is then measured using a highly sensitive solid-state sensor. The analyzer is controlled by a microprocessor, and initial data indicated a linear response that is sensitive to less than 0.2 nM can be attained. Further information on the technology theory can be found in the references (Evans, 2001a, b, and c).

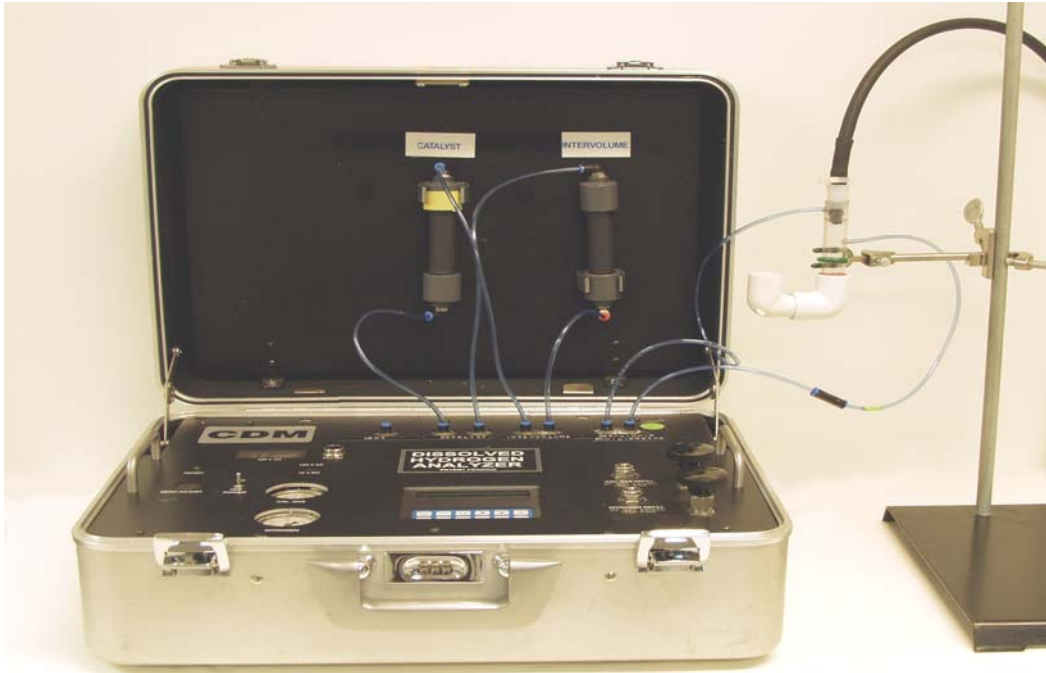
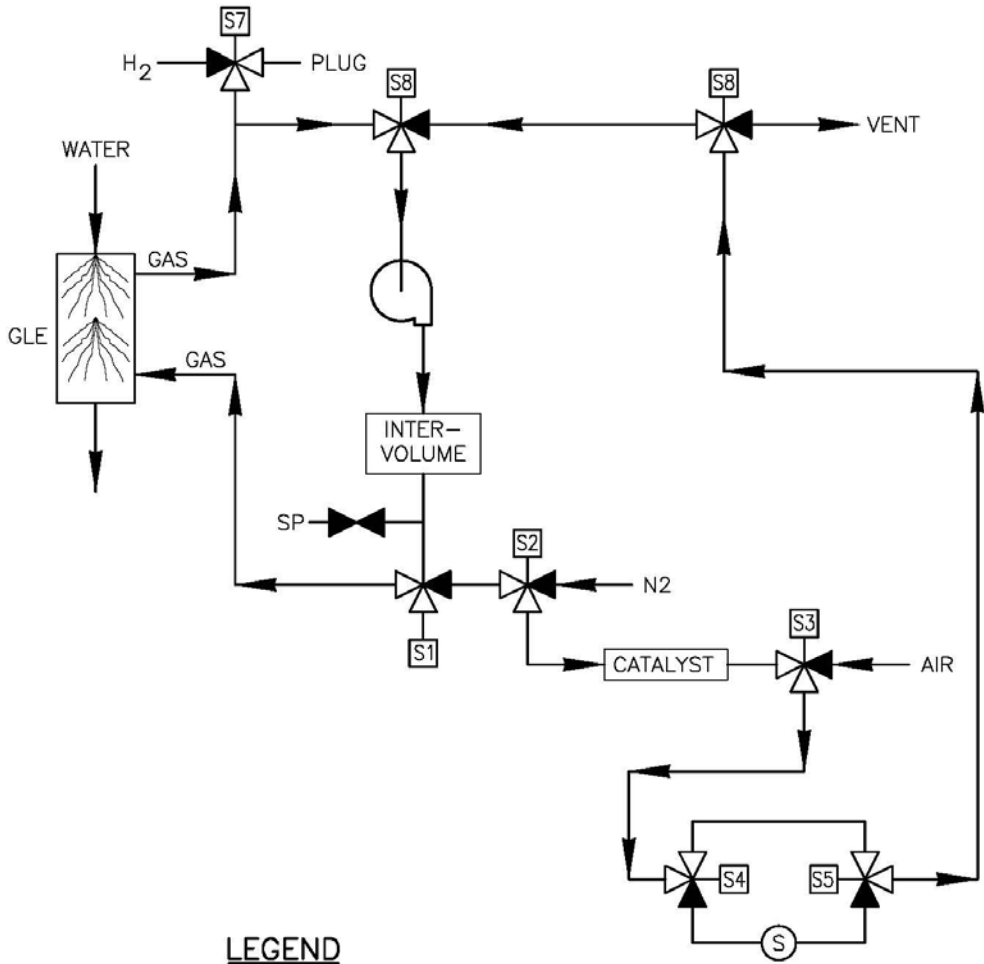

Figure 2-1. Dissolved Hydrogen Analyzer







Figure 2-2. Dissolved Hydrogen Analyzer Implementation

riehepij
 2:15:06
 07/22/04 08:09:03
 Fig-2-3
 P:\4000\31212\MS23F\



LEGEND

- | | | | |
|---|-------------------------------|---|-------------------------|
|  | BLOWER |  | SAMPLE PORT |
|  | 3-WAY SOLENOID VALVE NUMBER 3 |  | GAS LIQUID EQUILIBRATOR |
|  | SENSOR | | |

CDM

Figure 2-3
DH ANALYZER PROCESS FLOW DIAGRAM

2.3 Previous Testing of the Technology

Earlier prototypes of the DH analyzer were field tested at the following eight sites across the United States during 1998 (AGI, 1999):

- Natural Attenuation Test Site (NATS) in Columbus, Mississippi.
- Chlorinated solvent site (USG) in Baltimore, Maryland.
- Chlorinated solvent site (Unisys) in Plymouth, Michigan.
- Operating gasoline station (Chevron) in Nisqually, Washington.
- Chlorinated solvent site at (Union Pacific) rail yard in Sacramento, California.
- Petroleum hydrocarbon site at Hill Air Force Base (AFB) in Ogden, Utah.
- Chlorinated solvent site at (Union Pacific) rail yard adjoining Hill AFB.
- Petroleum hydrocarbon site in Laurel Bay, South Carolina.

Additional testing was conducted during this project and is described in the ESTCP Final Report (NFESC and CDM, 2004).

2.4 Advantages and Limitations of the Technology

Available methods to quantify DH in groundwater involve either (1) stripping the hydrogen from the groundwater into a carrier gas that is then analyzed at an offsite laboratory with standard turnaround time issues; or (2) using the bubble-strip method described briefly in Section 1.1 and in detail in **Appendix A**. This existing method is difficult, time consuming, and expensive to use; therefore, it has not gained widespread acceptance as an analytical method. The DH analyzer was shown during Phase II work under a SBIR grant to give comparable results to the standard bubble-strip/reduction gas analyzer method; however, the DH analyzer is simpler to use and unlike the offsite lab method, produces near real-time results. Also, the DH analyzer costs are significantly less than the standard bubble-strip method.

The DH analyzer is field-portable and incorporates the GLE and hydrogen sensing into a single instrument. Thus, the difficulty associated with the bubble-strip method is eliminated. The instrument is user-friendly and requires little technical knowledge for operation. As with any electromechanical device, periodic maintenance is necessary. This includes replacement of filters, catalysts, and gases.

Based on the results of this demonstration, it is clear that a major limitation of the analyzer as it now exists is the need for further investigation to identify a hydrogen sensor that minimizes interferences from other dissolved gases and has sensitivity to hydrogen to produce detection limits near 0.2 nM. A relatively minor limitation of the instrument is an analysis time that is expected to be about 30 minutes but may be up to 1 hour. This time may seem excessive; however, it is comparable to the bubble-strip method and provides near real-time results (as opposed to the offsite lab method). An indirect limitation pertains to well materials of construction, direct push technologies, and use of electric submersible pumps, all of which can result in hydrogen generation, thus giving falsely elevated DH concentrations. Although this limitation is not directly associated with the DH analyzer, it can result in misleading data if not addressed.

3.0 Demonstration Design

The demonstration described in this section was performed by CDM in cooperation with the NFESC as the principal investigator. Points of contact involved in the demonstration are listed in Section 8. The demonstration was conducted in accordance with the Technology Demonstration Plan (NFESC and CDM, 2001). The Technology Demonstration Plan also described the demonstration of a second MNA tool – a bioavailable ferric iron assay – and the demonstration of this tool is described in a separate report.

3.1 Performance Objectives

Performance of the DH analyzer was compared to the bubble-strip method used in conjunction with the reduction gas analyzer. At NAS Pensacola, Dr. Frank Chapelle of the United States Geological Survey (USGS) coordinated validation of the DH analyzer and ensured that the bubble-strip/reduction gas analyzer technique was correctly executed. Performance was evaluated based on the following objectives identified in the Demonstration Plan and also shown in **Table 3-1**:

- **Accuracy** as demonstrated by a one-to-one correlation between the two analytical techniques.
- **Range** as demonstrated by a response from less than 0.2 nM to greater than 10 nM.
- **Precision** as demonstrated by a low coefficient of variation amongst replicate analyses.
- **Sample throughput** as demonstrated by low analysis time relative to the bubble-strip method.
- **Mechanical reliability** as demonstrated by a low incidence of failure
- **Versatility** as demonstrated by acceptable performance at all three sites.

3.2 Selection of Test Sites

Technical and administrative data associated with contaminated areas at each of the sites identified in the Technology Demonstration Plan were acquired and reviewed. Specific information included:

- Availability of an existing groundwater monitoring well network
- Geological and hydrogeological characteristics
- Terminal electron-accepting processes occurring in the aquifer
- Concentrations of parent compounds and presence of daughter products
- Groundwater chemistry
- Ability to drill on site
- Availability and quality of existing site characterization documentation

Table 3-1: Performance Objectives

Type of Performance Objective	Primary Performance Criteria	Expected Performance (Metric)	Actual Performance Objective Met?
Qualitative	1. Sample Processing Rate	Equal to or better than bubble strip method	Not Determined ¹
	2. Mechanical Reliability	Low breakdown incidence	No
	3. Versatility	Applicability to all sites	No
	4. Ease of use	Typical operator training and labor required	Yes
Quantitative	1. Accuracy	Percent error < 10 percent; correlation coefficient (r^2) > 0.9	No
	2. Precision	Coefficient of variation (CV) for DH analyzer equal to or less than CV for reference method	Yes
	3. Sensitivity	< 0.2 nM	Yes (if no interference)
	4. Range	> 10 nM	Yes (if no interference)

¹Will depend on the hydrogen sensor ultimately used.

The objective was to select sites that offered a range of DH concentrations, geochemical characteristics, and TEAPs. This range of DH concentrations enabled validation of the DH analyzer over its full range.

As mention above, five sites were originally selected for field testing in the Demonstration Plan, including:

- Petroleum hydrocarbons at Laurel Bay Exchange Marine Corps Air Station in Beaufort, South Carolina (Laurel Bay).
- Dissolved petroleum hydrocarbons and chlorinated VOCs at Bangor Naval Submarine Base in Kitsap County, Washington (SUBASE Bangor).
- Chlorinated VOCs at Fort Lewis Logistics Center near Tillicum, Washington (Fort Lewis).
- Chlorinated VOCs at Dover AFB in Dover, Delaware (Dover AFB).
- Chlorobenzene plume at NAS Pensacola (Pensacola).

Ultimately, an analyzer was demonstrated at three sites. The DH analyzer was demonstrated at SUBASE Bangor, Fort Lewis and then at NAS Pensacola.

3.3 Test Site Descriptions

3.3.1 Site 1 – SUBASE Bangor

The study area is Operable Unit 8 (OU8), which is located in the Public Works Industrial Area (PWIA) of Bangor. Bangor is located near the town of Silverdale, Washington. An onsite underground storage tank (UST) is believed to be the source of a release of unleaded gasoline into the surrounding media between 1982 and 1986. In 1986, soil vapor extraction/air system and product recovery were implemented to clean up the site. To date, liquid petroleum hydrocarbons remain in several monitoring wells at the PWIA (EA, 2000). Chlorinated volatile organic compounds (VOC) are also present in site groundwater (EA, 2000).

3.3.2 Site 2 – Fort Lewis

Fort Lewis Logistics Center is located south of Tacoma, Washington. The source area is the East Gate Disposal Yard (EGDY), which is situated at the northwest corner of the base. Originally, the site was used for storage and disposal of various solid and liquid waste products of the Fort Lewis Logistics Center. Since 1982, studies have been conducted at the EGDY to verify and delineate contamination at the site. Affected media were soil and groundwater, with the prominent contaminant being TCE (Battelle, 2000). Battelle Memorial Institute (in cooperation with the Air Force Research Laboratory, USGS, Environmental Protection Agency [EPA], and Cornell University) is performing RABITT at the East Gate Disposal Yard at Fort Lewis (Battelle, 2000).

3.3.3 Site 3 – NAS Pensacola

This site is situated near Pensacola Bay in the far northwest corner of Florida (USGS, 1999). The area predominantly consists of marine and fluvial terrace deposits ranging from fine- to medium-grained sands, silts, clays, and gravel. The site has two aquifers, a shallow aquifer and a deeper confined aquifer (referred to as the underlying main producing zone). There is a 20-foot-thick confining barrier of low-permeable silts and clays that separate the upper and lower aquifers. The upper aquifer is composed of fine- to medium-grained sands. The main producing zone is used locally as a water supply and consists of permeable sands and gravel. Two plumes have been identified at the site, one comprised of chlorinated ethenes and the other chlorinated benzenes. Most of the contaminants on site are located in the upper aquifer region. The depth of contamination ranges from 20 to 40 feet bgs.

3.4 Physical Set-up and Operation

Two persons from CDM were on site during each demonstration. Startup responsibilities included well sampling and operation of the DH analyzer. Dr. Frank Chapelle of the USGS was on site at Site 3 for completion of confirmatory analyses. Site-specific security procedures were determined and followed at all sites.

Upon arrival at each site, the DH analyzer was inspected to determine if damage had occurred during shipment. A calibration run was then performed to ensure proper operation. Compressed

nitrogen required for the reduction gas analyzer was obtained from a local gas supply vendor. The DH analyzer and groundwater sampling pump operated off 12 VDC using a cigarette lighter adapter in the vehicle being used on site. The reduction gas analyzer required 120 volts AC.

3.5 Sampling/Monitoring Procedures

Figures 3-1 through **3-3** show maps and monitoring well locations for each of the three demonstration sites.

To evaluate the performance objectives listed in **Table 3-1**, the three site demonstrations followed the experimental design described in the Demonstration Plan. Well sampling for DH analysis began by measurement of water level in the subject monitoring well using an electronic sounder. Then tubing connected to either a bladder or peristaltic pump was lowered into the subject monitoring well. In wells that already contained sampling tubes, the intake to the sampling pump was connected to the sampling tube. The sampling pump was typically operated at a flow rate between 200 and 1,000 mL/min and discharged into a 5-gallon bucket. Field parameters (i.e., pH, temperature, dissolved oxygen, Eh, and specific conductivity) were monitored using a Hydrolab™. Once these parameters were stable, the bubble strip/reduction gas detection method was used to measure the DH concentration. The DH analyzer was connected to the discharge of a second sampling pump and operated in parallel with the bubble strip method.

At each of the three demonstration sites about 10 monitoring wells were measured for DH. Wells were selected based upon an evaluation of site conditions to provide a wide range of anticipated DH concentrations. Measurements using the bubble strip/reduction gas detection method and the DH analyzer were repeated up to four times at several wells.

3.6 Analytical Procedures

The DH analyzer was used to measure DH in groundwater samples at each of the sites. The results of the DH analyzer were compared against the standard bubble-strip method. The bubble-strip method with reduction gas analyzer detection is considered to be the standard method for DH analysis and was used to verify the DH analyzer results. Validation of the DH analyzer depends on comparable results to the bubble-strip method DH measurements. CDM was responsible for operation of the DH analyzer. CDM performed the bubble strip method at SUBASE Bangor and Ft Lewis. Dr. Frank Chapelle of USGS assisted in performing the bubble-strip method and evaluating DH results at Pensacola NAS.

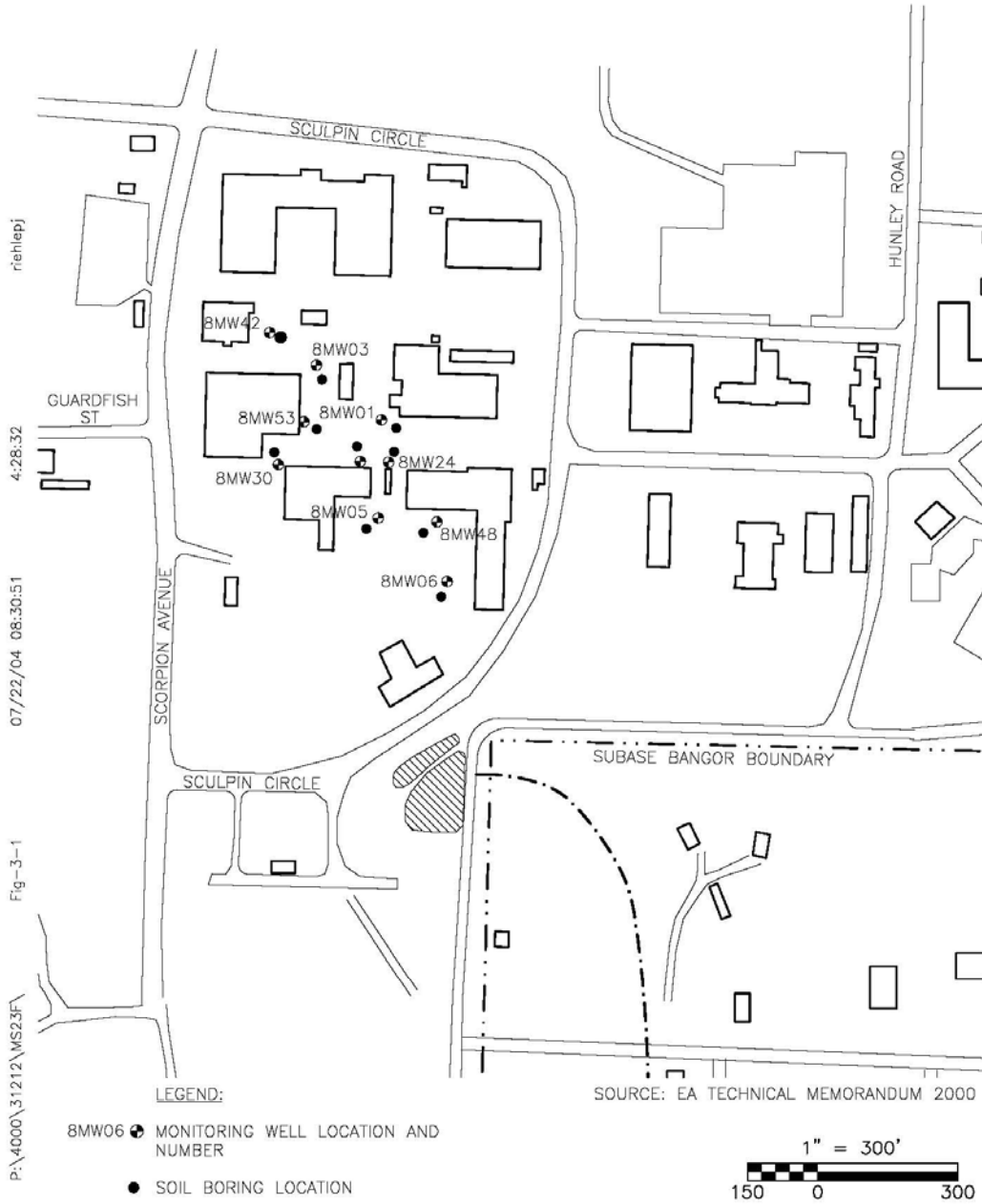

SUBBASE BANGOR
SILVERDALE, WASHINGTON

Figure No. 3-1
Sample Collection Points



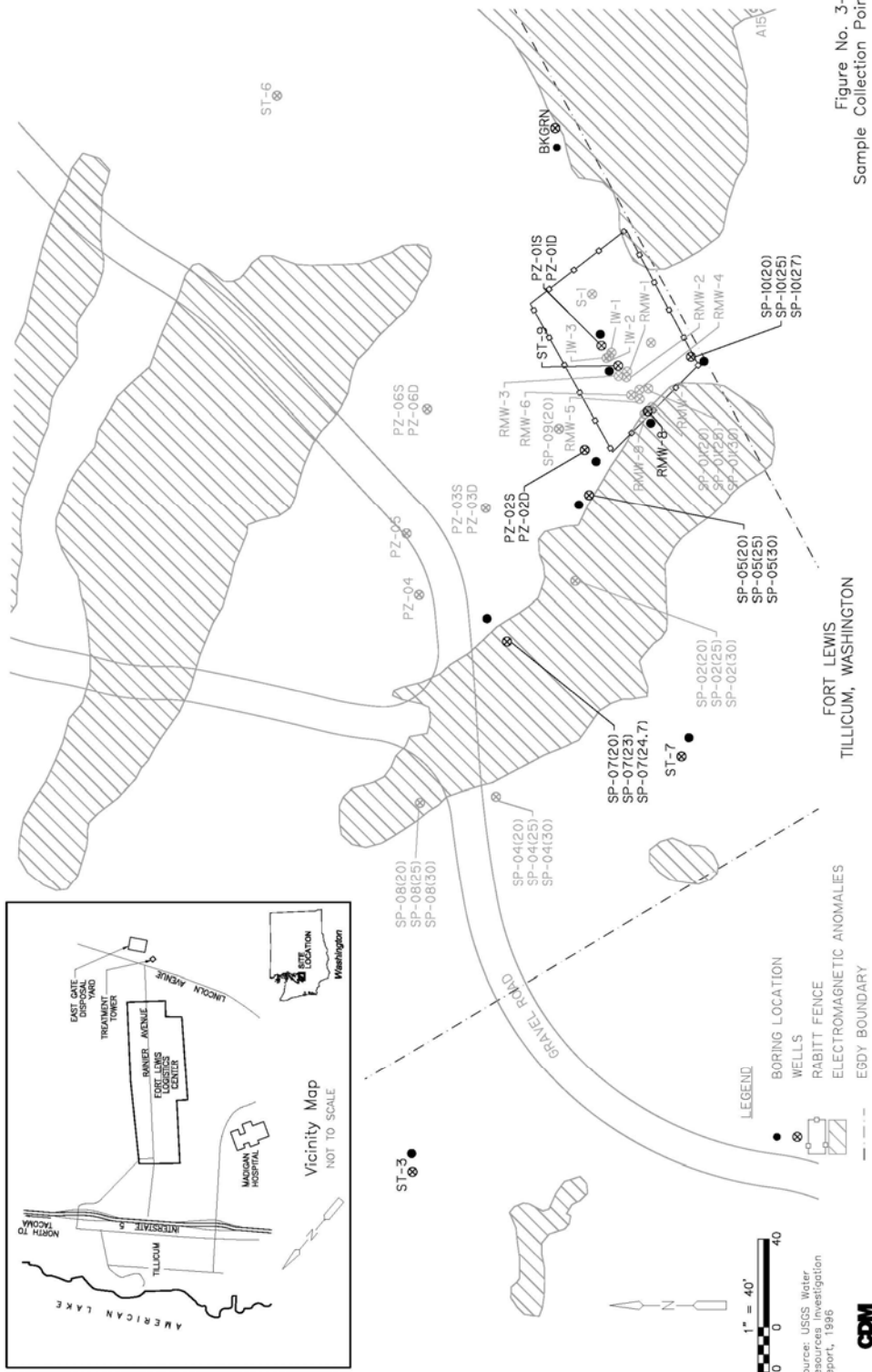

Figure No. 3-2
Sample Collection Points

rehlep)

10-43:17

07/22/04 08:41:54

Fig-3-2

P:\4000\31212\MS23\F

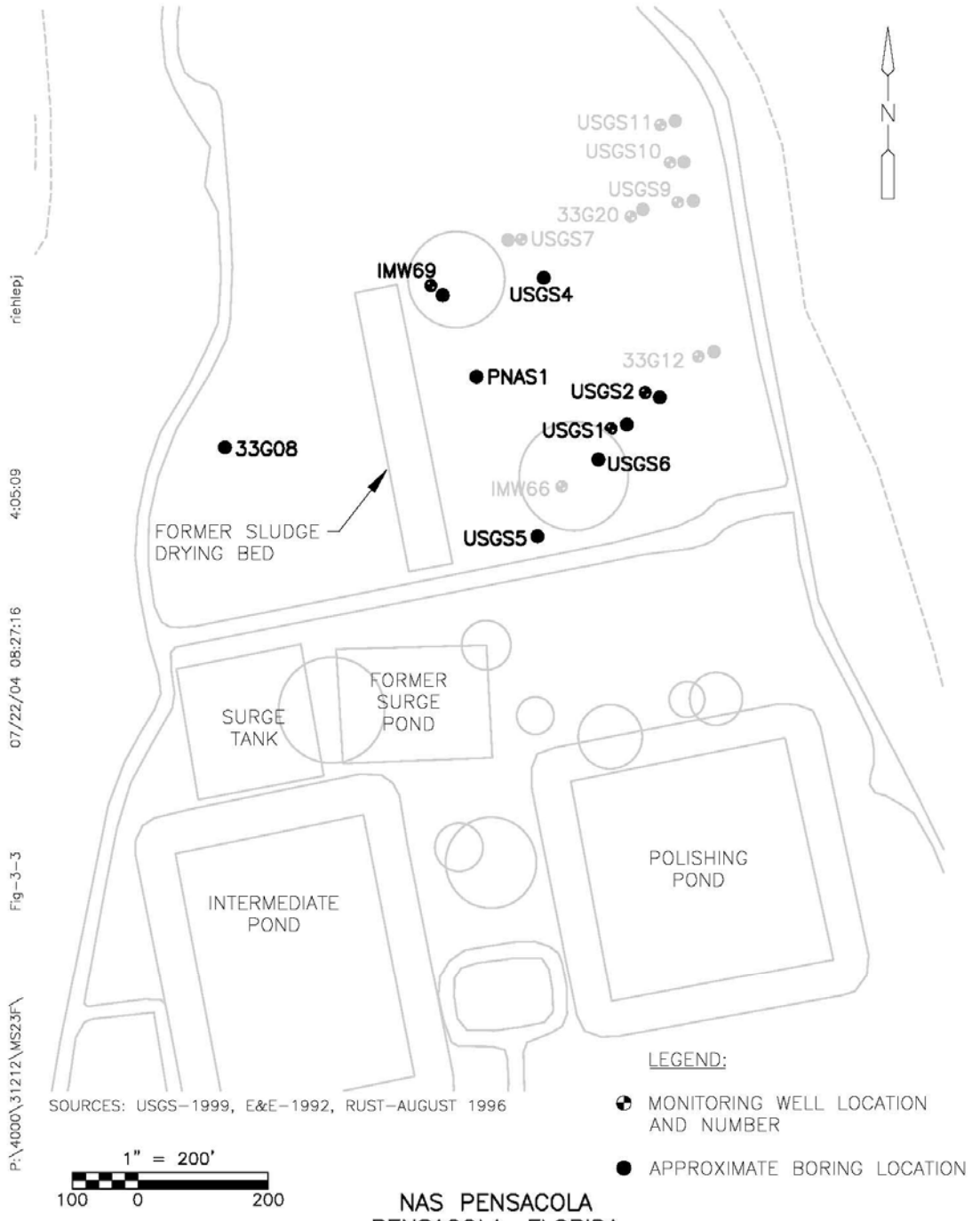

Figure No. 3-3
Sample Collection Points



4.0 Performance Assessment

4.1 Performance Data

Results of the DH analyzer and the bubble strip method are summarized in **Figures 4-1, 4-2, and 4-3**, for Sites 1, 2, and 3, respectively. In general the precision of the DH analyzer was similar to that of the bubble strip reference method. The accuracy of the DH analyzer was poor compared to the bubble strip reference method. Further discussion of the results is presented in Section 4.3.

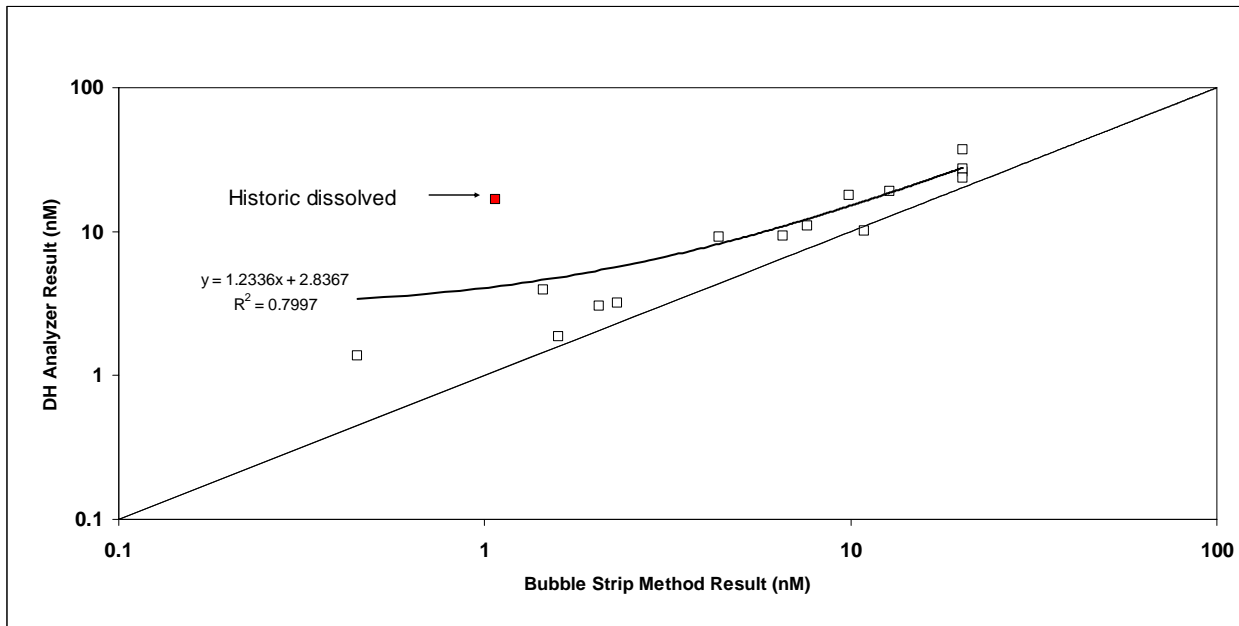

Figure 4-1. Site 1 (SUBASE Bangor) Dissolved Hydrogen Data

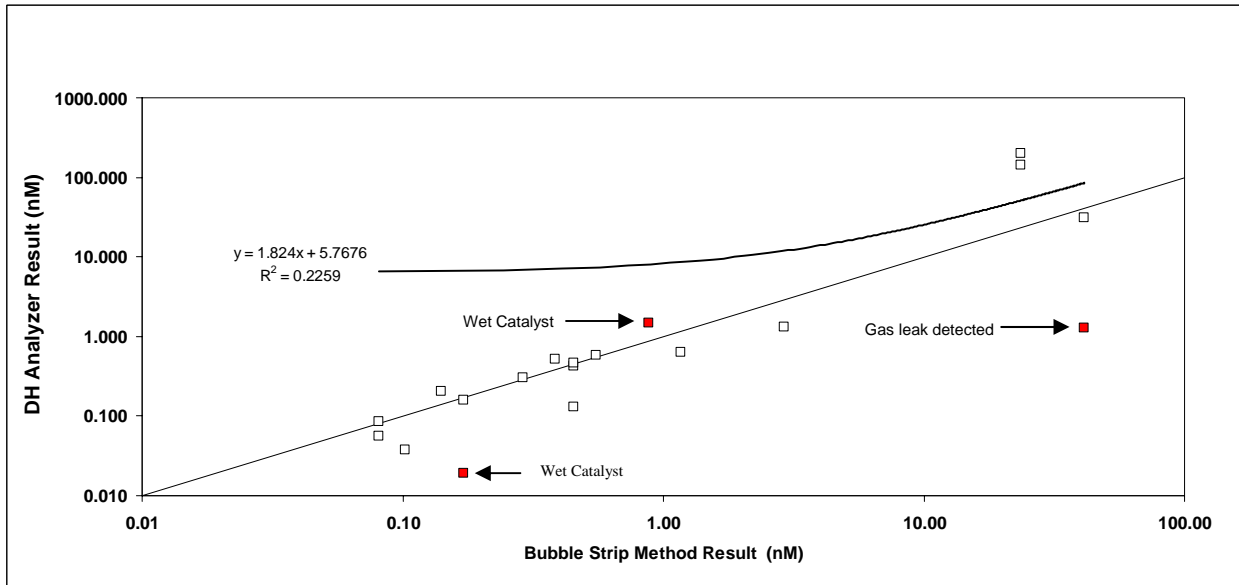

Figure 4-2. Site 2 (Ft. Lewis) Dissolved Hydrogen Data

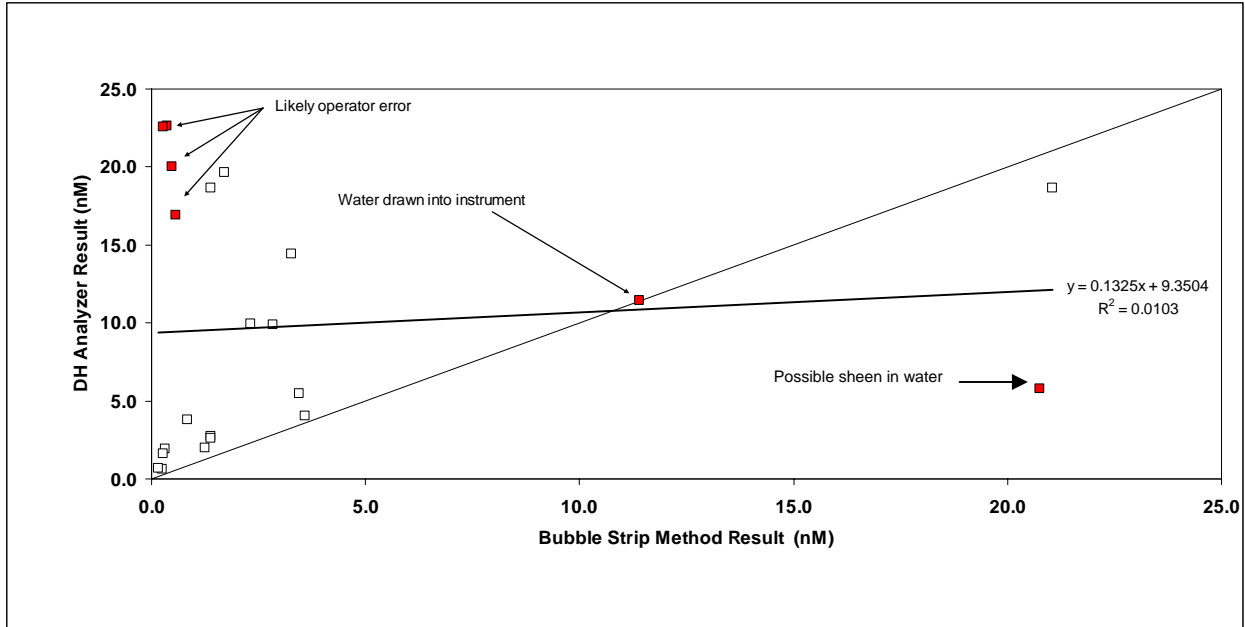

Figure 4-3. Site 3 (NAS Pensacola) Dissolved Hydrogen Results

4.2 Performance Criteria

Performance criteria that were used to evaluate the performance of the DH analyzer are given in **Table 4-1**. The performance criteria have been categorized as primary criteria (the project's performance objectives), or secondary criteria.

The primary method of evaluating the DH analyzer's performance was to determine the correlation between the analyzer results and bubble strip method results for samples that were co-located from the same well. However, other methods, metrics, and criteria were used to evaluate performance of the analyzer. **Table 4-2** presents a summary of these and lists them as either primary criteria (performance objectives) or secondary criteria. Within these two categories, the criteria are further divided as being qualitative or quantitative.

Table 4-1: Performance Criteria

Performance Criteria	Description	Primary or Secondary
Sample Throughput	Low analysis time relative to bubble strip method	Primary
Mechanical Reliability	Low incidence of mechanical failure	Primary
Versatility	Acceptable performance at all three demonstration sites	Primary
Ease of Use	Minimal user training required	Primary
Accuracy	Correlation between DH analyzer results and bubble strip method results	Primary
Precision	Low coefficient of variation amongst replicate analyses	Primary

Table 4-1: Performance Criteria (cont.)

Performance Criteria	Description	Primary or Secondary
Sensitivity	Detection limit for DH <0.2 nM	Primary
Range	Accurate results between <0.2 and 10 nM DH	Primary
Hazardous Materials	Little or no hazardous material generated during use of analyzer	Secondary
Process Waste	Little of no process waste generator during analyzer use	Secondary
Factors Affecting Technology Performance	Few interferences and accurate operation possible over a wide range of groundwater quality and field conditions	Secondary
Maintenance	Easily kept in operating order with infrequent part replacement	Secondary
Scale-Up Constraints	Can analyzer be easily produced commercially	Secondary

Table 4-2: Expected Performance and Performance Confirmation Methods

Performance Criteria	Expected Performance Metric (pre-demonstration)	Performance Confirmation Method	Actual (post-demonstration)
PRIMARY CRITERIA (Performance Objectives) (Qualitative)			
Sample Throughput	Equal to or better than bubble strip method	Experience from demonstration operation	Analysis time similar to bubble strip method (~1 hour)
Mechanical Reliability	Low breakdown incidence	Experience from demonstration operation	Further development needed to improve mechanical reliability
Versatility	Applicability to all demonstration sites	Comparison of results from different sites and laboratory testing	Further development needed for the hydrogen sensor to improve versatility through reduction in interfering dissolved gases
Ease of Use	Operator training and labor required similar to other field equipment	Comparison to operator requirements for other commonly used field instruments	Ease of operation similar to other field instruments, although calibration could be simplified.

Table 4-2: Expected Performance and Performance Confirmation Methods (cont.)

Performance Criteria	Expected Performance Metric (pre-demonstration)	Performance Confirmation Method	Actual (post-demonstration)
PRIMARY CRITERIA (Performance Objectives) (Quantitative)			
Accuracy	Percent error < 10 percent $r^2 > 0.9$	Correlation with bubble strip/reduction gas analyzer reference method.	Accuracy was highly dependent on types and amounts of interfering gases. Site 1 $r^2 = 0.80$; Site 2 $r^2 = 0.24$; Site 3 $r^2 = 0.01$
Precision	CV for DH analyzer equal to or less than CV for reference method	CV between replicates taking into account best CV attained with the bubble strip/reduction gas analyzer reference method.	Average CVs: Site 1 – 34% for DH analyzer and 67% for reference method Site 2 – 64% for DH analyzer and 34% for reference method Site 3 – 20% for DH analyzer and 17% for reference method Overall, CVs similar to reference method.
Sensitivity	Detection limit for DH < 0.2 nM	Detection of DH concentrations less than 0.2 nM as determined by bubble strip/reduction gas analyzer reference method.	Detection limit for DH < 0.2 nM when no interferences presence.
Range	> 10 nM	Ability to quantify DH concentrations greater than 10 nM as determined by bubble strip/reduction gas analyzer reference method.	> 10 nM when no interferences present.

Table 4-2: Expected Performance and Performance Confirmation Methods (cont.)

Performance Criteria	Expected Performance Metric (pre-demonstration)	Performance Confirmation Method	Actual (post-demonstration)
SECONDARY PERFORMANCE CRITERIA (Qualitative)			
Hazardous Materials	No hazardous materials produced	Evaluate materials needed for operation	No hazardous materials produced
Process Waste	No process waste produced	Observation	No process waste produced. Very small amounts of spent MGC, Carulite, molesieve are produced.
Factors Affecting Performance <ul style="list-style-type: none"> ▪ throughput ▪ groundwater quality 	<ul style="list-style-type: none"> ▪ analysis time ≤ 1 hr ▪ no interferences under typical groundwater conditions 	<ul style="list-style-type: none"> ▪ time/sample analysis ▪ performance not affected by groundwater quality 	<ul style="list-style-type: none"> ▪ analysis time ≤ 1 hr ▪ other dissolved gases interfered with DH analysis
Maintenance	Maintenance requirements similar to other field instruments (gas and filter replacement)	Comparison of field records to operator requirements for other commonly used field instruments	Gas and filter replacement are primary maintenance requirements (i.e., not dissimilar to other field instruments)
Scale up Constraints	No commercialization constraints	Investigate ability to easily produce commercially	Likely no commercialization constraints except relatively small market; however, depends on further development results and hydrogen sensor used

4.3 Data Assessment

The correlation coefficients for the two methods for Sites 1, 2, and 3 were 0.80, 0.24, and 0.01, respectively. The variability of correlation of the DH analyzer results to bubble strip method results has been determined to be most likely due to interferences from dissolved gases (primarily methane and H₂S) in the groundwater analyzed. Specifically, the ability of the various hydrogen sensors tested to accurately measure gaseous hydrogen was negatively impacted by the

presence of other gases that partitioned from groundwater in the GLE device. For example, **Figure 4-1** indicates a data point for a well that had historic dissolved methane. The sensor is sensitive to methane and thus the high DHA result is likely attributable to this interference. Much but not all of the poor correlation in **Figure 4-3** was attributed to operator error or high sulfide concentrations in groundwater. A direct correlation between error and sulfide concentration was not evident. Sulfide did not completely explain the poor correlation and other possible interferences or sensor instabilities likely exist.

The interference of other dissolved gases impacted how the DH analyzer performed against several performance criteria, including accuracy, precision, sensitivity, and range. It is evident that further investigation into and testing of hydrogen sensors is required for the DH analyzer to be a reliable field instrument. Additionally, the viability, or lack thereof, of the DH analyzer could not be demonstrated at this time because of poor precision (e.g., coefficient of variation of 17 to 67 percent) of the standard reference method (i.e., the bubble strip method). Since further development of the DH analyzer was beyond the scope of the ESTCP demonstration, evaluation of the current configuration of the DH analyzer was discontinued after Site 3 (NAS Pensacola).

4.4 Technology Comparison

No other field portable method is available for the measurement of dissolved hydrogen in groundwater. Equilibrated gas samples can be collected and sent to a fixed laboratory if desired.

5.0 Cost Assessment

Given the developmental requirements of the DH analyzer before it can be commercialized and at ESTCP's direction (Email from Dr. Andrea Leeson to Carmen A. Lebrón dated December 12, 2003), no costs for its use have been developed at this time.

6.0 Implementation Issues

6.1 Cost Observations

Not applicable (see Section 5.0)

6.2 Performance Observations

The accuracy of the DH analyzer did not meet the performance objectives set for this demonstration. The primary reason was attributed to interferences from gases that include but may not be limited to hydrogen sulfide and methane. Further research into interference-resistant sensors or adsorbents that are capable of removing these interfering gases is recommended and is discussed further in Section 6.5.

6.3 Scale-up

The DH analyzer is an analytical technology and thus scale-up is more appropriately termed commercialization. Commercialization requirements are discussed in Section 6.5.

6.4 Other Significant Observations

Implementation of this technology will require investment in research and development to address the issues identified in Section 6.5. Interested parties can contact Dr. Patrick Evans at CDM. Contact information is presented in Section 8.0.

6.5 Lessons Learned

These demonstrations showed that while the DH analyzer is not yet ready for commercialization, with further development it can be a valuable tool for providing accurate field analyses of dissolved hydrogen. This further development needs to focus on:

- Modifying the existing hydrogen sensor or identifying a new sensor that is not sensitive to the dissolved gases that were found to interfere with DH detection in these demonstrations. Furthermore, increased sensor stability and lack of a need for preconditioning is necessary.
- Developing a system to detect leaks in the gas conveyance tubing/valving
- Improving mechanical stability
- Evaluating adsorbents capable of adsorbing hydrogen sulfide. The Carulite and molecular sieves used in the current DHA have some but insufficient hydrogen sulfide adsorption capacity. Alternative molecular sieves capable of adsorbing hydrogen sulfide are warranted. However, methane will likely still pose an interference problem and practical methane adsorbents do not exist. Thus identification of an alternative sensor is still necessary.

6.6 End-User Issues

The main end-user (technical staff working on characterizing DoD sites) issue regarding use of a DH analyzer is "Will this instrument provide results that are comparable to those from the reference method?" Since the demonstration results indicated that the DH analyzer results did not

correlate well with the bubble strip method, evaluation of implementation issues would be premature. Further investigation into finding and testing a hydrogen sensor that did not negatively respond to other dissolved gases would be needed before the DH analyzer could be further field demonstrated.

6.7 Approach to Regulatory Compliance and Acceptance

Dissolved hydrogen is referenced in the EPA technical guidance on MNA of chlorinated solvents (EPA, 1998). Analysis of this analyte is not required at this time, and is considered optional by regulatory agencies. Additionally, no field method for DH measurement has been approved by any regulatory agency, including the bubble strip method.

With respect to execution of this project, minimal regulatory involvement was needed since this was a demonstration of analytical techniques and not of a remediation technology. Drilling permits were obtained as required by registered drillers under subcontract to CDM.

7.0 References

- AGI Technologies. 1999. *Development of a Dissolved Hydrogen Analyzer and a Bioavailable Ferric Iron Assay*. Submitted to the Air Force Research Laboratory. October 1999.
- Battelle. 2000. *Technology Demonstration Plan: Reductive Anaerobic Biological In Situ Treatment Technology (RABITT) Treatability Testing at the East Gate Disposal Yard Site Fort Lewis, WA*. May 2000.
- Chapelle, F.H., D.A. Vroblesky, J.C. Woodward, and D.R. Lovley. 1997. *Practical Considerations for Measuring Hydrogen Concentrations in Groundwater*. *Envir. Sci. Technol.* 31: 2873 – 2877.
- EA. 2000. *Final Site Specific Health and Safety Plan Monitoring Natural Attenuation Operable Unit 8 Submarine Base Bangor Washington*. October 30, 2000.
- EPA. 1998. *Technical Protocol for Evaluating Natural Attenuation of Chlorinated Solvents in Groundwater*. EPA/600/R-98/128. September 1998.
- Evans, P.J. 2001a. *Theory and Performance of a Field-Portable Dissolved Hydrogen Analyzer* In: *Natural Attenuation of Environmental Contaminants* (A. Leeson, M. Kelley, H.S. Rifai, and V.S. Mayar, eds.) Battelle Press, Columbus, OH. pp. 199-206.
- Evans, P.J. 2001b. *A Dissolved Hydrogen Analyzer and a Bioavailable Ferric Iron Assay for Bioremediation Analysis*. In: *Proceedings of the Second International Conference and Industrial Exhibition: Field Screening Europe 2001* pp. 139-144.
- Evans, P.J. 2001c. *Dissolved Hydrogen Analyzer* U.S. Patent No. 6,277,329
- NFESC and CDM. 2001. *Technology Demonstration Plan. Development of a Dissolved Hydrogen Analyzer and a Bioavailable Ferric Iron Assay*. ESTCP Project CU-0009. July 26, 2001.
- NFESC and CDM. 2004. *Final Report. Field Demonstration and Validation of a Dissolved Hydrogen Analyzer*. ESTCP Project CU-0009. November 2004.
- USGS. 1999. *Monitoring Plan for Natural Attenuation Remediation, Waste Water Treatment Plant, Pensacola, Florida*. December 1999.

8.0 Points of Contact

POINT OF CONTACT Name	ORGANIZATION Name Address	Phone/Fax/email	Role in Project
Carmen A. Lebrón	NFESC Restoration Development Branch Code ESC411 1100 23 rd Avenue Port Hueneme, CA 93043-4370	p) 805-982-1616 f) 805-982-4304 carmen.lebron@navy.mil	PI
Dr. Patrick Evans	CDM 11811 NE 1 st St. Ste 201 Bellevue, WA 98005-3033	p) 425-453-8383 f) 425-646-9523 evanspj@cdm.com	Co-PI
Dr. Frank Chapelle	USGS 720 Gracern Road Ste 129 Columbia, SC 29210	p) 803-750-6116 f) 803-750-6181 chapelle@usgs.gov	Partner
Dr. Roger Olsen	CDM 1331 17 th St. Ste 1200 Denver, CO 80202	p) 303-298-1311 f) 303-293-8236 olsenrl@cdm.com	Reviewer

Signature of Project Lead

Date

Appendix A Bubble Strip Method for Analyzing Dissolved Hydrogen

Measurement of dissolved hydrogen (DH) is becoming more important in the evaluation of contaminated groundwater systems. Dissolved hydrogen is produced by fermentative microorganisms under anaerobic concentrations. Respiring microorganisms then utilize DH for use in terminal electron-accepting processes. This process involves reduction of terminal electron acceptors, such as CO₂, Fe (III), and sulfate (Chapelle, 1997).

The bubble-strip method has been proven to be a valuable and reliable method to measure DH. The analysis generally takes 30 minutes. The method can also measure a wide range of different DH concentrations (Chapelle, 1997).

The bubble-strip method is divided into two parts: (1) field sampling of wells and (2) laboratory analysis (EPA, 1998). Groundwater is continuously pumped at a rate of about 500 milliliters per minute (mL/min) through a 250-mL gas-sampling bulb. Gas (20-mL bubble of H₂-free N₂) is then introduced into the sampling bulb through the septum. Over time, hydrogen is transferred from the liquid to the gas phase. Some refer to this as hydrogen being "stripped" from water. Equilibrium between the hydrogen in the liquid and gas phase is achieved over time. Once equilibrium has been established, a gas sample is taken and analyzed for hydrogen. The procedure generally takes 20 to 30 minutes (Chapelle, 1997).

The gas sample is then analyzed for hydrogen by gas chromatography with a reduction gas detector (EPA, 1998). Concentrations are then calculated from the following equations, assuming the DH concentration in the aqueous phase is in equilibrium with the gas phase (Chapelle, 1997).

$$C_{aq} = 0.812 C_{vap}$$

Where C_{aq} is the aqueous concentration of DH in nanomolar (nM) and C_{vap} is the equilibrium vapor concentration of DH in ppm by volume.

The method should be used with a bladder, piston, or peristaltic pump. Use of a direct current driven submersible pump has the potential to generate DH and should not be used. In addition to different pumping systems, the method can also be affected by materials used in well construction (Chapelle, 1997). Metallic well casings with can generate DH. This effect is not seen with DH concentrations measured from PVC wells (Chapelle, 1997).