

UNCLASSIFIED

Final Report



**Feasibility Study for Enhanced CC-130 Search and Rescue Capability
with a Ground Penetrating Radar**

March 2004



Prepared for:

**Doreen Dyck
Head/Radar Systems
Defence Research and Development Canada
613-998-2218**

**Submitted by: R Vickers,
President and Project Manager
Environmental Mapping Canada
203-2776 Bourquin Place
Abbotsford, BC V2S 6A4**

**Contract # W7714-030743/001/SV
PWGSC File Number 017SV.W7714-030743**

Unlimited distribution

DRDC Ottawa CR 2005-033

Doc# EMC G04011

UNCLASSIFIED

Report Documentation Page

Form Approved
OMB No. 0704-0188

Public reporting burden for the collection of information is estimated to average 1 hour per response, including the time for reviewing instructions, searching existing data sources, gathering and maintaining the data needed, and completing and reviewing the collection of information. Send comments regarding this burden estimate or any other aspect of this collection of information, including suggestions for reducing this burden, to Washington Headquarters Services, Directorate for Information Operations and Reports, 1215 Jefferson Davis Highway, Suite 1204, Arlington VA 22202-4302. Respondents should be aware that notwithstanding any other provision of law, no person shall be subject to a penalty for failing to comply with a collection of information if it does not display a currently valid OMB control number.

1. REPORT DATE MAR 2004		2. REPORT TYPE		3. DATES COVERED -	
4. TITLE AND SUBTITLE Feasibility Study for Enhanced CC-130 Search and Rescue Capability with a Ground Penetrating Radar(U)				5a. CONTRACT NUMBER	
				5b. GRANT NUMBER	
				5c. PROGRAM ELEMENT NUMBER	
6. AUTHOR(S)				5d. PROJECT NUMBER	
				5e. TASK NUMBER	
				5f. WORK UNIT NUMBER	
7. PERFORMING ORGANIZATION NAME(S) AND ADDRESS(ES) Defence R&D Canada -Ottawa,3701 Carling Ave,Ottawa Ontario,CA,K1A 0Z4				8. PERFORMING ORGANIZATION REPORT NUMBER	
9. SPONSORING/MONITORING AGENCY NAME(S) AND ADDRESS(ES)				10. SPONSOR/MONITOR'S ACRONYM(S)	
				11. SPONSOR/MONITOR'S REPORT NUMBER(S)	
12. DISTRIBUTION/AVAILABILITY STATEMENT Approved for public release; distribution unlimited					
13. SUPPLEMENTARY NOTES The original document contains color images.					
14. ABSTRACT Penetration radars have been successful in detecting and locating many types of metallic targets under foliage, including flat plates, vehicles, reflectors, and pipes. The purpose of this study is two-fold: (1) define the radar operating parameters, especially frequency, that would maximise the chances of success for a penetration radar mounted on the CC-130 for detection of downed aircraft in search and rescue operations; and (2) investigate the feasibility of mounting a foliage penetration radar on the CC-130 RMAS. The study concludes that the penetration radar can be operated from the CC-130 RMAS pallet and associated pod using a frequency range which will effective in detecting concealed sections of downed aircraft. The minimum size of detected metal parts will depend mostly on the background clutter in the radar image. In many scenes this will most likely be due not to snow or forest properties, but to surface rockfall in the area which itself has also been covered by foliage or snow. Pieces of metal two or more meters across will be readily detectable from a wide range of illumination angles. Snow cover is not an impediment to radar detection in this frequency range, or indeed for any frequencies, even beyond L-Band.					
15. SUBJECT TERMS					
16. SECURITY CLASSIFICATION OF:			17. LIMITATION OF ABSTRACT	18. NUMBER OF PAGES 30	19a. NAME OF RESPONSIBLE PERSON
a. REPORT unclassified	b. ABSTRACT unclassified	c. THIS PAGE unclassified			

Table of Contents

Background	3
Part I Effects of Foliage and Snow cover on SAR Performance	
1 Forest Penetration	4
1.1 Attenuation	4
1.2 Clutter	8
1.3 RCS of Metal Targets	9
1.4 Target Detection	11
2 Penetration through Snow and Ice	
2.1 Losses through Snow	13
2.2 General Comments	16
2.3 Recommended Frequency Range	16
Part II Aircraft Installation Considerations	
3.1. Antenna size and Location on the CC-130	17
3.2. Positioning Data	21
3.3 Operator Station	21
3.4 Modifications to the Aircraft	22
3.4.1 Radar Antennas	22
3.4.2 GPS Antennas	22
3.4.3 Power	22
3.4.4 Display	22
3.4.5 EMI/EMC	23
3.5 Conclusions and Recommendations	24
References	26
Further References	27

Background

Radars exist now that operate at wavelengths that are long enough to permit imaging through snow, ice, trees and even some soils. They have been flown in the USA since 1990 on various development programs for the US Department of Defense, and are now available commercially on a custom basis. Like most radar systems, they respond well to metallic targets and thus have an application to the Search and Rescue (S&R)* field. The most difficult problem for search and rescue applications of these types of radar is the penetration through forest, and the estimation of the percentage of terrain over which a synthetic aperture radar can be operated. The geometric requirements for SAR imaging are that the radar wave hit the ground pixels in sequence so as to give range discrimination, and that the wave also propagates through foliage at a suitable depression angle such that the biomass is not maximised. This means that the radar could not depress at 45 degrees while at the same time scanning a mountainside with 45-degree slope. Thus operations in steep walled mountain areas will require mission planning that takes this requirement into account.

Penetration radars have been successful in detecting and locating many types of metallic targets under foliage, including flat plates, vehicles, reflectors, and pipes. To our knowledge, no tests have been conducted against downed aircraft concealed by foliage or snow. The purpose of this study is to define the radar operating parameters, especially frequency, that would maximise the chances of success for a penetration radar mounted on the CC-130 .

** Throughout this report the acronym SAR will be used for Synthetic Aperture Radar, and S&R will be used for Search and Rescue.*

Part I. Effects of Foliage and Snow cover on SAR Performance.

1 Forest Penetration

1.1 Attenuation

Radars have been designed to demonstrate foliage penetration capabilities since the early 1980's. The frequencies needed for this capability are under 1000 MHz, and are considerably lower than those normally used for synthetic aperture radar (SAR) systems. We are fortunate for this study in that a number of detailed studies on foliage penetration were completed by DARPA in the mid 1990's and reported extensively by MIT/Lincoln Laboratory and others. During this time the US agency DARPA conducted a number of tests (Bessette and Ayasli, 2001) using the Swedish CARABAS radar (20-90 MHz), the SRI FOLPEN (200-400 MHz), and the Navy/ERIM radar mounted on a P-3 aircraft (200-1000 MHz). These radars were flown over tropical forest in Panama, and North American forests in Maine and Michigan. These data acquisition programs included valuable collections of clutter data over the various forest types. The clutter data is important because it allows comparison of forest clutter statistics with target RCS and thence an estimate of the detection probability.

From a radar perspective, forest canopy falls into many categories, depending on the biomass and the water content. Tropical forests for example cannot be consistently penetrated by radar frequencies higher than 400 MHz or so, while temperate forests (North American for example) can be penetrated at higher frequencies (up to 1000 MHz), especially in winter, when liquid water is not present on the leaves. A number of studies in the 1990's bear this out, in particular the paper by Fleischman et al (1996) addresses the issues of this study. The effects of foliage on the radar signal are to cause attenuation, phase shift, and unwanted backscatter. Each of these effects contributes to a limitation in our ability to image objects beneath the trees. Attenuation is perhaps the most obvious limiting factor, since if the radar signal is too weak to reach its target and return to the aircraft antenna, then it will fail to detect surface objects. Random phase shift has a similar effect, since in order to achieve the full power of the synthetic aperture algorithm, the signal must be coherently integrated over a significant number of pulses, (typically over 1000), and the phase must be coherent between these pulses in order to obtain integration gain. The more the phase is corrupted, the less processing gain we can achieve, and again, the less probability of detecting a surface target. Lastly, the backscatter from both the leaves and the upper branching in the forest contribute to a background graininess in the radar image known as clutter, which competes with the desired target signatures. The signal from the targets being sought must be larger than this clutter level in order to be distinguishable; therefore, the lower the clutter level, the better the chances of detection, all other things being equal.

The key radar parameters to establish, before we can calculate the probability of detection, are the forest attenuation, the image threshold (forest clutter), and the target intensity, or radar cross section (RCS). A number of studies have been performed by

the author and others on the first two of these parameters in the 1990's, and we can use that data effectively in determining the expected response of a Canadian forest region

From an early study reported in 1992 (Tamasinis 1992) the data shown in Figure 1 was obtained.

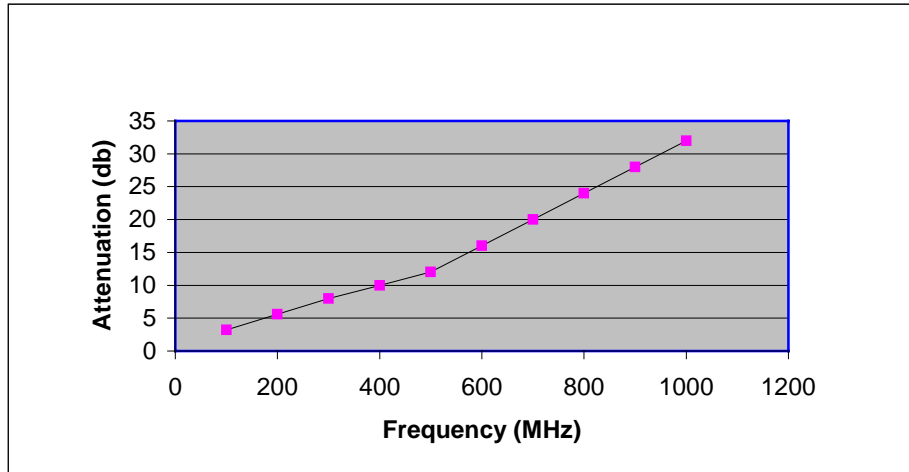

Figure 1. Two-Way Attenuation through Forest Canopy as a Function of Frequency

The values shown are for two-way attenuation through the forest canopy at a 45 degree depression angle. As will be shown later, this depression is optimum for combining swath width with low biomass in the ray path. We know from the geometry of the CC-130 pod that frequencies lower than 300 MHz will not be radiated efficiently since the antenna dimension cannot exceed 50 cm. And in practice the lower frequency limit is more likely to be 400 MHz. Without the constraint of the pod, frequencies down to 200 MHz can be used. Assuming for a moment that the bandwidth of the system will be 200 MHz, equivalent to a slant range resolution of 75cm, then the high frequencies of the two possible modes would be 400 and 600 MHz respectively. The difference in attenuation between these two modes is thus approximately 6 dB. The graph is almost linear, so the 6dB figure would extend across the whole radar bandwidth. From this graph it appears that attenuation will not be a constraint in operating a radar for S&R on the CC-130.

Another presentation is given in Fleischman (1996) and is shown in Figure 2.

In this presentation, it can be seen that the more usual radar frequencies at L and C bands, (1-2 and 4-8 GHz), suffer from substantially higher attenuation than the UHF band that we are considering for S&R work. Interestingly, the attenuation for VV polarisation is about twice that of HH in the UHF band. Also of note is the attenuation at L Band, which is only 14dB in Figure 2, but is over 30dB according to Tamasinis, probably due again to the difference in forest type and water content. We will use the high figure.

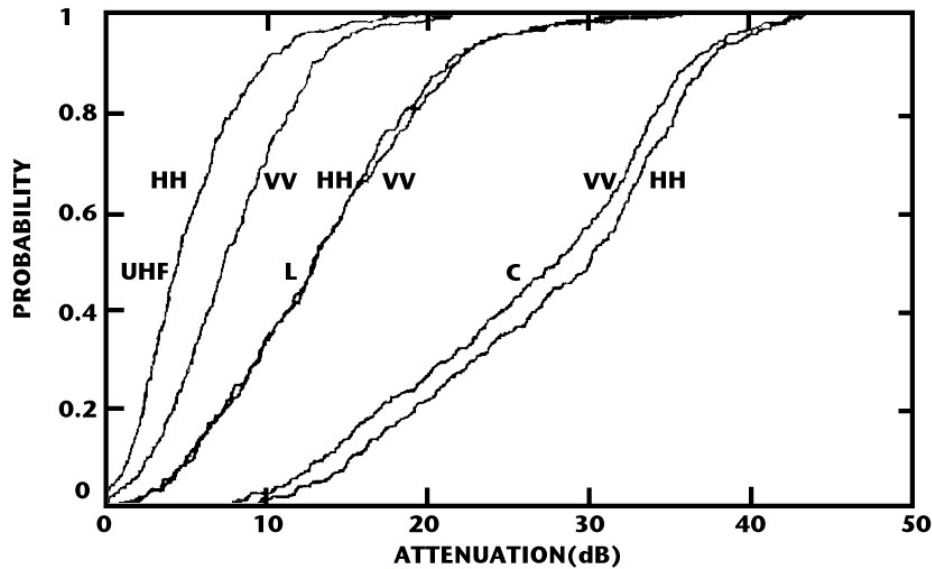

Figure 2. Cumulative Probability Distribution curves for Two-Way Attenuation at Three Radar Frequencies.

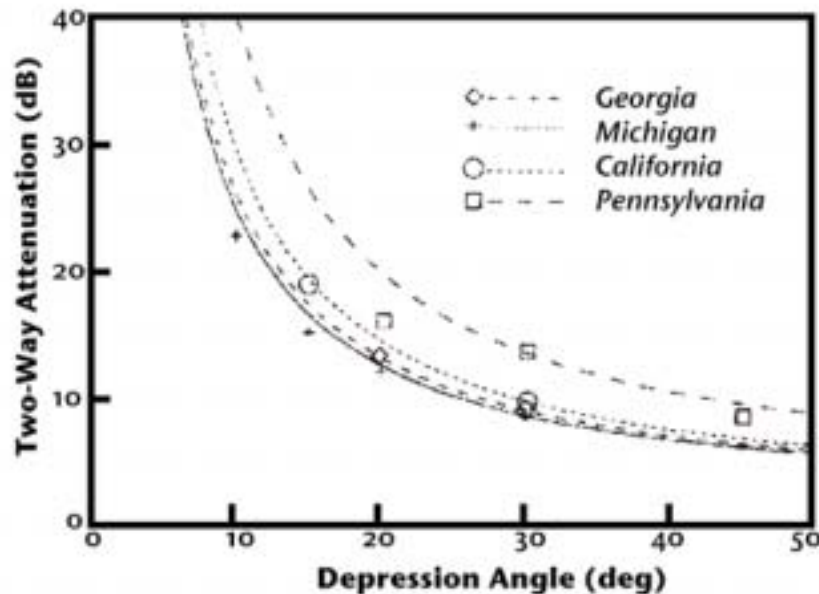

Figure 3. Variation of Two-Way Attenuation (UHF) with Depression Angle (Bessette and Ayasli)

Figure 3 illustrates the penalty of using shallow depression angles. The radars used for foliage penetration work typically depress from 30 to 60 degrees, whereas mapping radars typically depress 20 degrees or less. For the North American forests shown in this figure, it is clear that the region from 30 to 60 degrees is preferable. This particular data was collected over the band 215-724 MHz at HH polarisation, and if anything shows slightly lower values for 2-way attenuation than Figure 1. The data here also shows the

penalty for depressing at angles shallower than 30 degrees or so due to the longer slant path through the biomass. The important factor for this study is the penalty to be paid by moving the radar operating frequency from 300 MHz to 600 MHz or higher. Figure 1 showed a two-way attenuation increase from 10dB to around 16db for the HH case, and similar numbers (5dB and 14dB at 50% probability) are shown in Figure 2 for a different data set, and over different trees in Portage, Maine. Neither of these attenuation figures are a show-stopping problem for a penetration SAR design, but they do represent significant signal degradation.

The attenuation data can be summarised as in Table I (Fleischman et al 1996). In this table, Fleischman has apparently used the 50% probability points on his graph (Figure 2).

Table I Attenuation versus Depression Angle for Three Radar Bands

Depression	C -Band		L -Band		UHF	
	HH	VV	HH	VV	HH	VV
30	33.6	32.8	17.0	17.1	5.5	10.5
45	30.4	27.5	12.7	13.3	4.9	7.5
60	24.2	23.1	11.0	10.4	4.0	5.4

Of equal importance is the effect of the foliage on the phase of the SAR signal, since phase shift would decorrelate the radar returns and lessen the integration gain of the processor. The data in Figure 4, taken from Sheen, (1994) plots the peak of the bell shaped distribution of phase shifts from a dense, wet Californian forest. Again, the graph between 300 and 1000MHz is approximately linear, doubling from 42 degrees at 300 MHz to 80 degrees at 600 MHz, roughly following a formula of

$$\text{Phase shift (f)} = \text{Frequency (MHz)} * 0.133$$

In general, phase deviations of more that 45 degrees will cause image defocus and loss of integration gain. This would indicate that a band from 400-600 MHz would have some deterioration in performance when used in forests similar to those in the Californian data set. Canadian coniferous forests can be expected to give more favorable results due to the higher coniferous content, and less liquid water on the leaves and branch structure.

Figure 4. Phase Shift through Forest Canopy Vs Frequency

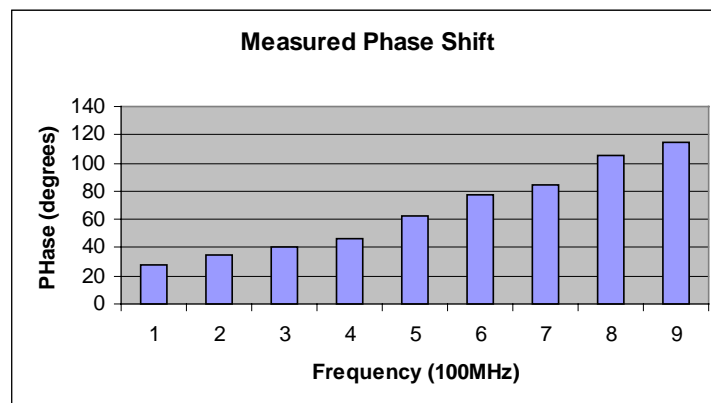

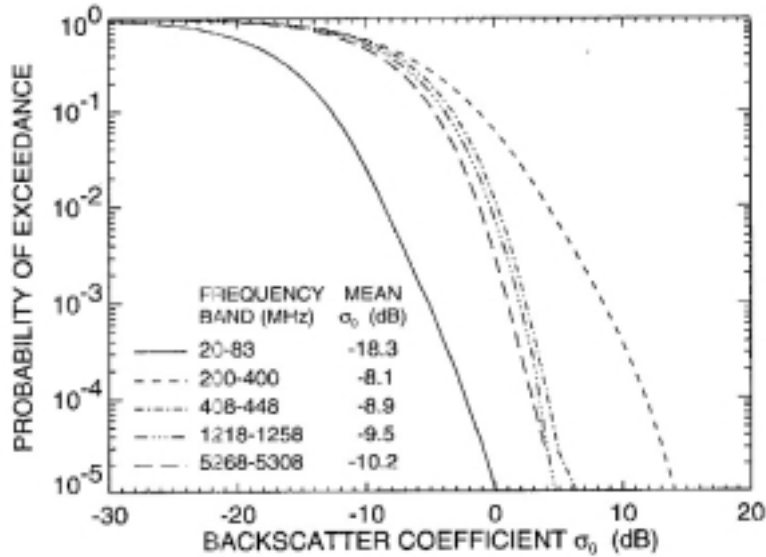

Figure 5. Exceedance Diagram for Backscatter from 20 – 5300 MHz

1.2 Clutter

We have two studies to draw from in order to put an estimate on forest backscatter clutter. This clutter forms the background in the SAR image with which the target echoes has to compete, and so is fundamental in determining how successful a penetration radar might be in detecting downed aircraft.

In 1995, a study was conducted by DARPA on the relative radar performance over tropical and Northern Maine forests. Figure 5, taken from a report by Binder et al (1995), shows the backscatter to be expected. The forest in Maine was from a site in Portage, and is not unlike Canadian forests in its composition. From this figure one can see that the forest backscatter coefficient (S_0) is around -9 dB (actually dBsm/sm) at the 3dB point for most frequencies of interest. This figure, however, appears to be mislabeled since the graph indicates a trend that is not consistent with frequency. Since the curves are so closely bunched at the 3dB point, it doesn't matter.

Notably, the change in mean backscatter from the 200-400 MHz band even to the L Band radar is only 1.4 dB, indicating that backscatter should not be an important factor in choosing between VHF, UHF and L Band frequencies for S&R applications. This is a surprising result, since in these types of forest, the leaves are significantly smaller than a wavelength, i.e. in the Rayleigh scattering region. We do however see the rapid fall off in backscatter at the lowest frequency shown (20-83 MHz). The importance of this parameter is that it determines the background clutter in the image, and therefore the smallest target that can be reliably detected under a forest canopy.

A second study (Dreyer 1995) shows a classical clutter distribution (Figure 6) with a mean of -2.9 dB. The difference in these two studies is most probably due to the higher

backscatter from the wet Californian forest with higher leafy deciduous content. For Canadian forests, we would expect numbers closer to the Maine example of -9dB .

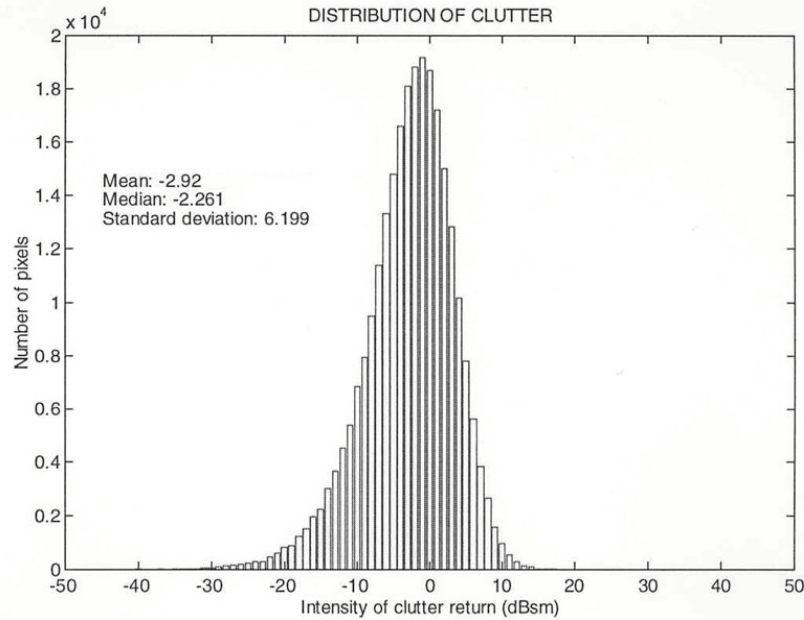

Figure 6. Clutter Distribution for Californian Forest, 200 – 400 MHz (Dreyer 1995)

The shape of the distribution curve changes somewhat between flat, horizontal ground and hilly or mountainous terrain. In the case of flat terrain, the tail of the distribution curve extends toward higher values since it contains contributions from the retroreflector effect when the tree trunk and ground are at 90 degrees to each other. The SRI site was hilly however, and these exaggerated tails do not show. The other point to note is that the forest clutter occurs in the upper canopy structure plus tree trunks, and is not subject to the same attenuation as a target sitting on the ground. If we assume that we are looking for multi-pixel detection, then a margin of 10dB for target / clutter ratio should be more than adequate. Therefore, we are looking for targets to be in the range from +1 to +7dB or higher to permit a high probability of detection.

1.3 RCS of Metal Targets

We have seen that radar signals can penetrate foliage, but that the foliage produces some attenuation, backscatter, and loss of coherence. Before we can calculate the probability of detecting downed aircraft, we need to estimate the cross section of aircraft sections at penetration frequencies. The RCS values for aircraft or parts of aircraft are not widely known in the frequency range from 200 – 1000 MHz, but can be modeled given a few simple assumptions. Given a background clutter of -9dB to -3dB as seen above, and using a detection criterion of 10dB for the SCR, then we need to have aircraft sections with an individual RCS of +1dB to +7dB. However, the forest attenuation introduces a loss of 8 to 16dB, which increases the necessary target cross section accordingly to +9 to +23dB.

The RCS of a short cylinder and a flat plate are given (Knott 1990) as:

$$\begin{aligned} \text{And} \quad \text{Sigma} &= 2 \rho r h^2 / l && \text{(cylinder)} \\ \text{Sigma} &= 4 \rho w^2 L^2 / l^2 && \text{(flat plate)} \end{aligned}$$

where

- r = cylinder radius
- h = cylinder length
- w = flat plate width
- L = flat plate length
- l = wavelength, 0.75m equivalent to 400 MHz

A typical light twin engined aircraft might have a 10m wing span, which could give rise to wing sections 5m x 1m and fuselage sections as large as 1.5m diameter and 2m in length. These would give a peak RCS of 14 dB and 27dB in the specular direction. If the aircraft were to break up into numerous small sections, not in contact with each other, then the RCS values would become too small to compete with the clutter. For example, for a 10dB excess over the clutter of -9dB, the flat plate would have to be larger than 1.5m on a side. In addition, the pieces would have to face the aircraft in order to obtain the specular effect and maximise the RCS. In the along-track direction this is not such a problem, since the integration angle for these radars can be as high as 60 degrees, thus catching the specular flash anywhere in that angle. In the depression direction however, it is much more difficult, and smaller targets stand a better chance of detection since their polar pattern is much broader. For example, a 1.5m square plate would have 3 dB points at about +/- 15 degrees from the normal direction indicating that the radar would have a 30 degree depression window to take advantage of the highest RCS values. Strangely, decreasing the frequency helps this problem since at lower frequencies, while the peak RCS values decrease, the polar pattern of a small metal target becomes wider in azimuth and elevation,.

Table II shows some RCS values of possible aircraft sections. At a resolution of 0.75 x 0.75m, the 3m cylinder with its RCS of 18 dBsm for example would occupy 8 pixels. This would be more than adequate for detection.

Table II Peak RCS of Sample Model Sections

RCS Values			
Center Frequency (MHz)	300	500	1100
Target Geometry			
Cylinder (2x1.5m)	11.5db	13.7dB	17.1dB
Cylinder (2x3m)	17.5 dB	19.7dB	23.1dB
Cylinder (2x5m)	22dB	24.2dB	27.6dB
Plate (1x1.5m)	14.5dB	19dB	25.8dB
Plate (1x3m)	20.5dB	25dB	31.8dB
Plate (1x5m)	25dB	29.4dB	36.3dB

As the radar frequency is decreased, the peak RCS decreases, but the polar scattering diagram broadens until the target radiates as a whole body resonator, with little fine structure in the RCS polar plot. In a study by the Army Research Laboratory (Sullivan 1995) it was found that low pass filtering on the radar image data produced better target/clutter ratios and enhanced the detection probability for targets under foliage.

1.4 Target Detection

The target RCS is something we can calculate by making some assumptions about the size and characteristics of the crashed aircraft. All these considerations will lead to an indication of how well the target will be detected, however, there is a larger and less well-defined problem, and that is how well we can identify the target after it has been detected. This topic has been the subject of much research in the radar community, and is by no means a completed study. We do know that identification from a single polarization data set is difficult, and that the availability of multiple polarizations brings with it opportunity for discrimination against such things as tree trunks. The biggest problem in analyzing previous radar images of metallic targets under trees has been the presence of large rock outcrops, road cuts, slide areas, etc., which give rise to large radar reflections not unlike those from the desired target. James and Hoff (1993) published the radar operating curves (ROC) for the foliage penetration radar scenario in which the false alarm rate for detection of a +20dB target under forest was shown to be 10^{-5} .

Table III shows the excess SCR for the canonical targets used above assuming the lower of the two backscatter numbers given earlier.

Table III: Signal to Clutter Ratio for Various Frequencies

Frequency	200-400 MHz	400-600 MHz	1000-1200 MHz
Two-way Attenuation (fig1)	8	12	35
Clutter	-8	-9	-10.5
Signal to Clutter Ratio			
Cylinder (2x1.5m)	11.5	10.7	-7.4
Cylinder (2x3m)	17.5	16.7	-1.4
Cylinder (2x5m)	22	24.2	3.1
Plate (1x1.5m)	14.5	20.4	1.4
Plate (1x3m)	20.5	22.4	6.3
Plate (1x5m)	25	26.4	11.8

The net result from these calculations is that both the 200-400 and the 400-600 MHz band produce comparable performance which would be acceptable for S&R purposes, but the L Band performance is significantly worse. Thus, the operating frequency for a CC-130 installation can be increased to the 400-600MHz band, and the antenna size reduced to 50cm aperture without significant loss of detection performance.

As an added verification of this result (at least at the 200-400 MHz band) the following two figures show radar images in which a flat plate (2m x 5m) is clearly visible without any processing other than image formation. The SNC numbers are lower than the previous calculations would indicate, but this represents the difference between theory and practice.



**Figure 7. An Example of a Metal Plate Target (broadside) 2x5m under Tropical Forest
Signal to clutter ratio is + 20dB**

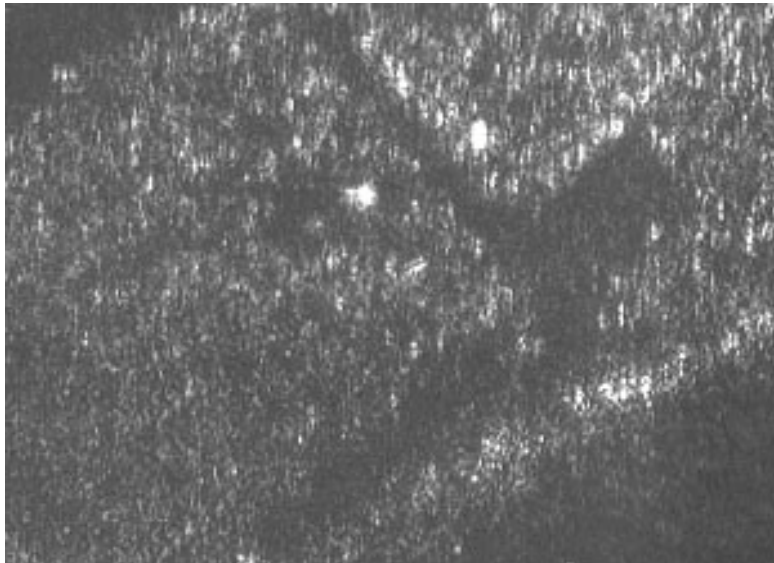

**Figure 8. Examples of two 2x4m Flat Metal Panels under California Forest
(one end-on, one broadside, SCR is +17 and +20dB)**

For the remainder of this study, we will assume that the 400-600 MHz band is to be used. As will be seen, the radar properties of the other concealment mechanism, snow, are favorable all the way from VHF to C Band.

2. Penetration through Snow and Ice

2.1 Losses through Snow

The propagation of radar waves through snow and ice is somewhat simpler than in the case of forestry. Dry snow has an extremely low loss tangent for radar energy up to at least 4000 MHz. Similarly ice (but not sea ice) is transparent to radar profiling. Data has been taken from 60 to 600 MHz showing ice depths in excess of 2000m. The case where snow becomes less than transparent is when there is liquid water present in equilibrium with the snow. This happens in the springtime, when the snowpack is said to 'ripen', i.e. melt. Melt water from the surface percolates downwards and eventually forms a water-rich layer near the bottom of the snowpack. In general, the pack turns into a graded dielectric with dry snow at the top ($\epsilon = 1.6$) to a slurry at the bottom where the permittivity (ϵ) is up to 30-40. This results in increasing reflectivity as the water content increases. Nevertheless, even with a water interface present, the reflection losses are not overwhelming, as we shall see.

It is well known that radar penetrates dry snow. Work at the Scott Polar Research Institute, and at the Technical Institute of Denmark in the 1970's have shown that radars in the range from 60 to 600 MHz can map through snow and ice to the bottom of the Greenland and the Antarctic ice caps. Work by the author (Vickers 1973) showed that snow depth and density could be obtained at frequencies up to S Band (2-4 GHz) through alpine snow pack many meters thick, and could even show subtle layering within the snowpack related to solar heating during its history of formation. Figure 9 shows such a profile through 160cm of snow. In this data, taken in March 1972, the snowpack had accumulated over a period of three months at an altitude of 3500ft and was still dry, although the increasing density near the bottom can be clearly seen. Although the density is 0.4 at the bottom of the pack, the dielectric constant is still low, since the value for pure ice is only $\epsilon = 3.2$, whereas for water $\epsilon = 81$.

The reason that these numbers are important of course is that the reflection coefficient at a snow / air or snow / water boundary is a strong function of the relative values of ϵ at the interface. The actual formula for 90 degree incident radiation being

$$R = (\text{Re}_1 - \text{Re}_2) / (\text{Re}_1 + \text{Re}_2)$$

where R is the real part of the reflection coefficient.

The amplitude reflection coefficients and power losses are shown in Table IV for various interfaces that S&R might encounter.

Table IV Interface Losses in Snowpack

Interface	Epsilon Ratio	Refl. Co-eff (E field)	Power Loss (2-Way)
Air/Snow	1 : 1.6	0.11	0.1 dB
Snow/Ice	1.6 : 3.2	0.17	0.25 dB
Old snow/ice	2.1 :3.2	0.1	0.08 dB
New snow/frozen soil	1.6 : 4.0	0.225	0.46 dB
Snow /water	1.6-2.1 : 81	0.7	5.0 dB

In contrast, the reflection coefficient of a conductor such as aircraft metal parts (at normal incidence) is 1.0.

In fresh snowpack we would expect to have reflection losses at the upper surface and perhaps one snow/ice layer, i.e., a total loss of 0.26 dB two-way attenuation. In the extreme case of liquid water above the target aircraft, (an unlikely scenario) the two-way losses would be more significant at 5.1 dB. In summary, snow cover is not a consideration unless there is significant recent liquid water present, which has not had time to drain to the bottom of the snowpack.

In addition to the low attenuation from snow, the backscatter, or clutter generated from snow layering will also be insignificant, unlike the case of foliage, since the layers themselves will be smooth compared to a wavelength.

For aircraft downed in snowstorms, the snow cover might be dry or it might have significant moisture, but it is unlikely that liquid water would be present in sufficient quantity to disguise the reflection from metallic targets above 30cm or so above the ground. Examples of radar penetration through both wet and dry snow exist in the literature, although they are not abundant.

The data taken in Figure 9 were obtained in 1972 at the beginning of the spring thaw at about 3,500ft altitude in the Rocky Mountains. Some fresh snow was present on the top of the pack, and several layers existed where solar heating had produced an ice crusting during the buildup of the snowpack. The various layers inside the snowpack can be seen. The vertical resolution of this system was 7.5cm. The liquid water runoff at the bottom of the snowpack can also be seen, and it should be noted that this runoff appears to occupy only the lowest few centimeters of the pack. One can imagine that if parts of downed aircraft were present, they would project above the lower 30cm of the snowpack, and would thus be quite visible, even at 2.2GHz. Other workers have successfully profiled through snow at frequencies between 60 and 7000 MHz. Figure 10 shows one such profile traversing across multi-year snowpack 8m thick at 900 MHz in Northern Sweden. It should be noted that the figure is of raw, totally unprocessed data, and that SAR imagery will be photographic format and easy to interpret.

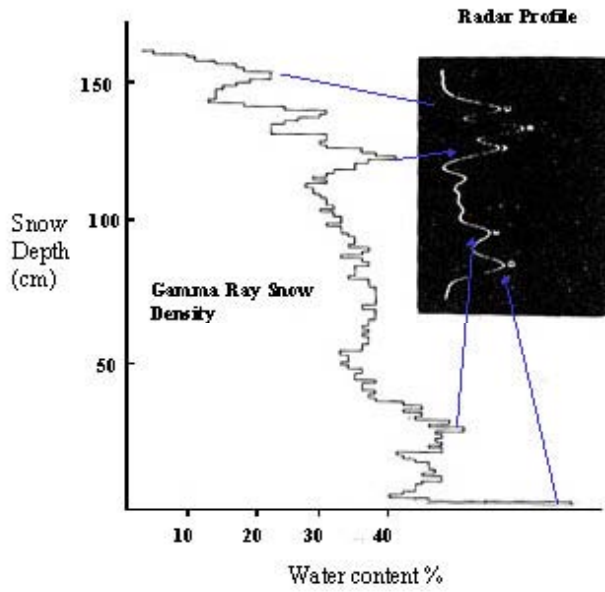

Figure 9. A Radar Profile through Alpine Snowpack (1972) at 2200 MHz. (Vickers 1973)

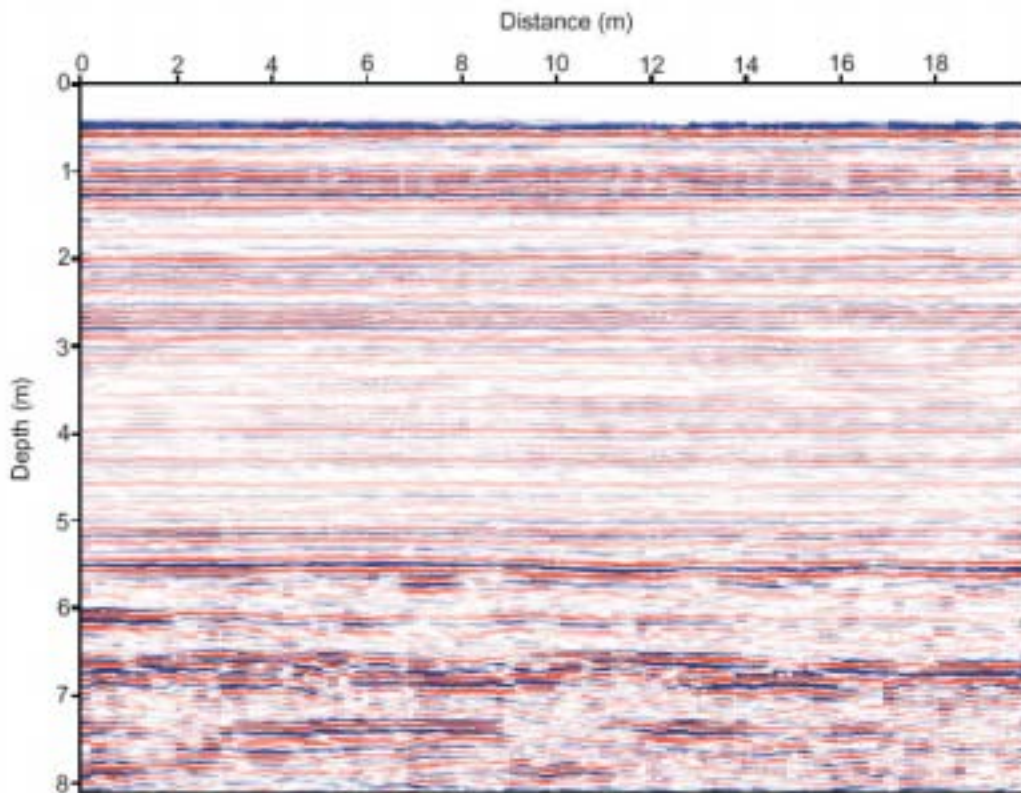

Figure 10. Vertical Profile through Dry Snowpack at 900 MHz showing Internal Layering despite Low Reflection Coefficients. (De Brabander 2003)

The example shown in Figure 10 is taken at 900 MHz and shows detailed layering in multi-year snowpack. Despite the low reflection coefficients, the layers themselves are well visualised. A metal target in such a record would stand out extremely clearly.

In summary, snow cover will not degrade the penetration radar performance at the 400-600 MHz range, and the system we suggest for S&R would therefore have its frequency dictated by the need to penetrate forest cover rather than by snowpack losses.

2.2 General Comments

Several parameters have been ignored in this discussion, and they are important. The first is that mountain geometry will frequently be difficult for any SAR imaging system. Steep valleys can only be successfully imaged by flying 90 degrees to the valley, or by directing the radar beam vertically, (which is a possibility if we use the CC-130 arm and pod). The second is that if the downed aircraft is indeed on a steep hillside, then there might well be a thick layer of rocks and boulders under the snow / foliage giving rise to higher clutter levels than have been used above. This type of clutter source in fact may be the greatest problem that a penetration radar will have when used in S&R missions. On the other hand, the use of the polarisation ellipse can enhance the reflections from metallic targets and thereby enhance the detection probability for aircraft sections.

2.3 Recommended Frequency Range

The previous sections show that there is a small penalty to be paid for increasing the operating frequency for foliage penetration work beyond the 200-400 MHz range, and no penalty for penetration of snow. The range (nominal) from 400-600 MHz was deemed to be suitable both in terms of the detection performance and also in the ability to mount the smaller antennas for this range on the CC-130 pod. Some small adjustment (raising the frequency by 35 MHz) could be made to achieve a more efficient antenna without enlarging the envelope of the pod at all. There are some issues still evolving about radiation regulations in this frequency band, but in general this type of radar has such a low average radiated power spectral density, (10W over 200MHz), that it will not be a source of interference for ground or satellite based installations. Therefore, for the remainder of this study, we will assume a nominal frequency band of 400-600 MHz. Even at this higher frequency some minor modification of the CC-130 pod will be necessary to accommodate the antennas if quad-ridged horns are used. This will be discussed later.

Part II Aircraft Installation Considerations

3.1 Antenna Size

The results of the investigation into radar penetration through foliage and snow indicate that a frequency of 400-600 MHz would be low enough for successful detection of metal aircraft sections on the ground. This would imply a minimum antenna size of 50cm square. The CC-130 arm and pod have two aperture sections 22" x 17" (56 x 43 cm) which could be used for antenna placement. By allowing a small protrusion outside the envelope of the pod, a 50 cm square antenna could be incorporated. Alternatively, raising the lower frequency bound of the operating bandwidth to 465 MHz would permit a conformal fit. The depth (axial length) of the antenna is approximately equal to the aperture if a short axial horn design is used. Again, this can be accommodated by either modifying the pod envelope slightly, or by raising the operating frequency, if a conformal antenna design can be used. If quad-ridged horns are used, which right now is the antenna of choice, then they would protrude from the pod as shown in Figure 11. The protruding section would then have to be faired in with a fiberglass blister raydome similar to that used on the C-12 baggage pod shown in Figure 12.



Figure 12. Horn Antenna Installation on a C-12 Baggage Pod

The necessity for this blister would be eliminated by either raising the frequency still further, or by using a conformal surface antenna such as the sinuous antenna mentioned earlier. To our knowledge, this form of antenna has not been tested in an application such as discussed here, although they have been used extensively as feed elements for reflector antennas. Calculations in the earlier sections of this report show that there is significant excess SCR for plates and cylinders of the size used in the study. However, raising the frequency will reduce the sensitivity of the system due to increased attenuation, and this will mean that smaller pieces of aircraft debris will not be as easy to detect. From the practical standpoint, it may be considered preferable to raise the frequency than to modify the pod. The issue arises mostly in the case of targets under trees, since snow cover is transparent beyond any frequencies considered in this report. If the frequency is raised to have nominal lower band edge of 435MHz, then an installation similar to the artist's drawing in Figure 13 will be possible.

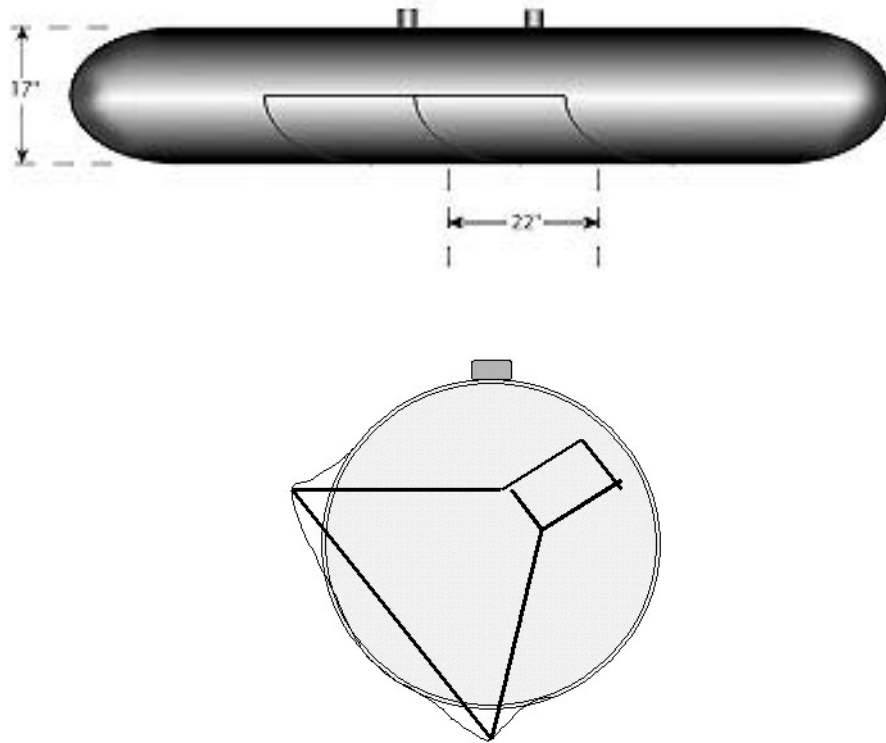

Figure 13. Possible Antenna Mounting in CC-130 Pod

The other possibility for antenna placement is on the pallet itself, using the window section as a raydome. This would permit the use of lower frequencies, but would place the antenna in a higher location where some energy would undoubtedly scatter from the aircraft fuselage itself, even if a depression angle of 45 degrees are used. The wing pod structures would intercept the sidelobes of radar beam and generate scattered energy that would decrease both the sensitivity and resolution of the installation. The preferred location for the antenna is underneath the door, mounted integral with the RMAS pod, as

shown diagrammatically in Figures 14 and 15. With the beam pointed downwards from the pod, there would be minimal interaction with the aircraft structure since the pod is the lowest point on the aircraft.



Figure 14. Radar Beam in Elevation and Azimuth when Antennas are mounted in the Pod

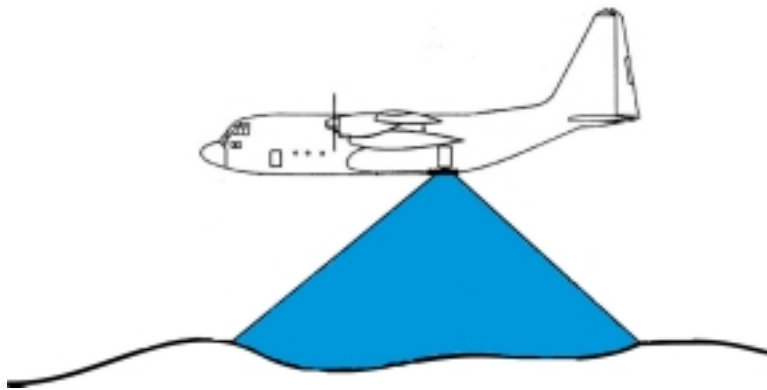

Figure 15. Radar Beam in Azimuth, assuming 90 degree beamwidth (-10dB)

An added thought to the pod mounting is that a second pair of conformal antennas could be mounted looking down vertically, for use in steep slope areas, where conventional SAR geometry does not work, since the slope face would be almost orthogonal to the radar beam, and the range resolution would be zero.

The azimuthal beamwidth is determined by the frequency of operation and the required along-track resolution. With a bandwidth of 200 MHz, it has been possible in the past to come close to the theoretical resolution (along-track) of 0.75m. In order to achieve this with a center frequency of 500 MHz, we will only need an azimuthal integration angle of 22 degrees. If we use one of the two 56cm apertures present in the pod for the receiver antenna however, then the resultant along track beam will be 61 degrees at the 3dB points, i.e. +/- 30 degrees, and over 90 degrees at the -10dB points. This means that some energy is radiated outside the integration envelope, giving the opportunity for multi-look processing. Clearly, along-track resolution will not be limited by the antenna beamwidth. We should not however, ignore the decreased beamwidth at the upper end of the band when using an aperture antenna, as this will place some limits on the squint

angles used in multi-look processing. In the elevation direction, the situation is more serious, since the square aperture in the pod will result in a ± 30 degree beam in elevation as well, which means that the upper 3dB bound on the beam will be depressed only 15 degrees from the horizontal. Some residual energy therefore will scatter from the aircraft, although as shown in Figure 13, it will be minimal, since the aircraft structure is 20 degrees up from the horizontal when viewed from the pod location. Some energy will also radiate on the wrong side of the aircraft, but only in a minimal fashion in the 30-60 degree zone. In many previous installations on a number of different aircraft, this has not proved to be a problem for left/right ambiguity.

Figure 16 shows the CC-130 with the radar beam issuing below the cargo door. The pod is clearly the preferred location for a radar antenna using a wide beamwidth.



Figure 16. A CC-130 Showing the Radar Beam in relation to the Aircraft Structure

3.2. Positioning Data

At the kick-off meeting with Major Kirkland it was apparent that the radar system should carry its own positioning sub-system so as not to place a requirement on the CC-130 equipment, the composition of which could change according to the particular payload

installed. Thus we can specify the positioning requirements with no regard to the to CC-130 existing positioning system.

The requirement for high quality radar imagery in the UHF frequency range are:

Relative position, (x,y,z)	+/- 10cm for 30 seconds.
Update rate	100 per second
Attitude (roll,pitch,yaw)	+/- 3 degrees
Latency	< 20 ms
Time tag	1 / sec
Frequency standard	10 MHz

In previous installations, the attitude information has not been recorded, and the flight lines have all been flown under smooth, level flight conditions. This is a typical mode for data collection with any SAR system, although it may not be typical for search and rescue flights. If smooth flight conditions are not possible, then the attitude information will be needed. This implies the use of either multiple GPS antennas, or an inertial measurement unit, which adds significantly to the cost of the system. We will plan that all positioning requirements for the radar will be met by stand-alone equipment included in the roll-on package. In the past, the tightly coupled INS/GPS system marketed by Honeywell under the name M-Migits, at a cost of under \$50,000 USD, has been adequate for these radar systems. The fact that the pallet is liable to undergo significant shock during handling points towards the use of a solid state gyro, to avoid continual re-calibration expense and delay.

3.3 Operator Station

The location preferred by DAR-2 for the radar is adjacent to the cargo door. The radar and operator station can both be mounted on a palette that rolls up to the door, and this configuration would work well whether the antennas are on the pod or in the opening itself. The station will be similar in all respects to other operator stations as illustrated in NSS documents presented at the kick-off meeting. An illustration of this type of configuration is shown in Figure 17. The radar equipment will occupy a single standard rack with a height of 36 inches. The total weight of the radar payload will be under 260 lb, (120 Kg) plus the operator.



Figure 17. RMAS Palette with the AS-7 strut that will hold the Radar Antenna Pod. Radar Rack is shown to scale. The addition of a real time processor increases the equipment size by 50%.

3.4 Modifications to the Aircraft

3.4.1 Radar Antennas

The largest modification is the attachment of the radar antennas. This involves having a dedicated pod which is deployed on the AS-7 articulated arm so that the antennas have an unobstructed view of the ground beneath. The antennas have a vertical angle of view of 60 degrees, (3dB points), and a vertical depression angle of 45 degrees. Thus the upper 'edge' of the radar beam will be approximately horizontal. In the horizontal plane, the beam is also +/- 30 degrees which means that there can be no obstructions fore and aft of the pod. The usual choice for ground penetration radar antennas themselves has been quad-ridged horns, since they exhibit good front-back ratio, wide bandwidth and low dispersion. For the CC-130 pod, there is another possibility, and that is the sinuous antenna, which could be made conformal with the outside of the pod. Figure 13 shows such an antenna, which outwardly resembles a cavity-backed spiral, but in fact is two crossed dipoles with a shallow cavity. These antennas are wide band, and do not have the -20dB front-back ratio of the horns, but are an extremely convenient geometry for pod mounting.

3.4.2 GPS Antenna

The GPS antenna is best mounted on the top of the fuselage, or on top of the vertical stabiliser. There are undoubtedly GPS antennas at such locations already, and the signals from these could be split out to provide positioning information for other systems such as the penetration radar. Even mounting a dedicated antenna for pod sensor would not impact roll-on roll-off requirement, since the GPS antenna is small, and could even be

removable and attached in a temporary manner to the fuselage. Attachment on the pod is not possible because of shadowing effects. This is true for any sensor packages mounted in the pod, not just the radar. Cabling for the antenna is typically 0.141" diameter semi-rigid or similar co-axial cable used regardless of which sensor package was selected for a given mission, and could be terminated close to the pod location. A number of antennas are available which are 'universal' in the sense that they work with any of the major GPS receivers. An example would be the Universal Avionics #10705 which operates from 5 – 18 VDC and receives both Glonass and GPS signals.

3.4.3 Power

The power harness for the aircraft provides 28 VDC power with outlets close to the cargo door. No other power will be required, and therefore no aircraft modifications for delivering raw power will be necessary. The total requirement for the radar will be approximately 50 amps continuous, and 75 amps turn-on peak. All inverters, power conditioners etc for the radar will be self-contained.

3.4.4 Display

The display will be physically located on the palette, but the information has to be transferred to the mission commander in the event that a likely target location is identified. The simplest way of achieving this is to keep all image viewing and interpretation in the radar station, and just transmitting the GPS co-ordinates and probability of detection for suspected targets sites to the mission commander. This would result in a very low data rate, possibly even transmitted verbally, with little impact on other CC-130 systems. A snapshot image could also be sent at the expense of a higher data rate, but would require a more sophisticated interface with the CC-130 systems.

3.4.5 EMI / EMC

The only way we can address this problem without knowing the EM characteristics of all possible payloads on the CC-130, is to establish the spectrum power levels transmitted by the radar and to see if the payload has any particular sensitivity to the wavelengths used. Unfortunately, the radar has its own sensitivity to incoming radiation and there is a real potential that other radiators on the aircraft will impair the imaging performance of the radar. Designs are available in which the radar receiver can jump over specific conflicting frequencies providing that there are not too many of them. The average output power of the radar is 10 W spread over a minimum of 200 MHz. Therefore in each 25 KHz spectral cell the average power radiated by the radar is 1.25 mW. In addition, these numbers refer to the power in the main lobe of the antenna. Any acceptable antenna design would reduce the amount of power impinging on the aircraft itself by a further 10-20dB. The resulting low levels of 10 – 100 microwatts / 25KHz could conceivably interfere with, but not damage, other sensors on the aircraft. Experience with these radars on some 27 different aircraft installations has shown that no detectable interference with aircraft avionics, including GPS, TACAN, or ILS can be expected, but that during flight line acquisition the aircraft VHF/UHF communications cannot be used in the transmit mode.

Because of the nature of S&R operations, there is clearly a need for near-real time data reduction and image generation. This requirement has an impact on the size and power consumption of the radar package, as well as generating another electrical and mechanical interface into the aircraft's existing operator stations.

The radar output needs to be presented so that a minimum of operator training is required to interpret the imagery. If other sensors are being used simultaneously, then at a minimum, a side-by-side viewing station must be provided to glean maximum benefit from the data. SAR, by its very nature, cannot work successfully on all surfaces of steep terrain, since the radar wave must traverse the ground in the scene in a sequential manner. The opposite is true for optical sensors, which have minimum distortion when the sensor views the side of a mountain at normal (90 degree) incidence. Thus there is some need to recognise the limitations of each device, and plan missions accordingly.

Summary of Aircraft Integration Requirements

Antennas	Can be mounted in CC-130 pod with a blister fitting Can be mounted with no blister with reduced performance
GPS	Need access to an existing GPS antenna
Power	Need access to 28 VDC 100 amp
EMI	Some modification to survey procedures
Display /Information interface	Not determined, but input into mission manager's display would be optimum.

3.5 Conclusions and Recommendations

The study concludes that the penetration radar can be operated from the CC-130 RMAS pallet and associated pod using a frequency range which will be effective in detecting concealed sections of downed aircraft. The minimum size of detected metal parts will depend mostly on the background clutter in the radar image. In many scenes this will most likely be due not to snow or forest properties, but to surface rockfall in the area which itself has also been covered by foliage or snow. Pieces of metal two or more meters across will be readily detectable from a wide range of illumination angles. Snow cover is not an impediment to radar detection in this frequency range, or indeed for any frequencies, even beyond L-Band.

The radar system can be fitted entirely on the RMAS pallet, with the antennas fitted in a pod attached to the AS-7 arm. The external interface for the CC-130 is only needed for a GPS antenna, and for integrating the detection information into the mission search protocol. We recommend that the results of this study be validated by a series of test flights over test downed aircraft, or aircraft parts, in a variety of concealment conditions, including

- Snow on level ground,
- Snow on hillsides,
- Foliage on level ground, and
- Foliage on hillsides.

Since data on snow penetration of imaging radar is sparse, snow conditions should be measured at the time of flight to determine the liquid water content to increase the value of the measurements. The tests should include both the easy case of horizontal terrain, and the more challenging case of inclined terrain, both with snow and foliage cover. Images from these tests can be used to estimate signal/clutter ratios and detection probabilities for a variety of sizes of aircraft sections.

Overall, the probability of successful aircraft detection under either form of concealment is rated high except where the terrain is too shear for SAR geometry.

REFERENCES
(In order of citation)

1. Bessette, L.A.; Ayasli, S.; "Ultra-wideband P-3 and CARABAS II foliage attenuation and backscatter analysis" Radar Conference, 2001. Proceedings of the 2001 IEEE, 1-3 May 2001, Page(s): 357 –362.
2. Fleischman, J.G.; Ayasli, S.; Adams, E.M.; Gosselin, D.R.; "Foliage attenuation and backscatter analysis of SAR imagery" IEEE Transactions on Aerospace and Electronic Systems, Volume 32, Issue 1, Jan 1996, pp 135-144.
3. Tamasinis, Douglas, "Application of Volumetric Scattering Approximations to Foliage Media", Radio Science, Vol. 27, No. 6., pp. 797 - 812, Nov. - Dec. 1992.
4. Sheen, D. R., et. al., "Foliage Transmission Measurement Using a Ground-Based Ultrawide Band (300 1-1300 MHz) SAR System", IEEE Transactions, Geoscience and Remote Sensing, Vol. 32, No. 1, January 1994.
5. Binder, B.T.; Toups, M.F.; Ayasli, S.; Adams, E.M.; "SAR foliage penetration phenomenology of tropical rain forest and northern US forest" Radar Conference, 1995., Record of the IEEE 1995 International , 8-11 May 1995 Page(s): 158 –163.
6. Bessette, L.A.; Crooks, S.M.; Ayasli, S. "P-3 ultra-wideband SAR, Grayling, Michigan, target and clutter phenomenology" ; Radar Conference, 1999. The Record of the 1999 IEEE , 20-22 April 1999, Page(s): 125 -129
7. Dreyer K, "Analysis of Foliage Penetration Radar results from Soquel Quadrangle." SRI Final Report, NASA Geosar Project 1995.
8. Knott, Eugene F., Radar Cross Section. Chapter 11 of the "Radar Handbook", 2nd ed., Merrill I. Skolnik, ed., Mcgraw-Hill, New York, New York, 1990.
9. Sullivan, A. Advanced Modeling and Simulation of Low Frequency Foliage Penetrating Radar. US Army Research Laboratory, Research Report 1995 (<http://www.asc2002.com/manuscripts/H/HO-04.PDF>)
10. James, Robert R., and Lawrence E. Hoff, "Investigation of SAR Target Detection Algorithms Using Narrowband and Ultra Wideband Sensors", Naval Command, Control, And Ocean Surveillance Center report, San Diego, California, 15 May 1993.
10. Vickers R.S., Rose G. Snowpack Depth and Density. Final Report, Alpine Snow Project, 1973, Dept of Electrical Engineering, Colorado State University,
11. Dr Brabander, S., A Snow Cover Experiment at Tarfala Research Station with UHF Ground Penetrating Radar. (submitted) Arctic Centre April 2003. Vryje Universitiet Brussel.

Further References (not cited in this report)

1. James, R. R., INVESTIGATION OF SAR TARGET DETECTION ALGORITHMS USING NARROWBAND AND ULTRA WIDEBAND SENSORS. Presented at Third Automatic Target Recognizer System and Technology Conference, Monterey, California, 06/29/93. Published in Proceedings, Third Automatic Target Recognizer System and Technology Conference, June, 1993,
2. Vickers, Roger S., and Walter G. Chestnut, "Foliage-Penetrating Synthetic Aperture Radar", Final Report, SRI Project 1428, SRI International, Menlo Park, California, January 1992.
3. Vickers, Roger S., et. al., "Detection and Classification of Concealed Targets", Final Report, SRI Project 3928, SRI International, Menio Park, California, March 1994.
4. T. Miller and L. C. Potter, "Estimation of UWB target responses from images," *Proceedings Fourth Annual ARL Federated Laboratory Symposium, Advanced Sensors Consortium*, pp. 231-235, March 2000, College Park, MD.
5. Timothy R. Miller, John McCorkle and Lee C. Potter, "Radio frequency interference suppression for foliage penetrating radar imaging," *IEEE Transactions on Aerospace and Electronic Systems*, vol. 33, no.4, pp. 1142--1156, October 1997.

UNCLASSIFIED

SECURITY CLASSIFICATION OF FORM
(highest classification of Title, Abstract, Keywords)

DOCUMENT CONTROL DATA (Security classification of title, body of abstract and indexing annotation must be entered when the overall document is classified)		
1. ORIGINATOR (the name and address of the organization preparing the document. Organizations for whom the document was prepared, e.g. Establishment sponsoring a contractor's report, or tasking agency, are entered in section 8.) Environmental Mapping Canada 203-2776 Bourquin Place Abbotsford, British Columbia V2A 6A4		2. SECURITY CLASSIFICATION (overall security classification of the document, including special warning terms if applicable) UNCLASSIFIED
3. TITLE (the complete document title as indicated on the title page. Its classification should be indicated by the appropriate abbreviation (S,C or U) in parentheses after the title.) Feasibility Study for Enhanced CC-130 Search and Rescue Capability with a Ground Penetrating Radar(U)		
4. AUTHORS (Last name, first name, middle initial) Vickers, Roger		
5. DATE OF PUBLICATION (month and year of publication of document) March 2004	6a. NO. OF PAGES (total containing information. Include Annexes, Appendices, etc.) 27	6b. NO. OF REFS (total cited document) 11
7. DESCRIPTIVE NOTES (the category of the document, e.g. technical report, technical note or memorandum. If appropriate, enter the type of report, e.g. interim, progress, summary, annual or final. Give the inclusive dates when a specific reporting period is covered.) Contractor Report		
8. SPONSORING ACTIVITY (the name of the department project office or laboratory sponsoring the research and development. Include the address.) Defence R&D Canada - Ottawa National Defence Ottawa, Canada K1A 0Z4		
9a. PROJECT OR GRANT NO. (if appropriate, the applicable research and development project or grant number under which the document was written. Please specify whether project or grant) DRDC Ottawa Project: 13db29	9b. CONTRACT NO. (if appropriate, the applicable number under which the document was written) W7714-030743/001/SV	
10a. ORIGINATOR'S DOCUMENT NUMBER (the official document number by which the document is identified by the originating activity. This number must be unique to this document.) EMC-G04011	10b. OTHER DOCUMENT NOS. (Any other numbers which may be assigned this document either by the originator or by the sponsor) DRDC Ottawa CR 2005-033 SAR New Initiatives Fund: DND #4/03	
11. DOCUMENT AVAILABILITY (any limitations on further dissemination of the document, other than those imposed by security classification) <input checked="" type="checkbox"/> Unlimited distribution <input type="checkbox"/> Distribution limited to defence departments and defence contractors; further distribution only as approved <input type="checkbox"/> Distribution limited to defence departments and Canadian defence contractors; further distribution only as approved <input type="checkbox"/> Distribution limited to government departments and agencies; further distribution only as approved <input type="checkbox"/> Distribution limited to defence departments; further distribution only as approved <input type="checkbox"/> Other (please specify):		

12. DOCUMENT ANNOUNCEMENT (any limitation to the bibliographic announcement of this document. This will normally correspond to the Document Availability (11). However, where further distribution (beyond the audience specified in 11) is possible, a wider announcement audience may be selected.)

Unlimited Announcement

UNCLASSIFIED

SECURITY CLASSIFICATION OF FORM

UNCLASSIFIED

SECURITY CLASSIFICATION OF FORM

13. ABSTRACT (a brief and factual summary of the document. It may also appear elsewhere in the body of the document itself. It is highly desirable that the abstract of classified documents be unclassified. Each paragraph of the abstract shall begin with an indication of the security classification of the information in the paragraph (unless the document itself is unclassified) represented as (S), (C), or (U). It is not necessary to include here abstracts in both official languages unless the text is bilingual).

Penetration radars have been successful in detecting and locating many types of metallic targets under foliage, including flat plates, vehicles, reflectors, and pipes. The purpose of this study is two-fold:

- (1) define the radar operating parameters, especially frequency, that would maximise the chances of success for a penetration radar mounted on the CC-130 for detection of downed aircraft in search and rescue operations; and
- (2) investigate the feasibility of mounting a foliage penetration radar on the CC-130 RMAS.

The study concludes that the penetration radar can be operated from the CC-130 RMAS pallet and associated pod using a frequency range which will be effective in detecting concealed sections of downed aircraft. The minimum size of detected metal parts will depend mostly on the background clutter in the radar image. In many scenes this will most likely be due not to snow or forest properties, but to surface rockfall in the area which itself has also been covered by foliage or snow. Pieces of metal two or more meters across will be readily detectable from a wide range of illumination angles. Snow cover is not an impediment to radar detection in this frequency range, or indeed for any frequencies, even beyond L-Band.

14. KEYWORDS, DESCRIPTORS or IDENTIFIERS (technically meaningful terms or short phrases that characterize a document and could be helpful in cataloguing the document. They should be selected so that no security classification is required. Identifiers such as equipment model designation, trade name, military project code name, geographic location may also be included. If possible keywords should be selected from published thesaurus. e.g. Thesaurus of Engineering and Scientific Terms (TEST) and that thesaurus-identified. If it is not possible to select indexing terms which are Unclassified, the classification of each should be indicated as with the title.)

CC-130

Foliage penetration radar

FOLPEN

Ground penetrating radar

Rapid Mount Airborne Sensor System

RMASS

SAR

Search & Rescue

UNCLASSIFIED

SECURITY CLASSIFICATION OF FORM