

**AFRL-IF-RS-TR-2005-309**  
**Final Technical Report**  
**August 2005**



**GLOBAL INFORMATION ENTERPRISE  
SIMULATION (GIESIM) JOINT TACTICAL  
INFORMATION DISTRIBUTION SYSTEMS  
SIMULATION EXPERIMENTATION**

**Prediction Systems, Incorporated**

*APPROVED FOR PUBLIC RELEASE; DISTRIBUTION UNLIMITED.*

**AIR FORCE RESEARCH LABORATORY  
INFORMATION DIRECTORATE  
ROME RESEARCH SITE  
ROME, NEW YORK**

## STINFO FINAL REPORT

This report has been reviewed by the Air Force Research Laboratory, Information Directorate, Public Affairs Office (IFOIPA) and is releasable to the National Technical Information Service (NTIS). At NTIS it will be releasable to the general public, including foreign nations.

AFRL-IF-RS-TR-2005-309 has been reviewed and is approved for publication

APPROVED: /s/

JON B. VALENTE  
Project Engineer

FOR THE DIRECTOR: /s/

WARREN H. DEBANY, JR., Technical Advisor  
Information Grid Division  
Information Directorate

<b>REPORT DOCUMENTATION PAGE</b>			<i>Form Approved</i> <i>OMB No. 074-0188</i>
Public reporting burden for this collection of information is estimated to average 1 hour per response, including the time for reviewing instructions, searching existing data sources, gathering and maintaining the data needed, and completing and reviewing this collection of information. Send comments regarding this burden estimate or any other aspect of this collection of information, including suggestions for reducing this burden to Washington Headquarters Services, Directorate for Information Operations and Reports, 1215 Jefferson Davis Highway, Suite 1204, Arlington, VA 22202-4302, and to the Office of Management and Budget, Paperwork Reduction Project (0704-0188), Washington, DC 20503			
<b>1. AGENCY USE ONLY (Leave blank)</b>	<b>2. REPORT DATE</b> AUGUST 2005	<b>3. REPORT TYPE AND DATES COVERED</b> Final Feb 05 – Jul 05	
<b>4. TITLE AND SUBTITLE</b> GLOBAL INFORMATION ENTERPRISE SIMULATION (GIESIM) JOINT TACTICAL INFORMATION DISTRIBUTION SYSTEMS SIMULATION EXPERIMENTATION		<b>5. FUNDING NUMBERS</b> C - FA8750-05-C-0069 PE - 62702F PR - 4519 TA - MA WU - 04	
<b>6. AUTHOR(S)</b> John Fikus			
<b>7. PERFORMING ORGANIZATION NAME(S) AND ADDRESS(ES)</b> Prediction Systems, Incorporated 309 Morris Avenue Spring Lake New Jersey 07762		<b>8. PERFORMING ORGANIZATION REPORT NUMBER</b>  N/A	
<b>9. SPONSORING / MONITORING AGENCY NAME(S) AND ADDRESS(ES)</b> Air Force Research Laboratory/IFGA 525 Brooks Road Rome New York 13441-4505		<b>10. SPONSORING / MONITORING AGENCY REPORT NUMBER</b>  AFRL-IF-RS-TR-2005-309	
<b>11. SUPPLEMENTARY NOTES</b>  AFRL Project Engineer: Jon B. Valente/IFGA/(315) 330-1559/ Jon.Valente@rl.af.mil			
<b>12a. DISTRIBUTION / AVAILABILITY STATEMENT</b> APPROVED FOR PUBLIC RELEASE; DISTRIBUTION UNLIMITED.			<b>12b. DISTRIBUTION CODE</b>
<b>13. ABSTRACT (Maximum 200 Words)</b> Controlled, bench-test experimentation was performed by PSI to determine loading capacities and scalability associated with the GIESim JTIDS simulation for handling larger scenario sizes and networks of different complexity. The simulation was modified to provide communications capabilities to JASF. The GIESim JTIDS simulation was "instrumented" to capture and record key internal metrics. An HLA Recorder, Player and Generator was created to stimulate the JTIDS simulation as a surrogate for JSAF and to capture HLA traffic. A driver simulation sent controlled position updates to the simulation under test. Many load factors were measured including HLA overhead, position update rate, size and characteristics of Link-16 networks, network relays, transmission request rates, type and capacity of test PCs, and long term stability. Our overarching conclusion is that the Sim/Real ratio (SRR) is the best indicator of system load on the GIESim JTIDS simulation. Scenarios of 136 Link-16 platforms can easily be supported with position updates of every 10 seconds - typical of what is expected from JSAF. The GIESim JTIDS simulation can be used for experiments of extended duration of many hours. The report includes detailed findings on message latencies, loading, and in-depth analyses of results, and recommendations.			
<b>14. SUBJECT TERMS</b> Modeling and Simulation, Communications, Communications Modeling, Network Modeling, JTIDS, Federates			<b>15. NUMBER OF PAGES</b> 119
			<b>16. PRICE CODE</b>
<b>17. SECURITY CLASSIFICATION OF REPORT</b>  UNCLASSIFIED	<b>18. SECURITY CLASSIFICATION OF THIS PAGE</b>  UNCLASSIFIED	<b>19. SECURITY CLASSIFICATION OF ABSTRACT</b>  UNCLASSIFIED	<b>20. LIMITATION OF ABSTRACT</b>  UL

## Table of Contents

1.0 Background .....	1
2.0 Introduction .....	2
3.0 Design of Experiment .....	4
3.1 Scope of Challenges.....	4
3.1.1 What is Time? .....	5
3.1.2 Latency Variations and Accuracy .....	7
3.1.3 Position Accuracy .....	11
3.2 Factors Affecting JTIDS Loading.....	12
3.2.1 Propagation Calculations and Position Updates .....	13
3.2.2 Size of Operational Nets .....	14
3.2.3 Airborne Relays .....	16
3.2.4 HLA Overhead and “Tick” Time.....	17
3.3 Test Configurations.....	19
3.4 Run Definitions.....	21
3.4.1 Scenarios for Experimentation.....	21
3.4.2 Networks for Experimentation.....	22
3.4.3 Load Runs .....	23
3.5 Metrics .....	27
3.6 Charts .....	29
4.0 JTIDS Enhancements.....	30
4.1 Instrumentation and Monitoring.....	30
4.2 Enhancements to GIESim JTIDS.....	32
5.0 Driver Enhancements.....	34
6.0 HLA Recorder/Player/Generator (HRPG) Tool.....	37
7.0 Experimentation.....	40
8.0 Analysis of Results .....	43
8.1 HLA & System Overhead.....	43
8.2 Review of Main Load Runs .....	45
8.2.1 Review of Charts and Simulation Behavior.....	45
8.2.2 Cross Load Run Analysis .....	48
8.4 Position Update Sensitivity Analysis.....	52
8.5 Cross-PC Run Analysis.....	53
8.6 Long Stability Run.....	54
8.7 Message Loss Analysis.....	54
9.0 Future Work Possibilities.....	55
10.0 Conclusions.....	57
11.0 References.....	59
Appendix A – Test Networks .....	60
Appendix B – Run Data.....	63

## List of Figures

Figure 1 - GIESim JTIDS Simulation Interface to JSAF .....	2
Figure 2 - PSI Link-16 Network Management System .....	3
Figure 3 - Initial Scenario developed for testing and demo with JSAF .....	3
Figure 4 - Load Factors on the GIESim JTIDS Simulation.....	4
Figure 5 - Comparison of Simulation Clock to Real Time during processing .....	6
Figure 6 – Conceptual Effect of Message Request Rate on Simulation Time Slip .....	6
Figure 7 - Transmit Requests vs. Scheduled Receive Times for JTIDS.....	7
Figure 8 - Section of JTIDS Simulation .....	8
Figure 9 - Platform Position Accuracy .....	11
Figure 10 - JTIDS Internal Load Factors.....	12
Figure 11 - Propagation Calculations for Moving Platforms.....	13
Figure 12 - Size of Operational Nets .....	14
Figure 13 - Message Transmission and Mutual Interference.....	15
Figure 14 - JTIDS Relay Operation .....	16
Figure 15 - Complex Relay Operations and Impacts.....	17
Figure 16 - Main Test Configuration for Experimentation.....	19
Figure 17 - Set-up Configuration for Initial Script Building .....	20
Figure 18 - Reference Platforms in the Korona Scenario Derivatives.....	22
Figure 19 - Ideal Cumulative Count Curve for Stepped Transmission Requests. ....	25
Figure 20 – Sample of Full Request Rates.....	26
Figure 21 – Sample of Half Request Rates .....	26
Figure 22 – Sample of Quarter Request Rates.....	26
Figure 23 -Instrumentation and Monitoring of JTIDS for Load Test Experimentation .....	30
Figure 24 - New Monitor Task for Collecting JTIDS data.....	31
Figure 25 - Updated and Enhancement GIESIM_INTERFACES Model in JTIDS.....	33
Figure 26 - New Instrumentation Model added to JTIDS .....	33
Figure 27 - Cumulative Driver Updates: ALL positions every 10 seconds.....	35
Figure 28 - Cumulative Driver Updates: ALL updates distributed over 10 seconds.....	35
Figure 29 - Cumulative Driver Updates: Changed positions every 10 seconds .....	36
Figure 30 - Cumulative Driver Updates: Changed positions distributed over 10 seconds.....	36
Figure 31 -Functionality and Graphics of the HLA Recorder/Player/Generator (HRPG) .....	37
Figure 32 - GSS Architectural Drawing of the Final HLA Recorder/Player/Generator.....	38
Figure 33 - HLA and System Overhead on Message Latency.....	43
Figure 34 – HLA + System Overhead for Ref Net under Minimal Load .....	44
Figure 35 - HLA + System Overhead for Ref Net under Moderate Load .....	44
Figure 36 – Sim/Real Chart Compared with Cumulative MS and MR Counts.....	45
Figure 37 – Ref Net Latency for No Load vs. Full 41 Net Step Load.....	46
Figure 38 - Comparison of Cum MS and MR vs. Cum E and R counts.....	46
Figure 39 - Comparison of TMA charts of MS and MR vs. E and R.....	47
Figure 40 - Comparison of Ref Net Latency Across Load Runs.....	48
Figure 41 – Comparison of Selected Results for 41 Net Step Half-Rate Load .....	50
Figure 42 – Comparison of Selected Results for 41 Step Full Rate Load .....	51
Figure 43 - Sensitivity to Position Update Rate.....	52

Figure 44 - Comparison of Sim/Real Ratio in Cross-PC Experiments..... 53  
 Figure 45 - Relationships of Position Accuracy and Latency versus System Load ..... 57

**List of Tables**

Table 1 - Computers Used in Experimentation..... 20  
 Table 2 - Platform Counts for two Korona Variations ..... 21  
 Table 3 - Net Groups for Experimentation ..... 23  
 Table 4 - Scenario and Net File Pairing..... 23  
 Table 5 - Network Load Rates ..... 24  
 Table 6 - 41 Net Group Stepped Loads ..... 24  
 Table 7 - 81 Net Group Stepped Loads ..... 24  
 Table 8 - Notations and Meaning..... 27  
 Table 9 - Metric Notation for Data Collected by JTIDS Monitor ..... 27  
 Table 10 - Metrics Computed from Monitor Data..... 28  
 Table 11 - Metrics Computed from Recorder LOG Files..... 28  
 Table 12 - Load Runs on Main Test PC ..... 40  
 Table 13 - Position Update Sensitivity Runs ..... 41  
 Table 14 - Cross PC Comparison Load Runs and Long-Term Stability Run..... 42  
 Table 15 - Analysis of 41 Net Group Sources ..... 49  
 Table 16 - Analysis of 81 Net Group Sources ..... 49  
 Table 17 - 41 Net Set Groups ..... 60  
 Table 18 - 81 Net Set Groups - Part 1..... 61  
 Table 19 - 81 Net Set Groups - Part 2..... 62

## 1.0 Background

Most large-scale force level simulations assume perfect communications. This can lead to significant limitations in the results obtained from running these simulations. The vision of GIE is to move, process, manage, and protect the Command and Control Intelligence Surveillance and Reconnaissance (C2ISR) information that supports the functions of Global Awareness and Dynamic Planning and Execution. The mission of GIE is to link aerospace assets in-theater and globally, to integrate C2 & ISR networks, to defend critical information systems from cyber attack, and to develop new information processing and management techniques. This implies the ability to construct large-scale simulation environments for these large force-level simulations that take into account the highly dynamic nature of combat networks that can include reach-back networks, layers of radio links and networks, and a host of communications vehicles including satellites, manned and unmanned air platforms, ground and sea vehicles down to individual soldiers and sensor systems. The GIESim effort plans to fill the gaps in communications modeling, and plans to accomplish its goals by assembling complex, heterogeneous simulations into the appropriate multi-simulation environments required to model the GIE. The General Simulation System (GSS), and the many models and simulations built with it have been chosen as one platform to take part in the development of the GIESim/JSB-RD software merger.

In FY 2004, the GIESim AFRL/IFGC leadership team set the goal of expanding on and drawing upon the expertise and lessons learned in building the DTIG Multi-Simulation Demonstration (DMSD) built for the 2003 SAB Review. In FY04, the GIESim JTIDS Simulation capabilities from PSI were merged into the Joint Semi-Automated Forces (JSAF) simulation in AFRL Rome in conjunction with the JSB-RD team. The central themes for the FY04 GIESim/JSB-RD merger were:

- The addition of communications modeling capabilities to JSAF by interfacing and merging GIESim JTIDS modeling capabilities. JSAF is a JFCOM program that is used extensively for war gaming and large, man-in-the loop exercises. However, JSAF does not include any communications modeling, and simply assumed that communications always worked.
- Faster and Easier design, development and execution of GIESim simulations.
- Tools and Technologies for GIESim.

The focus of the FY05 program was to further develop the GIESim/JSB-RD merger by building a robust demonstration of JSAF-GIESim interoperability, and to explore further experimentation with respect to scalability associated with handling larger scenario sizes. This report covers the experimentation performed by PSI on the GIESim JTIDS simulation under controlled loads.

## 2.0 Introduction

This report covers the experimentation that was performed by PSI to determine loading capacities and scalability associated with the GIESim JTIDS simulation for handling larger scenario sizes and networks of different complexity. Figure 1 illustrates the operation of the GIESim JTIDS simulation with JSAF. JSAF provides platform position updates to JTIDS, and makes transmission requests for specific platforms. If the transmission is successful, then JTIDS provides a response to JSAF that indicates the receiving platform and JSAF message ID. Both systems use the same force composition of Link-16 platforms, and the JTIDS simulation uses a network design that was developed for the operations within JSAF. Details on the overall system are provided in references [1][2].



Figure 1 - GIESim JTIDS Simulation Interface to JSAF

The GIESim JTIDS Simulation was derived from a variation of the PSI Link-16 Network Management System (NMS) as shown in Figure 2. The Link-16/JTIDS Planning Tool is used to capture and refine network requirements for the dynamic operations planned for the force composition in the Scenario. The Planning Tool can also be used to create scenarios that consist of Link-16 platforms and motion paths. The Planning Tool can test both RF JTIDS connectivity and Link-16 *network* connectivity while designing the scenarios and networks. The Link-16 NMS was used to design the initial interoperability test and demo scenario used with JSAF. This scenario, which was dubbed the “Wow” scenario, is shown in Figure 3. The goal of experimentation was to explore larger scenarios and more complex networks to determine the performance “envelop” of the JTIDS simulation.

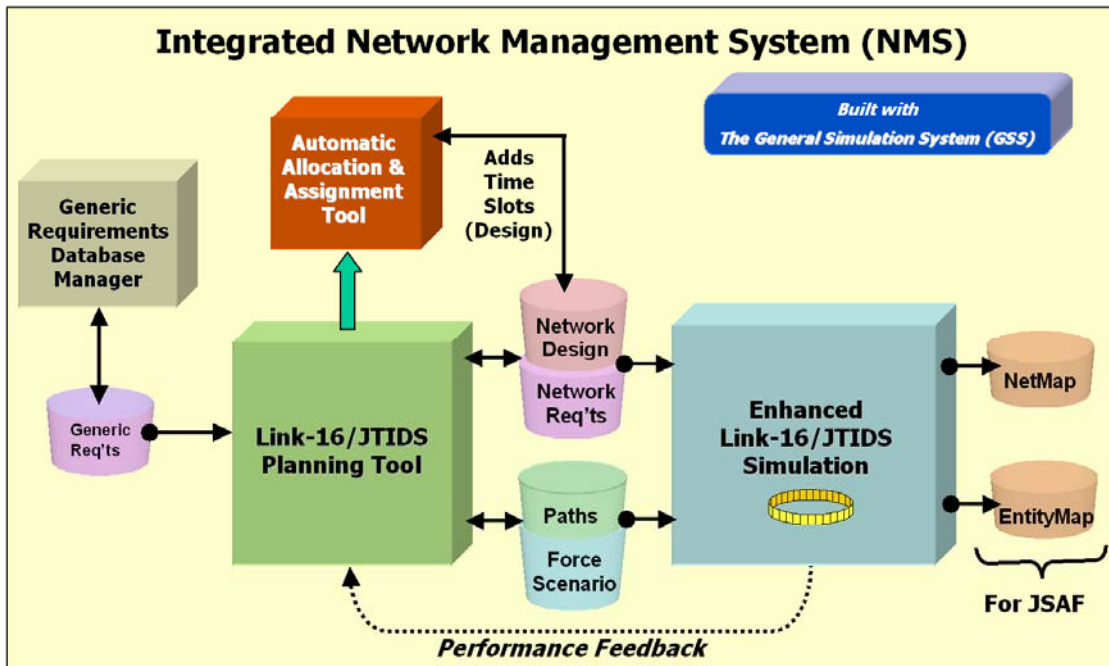


Figure 2 - PSI Link-16 Network Management System

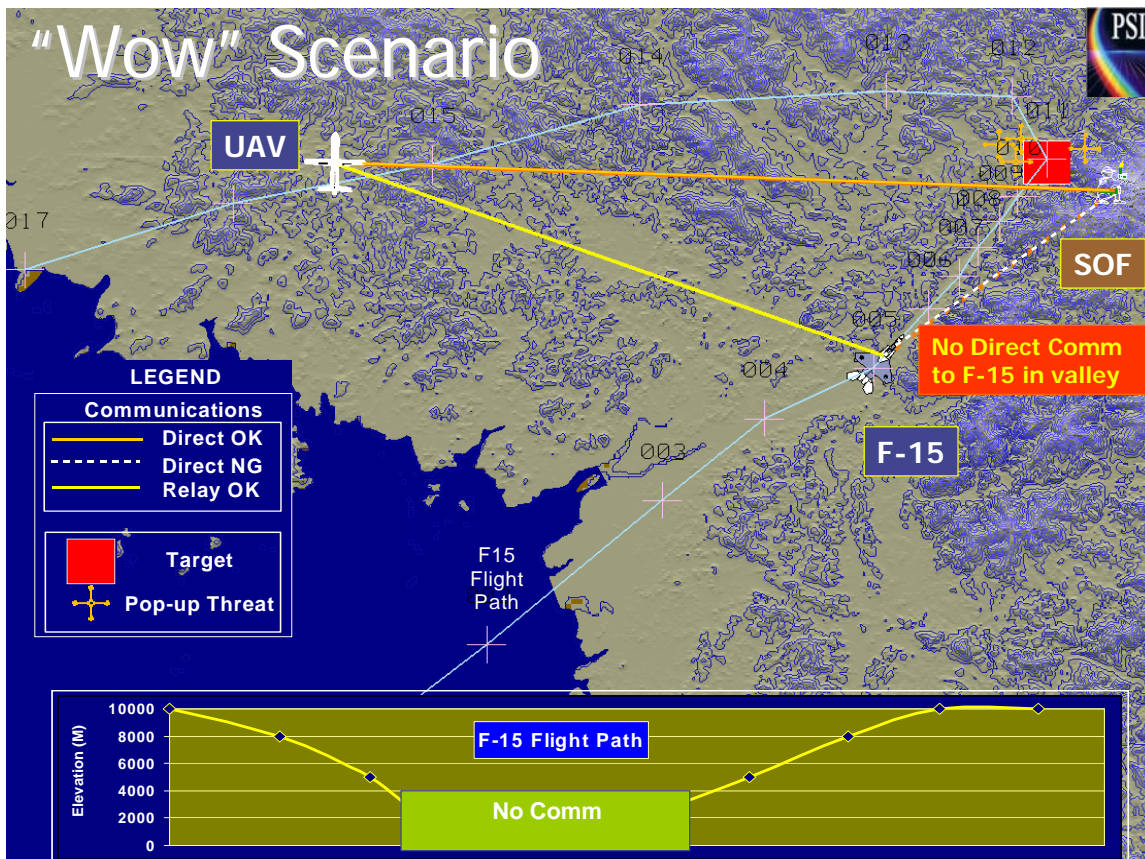


Figure 3 - Initial Scenario developed for testing and demo with JSAF

### 3.0 Design of Experiment

This section of the report covers the overall design of experiment for load testing the GIESim JTIDS simulation, and reviews the considerations, challenges, tools and ultimately the details of the experiments that were designed and executed.

#### 3.1 Scope of Challenges

Experimentation turned out to be a much more complex and challenging undertaking than expected. To a large extent, this was due to the high number of experimental variables and the potentially large test space that could be explored. Furthermore, after some initial considerations and experimental runs, the concept of “load testing” became much more profound and deeper than originally anticipated. To some extent this was due to the fact that platform position updates and transmission requests were arriving in “real time”, while the simulation was trying to maintain real time processing. This is described in more detail shortly. Also, we identified the need to “correlate” external driving factors with the size and complexity of the scenario and network design and internally obtained metrics that provide an assessment of simulation load.

Figure 4 illustrates most of the load factors on the JTIDS simulation. Platform position updates arrive with a certain rate, and updates may be distributed over time or come as a group. Furthermore, updates may only come for platforms with changed positions, or for all platforms.

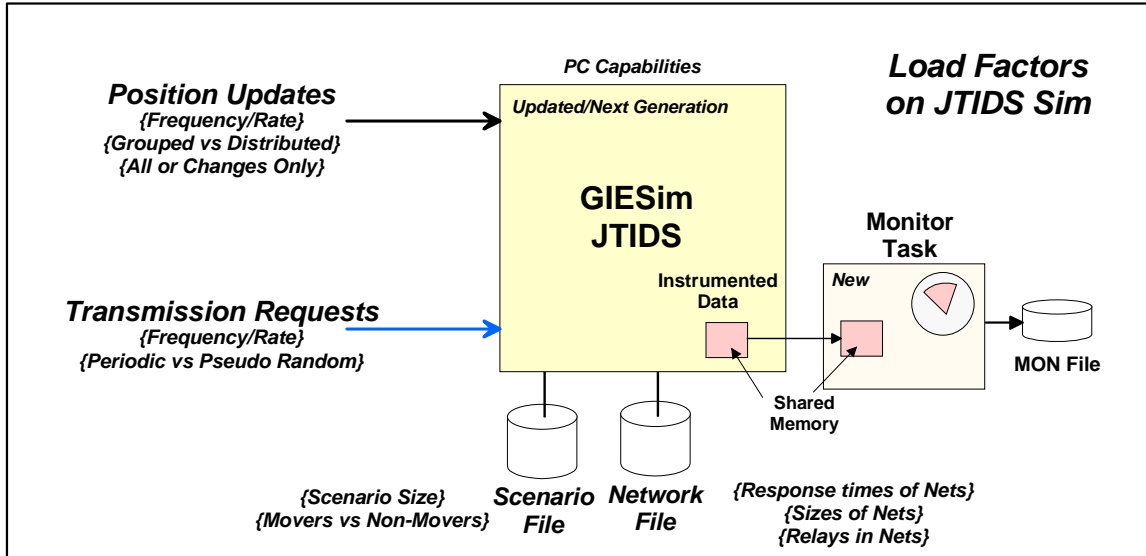


Figure 4 - Load Factors on the GIESim JTIDS Simulation

Load on the system depends on the frequency of transmission requests, and on the size and types of the operational nets being requested. Furthermore, higher loads are incurred for transmissions through networks with platforms that move more rapidly, since platform motion causes more frequent, and costly, propagation calculations. Also the number of destinations and relays in each operational net also influences loading. Generally nets with larger numbers of destinations introduce higher loads. Relays in particular can dramatically impact performance.

We determined that we needed to “instrument” the JTIDS simulation to extract internal measures of performance that could be correlated to the external driving factors. These internal measures, combined with the driving factors, would allow us to characterize the “load” on the system. Also, a controlled means of sending different volumes of position updates and transmission requests was required to obtain repeatable data. Reception responses from JTIDS also had to be captured for later analysis and archiving.

We also considered the potential impact of HLA overhead on “real time” performance. We also wanted to compare performance on computers with different capabilities to assess sensitivity to PC parameters.

The subsections that follow provide deeper descriptions of some of the challenges that were considered and how we addressed them.

### **3.1.1 What is Time?**

The title of this section may seem frivolous, however the question of what time is when applied to a simulation environment is very important to consider and highly relevant to this application of JTIDS with JSAF. JSAF and JTIDS are planned to run in “real time”, which means that both simulation JSAF and JTIDS clocks are “constrained” to the system clock that each is running on. This implies that ideally one second on each system will be the same as one second on the wall clock.

What this means is that each simulation will attempt to schedule events as they should occur according to the real-time (wall) clock. However, in any simulation, a certain amount of time slip will occur between the simulation clock and the real time system clock. For instance, suppose that two events are scheduled at the same time. The first event will take a finite amount of time to process. This implies that the second event will get processed later than scheduled, which is a time slip. Figure 5 illustrates this. When (in this case) GSS looks at a scheduled process, if the current real-time is later than the scheduled event time, e.g., a time slip has occurred, then the process is run immediately as shown for P3 in Figure 5. On the other hand, if the scheduled event time is a “future time”, then the simulation time will catch up to real time as shown for P4. If the average time interval between events, e.g., the event rate, is shorter than the time required to process events then the simulation clock will, on average, be synchronized with the real time system clock.

A comparison measure of the simulation time to real time is the Sim/Real ratio. Figure 6 illustrates how increasing message transmission request rates can impact time slip of the simulation clock, and lower the Sim/Real ratio. At some point, the Sim/Real ratio becomes too low. The question is then: “What is too low?” The experiments performed under this task were aimed at answering this question, and to determine a rough “performance envelop” for JTIDS. From the internal perspective of the simulation receiving requests in real time, as the simulation

clock slows down, the “apparent” rate of requests measured against the simulation clock increases. This implies that requests pile up within the simulation and can cause the simulation clock to stay behind for a longer duration.

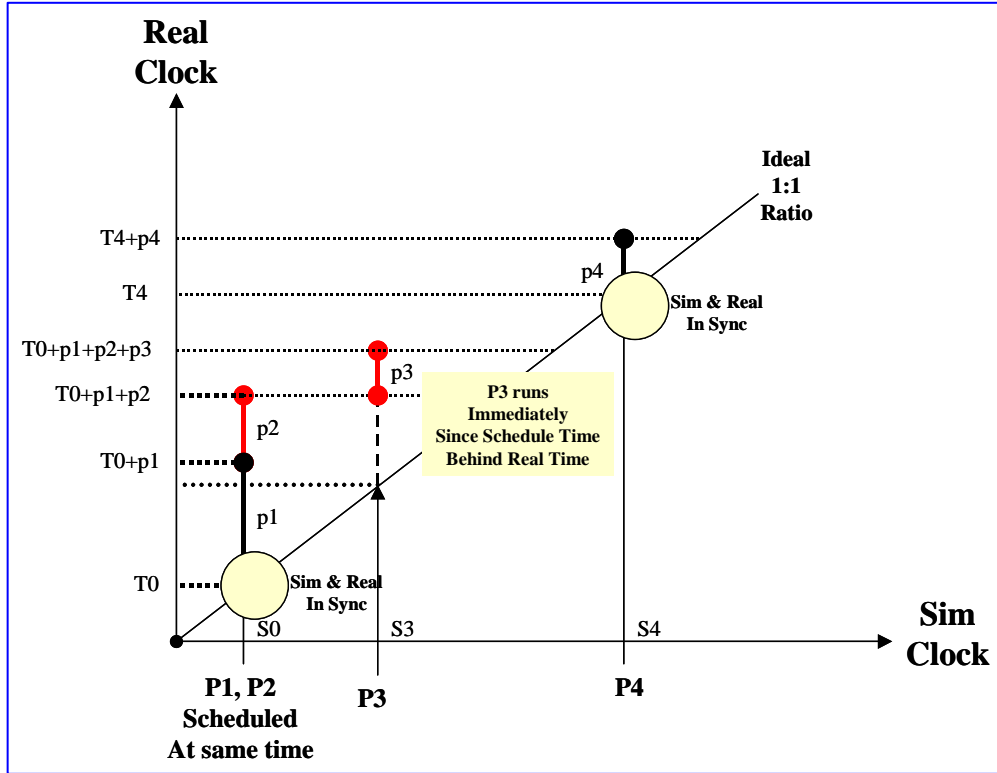


Figure 5 - Comparison of Simulation Clock to Real Time during processing

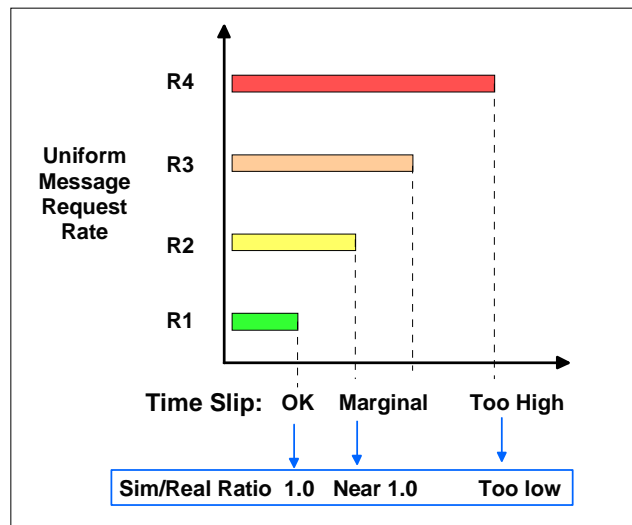


Figure 6 – Conceptual Effect of Message Request Rate on Simulation Time Slip

### 3.1.2 Latency Variations and Accuracy

Each Link-16 Operational Net has a specific response time that is defined at design time. Therefore on average, responses to transmission requests should ideally have latencies that do not exceed the response time of each network. The key term is “on average”. The response time of a net is determined by how many time slots are assigned to it for transmission. Figure 7 shows the 1536 time slots in JTIDS that repeat every 12 seconds. This repetition rate is referred to as the Repetition Rate Number (RRN). A message that is queued for transmission can be transmitted whenever its assigned time slot comes around. Figure 7 depicts two different cases for transmission requests. Transmit Request A comes in a few time slots before its next allocated time slot (red), and therefore the message will have a short latency. Transmit Request B, however, arrives many time slots before it can transmit (green), which means that its message latency will be much longer. When messages arrive “just” before the assigned time slot, they will have near-zero latency, whereas messages that arrive just after the assigned time slot will incur the worst-case latency.

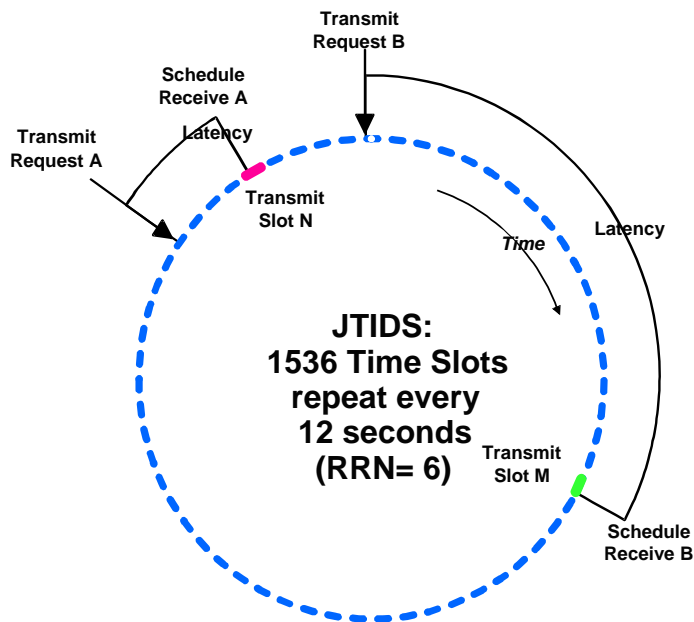


Figure 7 - Transmit Requests vs. Scheduled Receive Times for JTIDS

The time-slot nature of JTIDS communications can introduce broad variations in the response time of transmission. Nets with very high response times, or high throughputs, can be allocated many time slots so that transmit opportunities occur frequently.

In the JTIDS simulation, latency is computed from the time the message request comes in to the time that the message is received within the simulation. Because of the desire to run in real-time, latency is now computed in terms of wall clock (system) time. As the simulation becomes more and more loaded, the accuracy of the computed latency will drop.

### 3.1.2.1 Transmission Requests, Bus Delays, and Scheduling

In Link-16 radios, other factors affect latency. The bus between the Link-16 Host and the Link-16 terminal can introduce additional delays. In the JTIDS simulation, a normal distribution is used to randomly introduce 50 to 150 ms of delay. Based on our analysis, bus delays make negligible contributions to message latency.

The point at which the HOST\_OUTBOUND\_QUEUE model schedules the bus delay is the first schedule statement that occurs following a transmission request. The significance of this will become clear shortly. See Figure 8 for reference.

In the JTIDS simulation HLA events including transmission requests are accumulated in near real time. Once the transmission request has been scheduled the simulation clock determines when the request is actually honored.

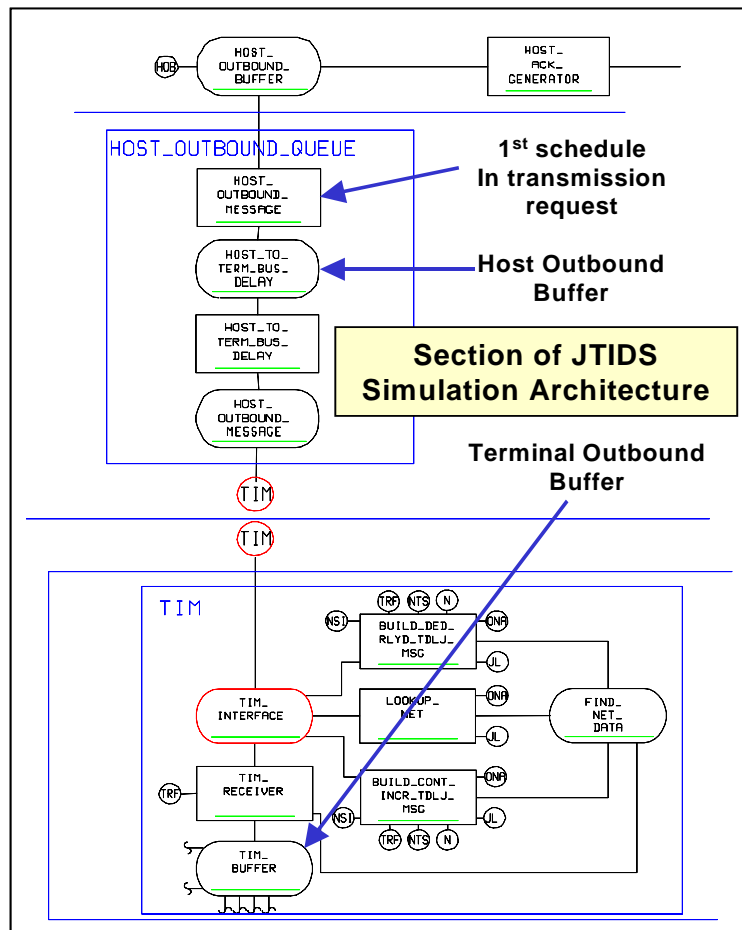


Figure 8 - Section of JTIDS Simulation

When the simulation is lightly loaded, i.e. the Sim/Real ratio is very close to 1.0, the transmissions will occur in the desired (wall clock) time. However, as the simulation gets more and more loaded, then the simulation queue size will increase and the transmission requests may get queued up behind many other events that are running late relative to wall time. The consequence is that transmission latency through the system will be longer than expected.

### 3.1.2.2 Transmission Requests and Net Overdrive

In the JTIDS simulation each net has a transmit buffer in the JTIDS Processor Model that can hold messages for transmission. Since any net can only send messages at a certain rate, the buffer is intended to temporarily hold messages.

If transmission requests arrive at a *steady* rate that is faster than the net can handle, then eventually the input buffer will overflow and excess requests will be lost. This can happen even if the system is lightly loaded, and is a case of over driving the net.

Another consequence of the transmit buffers is that short bursts of transmission requests on one net may become deeply buffered. As a result, the “latency” of the last request loaded into the transmit buffer will be much longer than the first request in the buffer since all proceeding messages in the buffer must be sent before the final message is transmitted.

Since brief bursts of requests are “stored” in the transmit buffer and are metered out at the rate supported by the net, the apparent load on the system will not increase appreciably since messages leave the buffer at a fixed rate. However, as noted earlier, the *latency* of the message in the buffer will suffer.

As the simulation becomes loaded, then the real time to handle messages starts to drop. Individual transmissions will take longer by a factor that is inversely proportional to the Sim/Real ratio. Latency of buffered transmit messages will therefore take substantially longer.

Generally, the rate of transmission requests on any net should be less than the capacity of the net. The net capacity is determined by either the specified response time or the throughput required for the net – whichever is higher. In cases where there are insufficient time slots to satisfy the required capacity, the actual capacity allocated will be less. This can be determined by reviewing the time slots allocated to the net with the Link-16 Planning Tool.

### 3.1.3 Position Accuracy

As a result of frequent HLA event checking, platform position updates are handled in near real time. The new positions of platforms are updated in the platform database and the platform icons are updated on the graphics display as they occur. However, message transmission requests may not be handled in real time depending on the load on the JTIDS system at the time. This is a generic problem for simulations.

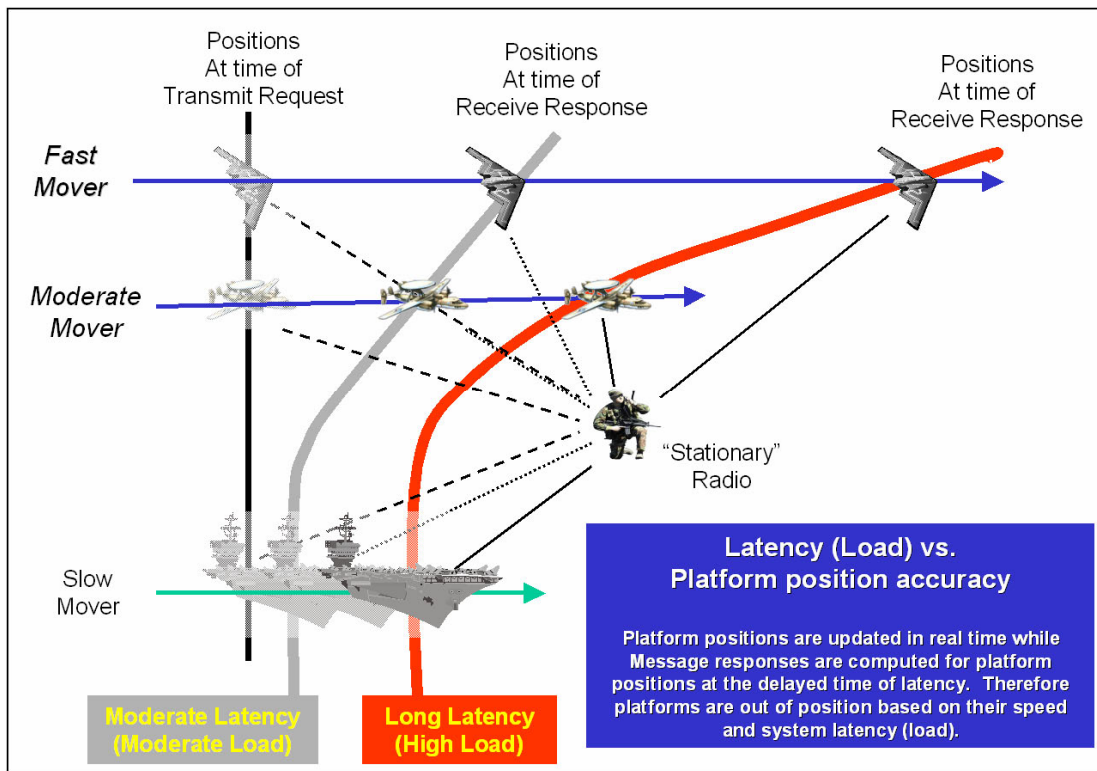


Figure 9 - Platform Position Accuracy

With higher system loads, transmission requests can become queued in internal buffers including the simulation queue. Transmission requests are associated with the platform positions at the time of the request, and the impacts of system delays in transmissions vary in terms of platform speed. This situation is illustrated in Figure 9. Fast moving platforms will be out of position much quicker than slow moving or stationary platforms at the time the message transmission actually takes place after experiencing system delays. Therefore, the physical platform positions at the time of message transmissions can lead to inaccurate results. For instance, at the time of a transmission request on a particular net, platforms in the net may be clear of terrain obstructions. However, at the time the message goes through, the terrain might block RF propagation and give a false answer. All of this of course assumes that the extended latency incurred by system delays is in itself acceptable.

The root of the overall problem is time; real time compared to simulation time. This implies that during driven operations of JTIDS that the state of the Sim/Real ratio is monitored throughout the load runs. Our experimentation analysis places reasonable limits on JTIDS loading.

### 3.2 Factors Affecting JTIDS Loading

The overarching goal of experimentation is to determine the operational performance envelop for JTIDS under varying load conditions and sensitivity to scaling of scenario sizes and networks. While contemplating our experiments and during analysis of data we explored different factors that could influence loading of the JTIDS simulation. Some loading factors have already been discussed. This section presents additional loading factors and provides some detailed insights into each that must be considered when planning operational runs with JSAF or other large forces simulations that might drive JTIDS and employ it to provide network connectivity.

Figure 10 depicts some of the load factors that can affect loading of GIESim JTIDS. The left side of Figure 10 involves both interface overhead and computational overhead associated with transmission processing. The right side of Figure 10 shows the scenario and networks that can be loaded into JTIDS. The magnitude of the computations required to support transmission requests can be directly affected by the scenario size and complexity and size of the Link-16 networks that are loaded.

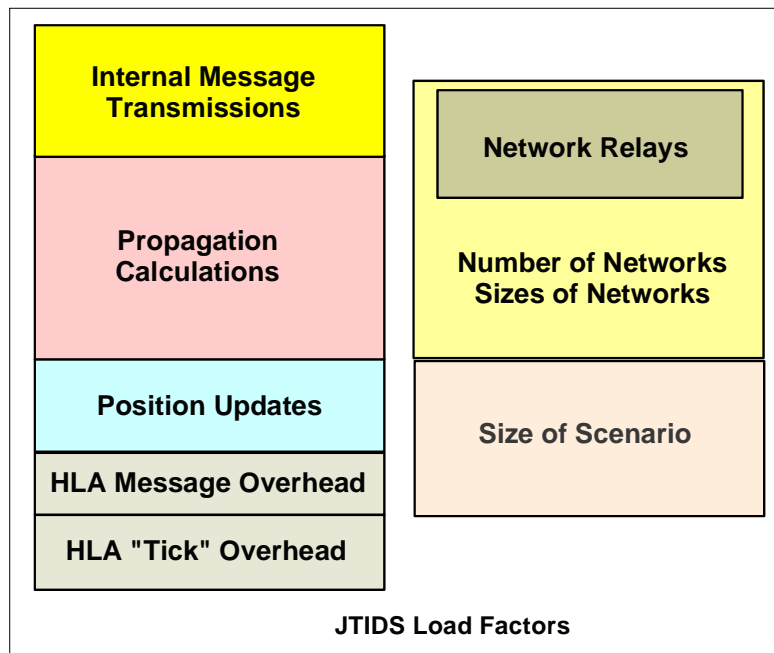


Figure 10 - JTIDS Internal Load Factors

Sections 3.2.1 through 3.2.4 provide a brief overview of some of these factors and their relationships.

### 3.2.1 Propagation Calculations and Position Updates

Propagation calculations are amongst the heaviest computational loads in the JTIDS simulation even with the PSI Fast Propagation Prediction System (FPPS). JTIDS keeps track of platform position locations and avoids the costly propagation calculation for links between pairs of platforms that have not changed position since the last calculation. Since position updates can change platform positions between transmission requests, updates can cause additional calls to FPPS. Consider the two cases illustrated in Figure below. Both cases assume that T1 is just after a transmission has been handled.

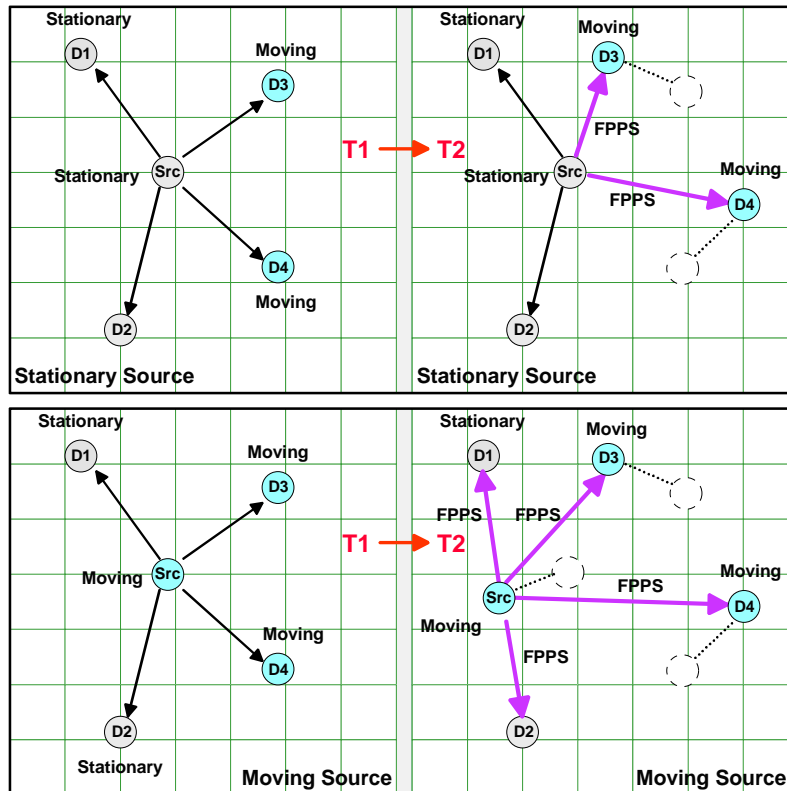


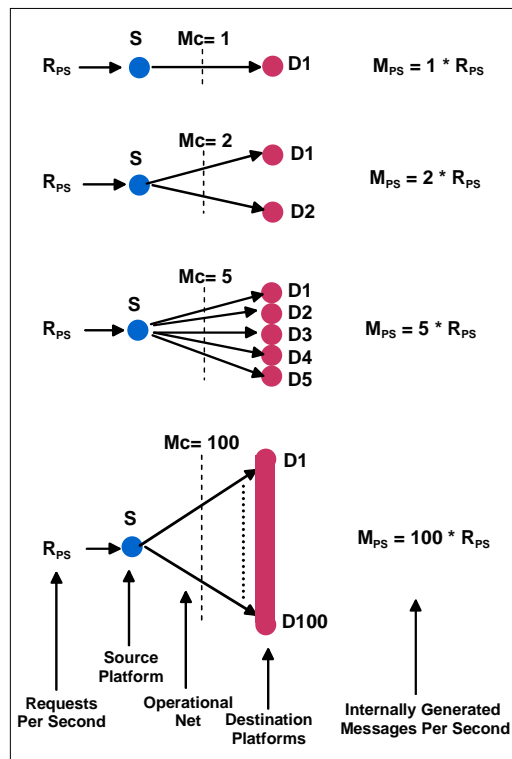
Figure 11 - Propagation Calculations for Moving Platforms

In the top case, platforms D1 and D2 are stationary, the source platform (Src) is also stationary, and D3 and D4 are moving. When a transmission request comes in at T2, new FPPS calculations are required between the Src and D3 and D4 but not with respect to D1 or D2.

In the lower case, the source platform is moving in addition to D3 and D4. Now when a transmission request comes in at T2, FPPS calculations are required for *all* links. Fast moving platforms will change positions more frequently with position updates than slow moving platforms. Airborne transmitters will typically introduce a higher propagation load than other platforms.

### 3.2.2 Size of Operational Nets

The size of operational nets can directly influence computational load. Figure illustrates several operational nets of increasing size. When a transmission is requested from the source of an operational net, the JTIDS simulation builds a message for transmission through the simulation. The message that is built contains a list of destinations, network characteristics, and other data including the payload required for JSAF. The completed message is then moved to the buffer of each destination receiver and each destination is scheduled to receive the message at the next time slot available to the net. Message movement and scheduling take a finite amount of time. Larger nets therefore require more time for this step in the transmission process to complete.



Internal JTIDS Message Traffic for Different Sized Nets

Figure 12 - Size of Operational Nets

With JTIDS radios, many radios can be transmitting at once on the same time slot. This can be due to the use of different J-Nets (frequency hopping patterns), or use of Contention Access or be due to net designs in which transmitters are expected to be far enough apart. Figure 13 illustrates the case where two transmitters are transmitting in the same time slot.

Assume that the JTIDS Host Model gets back-to-back transmission requests with T2 following T1. T1 moves its transmitted message to time slot buffer N and then schedules destinations D1 and D2 to be received at time T. T2 then moves the transmit message onto the buffer for time slot N.

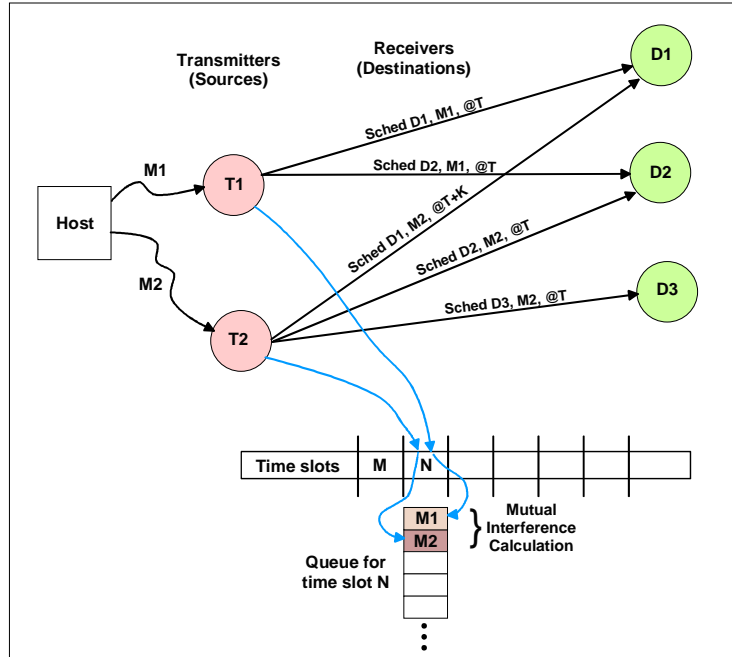


Figure 13 - Message Transmission and Mutual Interference

At the scheduled time, first D1 and then D2 check to see what message they should be receiving from time slot N. Each in turn, does a mutual interference calculation to determine if the SNR is sufficient for it to receive. This involves checking distance to the transmitters and propagation calculations to determine which transmitter has the stronger signal. If T1 has the stronger signal and the SNR is sufficient then the message M1 is received, otherwise it is dropped. After this, D2 then performs a similar calculation. When a message is received, then it is passed to the Host model, which determines if the JSAF message was intended for this particular receiver. If so, then an HLA response message is created that includes message latency through JTIDS and the message is send out over HLA.

Next D1, D2 and D3 repeat this sequence of calculations to determine if message M2 transmitted from T2 can be received and how it should be handled when received.

Obviously nets with larger numbers of destinations will incur higher processing overhead. As discussed in an earlier section, relative motion between platforms in a net can dramatically increase processing time due to higher number of propagation calculations that are required.

Internal to the JTIDS simulation a value called “Expected” is incremented each time a transmission occurs by the number of destinations in the net being used. Expected is therefore an internal measure of loading on JTIDS.

### 3.2.3 Airborne Relays

Many operational nets, particularly larger nets, require relays to ensure that all destinations can be reached. Frequently airborne relays are the first choice, particularly to reach ground positions, because of their altitudes. The use of relays complicates loading and makes load assessment of nets inherently less predictable.

Figure illustrates operation with a single relay R1. The source platform transmits message m1 that is received at destinations D1 and D2 and by R1. However, destination D3 is too far from the source to receive the message. In the next set of adjacent time slots, R1 will transmit message m1. Assuming that D3 is in range, D3 will receive message m1. Note that the figure shows the source and D1 and D2 dropping message m1 from the relay. This is because each receiver keeps a list of message IDs that have already been received. FPPS calculations are performed to determine if each receiver has an SNR value for it to receive.

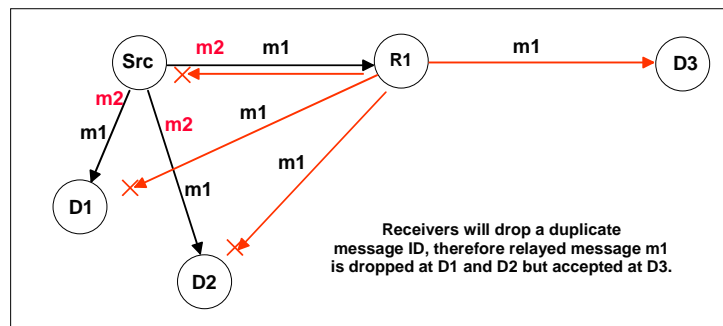


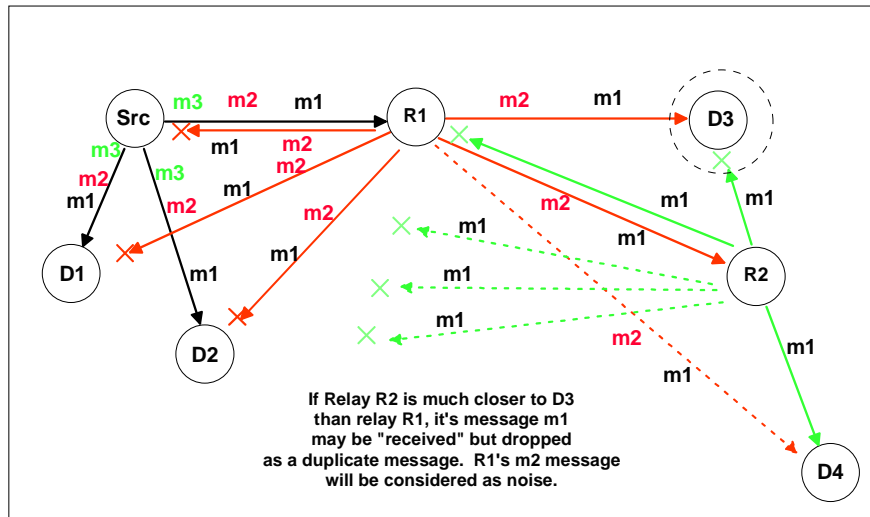
Figure 14 - JTIDS Relay Operation

Multiple relays in a net make the situation more complicated from the perspective of loading and with respect to understanding what happens at any point in time. Figure 14 illustrates the case for an operational net with two relays. The configuration assumes that destinations D3 and D4 and relay R2 are too far from the source to hear it directly. The different colored links are intended to represent the sequence in time of transmissions. Black represents the initial transmission from the source. Red lines indicate the transmissions from the first relay – R1. Green lines indicate transmissions from relay R2.

First Src transmits message m1 to the destinations on the net. Here we assume that D1, D2 and R1 receive the message. R1 then retransmits the message to all destinations on the net. The source, D1 and D2 drop the message because it has a repeated ID. In Figure 14, we assume that D3 and relay R2 are in range of R1 and that destination D4 is not. In JTIDS radios, sources send on their time slots and relays are assigned an equivalent set of time slots that immediately follow the source time slots. Therefore, the first hop relay transmits in the time slots following the transmission of m1 from the source. Relay R2 transmits the message received on the time slots following transmission from R1; at the same time the source can transmit the next message m2.

In the simulation, destination D3 will be scheduled to receive m1 relayed from R2, and m2 from R1. In the figure we assume that R2 is closer to D3 than R1. Therefore the signal from R2 is stronger than that from R1, so that D3 considers the signal from R2 as the valid signal and the

message from R1 as “noise”. Because m1 has already been received from R1, D3 will drop the message from R2. *This is an example where a single and double relay hop to a single destination, D3 in this case, can result in the loss of a valid message.*



**Figure 15 - Complex Relay Operations and Impacts**

Relays (multiple relays in particular) therefore complicate simulation loading in several ways:

- Relays cause additional FPPS calculations and less predictable message transmissions.
- Multiple relay hops to a destination can cause loss of messages.
- Relays will not retransmit messages they have already transmitted; therefore it is less predictable to determine the number of relay transmissions to expect for a given net.
- Because many relays are likely to be fast moving airborne platforms, they will invoke a higher number of FPPS calculations than ground-based relays.

JTIDS increments a “Relay” counter each time that a relay schedules a destination to receive. This value is used as a metric for measuring additional load due to relays.

### 3.2.4 HLA Overhead and “Tick” Time

GSS receives HLA events via the HLA “tick” routine. The amount of time spent in the HLA tick routine is specified with a minimum and maximum limit. The minimum tick time is incurred whenever GSS inspects the HLA buffer even if no HLA interactions have arrived. If interactions have arrived, then GSS will pull as many as possible off the HLA buffer within the maximum tick interval. Once an HLA interaction has been received by GSS, it is automatically processed a user specified HLA event handler.

ENTITY\_STATE messages result in updates to platform locations in the platform database, and movement of platform icons on the display. MSG\_SEND interactions start a sequence of tasks leading up to a potential message transmission. First the Entity ID of the source and destination platforms is looked up and, if found, a search is done to find a Net of the appropriate type. Once

a net is found then its Access Mode is determined and a JTIDS internal message is constructed for transmission through the simulation. This message includes the payload required for the JSAF message, e.g., destination ID, JSAF message number and size.

Early experiments indicated that the minimum HLA tick time was eating a large portion of available real time. This resulted in a reduction of the minimum HLA tick time that is detailed in a later section. Also, experimentation has shown that HLA message handling, once received within GSS, does not introduce a substantial load on the JTIDS simulation compared to other factors such as message transmission. This is described in more detail in a later section.

### 3.3 Test Configurations

Figure 16 shows the main test configuration that was used for experimentation. The GIESim JTIDS under test ran on a PC with no other applications loaded and generated a Monitor file of data collected during each run. A specific NET file was loaded based on the type of test being run. For the majority of the tests, a single Dell Desktop PC was used as the Driven system. The JTIDS Driver of position updates (HLA GIESIM\_ENTITY\_STATE interactions) also ran on a separate PC. The same scenario file was loaded into both systems for each load run. A third PC ran three applications, an HLA Player, an HLA Generator, and an HLA Recorder. The HLA Player and HLA Generator created the Link-16 transmission requests (HLA GIESIM\_MSG\_SEND interactions). The HLA Recorder logged all HLA traffic during a load run.

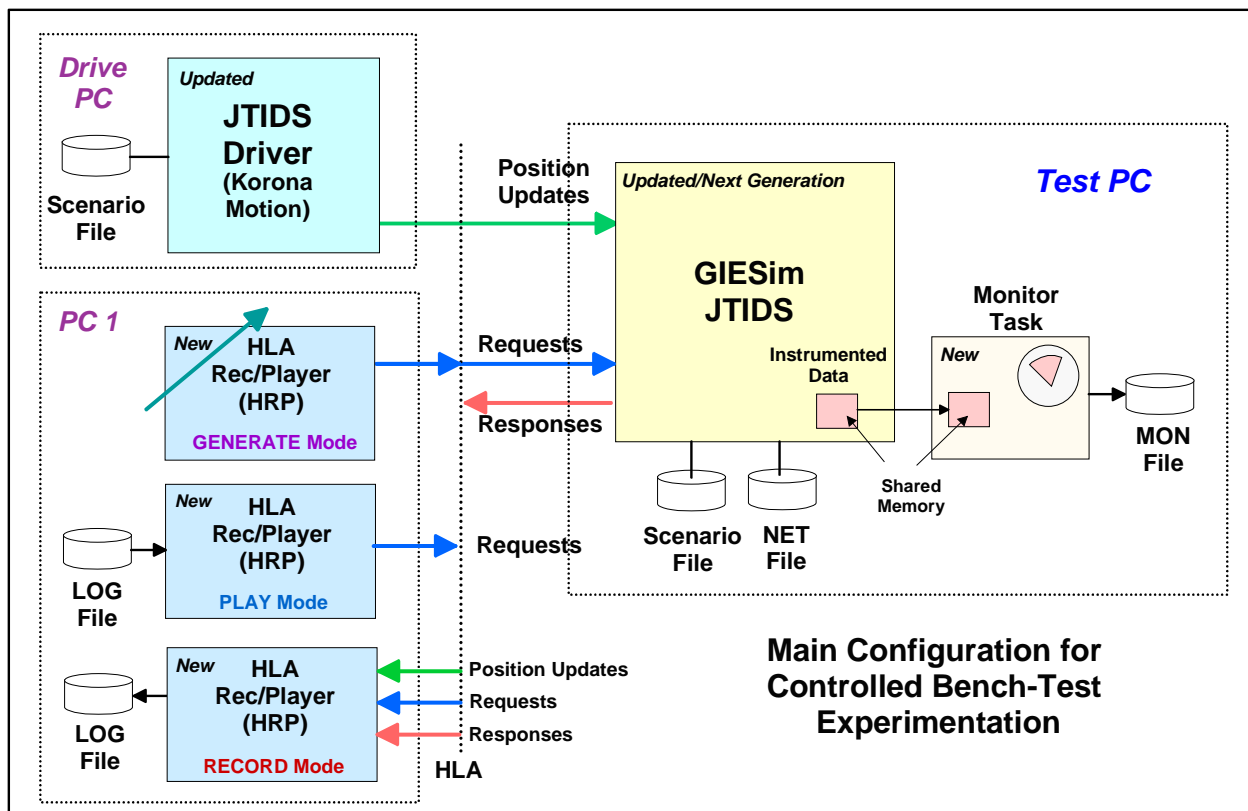


Figure 16 - Main Test Configuration for Experimentation

Figure 17 shows a different configuration of PCs and applications that were used to record test loads for later playback in the main test configuration. Up to four HLA message generators were run across two PCs to create various test loads. This approach simplified load generation, since once the load was recorded it could be played back easily and consistently.

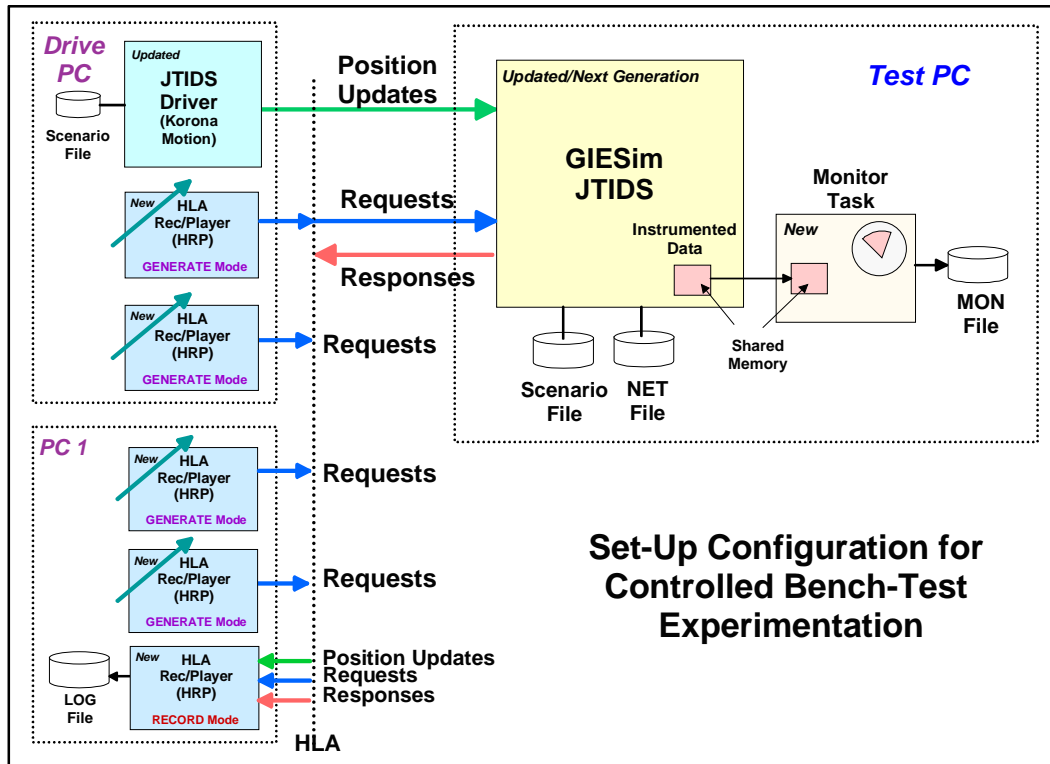


Figure 17 - Set-up Configuration for Initial Script Building

Details on PCs used in each run are provided in Table 1 below. As mentioned earlier, the Main Test PC was used for the majority of the tests. The Dell Laptop (Alt Test 1) was used to test load on a very weak machine, and the Custom Desktop PC (Alt Test 2) was used to measure performance of a machine with more memory than Main Test and that was slightly faster. The Custom Desktop also had a very fast, high-end graphics card, and two runs were done with GIESim JTIDS running in hardware graphics mode.

Table 1 - Computers Used in Experimentation

Purpose	PC Type	Processor	OS	RAM	Video
Main Test	Dell Desktop	P4 2.8 GHz	Win XP SP2	1 GB	Integrated
Rec/Gen Alt Test 1	Dell Laptop	P3 850 MHz	Win 2K SP4	256 MB	ATI Mobility M4 32 MB card
Drive PC	Compaq Laptop	P4 2.8 GHz	Win XP SP1	896 MB	ATI Mobility Radeon 9000 128 MB
Alt Test 2	Custom Desktop	P4 3.0 GHz	Win 2K SP4	2 GB	ATI Radeon 9800 Pro 256 MB DDR

### 3.4 Run Definitions

This section provides an overview of the scenarios, networks and load runs that were designed and executed for experimentation with JTIDS.

#### 3.4.1 Scenarios for Experimentation

All operational scenarios that were used in JTIDS experimentation are based on derivatives of the PSI Korona Scenario that is described in reference [3]. Two variations of Korona were developed. The first variation, KORONA\_DEMO\_REF.SCN, is the same as the basic Korona scenario with the addition of two Global Hawk UAVs that were used for reference. The second variation of Korona, KORONA\_HALF\_REF.SCN, contains roughly half the platforms from the basic scenario in addition to the two reference UAVs. Table 2 summarizes the platform force composition in both test scenarios.

**Table 2 - Platform Counts for two Korona Variations**

KORONA DEMO_REF		KORONA_HALF_REF			
Air Platforms	AB IFC Sensor	2	2		
	ABL	4	2		
	KC 135	5	5		
	Air Cav Helo	2	2		
	E2C	6	6		
	E3	4	3		
	EP3	1	1		
	F15F	24	0		
	F18	24	0		
	JLENS	3	0		
	JSTARS	2	1		
	Rivet Joint	2	2		
	Global Hawk UAV	12	8		
	Global Hawk Src/Dest Refs	2	2		
<b>Total Air</b>	<b>93</b>	<b>34</b>			
Sea	Carriers	2	2		
	Cruisers	15	6		
	Submarine	1	1		
	<b>Total Sea</b>	<b>18</b>	<b>9</b>		
Ground	CAC2S	6	3		
	CRC	2	2		
	JTAGS	4	3		
	Patriot ICC	4	2		
	SHORAD	2	2		
	TOAM	2	2		
	THAAD TOC	4	2		
	UAV Grnd Station	1	1		
	<b>Total Ground</b>	<b>25</b>	<b>17</b>		
	Moving	108	Moving	43	
	Stationary	27	Stationary	17	
<b>Total Link-16 Platforms</b>		<b>136</b>	<b>Total Link-16 Platforms</b>		<b>60</b>

Figure 88 shows the location and relative positions of the two reference platforms. These platforms were added to support a Reference Net for load and latency analyses during experimentation runs. The full complement of platforms was driven with position updates during load testing using each scenario. The next section covers the Reference Net and other networks that were used in experimentation.



Figure 18 - Reference Platforms in the Korona Scenario Derivatives

### 3.4.2 Networks for Experimentation

PSI designed a set of operational nets for the Korona scenario. These networks were designed based on high-level suggestions described by MITRE. The Korona Networks were highly complex and contained a very high number (12+) of relays for most nets. For reasons explained earlier, large numbers of relays in nets introduce extra complexity. For this reason, and to simply experimentation and to make it more controllable, several sets of operational nets were designed based on the Korona Net design with either no relays or a single relay each.

We started the net design process by stripping out all relays from the Korona network. Two main net groups were then defined as shown in Table 3. Nets in the 41 Net Group contain all the destinations from the original Korona scenario. We used the Link-16 Planning Tool to find suitable relays for the 20 nets with one relay. Relays were chosen for best position with respect to the network source platforms. Nets in the 81 Net Group were based on the KORONA\_HALF\_REF.SCN scenario and were developed by loading this scenario into the Planning Tool and then loading the Korona network that had been stripped of all relays. The Planning Tool automatically dropped missing destinations from nets and dropped nets with missing source platforms. The resulting network was stored and the Planning Tool was used to add in suitable relays for the nets that we wanted to have a relay.

**Table 3 - Net Groups for Experimentation**

Net Groups	Nets with No Relay	Nets with One Relay
41 Net Group KORONA_REF_RELAY.NET 80-94 Destinations	1 Ref Net 2 Groups of 10: <ul style="list-style-type: none"> <li>▪ 10 PPLI_B</li> <li>▪ 10 Mission Management</li> </ul>	2 Groups of 10: <ul style="list-style-type: none"> <li>▪ 10 PPLI_B</li> <li>▪ 10 Mission Management</li> </ul>
81 Net Group KORONA_HALF_REF.NET 48-56 Destinations	1 Ref Net 2 Groups of 20: <ul style="list-style-type: none"> <li>▪ 20 PPLI_B</li> <li>▪ 20 Mission Management</li> </ul>	2 Groups of 20: <ul style="list-style-type: none"> <li>▪ 20 PPLI_B</li> <li>▪ 20 Mission Management</li> </ul>

Appendix A provides details on these Net Groups. The idea behind these Net groups was to allow us to create different mixes of loads. The 41 Net group and 81 Net group are mutually exclusive and are always used in separate runs and are paired with their respective scenario as shown in Table 4.

**Table 4 - Scenario and Net File Pairing**

Scenario	Net File
KORONA_DEMO_REF.SCN	KORONA_REF_RELAY.NET
KORONA_HALF_REF.SCN	KORONA_HALF_REF.NET

### 3.4.3 Load Runs

The load runs were to some extent arrived at empirically through early experimentation that was required to size the scope of final experimentation and loads. Many early runs were done to shake out the tools and to determine bounds for driving the simulation. Many refinements and enhancements to JTIDS and the associated tools were identified and tested in this early phase. Once we had collected some preliminary data, we established and followed a plan for experimentation.

The runs fell into the following categories:

- **Load runs:** Used a single target PC that involved stepped loads on different size nets and scenarios.
- **Sensitivity runs:** Explored the impact on platform update rate on load.
- **PC comparison runs:** Performed the same set of load runs on three different PCs.
- **Long-Term Stability run:** One 10-hour run was done with a heavy load to determine the stability of the JTIDS simulation.

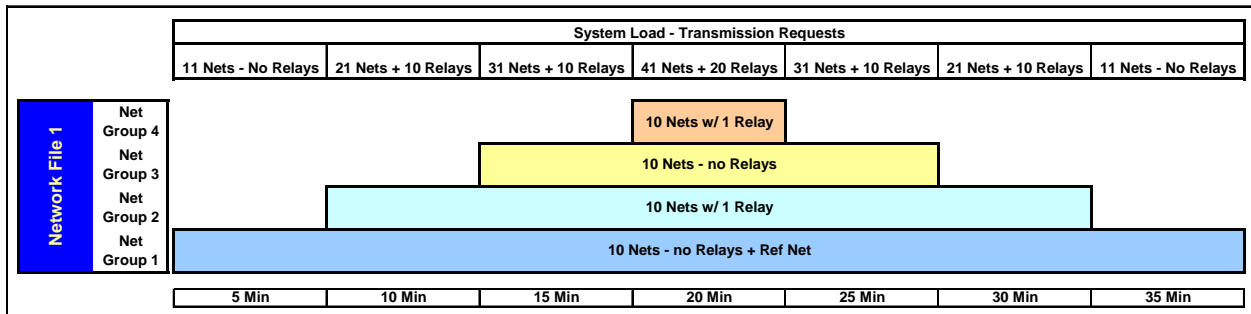
We decided to use different load rates that we came to refer to as “full”, “half” and “quarter” rates to drive the nets. For each “load” rate, we used different values for nets with and without relays. Table 5 shows that network load rates that were used in the experimentation. Generally, the HLA message generator was set to generate specified messages at random rates between the high and low values shown in the table.

**Table 5 - Network Load Rates**

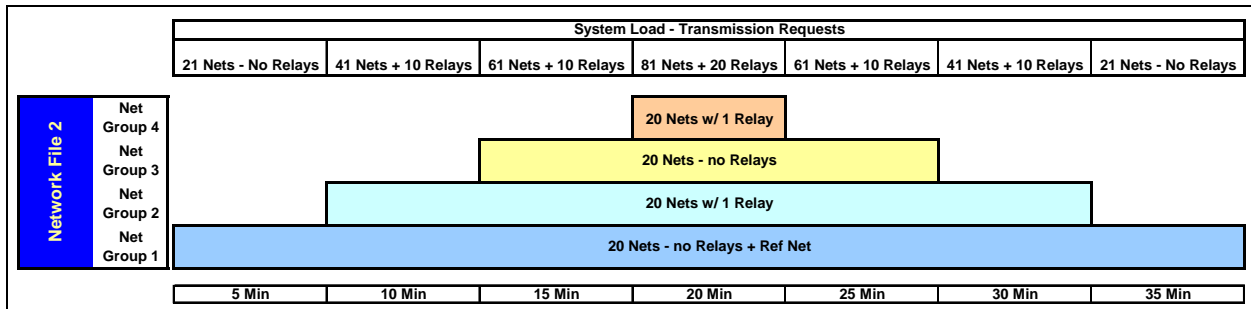
	<b>Nets with No Relay</b>	<b>Nets with One Relay</b>
<b>Full Rate</b>	5 – 20 Seconds	15 – 30 Seconds
<b>Half Rate</b>	10 – 40 Seconds	30 – 60 Seconds
<b>Quarter Rate</b>	20 – 80 Seconds	60 – 120 Seconds

For most load runs, we decided to use a stepped sequence of transmission requests. Every five minutes (real time) we introduced another set of transmission requests on a new net group, building up to a total of four net groups under load. Then we turned off net group requests every five minutes. The sequence and loads for 41 Nets and for 81 Nets is shown in Table 6 and Table 7 respectively.

**Table 6 - 41 Net Group Stepped Loads**

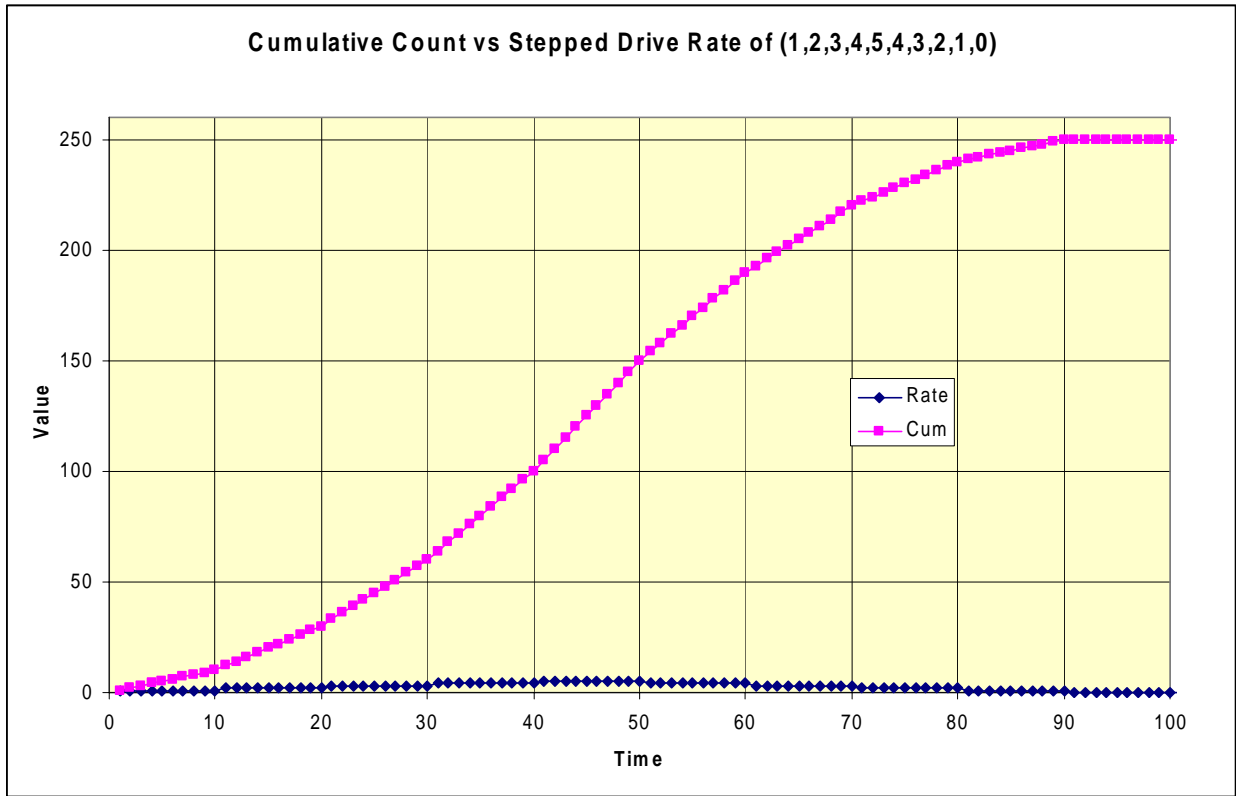


**Table 7 - 81 Net Group Stepped Loads**



Note that these loads were not uniform in size due to the fact that every other net group that was introduced had nets with a single relay. Also, the nets within the Net Groups varied in terms of their throughput with the Mission Management nets having an RRN of 8 and the PPLI\_B nets having an RRN of 7. Note that the Reference Net has an RRN of 8.

The stepped requests allowed us to predict the ideal shape of the cumulative count of MSG\_SEND interactions (transmission requests) as shown in the pink curve in Figure . If the JTIDS system is keeping up with real time, then the shape of the cumulative count of MSG\_RCVD interactions (transmission responses) should have exactly the same shape. The lower black curve shows the stepped request rates during each five-minute step period.



**Figure 19 - Ideal Cumulative Count Curve for Stepped Transmission Requests.**

Figure 20, Figure 21 and Figure 22 show sample transmission request rates for “full”, “half” and “quarter” rates respectively. The left side of each figure shows data for the rate with no relay, and the right side shows data for the rate with one relay. This data comes from the LOG files created by the HLA Recorder from recording different experimentation runs.

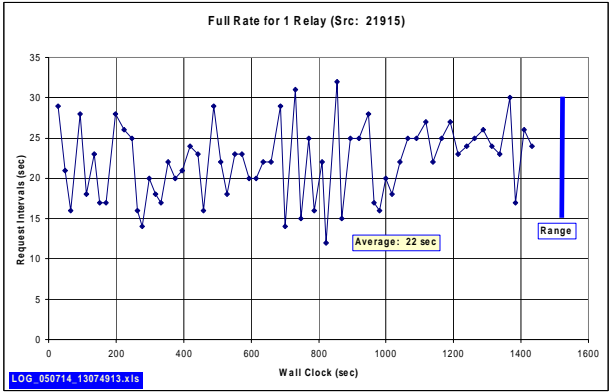
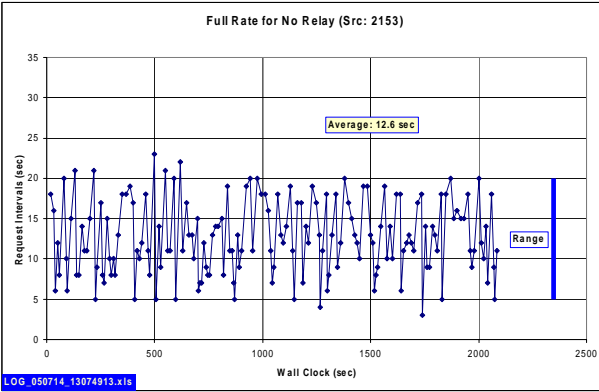


Figure 20 – Sample of Full Request Rates

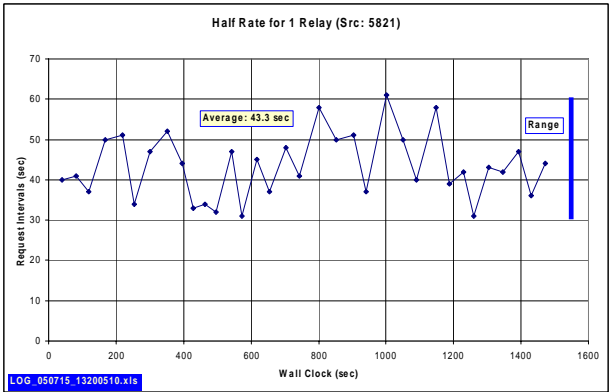
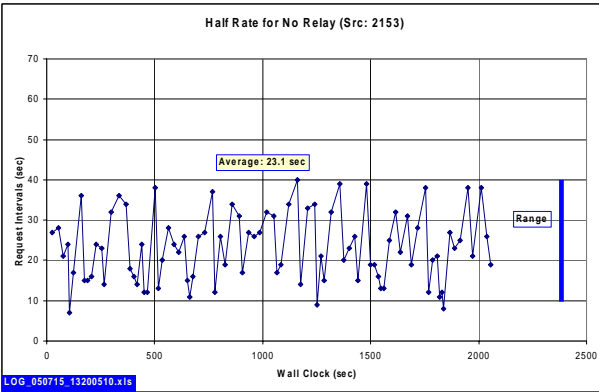


Figure 21 – Sample of Half Request Rates

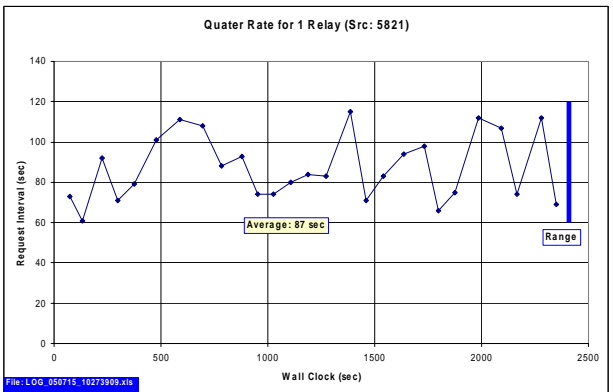
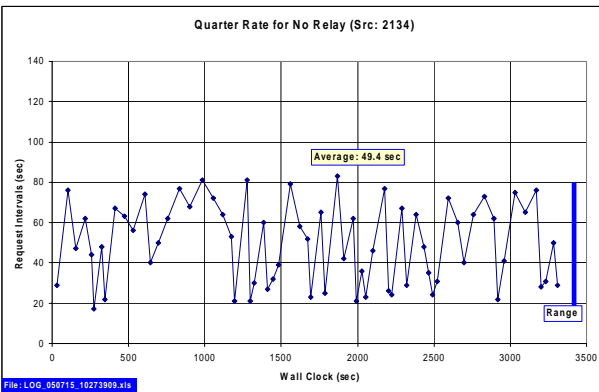


Figure 22 – Sample of Quarter Request Rates

### 3.5 Metrics

Metric data for GIESim-JTIDS bench-test load runs were collected in the JTIDS Monitor MON files and in the GIESim HLA Recorder LOG files. Some data in these files was used directly, and some of the data was post processes. Examples of data that is used directly include cumulative counts of transmission requests in the Monitor file and measured latency recorded in the recorder LOG file. Some post analysis involved statistical analysis of captured data to yield new metrics for understanding JTIDS loading and to verify correct operation.

**Table 8 - Notations and Meaning**

<b>Notation</b>	<b>Meaning</b>
<X>	Average value of a measured metric over the duration of a load run. Typically applied to measured latency values.
SD(X)	Standard deviation of a measured metric over the duration of a load run. Typically applied to measured latency values.
TMA(X)	Time moving average of a measured metric over a moving window of time – typically 60 seconds unless otherwise specified. TMA is typically applied to cumulative metric data to determine the average driving rate over the averaging window.
Min(X)	Minimum value of a measured metric over the span of a load run.
Max(X)	Maximum value of a measured metric over the span of a load run.

**Table 9 - Metric Notation for Data Collected by JTIDS Monitor**

<b>Metric Notation</b>	<b>Meaning</b>	<b>How Collected</b>
E	Expected value – JTIDS internal cumulative measure of how many receivers are expected to receive messages as a result of transmissions.	JTIDS/Monitor Accumulated each second as transmission requests come in.
R	Relay value – JTIDS internal cumulative measure of how many relay transmission occur.	JTIDS/Monitor Accumulated each second as relay transmissions occur.
E+R	Sum of Expected and Relay values.	JTIDS/Monitor Accumulated each second.
HR	Cumulative value of Host messages received.	JTIDS/Monitor Accumulated each second for host receptions.
S/R	Ratio of simulation clock to wall (system) clock.	JTIDS/Monitor Computed each real second.
OF	Cumulative count of transmit buffer overflows that may occur.	JTIDS/Monitor Accumulated each second if overflow occurs.
ES	Cumulative count of Entity State HLA interactions received to update platform positions.	JTIDS/Monitor Computed each real second.
MS	Cumulative count of GIESIM_MSG_SEND HLA interactions that request message transmissions.	JTIDS/Monitor Computed each real second.
MR	Cumulative count of GIESIM_MSG_RCVD HLA interactions sent by JTIDS when a requested destination has received the message.	JTIDS/Monitor Computed each real second.
MS-MR	Difference in total requests versus responses (lost messages).	Computed in Monitor.
T	Total duration of the run in seconds.	JTIDS/Monitor.

The following table lists post process analysis of JTIDS Monitor data.

**Table 10 - Metrics Computed from Monitor Data**

<b>Computed Metric Notation</b>	<b>Meaning</b>
<E>	Average value of E over the duration of a load run.
TMA(E)	Time moving average of Expected values.
<R>	Average value of R over the duration of a load run.
TMA(R)	Time moving average of Relay values.
<E+R>	Average value of E+R over load run.
TMA(E+R)	Time moving average of E+R.

The GIESim HLA Recorder captures all GIESim HLA interactions that occur and time stamps them with the wall clock (system time) in which they occur. The Recorder can record all of the five GIESim HLA interactions and their data fields that have been defined. Several post analysis operations are performed on recorded data to yield additional metrics. These are shown in the table below.

**Table 11 - Metrics Computed from Recorder LOG Files**

<b>Computed Metric Notation</b>	<b>Meaning</b>
<Net>	Latency values reported for selected nets average over the load run.
SD(Net)	Standard deviation of reported latencies for a selected net.
Min(Net)	Minimum latency for a selected net.
Max(Net)	Maximum latency for a selected net.

### 3.6 Charts

With the large number of metrics that were collected, there are an equally large number of possible charts. Charts are useful in understanding the dynamics of loading and the state of the simulation at different points in time, and the externally observable results recorded in the HLA recorder. Charts (and analyses) tended to fall into two categories as shown below.

- **Run Charts:** We decided to “standardize” on the following charts for each run with data spanning the duration of the run:
  - Sim/Real Ratio (MON data)
  - Ref Net Latency (LOG data)
  - Cumulative MSG\_SEND (MS) and MSG\_RCVD (MR) interactions (MON data)
  - Cumulative Expected (E) and Relays (R) (MON data)
  - Time Moving Averages: TMA(MS) and TMA(MR) (MON data)
  - Time Moving Averages: TMA(E) and TMA(R) (MON data)

We occasionally selected other metrics to chart for comparison and analysis, e.g., latency of other nets.

- **Cross-run Charts:** These were used to compare and analyze load factors between runs. Some examples include:
  - Cross Run Comparison Spreadsheet of collected metric data on the target PC, for different position update rates, and between target test PCs.
  - Sensitivity Charts: Plot a measure of load against Sim/Real Ratio.
- **Special Case Analysis Charts:** These are charts that were used to study specific things such as:
  - HLA Overhead.
  - Position update rates and modes.
  - Transmission Request rates for selected nets.

Early charting and comparison of Monitor and Recorder data gave us confidence that the Monitor and Recorder were working correctly and that internal and external measures correlated very well.

## 4.0 JTIDS Enhancements

### 4.1 Instrumentation and Monitoring

The PSI JTIDS simulation was designed and built with performance measurement capabilities, which were “inherited” by the GIESim version of JTIDS. To support the experimentation associated with loading of the GIESim JTIDS simulation, some of these functions in addition to other metrics associated with HLA were instrumented and monitored. This effort required a small amount of effort to achieve. Some extra statements were added to key places in the JTIDS simulation and to keep performance data. This data structure is tracked by a new GSS-based monitor task that is started by the JTIDS simulation and runs in parallel with it. Figure 23 illustrates the JTIDS instrumentation and monitor. JTIDS launches the monitor task automatically whenever it starts. The monitor task schedules a process to periodically read the metrics data being collected in JTIDS. The Monitor task does minimal processing on the data until JTIDS ends, at which point the Monitor writes its stored data to a MON file. A Sim Clock, which also displays the current Sim/Real Ratio, was also added to JTIDS. This clock allowed us to determine how well JTIDS was maintaining real time.

The monitor task is simple, small and was easy to build. The Monitor task architecture is shown in Figure 104. Instrumentation and monitoring of JTIDS were keys to the experimentation that was performed. Load testing indicated that the instrumentation and Monitor functions introduce a negligible load on the system PC.

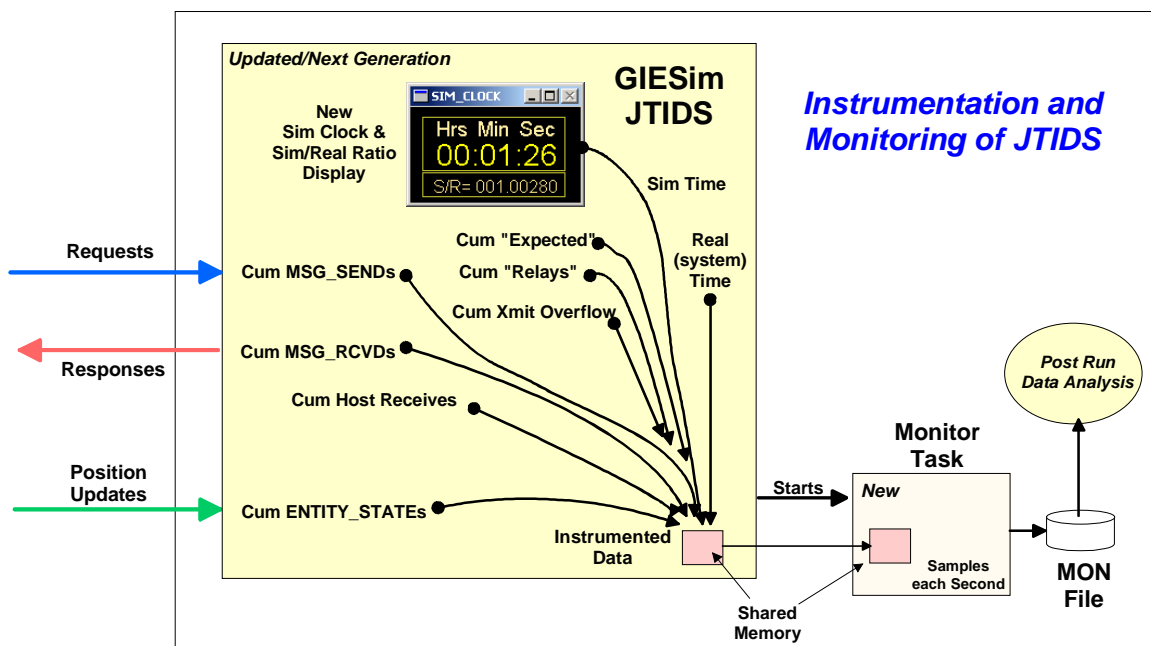
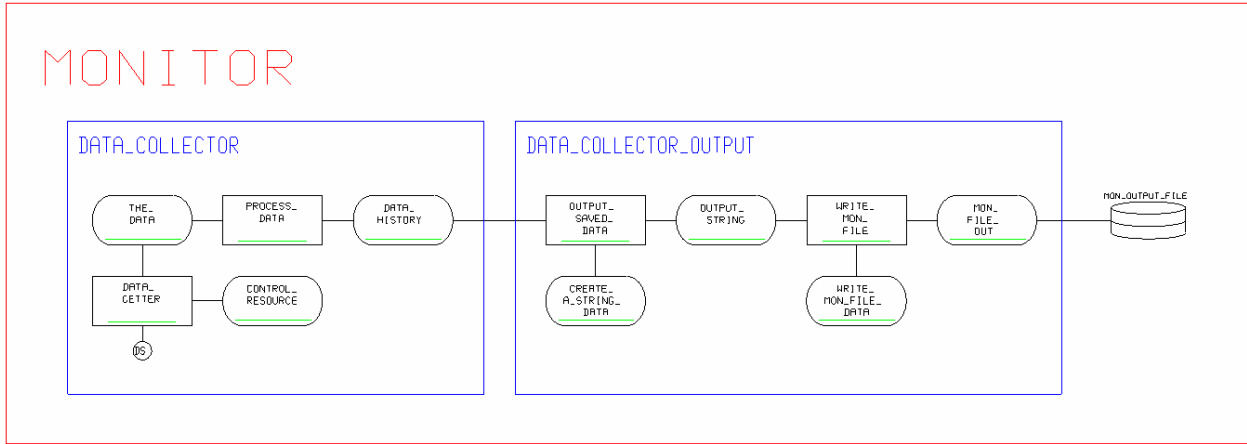


Figure 23 -Instrumentation and Monitoring of JTIDS for Load Test Experimentation

Figure 24 indicates the metrics that are accumulated in JTIDS that are collected by the Monitor.



**Figure 24 - New Monitor Task for Collecting JTIDS data**

The MON file is automatically assigned a unique name of the form: MON\_050714\_13584804.CSV. Monitor files store data in comma-separated-value (CSV) format that can be directly read into Excel.

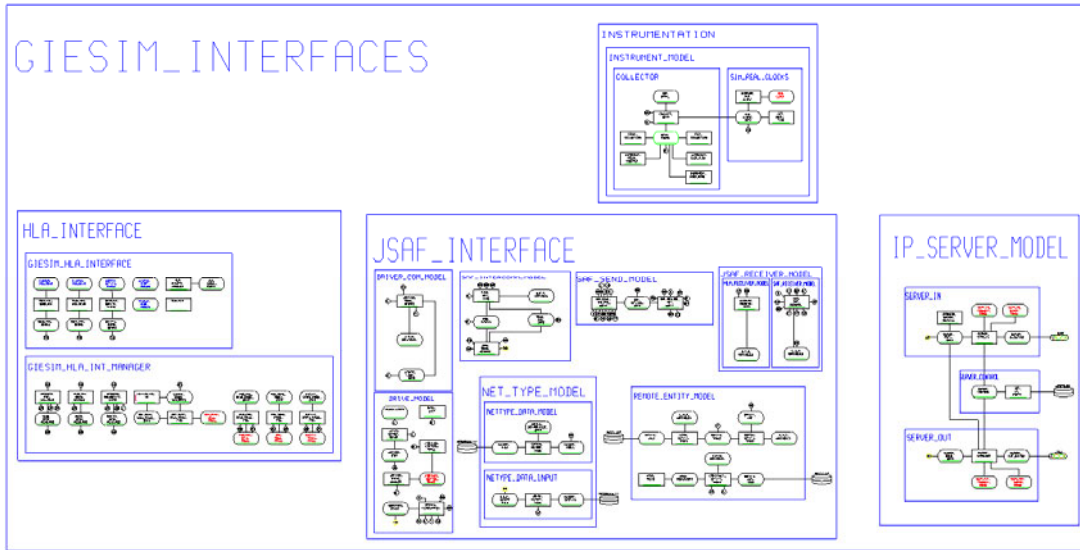
The next section provides additional information on enhancements and updates that were accomplished for the GIESim JTIDS Simulation.

## 4.2 Enhancements to GIESim JTIDS

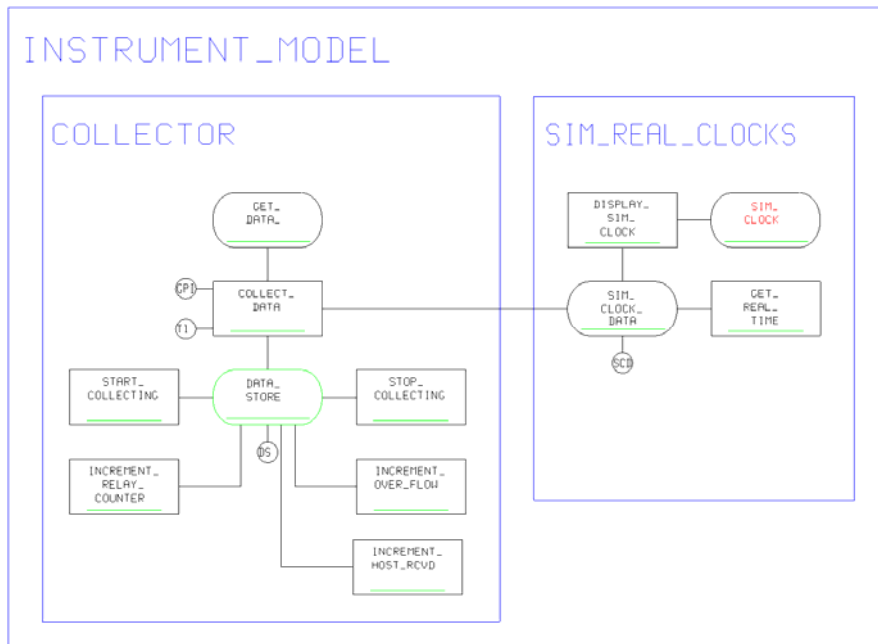
During early experiments with GIESim JTIDS, several needed enhancements were identified that could substantially increase load capacity and accuracy of responses. These enhancements were beyond the instrumentation that was added to JTIDS. Enhancements to JTIDS are summarized in the list that follows.

- **GIESim Enhancements:** Figure 25 shows the architecture of the updated and refined GIESIM\_INTERFACES model that now includes the new INSTRUMENT\_MODEL. Several enhancements were made to this interface module that improved performance. In particular, the efficiency of the Entity ID search processes was improved and the net search efficiency was dramatically improved by using previously computed information.
- **Instrumentation:** Details of instrumentation were largely discussed in the prior section. Figure 126 provides a close-up of the INSTRUMENT\_MODEL architecture.
- **Reduced HLA tick time:** The minimum time to process HLA events within the HLA tick routine is referred to as the “tick” time. GSS had a minimum tick default value of 1 ms., which had been set for other GSS applications of HLA. Due to the large amount of processing performed in the JTIDS simulation, the minimum tick time was being invoked frequently and taking up a lot of real time. We assessed the impact of reducing the minimum tick interval and eventually chose 100 us. This value had no impact on HLA event handling and made a huge difference in available real time.
- **Reduced overhead of HLA GUI:** The GIESim JTIDS simulation has a GUI to show HLA traffic and cumulative counts of each GIESim HLA interaction. This panel was updated (redisplayed) for each HLA event, either sending or receiving. This display activity introduced a high load on the system, which diminished the ability of JTIDS to handle message requests. This panel is now updated every 5 seconds, which significantly improves available real-time.
- **New Latency Calculation:** The latency calculation was changed to use wall (system) clock rather than simulation clock since we were interested in the real rather than simulated latency. In early applications of GIESim JTIDS with JSAF, only single transmission requests were being made, and JTIDS was running essentially at real time. However, as JTIDS gets loaded down the simulation clock can fall behind the wall clock. The use of wall clock time to determine message latency provides a more accurate measure of the real performance of JTIDS under load.
- **Migration to JTIDS 1.4Update:** The GIESim JTIDS Simulation was migrated to the most recent version of the PSI JTIDS Simulation (1.4Update). This move, while costly in time, was deemed to take less time than to find and fix bugs that were already fixed in the latest JTIDS. This move fixed a number of problems and provided new capabilities:
  - The link states to/from ground platforms now accurately reflect their true states. The older version of JTIDS that GIESim-JSAF was based on sometimes did not update link states for ground platforms, which could cause messages to drop.

- The newer JTIDS simulation has a new NET file format, therefore by moving GIESim-JSAF to the newer version we can now use all the capabilities of the current Link-16 NMS including:
  - Link-16 Planning tool
  - Time Slot Allocation tool.
- Migration to the newer JTIDS and GSS improves support of GIESim JTIDS.



**Figure 25 - Updated and Enhancement GIESIM\_INTERFACES Model in JTIDS**



**Figure 26 - New Instrumentation Model added to JTIDS**

## 5.0 Driver Enhancements

During early experimentation, we determined that more controlled position updates were required from the JTIDS Driver simulation. We also identified some modes of update operations that would be good to have for load testing, and some opportunities to reduce load on the Driver system. As a consequence the Driver was updated as listed below.

- **New Platform Update Model:** A new platform update model was introduced that had been built for another application. This update model provides very precise control of update rates. In addition, the update model was enhanced to provide new modes of operation. Mode of operation and update rate are now specified in the file P\_U\_VARS.SFI. The new modes of operation are:
  - **Update Platforms:**
    - **All** platform locations – sends updates for all platforms.
    - **Changed** platform locations – sends updates only for platforms that change location. The initial update will send all platform positions.
  - **Update Type:**
    - **Bulk** - All position updates are sent “at once” at each update interval. In actuality it may take 2-3 seconds to send 130+ updates.
    - **Distributed:** Position updates are spread uniformly over the update interval.
- **Reduced HLA GUI Overhead:** The HLA GUI is now updated after completion of the platform update cycle rather than for every HLA event.
- **Reduced HLA Tick:** The HLA minimum time was reduced to 100 us.
- **Update Only Link-16 Platforms:** The Link-16 NMS scenario file can contain logical references to hierarchical platform groups such as a mission. These logical references are represented as icons on the JTIDS screen. While sending position updates for these references does not cause a problem, it did add to the HLA message overhead so the Driver was modified to only send position updates for actual Link-16 platforms.
- **GSS Upgrade:** The Driver is now built with GSS Release 10.3.10.

Sample runs using all four Driver update combinations were performed, and the cumulated ENTITY\_STATE counts were analyzed and charted from the JTIDS Monitor data files as shown in Figure 137 through Figure 30.

In private discussions with Jerry Reaper at SAIC, it was determined that JSAF processes and sends position updates for each platform separately. However, platform position updates occur on a fairly regular schedule such that all position updates are typically sent very close together every 10 seconds. Furthermore, JSAF sends position updates for all platforms even if the platforms have not changed position. Therefore, for the majority of our experiments we chose to

set the Driver simulation to send ALL positions every 10 seconds as shown in Figure 27. In selected runs we examined the impact of using Changed and Distributed updates.

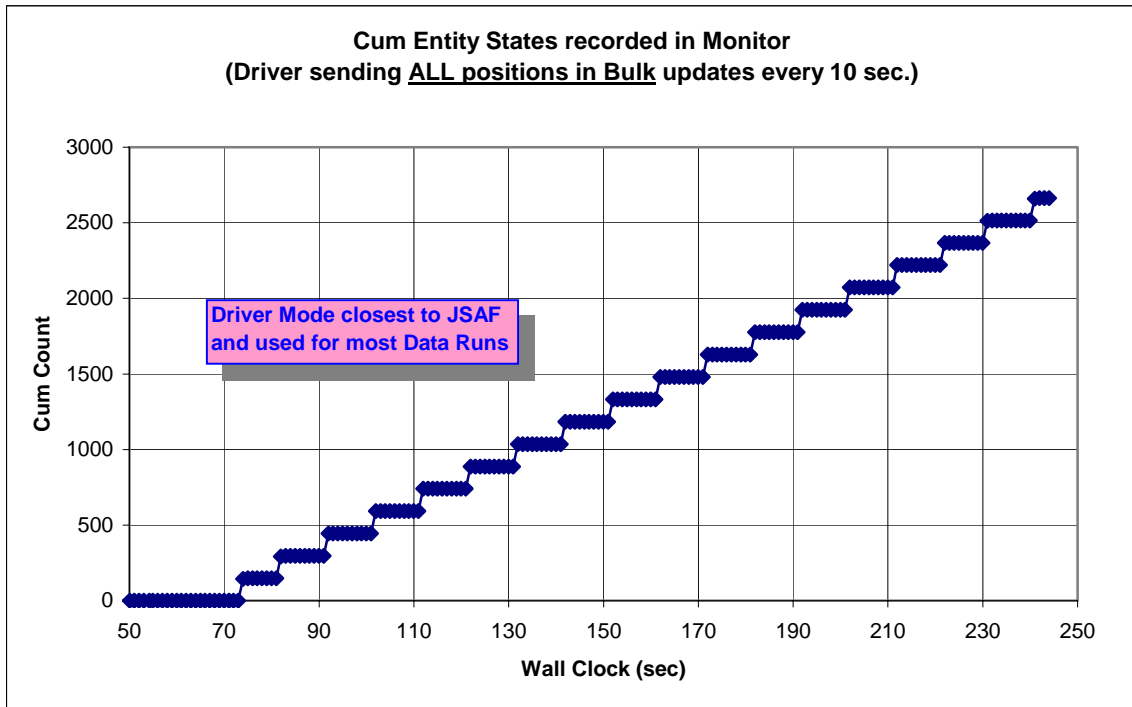


Figure 27 - Cumulative Driver Updates: ALL positions every 10 seconds

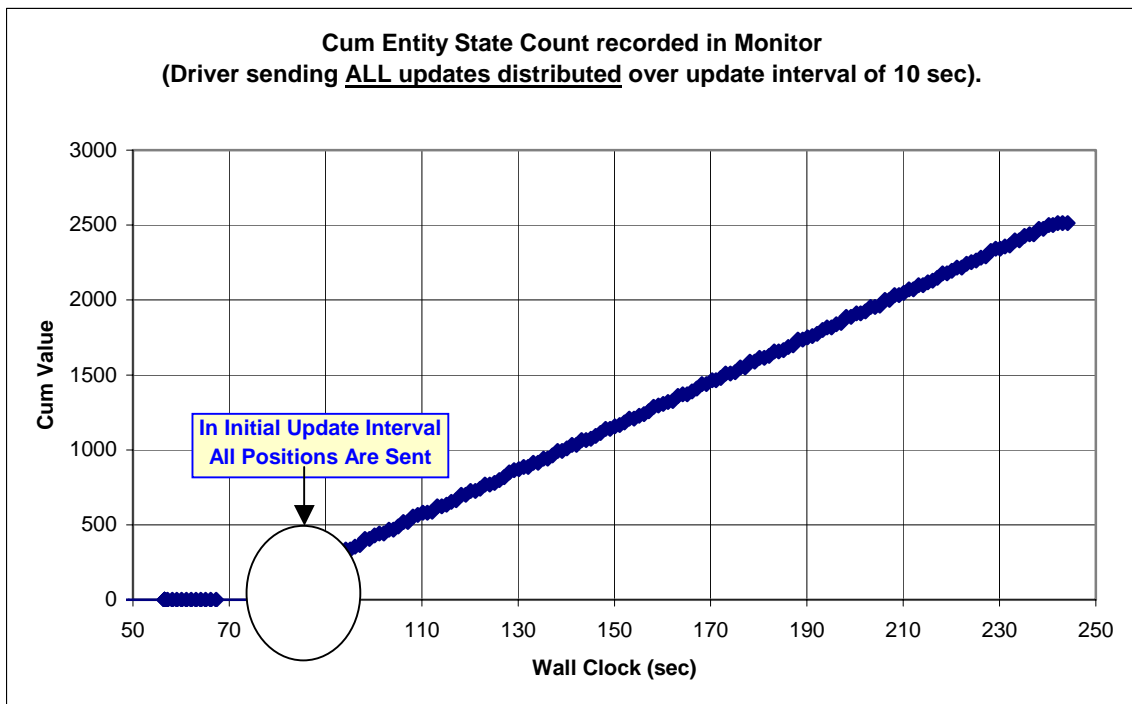
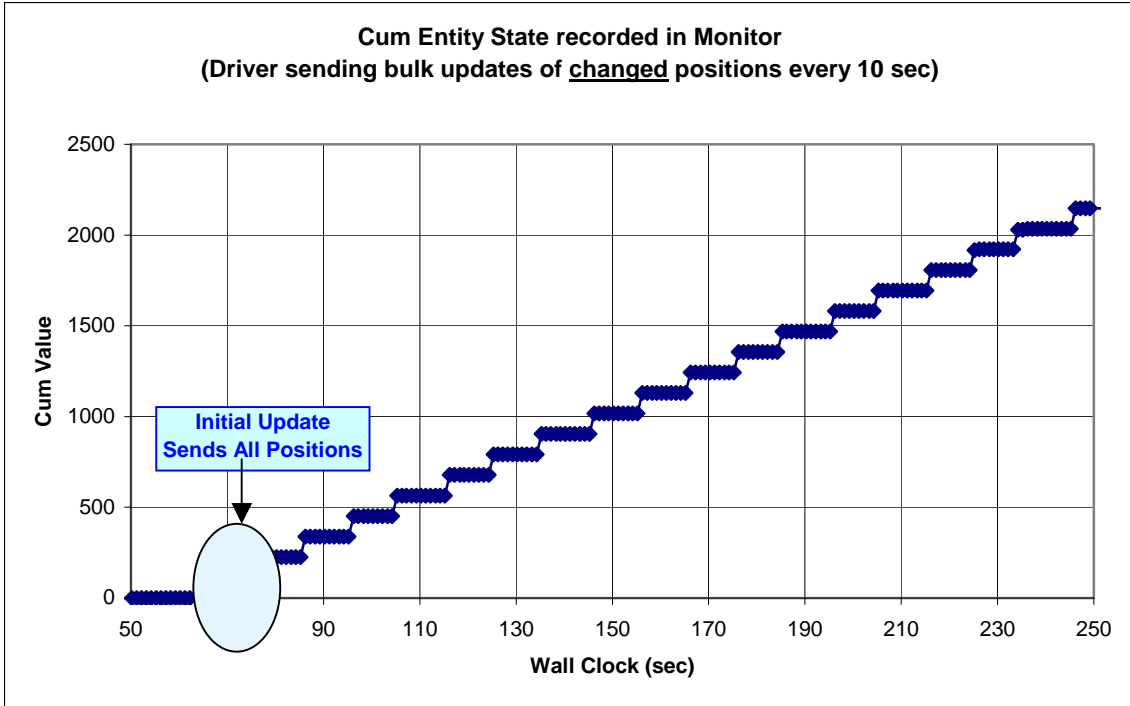
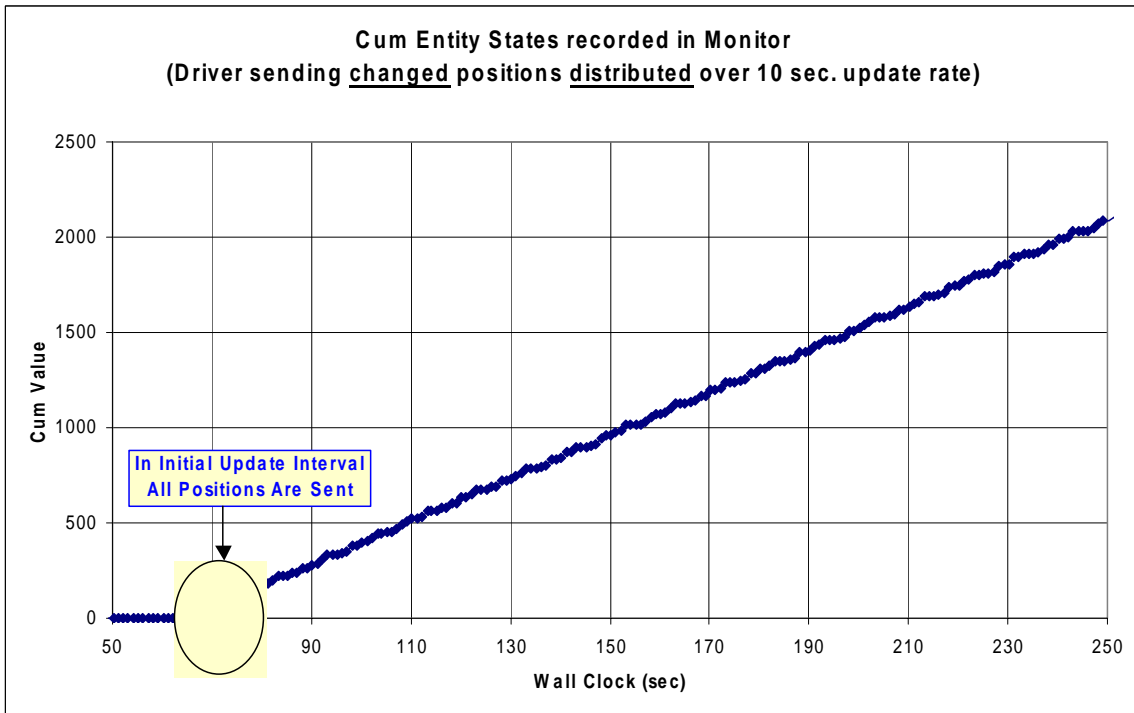


Figure 28 - Cumulative Driver Updates: ALL updates distributed over 10 seconds.



**Figure 29 - Cumulative Driver Updates: Changed positions every 10 seconds**



**Figure 30 - Cumulative Driver Updates: Changed positions distributed over 10 seconds**

## 6.0 HLA Recorder/Player/Generator (HRPG) Tool

Based on the experience in preparation for the Mar 05 SPIE demonstration of GIESim/JSAF integration, PSI and SAIC identified the need for a GIESim HLA Recorder/Player (HRP). This capability would allow SAIC to record JSAF messages being sent to JTIDS and responses sent from JTIDS. Recordings would then be sent to PSI for playing into JTIDS for the purposes of debugging, and more importantly for interoperability load experiments. An initial version of HRP was developed by PSI and sent to SAIC on May 12, 2005. The HRP is based on the HLA test tool that PSI developed for prior GIESim projects. The recorder and player functionally of HRP were adapted from HLA work that PSI did for the Army.

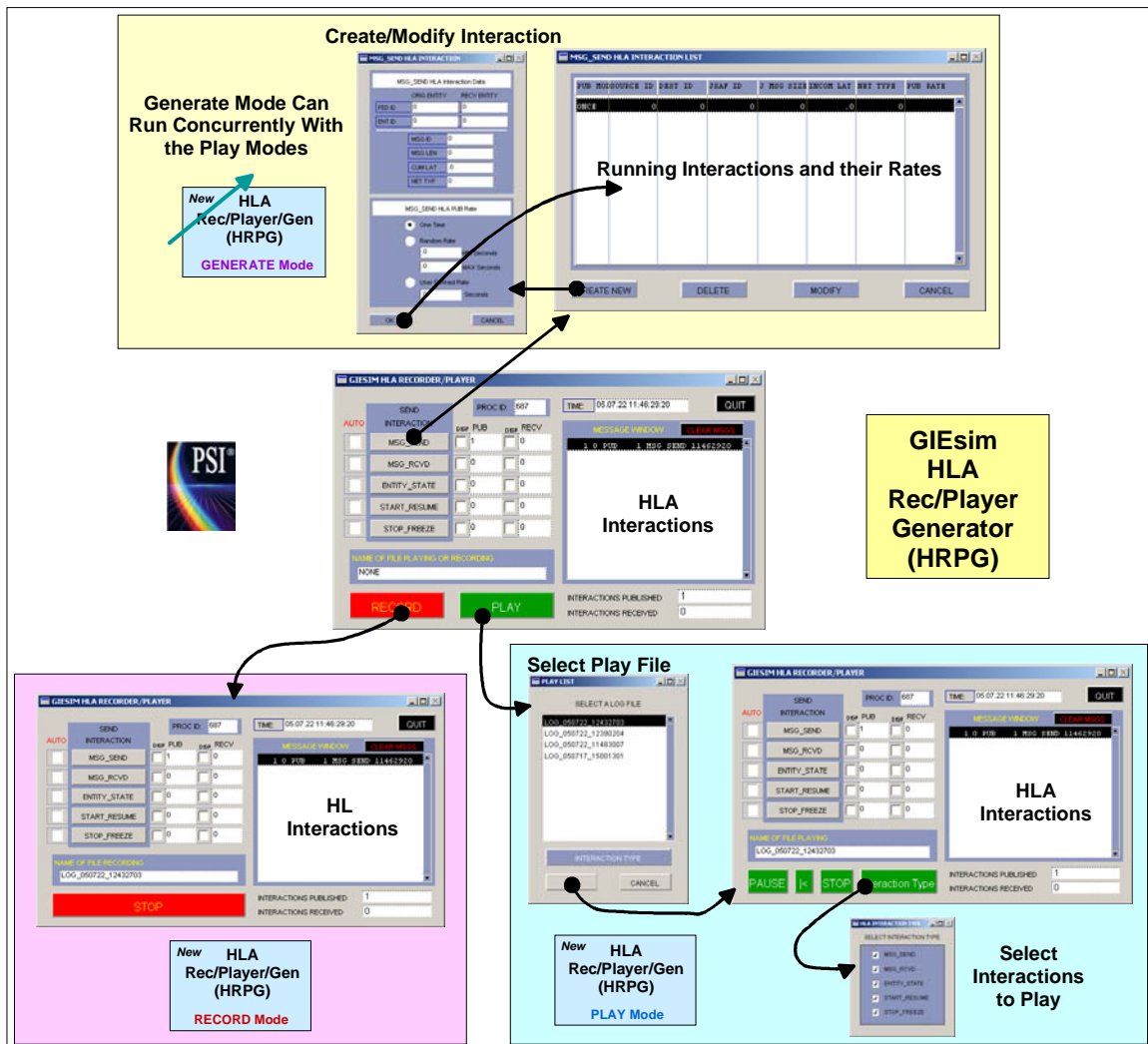


Figure 31 -Functionality and Graphics of the HLA Recorder/Player/Generator (HRPG)

During initial planning for experimentation on JTIDS, PSI realized that HFP could be extended to include the ability to generate messages. This is a straightforward extension of HRP and resulted in a new tool - HRPG. The Generate mode of HRPG can be used concurrently with the

Play mode. Figure 31 illustrates the operating modes and screens of HRPG. The upper part of the Figure 31 illustrates the Generate mode function. HRPG allows creation and scheduling of any of the GIESim HLA interactions on either a one-shot, periodic or quasi-random rate. Multiple messages with different content can be scheduled. HRPG allows modification or deletion of any running message generator. HRPG has proven to be an essential, invaluable tool for bench-test experimentation on JTIDS.

The Figure 32 is a screen shot of the architecture of HRPG that shows its functional portioning.

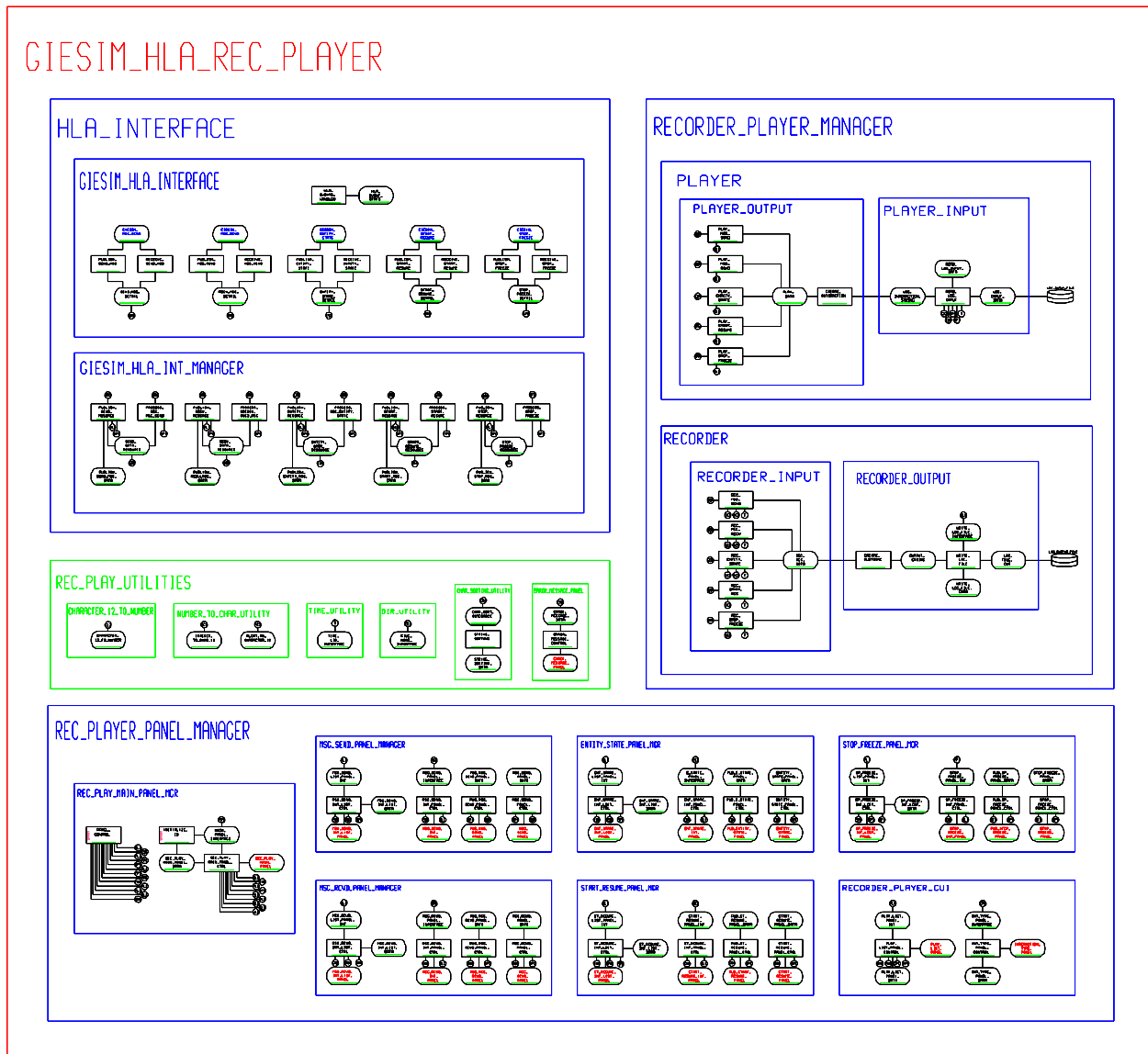


Figure 32 - GSS Architectural Drawing of the Final HLA Recorder/Player/Generator

The following list provides an overview of HRPG functions:

- **HLA Message Generator:** Functions allow a user to build messages for each GIESim HLA interaction. Up to 50 user created interactions of each type can be stored.
  - **Transmission options** include:
    - **Single message.**
    - **Periodic transmissions**
    - **Pseudo random transmissions.**
  - **Auto ID numbering:** In any message, if the message ID is set to zero, then HRPG automatically supplies a sequential message ID from a sequence that it maintains. Auto ID capability is extremely useful in tracking specific messages and associated responses from JTIDS.
  - **Modify/Cancel Messages:** HRPG creates a list of user created messages and allows the user to select and modify (or delete) the message.
- **Play Mode:** Presents the user with a list of recordings to play and plays the recording that is selected. Prior to and during playing, the user can select which of the HLA interactions to play. This allows playback of just the MSG\_SEND interactions to stimulate the JTIDS simulation.
- **Record Mode:** This mode records all GIESim HLA interactions that occur and automatically stores the results in recording file with a name of the form LOG\_050717\_15001301 into the LOG\_FILE sub directory. The name of each recording file is unique since it includes the date and time at the start of the recording. LOG files record data in comma-separated-value (CSV) format that can be directly read into Excel.

Additional enhancements that were made to HRPG over the period of experimentation include:

- Reduced HLA Tick time to 100 us.
- Reduced overhead of HLA GUI by refreshing it every 5 seconds.
- HRPG is now built with GSS Release 10.3.10.

## 7.0 Experimentation

Over 26 hours of testing was required to run the 22 load tests that were performed to collect well over 100 MB of data that was used in this report. Data reduction, charting and cross-run analyses incurred considerable additional time. This does not count the dozen or so early runs and hours of testing that were done to refine the tools and to establish the overall test methodology.

Table 12 presents all the load runs that were performed on the Main test PC and that summarizes the high-level data that was collected.

Table 12 - Load Runs on Main Test PC

### GIESim-JTIDS Bench Test Data

Load Tests on Main Test PC									
Load Run Description	Ref Net 10s Rate	41 Net Step .25 Rate	41 Net Step .5 Rate	41 Net Step Full Rate	41 Net Constant .5 Rate	41 Net Step Full Fate	81 Net Step .5 Rate	81 Net Step Full Rate	
Duration (sec)	712	3510	2250	2516	2237	2586	2312	2525	
<b>Position Updates</b>									
Update Rate (sec)	10	10	10	10	10	10	10	10	
ALL/Delta	ALL	ALL	ALL	ALL	ALL	Delta	ALL	ALL	
Burst/Distrib	Bulk	Bulk	Bulk	Bulk	Bulk	Bulk	Bulk	Bulk	
<b>Load Factors</b>									
JTIDS Simulation Internal Measures	Total Expected	61	115752	142429	285034	199489	285034	167371	346726
	Total Relays	0	27898	34836	67591	67810	67412	39912	78299
	Total E+R	61	143650	177265	352625	267299	352446	207283	425025
	<Expected>	0.086	33	63	113	89.18	110	72.4	137.3112
	<Relays>	0	8	15	27	30.31	26	17	31.00815
	<E+R>	0.086	41	79	140	119.49	136	89.7	168.3194
	Total Receives	61	79311	96511	191763	136390	191665	79761	163572
<Receives>	0.086	23	43	76	60.97	74	34.5	64.77817	
Measured Values recorded from Monitor	Total ES	9472	56376	35478	40014	31968	28529	17325	18942
	<ES>	13.3	16	16	16	14.3	11	7.49	7.50
	Total MS	61	1628	1806	3400	2400	3400	3376	6755
	<MS>	0.086	0.46	0.80	1.35	1.07	1.31	1.46	2.68
	Total MR	61	1599	1781	3361	2351	3357	3300	6618
	<MR>	0.086	0.46	0.79	1.34	1.05	1.30	1.43	2.62
	Gap(MS-MR)	0	29	25	39	49	43	76	137
% Lost	0%	2%	1%	1%	2%	1%	2%	2%	
Worst S/R Ratio	1	0.996	0.883	0.531	0.576	0.541	0.993	0.63	
<b>Measures</b>									
<Ref Net Latency>	1.56	1.63	2.13	5.28	3.88	4.76	1.82	2.85	
STDV(Ref Net Latency)	0.96	0.89	1.66	5.45	2.72	4.65	0.88	2.37	
Min(Ref Net Lat)	0.42	0.23	0.04	0.11	0.05	0.05	0.22	0.04	
Max(Ref Net Lat)	3.48	4.60	10.93	26.20	13.50	27.77	4.10	12.79	

Table 13 lists load runs that were performed to examine load sensitivity to position update rates. Data from some runs from Table 12 were repeated in this table so that they can be more easily compared on a side-to-side basis.

**Table 13 - Position Update Sensitivity Runs**

<b>GIESim-JTIDS Bench Test Data</b>									
<b>Sensitivity to Position Update Rates</b>									
		<b>5 Update Rates</b>					<b>3 Update Rates</b>		
<b>Load Run Description</b>		<b>41 Net Step .5 Rate 18s</b>	<b>41 Net Step .5 Rate 14s</b>	<b>41 Net Step .5 Rate 10s</b>	<b>41 Net Step .5 Rate 6s</b>	<b>41 Net Step .5 Rate 2s</b>	<b>81 Net Step Full Rate 14s</b>	<b>81 Net Step Full Rate 10s</b>	<b>81 Net Step Full Rate 6s</b>
	<b>Duration (sec)</b>	2260	2240	2274	2306	2272	2443	2525.11	3031
<b>Position Updates</b>									
	<b>Update Rate (sec)</b>	18	14	10	6	2	14	10	6
	<b>ALL/Delta</b>	ALL	ALL	ALL	ALL	ALL	ALL	ALL	ALL
	<b>Burst/Distrib</b>	Bulk	Bulk	Bulk	Bulk	Bulk	Bulk	Bulk	Bulk
<b>Load Factors</b>									
<b>JTIDS Simulation Internal Measures</b>	<b>Total Expected</b>	142429	142429	142429	142429	142429	346726	346726	346726
	<b>Total Relays</b>	34922	34836	34836	34836	34664	77907	78299	78579
	<b>Total E+R</b>	177351	177265	177265	177265	177093	424633	425025	425305
	<b>&lt;Expected&gt;</b>	63.03	63.58	62.6	61.76	62.7	142	137.3112	114.4
	<b>&lt;Relays&gt;</b>	15.46	15.55	15.32	15.1	15.26	31.9	31.00815	26
	<b>&lt;E+R&gt;</b>	78.49	79.1	77.95	76.87	77.96	173.8	168.3194	140.3
	<b>Total Receives</b>	96647	96438	96437	96394	95876	163087	163572	163628
	<b>&lt;Receives&gt;</b>		43.05	42.4	41.8	42.2	66.75	64.77817	54
<b>Measured Values recorded from Monitor</b>	<b>Total ES</b>	18056	23088	32708	55352	163688	13090	18942	37884
	<b>&lt;ES&gt;</b>	7.99	10.31	14.38	24	72.06	5.36	7.501455	12.5
	<b>Total MS</b>	1806	1806	1806	1806	1806	6755	6755	6755
	<b>&lt;MS&gt;</b>	0.8	0.806	0.794	0.783	0.8	2.765	2.675131	2.23
	<b>Total MR</b>	1782	1781	1780	1780	1778	6614	6618	6605
	<b>&lt;MR&gt;</b>	0.788	0.795	0.783	0.772	0.78	2.71	4.844802	2.18
	<b>Gap(MS-MR)</b>	24	25	26	26	28	141	137	150
	<b>% Lost</b>	1.3%	1.4%	1.4%	1.4%	1.6%	2.1%	2.0%	2.2%
<b>Worst S/R Ratio</b>		<b>0.988</b>	<b>0.98</b>	<b>0.89</b>	<b>0.84</b>	<b>0.773</b>	<b>0.753</b>	<b>0.63</b>	<b>0.553</b>
<b>Measures</b>									
	<b>&lt;Ref Net Latency&gt;</b>	1.77	1.81	1.87	2.44	3.10	2.42	2.85	3.63
	<b>STDV(Ref Net Latency)</b>	1.18	1.18	1.29	2.03	3.40	1.91	2.37	3.08
	<b>Min(Ref Net Lat)</b>	0.04	0.04	0.05	0.25	0.05	0.09	0.04	0.11
	<b>Max(Ref Net Lat)</b>	7.22	7.56	7.20	12.70	17.02	9.37	12.79	18.83

Table 14 lists high-level data for cross PC comparison load runs plus data for the 10-hour long-term stability run.

Table 14 - Cross PC Comparison Load Runs and Long-Term Stability Run

GIESim-JTIDS Bench Test Data										
Cross-PC Load Test Comparisons & Long-Term Stability Run										
		Main Test PC			Laptop		3GHz Win 2K SP4 Desktop			10 Hour Long Run
Load Run Description		41 Net Step .25 Rate	41 Net Step .5 Rate	41 Net Step Full Rate	41 Net Step .25 Rate	41 Net Step .5 Rate	41 Net Step .5 Rate HWG	41 Net Step Full Rate	41 Net Step Full Rate HWG	41 Net Constant 1/2 Rate
Duration (sec)		3510	2250	2516	5001	5761	2236	3043	1869	36364
<b>Position Updates</b>										
Update Rate (sec)		10	10	10	10	10	10	10	10	10
ALL/Delta		ALL	ALL	ALL	ALL	ALL	ALL	ALL	ALL	ALL
Burst/Distrib		Bulk	Bulk	Bulk	Bulk	Bulk	Bulk	Bulk	Bulk	Bulk
<b>Load Factors</b>										
JTIDS Simulation Internal Measures	Total Expected	115752	142429	285034	115752	142429	142429	284346	162509	3873955
	Total Relays	27898	34836	67591	28242	33356	34750	67895	39239	1250238
	Total E+R	143650	177265	352625	143994	175785	177179	352241	201748	5124193
	<Expected>	33	63	113	23	24.7	63.7	93.4	87	106.5
	<Relays>	8	15	27	5.6	5.8	15.5	22.3	21	34.4
	<E+R>	41	79	140	28.8	30.5	79	115.7545	108	141
	Total Receives	79311	96511	191763	78580	95216	95976	190133	104708	2551376
<Receives>	23	43	76	15.7	16.5	43	62.5	56	70.16	
Measured Values recorded from Monitor	Total ES	56376	35478	40014	67192	79032	32412	43956	26788	537092
	<ES>	16	16	16	13.4	13.7	14.5	14.4	14.3	14.77
	Total MS	1628	1806	3400	1628	1806	1806	3400	3127	46168
	<MS>	0.46	0.80	1.35	0.325	0.31	0.81	1.12	1.67	1.27
	Total MR	1599	1781	3361	1597	1760	1779	3343	1941	43417
	<MR>	0.46	0.79	1.34	0.319	0.3	0.795	1.1	1.04	1.19
	Gap(MS-MR)	29	25	39	31	46	27	57	1186	2751
% Lost	1.8%	1.4%	1.1%	1.9%	2.5%	1.5%	1.7%	37.9%	6.0%	
Worst S/R Ratio		0.996	0.883	0.531	0.327	0.26	0.766	0.43	0.44	0.485
<b>Measures</b>										
<Ref Net Latency>		1.63	2.13	5.28	254.46	410.44	3.09	7.39	8.08	4.02
STDV(Ref Net Latency)		0.89	1.66	5.45	228.09	335.52	3.32	6.84	7.13	2.52
Min(Ref Net Lat)		0.23	0.04	0.11	0.33	0.40	0.05	0.08	0.12	0.04
Max(Ref Net Lat)		4.60	10.93	26.20	639.61	822.68	21.57	30.53	31.73	14.50
										Run Stopped HWG No Affect

The analysis of data collected from these runs is presented in the next section. Suggestions for future work opportunities are presented in the section that follows. Overall conclusions from load test experimentation are presented in the remaining section. The “standard” charts for the experimentation runs listed in the tables above are included as Appendix B. Note that all data collected is being provided on a CD that is hierarchy organized to match the organization of the three tables above.

## 8.0 Analysis of Results

PSI collected an enormous volume of data from the runs that were performed. This section provides high-level analyses of the load runs. First, an analysis is performed to examine the impact of HLA and system overhead to latencies. Next, data and analyses of the load runs performed on the Main Test PC are presented. An analysis across the main load runs follows next. Finally, results from position update rate sensitivity runs are presented, followed by analysis of the cross-PC load tests.

### 8.1 HLA & System Overhead

There was a question and concern about the possible overhead of HLA and JTIDS system message handling. Figure 33 illustrates some of the JTIDS simulation components that are involved with message handling and transmission latency. The figure also shows how data was collected to explore the answer to the question of overhead.

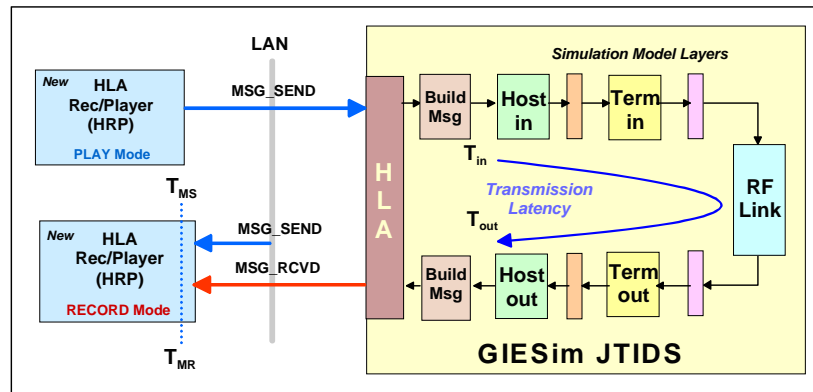


Figure 33 - HLA and System Overhead on Message Latency

The HLA recorder records the time of each MSG\_SEND interaction and the time of arrival of each associated MSG\_RCVD interaction. The difference in arrival times provides an overall measure of total system latency including contributions from HLA RTI-S. The latency for each message “transaction” was then subtracted from the computed time difference to provide a result that represents the contribution of the JTIDS and HLA without the internal JTIDS transmission latency.

Figure 34 shows the HLA and system overhead for the Reference Net when JTIDS is minimally loaded; the only transmission requests are the Reference Net while all 136 platforms are being updated. The overhead variation is only 2 seconds with an average close to 1.5 seconds.

Figure 35 shows a similar chart. In this case the system load is half rate on the 41 Net step case while all platforms are updating at a 10 second rate. The overhead variation is roughly the same. Note that recorder accuracy is 1 second while latency accuracy is in milliseconds. This can lead to negative overhead values.

Overall, HLA and JTIDS system overhead is a small contribution to message latency.

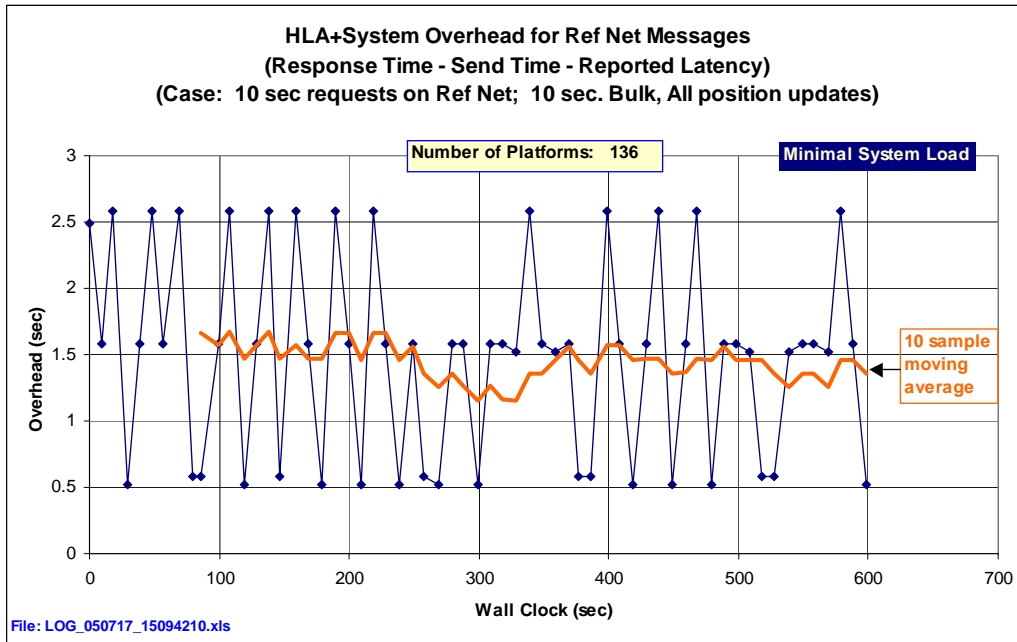


Figure 34 – HLA + System Overhead for Ref Net under Minimal Load

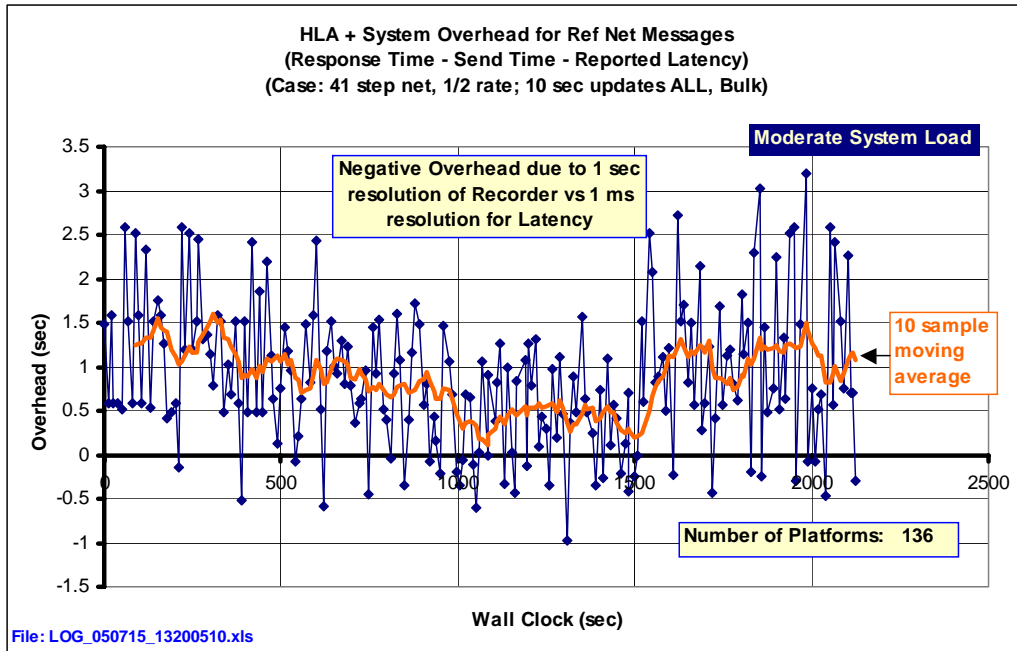


Figure 35 - HLA + System Overhead for Ref Net under Moderate Load

## 8.2 Review of Main Load Runs

Recall that the main PC load experiments were summarized in Table 12. This section presents charts and analyses for these runs. Much of the information presented will also be relevant to analyses presented in the sections that follow.

### 8.2.1 Review of Charts and Simulation Behavior

For each experiment load run we produced a “standard” set of charts. The first two charts are the Sim/Real Ratio and Reference Net Latency plotted against wall clock run time. Following these charts is a chart of cumulative MSG\_SEND (MS) and MSG\_RCVD (MR) interactions positioned above a chart of Cumulative Expected and Relay counts. The remaining two charts are time moving averages (TMA) of these four values. These charts, individually and taken together, can tell an interesting story. We start by comparing the charts shown in Figure 36.

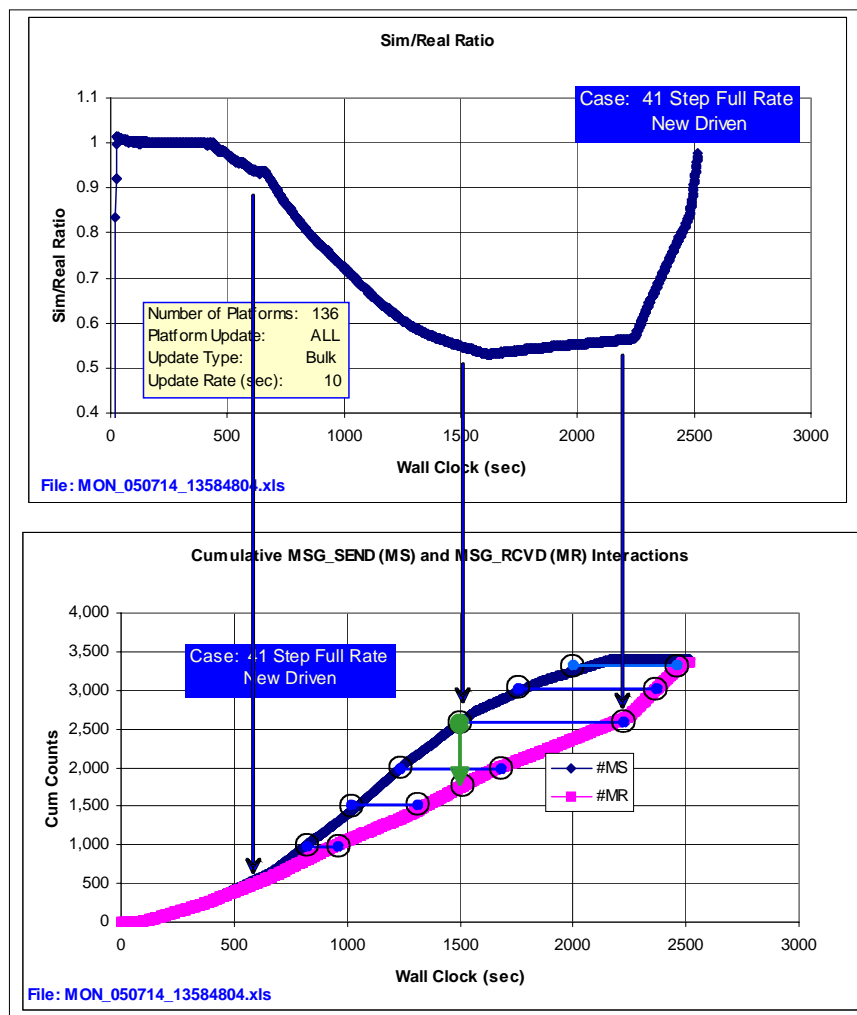


Figure 36 – Sim/Real Chart Compared with Cumulative MS and MR Counts

Figure 36 compares a chart of Sim/Real Ratio (SRR) to cumulative counts of MS and MR. The Sim/Real Ratio shown is for the highest (full) load on the 41 Net Step case. SRR quickly starts to drop when the first two loads are introduced, and drops to a low of approximately 0.54. The behavior of the cumulative chart for MS and MR follows the SSR curve. First note that the cumulative curve for MS closely follows the expected ideal curve for the driving function (41 Net Step requests). However, the curve for cumulative MR quickly departs from the MS curve and is not at all close to the ideal curve. As shown, the gaps between the MS and MR curves can be interpreted in two ways – horizontal and vertical. Horizontal gaps indicate the amount of time that responses are behind the requests. Vertically, the gaps tell how many messages are lagging behind in responses. The overall magnitude of the load is indicated by the amount of time that SRR spends below the ideal value of 1.0. Clearly the full 41 Net Step load is too high to be useful with JSAF because of the high latency delays and the position inaccuracies that will occur.

Figure 37 validates this conclusion. Under no load, the Reference Net has an average latency of 1.2 seconds. Under the highest load portion (middle of the run) the full 41 Net Step load, the moving average latency of the Reference Net goes up to 15 seconds – over 10 times the no-load value. The other charts in the sequence tell a similar story.

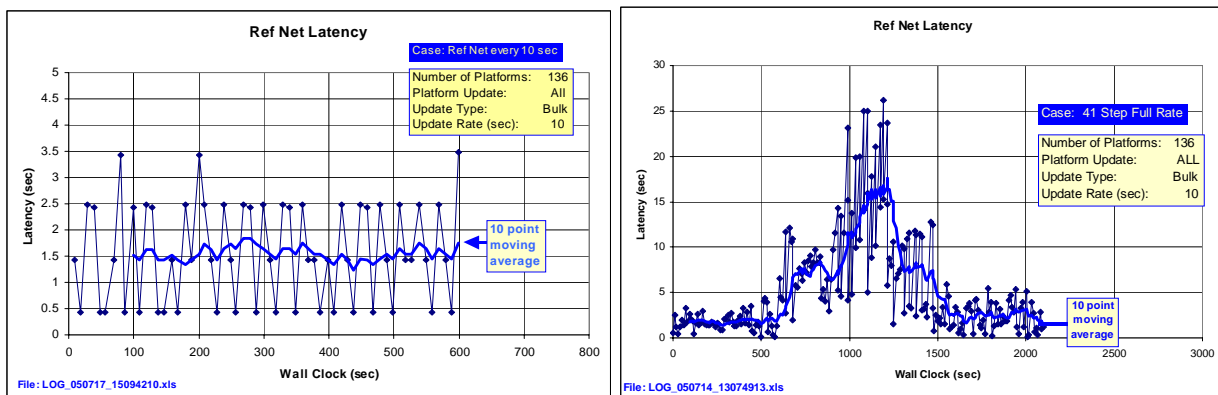


Figure 37 – Ref Net Latency for No Load vs. Full 41 Net Step Load

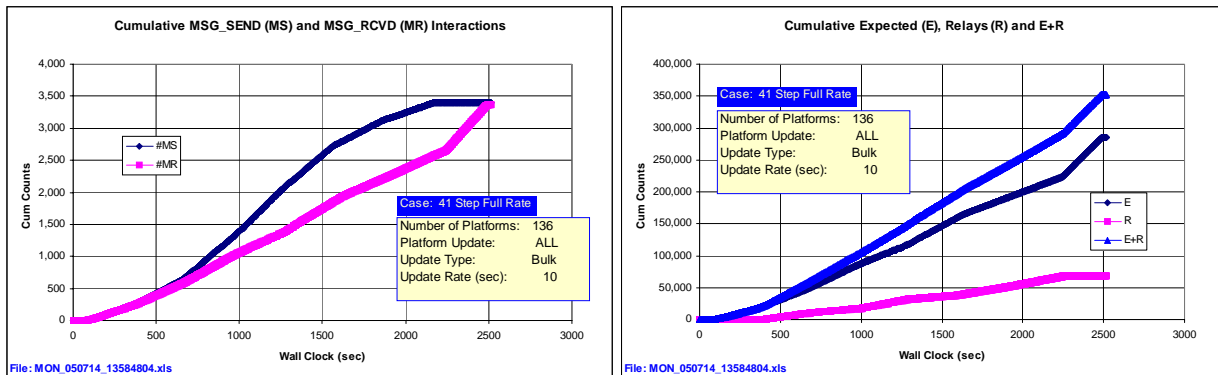


Figure 38 - Comparison of Cum MS and MR vs. Cum E and R counts

Figure 38 compares the charts for cumulative MS and MR with charts for cumulative E and R counts. We explored the left chart before. The chart for cumulative E and R deviates from the ideal step response curve. The shape shows break points in the same places that the SRR curve changes.

More interesting are the TMA charts for MS and MR and E and R shown below in Figure 39. At first the shape of the TMA(MR) and TMA(E) and TMA(R) curves surprised us. The TMA(MS) curve however reflected the real-time stepped load of requests that were being applied. We concluded that the large “bump” shown for TMA(MR), TMA(E) and TMA(R) is a result of the extended drop in SRR and messages therefore being queued up in the system – primarily in the simulation schedule queue. Once the driven load turns off, then the JTIDS simulation rather quickly flushes out the pent-up transmission requests that generate a flurry of transmission responses.

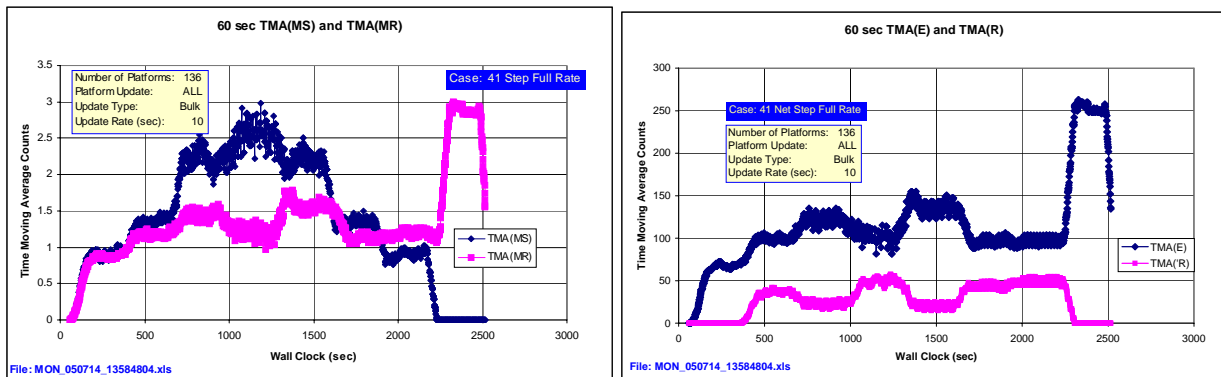


Figure 39 - Comparison of TMA charts of MS and MR vs. E and R

Obviously, the full 41 Net Step load is too high for this computer. The next section provides a comparison across the loads that were used and an analysis of what can be learned from the data.

## 8.2.2 Cross Load Run Analysis

This section looks across the experimental data to explore patterns that may be extracted. Figure 40 shows a chart that compares the average and min/max values of the Reference Net latency for each of the load runs performed on the Main Test PC. Each case shows the average value of Expected + Relay, e.g., <79>, and the worst-case SRR in the run, e.g., [.883]. Notice that as the SRR drops, the average Ref Net Latency increases rather smoothly to about 4 times the no-load value, however the max latency values spread by almost a factor of 7 to 8. While there is some correlation between SRR and <E+R>, there are unexpected differences between the SRR values for the 41 Net cases and the 81 Net cases compared to <E+R>.

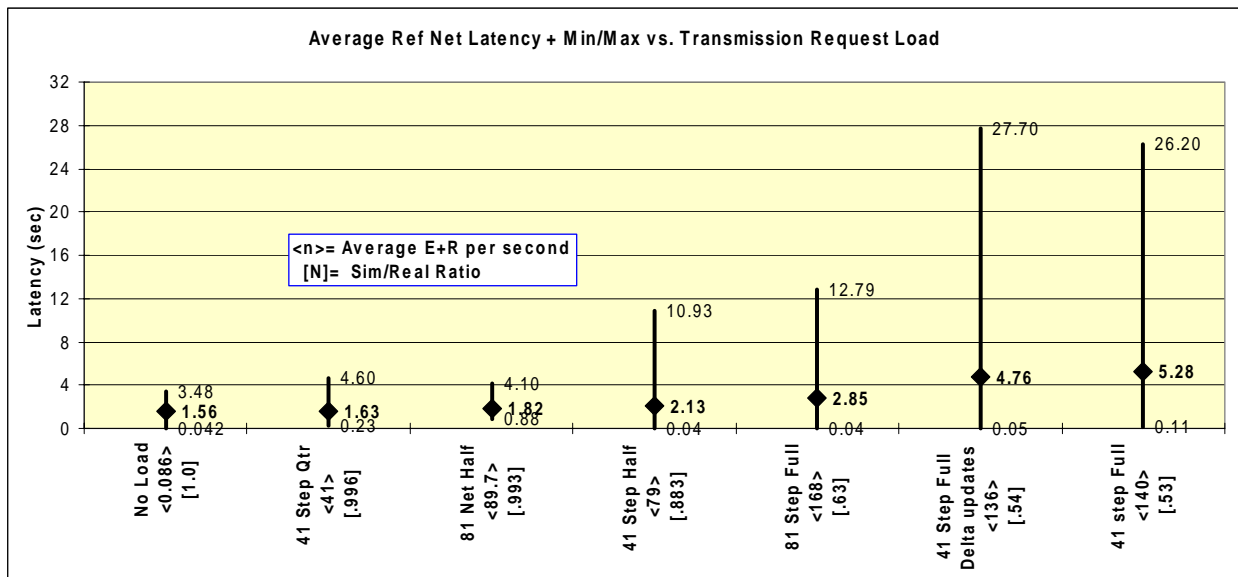


Figure 40 - Comparison of Ref Net Latency Across Load Runs

Table 15 and Table 16 shed some light on the measured differences. Each table lists the net sets within each net group and analyzes the number of stationary and moving sources within each net set. 82.5% of the sources in the 41 Net Group are moving compared to 60% of the sources in the 81 Net Group. In the 41 Net Group, 79% of the moving sources are *fast* movers, e.g., airborne platforms. In the 81 Net Group, 65% of the moving sources are fast movers. 65% of *all sources* in the 41 Net Group are fast movers, whereas only 38.8% of all sources in the 81 Net Group are fast movers. The tables also list the number of platform destinations in each net set, and total the destinations within each Net Group. The two Net Groups have roughly the same number of total destinations, 4080 for the 81 Net Group versus 3600 for the 41 Net Group. Since the 41 Net Group has a much higher percentage of moving sources, transmission requests will invoke FPPS calculations much more often than for the 81 Net Group.

Furthermore, when the scenario and nets for the 81 Net Group were designed, a high percentage of moving platforms were dropped to reduce the number of end-points in each net, many of these were F15s and F18s. Therefore, the 81 Net Group is more likely to have a higher percentage of stationary destinations, which will reduce propagation calculations further.

Table 15 - Analysis of 41 Net Group Sources

41 Net Group Sources					
Net Set	Stationary	Moving	Fast	Slow	# Dests per Net
PPLI_B No Relay	2	8	8	0	86
PPLI_B 1 Relay	1	9	8	1	86
MM No Relay	2	8	5	3	94
MM 1 Relay	2	8	5	3	94
<b>Totals</b>	<b>7</b>	<b>33</b>	<b>26</b>	<b>7</b>	<b>3600</b>
% of Total	17.5%	82.5%	65.0%	17.5%	
	% of Movers		79%	21%	

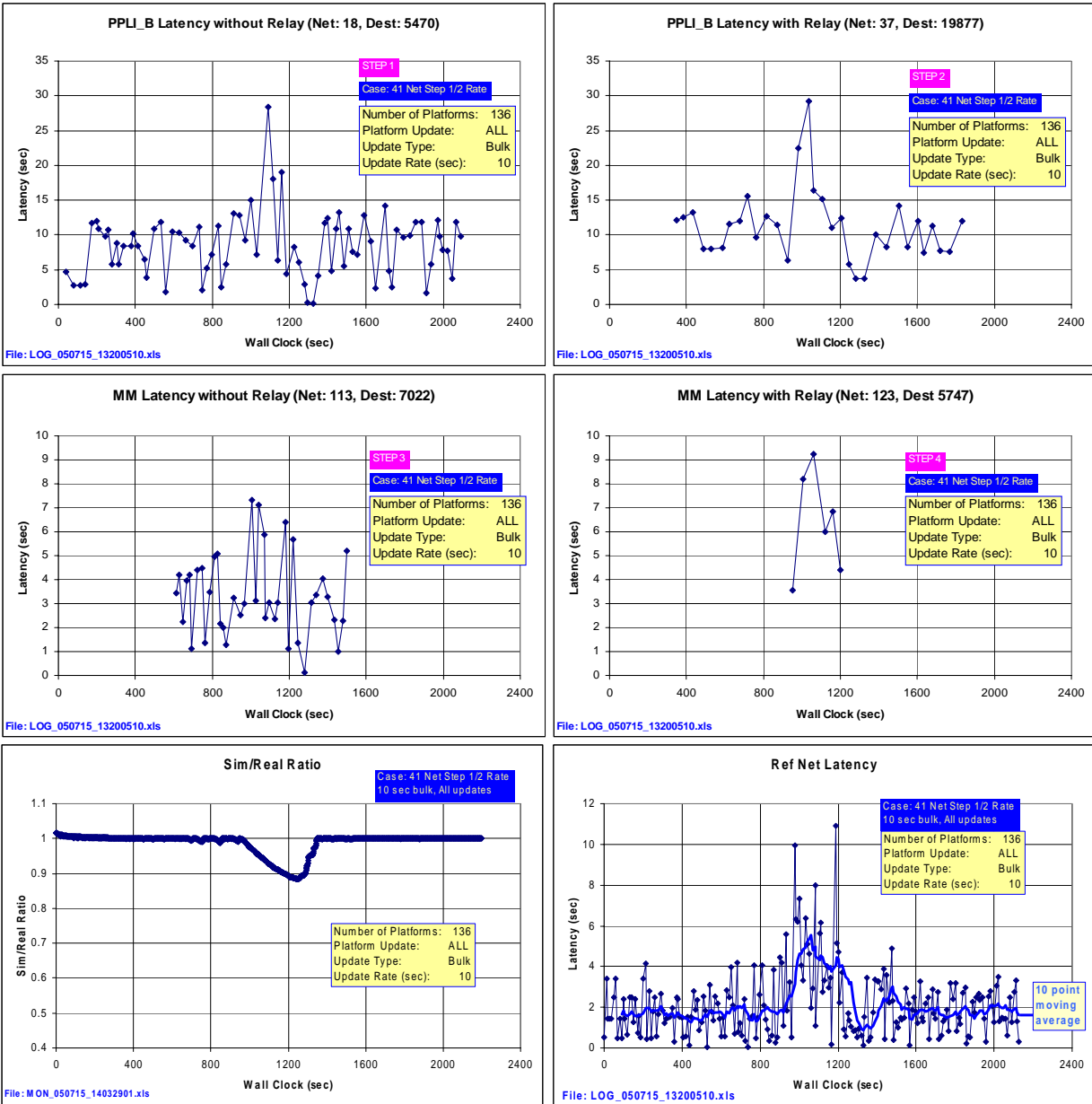
Table 16 - Analysis of 81 Net Group Sources

81 Net Group Sources					
Net Set	Stationary	Moving	Fast	Slow	# Dests per Net
PPLI_B No Relay	13	7	5	2	56
PPLI_B 1 Relay	3	17	12	5	48-56
MM No Relay	14	6	6	0	48
MM 1 Relay	2	18	8	10	48
<b>Totals</b>	<b>32</b>	<b>48</b>	<b>31</b>	<b>17</b>	<b>4080</b>
% of Total	40.0%	60.0%	38.8%	21.3%	
	% of Movers		65%	35%	

Also consider that the request rate for nets with 1 relay is half that for nets with no relays. In the 41 Net Group, all net sets have approximately the same number of moving sources for nets with and without relays. On the other hand, 81 Net Group sources without relays have half as many movers than sources with relays. This implies that transmissions on the relay nets in the 81 Net Group will likely be higher loads.

These observations begin to explain some of the differences observed in the cross-run comparisons and the results charted in Figure 40. The analyses begin to suggest the possibility of using the experiment data to “predict” loading for different scenarios and net designs being driven by specific patterns of transmission requests. While tantalizing, this is outside the scope of this experimentation task.

The charts that follow complete this portion of the cross run analysis. Figure presents latency data for selected net in the 41 Net Step Half Rate run. Latencies are shown side-by-side for the PPLI\_B and Mission Management (MM) nets with no relay and those that have 1 relay. At the bottom of the figure, the SSR and Ref Net latency charts are shown for reference. The 41 Net Step Half Rate case is a moderate load on the Main Test PC; the SRR falls to slightly less than 0.9 for less than 400 seconds during the peak load within this loading case. The top four charts in Figure correspond to Steps 1, 2, 3 and 4 of the stepped load run. The right-hand charts show latency for a relayed destination, e.g., reached by a relayed transmission. The left-hand charts show latency for direct transmission from sources to destinations.



**Figure 41 – Comparison of Selected Results for 41 Net Step Half-Rate Load**

Notice that the Mission Management nets have lower latency. This is because they have higher throughput than the PPLI\_B nets. The latencies for all the nets shown are good with variations that are within reasonable limits.

The next set of charts is for the 41 Net Step Full Rate case. These charts are shown in Figure 42 and are formatted as described for the 41 Net Step Half Rate case in Figure 41. The immediate observation for this case is that the processor is loaded to the point where latency is clearly too long by a huge factor. The next observation is that there is a dramatic difference between the

lower throughput PPLI\_B nets and the higher throughput Mission Management nets. Latency varies by a factor of amount 10 between these net types. Also, for this load case, the relay nets show a lower latency. Since the SRR drops to less than 0.5 for over 80% of the run, this load is clearly unreasonable.

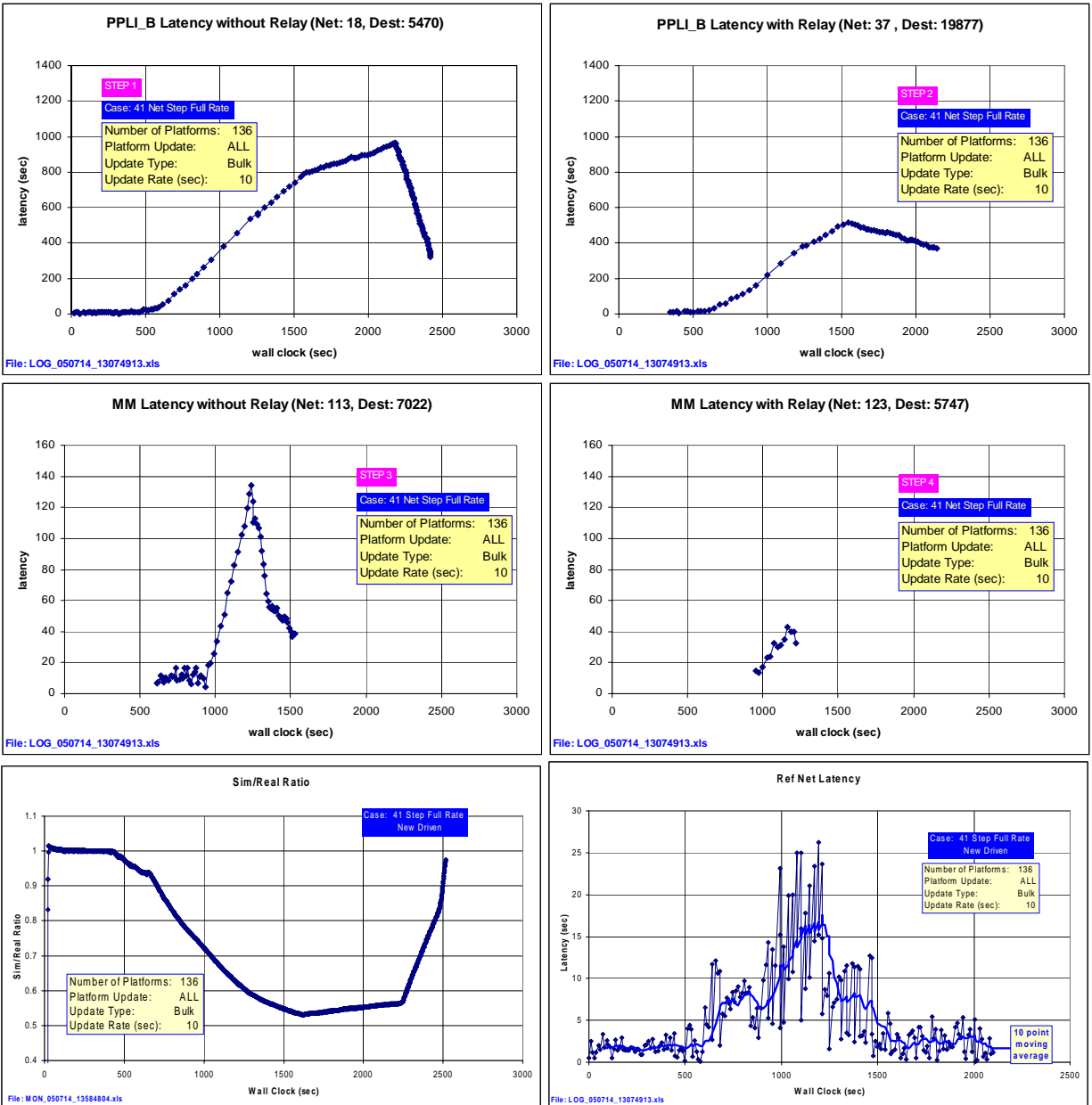


Figure 42 – Comparison of Selected Results for 41 Step Full Rate Load

## 8.4 Position Update Sensitivity Analysis

To evaluate the sensitivity of loading to position update rates, we performed a total of eight load runs as detailed in Table 13 in Section 7.0. The 41 Net Step Half-Rate load was chosen as a “moderate” load, and the 81 Net Step Full-Rate was chosen as a “high” load. We initially drove each request load case with position update rates of 14, 10 and 6 seconds. The 10-second rate is our standard rate, and the other rates are 40% higher and lower. After comparing SRR results across the runs, we decided to perform two more runs on the 41 Net case, one at a rate of 8 seconds and another at a faster rate of 2 seconds. We decided to do no further update rate tests on the 81 Net case because the 81 Net load was too high.

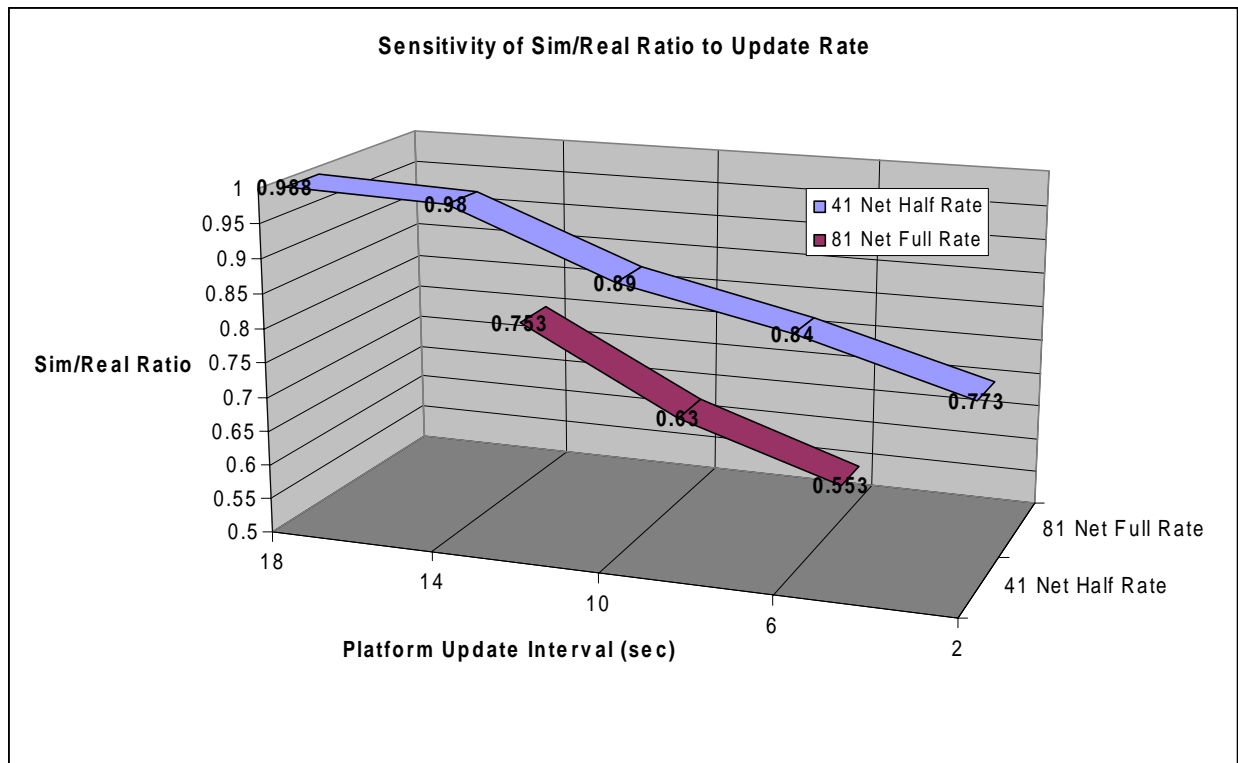


Figure 43 - Sensitivity to Position Update Rate

The results of the sensitivity runs are shown in Figure 43. For the 41 Net Step Half Rate case, there is very little difference between the 14s and 18s update rate. This seems reasonable since the lower update rate (longer interval) will induce fewer FPPS calculation. Similar results are expected for much higher update rates since updates between transmission requests should not increase the FPPS load on the system. This is not apparent in the figure, although there is a hint of this for the 41 Net Full Rate case. The higher sensitivity of the 81 Net Full Rate case to position update rate is a little surprising. We suspect that high load on the system for this case makes this load case more sensitive to the update rate. We feel that any load that drives the SRR to below 0.8 should be avoided.

## 8.5 Cross-PC Run Analysis

Data for the cross-PC runs was shown in Table 14 in Section 7.0. Five additional load experiments were performed to gather data to analyze; two runs were completed on the Test Laptop, and three runs were done on the Custom PC. The SRR for these runs is compared in Figure 44.

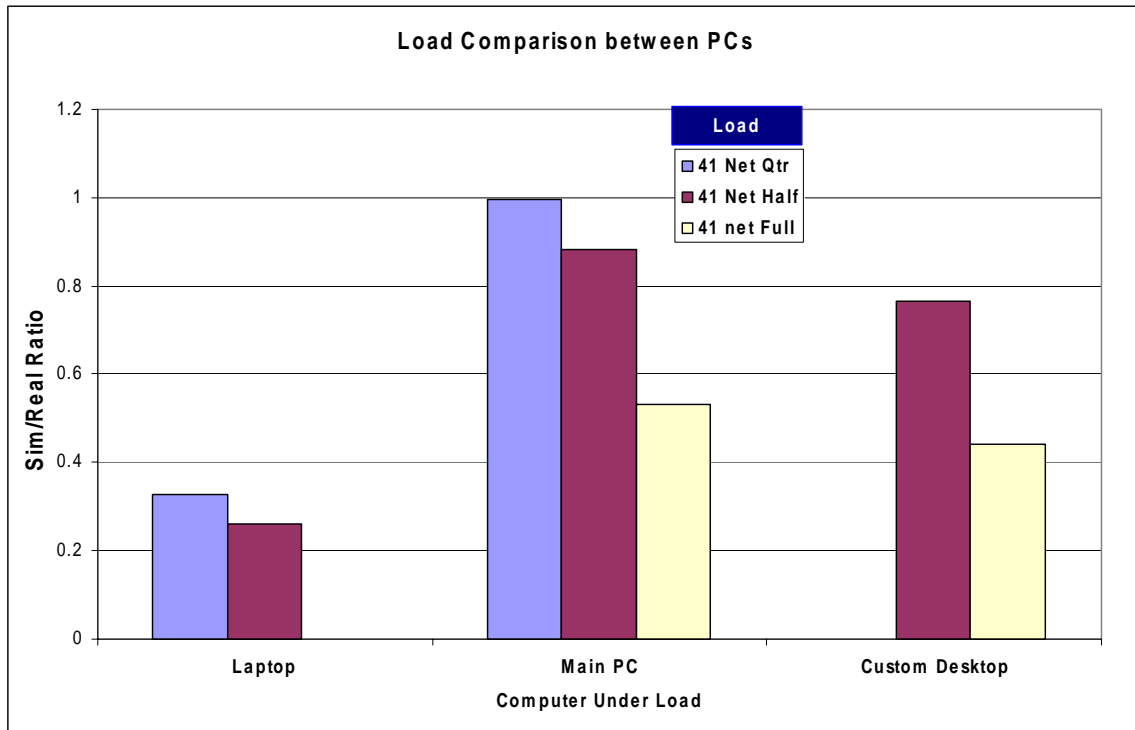


Figure 44 - Comparison of Sim/Real Ratio in Cross-PC Experiments

Only the 41 Net Step Quarter and Half rate runs were completed on the Test Laptop with unacceptable results. This Laptop PC is an old 850 MHz P3 machine with only 256 MB of RAM. Attempts to run the 41 Net Step Full rate were aborted due to excessive time and abysmal SRR.

The comparison between the Main Test PC and the Custom Desktop PC is more interesting. The Main Test PC is a Dell Desktop that is less than a year old and has a 2.8 GHz P4 with 1 GB RAM running Windows XP Pro SP2. The Custom Desktop is over two years old and is a 3 GHz P4 machine with 2 GB RAM running Windows 2K SP4. We believe that two factors account for the differences in loading between these PCs: 1) machine age – we suspect that the newer machine has a higher speed memory bus, and 2) XP versus 2K. PSI has seen a slight PC performance edge in Windows XP Pro over Windows 2K. The additional memory in the Custom PC apparently did not make a difference compared to other factors. Also, although an attempt was made to close all applications loaded into the Windows desktop tray after re-booting, there may have been some drivers consuming sources in the Custom PC.

Note that the Custom PC has a much higher resolution screen and a high-end graphics card. Since there was a possibility that screen resolution could be a factor, we re-prepared the JTIDS simulation for operation in Hardware Graphics Mode (HWG). This mode of operation made essentially no difference in measured SRR. Note that the 41 Net Step Full rate run with HWG was aborted since there was no apparent difference with respect to the non-hardware graphics mode.

## 8.6 Long Stability Run

There is a distinct chance that the JTIDS simulation could be used to support JSAF and other similar large forces simulations over an extended period of time. Therefore, we decided to run an experiment for an extended period of 10 hours. All prior runs were no longer than 60 minutes, and most runs were less than 40 minutes. We drove traffic requests to all 41 nets in the 41 Net Group at half rate while sending position updates every 10 seconds.

After 10 hours the long run was manually ended. Over 500,000 position updates were sent to the system, and over 46,000 transmission requests were sent. The long run was an excellent test of the stability of the GIESim JTID Simulation. This is the first time that the simulation was left running this long or had this much traffic sent through it. Our conclusion is that there are neither apparent memory leaks nor other accumulating errors in the simulation, and that the GIESim JTIDS simulation should run much longer.

## 8.7 Message Loss Analysis

For each of the load runs we computed the difference between the requests sent and the responses received. The difference is considered a loss of messages. In general we attempted to design the networks and chose destinations for transmission such that network connectivity should always be good. However, the run time of the original Korona scenario was about 20 minutes, after which platforms loop back on their movement paths. After a few movement cycles, the original synchronization between moving platforms is lost. While this should not introduce any operational errors, the scenario dynamics are different and there is a possibility of platforms being out of position with respect to the initial scenario.

Across *all* experiments, the message loss was generally less than 2%. The overloaded laptop lost 3% of messages. 6% of messages were lost in the long run. Overall, we believe these are very reasonable loss numbers.

## 9.0 Future Work Possibilities

During any experiment, observations arise that can suggest other possibilities for work and potential modifications and enhancements of tools and experimental design. This section briefly captures these ideas for future consideration.

- **All Destination Address:** The original planning and design for GIESim/JSAF interoperability considered the idea of using a destination address of zero to signify that all receivers of the message should respond. Some of the code was put into JTIDS to support this, and the GIESim/JSAF team never exploited the capability because of the high volume of HLA response traffic possible, and because we never identified an operational case that called for this feature.
- **Other Access Modes:** Link-16 radios support Dedicated, Contention and Dedicated Slot Re-use Access Modes. The JTIDS simulation supports these modes in addition to new modes developed by PSI. The GIESim version of JTIDS also supports these modes although they have not been extensively tested, and only the Dedicated Access Mode was used during experimentation.
- **Use of SAR:** The GIESim JTIDS Simulation supports Segmentation and Re-assembly (SAR) of messages that will not fit into the capacity of an operational net. SAR complicates loading since extra messages are generated that are not included in the existing metrics. SAR was not tested during experimentation.
- **SRR Request/Response:** Since the Sim/Real ratio (SRR) is a critically important load factor; the existing GIESim HLA interactions could be used with special parameters to request a response that contains the current SRR.
- **More Complex Networks:** For some applications with JSAF and similar simulations more complex networks with more relays may be required. PSI performed two experiments on the original Korona networks that had 12+ relays. We decided to scrap this data due to the extremely high SRR incurred and extensive latency and message delays. We think that operational nets should use no more than 3-4 relays. Load experiments on nets with 2, 3 and 4 relays would provide more data for sizing potential operations with JSAF, etc.
- **Machine Synchronization Messages:** During experimentation we frequently waited for the GIESim JTIDS simulation to initialize before we started our load generators and recorders. The same coordination is needed in operation with JSAF and other large forces simulations. The idea developed to use existing GIESim HLA interactions with specific parameters to trigger the start of other simulations and to synchronize them. To some extent this has been used in the past, and could be extended to our newer tools, such as the HLA Recorder.
- **HLA Time Management:** As the size and complexity of scenarios and networks increase, a point will be reached where any one computer will not be able to attain sufficient SSR to achieve required accuracy. We may want to consider introduction of some form of cross

simulation time management to keep the simulation clocks closely aligned. Of course this would drop both JSAF and JTIDS out of the realm of real time operation if message traffic were very high. This would require sizable modification of JTIDS.

- **Update Filtering:** The option to filter updates that do not change position locations would eliminate some computation overhead associated with updating the platform and link databases in JTIDS. This would be an easy change to JTIDS.
- **High Performance Computers:** Higher load conditions will require higher performance computers. Possibilities include new dual-core PCs, near-term multi-core PCs, and Massively Parallel Processor (MPP) machines. The latter is preferred because of the likely need to support large scenarios and high network traffic. Based on the eventual need to run very large JTIDS simulations very fast, and the fact that the platforms within the simulation are coupled due to their potential interactions in a shared electromagnetic space, PSI has concluded that the most effective processing solution is a single-OS MPP machine with shared memory.

Processing requirements analysis done on another project determined that a single, very large simulation could not run on a single PC and meet the desired response requirements. Alternatives that are potentially available include:

- **Beowulf clusters:** Beowulf clusters are potentially good for simulations of very loosely coupled systems. For simulations that have a potentially high degree of coupling however (not embarrassingly parallel), such as the simulation of a MTN, the inter-processor network latency becomes a major limitation due to the number of messages that must be exchanged to synchronize the simulation state – particularly of the electromagnetic environment.
- **HLA or DIS Distributed Computing Environment:** HLA and DIS are typically used to interconnect disparate simulations. The distance/intercommunication loss for an HLA/DIS approach is estimated to be 10 to 100 greater than for a Beowulf cluster. While HLA is acceptable between JSAF and JTIDS, it is much too slow to couple multiple computers aggregated to support computation of JTIDS networking.
- **MPP machine:** In a massively parallel processor supercomputer with a single-OS, inter-process communication can be exceptionally fast, and shared memory architectures can support an essentially common electromagnetic environment. Furthermore, GSS can make much better use of parallel threads (p-threads) on an MPP machine. PSI has met with several parallel processing companies to further its support for parallel processing in GSS simulations. Several companies including IBM and SGI have found the approach to building software, e.g., simulations, for parallel processing created by PSI to be highly effective, a very good fit for the MPP hardware, and one that they think is on the leading edge. Of the MPP machines that PSI has looked at, the SGI machines seem to be an excellent first choice for JTIDS Planning and Validation. PSI is currently in favor of the SGI Altix 3000 family of super computers. These computers have a hardware architecture that is optimal for the type of computing required for JTIDS networking.

## 10.0 Conclusions

Our overarching conclusion is that the Sim/Real ratio (SRR) is the best indicator of system load on the GIESim JTIDS simulation. Scenario sizes on the order of 136 Link-16 platforms can easily be supported and external position update rates of every 10 seconds are acceptable, which is typical of what is expected from JSAF. The GIESim JTIDS simulation can be used for experiments of extended duration of many hours.

Network loading is more complex and less predictable than originally anticipated and is highly scenario dependent. Generally, SRR should be 0.8 or higher for the majority of experimentation on a machine of comparable performance to our Main Test PC. For networks of the size and complexity of our Net Groups used in testing, average request rates on any one operational net should be much less than half (preferably a quarter) of the response time or throughput for the net.

After analysis of experimentation results, and in retrospect, we believe the set of steady request rates that we used were higher than would typically be experienced in Command and Control (C2) operations, which are more likely to be more bursty. C2 operations are the primary focus of GIESim/JSAF. An exception to this may be in the handling of surveillance traffic where high volumes of track data may be exchanged, which implies a potential high request rate on high throughput nets. As experience with JSAF unfolds, additional experimentation may be identified.

Because positions updates and transmission requests are happening in real time, the need to keep SRR high is very important. As SRR drops much below 0.9, both transmission latency and position accuracy at the time of transmission become more and more inaccurate. The chart shown in Figure 45 provides an overview of these relationships.

Platform Speeds	Fast	Moderate Position Good Latency	Poor Position Moderate Latency	Bad Position Poor Latency
	Mod	Good Position Good Latency	Fair Position Moderate Latency	Poor Position Excess Latency
	Slow	Good Position Good Latency	Moderate Position Moderate Latency	Fair Position Excess Latency
	Fixed	Good Position Good Latency	Good Position Moderate Latency	Good Position Excess Latency
		Correct Latency	Moderately Increased Latency	Much Longer Latency
		Low Load	Moderate Load	High Load
		System Response Time (Latency)		

Figure 45 - Relationships of Position Accuracy and Latency versus System Load

Additional conclusions are listed below:

- The experimentation load test configuration can be used to assess support and capacity for planned interoperability runs with JSAF:
  - Use the Link-16 Planning Tool to design nets and scenarios of anticipated complexity.
  - Use the test configuration to exercise the planned operation.
- During live operations with JSAF, the JTIDS Sim Clock display and dynamic Sim/Real ratio display can be used to assess performance of JTIDS. The JTIDS Monitor and HLA Recorder can be used to collect data for post analysis following an operation.
- Any anomalous behaviors between JSAF and JTIDS can be explored by playing back recorded HLA traffic of ENTITY\_STATE and MSG\_SEND messages into JTIDS to search for root causes that could include:
  - JTIDS or JSAF operational problem
  - Real time slips in either JSAF or JTIDS
  - Potential network design issues, or incorrect operational use of (or expectations of) operational nets.

To a very large extent the GIESim experimentation work was highly interesting, challenging and thought provoking. Preliminary experiments lead to refinements of GIESim JTIDS that make it more robust and much more efficient for operational use. These early experiments also lead to much more powerful and effective test tools for use with GIESim JTIDS and JSAF. Over 26 hours of final experimentation has resulted in the collection of over 100 MB of data that can still be mined for additional information. The process of designing, executing and analyzing the experiments has lead to much deeper insights into GIESim JTIDS and operational considerations for use with JSAF and other similar simulations.

PSI deeply appreciates the GIESim leadership team in AFRL Rome, NY for this opportunity to experiment with GIESim JTIDS. We sincerely hope that GIESim JTIDS will be applied to further operations with JSAF and with the JSB-RD team in Rome and with USJFCOM J9. PSI is committed to the success of the GIESim Laboratory and looks forward to an on-going relationship with AFRL and the other GIESim/JSB-RD team members in Rome.

## 11.0 References

1. “Technical Challenges and Solutions in Merging GIESim JTIDS and JSAF”, J. Fikus, et. al., SPIE Defense & Security Symposium 28 Mar – 1 Apr, 2005.
2. “GIESim Briefing and Demonstration Report to AFRL”, Prediction Systems, Inc., 6 April 2005.
3. “Overview of PSI’s Basic Korona Scenario”, Oct 2004, Prediction Systems, Inc., Wall NJ.

# Appendix A – Test Networks

## A.1: 41 Net Group Details

Table 17 - 41 Net Set Groups

Test Set	Net ID	Net Type	Source	# Dest's	# Relay	Resp Time (sec)	TJ	Words per Msg	Msgs per unit time	Unit of Time	Packing	Target Destinations		
												D1	D2 Relay Dest	Relay
Ref Net	162	REF_NET	GH_REF_SRC	1	0	10	J15	4	12	12	P4	GH_REF_DEST		
Set 1 KORONA_REF_RELAY.NET	16	PPLI_B	ABRLY_2_1	86	0	10	J2/13	6	1	12	P2DP	ABRLY_3_1		
	17	PPLI_B	ABRLY_2_2	86	0	10	J2/13	6	1	12	P2DP	JSTARS_2_1		
	18	PPLI_B	ABRLY_2_3	86	0	10	J2/13	6	1	12	P2DP	E3_2_4		
	33	PPLI_B	E3_2_1	86	0	10	J2/13	6	1	12	P2DP	ABL_2_2		
	34	PPLI_B	E3_2_2	86	0	10	J2/13	6	1	12	P2DP	JLENS_2_2		
	35	PPLI_B	E3_2_3	86	0	10	J2/13	6	1	12	P2DP	GHAWK_2_9		
	107	PPLI_B	E2C_3_1	94	0	10	J2/13	6	1	12	P2DP	F15F_2_5		
	108	PPLI_B	E2C_3_2	94	0	10	J2/13	6	1	12	P2DP	E2C_3_3		
	76	PPLI_B	THAADTOC_2_3	86	0	10	J2/13	6	1	12	P2DP	ABRLY_3_1		
	77	PPLI_B	THAADTOC_2_4	86	0	10	J2/13	6	1	12	P2DP	ABRLY_2_1		
Set 2 - 1 Relay Each KORONA_REF_RELAY.NET	109	PPLI_B	E2C_3_3	94	1	10	J2/13	6	1	12	P2DP		E2C_1_2	ABRLY_3_1
	110	PPLI_B	E2C_3_4	94	1	10	J2/12	6	1	12	P2DP		SHIP_2_1	ABRLY_2_3
	111	PPLI_B	EP3_3_1	94	1	10	J2/13	6	1	12	P2DP		SHIP_3_7	E3_2_2
	36	PPLI_B	E3_2_4	86	1	10	J2/13	6	1	12	P2DP		GHAWK_2_11	GHAWK_2_10
	37	PPLI_B	RJ_2_1	86	1	10	J2/13	6	1	12	P2DP		SHIP_3_1	GHAWK_2_9@
	38	PPLI_B	RJ_2_2	86	1	10	J2/13	6	1	12	P2DP		SHIP_3_2	E2C_3_3@
	39	PPLI_B	JSTARS_2_1	86	1	10	J2/13	6	1	12	P2DP		SHIP_3_11	E2C_3_3@
	130	PPLI_B	E2C_1_1	95	1	10	J2/13	6	1	12	P2DP		E2C_3_2	GHAWK_2_10@ (N)
	74	PPLI_B	THAADTOC_2_1	86	1	10	J2/13	6	1	12	P2DP		SHIP_1_3	ABRLY_2_2
	136	PPLI_B	SHIP_3_1	86	1	10	J2/13	6	1	12	P2DP		JTAGS_2_3	ABRLY_2_1 (B)
Set 3 - No Relays KORONA_REF_RELAY.NET	112	MISSION_MGT	E2C_3_1	94	0	10	J9/10	4	6	12	P2DP	THAADTOC_2_3		
	113	MISSION_MGT	E2C_3_2	79	0	10	J9/10	4	6	12	P2DP	F18_1_6		
	114	MISSION_MGT	E2C_3_3	94	0	10	J9/10	4	6	12	P2DP	SHIP_3_7		
	115	MISSION_MGT	E2C_3_4	94	0	10	J9/10	4	6	12	P2DP	SHIP_3_1		
	101	MISSION_MGT	SHORAD_2_1	94	0	10	J9/10	4	6	12	P2DP	JLENS_2_2		
	119	MISSION_MGT	SHIP_1_1	94	0	10	J9/10	4	6	12	P2DP	E2C_1_1		
	137	MISSION_MGT	SHIP_3_1	94	0	10	J9/10	4	6	12	P2DP	E2C_3_2		
	91	MISSION_MGT	JSTARS_2_1	94	0	10	J9/10	4	6	12	P2DP	RJ_2_2		
	125	MISSION_MGT	SHIP_1_4	94	0	10	J9/10	4	6	12	P2DP	PATRIOTICC_2_4		
	85	MISSION_MGT	PATRIOTICC_2_4	94	0	10	J9/10	4	6	12	P2DP	E3_2_1		
Set 4 - 1 Relay Each KORONA_REF_RELAY.NET	28	MISSION_MGT	SHIP_3_2	94	1	10	J9/10	4	6	12	P2DP		PATRIOTICC_2_3@	E2C_3_4 (B)
	89	MISSION_MGT	E3_2_3	94	1	10	J9/10	4	6	12	P2DP		JTAGS_2_4@	ABRLY_2_1 (B)
	92	MISSION_MGT	JSTARS_2_2	94	1	10	J9/10	4	6	12	P2DP		JTAGS_2_3@	ABRLY_2_1 (B)
	96	MISSION_MGT	ABL_2_4	94	1	10	J9/10	3	8	12	P2DP		SHIP_3_1@	E2C_3_4 (B)
	104	MISSION_MGT	THAADTOC_2_3	94	1	10	J9/10	4	6	12	P2DP		JTAGS_2_2@	ABRLY_2_1 (B)
	121	MISSION_MGT	SHIP_1_2	94	1	10	J9/10	4	6	12	P2DP		PATRIOTICC_2_4@	E3_2_2 (B)
	133	MISSION_MGT	E2C_1_2	94	1	10	J9/10	4	6	12	P2DP		E2C_3_4@	E3_2_1 (B)
	123	MISSION_MGT	SHIP_1_3	94	1	10	J9/10	4	6	12	P2DP		ABIFC_1@	JSTARS_2_1 (B)
	95	MISSION_MGT	ABL_2_3	94	1	10	J9/10	3	8	12	P2DP		CAC2S_2_3@	ABRLY_2_1 (B)
	97	MISSION_MGT	CRC_2_1	94	1	10	J9/10	3	8	12	P2DP		RJ_2_1@	ABRLY_3_1 (B)

## A.2: 81 Net Group Details

Table 18 - 81 Net Set Groups - Part 1

Net Set	Net ID	Net Type	Source	# Dest's	# Relay	Resp Time (sec)	TJ	Words per Msg	Msgs per unit time	Unit of Time	Packing	Target Destinations		
												D1	D2 Relay Dest	Relay
Ref Net	100	REF_NET	GH_REF_SRC	1	0	10	J15	4	12	12	P4	GH_REF_DEST		
PPLI_B NO RELAY KORONA_HALF_REF.NET	37	PPLI_B	ABL_2_4	56	0	10	J2/13	6	1	12	P2DP	SHORAD_2_2		
	45	PPLI_B	ABIFC_1	56	0	10	J2/13	6	1	12	P2DP	UAV_GND_2_1		
	46	PPLI_B	ABIFC_2	56	0	10	J2/13	6	1	12	P2DP	PATRIOTICC_2_4		
	47	PPLI_B	CRC_2_1	56	0	10	J2/13	6	1	12	P2DP	ABRLY_3_1		
	48	PPLI_B	CRC_2_2	56	0	10	J2/13	6	1	12	P2DP	E2C_3_3		
	49	PPLI_B	TAOM_2_1	56	0	10	J2/13	6	1	12	P2DP	ABRLY_1_1		
	50	PPLI_B	TAOM_2_2	56	0	10	J2/13	6	1	12	P2DP	RJ_2_2		
	51	PPLI_B	CAC2S_2_1	56	0	10	J2/13	6	1	12	P2DP	E2C_3_1		
	52	PPLI_B	CAC2S_2_2	56	0	10	J2/13	6	1	12	P2DP	ABRLY_2_1		
	53	PPLI_B	CAC2S_2_3	56	0	10	J2/13	6	1	12	P2DP	E2C_3_2		
	54	PPLI_B	SHORAD_2_1	56	0	10	J2/13	6	1	12	P2DP	GHAWK_2_3		
	55	PPLI_B	SHORAD_2_2	56	0	10	J2/13	6	1	12	P2DP	ABL_2_4		
	57	PPLI_B	THAADTOC_2_2	56	0	10	J2/13	6	1	12	P2DP	ABRLY_2_2		
	58	PPLI_B	PATRIOTICC_2_3	56	0	10	J2/13	6	1	12	P2DP	E2C_3_4		
	59	PPLI_B	PATRIOTICC_2_4	56	0	10	J2/13	6	1	12	P2DP	EP3_3_1		
	12	PPLI_B	SHIP_2_1	56	0	10	J2/13	6	1	12	P2DP	PATRIOTICC_2_4		
	62	PPLI_B	UAV_GND_2_1	56	0	10	J2/13	6	1	12	P2DP	ABIFC_2		
14	PPLI_B	ABRLY_2_1	56	0	10	J2/13	6	1	12	P2DP	JTAGS_2_2			
16	PPLI_B	ABRLY_2_3	56	0	10	J2/13	6	1	12	P2DP	THAADTOC_2_1			
17	PPLI_B	SHIP_3_2	48	0	10	J2/13	6	1	12	P2DP	E3_2_3			
PPLI_B RELAY KORONA_HALF_REF.NET	18	PPLI_B	SHIP_3_4	48	1	10	J2/13	6	1	12	P2DP		JTAGS_2_3	ABRLY_2_1
	20	PPLI_B	SHIP_3_7	48	1	10	J2/13	6	1	12	P2DP		TAOM_2_2	RJ_2_2
	21	PPLI_B	SHIP_3_11	48	1	10	J2/13	6	1	12	P2DP		JTAGS_2_4	E2C_3_2
	22	PPLI_B	JTAGS_2_2	56	1	10	J2/13	6	1	12	P2DP		CRC_2_1	GHAWK_2_10
	23	PPLI_B	JTAGS_2_3	56	1	10	J2/13	6	1	12	P2DP		SHIP_1_1	E3_2_1
	77	PPLI_B	E2C_3_1	48	1	10	J2/13	6	1	12	P2DP		SHIP_1_1	ABIFC_2
	79	PPLI_B	E2C_3_3	48	1	10	J2/13	6	1	12	P2DP		E2C_1_2	ABRLY_3_1
	80	PPLI_B	E2C_3_4	48	1	10	J2/13	6	1	12	P2DP		SHIP_2_1	ABRLY_2_3
	81	PPLI_B	EP3_3_1	48	1	10	J2/13	6	1	12	P2DP		AIRCAV_1	E3_2_1
	35	PPLI_B	JSTARS_2_2	56	1	10	J2/13	6	1	12	P2DP		SHIP_3_2	E3_2_3
	36	PPLI_B	ABL_2_1	56	1	10	J2/13	6	1	12	P2DP		CAC2S_2_3	GHAWK_2_9
	88	PPLI_B	SHIP_1_1	56	1	10	J2/13	6	1	12	P2DP		CRC_2_2	ABRLY_2_2
	90	PPLI_B	SHIP_1_2	48	1	10	J2/13	6	1	12	P2DP		TAOM_2_1	ABRLY_1_1
	33	PPLI_B	RJ_2_1	56	1	10	J2/13	6	1	12	P2DP		SHIP_3_1	GHAWK_2_9
	34	PPLI_B	RJ_2_2	56	1	10	J2/13	6	1	12	P2DP		SHIP_3_2	E2C_3_3
	92	PPLI_B	E2C_1_1	49	1	10	J2/13	6	1	12	P2DP		E2C_3_2	GHAWK_2_10
	32	PPLI_B	E3_2_4	56	1	10	J2/13	6	1	12	P2DP		JTAGS_2_4	GHAWK_2_10
	94	PPLI_B	E2C_1_2	48	1	10	J2/13	6	1	12	P2DP		E2C_3_3	E3_2_3
	56	PPLI_B	THAADTOC_2_1	56	1	10	J2/13	6	1	12	P2DP		SHIP_1_2	ABRLY_2_2
38	PPLI_B	GHAWK_2_1	56	1	10	J2/13	6	1	12	P2DP		SHIP_3_4	E2C_3_1	

Table 19 - 81 Net Set Groups - Part 2

Net Set	Net ID	Net Type	Source	# Dest's	# Relay	Resp Time (sec)	TJ	Words per Msg	Msgs per unit time	Unit of Time	Packing	Target Destinations		
												D1	D2 Relay Dest	Relay
MISSION_MGT NO RELAY KORONA_HALF_REF-NET	60	MISSION_MGT	PATRIOTICC_2_3	48	0	10	J9/10	4	6	12	P2DP	E2C_3_4		
	60	MISSION_MGT	PATRIOTICC_2_3	48	0	10	J9/10	4	6	12	P2DP	RJ_2_2		
	61	MISSION_MGT	PATRIOTICC_2_4	48	0	10	J9/10	4	6	12	P2DP	E2C_1_1		
	61	MISSION_MGT	PATRIOTICC_2_4	48	0	10	J9/10	4	6	12	P2DP	ABRLY_1_1		
	63	MISSION_MGT	E3_2_1	48	0	10	J9/10	4	6	12	P2DP	ABRLY_2_3		
	63	MISSION_MGT	E3_2_1	48	0	10	J9/10	4	6	12	P2DP	ABRLY_2_2		
	65	MISSION_MGT	E3_2_4	48	0	10	J9/10	4	6	12	P2DP	PATRIOTICC_2_4		
	65	MISSION_MGT	E3_2_4	48	0	10	J9/10	4	6	12	P2DP	ABIFC_2		
	67	MISSION_MGT	ABL_2_1	48	0	10	J9/10	3	8	12	P2DP	THAADTOC_2_2		
	67	MISSION_MGT	ABL_2_1	48	0	10	J9/10	3	8	12	P2DP	RJ_2_2		
	70	MISSION_MGT	CRC_2_2	48	0	10	J9/10	3	8	12	P2DP	ABRLY_3_1		
	70	MISSION_MGT	CRC_2_2	48	0	10	J9/10	3	8	12	P2DP	ABIFC_1		
	71	MISSION_MGT	TAOM_2_1	48	0	10	J9/10	4	6	12	P2DP	ABRLY_2_2		
	71	MISSION_MGT	TAOM_2_1	48	0	10	J9/10	4	6	12	P2DP	RJ_2_1		
	72	MISSION_MGT	TAOM_2_2	48	0	10	J9/10	4	6	12	P2DP	ABL_2_4		
	72	MISSION_MGT	TAOM_2_2	48	0	10	J9/10	4	6	12	P2DP	E2C_3_1		
	74	MISSION_MGT	THAADTOC_2_1	48	0	10	J9/10	4	6	12	P2DP	ABRLY_2_3		
	74	MISSION_MGT	THAADTOC_2_1	48	0	10	J9/10	4	6	12	P2DP	RJ_2_1		
75	MISSION_MGT	THAADTOC_2_2	48	0	10	J9/10	4	6	12	P2DP	ABRLY_2_1			
75	MISSION_MGT	THAADTOC_2_2	48	0	10	J9/10	4	6	12	P2DP	E2C_3_4			
MISSION_MGT RELAY KORONA_HALF_REF-NET	64	MISSION_MGT	E3_2_3	48	1	10	J9/10	4	6	12	P2DP		JTAGS_2_4	ABRLY_2_1
	66	MISSION_MGT	JSTARS_2_2	48	1	10	J9/10	4	6	12	P2DP		JTAGS_2_3	ABRLY_2_1
	68	MISSION_MGT	ABL_2_4	48	1	10	J9/10	3	8	12	P2DP		SHIP_3_1	E2C_3_4
	69	MISSION_MGT	CRC_2_1	48	1	10	J9/10	3	8	12	P2DP		RJ_2_1	ABRLY_3_1
	73	MISSION_MGT	SHORAD_2_1	48	1	10	J9/10	4	6	12	P2DP		CAC2S_2_1	ABL_2_4
	82	MISSION_MGT	E2C_3_1	48	1	10	J9/10	4	6	12	P2DP		JTAGS_2_2	ABRLY_2_1
	83	MISSION_MGT	E2C_3_2	33	1	10	J9/10	4	6	12	P2DP		TAOM_2_2	ABIFC_1
	84	MISSION_MGT	E2C_3_3	48	1	10	J9/10	4	6	12	P2DP		E2C_1_1	RJ_2_2
	85	MISSION_MGT	E2C_3_4	48	1	10	J9/10	4	6	12	P2DP		TAOM_2_1	JSTARS_2_2
	89	MISSION_MGT	SHIP_1_1	48	1	10	J9/10	4	6	12	P2DP		CAC2S_2_2	ABRLY_2_2
	91	MISSION_MGT	SHIP_1_2	48	1	10	J9/10	4	6	12	P2DP		ABRLY_3_1	E2C_1_2
	93	MISSION_MGT	E2C_1_1	48	1	10	J9/10	4	6	12	P2DP		SHIP_3_1	E3_2_3
	95	MISSION_MGT	E2C_1_2	48	1	10	J9/10	4	6	12	P2DP		E2C_3_4	E3_2_1
	99	MISSION_MGT	SHIP_3_1	48	1	10	J9/10	4	6	12	P2DP		ABRLY_2_2	E2C_3_4
	99	MISSION_MGT	SHIP_3_11	48	1	10	J9/10	4	6	12	P2DP		JTAGS_2_4	E2C_3_2
	28	MISSION_MGT	SHIP_3_7	48	1	10	J9/10	4	6	12	P2DP		CRC_2_1	ABRLY_3_1
	27	MISSION_MGT	SHIP_3_6	48	1	10	J9/10	4	6	12	P2DP		CAC2S_2_3	ABRLY_2_1
	26	MISSION_MGT	SHIP_3_4	48	1	10	J9/10	4	6	12	P2DP		THAADTOC_2_2	ABIFC_1
25	MISSION_MGT	SHIP_3_2	48	1	10	J9/10	4	6	12	P2DP		PATRIOTICC_2_4	E2C_3_4	
13	MISSION_MGT	SHIP_2_1	48	1	10	J9/10	4	6	12	P2DP		RJ_2_2	EP3_3_1	

# Appendix B – Run Data

## B.1 Ref Net Only, and Position Updates every 10 sec (Main PC)

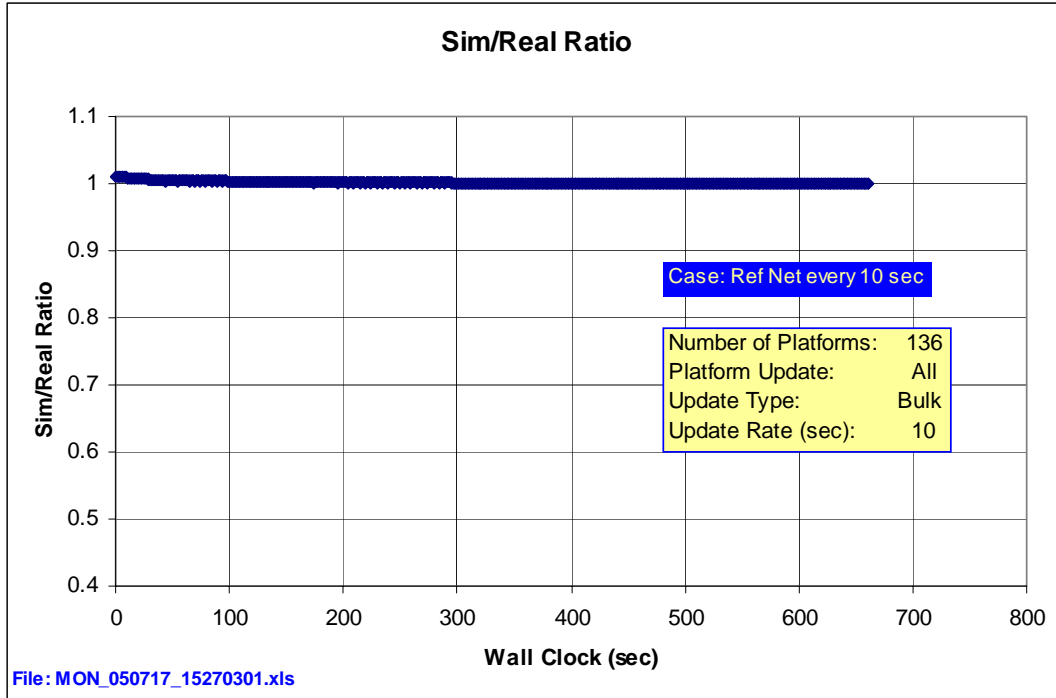


Figure 46 – Ref Net Only Sim/Real Ratio

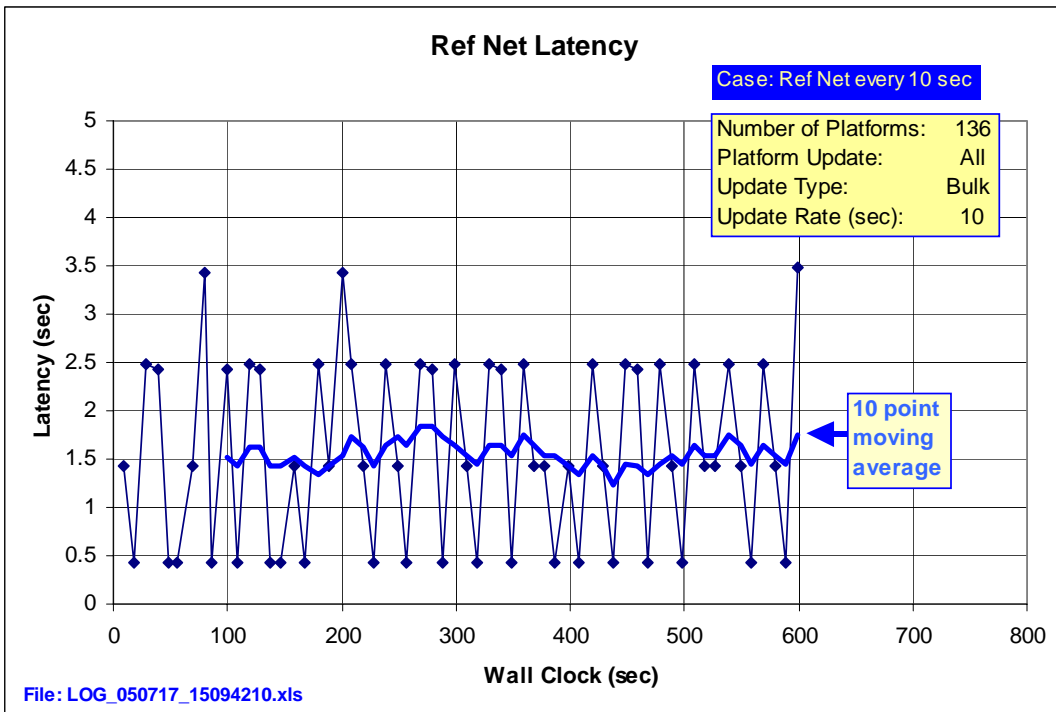
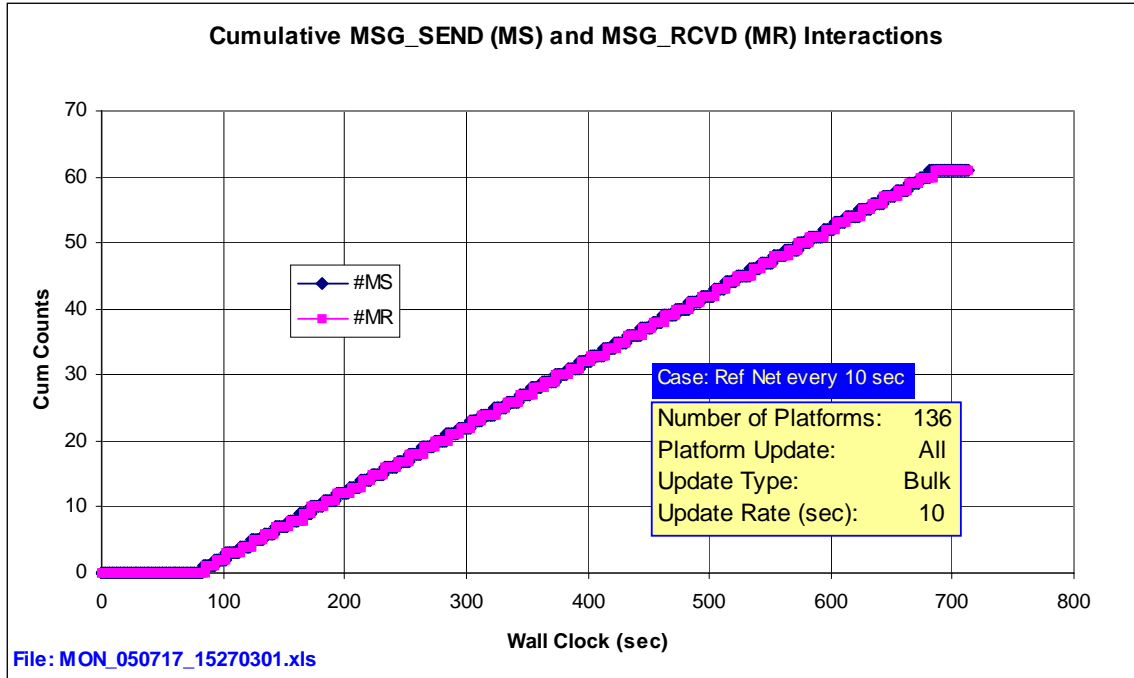
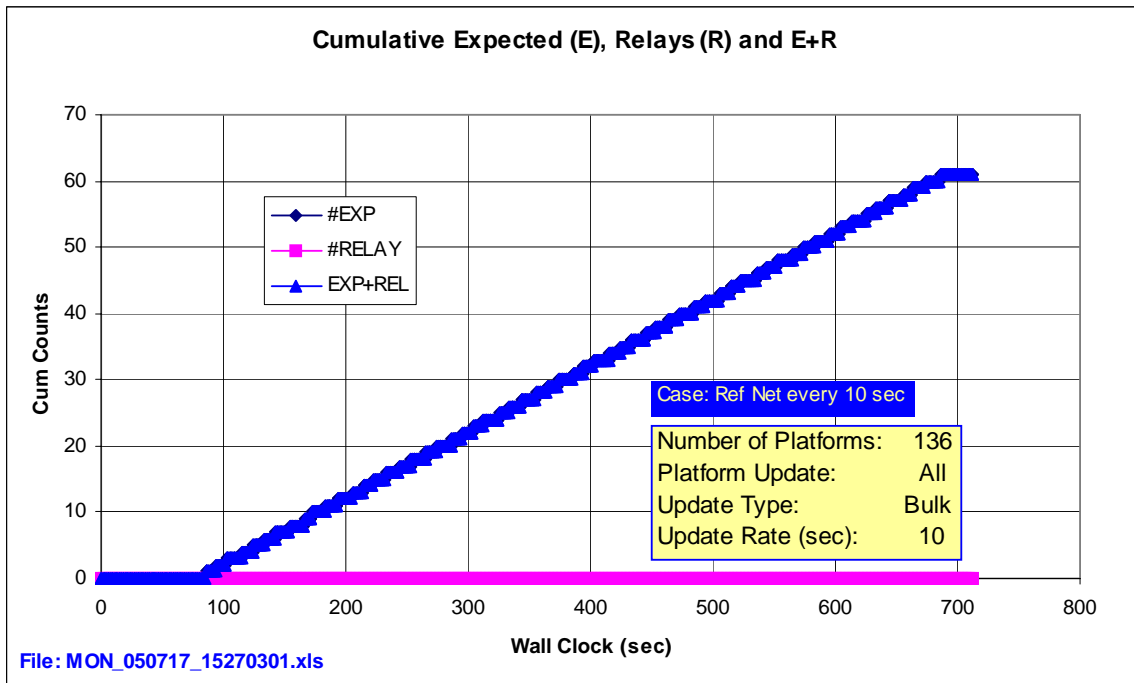


Figure 47 – Ref Net Only Ref Net Latency



**Figure 48 – Ref Net Only Cumulative MS and MR Interactions**



**Figure 49 – Ref Net Only E, R, and E+R**

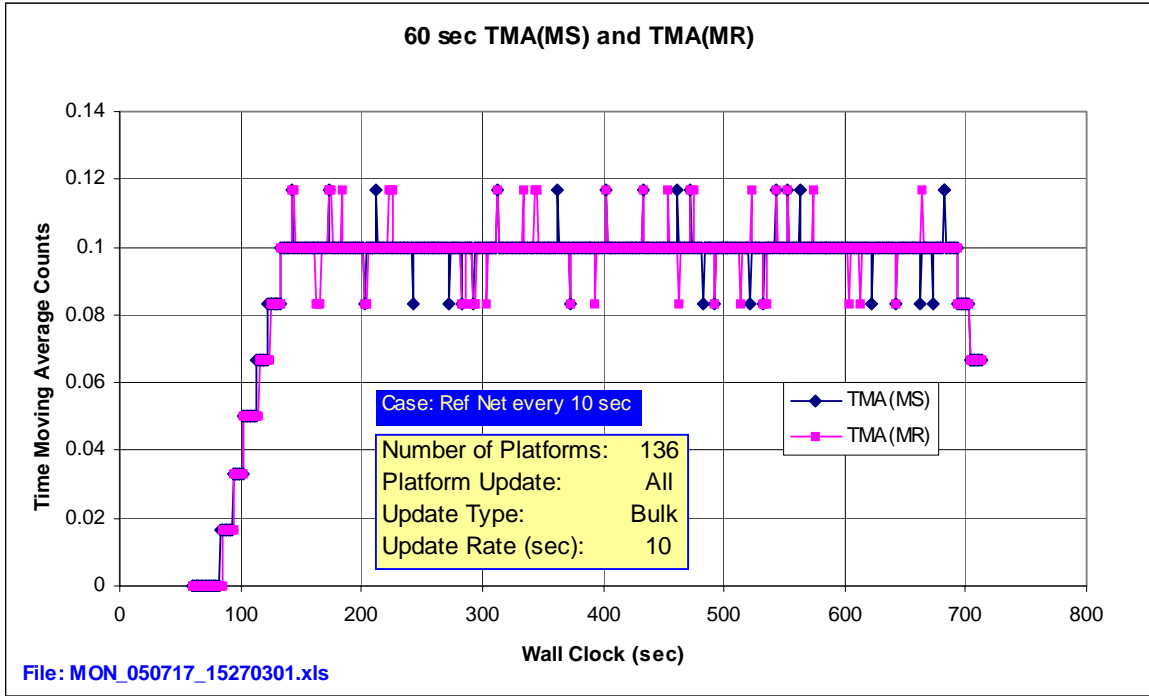


Figure 50 – Ref Net Only 60 sec TMA (MS) and TMA (MR)

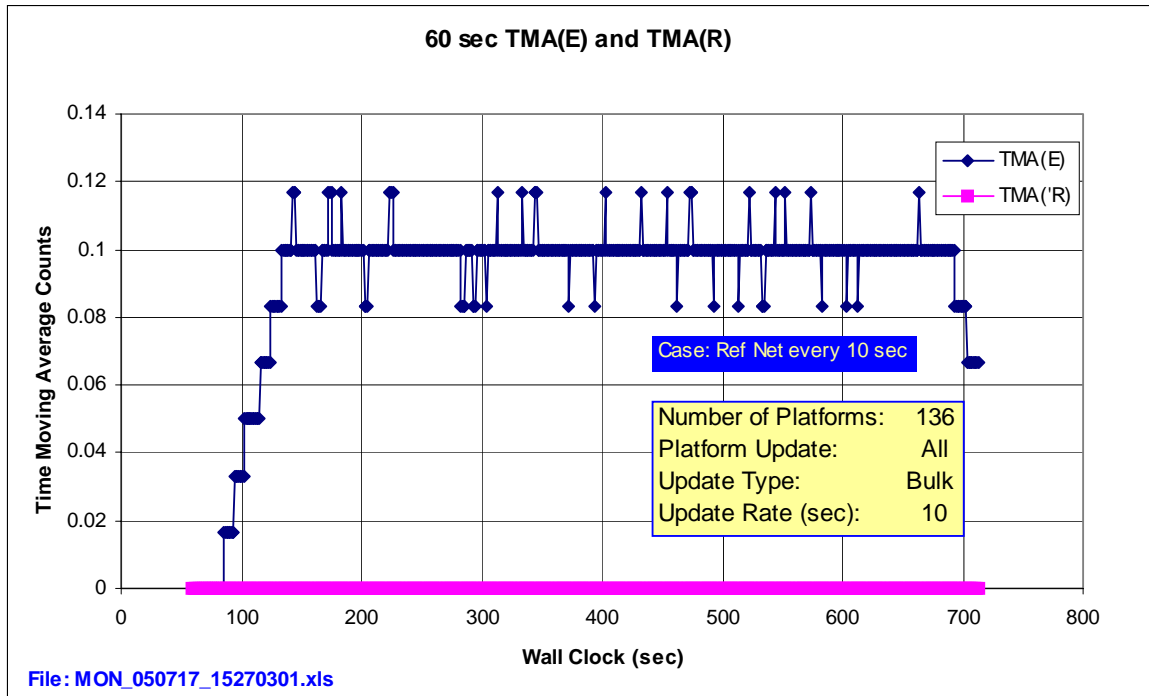


Figure 51 – Ref Net Only 60 sec TMA (E) and TMA (R)

## B.2 41 Net Step, 1/4 Rate, and Position Updates every 10 sec (Main PC)

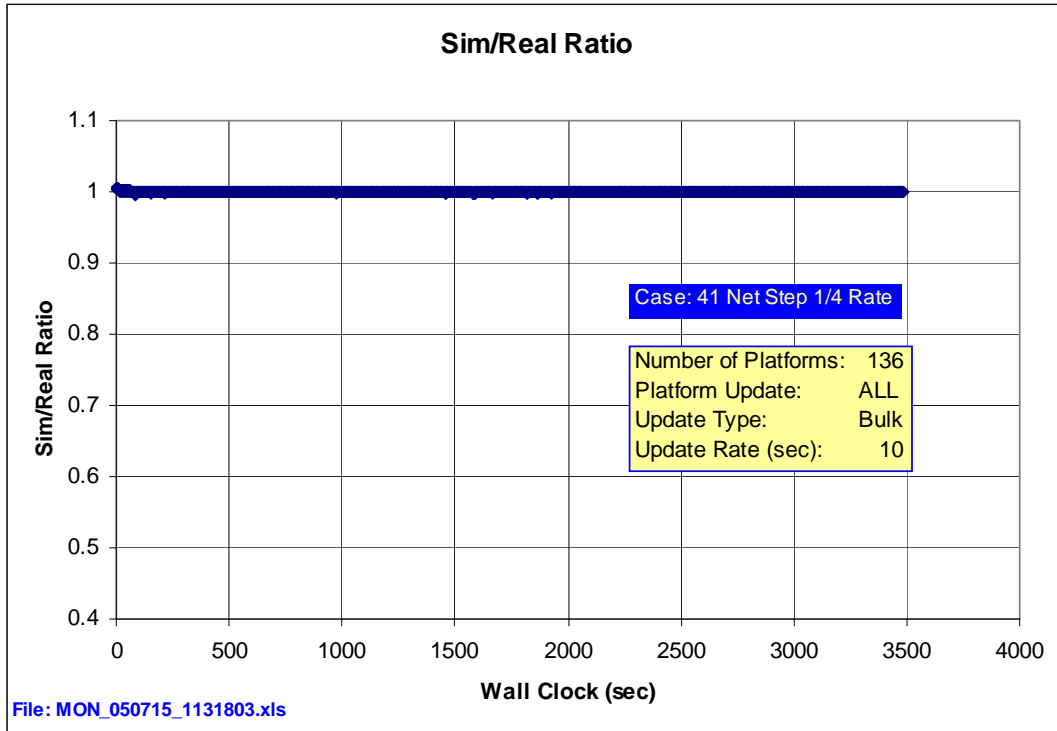


Figure 52 – 41 Net Step 1/4 Rate Sim/Real Ratio

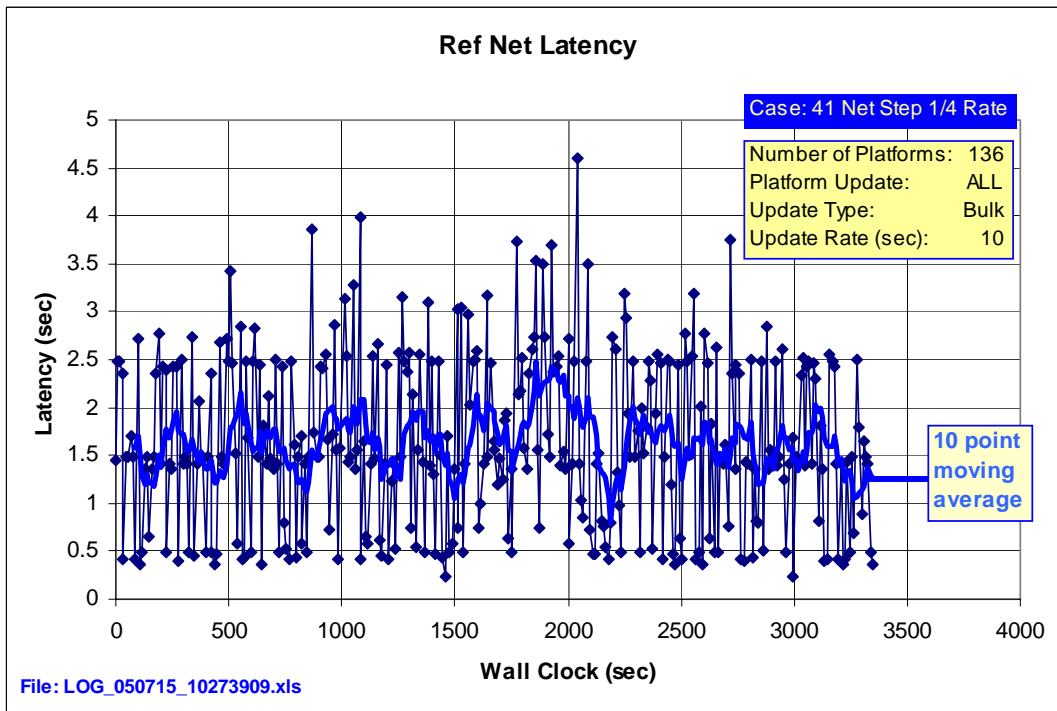


Figure 53 – 41 Net Step 1/4 Rate Ref Net Latency

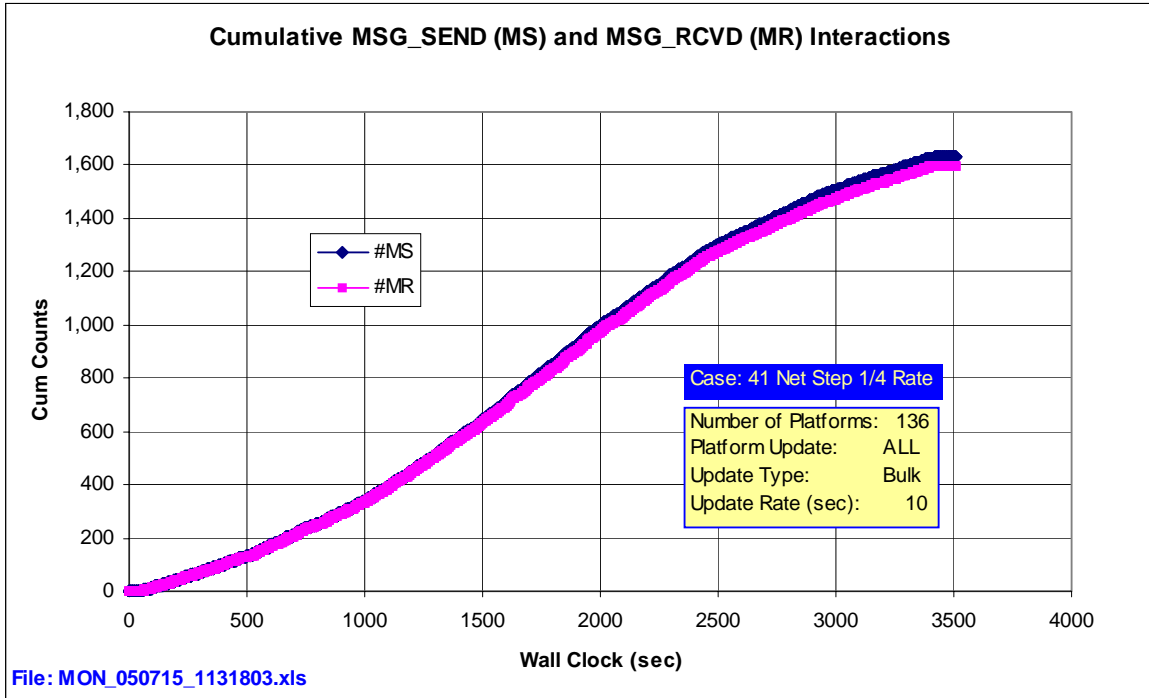


Figure 54 – 41 Net Step 1/4 Rate Cumulative MS and MR Interactions

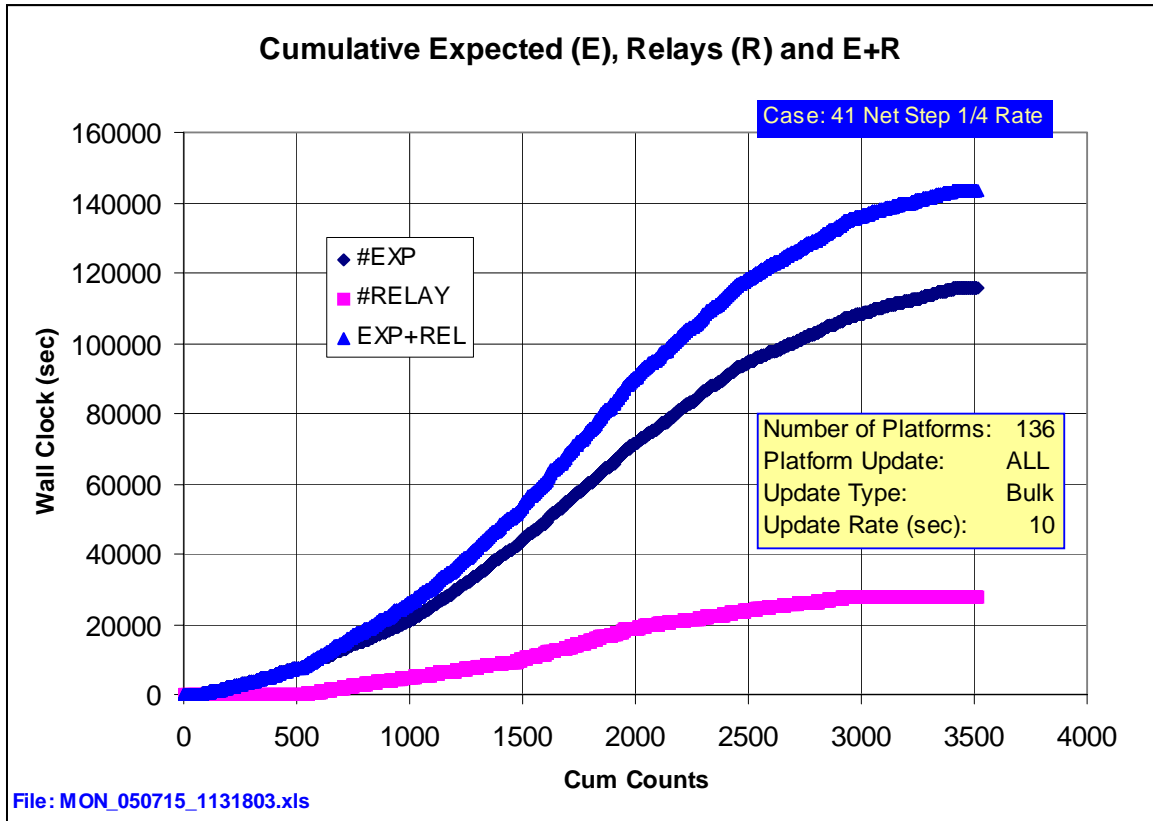


Figure 55 – 41 Net Step 1/4 Rate Cumulative E, R and E+R

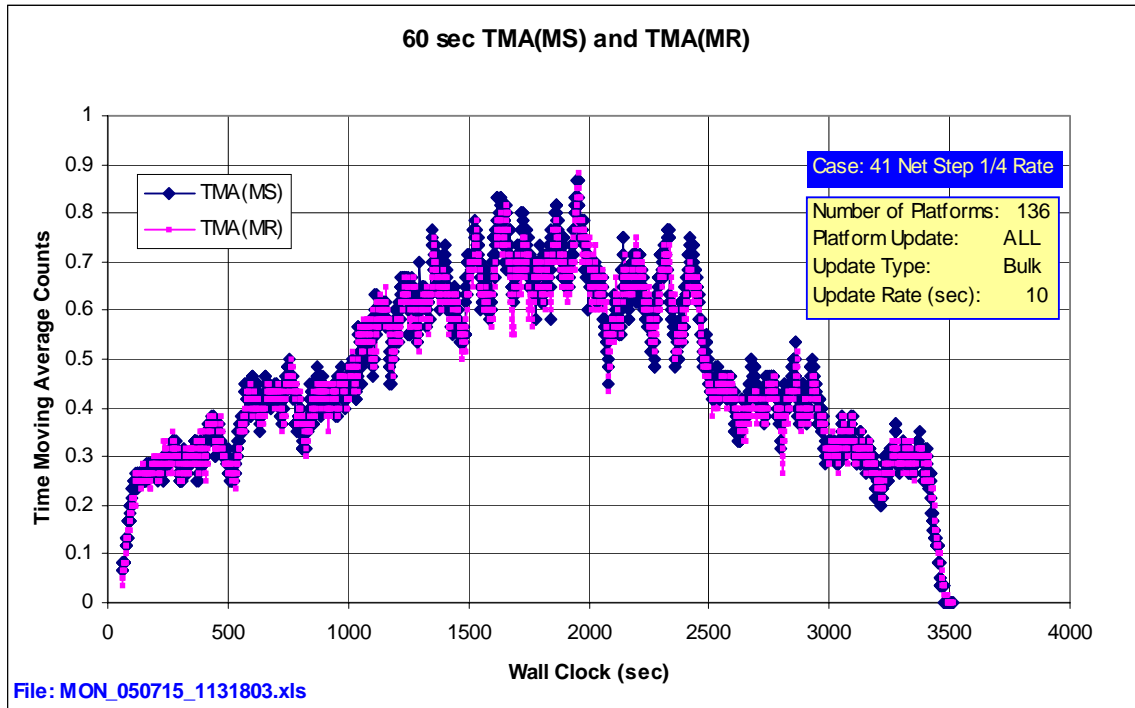


Figure 56 – 41 Net Step 1/4 Rate 60 sec TMA(MS) and TMA (MR)

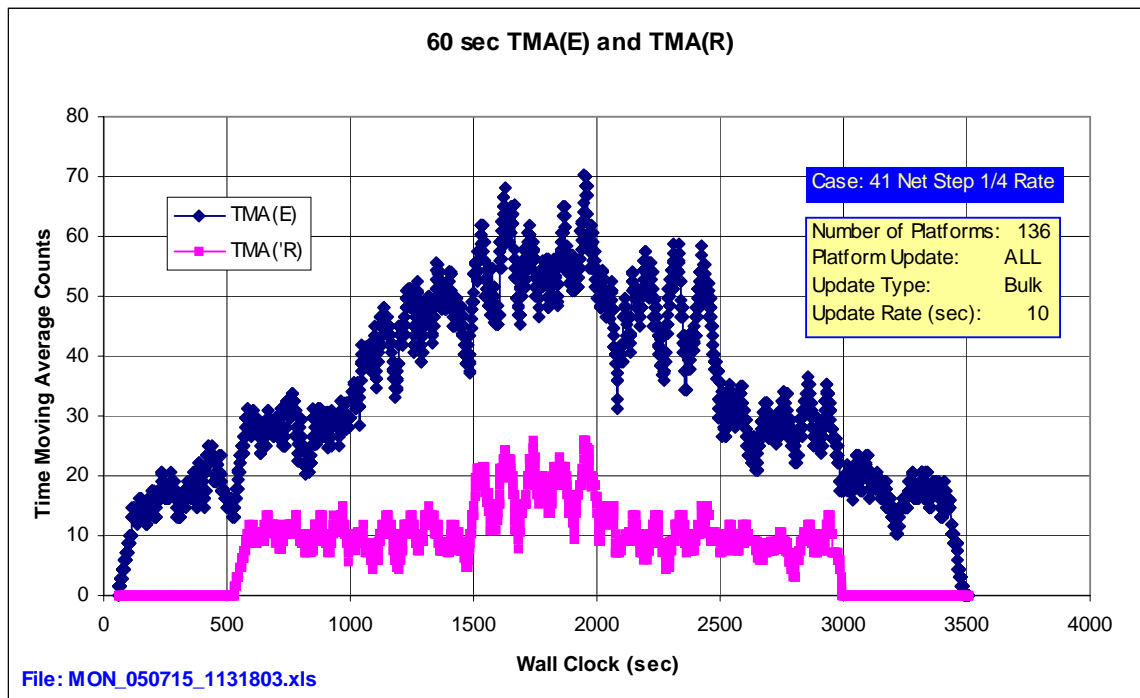


Figure 57 – 41 Net Step 1/4 Rate 60 sec TMA(E) and TMA(R)

### B.3 41 Net Step, 1/2 Rate, and Position Updates every 10 sec (Main PC)

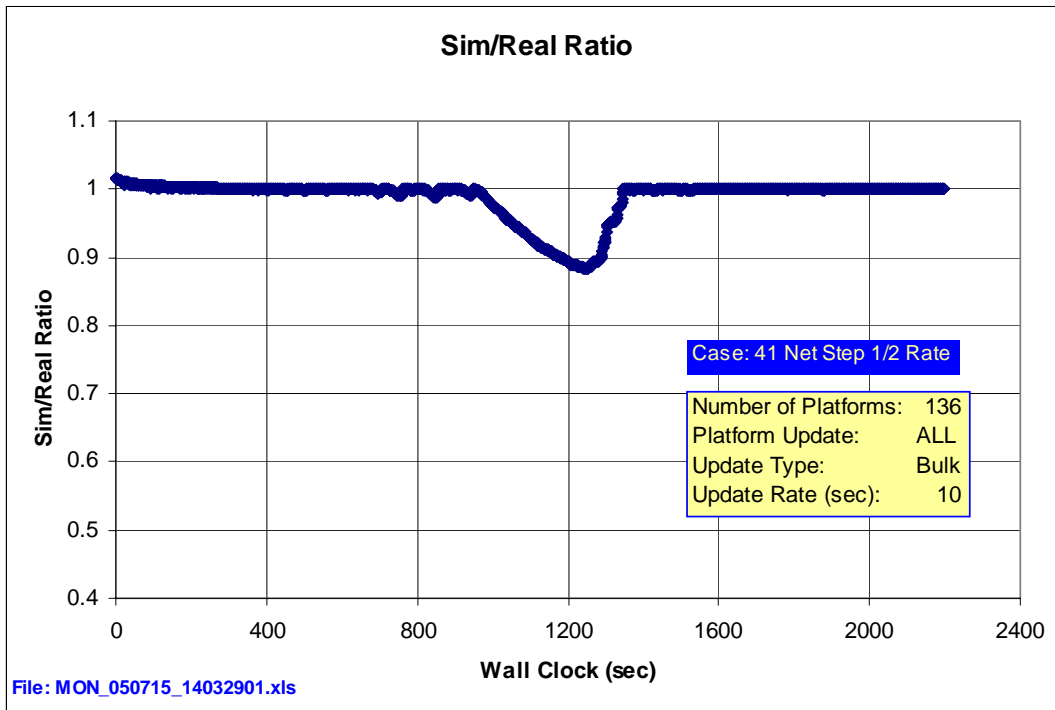


Figure 58 – 41 Net Step 1/2 Rate Sim/Real Ratio

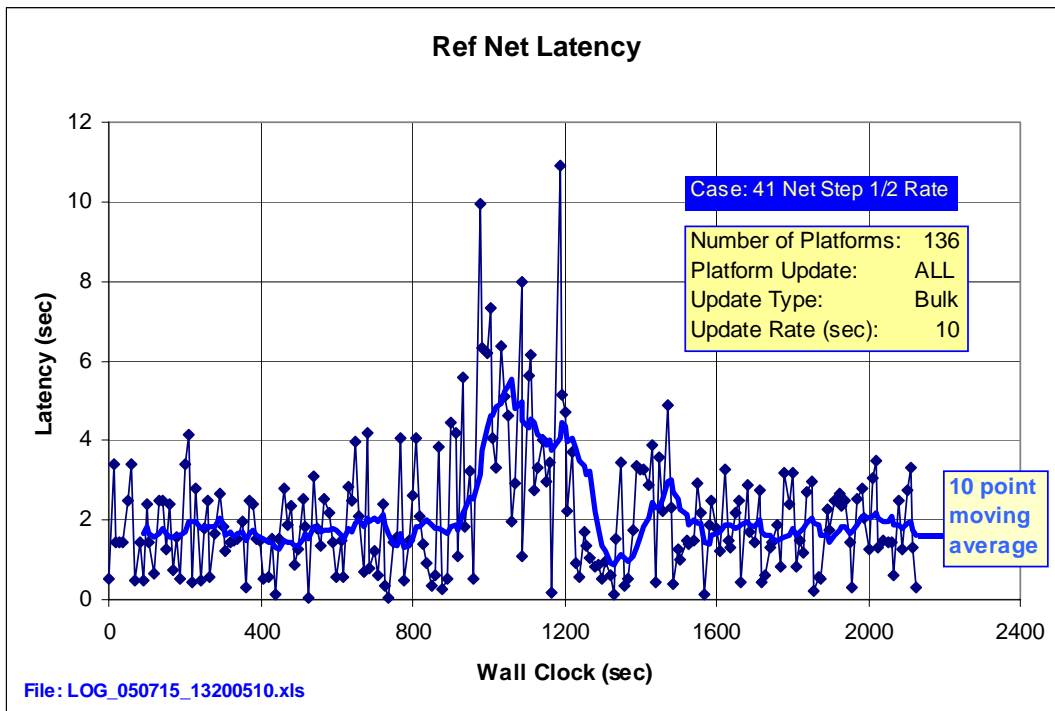


Figure 59 – 41 Net Step 1/2 Rate Ref Net Latency

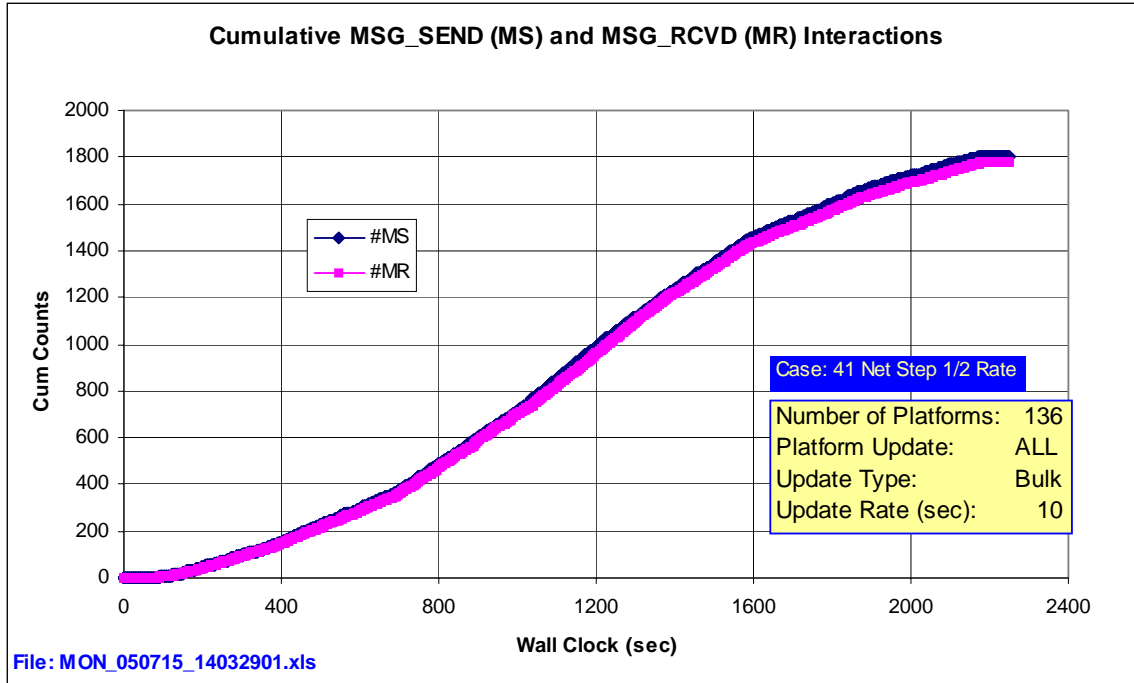


Figure 60 – 41 Net Step 1/2 Rate Cumulative MS and MR Interactions

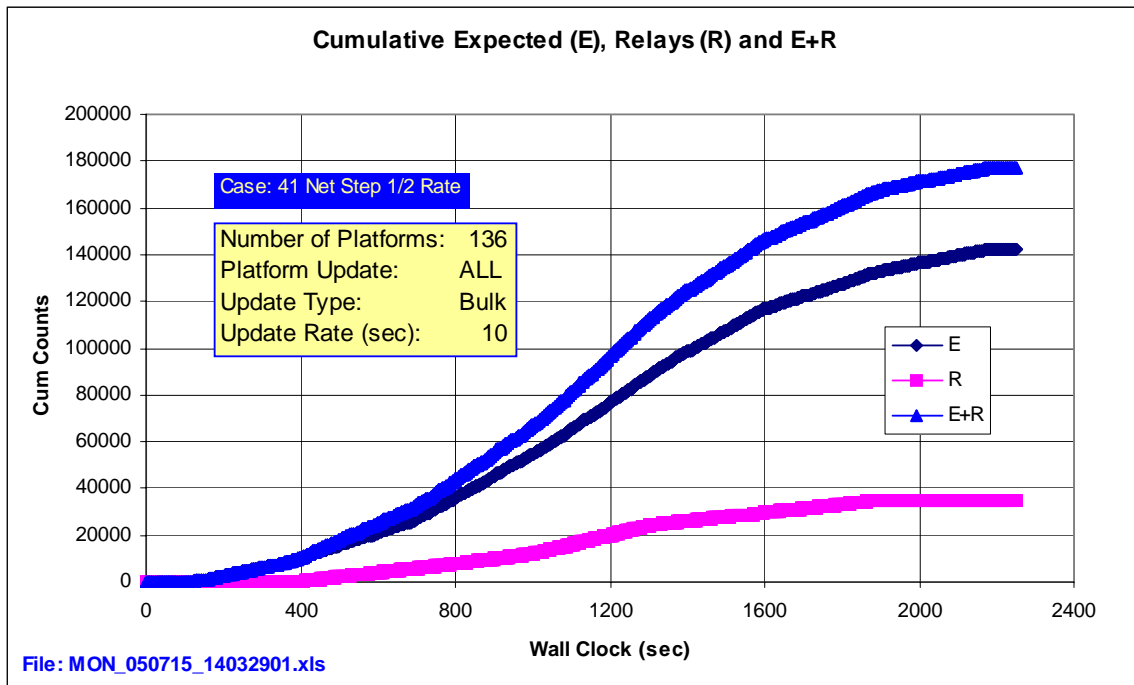


Figure 61 – Net Step 1/2 Rate Cumulative E, R, and E+R

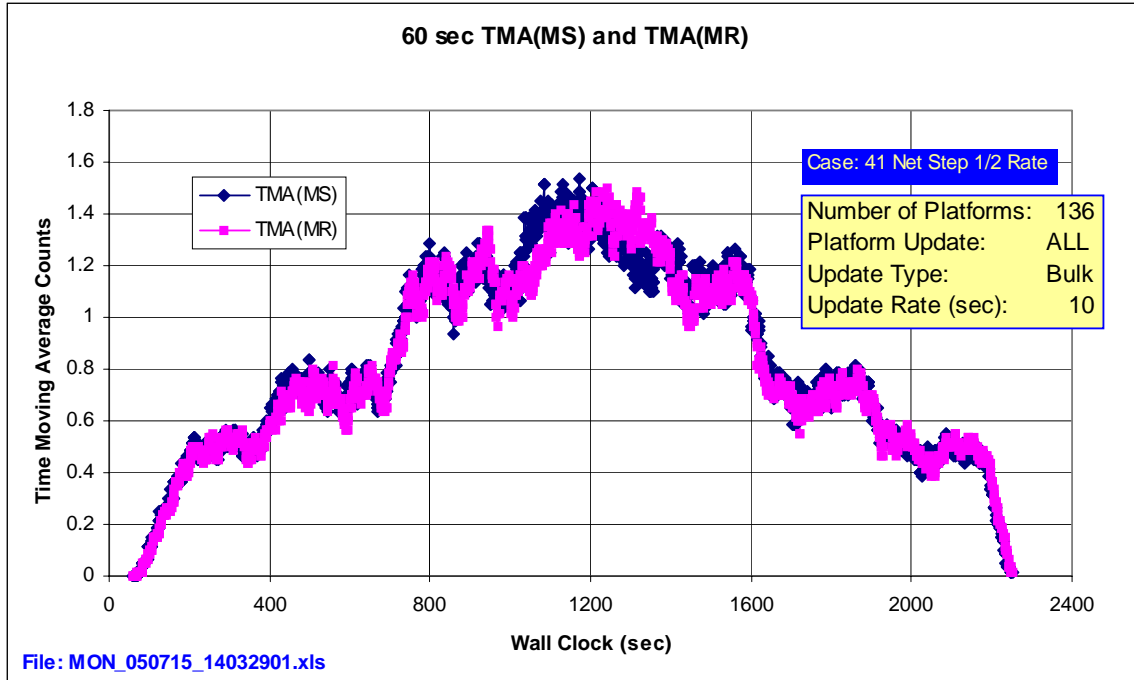


Figure 62 – Net Step 1/2 Rate 60 sec TMA(MS) and TMA(MR)

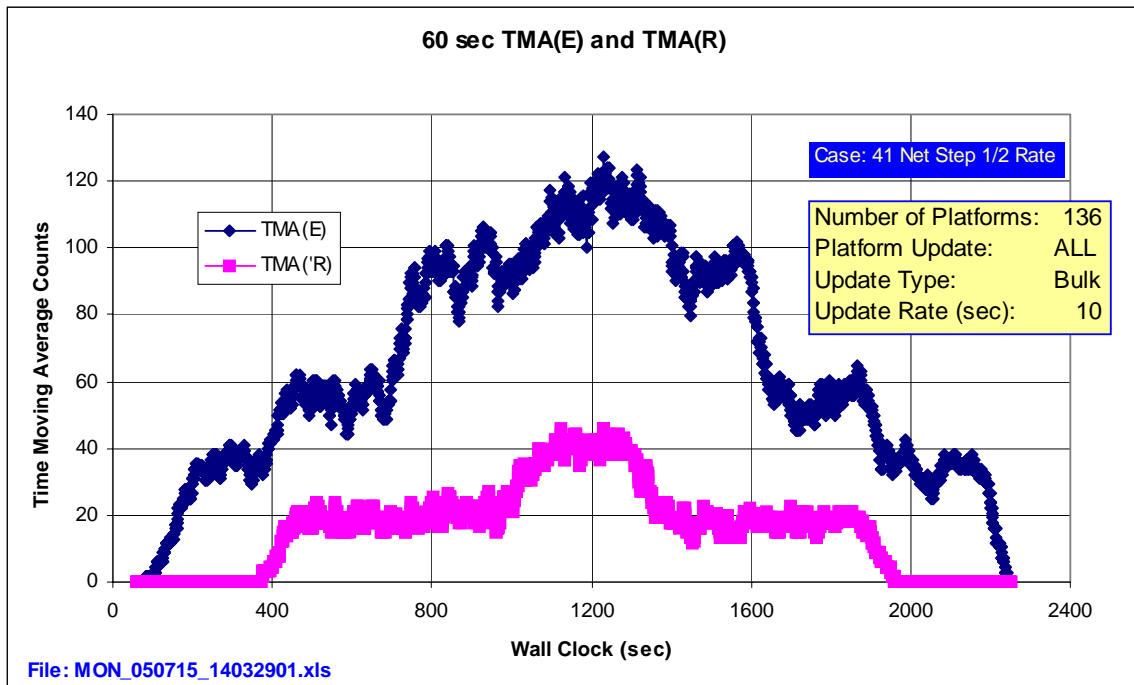


Figure 63 – Net Step 1/2 Rate 60 sec TMA(E) and TMA(R)

## B.4 41 Net Step, Full Rate, and Position Updates every 10 sec (Main PC)

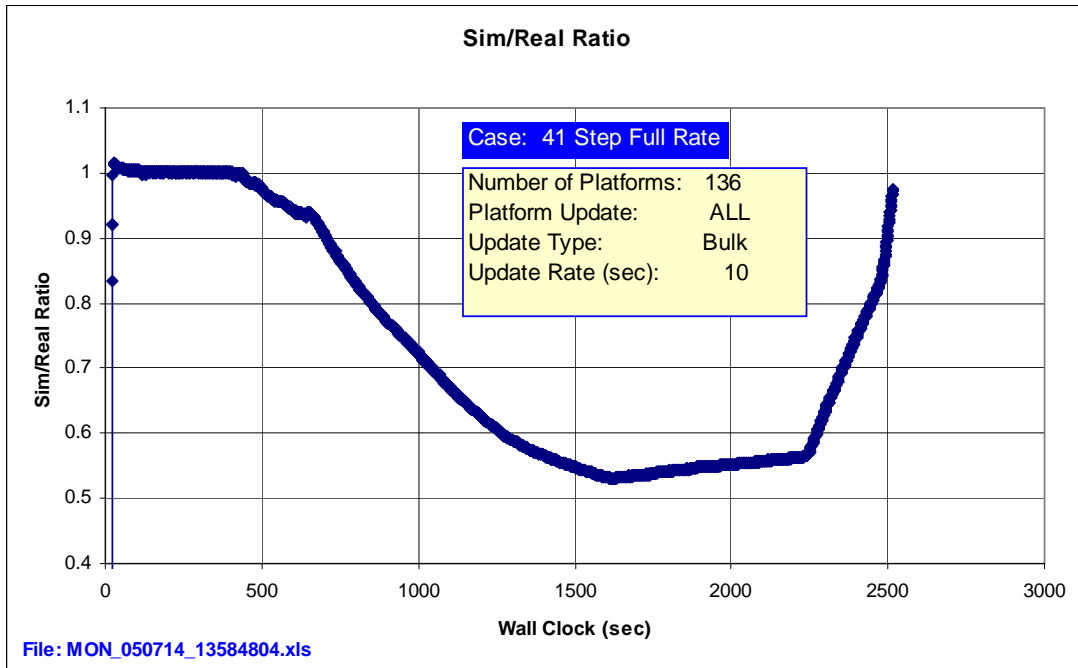


Figure 64 – 41 Net Step Full Rate Sim/Real Ratio

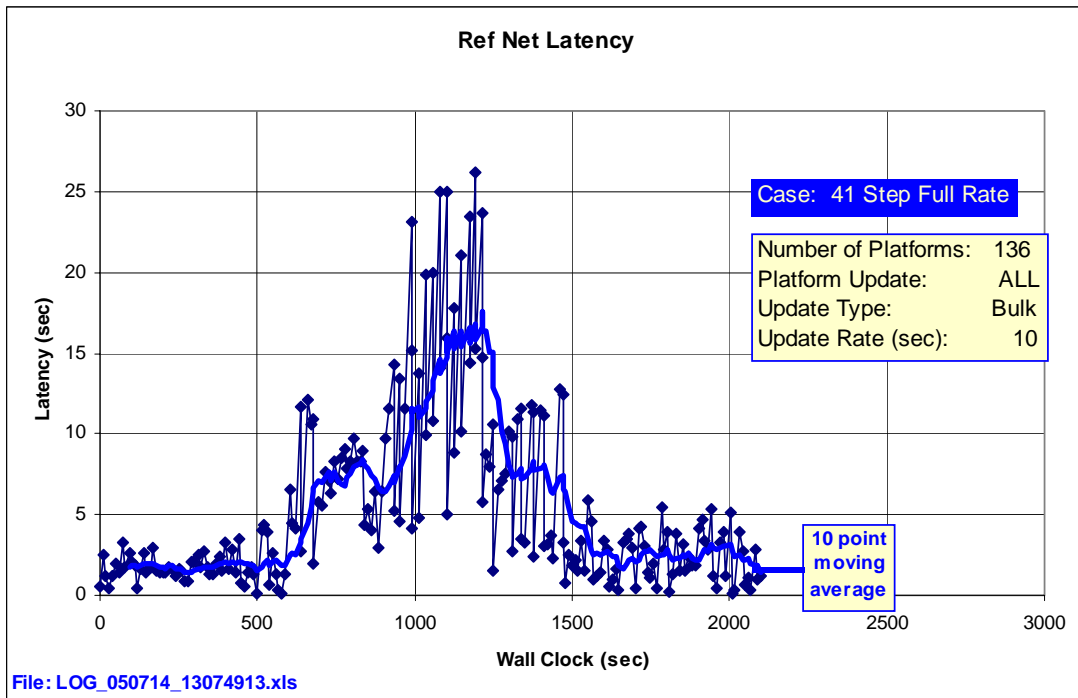


Figure 65 – 41 Net Step Full Rate Ref Net Latency

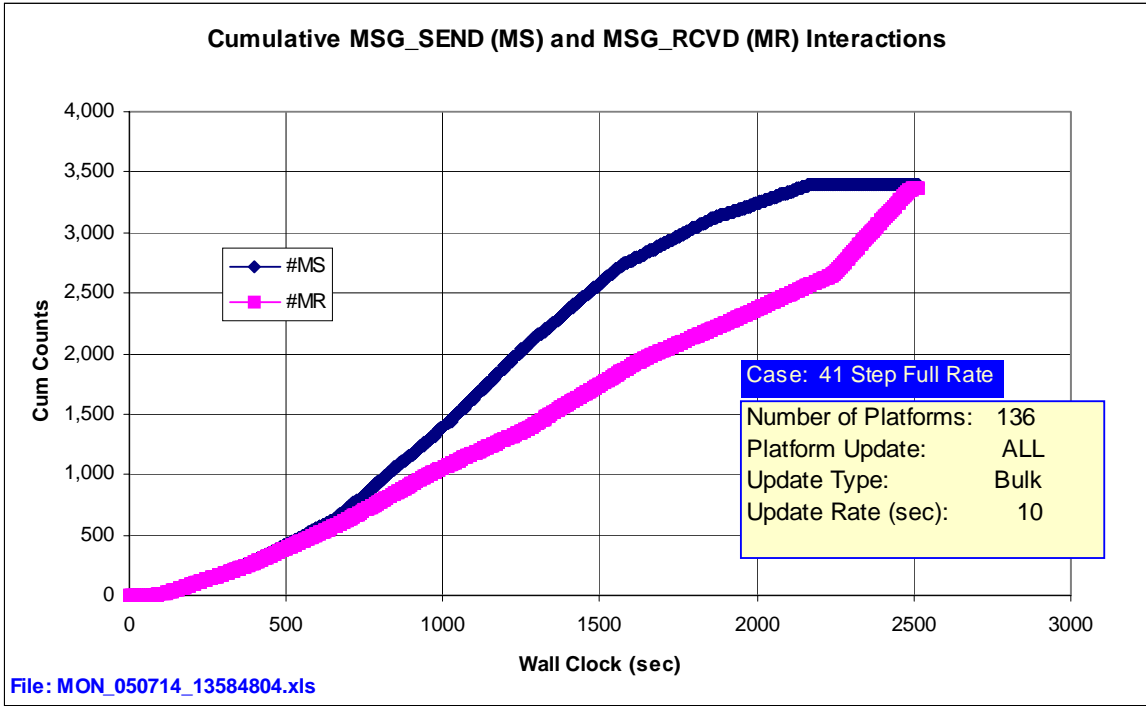


Figure 66 – 41 Net Step Full Rate Cumulative MS and MR Interactions

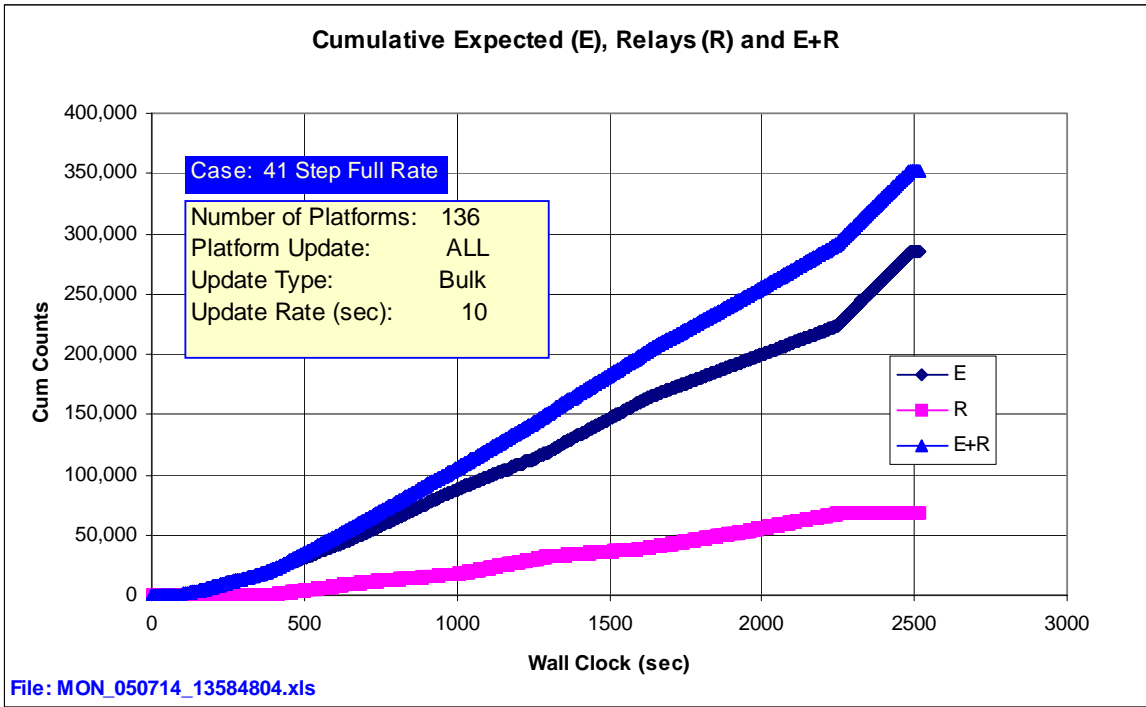
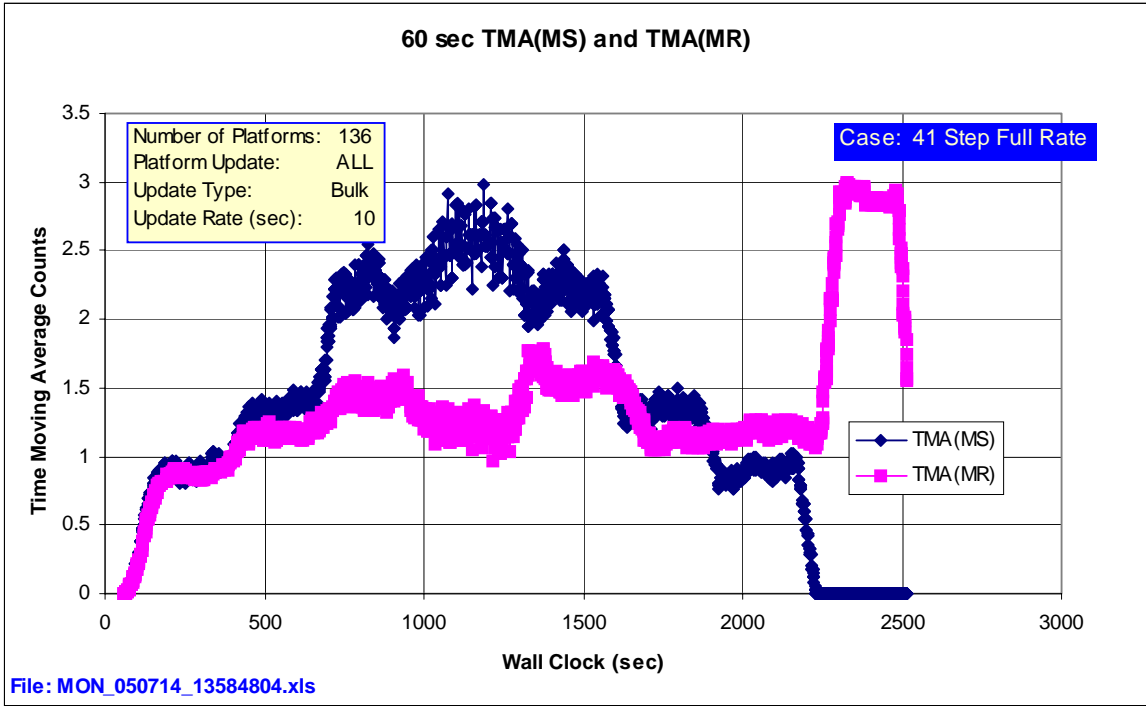
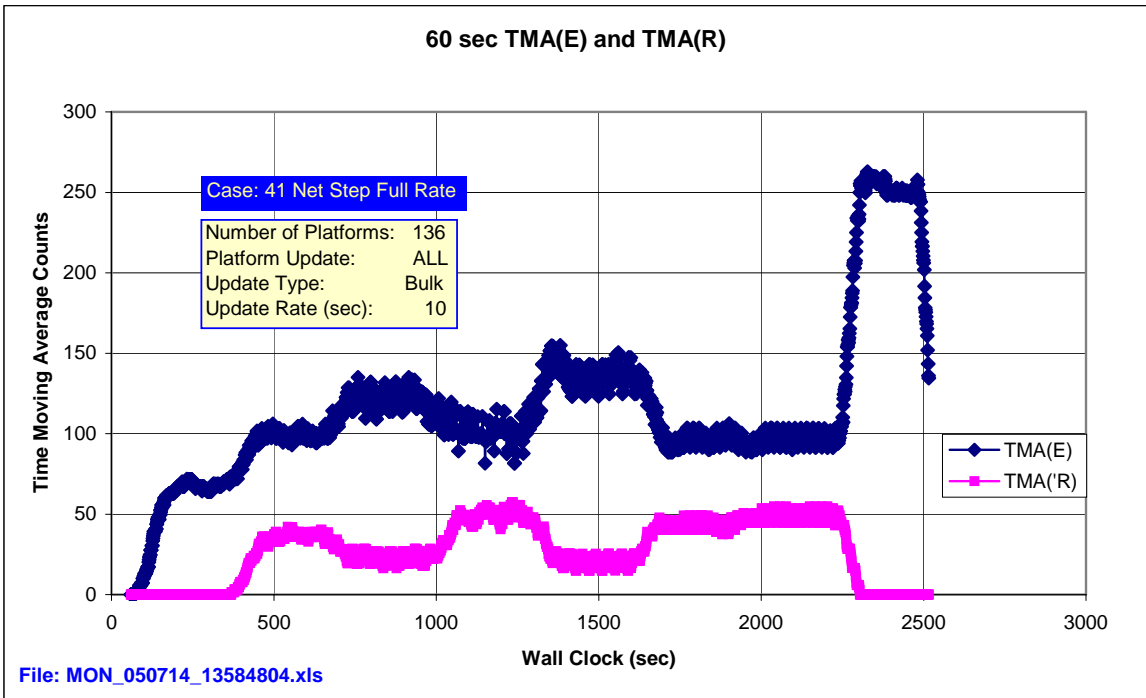


Figure 67 – 41 Net Step Full Rate Cumulative E, R, and E+R



**Figure 68 – 41 Net Step Full Rate 60 sec TMA(MS) and TMA(MR)**



**Figure 69 – 41 Net Step Full Rate 60 sec TMA(E) and TMA(R)**

## B.5 41 Net Step, Full Rate, and Delta Position Updates every 10 sec (Main PC)

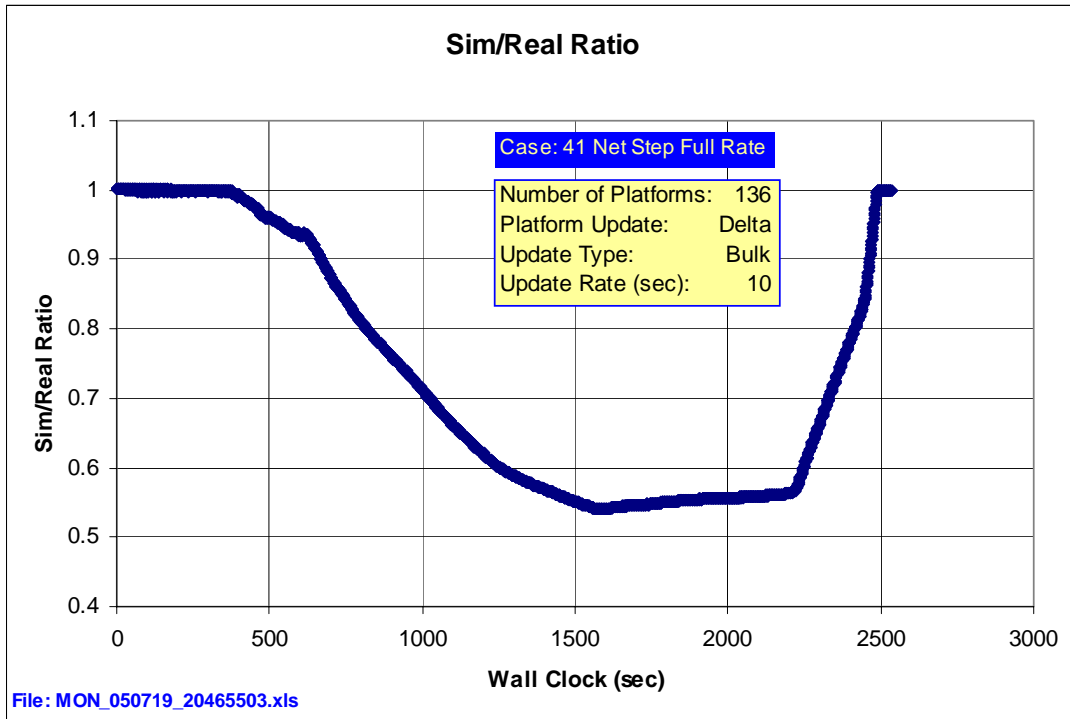


Figure 70 – 41 Net Step Full Rate Delta Position Update Sim/Real Ratio

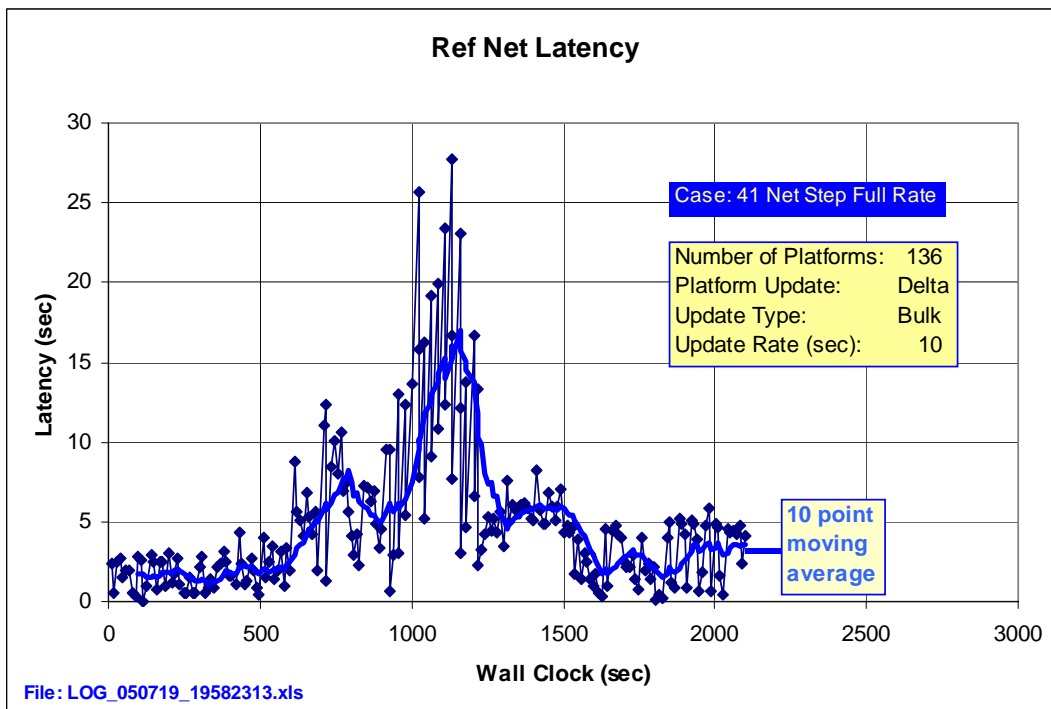


Figure 71 – 41 Net Step Full Rate Delta Position Update Ref Net Latency

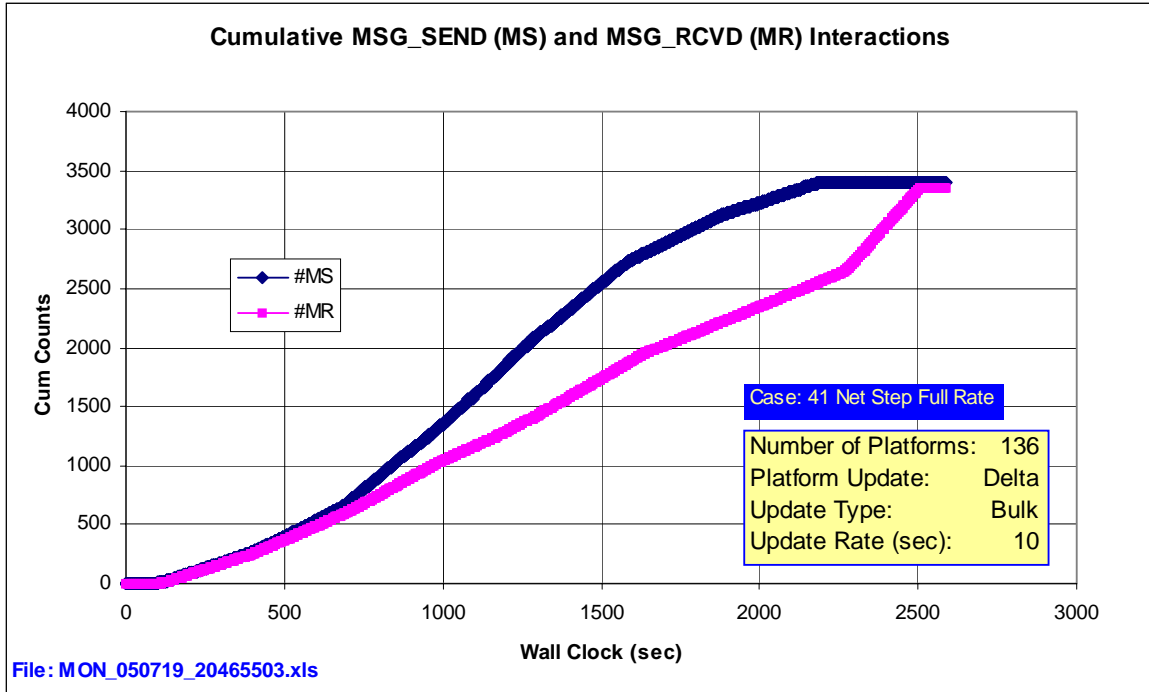


Figure 72 – 41 Net Step Full Rate Delta Position Update Cum MS and MR Interactions

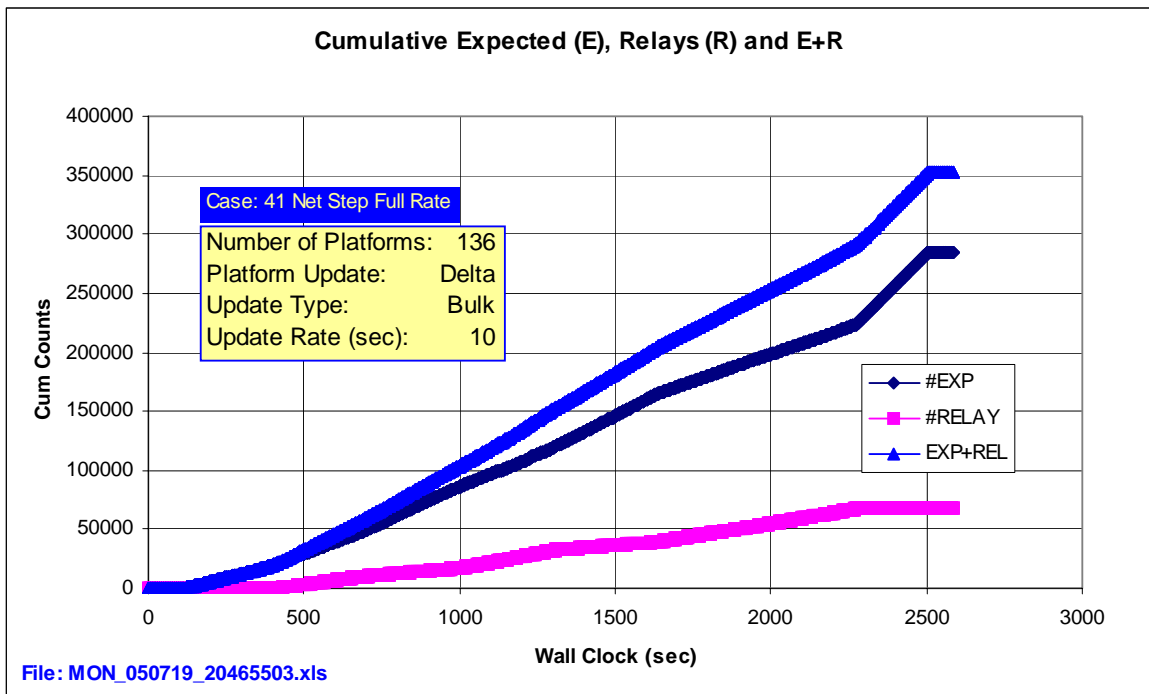


Figure 73 – 41 Net Step Full Rate Delta Position Update Cum E, R, E+R

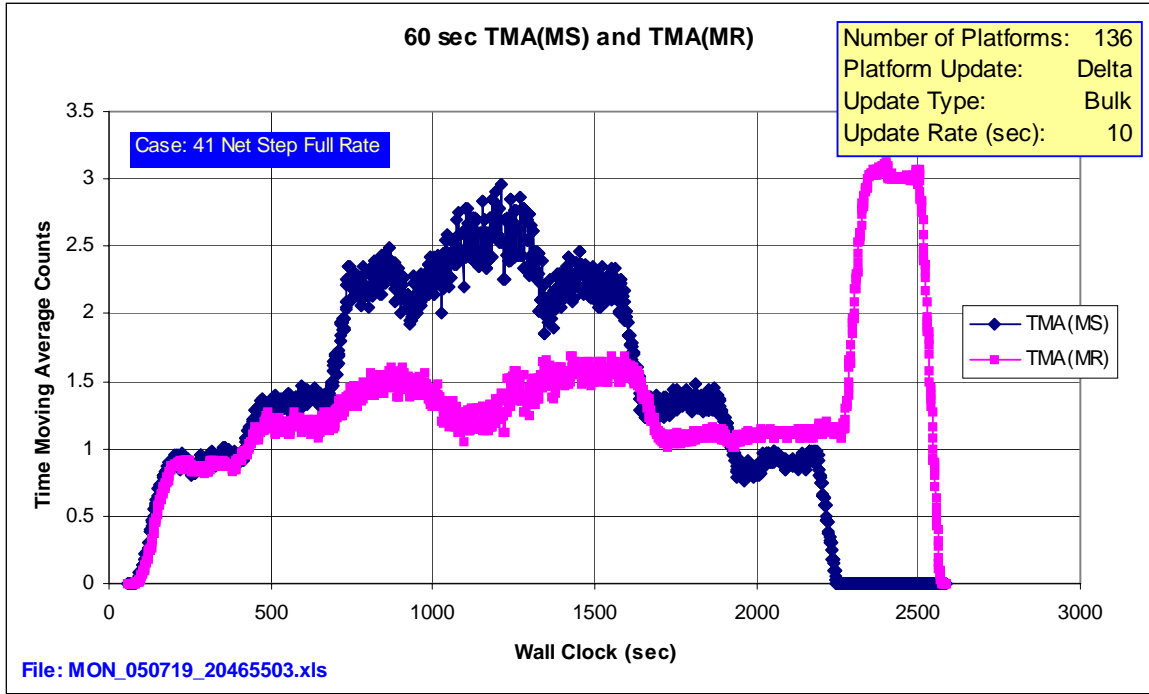


Figure 74 – 41 Net Step Full Rate Delta Position Update 60 sec TMA(MS) and TMA(MR)

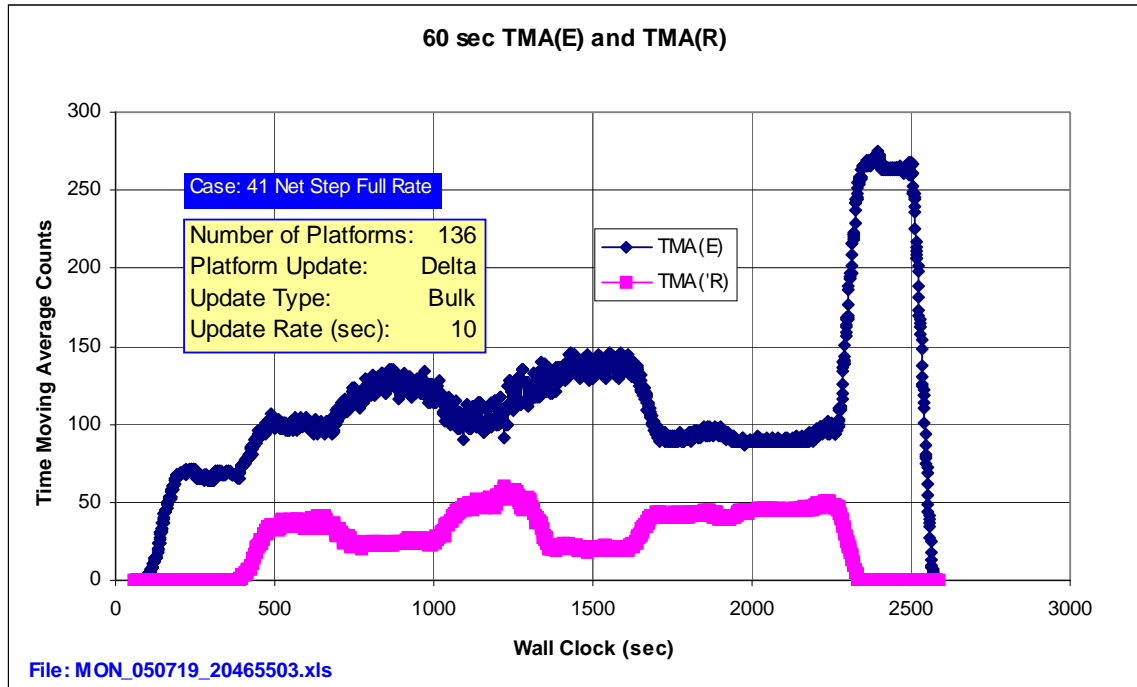


Figure 75 – 41 Net Step Full Rate Delta Position Update 60 sec TMA(E) and TMA(R)

## B.6 41 Net Step, 1/2 Rate, and Position Updates every 14 sec (Main PC)

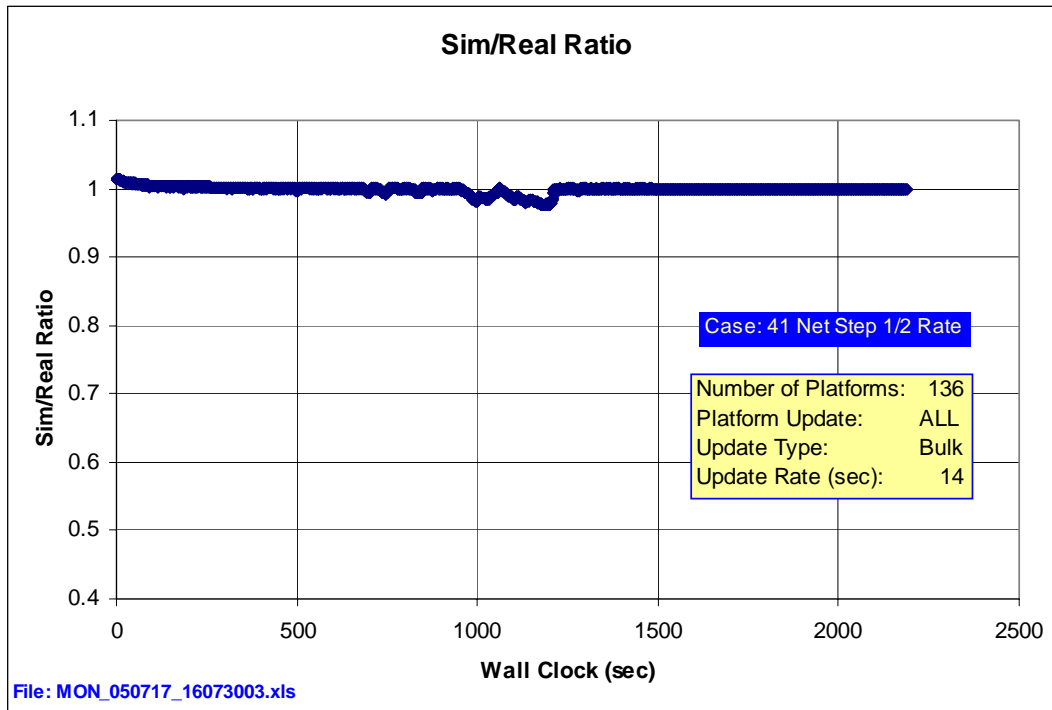


Figure 76 – 41 Net Step 1/2 Rate 14 sec Position Update Sim/Real Ratio

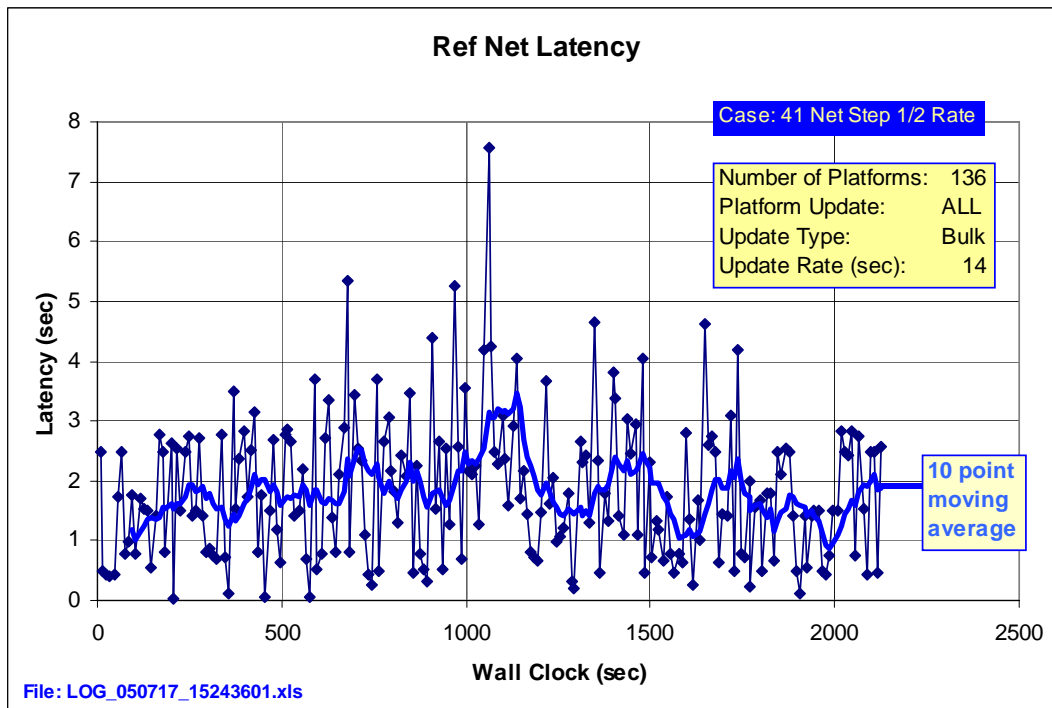
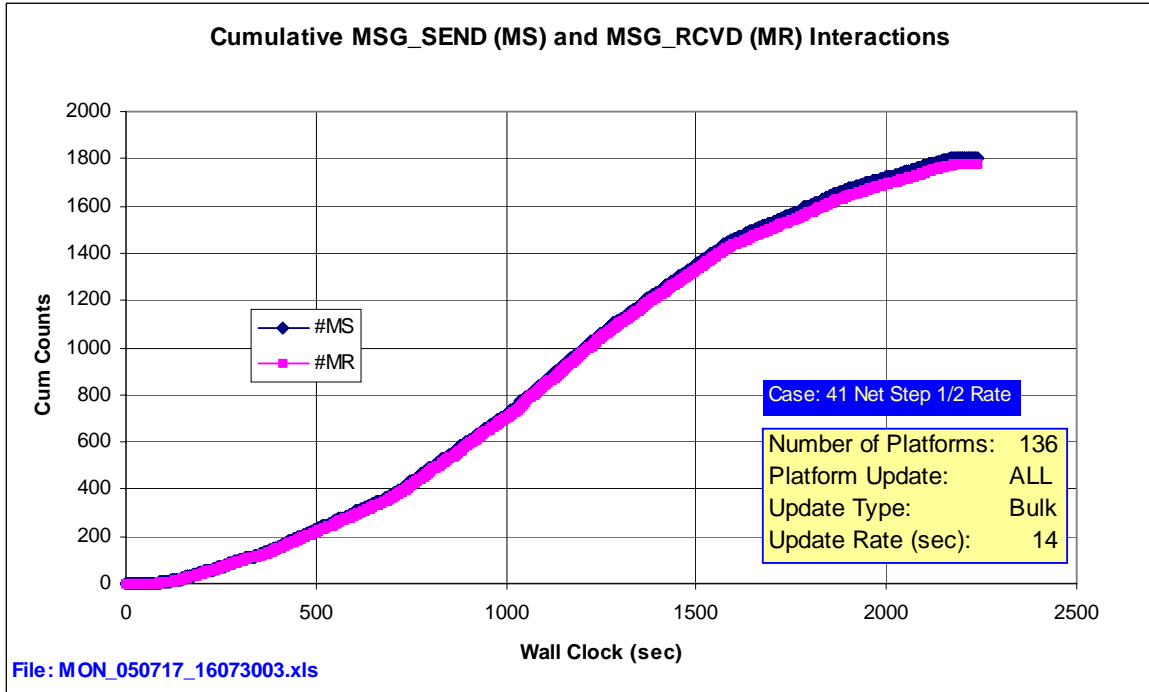
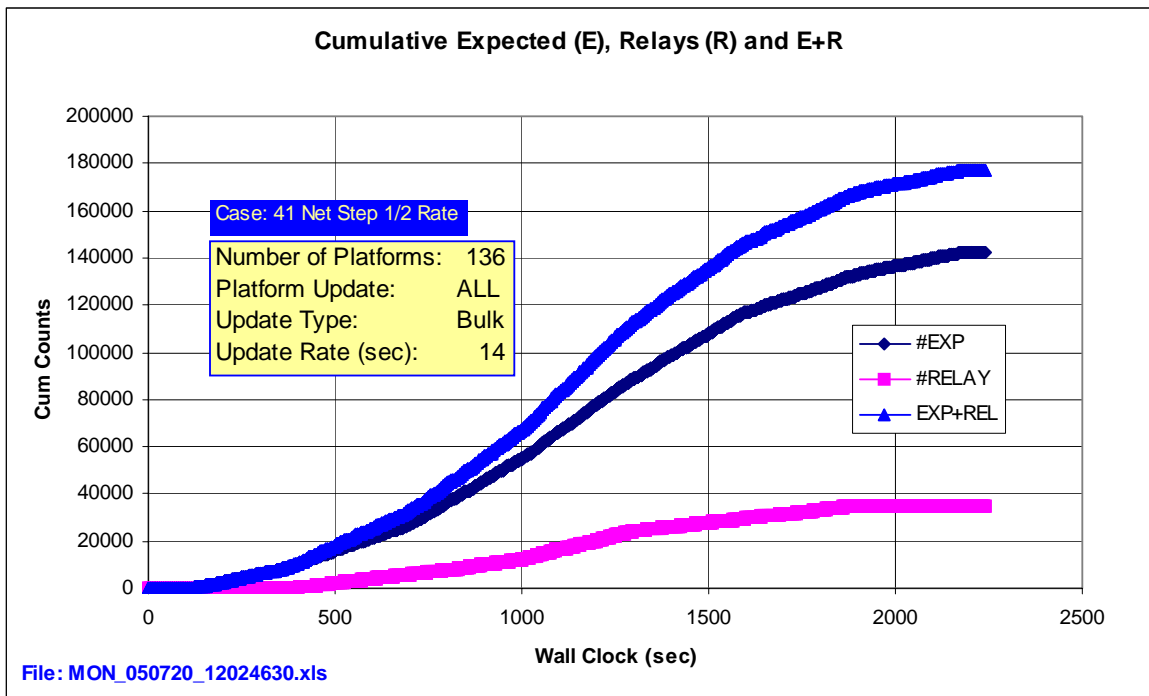


Figure 77 – 41 Net Step 1/2 Rate 14 sec Position Update Ref Net Latency



**Figure 78 – 41 Net Step 1/2 Rate 14 sec Position Update Cum MS and MR Interactions**



**Figure 79 – 41 Net Step 1/2 Rate 14 sec Position Update Cum E, R, and E+R**

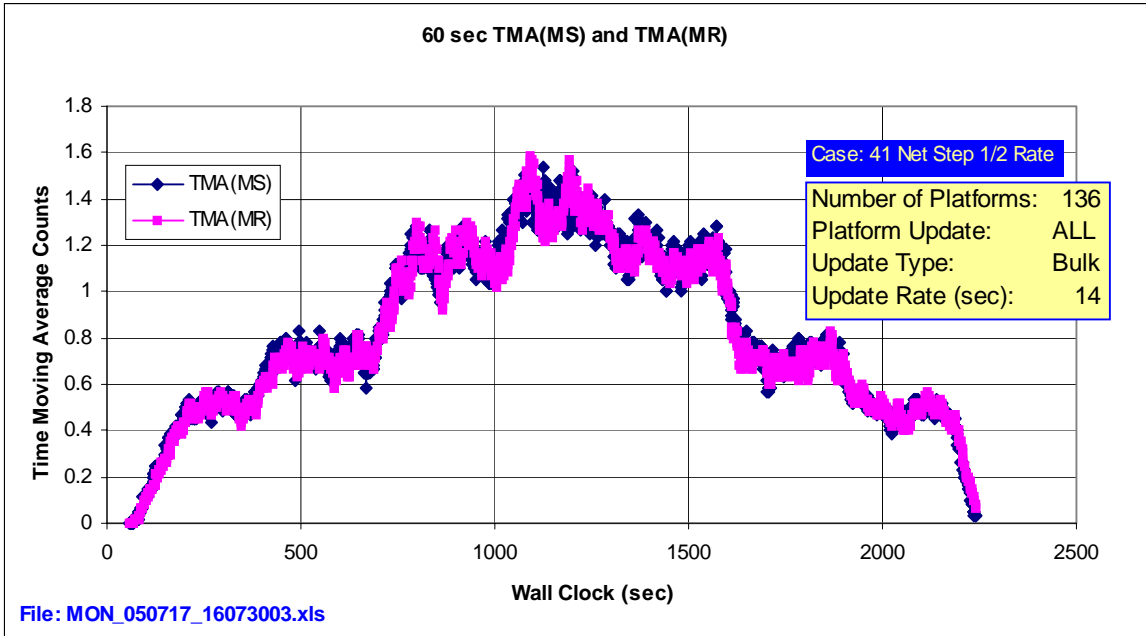


Figure 80 – 41 Net Step 1/2 Rate 14 sec Position Update 60 Sec TMA(MS) and TMA(MR)

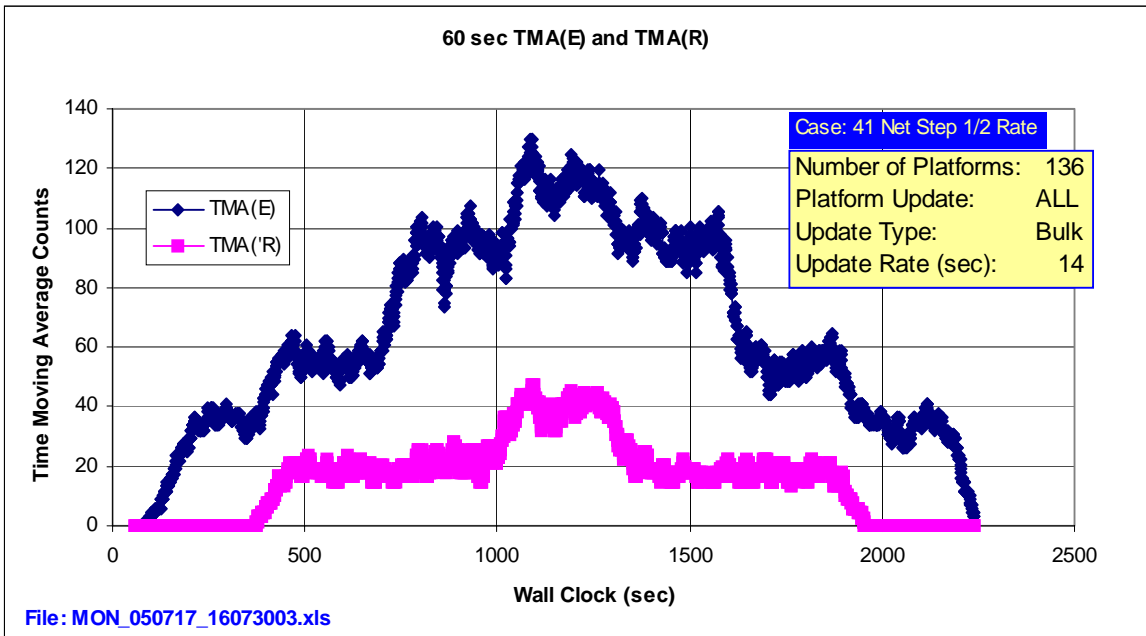


Figure 81 – 41 Net Step 1/2 Rate 14 sec Position Update 60 sec TMA(E) and TMA(R)

## B.7 41 Net Step, 1/2 Rate, and Position Updates every 6 sec (Main PC)

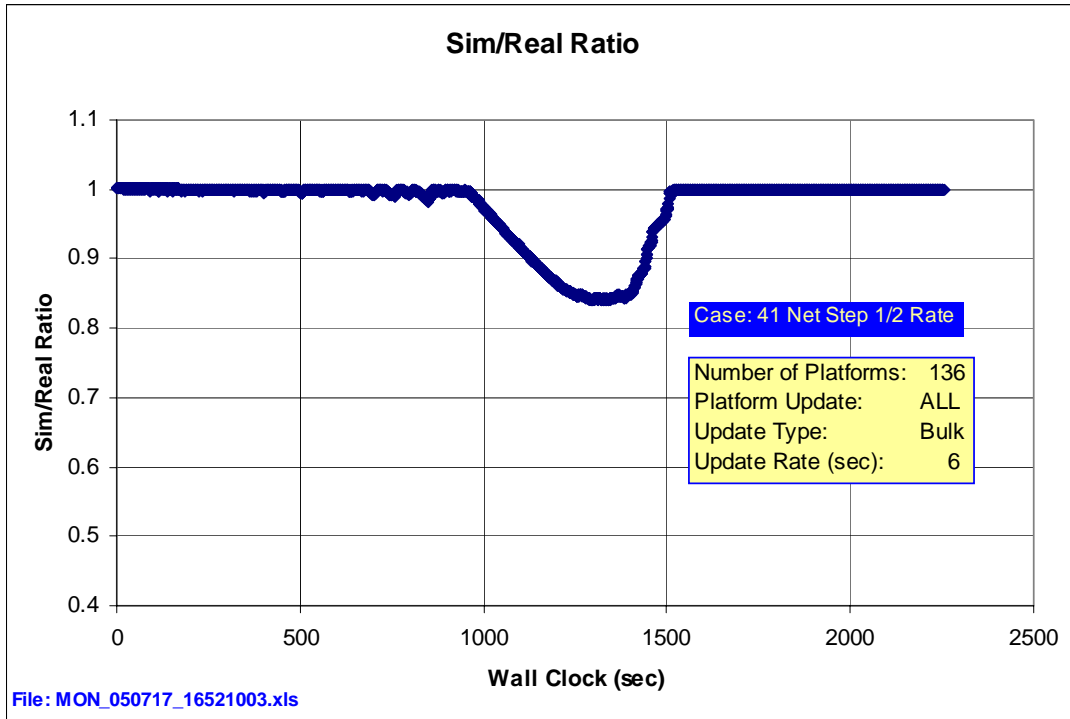


Figure 82 – 41 Net Step 1/2 Rate 6 sec Position Update Sim/Real Ratio

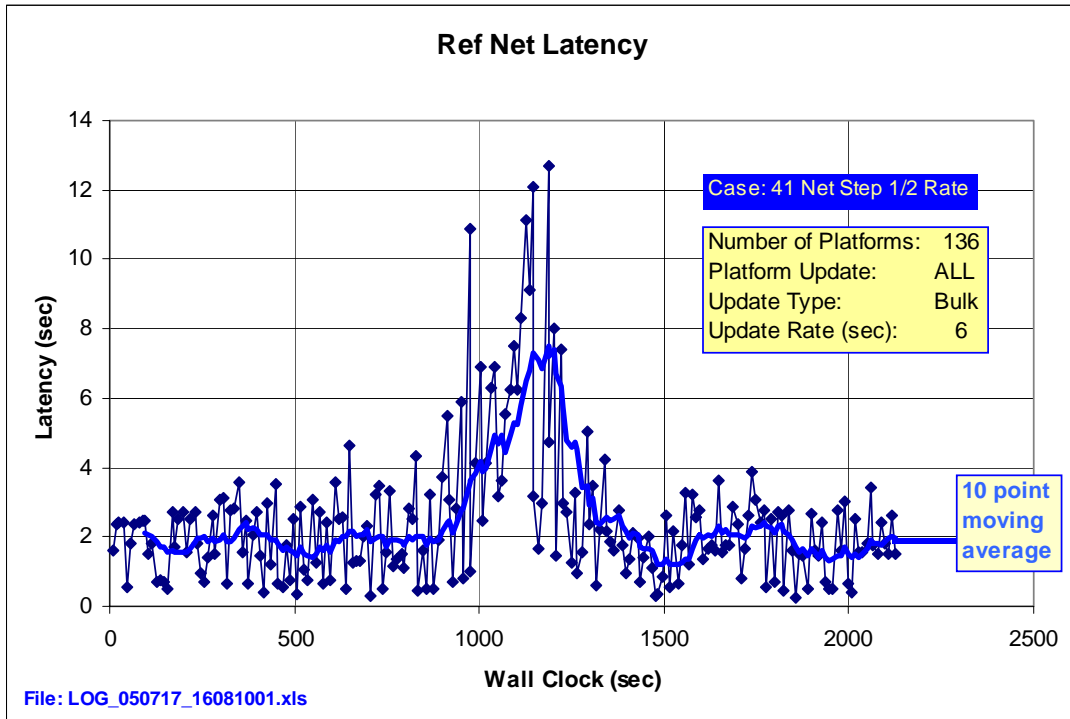


Figure 83 – 41 Net Step 1/2 Rate 6 sec Position Update Ref Net Latency

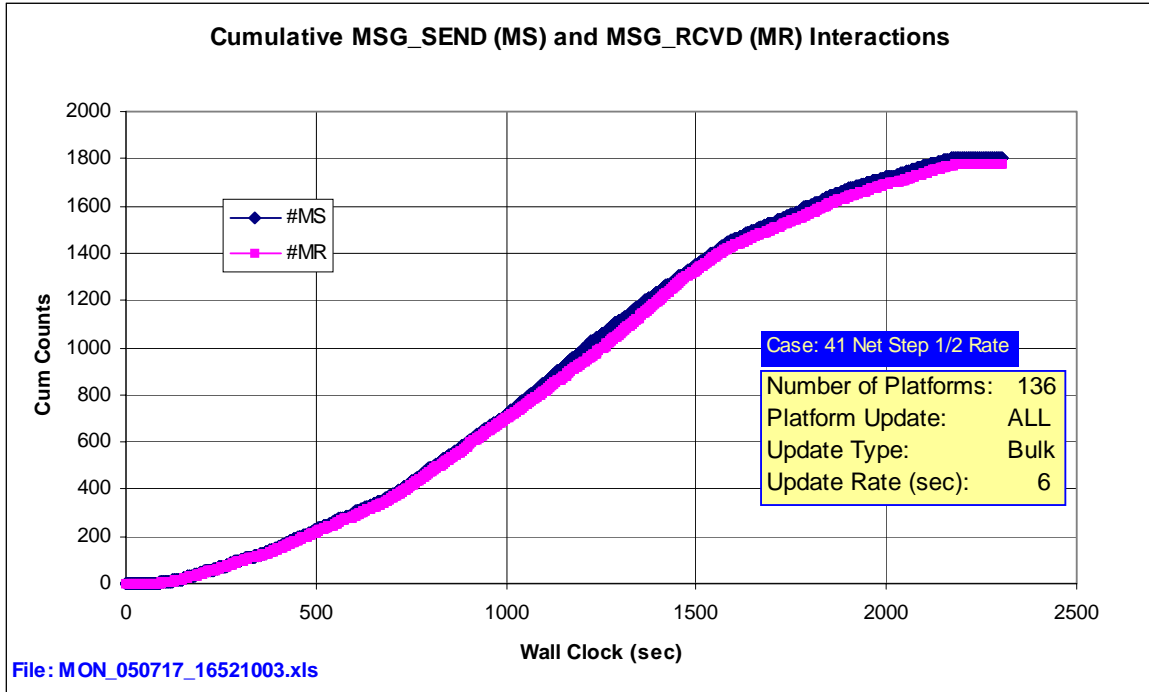


Figure 84 – 41 Net Step 1/2 Rate 6 sec Position Update Cum MS and MR Interactions

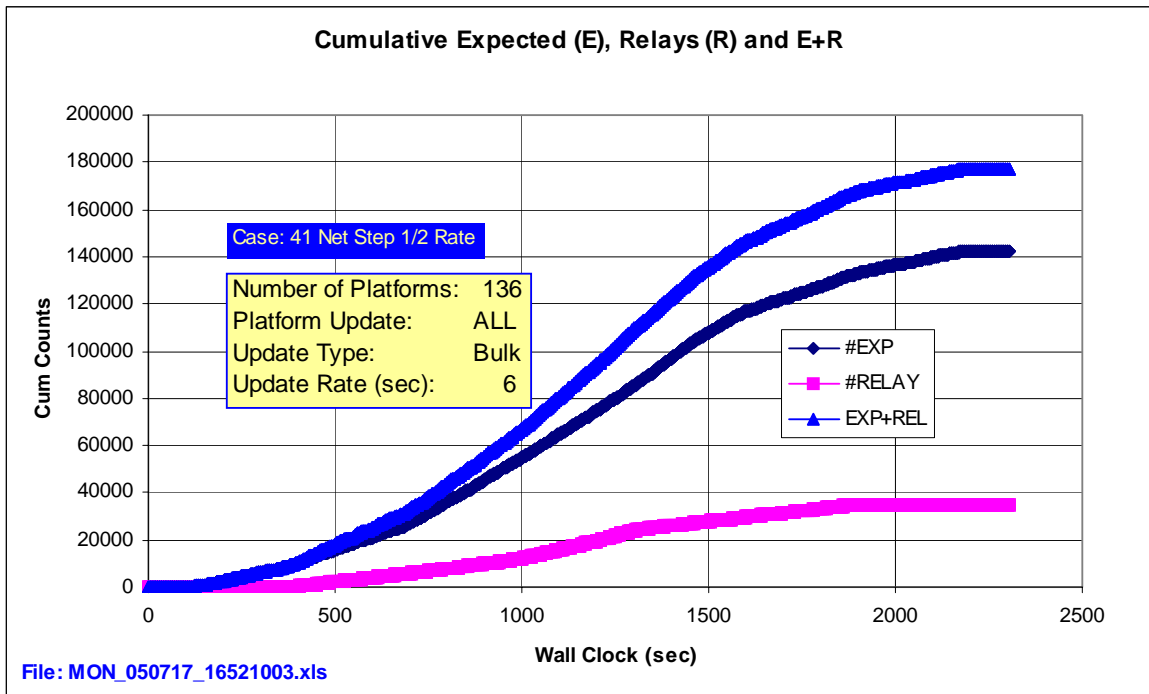


Figure 85 – 41 Net Step 1/2 Rate 6 sec Position Update Cum E, R, and E+R

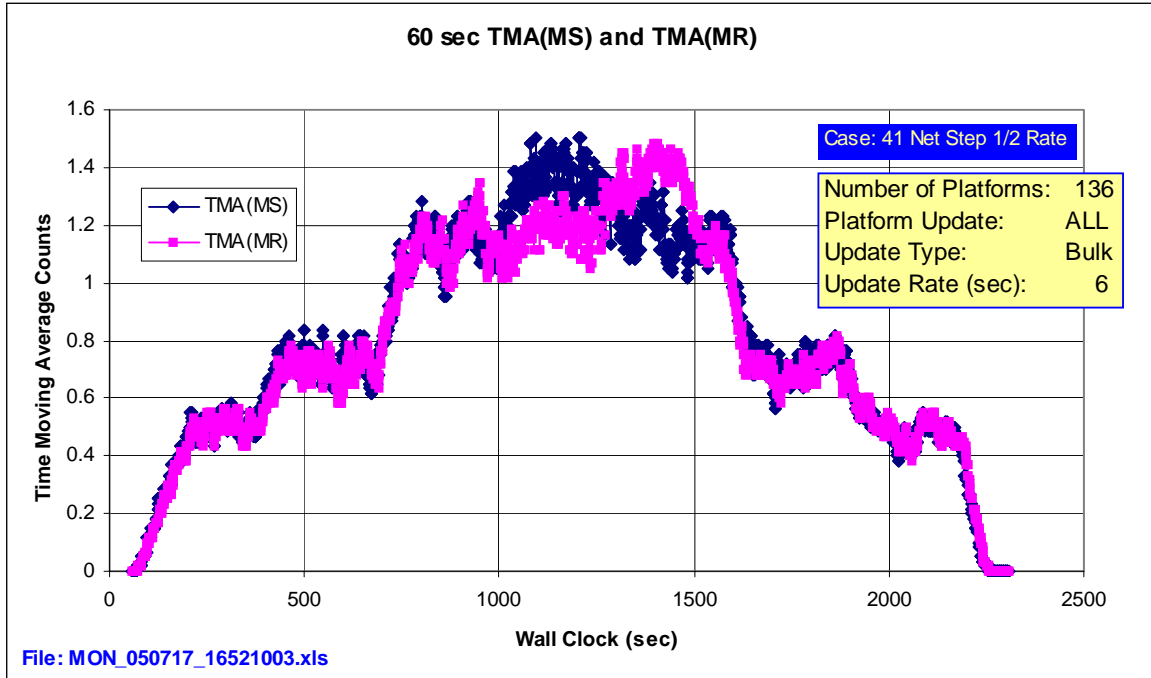


Figure 86 – 41 Net Step 1/2 Rate 6 sec Position Update 60 sec TMA(MS) and TMA(MR)

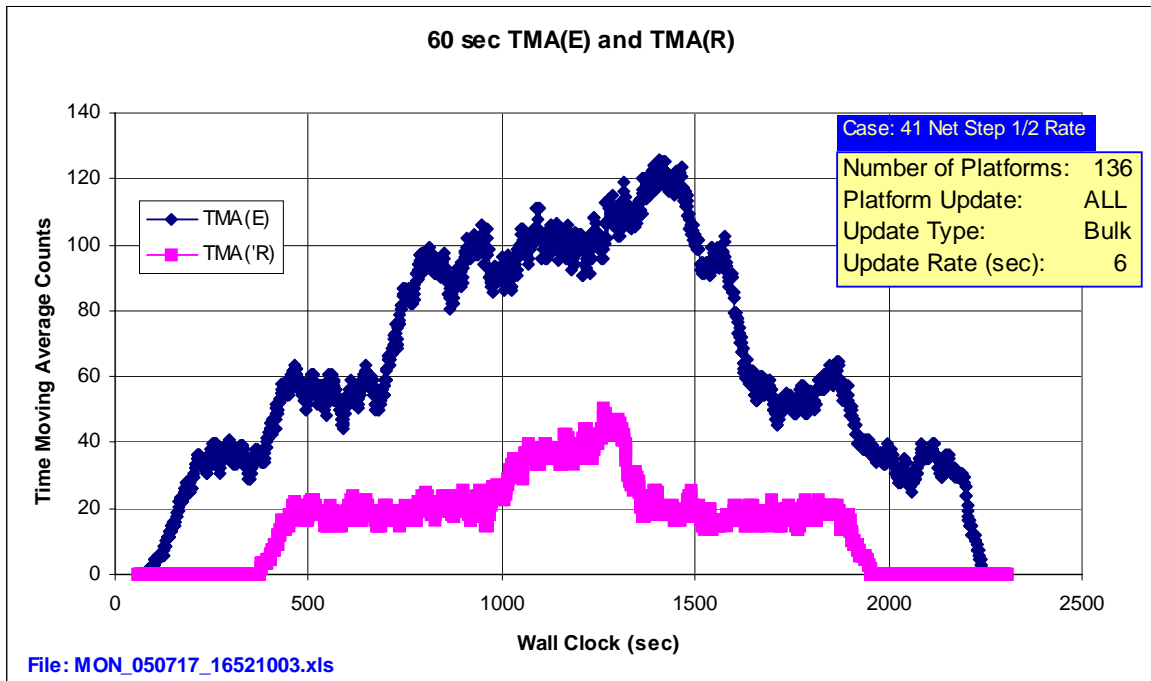


Figure 87 – 41 Net Step 1/2 Rate 6 sec Position Update 60 sec TMA(E) and TMA(R)

## B.8 41 Net Constant, 1/2 Rate, and Position Updates every 10 sec (Main PC)

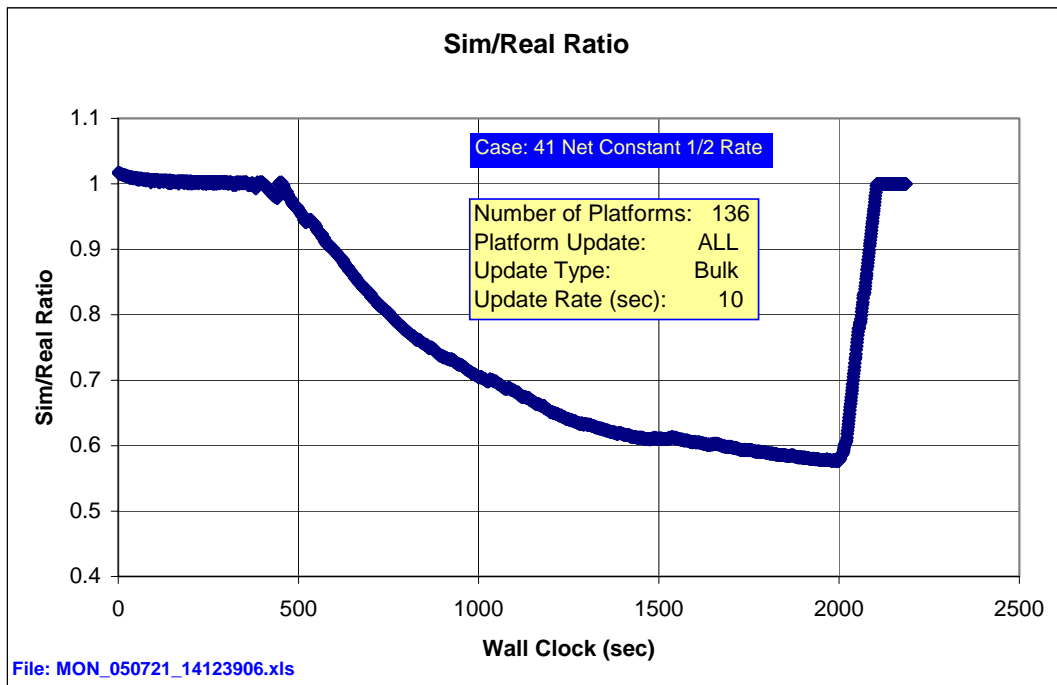


Figure 88 – 41 Net Constant 1/2 Rate Sim/Real Ratio

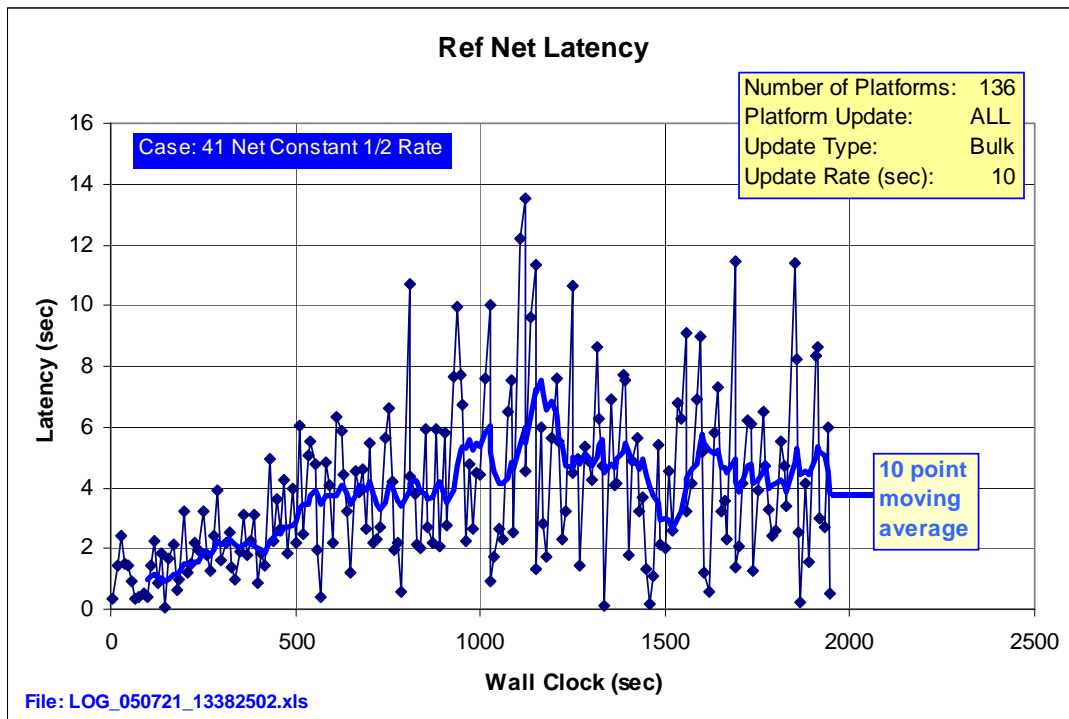
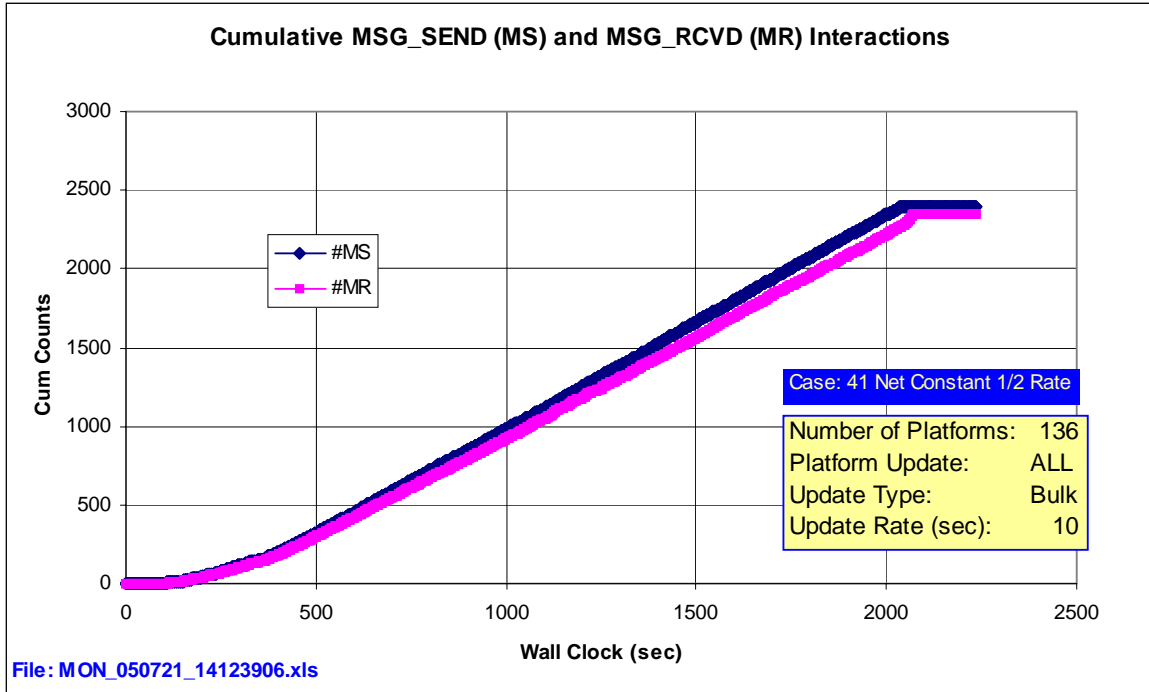
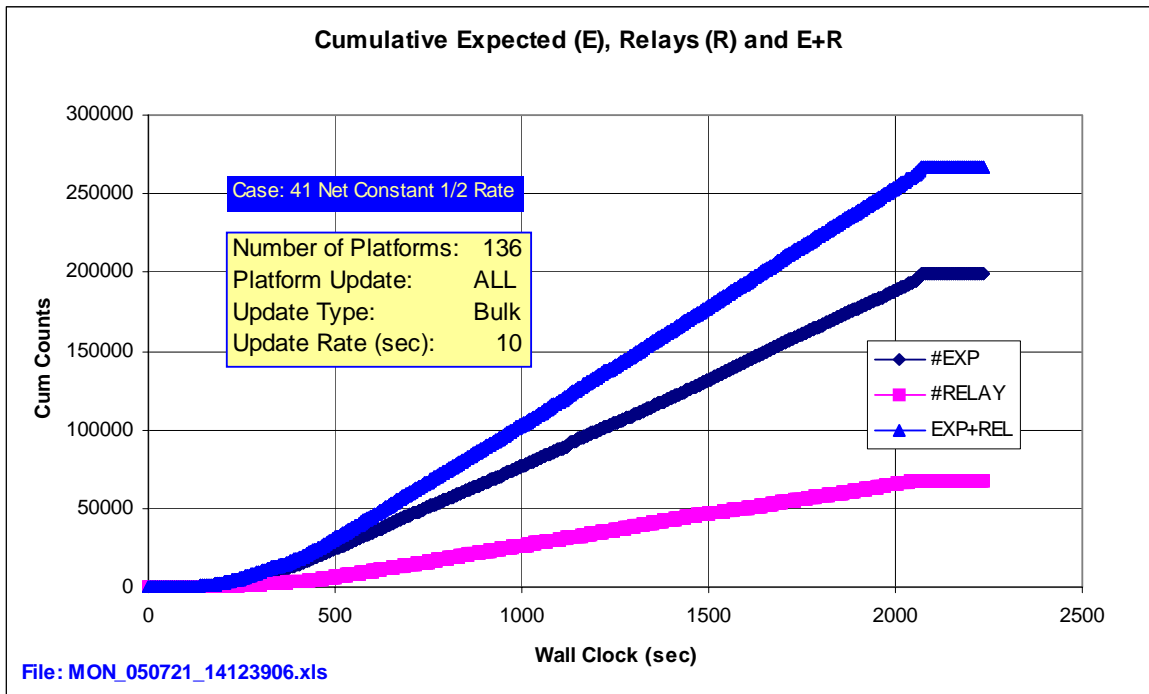


Figure 89 – 41 Net Constant 1/2 Rate Ref Net Latency



**Figure 90 – 41 Net Constant 1/2 Rate Cum MS and MR Interactions**



**Figure 91 – 41 Net Constant 1/2 Rate Cum E, R, and E+R**

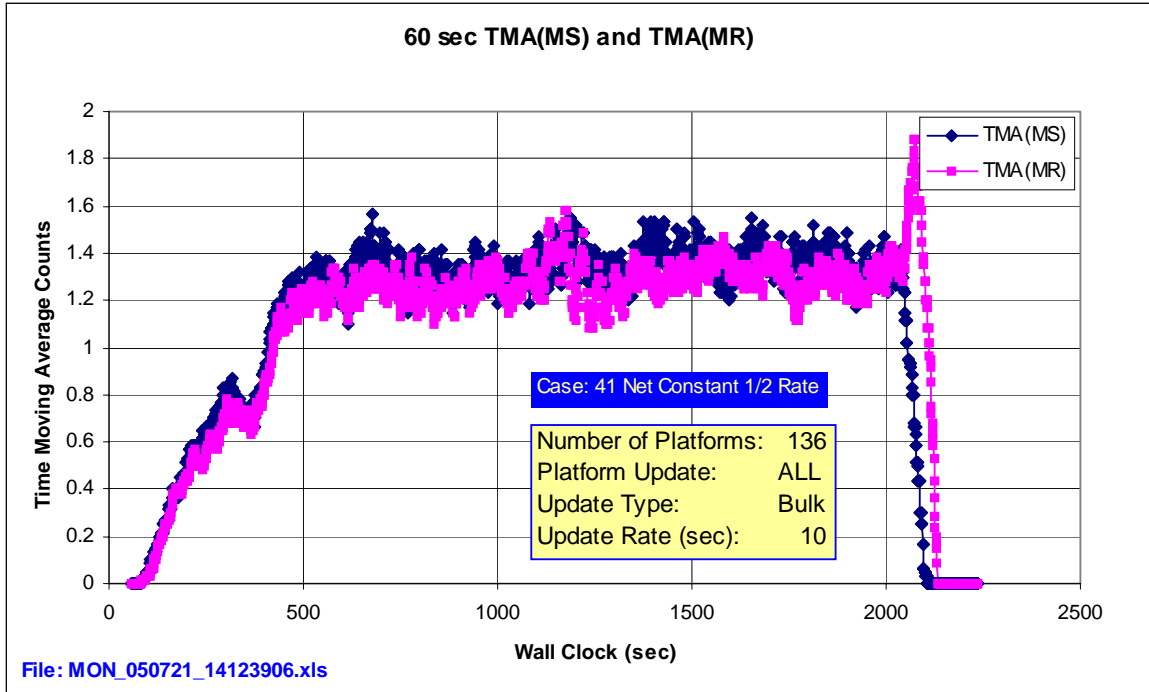


Figure 92 – 41 Net Constant 1/2 Rate 60 sec TMA(MS) and TMA(MR)

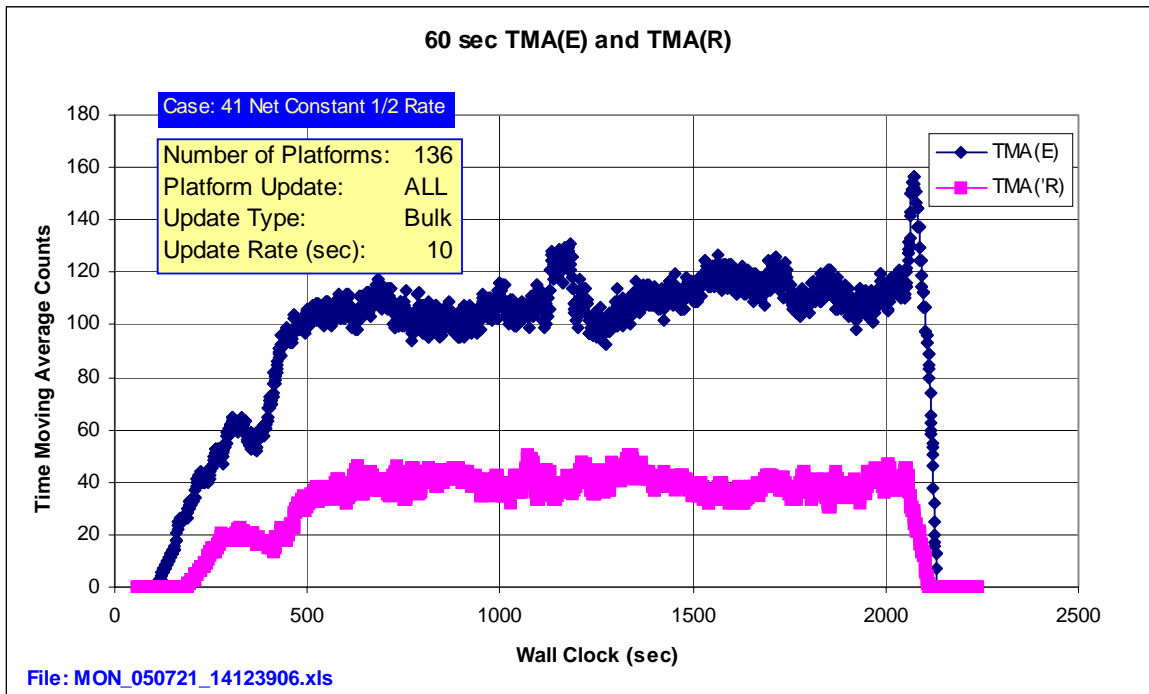


Figure 93 – 41 Net Constant 1/2 Rate 60 sec TMA(E) and TMA(R)

## B.9 10 Hour Run, 41 Net Constant, 1/2 Rate, and Position Updates every 10 sec (Main PC)

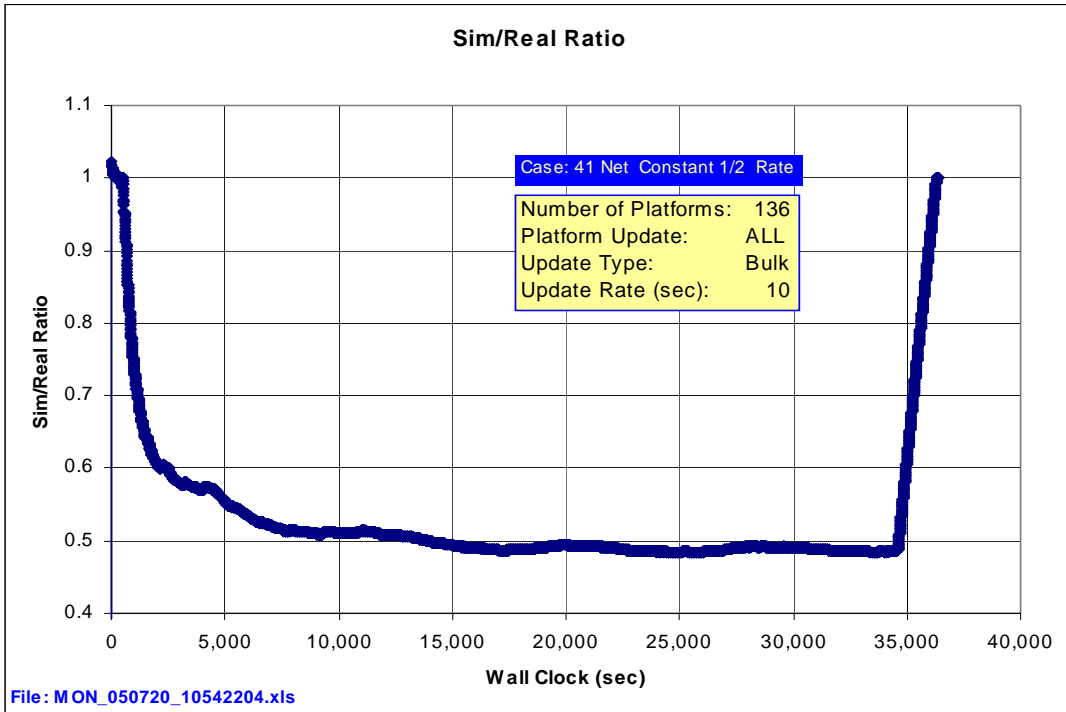


Figure 94 – 10 Hour Run 41 Net 1/2 Rate Sim/Real Ratio

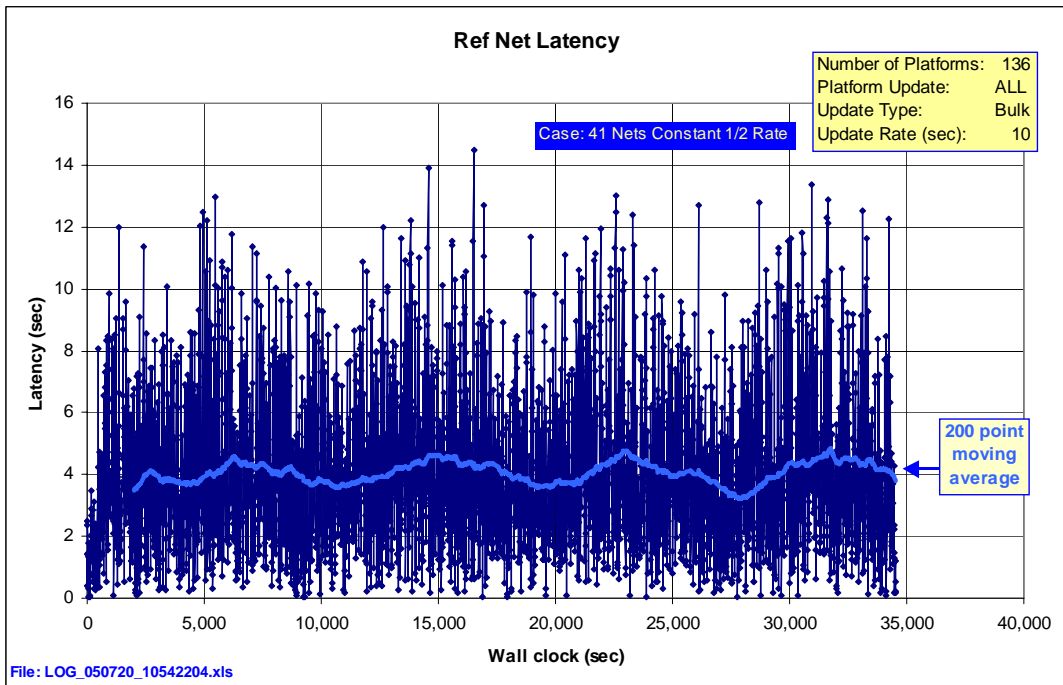
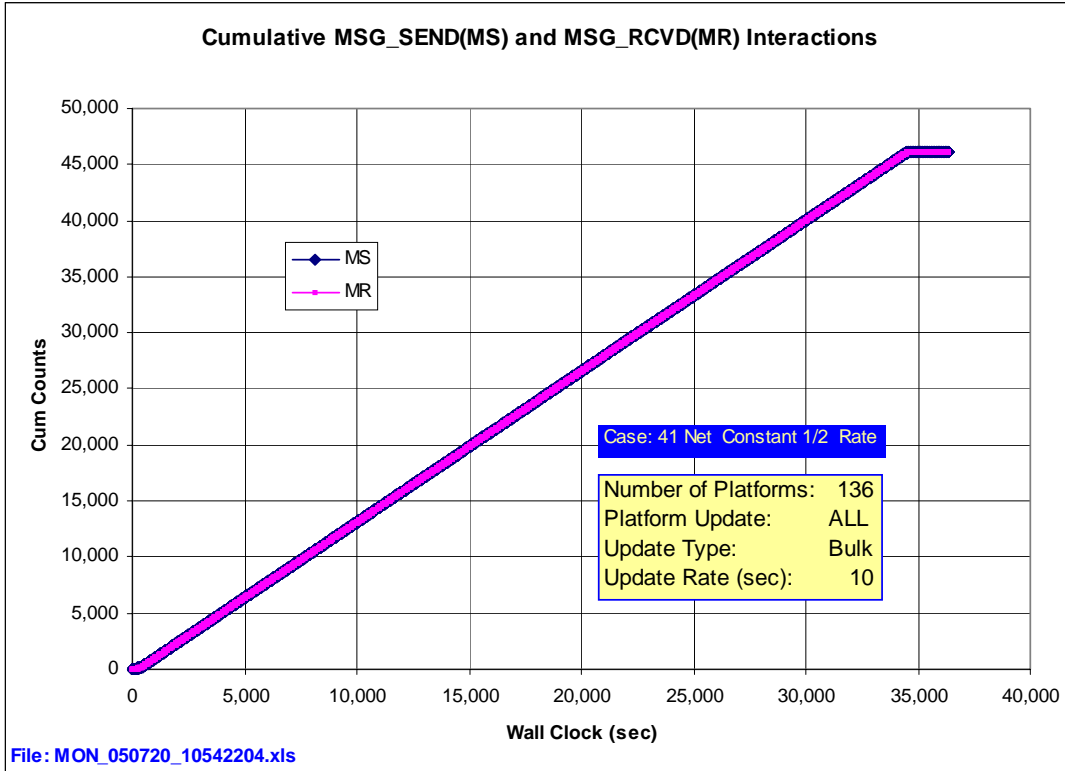
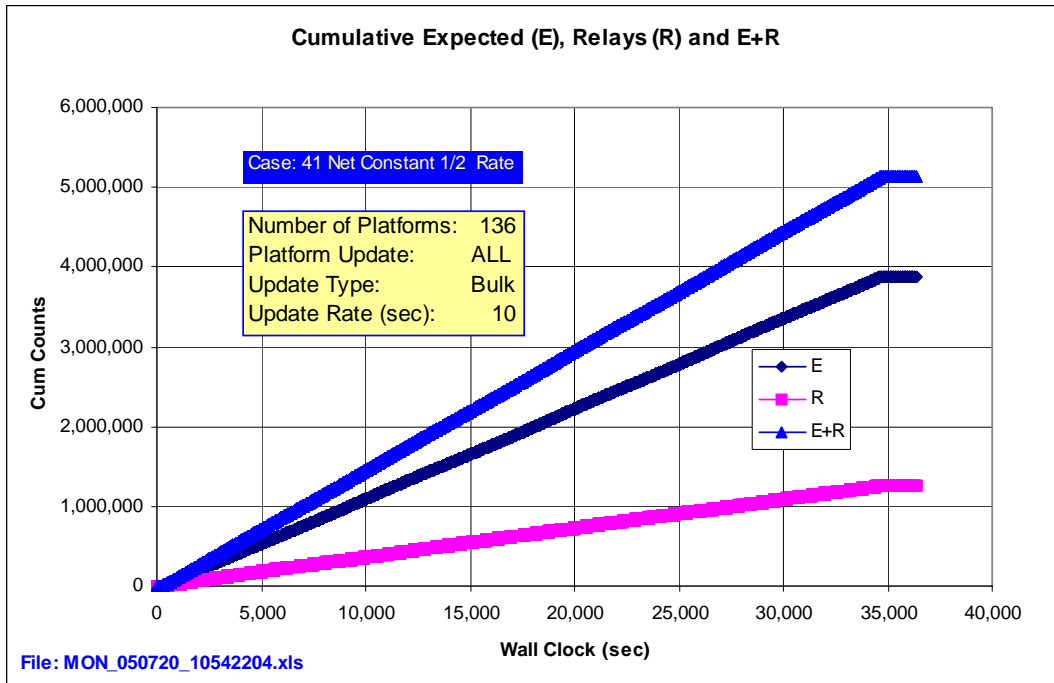


Figure 95 – 10 Hour Run 41 Net 1/2 Rate Ref Net Latency



**Figure 96 – 10 Hour Run 41 Net 1/2 Rate Cum MS and MR Interactions**



**Figure 97 – 10 Hour Run 41 Net 1/2 Rate Cum E, R, and E+R**

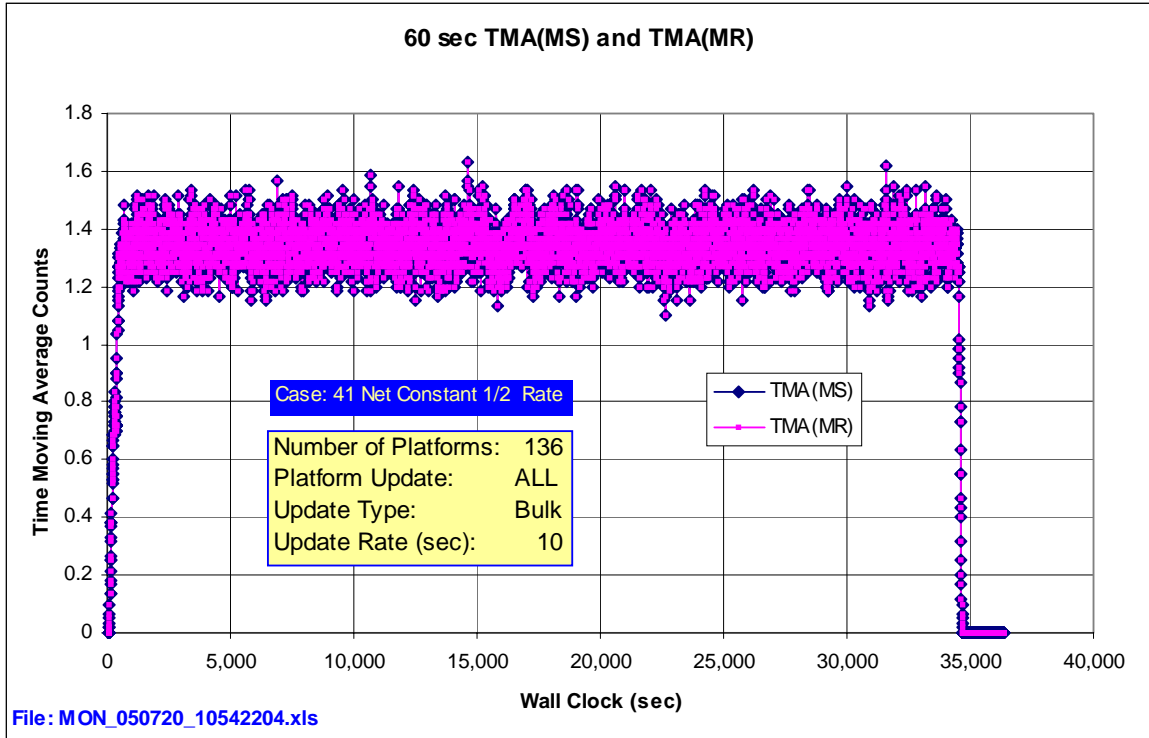


Figure 98 – 10 Hour Run 41 Net 1/2 Rate 60 sec TMA(MS) and TMA(MR)

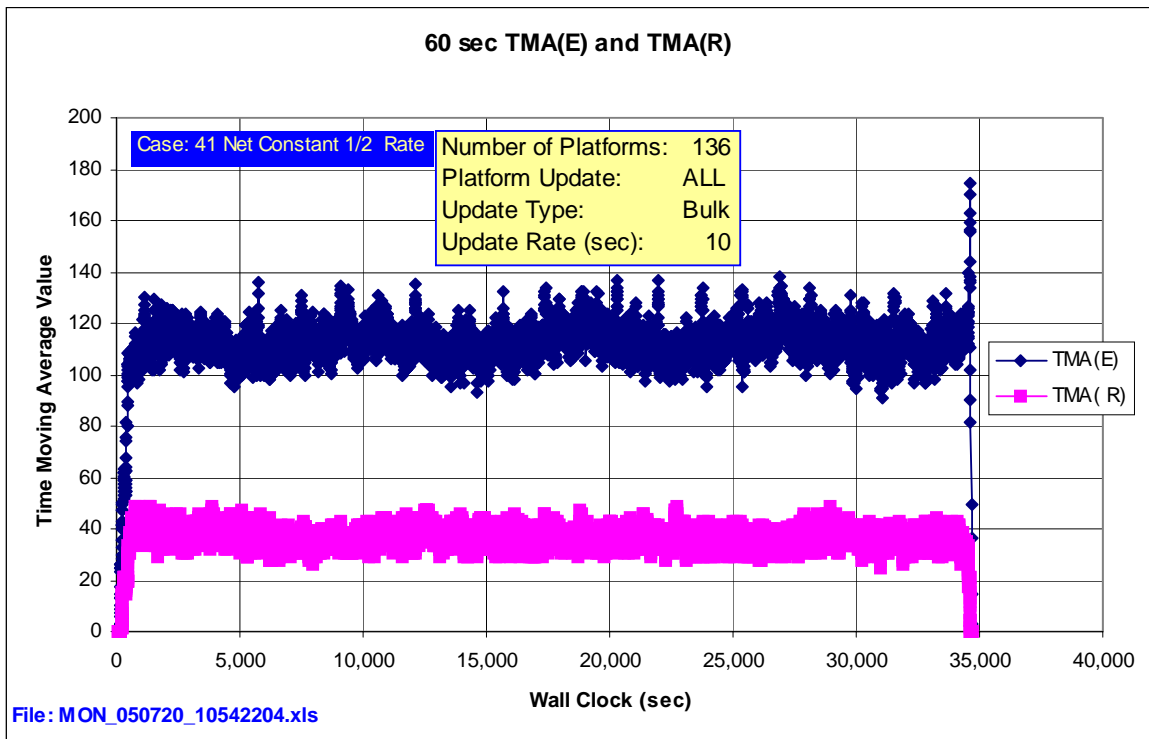


Figure 99 – 10 Hour Run 41 Net 1/2 Rate 60 sec TMA(E) and TMA(R)

## B.10 41 Net Step, 1/4 Rate, and Position Updates every 10 sec (Laptop)

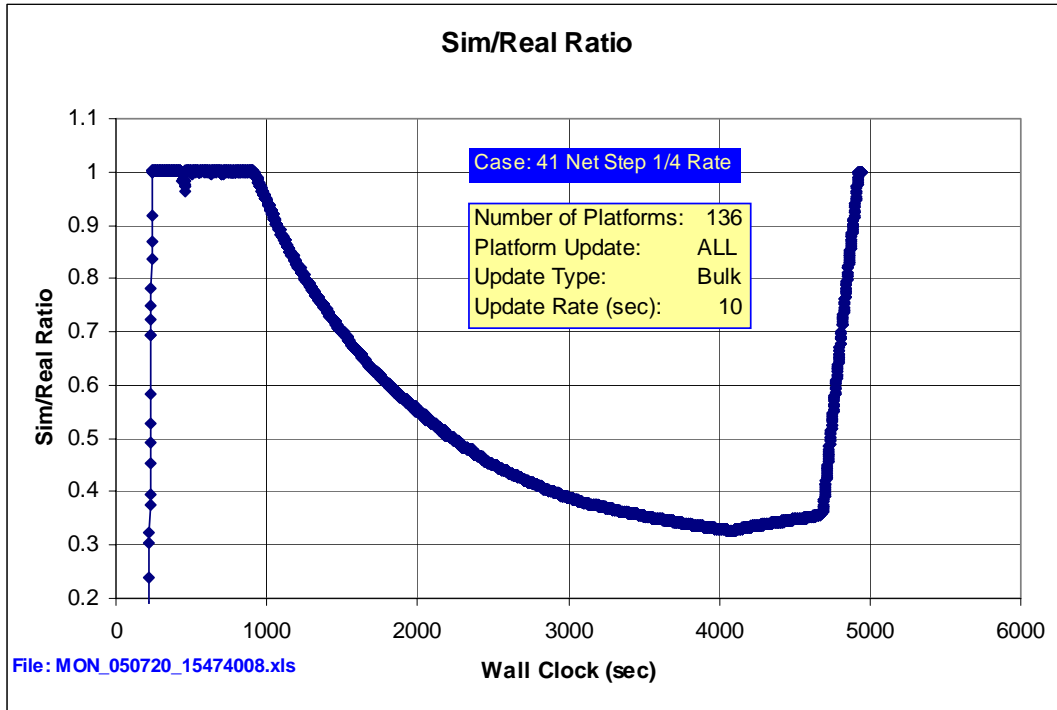


Figure 100 – Laptop Run 41 Net Step 1/4 Rate Sim/Real Ratio

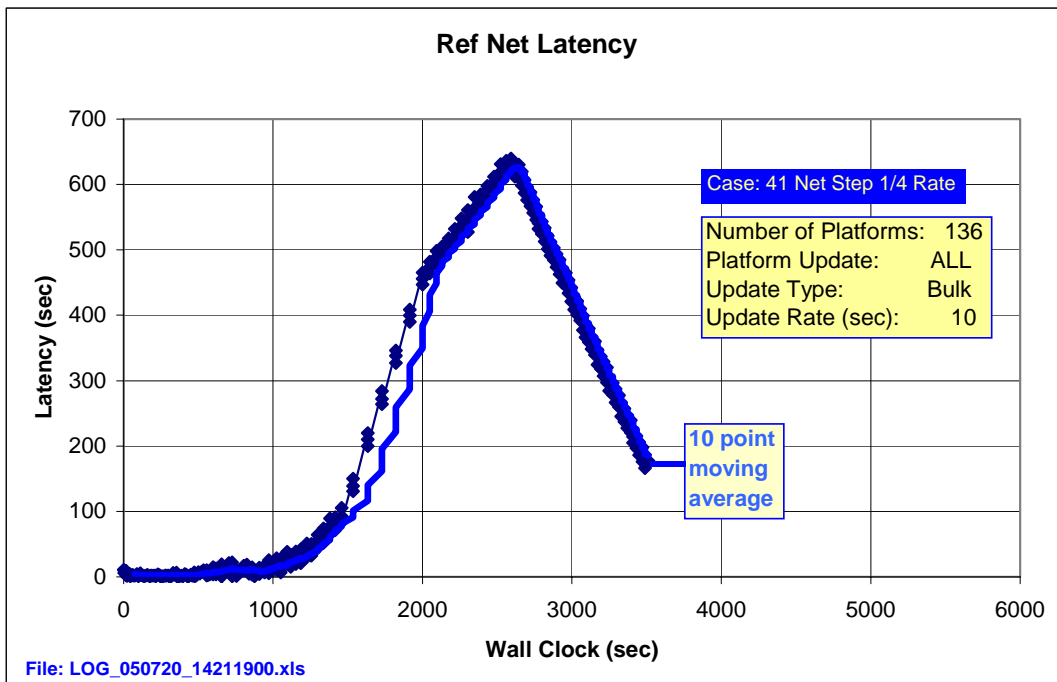


Figure 101 – Laptop Run 41 Net Step 1/4 Rate Ref Net Latency

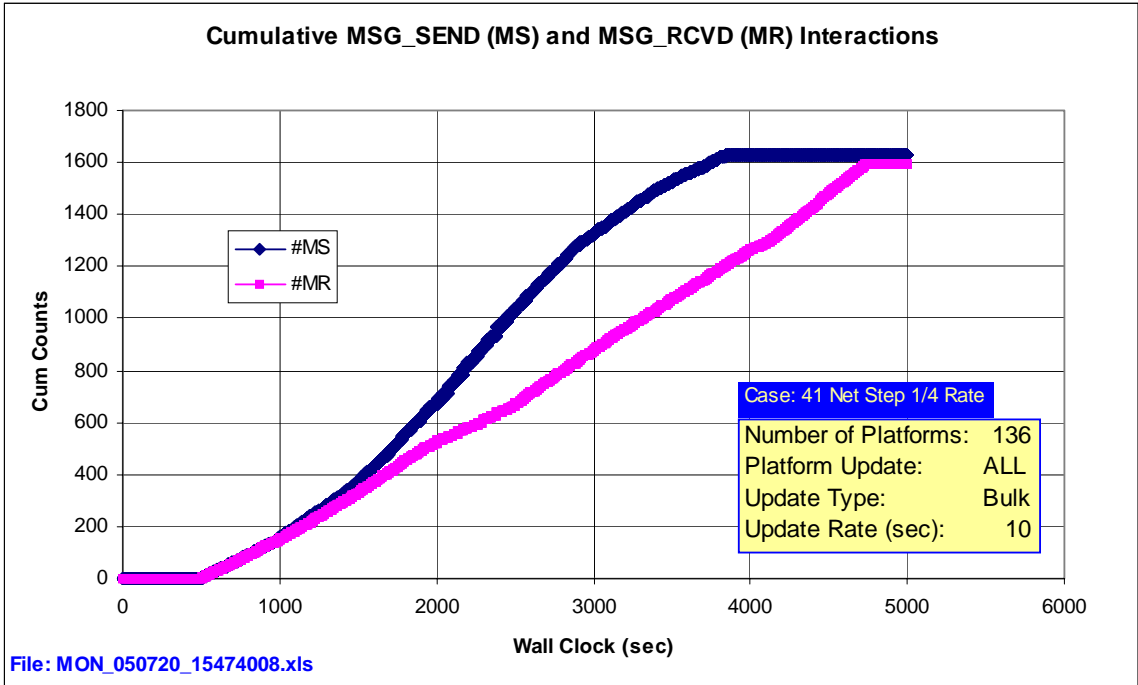


Figure 102 – Laptop Run 41 Net Step 1/4 Rate Cum MS and MR Interactions

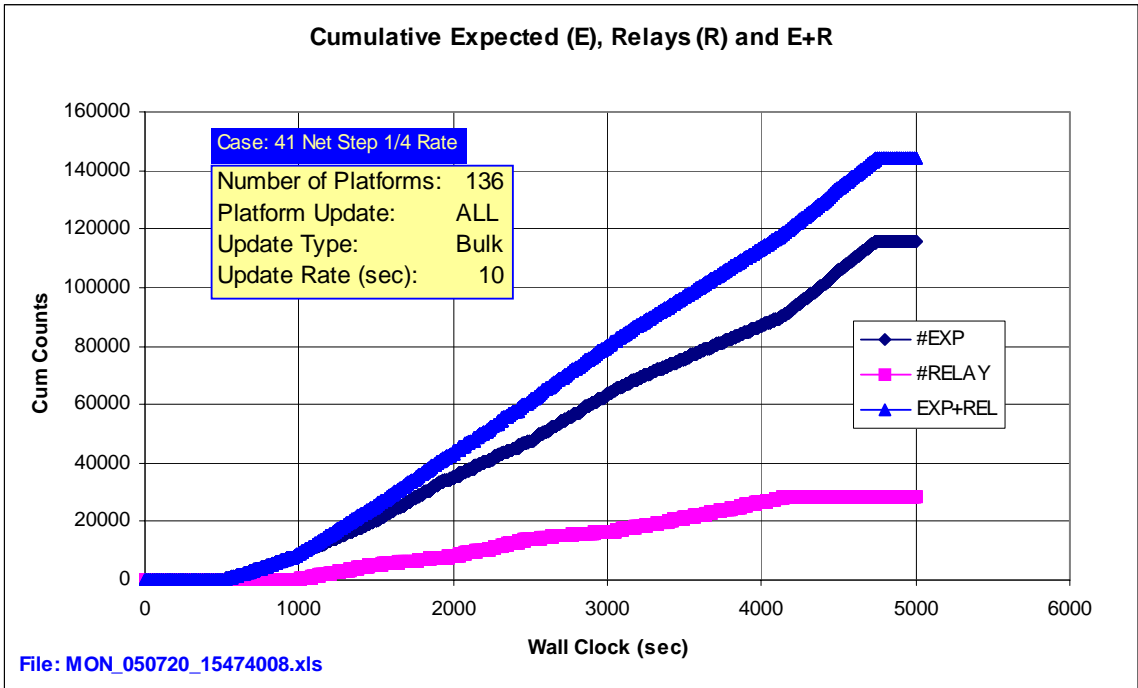


Figure 103 – Laptop Run 41 Net Step 1/4 Rate Cum E, R, E+R

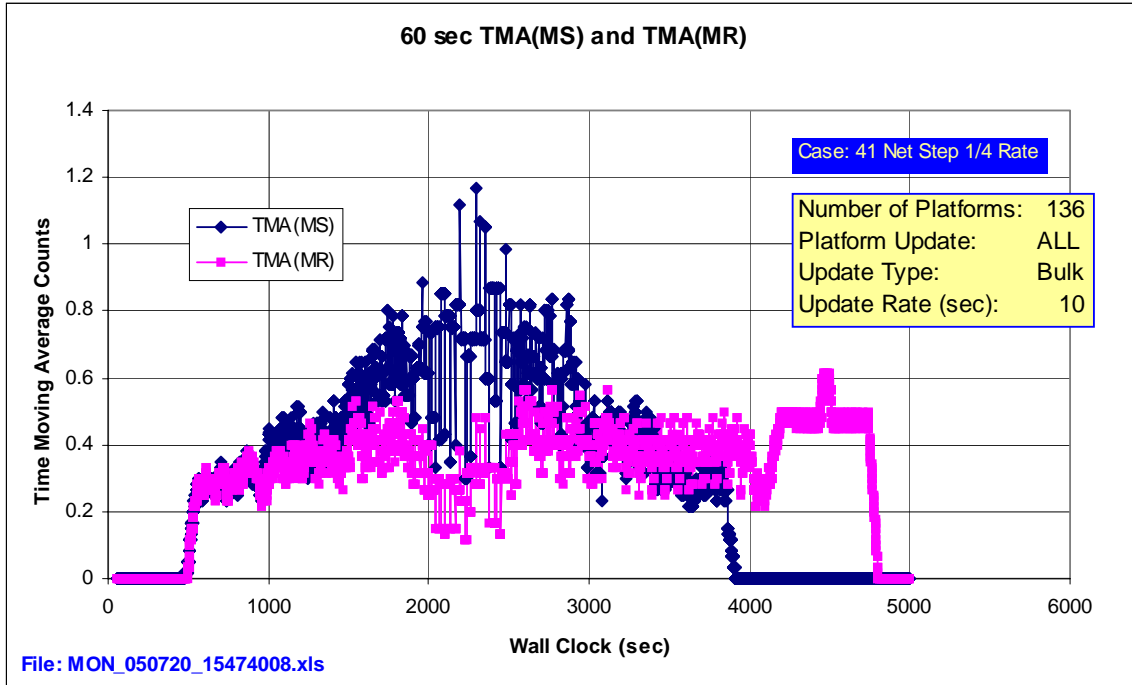


Figure 104 – Laptop Run 41 Net Step 1/4 Rate 60 sec TMA(MS) and TMA(MR)

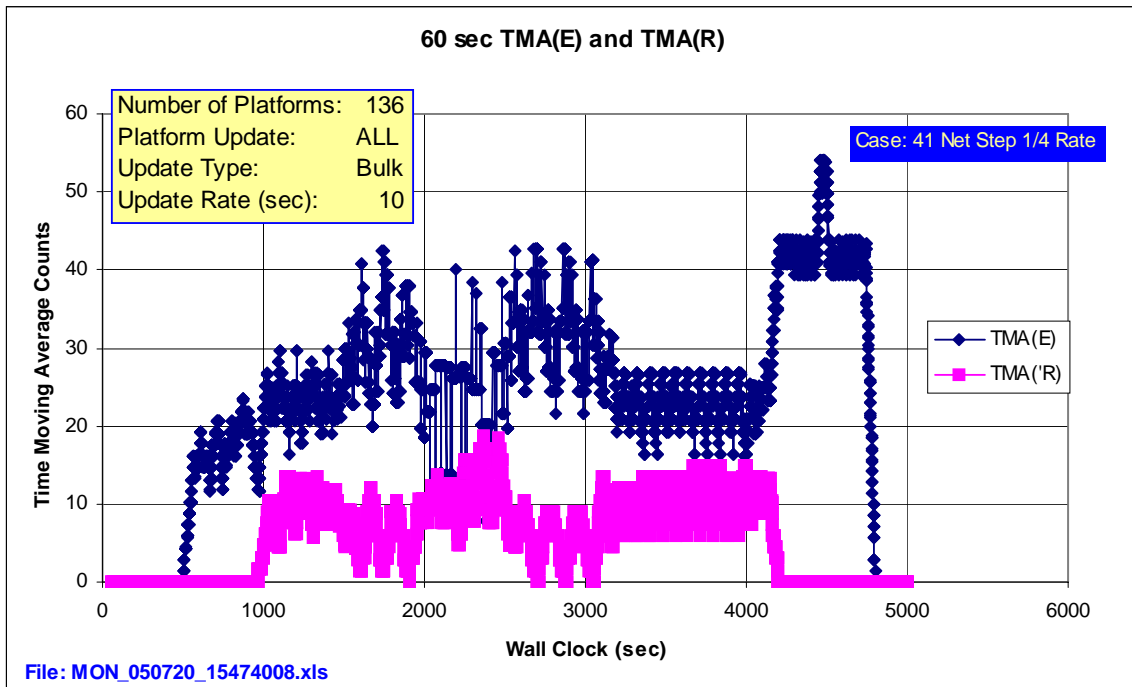


Figure 105 – Laptop Run 41 Net Step 1/4 Rate 60 sec TMA(E) and TMA(R)

## B.11 41 Net Step, 1/2 Rate, and Position Updates every 10 sec (Laptop)

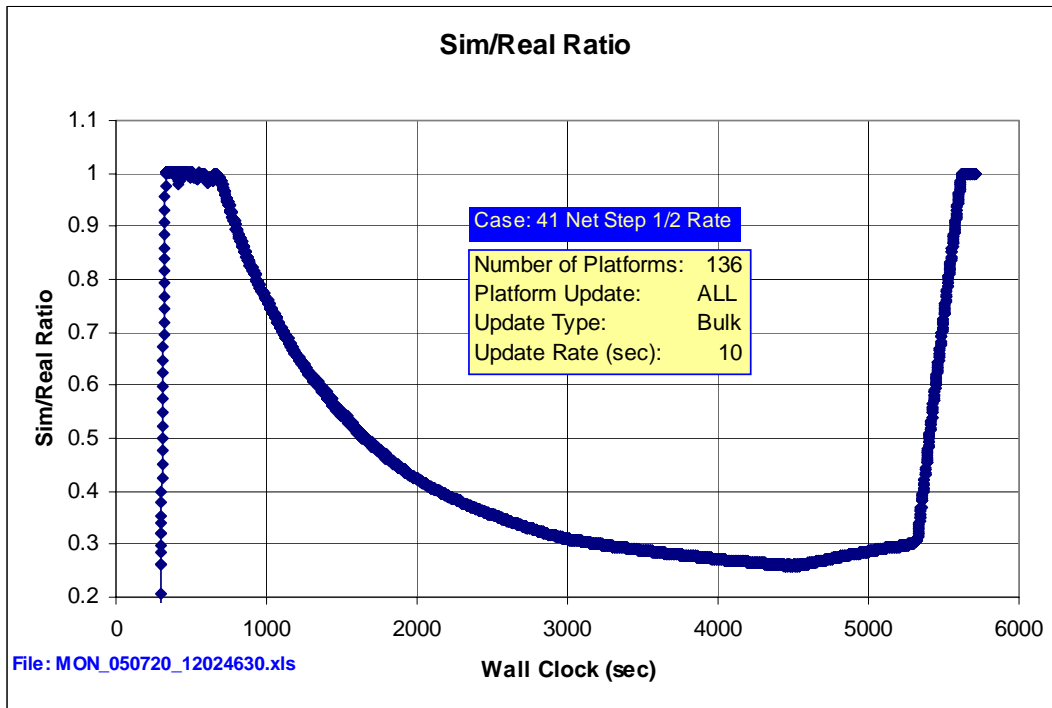


Figure 106 – Laptop Run 41 Net Step 1/2 Rate Sim/Real Ratio

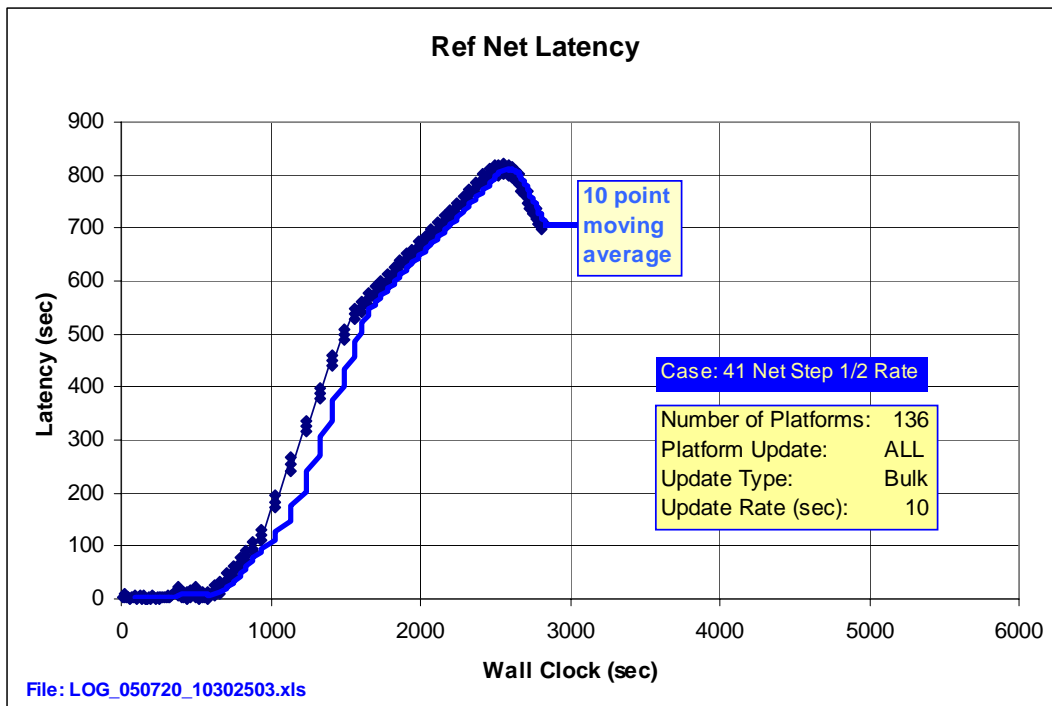


Figure 107 – Laptop Run 41 Net Step 1/2 Rate Ref Net Latency

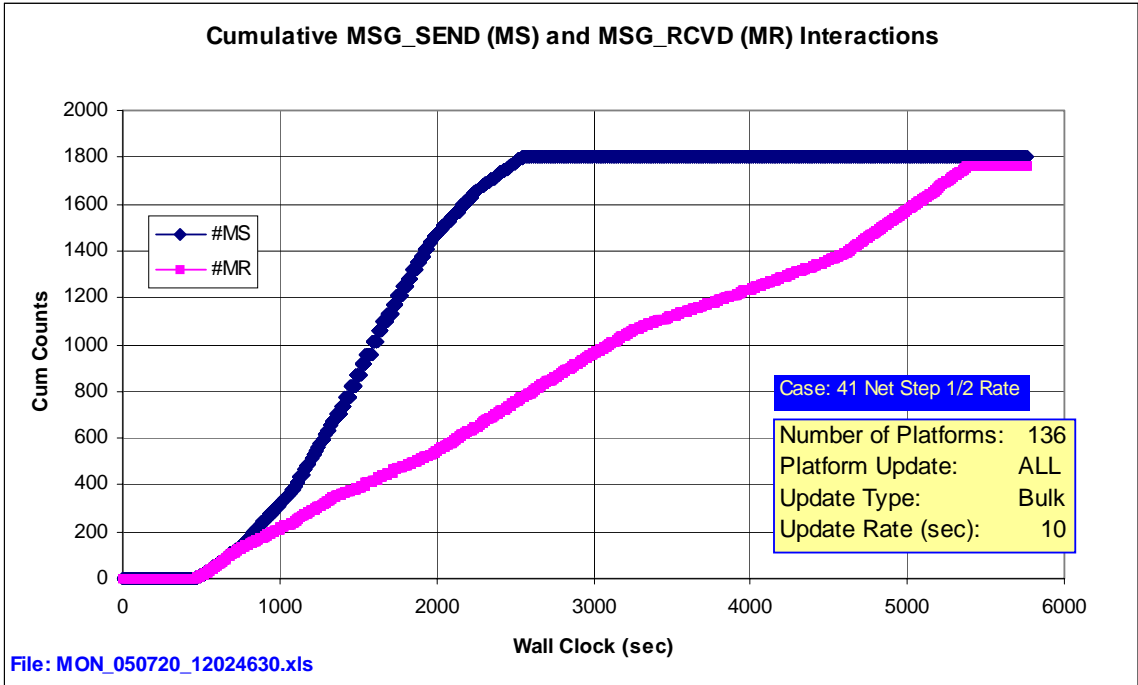


Figure 108 – Laptop Run 41 Net Step 1/2 Rate Cum MS and MR Interactions

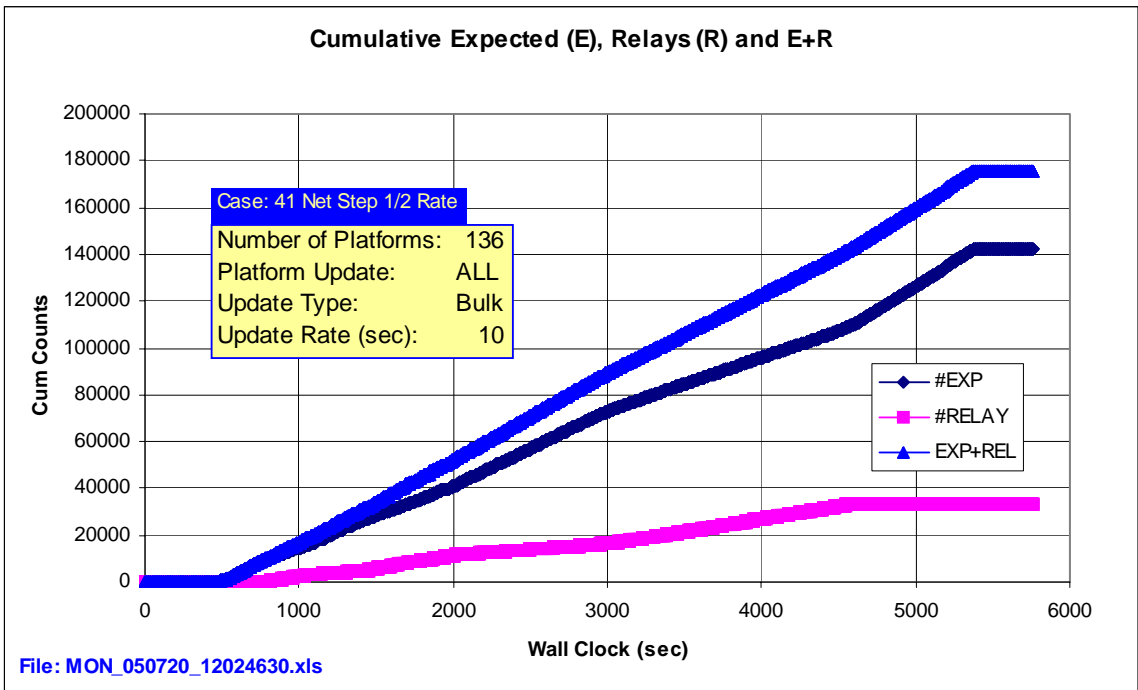
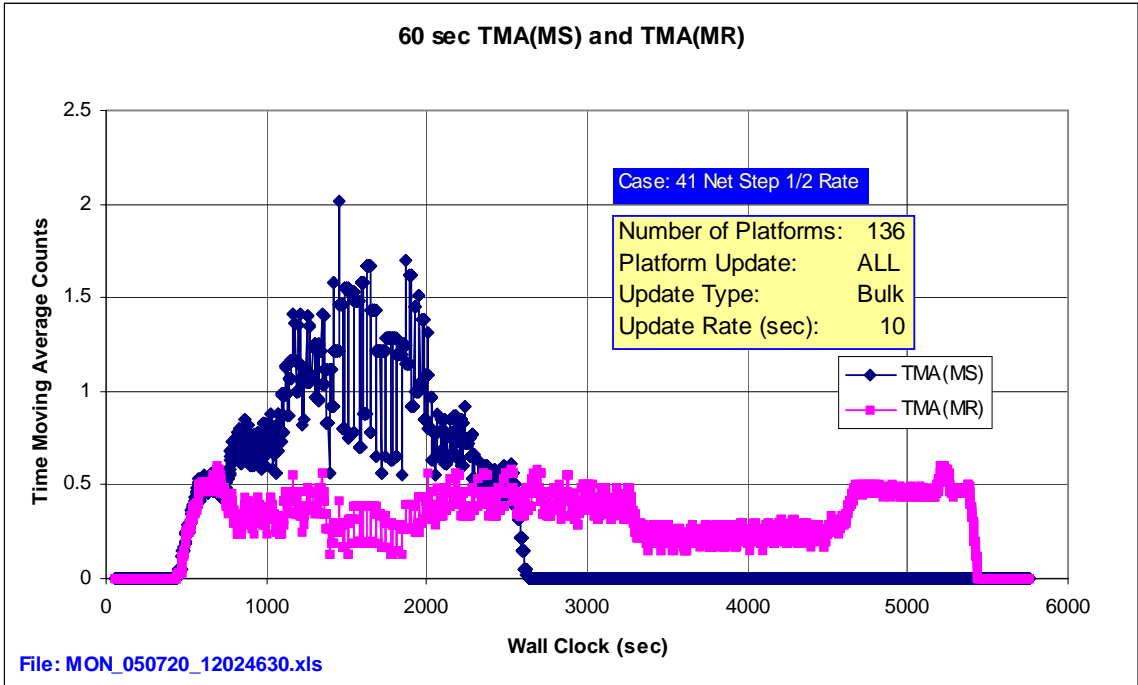
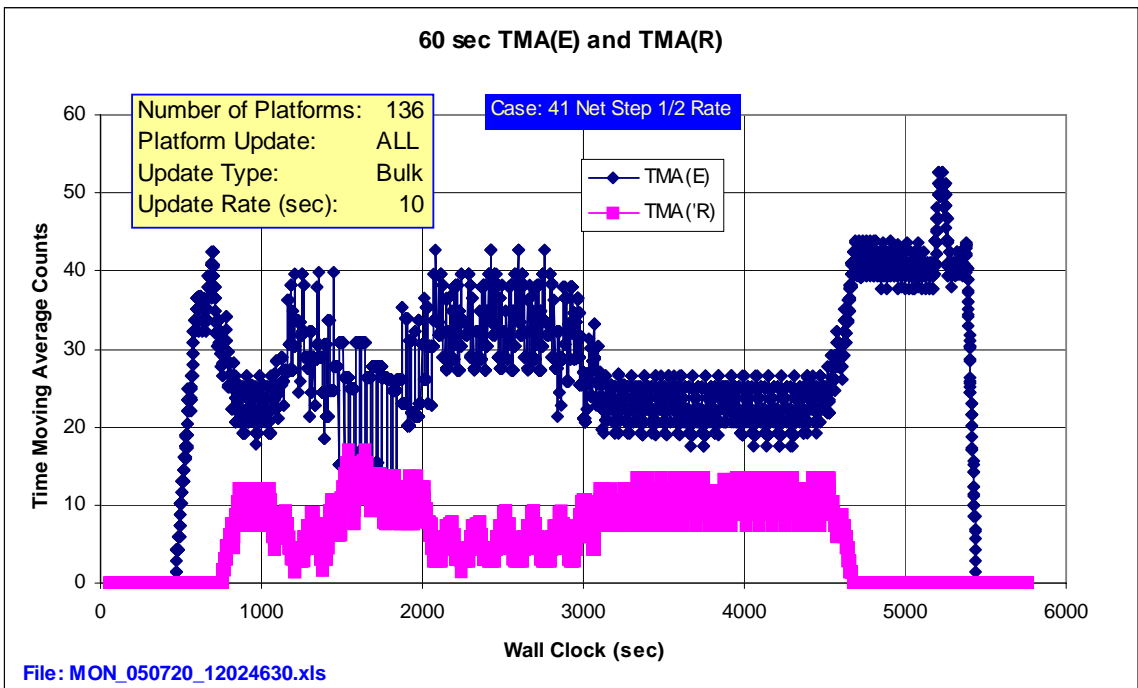


Figure 109 – Laptop Run 41 Net Step 1/2 Rate Cum E, R, and E+R



**Figure 110 – Laptop Run 41 Net Step 1/2 Rate 60 sec TMA(MS) and TMA(MR)**



**Figure 111 – Laptop Run 41 Net Step 1/2 Rate 60 sec TMA(E) and TMA(R)**

## B.12 41 Net Step, 1/2 Rate, and Position Updates every 10 sec (Dif. PC)

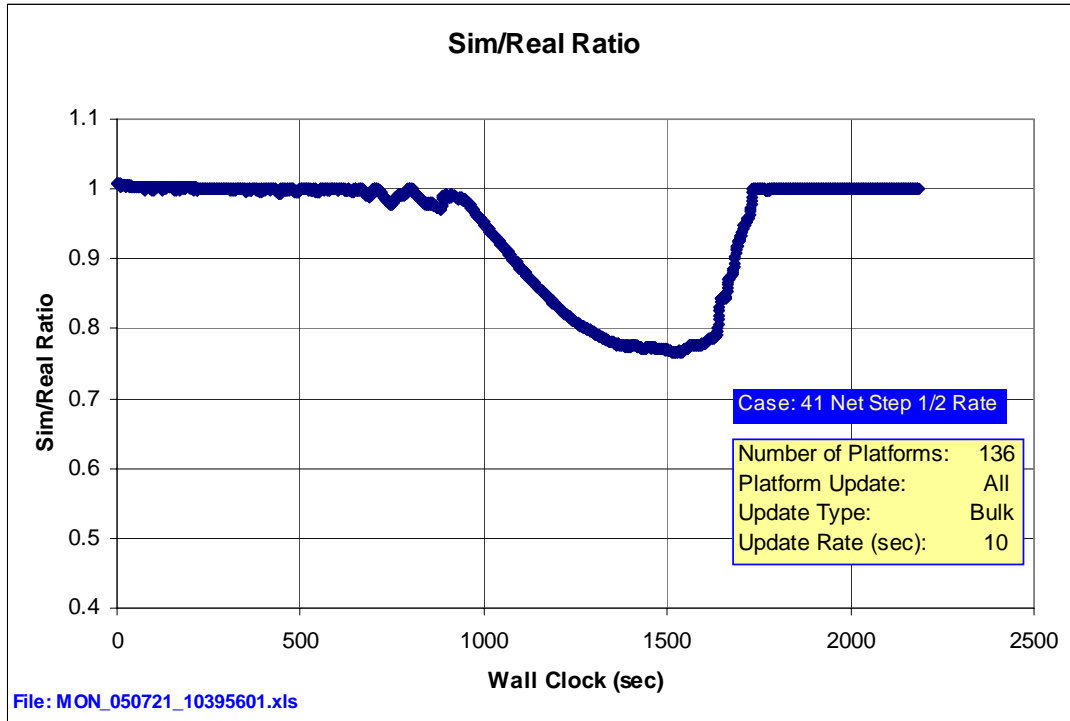


Figure 112 – Dif. PC Run 41 Net Step 1/2 Rate Sim/Real Ratio

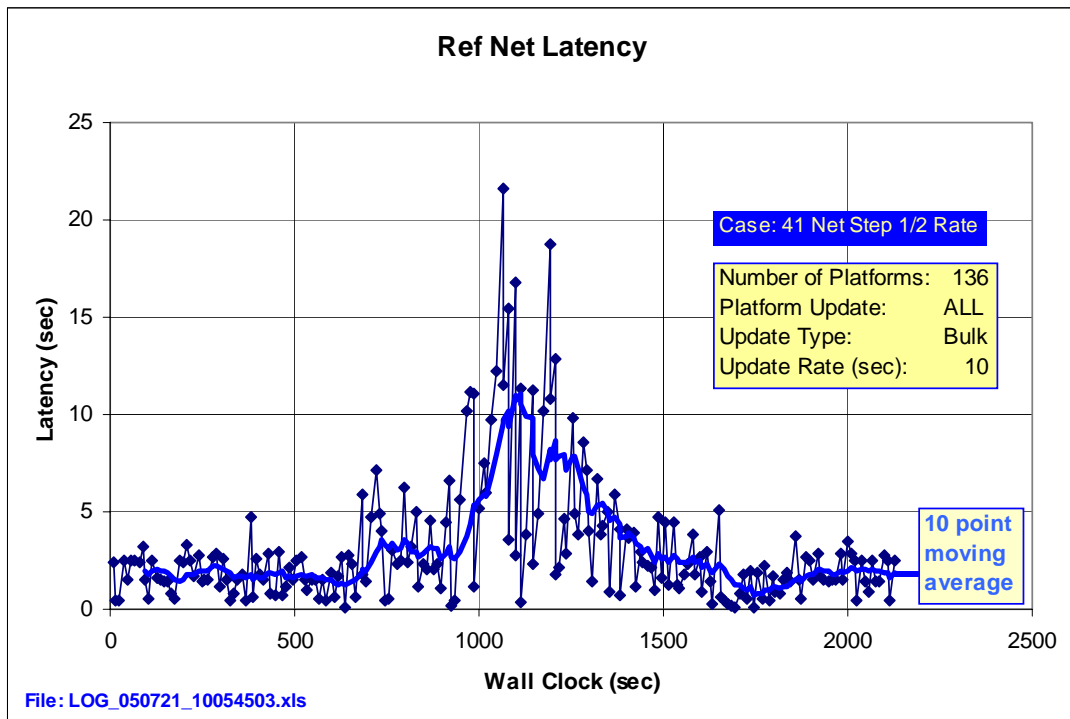
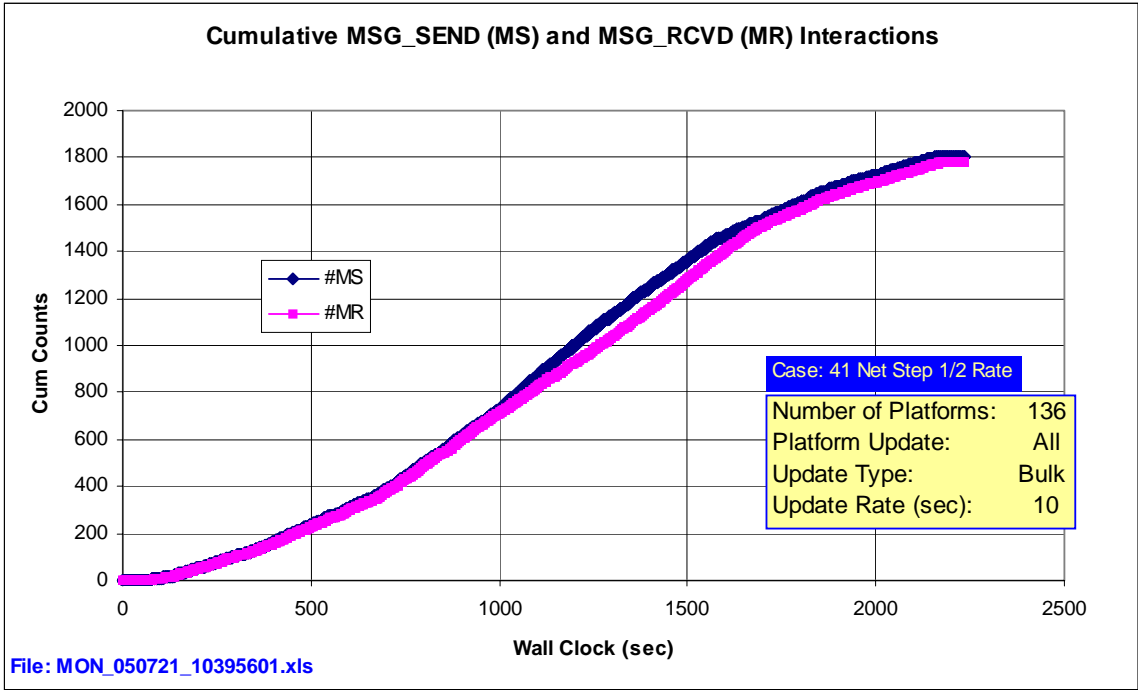
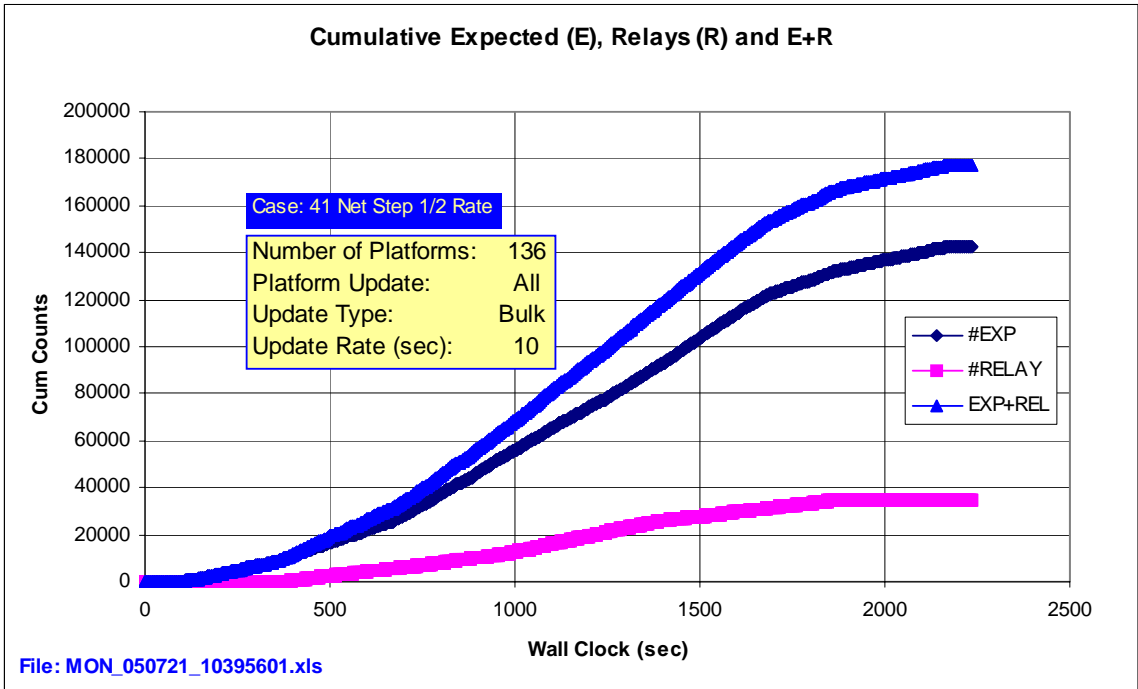


Figure 113 – Dif. PC Run 41 Net Step 1/2 Rate Ref Net Latency



**Figure 114 – Dif. PC Run 41 Net Step 1/2 Rate Cum MS and MR Interactions**



**Figure 115 – Dif. PC Run 41 Net Step 1/2 Rate Cum E, R, E+R**

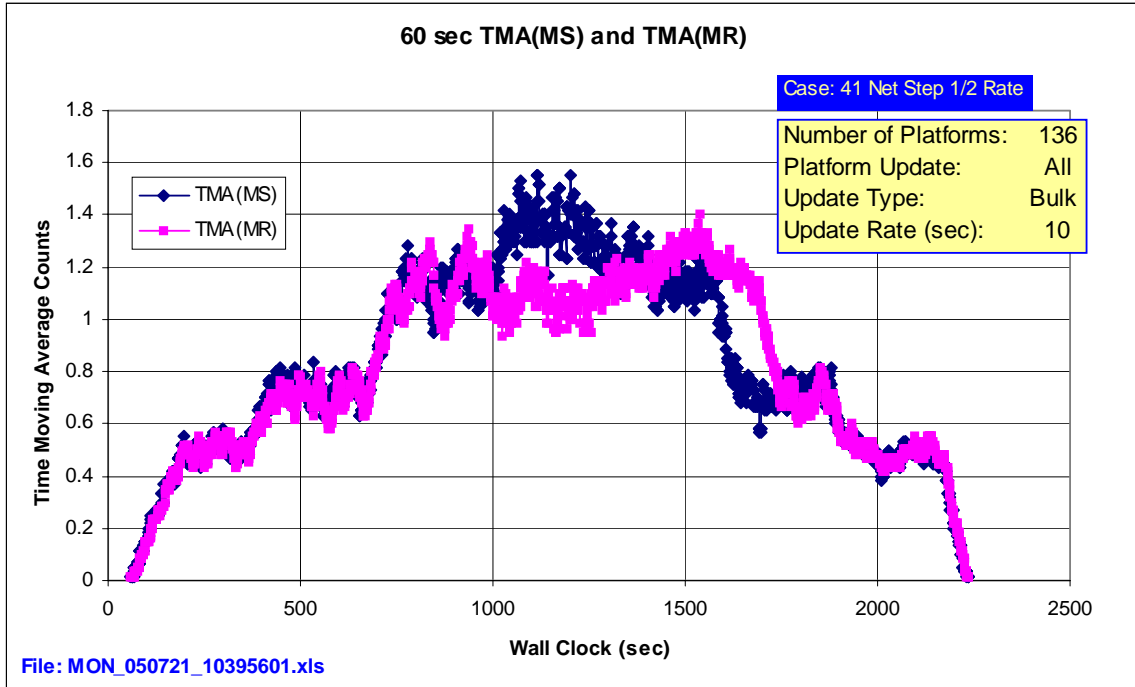


Figure 116 – Dif. PC Run 41 Net Step 1/2 Rate 60 sec TMA(MS) and TMA(MR)

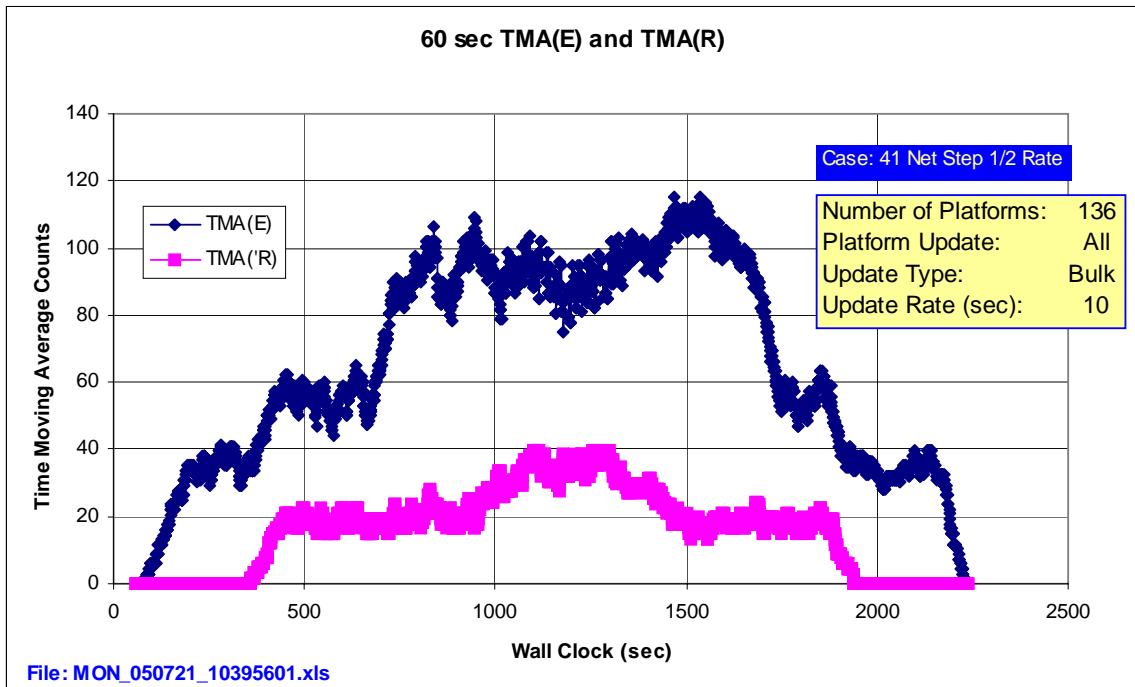
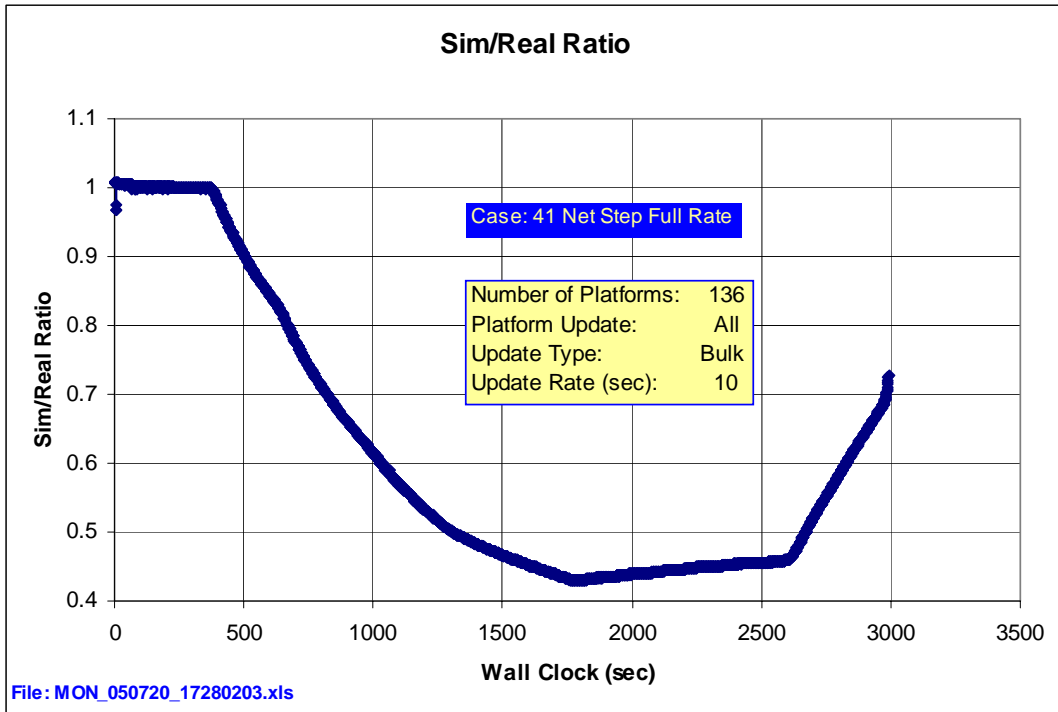
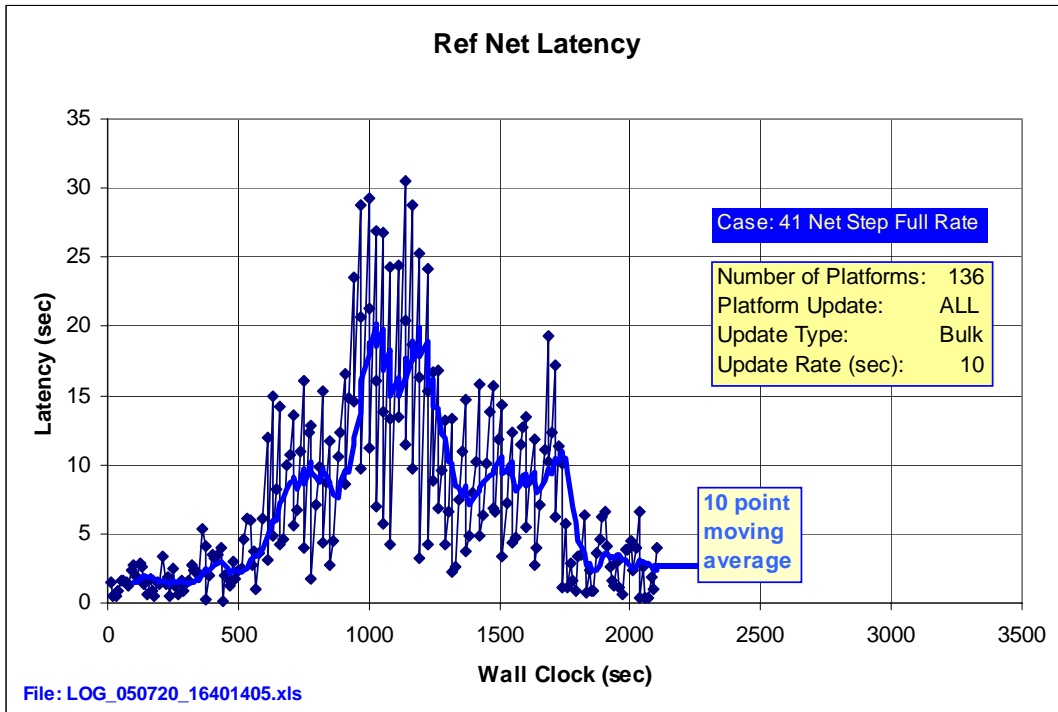


Figure 117 – Dif. PC Run 41 Net Step 1/2 Rate 60 sec TMA(E) and TMA(R)

**B.13 41 Net Step, Full Rate, and Position Updates every 10 sec (Dif. PC)**



**Figure 118 – Dif. PC Run 41 Net Step Full Rate Sim/Real Ratio**



**Figure 119 – Dif. PC Run 41 Net Step Full Rate Ref Net Latency**

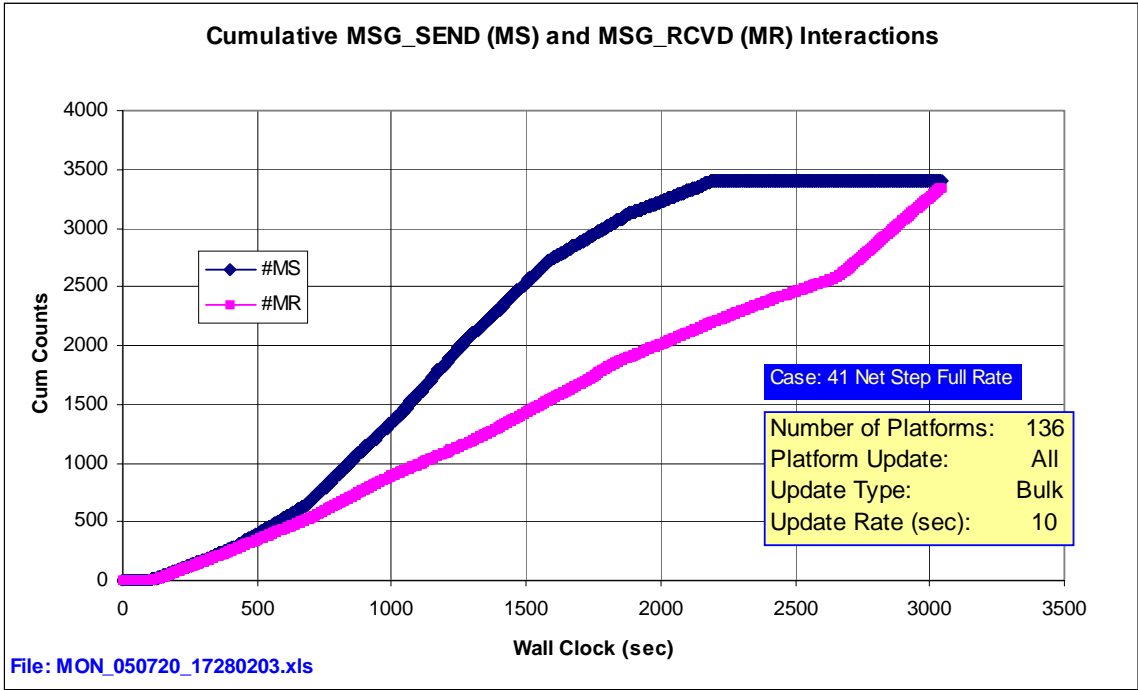


Figure 120 – Dif. PC Run 41 Net Step Full Rate Cum MS and MR Interactions

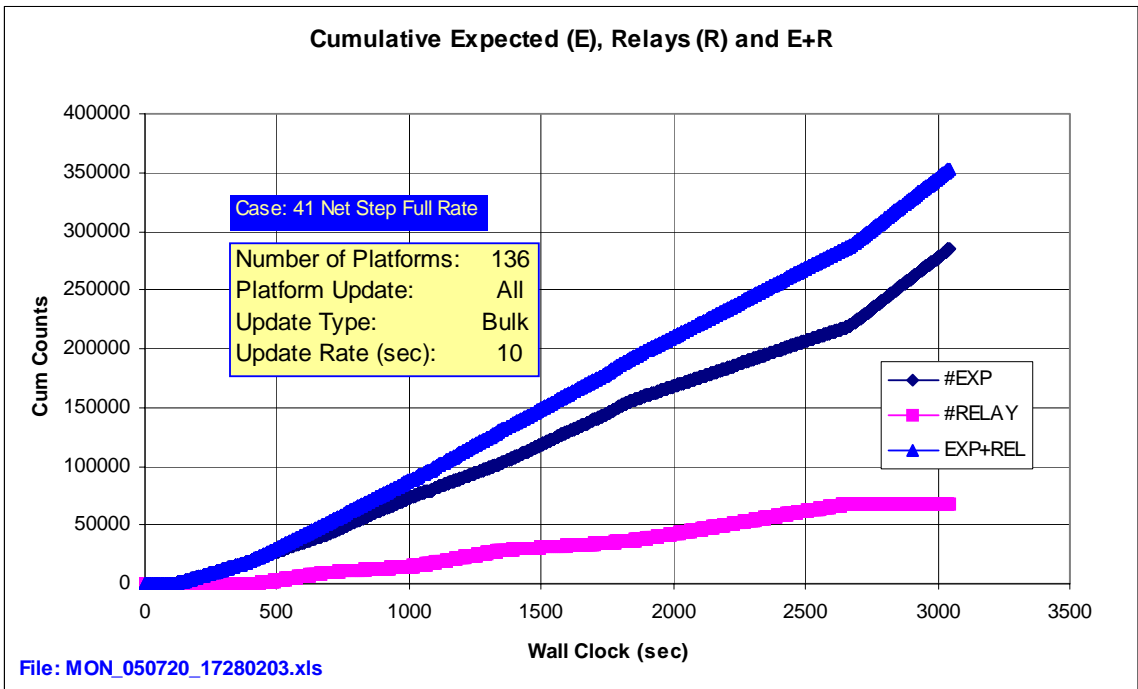


Figure 121 – Dif. PC Run 41 Net Step Full Rate Cum E, R, E+R

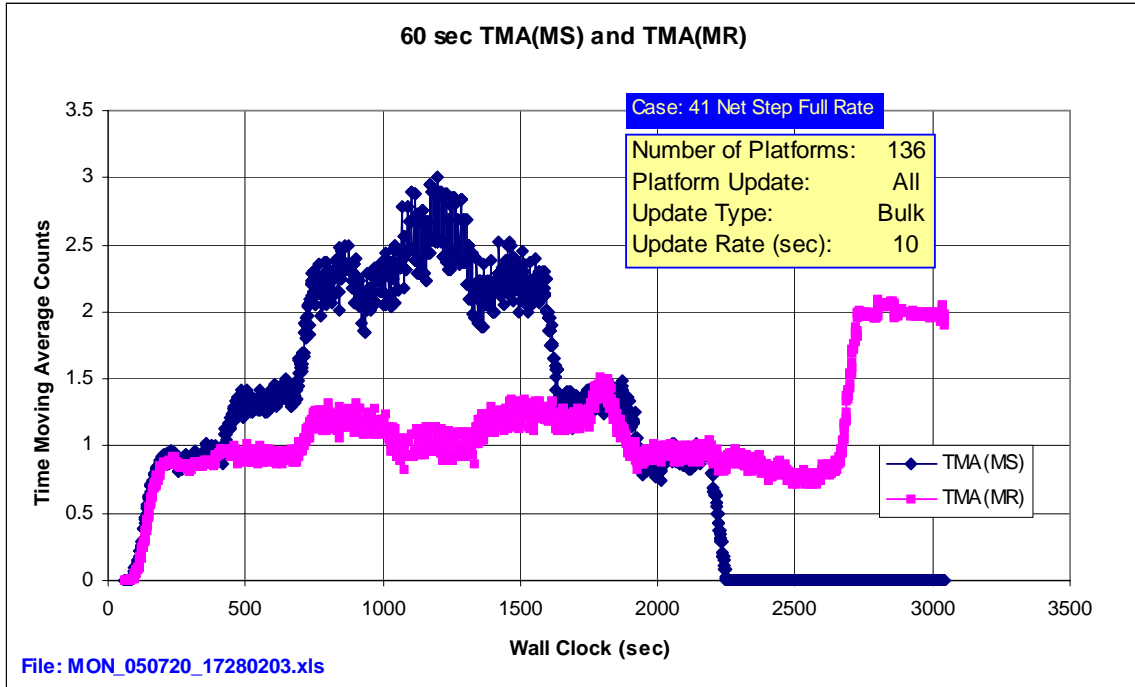


Figure 122 – Dif. PC Run 41 Net Step Full Rate 60 sec TMA(MS) and TMA(MR)

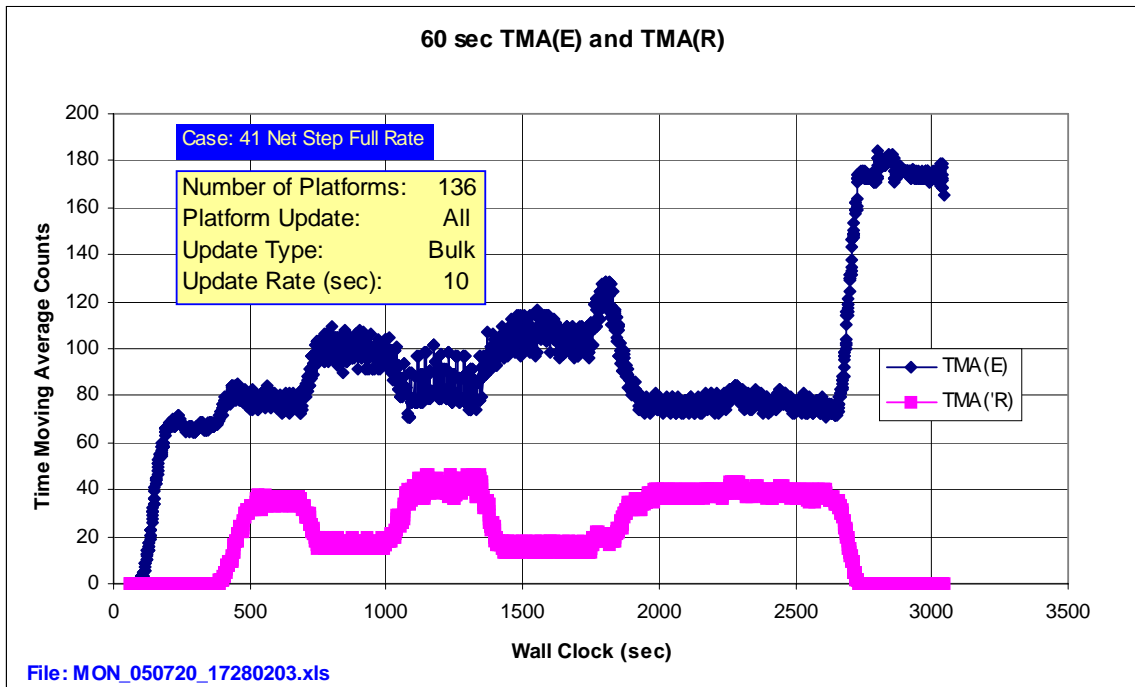


Figure 123 – Dif. PC Run 41 Net Step Full Rate 60 sec TMA(E) and TMA(R)

### B.14 81 Net Step, 1/2 Rate, and Position Updates every 10 sec (Main PC)

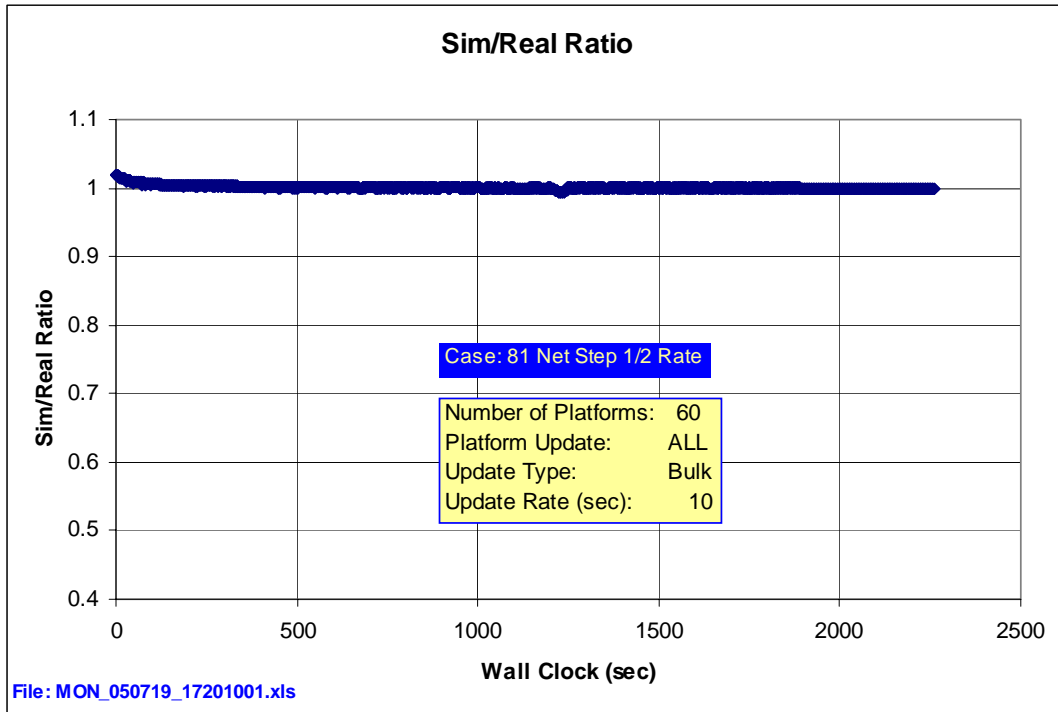


Figure 124 – 81 Net Step 1/2 Rate Sim/Real Ratio

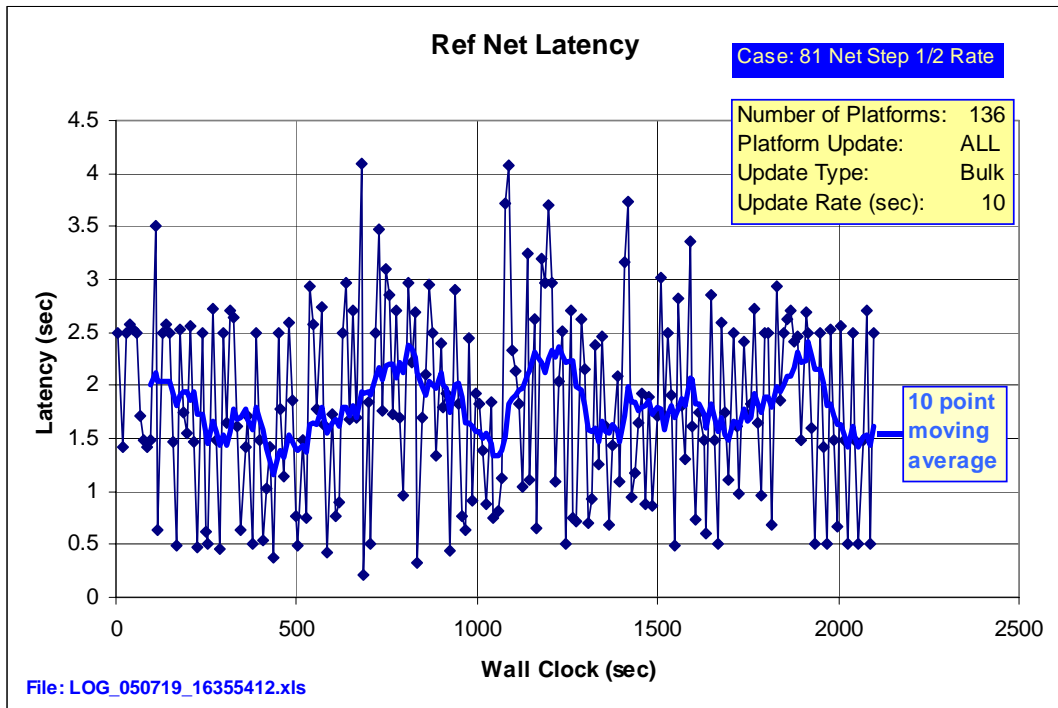


Figure 125 – 81 Net Step 1/2 Rate Ref Net Latency

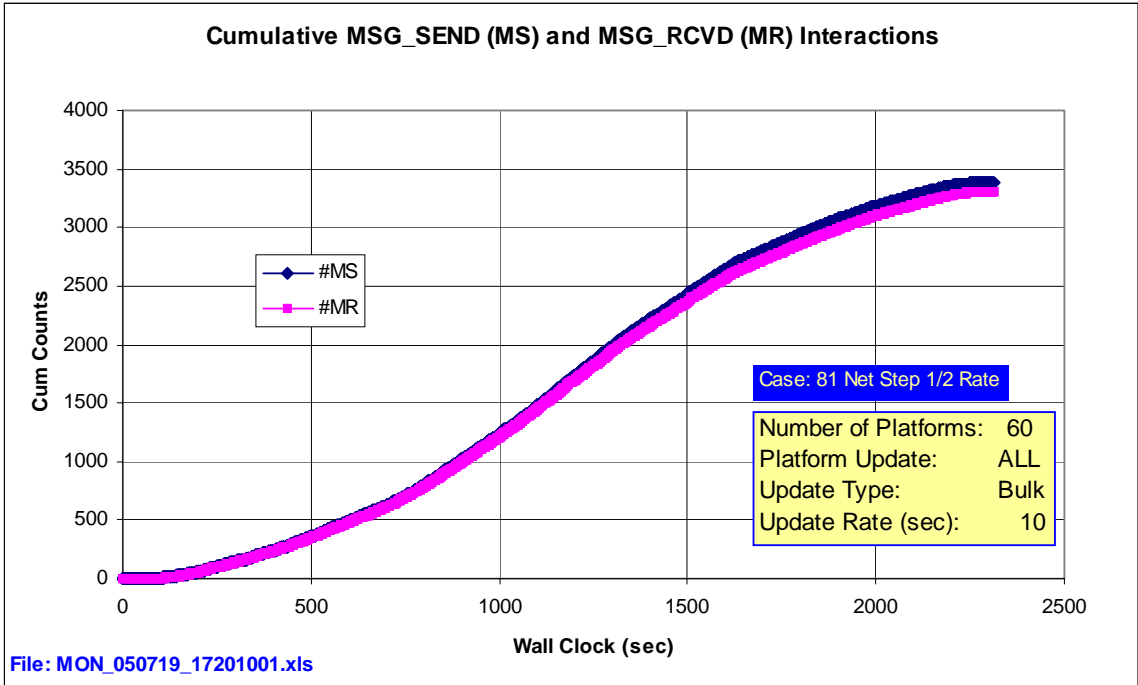


Figure 126 – 81 Net Step 1/2 Rate Cum MS and MR Interactions

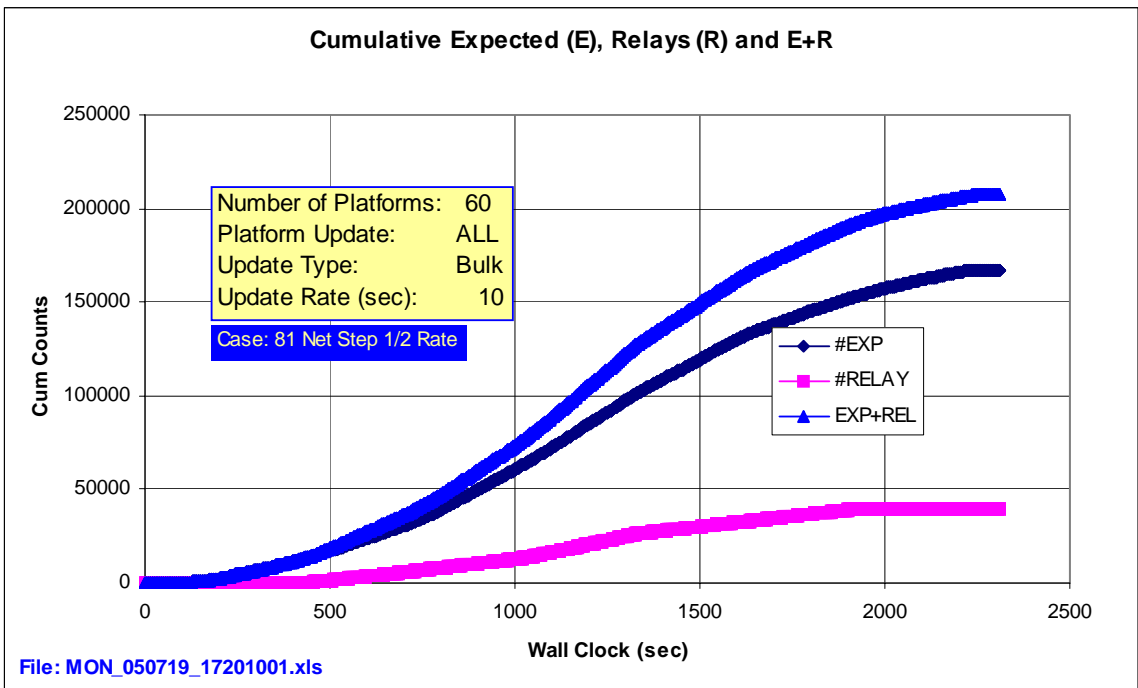


Figure 127 – 81 Net Step 1/2 Rate Cum E, R, and E+R

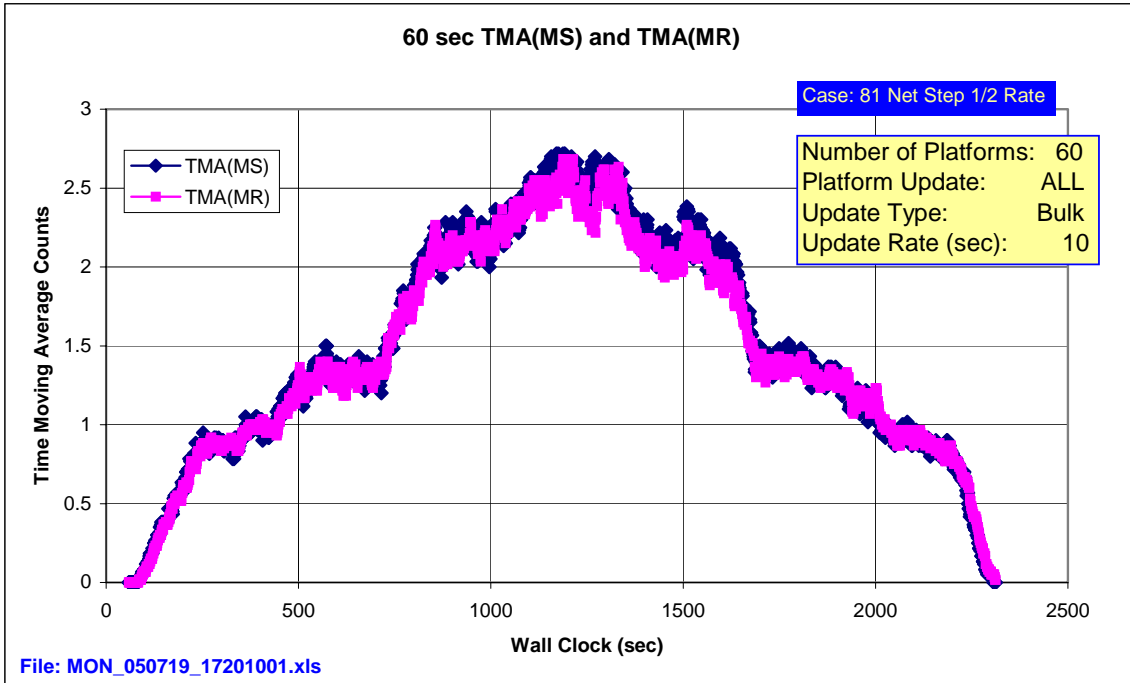


Figure 128 – 81 Net Step 1/2 Rate 60 sec TMA(MS) and TMA(MR)

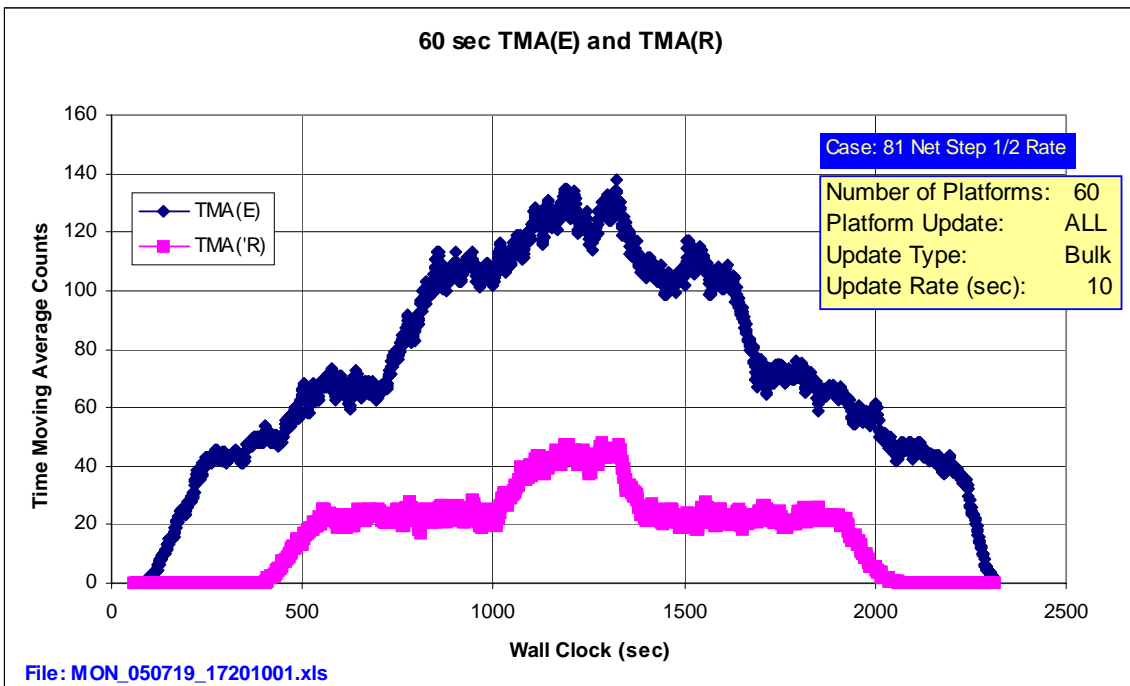


Figure 129 – 81 Net Step 1/2 Rate 60 sec TMA(E) and TMA(R)

## B.15 81 Net Step, Full Rate, and Position Updates every 10 sec (Main PC)

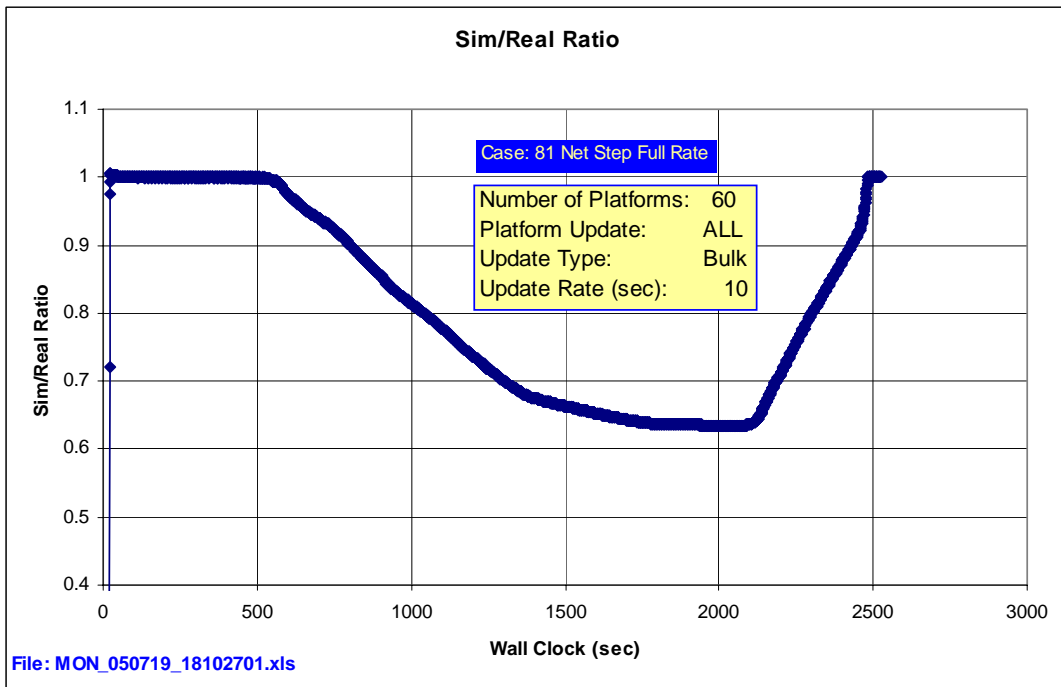


Figure 130 – 81 Net Step Full Rate Sim/Real Ratio

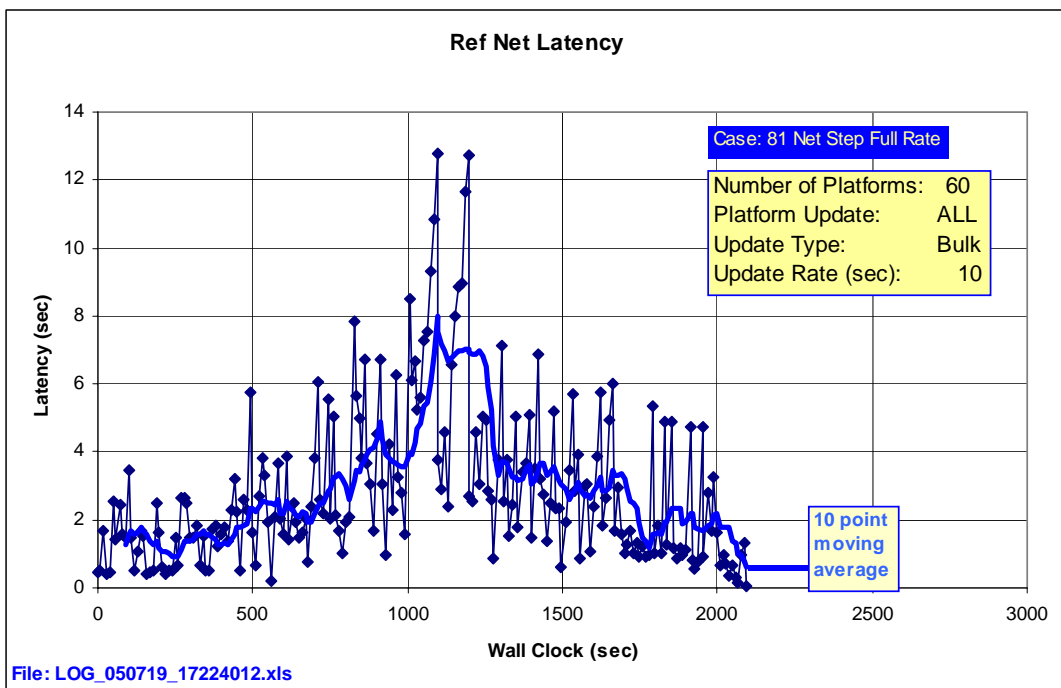


Figure 131 – 81 Net Step Full Rate Ref Net Latency

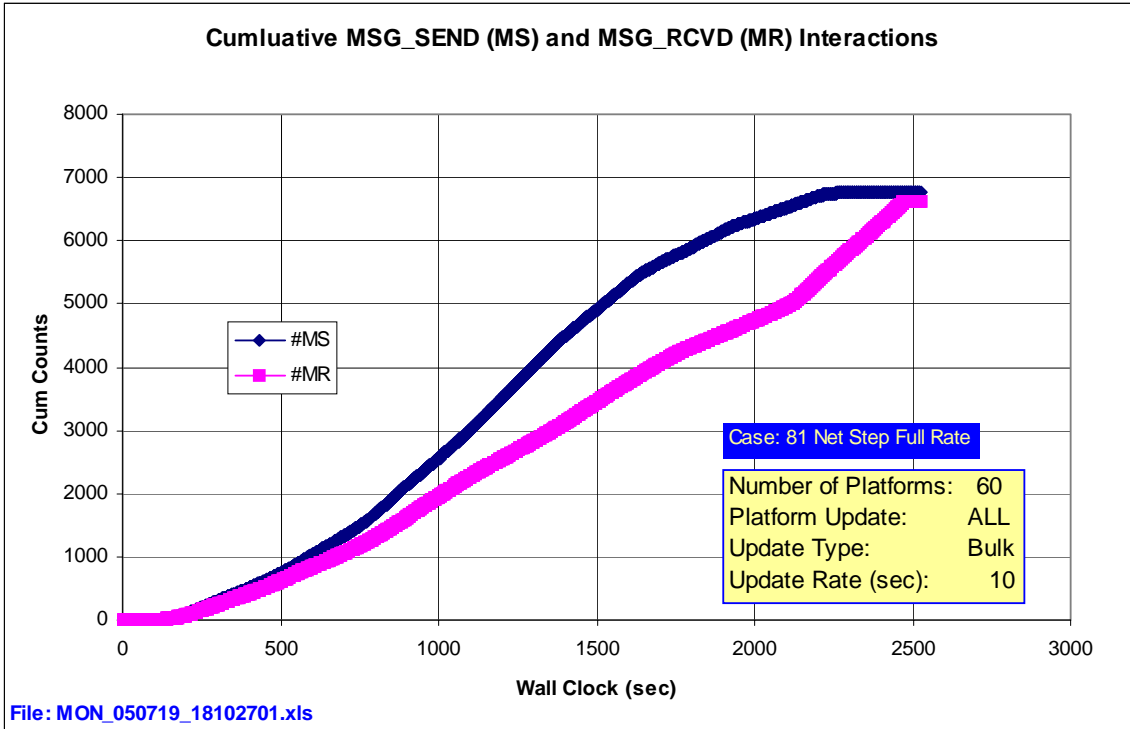


Figure 132 – 81 Net Step Full Rate Cum MS and MR Interactions

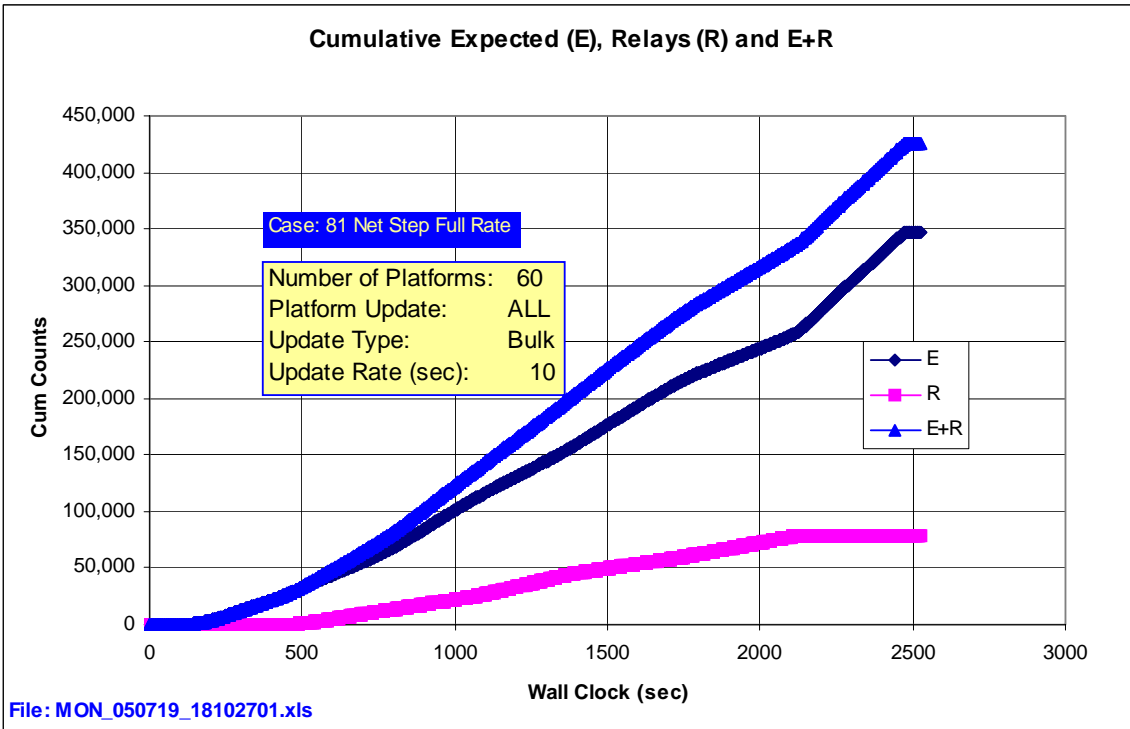


Figure 133 – 81 Net Step Full Rate Cum E, R, and E+R

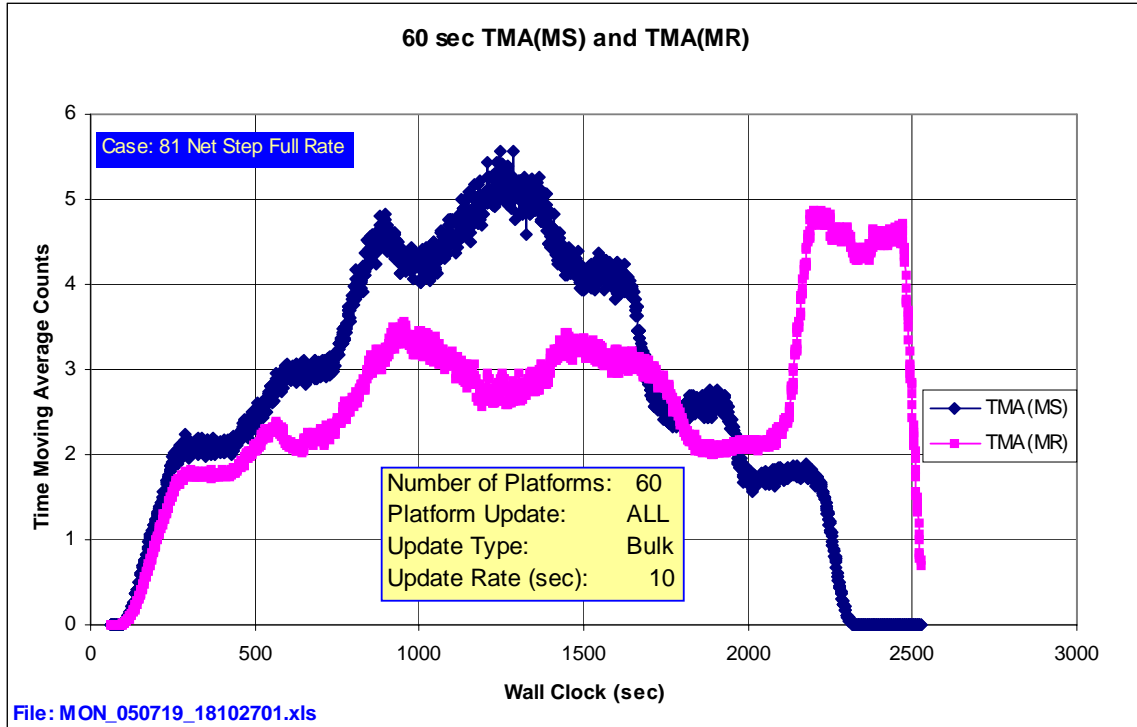


Figure 134 – 81 Net Step Full Rate 60 sec TMA(MS) and TMA(MR)

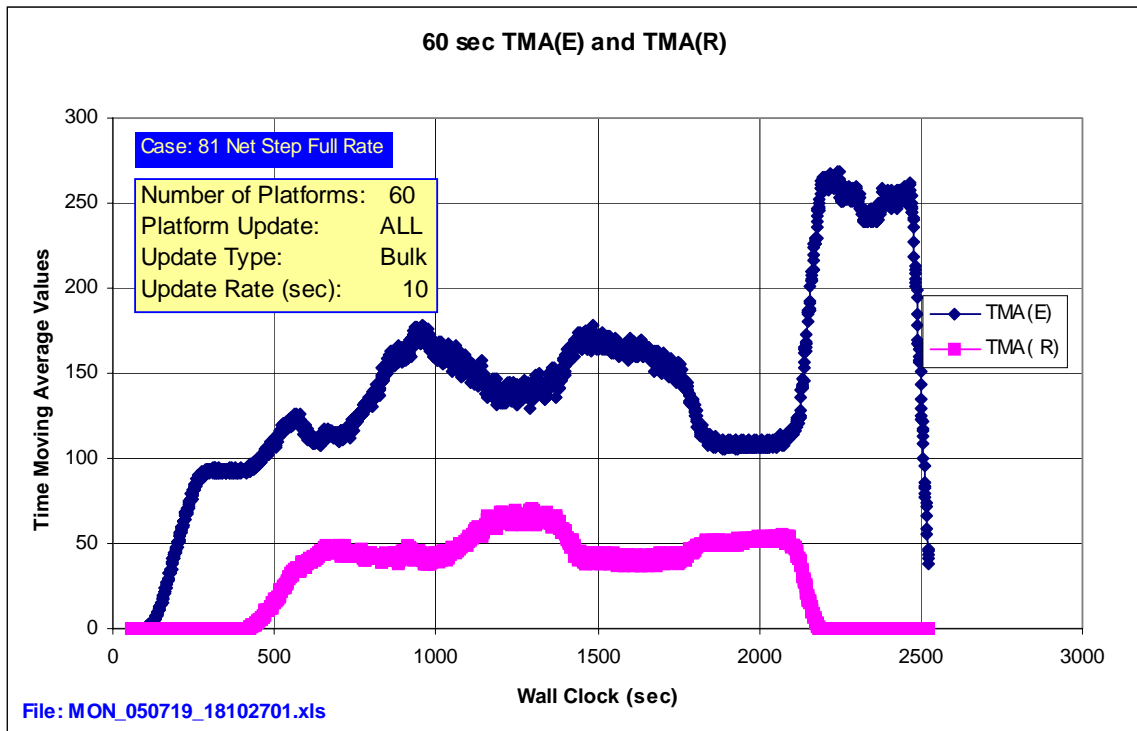


Figure 135 – 81 Net Step Full Rate 60 sec TMA(E) and TMA(R)

## B.16 81 Net Step, Full Rate, and Position Updates every 14 sec (Main PC)

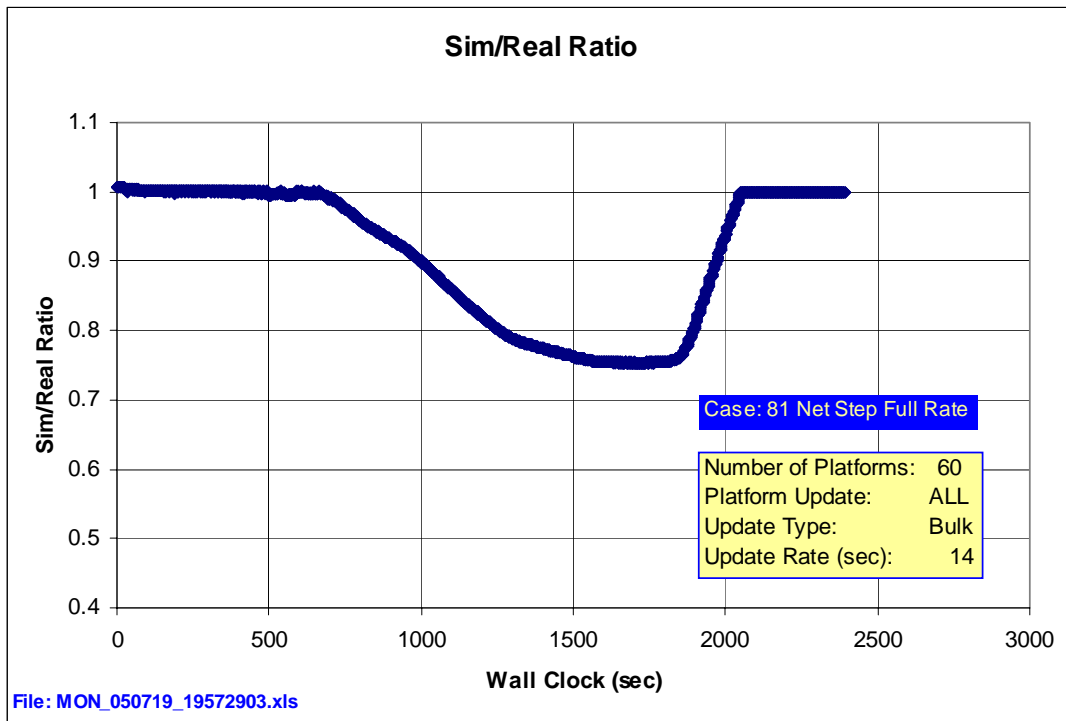


Figure 136 – 81 Net Step Full Rate 14 sec Position Update Sim/Real Ratio

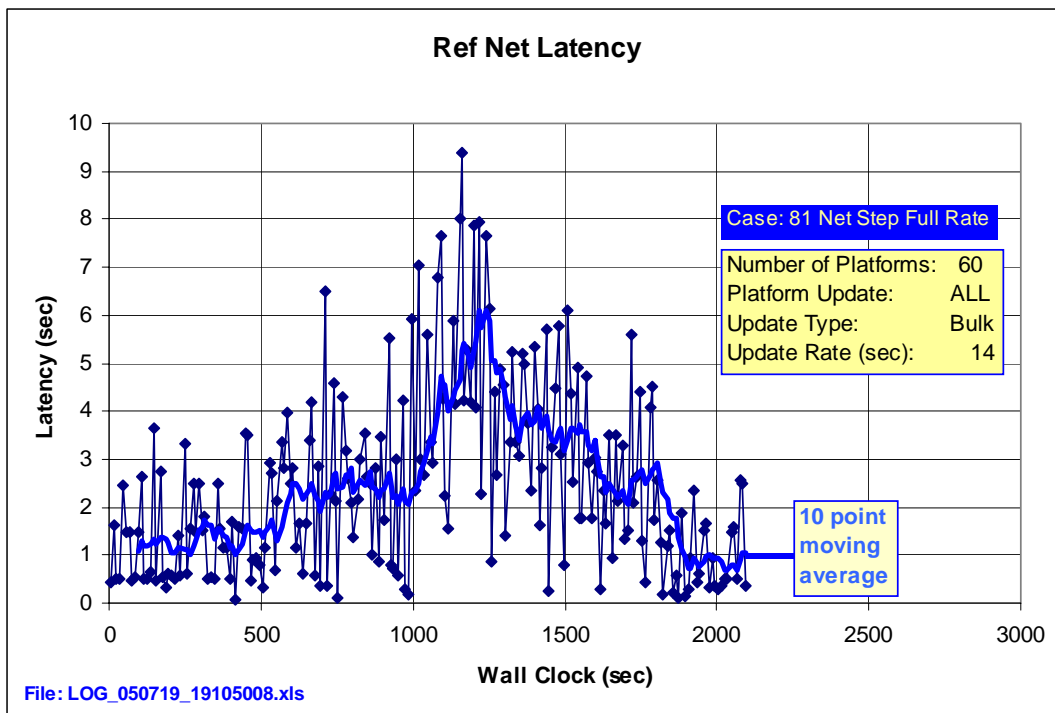
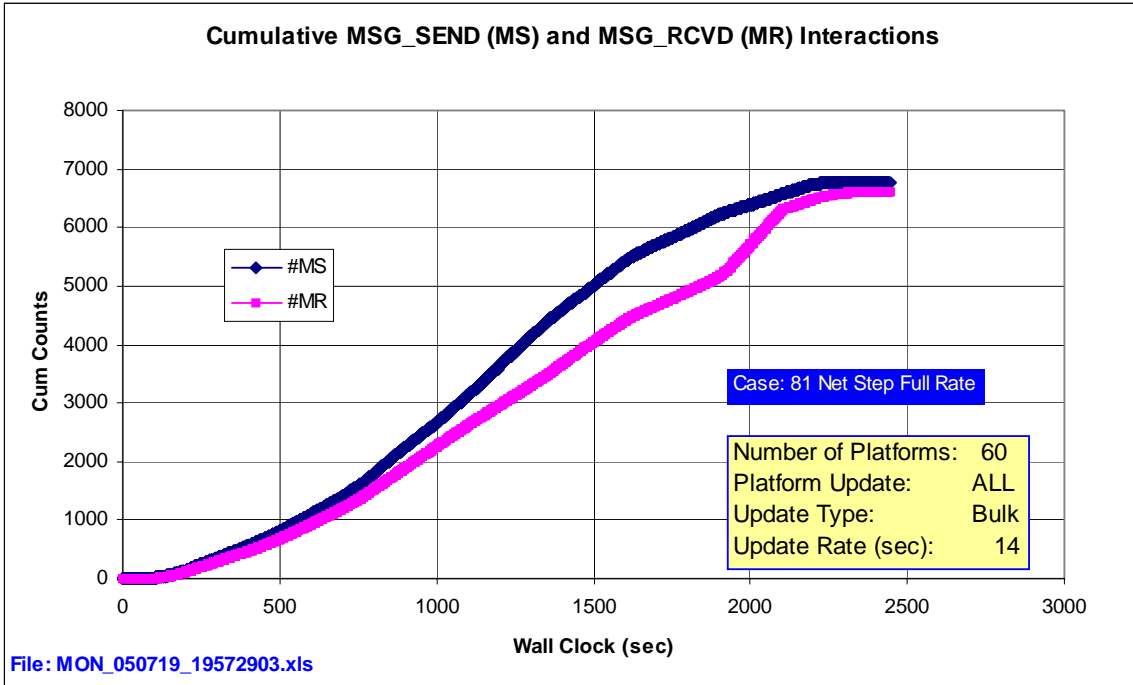
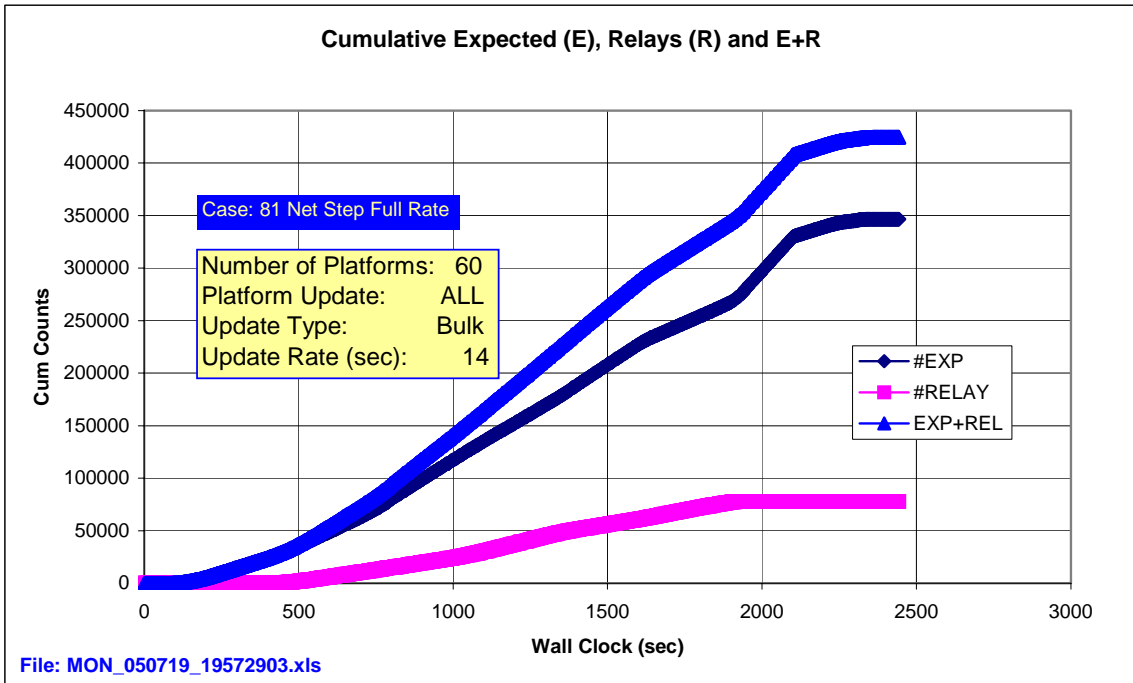


Figure 137 – 81 Net Step Full Rate 14 sec Position Update Ref Net Latency



**Figure 138 – 81 Net Step Full Rate 14 sec Position Update Cum MS and MR Interactions**



**Figure 139– 81 Net Step Full Rate 14 sec Position Update Cum E, R, and E+R**

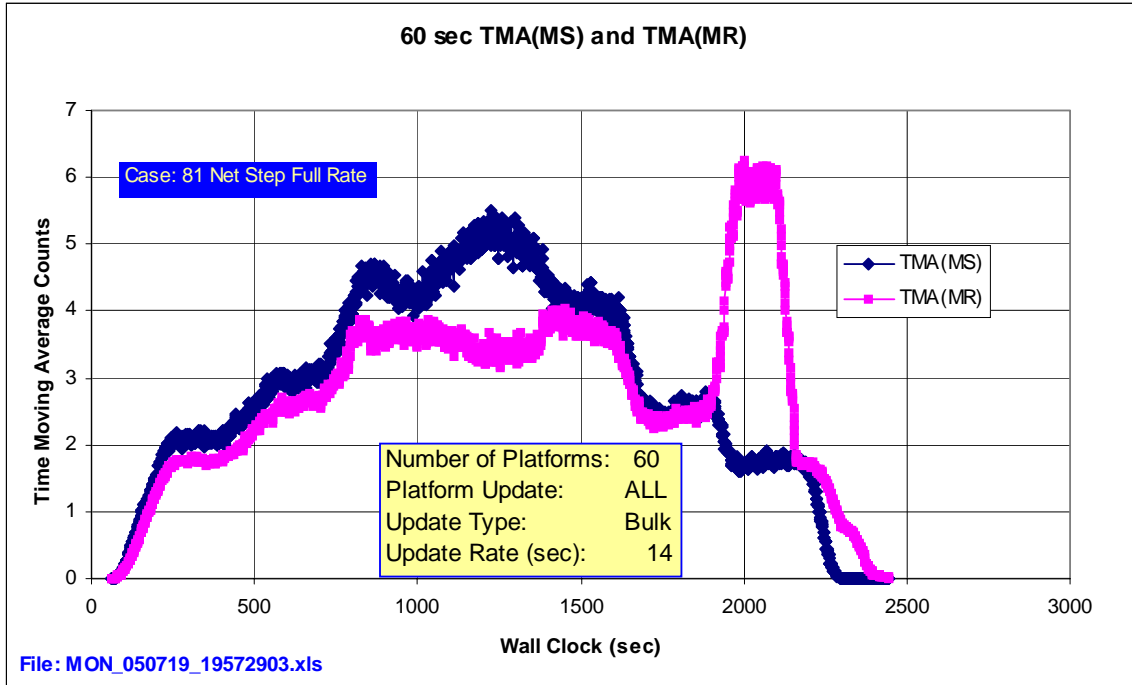


Figure 140 – 81 Net Step Full Rate 14 sec Position Update 60 sec TMA(MS) and TMA(MR)

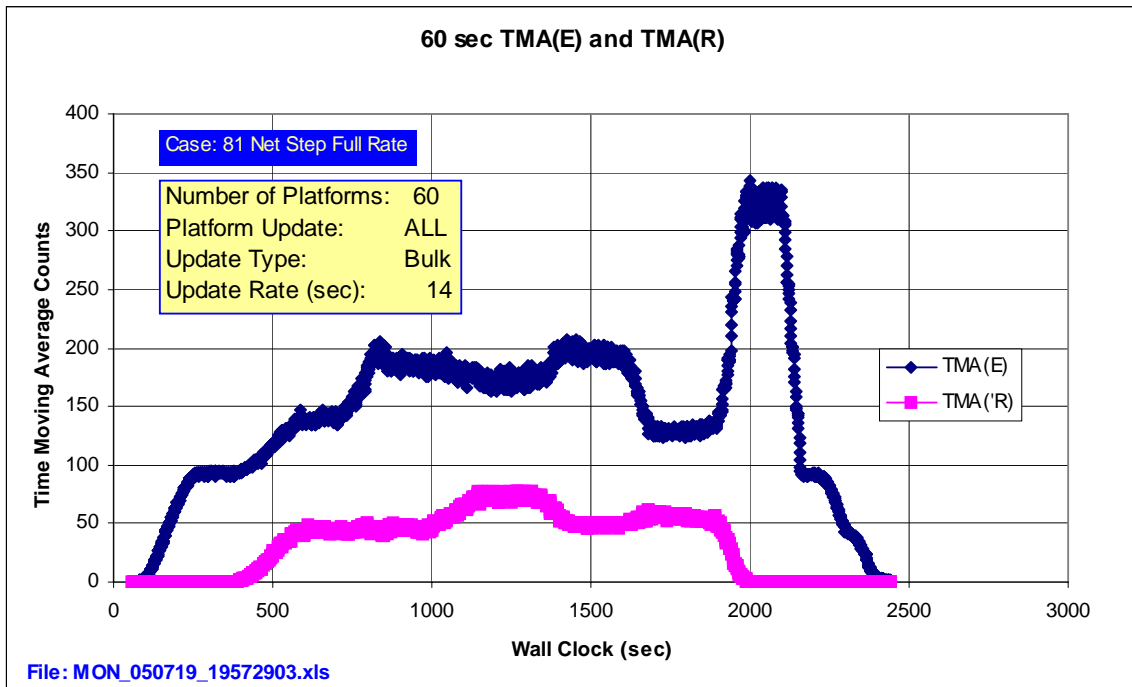


Figure 141 – 81 Net Step Full Rate 14 sec Position Update 60 Sec TMA(E) and TMA(R)

## B.17 81 Net Step, Full Rate, and Position Updates every 6 sec (Main PC)

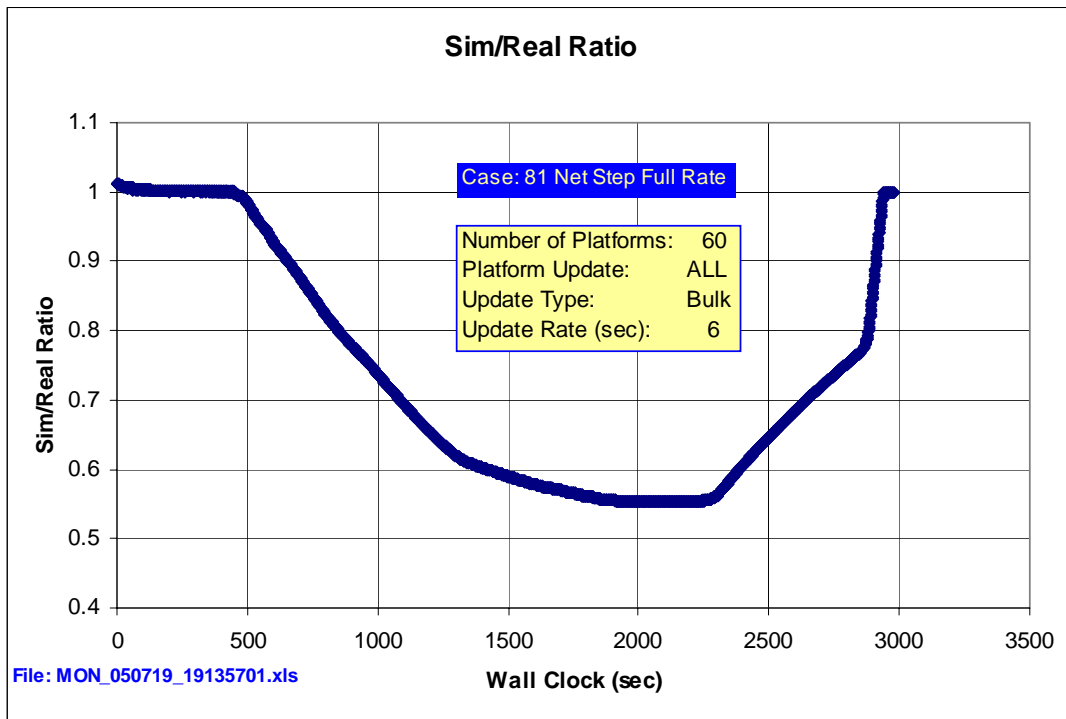


Figure 142 – 81 Net Step Full Rate 6 sec Position Update Sim/Real Ratio

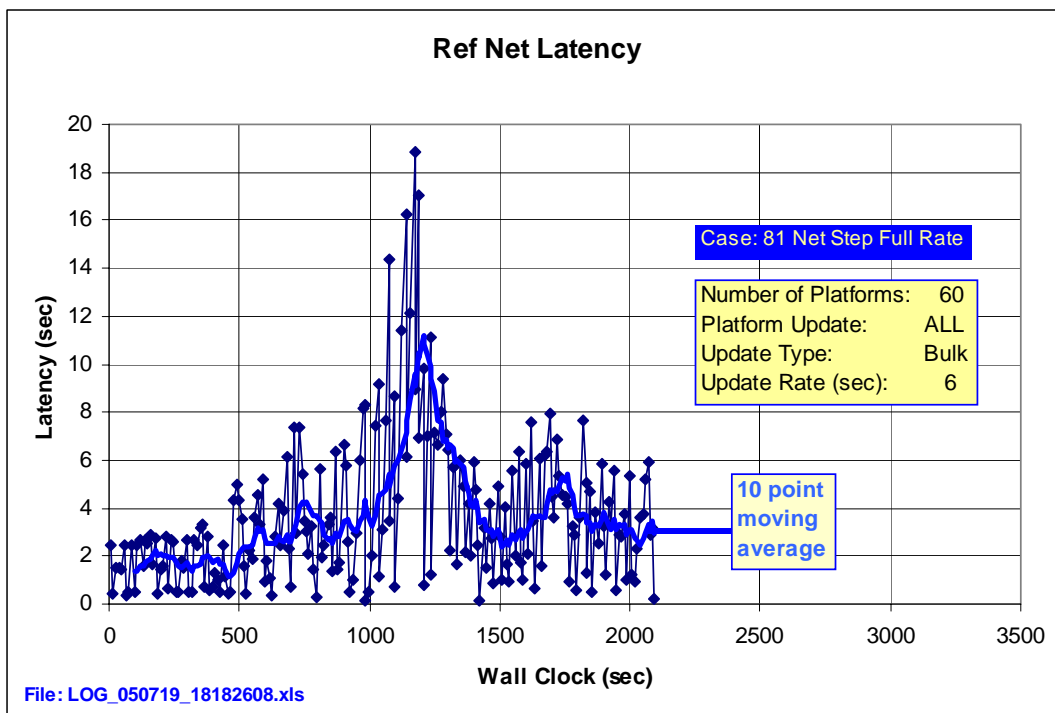


Figure 143– 81 Net Step Full Rate 6 sec Position Update Ref Net Latency

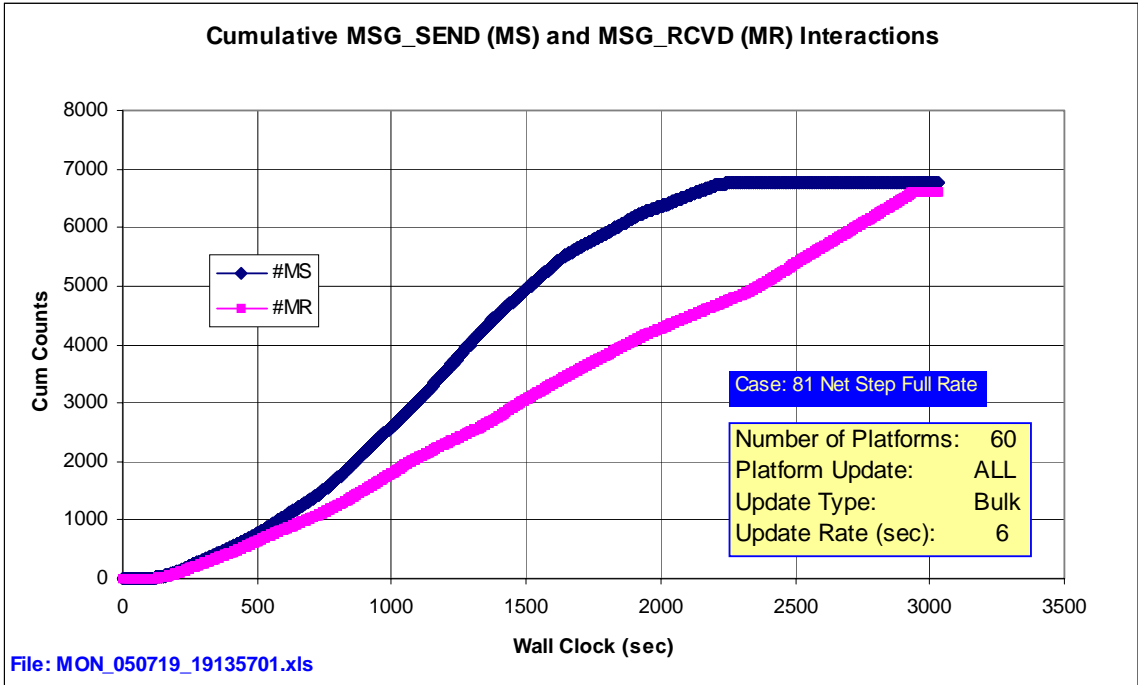


Figure 144– 81 Net Step Full Rate 6 sec Position Update Cum MS and MR Interactions

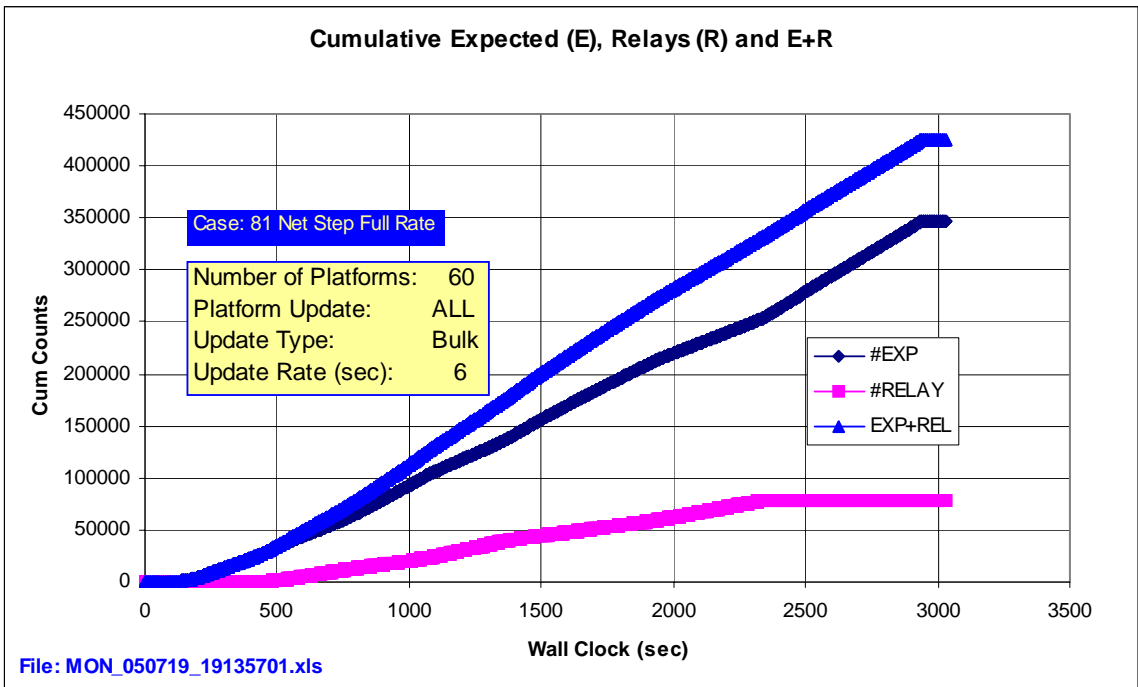


Figure 145 – 81 Net Step Full Rate 6 sec Position Update Cum E, R, E+R

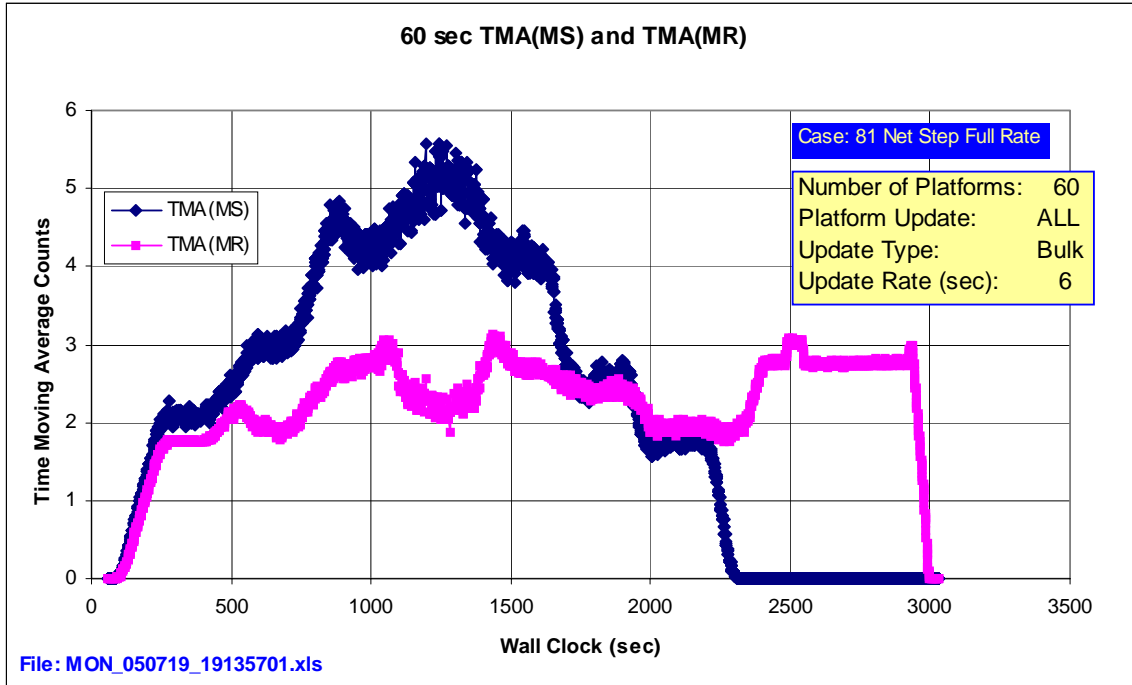


Figure 146 – 81 Net Step Full Rate 6 sec Position Update 60 sec TMA(MS) and TMA(MR)

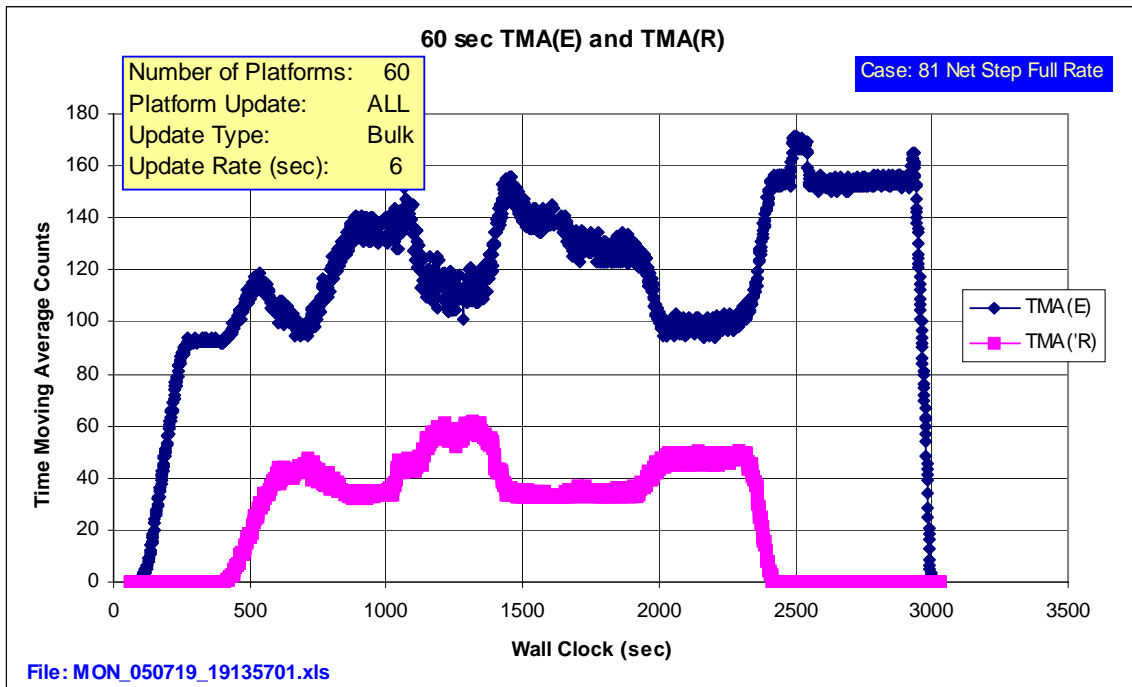


Figure 147 – 81 Net Step Full Rate 6 sec Position Update 60 sec TMA(E) and TMA(R)