



NRL/MR/6180--05-8908

Evaluation of Submarine Hydraulic System Explosion and Fire Hazards

JOHN B. HOOVER
JEAN L. BAILEY
HEATHER D. WILLAUER
FREDERICK W. WILLIAMS

*Navy Technology Center for Safety and Survivability
Chemistry Division*

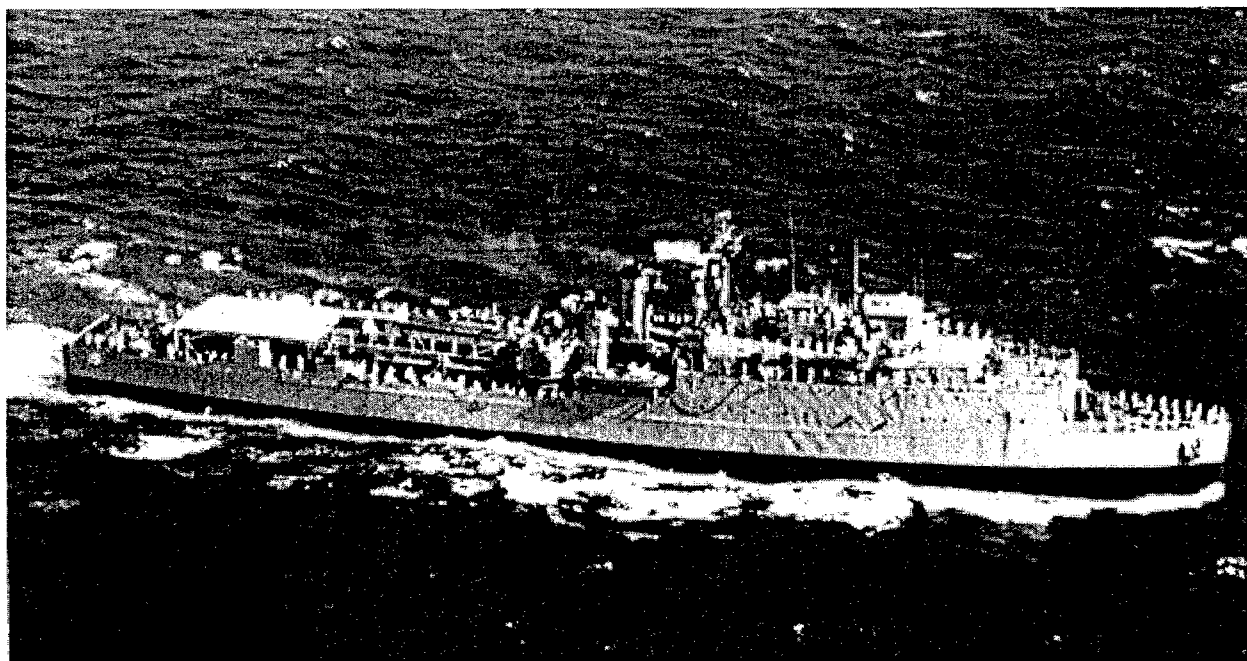

September 29, 2005

Approved for public release; distribution is unlimited.

20051209 010

REPORT DOCUMENTATION PAGE

Form Approved
OMB No. 0704-0188

Public reporting burden for this collection of information is estimated to average 1 hour per response, including the time for reviewing instructions, searching existing data sources, gathering and maintaining the data needed, and completing and reviewing this collection of information. Send comments regarding this burden estimate or any other aspect of this collection of information, including suggestions for reducing this burden to Department of Defense, Washington Headquarters Services, Directorate for Information Operations and Reports (0704-0188), 1215 Jefferson Davis Highway, Suite 1204, Arlington, VA 22202-4302. Respondents should be aware that notwithstanding any other provision of law, no person shall be subject to any penalty for failing to comply with a collection of information if it does not display a currently valid OMB control number. PLEASE DO NOT RETURN YOUR FORM TO THE ABOVE ADDRESS.

1. REPORT DATE (DD-MM-YYYY) 29-09-2005		2. REPORT TYPE Memorandum Report		3. DATES COVERED (From - To) October 2003 - September 2004	
4. TITLE AND SUBTITLE Evaluation of Submarine Hydraulic System Explosion and Fire Hazards				5a. CONTRACT NUMBER	
				5b. GRANT NUMBER	
				5c. PROGRAM ELEMENT NUMBER 61-8513-0-5-5	
6. AUTHOR(S) John B. Hoover, Jean L. Bailey, Heather D. Willauer, and Frederick W. Williams				5d. PROJECT NUMBER	
				5e. TASK NUMBER	
				5f. WORK UNIT NUMBER	
7. PERFORMING ORGANIZATION NAME(S) AND ADDRESS(ES) Naval Research Laboratory, Code 6180 4555 Overlook Avenue, SW Washington, DC 20375-5320				8. PERFORMING ORGANIZATION REPORT NUMBER NRL/MR/6180--05-8908	
9. SPONSORING / MONITORING AGENCY NAME(S) AND ADDRESS(ES) Office of the Secretary of Defense Joint Live Fire Test & Evaluation The Pentagon Washington, DC 20301-3090				10. SPONSOR / MONITOR'S ACRONYM(S)	
				11. SPONSOR / MONITOR'S REPORT NUMBER(S)	
12. DISTRIBUTION / AVAILABILITY STATEMENT Approved for public release; distribution is unlimited.					
13. SUPPLEMENTARY NOTES					
14. ABSTRACT Although hydraulic fluids are generally considered to be low flammable liquids, it is known that they can be highly flammable and even explosive in the atomized state. Because submarine hydraulic systems operate at high pressures, it is possible that mists could be produced in the event of a system leak. Large-scale tests were conducted aboard the ex-USS <i>Shadwell</i> test platform, under realistic temperature and pressure conditions, to evaluate the magnitude of the hazards. It was found that a significant fire and explosion potential does exist under conditions typical of normal hydraulic system operations.					
15. SUBJECT TERMS Hydraulic fluid Explosions Fires Explosion migrations					
16. SECURITY CLASSIFICATION OF:			17. LIMITATION OF ABSTRACT UL	18. NUMBER OF PAGES 97	19a. NAME OF RESPONSIBLE PERSON John B. Hoover
a. REPORT Unclassified	b. ABSTRACT Unclassified	c. THIS PAGE Unclassified			19b. TELEPHONE NUMBER (include area code) (202) 767-2002

CONTENTS

1.0	BACKGROUND.....	1
2.0	PROGRAM PLAN.....	2
2.1	Objectives.....	2
2.1.1	Consequences of submarine hydraulic fluid fires.....	2
2.1.2	Potential for submarine hydraulic fluid explosions.....	2
2.1.3	Casualty event timelines.....	3
2.1.4	Fire model validation data sets.....	3
2.2	Approach.....	3
3.0	EXPERIMENTAL.....	4
3.1	SHADWELL/688 Test Area.....	5
3.2	Fuel System.....	8
3.2.1	Fuel Characteristics.....	8
3.2.2	Nozzle Characteristics.....	9
3.2.3	Fuel Delivery System.....	10
3.3	Instrumentation.....	12
3.3.1	Thermocouples.....	13
3.3.2	Gas Sample Loops.....	13
3.3.3	Optical Density Meters.....	13
3.3.4	Fast-Response Pressure Transducers.....	13
3.3.5	Video Cameras.....	13
3.4	Data Acquisition.....	14

3.5	Test Matrices.....	14
3.6	Fire Test Procedures.....	17
3.6.1	Ventilation.....	17
3.6.2	End-of-Test Criterion.....	17
3.7	Explosion Test Procedures.....	19
3.7.1	End-of-Test Criterion.....	19
4.0	DATA ANALYSIS.....	19
4.1	Fire Tests.....	19
4.1.1	Temperature Data.....	20
4.1.2	Atmospheric Data.....	20
4.1.2	Event Timelines.....	21
4.2	Explosion Tests.....	22
4.2.1	Pressure Transient Data.....	22
5.0	RESULTS & DISCUSSION.....	23
5.1	Fire Tests.....	23
5.1.1	Flame Temperature and Burning Time.....	23
5.1.2	Torpedo Room Habitability.....	26
5.1.3	Crew Living Space Habitability.....	26
5.1.4	Combat Systems Space Habitability.....	32
5.1.5	Laundry Passageway Habitability.....	32
5.1.6	Control Room Habitability.....	36
5.2	Explosion Tests.....	41

5.2.1	Experimental Pressure Transients.....	41
5.2.2	Theoretical Pressure Transients.....	44
6.0	CONCLUSIONS & RECOMMENDATIONS.....	45
6.1	Fires.....	45
6.2	Explosions.....	46
6.3	Further Work.....	47
7.0	REFERENCES.....	48
8.0	ACKNOWLEDGMENTS.....	50

APPENDIX A. INSTRUMENTATION DIAGRAMS

APPENDIX B. COMPARTMENT AIR TEMPERATURE DATA

APPENDIX C. COMPARTMENT ATMOSPHERE DATA

APPENDIX D. OVER-PRESSURE TRANSIENTS

EVALUATION OF SUBMARINE HYDRAULIC SYSTEM EXPLOSION AND FIRE HAZARDS

1.0 BACKGROUND

The most recent summary of submarine fire history published by the Naval Sea Systems Command (NAVSEASYS COM) [1] is based on 24 years of operating experience with an average of 137 submarines in commission at any time. It concludes that, on average, there are 32 submarine fires per year and that nearly 45% of the fires spread beyond the immediate area of origin. The average yearly cost of these fires is \$3.3 million with 27 operational days lost as a result.

Based on this fire history, NAVSEASYS COM estimated the probability of a fire associated with a submarine hydraulic system casualty to be on the order of 2% over the 30 year life of a submarine. The severity and consequences of such fires were not addressed, nor were the potential explosion hazards. Since no hydraulic system fires or explosions have occurred on US Navy nuclear submarines, the actual risk (probability of occurrence times severity of results) of such events is not known.

It is important to note that this fire history covers only peacetime casualties. With the exception of the Falklands conflict, in which five British nuclear attack submarines were deployed [2], modern nuclear submarines have never been in combat. It is reasonable to suspect that the probability of occurrence of an hydraulic system fire or explosion will likely be higher, perhaps significantly higher, for submarines involved in hostilities.

The fluid used in the submarine interior hydraulic system (*i.e.* the system that is not in contact with sea water and which provides most of the ship hydraulic services), 2190 TEP hydraulic fluid, is designed to be relatively non-flammable. The specification for this fluid, MIL-PRF -17331J [3], requires a minimum flash point of 204 °C (400 °F) but does not specify any other fire-related properties.

As expected for a fluid with such a high flash point, bulk 2190 TEP fluid is difficult to ignite. However, in the atomized state, 2190 TEP is known to be highly flammable and potentially explosive under some conditions [4]. Military and civilian experience has confirmed these hazards. For example, a hydraulic spray fire in a Titan II missile silo, involving less than 340 liters (90 gal) of fluid, resulted in 53 fatalities [5]. Hydraulic fluid explosions have occurred on oil drilling platforms, when the spray was ignited by a self-induced static charge [6], and in manufacturing plants, where the ignition source was an electric light bulb [7]. The common thread in these accidents has been the production of a fine spray or mist. Due to the high operating pressures of submarine hydraulic systems (approximately 3000 psi for the *USS Los Angeles* class), it is highly likely that an hydraulic system casualty will produce such a mist.

The combination of an increased probability of an hydraulic casualty and a high loss potential in the event that such a casualty does occur suggests that, in combat, the overall risk of submarine hydraulic system fires or explosions may be very high. In order to investigate these concerns, the Naval Research Laboratory (NRL) proposed the Submarine Hydraulic System Explosion and Fire Hazard test program. The test plan for this program [8] was approved by the Department of Defense Office of Live Fire Test and Evaluation. Fire tests (Series 1a) and initial explosion scoping tests (Series 1b) were conducted during the period 4 — 7 August, 2003 and

demonstrations of fire and explosion hazards were carried out from 13 — 24 October, 2003. More detailed explosion hazard tests were performed during the period 17 — 21 November, 2003 (Series 2). This document reports the results obtained during those test cycles.

2.0 PROGRAM PLAN

The Submarine Hydraulic System Explosion and Fire Hazard program involved large-scale simulations of hydraulic system fires and explosions with the goal of defining the probable consequences of those casualties. Testing was conducted in the SHADWELL/688 submarine area aboard NRL's ex-*USS Shadwell* full-scale test platform.

Issues related to probability of occurrence or ignition sources were not addressed in these tests. The scope of the tests did not include investigation of tactics or doctrine for combating submarine hydraulic casualties. However, the data obtained establishes a baseline which provides a basis for future work targeted toward development of mitigation techniques.

2.1 Objectives

The program had four primary objectives:

1. to investigate the consequences of submarine hydraulic fluid fires;
2. to investigate the potential for hydraulic fluid explosions;
3. to determine casualty event timelines; and
4. to acquire test data suitable for use in fire modeling and engineering analysis.

2.1.1 Consequences of submarine hydraulic fluid fires

Under the general category of possible consequences of hydraulic fluid fires, we considered the effects of the casualty on the compartment of origin, on the immediately surrounding compartments and on critical spaces. Critical spaces are those that, if lost, would have a disproportionate effect on the survivability or combat effectiveness of the boat. They include the control room and the combat systems space.

Due to the anticipated severity of a hydraulic fire, it was assumed that the compartment of origin would be rendered uninhabitable almost instantly. In this compartment, the focus was on secondary effects, such as destruction of, or damage to, ship systems within the compartment. For the surrounding compartments and critical spaces, the central concern was the loss of habitability due to high temperatures, visibility reduction or toxic hazards. For the purposes of this work, the term "toxic hazard" refers to oxygen depletion and to the concentration of carbon monoxide and carbon dioxide.

Conditions in spaces adjacent to the fire compartment are important because of the possible impacts on fire fighting tactics, including loss of staging areas and limitations in options for attacking the fire.

2.1.2 Potential for submarine hydraulic fluid explosions

We investigated the conditions under which a leak in the hydraulic system might lead to an explosion, as opposed to a fire. Typically, explosions involving liquid hydrocarbons occur only if there is a significant concentration of small droplets (mist) within an enclosed space. Due to the high pressures inherent in submarine hydraulic systems, rupture of an hydraulic line is rather likely to produce a mist. Under those conditions, the major factors that will determine whether an explosion occurs will be the concentration, size distribution and temperature of the mist droplets and the availability of an ignition source.

For real-world hydraulic casualties, none of these factors can be predicted with any certainty. For example, the droplet size distribution depends on parameters such as the size and shape of the hole, the pressure and temperature of the fluid at that point in the system and whether the resulting fluid stream impacts on surfaces.

Since we can not know the details of a hypothetical future incident, our tests used spray nozzles and operating pressures chosen to produce a range of droplet sizes and concentrations that could reasonably occur during a real casualty. Concentrations were varied by changing the number of nozzles used and, in some cases, the length of time that hydraulic fluid was sprayed prior to ignition.

2.1.3 Casualty event timelines

The casualty timelines include events that could cause loss of habitability of various spaces. In our analysis, these events have been categorized by compartment and type (for example, excessive temperature or loss of visibility).

2.1.4 Fire model validation data sets

It is well known that large-scale fire testing is expensive and time consuming. Computer fire modeling is of increasing interest in an effort to reduce these costs and expedite the process of estimating fire effects on new designs. Many fire models have been written, ranging from very simplistic network models to more complex zone models to sophisticated field models. Each model has pros and cons but all suffer from a lack of quality, large-scale fire data against which their predictions may be compared. Accordingly, acquisition of such a data set was an important objective of this project.

2.2 Approach

Discussions with Fleet [9] and Naval Safety Center personnel [10], suggested that the torpedo room would be a likely site for hydraulic failures within the forward compartment. Since the forward and aft compartments on *USS Los Angeles* class submarines have comparable volumes,

the data from these tests should apply to either section.

Our investigation focused on the worst-case situation: a spray of hydraulic fluid leading to a fire or an explosion. The general scenario assumed that shock damage (possibly due to collision or weapons effects) ruptured a hydraulic header and that the fluid spraying from that rupture then ignited or exploded. This scenario provided a rationale for the existence of a casualty at the specified location but the results of the tests should not be construed to apply only to this scenario.

Limiting factors in this scenario were the total spillable volume of the hydraulic header (taking into account the segregation of the system by various check valves and isolation valves) and the maximum flow rate through the hydraulic piping. This leads to a quasi-steady state fire with a heat release rate (HRR) set by the lesser of the fuel flow rate and the oxygen availability and the duration set by the available quantity of either fuel or oxygen. The fuel temperature is also a factor to the extent that it affects the aerosolization and flammability of the hydraulic fluid.

Details of the design and configuration of the SHADWELL/688 test area, which was used extensively for the Submarine Ventilation Doctrine test series, may be found in the test plans for that program [11 — 14]. The overall test area configuration, along with information that is unique to our test program, is summarized below.

To support this program, the SHADWELL/688 area was refurbished and, where necessary, repaired to ensure a reasonable degree of fidelity to the conditions expected on an actual *USS Los Angeles* class submarine. The entire test area was pressure tested prior to the start of testing to verify integrity.

3.0 EXPERIMENTAL

In this report, tests are categorized as fire or explosion tests, depending on their primary goal. Within each category, shakedown tests were conducted for the purpose of validating procedures and verifying the operation of the instrumentation and data acquisition systems. Those tests are mentioned for the record, but data from them has not been included in the analysis. Several fire tests were run with the specific goal of acquiring data suitable for fire model validation studies. Because the ventilation conditions for the modeling tests were not representative of actual submarine operating conditions, those data have also been omitted from this analysis. Comparison of those test results with model predictions will be the subject of a future report.

The explosion tests are classified as shakedown tests, scoping tests, demonstrations or pressure transient tests. Scoping tests, in which the torpedo room was progressively isolated from the rest of the SHADWELL/688 test area, were conducted to determine the safe operating range for subsequent experiments. Demonstrations were carried out for the benefit of visiting dignitaries and to permit better photographic documentation of the results of the fires and explosions.

The pressure transient tests were the most operationally realistic of the explosion tests, although they deviated from actual shipboard conditions in that the torpedo room was isolated from the adjoining spaces by watertight closures. This was done primarily for safety reasons — if the

hydraulic mist had been allowed to spread throughout the test area, there would have been a possibility of a catastrophic explosion that could have severely damaged the SHADWELL facility and endangered test personnel.

In the following section, we discuss the experimental setup, starting with the overall configuration of the test area and progressing to the details of various subsystems, such as the fuel and the data acquisition systems.

3.1 SHADWELL/688 Test Area

The SHADWELL/688 test area is located in the port wing wall of ex-*USS Shadwell*. This area represents the forward compartment of a *USS Los Angeles* (SSN 688) class attack submarine. As shown in Figure 1, it includes three decks within the ship (bilge, lower and mid level) plus two decks built above the main deck (upper level and the sail).

Two configurations of the external closures, identified as "open" and "closed" boat, were used during these tests. The open boat configuration was similar to the pier-side state of a submarine, with both the sail hatches (H1 and H1a) and the weapons loading hatch (H2) open, except that we also had two safety doors in the torpedo room (S1 and S2) open to permit observations from the well deck. This configuration also allowed sufficient oxygen to support larger fires for the modeling tests.

In the closed boat configuration, which was intended to represent a submerged submarine, H1a and H2 were closed. On an actual submarine, H1 would have also been closed and, in the first closed boat test (HFH-03), this hatch was closed. However, it was found that H1 had to be opened for efficient post-test ventilation, requiring that a person enter the sail trunk, via H1a, to access H1. Since the trunk is a confined space, this was considered to be an unnecessary safety risk and, in subsequent tests, H1 was left open. Because H1 and H1a are in series, this is still a closed boat configuration.

With H1a closed, the sail trunk was a dead volume that did not affect the air flow. Furthermore, the volume of the trunk is negligible compared to the total volume of the SHADWELL/688. Therefore, this deviation from actual submarine conditions was not expected to have any impact on the results of the tests.

All of the internal closures shown in Figure 1 (D1 — D11 and H4 — H14) were open, except D1, D7, D11 and H14, which were closed. The fan room, which is actually a plenum that is part of the ventilation system, must be isolated so that flow through the fan room intake and exhaust ducts are balanced, as required for a properly configured ventilation system. Therefore, door D1 was always closed.

Doors D7 and D11 were closed to protect the instrumentation node rooms that are located in the CPO living space and the storeroom. Similarly, hatch H14 was closed to protect wiring that is routed through the bilge in that area.

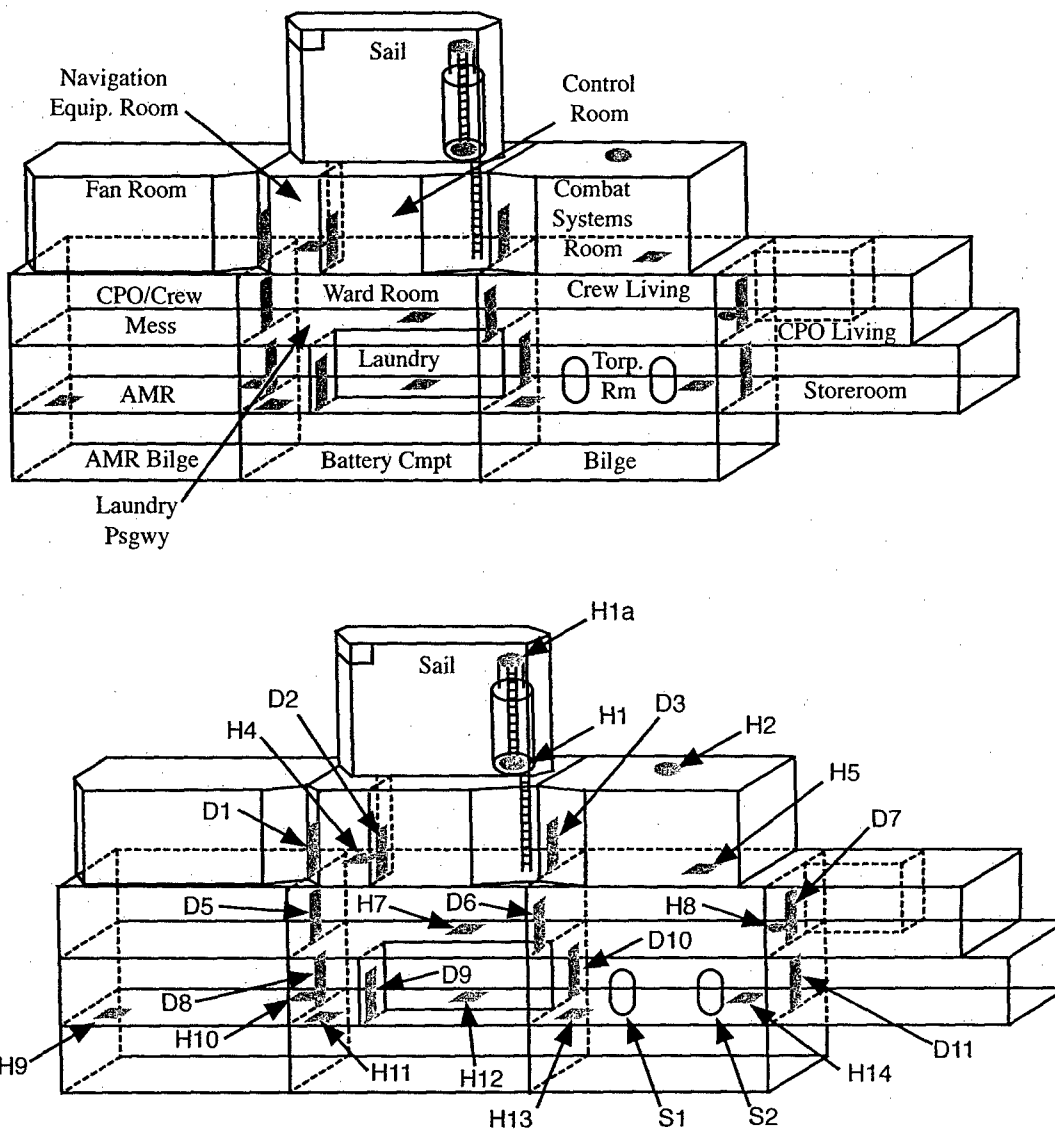

Figure 1. SHADWELL/688 Test Area

The compartments (upper diagram), and closures (lower diagram) within the SHADWELL/688 test area are shown. Closure designations are the same as those used in the Submarine Ventilation Doctrine tests, with the addition of the safety doors (S1 and S2). Closures H3, H6 and D4 were not used in the current test program and, for clarity, have been deleted from this diagram.

Eight ducts (for clarity, these are not shown in Figure 1) connect the lower level with the upper level. These ducts simulate the connections that bypass, via the frame bays, the wardroom and crew living spaces on SSN 688 class submarines. Four of these ducts (two port and two starboard) connect the torpedo room with the combat systems space, two (starboard) provide a direct path between the laundry room and the control room and the last two (port) go from the

laundry passageway to the control room.

Pressure testing of the entire SHADWELL/688 test area was accomplished by running the fans with the fan room open to the atmosphere¹, so that the ventilation system pulled makeup air from outside and slightly pressurized the test area. At time zero, the exterior door was then closed and the ventilation was secured. Pressure within the test area was monitored, using a Magnahelic gauge, and the pressures were recorded as a function of elapsed time. The resulting pressure versus time curve is shown in Figure 2.

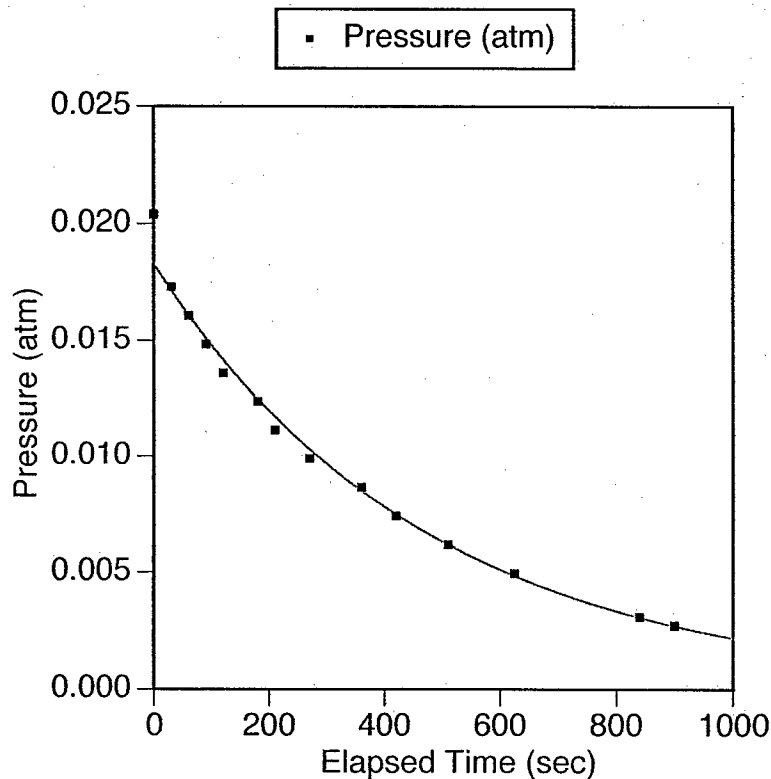

Figure 2. SHADWELL/688 Area Pressure Test

Prior to the start of fire testing, the SHADWELL/688 area was pressurized, as described in the text, and the pressure decay rate was measured. Data points are indicated by the symbols; the line is the exponential decay obtained by a least squares curve fit.

To increase the safety margin during explosion tests, the test area was modified by installation of three pressure relief panels in the outboard bulkhead of the torpedo room. Each of these measured 0.6 x 0.6 meters (24 x 24 in.) and was designed to blow out at an over-pressure of 1.5 psi.

¹ The water tight door used for this is not shown in Figure 1.

3.2 Fuel System

The fuel system was designed to create hydraulic fluid mists, using up to five spray nozzles operating at approximately 1000 – 1500 PSI. This is one third to one half the pressure used in *USS Los Angeles*-class submarine internal hydraulic systems (3000 psi) and is sufficient to produce the desired mist while not drastically increasing the expense, complexity or safety hazards of the test system.

In the following sections, we discuss the properties of the fuel and nozzles and the design of the fuel delivery system.

3.2.1 Fuel Characteristics

The fuel used in these tests was Chevron Turbine Oil Symbol 2190 TEP. This product is listed on the latest Qualified Products List (QPL) [15] and is representative of the hydraulic fluid currently in use aboard US Navy submarines.

Some pertinent product information, taken from the manufacturer's published specifications and from the Material Safety Data Sheet (MSDS), is presented in Table 1. The calculated heat of combustion for this material, 42.7 MJ/Kg (4.63 kcal/lb) [16], is also included in the table. Using the specific gravity from Table 1, the volumetric heat of combustion would then be about 37 MJ/liter (33.5 kcal/gal).

Fuel Property	Property Value
Composition	>99% Heavy paraffinic distillates
Absolute Viscosity (cP)	69.0 @ 40 °C; 8.4 @ 100 °C
Flash Point (°C)	246
Boiling Point (°C)	>315
Specific Gravity	0.86 - 0.87
Heat of Combustion (MJ/Kg)	42.7

Table 1. Selected Properties of ChevronTexaco 2190 TEP Hydraulic Fluid

These properties of ChevronTexaco 2190 TEP hydraulic fluid have been excerpted from the manufacturer's product data sheet and the MSDS.

3.2.2 Nozzle Characteristics

From previous work [4], it was known that the Bete P-series nozzles can produce a highly flammable mist. In a preliminary test [17], the Bete P24 nozzle was found to work satisfactorily at realistic fluid temperatures, even at relatively low pressures (about 120 psi), and was expected to work better at higher pressures. Consequently, Bete P24 nozzles were selected for these tests.

According to the Bete specifications, those nozzles produce a 90° solid cone pattern with a large percentage of the droplets in the 25 - 400 µm range. However, the size information cited in the specification is for water and the nozzle performance with other fluids will vary from these values. In order to better understand the performance expected from these nozzles, we requested that Bete calculate the size distribution parameters for hydraulic fluid, using a specific gravity of 0.865 and a viscosity of 69 cP (these values were taken from the physical properties given in Table 1). Using proprietary software, they produced [18] the estimated size distribution parameters shown in Table 2.

Press. (psi)	Dv(10)	Dv(50)	Dv(90)
1000	50	84	130
1500	44	74	110

Table 2. Estimated Size Distribution for Bete P24 Nozzles with 2190 Hydraulic Fluid

Estimated droplet diameters, in microns, for the 10th, 50th and 90th percentiles (by volume) at nozzle pressures of 1000 and 1500 psi. These values were calculated by the nozzle manufacturer (Bete Fog Nozzle), using proprietary software, for 2190 TEP fluid parameters.

The nominal flow rates, corrected for the difference in density between the standard fluid (water) and 2190 TEP, are given as a function of the nozzle pressure in Equation 1 [19]

$$Q_{\text{hyd}} = K P^{1/2} S_{\text{hyd}}^{-1/2} \text{ liters/min} \quad \text{Eqn. 1}$$

where K is the nozzle K-factor provided by the manufacturer (0.0598 for the P24 nozzle), P is the nozzle operating pressure (psi) and S_{hyd} is the specific gravity of the fluid (0.865 for 2190 TEP). For the pressures of interest (1000 — 1500 psi), the flow rates are in the range 2.0 — 2.5 liters/min (0.54 — 0.66 gpm) per nozzle. Based on the heat of combustion, the estimated heat release rate (HRR) for this system is 1.2 — 1.5 MW for each nozzle. Of course, the actual HRR may be limited by the availability of oxygen which, in turn, is dependent on the ventilation conditions for the test. Typical HRR values for different numbers of nozzles are given in Table 3.

Nozzles	HRR (MW)
1	1.26
3	3.78
5	6.30

Table 3. Target Heat Release Rates

These estimated heat release rates (HRRs) for fires with one, three and five nozzles were calculated from the heat of combustion of 2190 TEP hydraulic fluid and the flow rate of the Bete P24 nozzle at a nominal operating pressure of 1000 psi.

3.2.3 Fuel Delivery System

A nozzle array, containing five stations, was installed in the forward, starboard quadrant of the torpedo room, just inside the forward safety door, as illustrated in Figures 3A and 3B. From fore to aft, the nozzle positions were numbered one to five. For Series 1, the array was located at an elevation of 1 meter (3.3 ft.) above the deck. For later work, including the hazard demonstrations and Series 2 tests, it was lowered to about 0.5 meters (1.7 ft.) to reduce flame impingement on the overhead.

The fuel system, shown schematically in Figure 4, consisted of a fuel vessel, loaded with approximately 190 liters (50 gal) of fuel, pressurized by a nitrogen manifold and connected to the nozzle array by 1.25 cm (0.5 in.) diameter welded stainless steel pipe.

A solenoid valve was used to toggle the fuel flow, with a manual valve as a safety backup. Note that the fuel valves were used as binary devices — they switched the fuel on and off but did not control the actual flow rate. The latter was determined by the operating pressure and the flow characteristics of the nozzles, in accordance with Eqn. 1. During Series 1, clogging of the solenoid valve and the nozzles proved to be an intermittent problem. Therefore, an in-line fuel filter was installed and was used for the Series 2 tests.

For the explosion tests in Series 2, two electrical heater bands were wrapped around the circumference of the pressure vessel and were adjusted to maintain the fluid in the vessel at a temperature of about 45 °C (113 °F). This is near the middle of the normal operating temperature range for submarine hydraulic fluid.

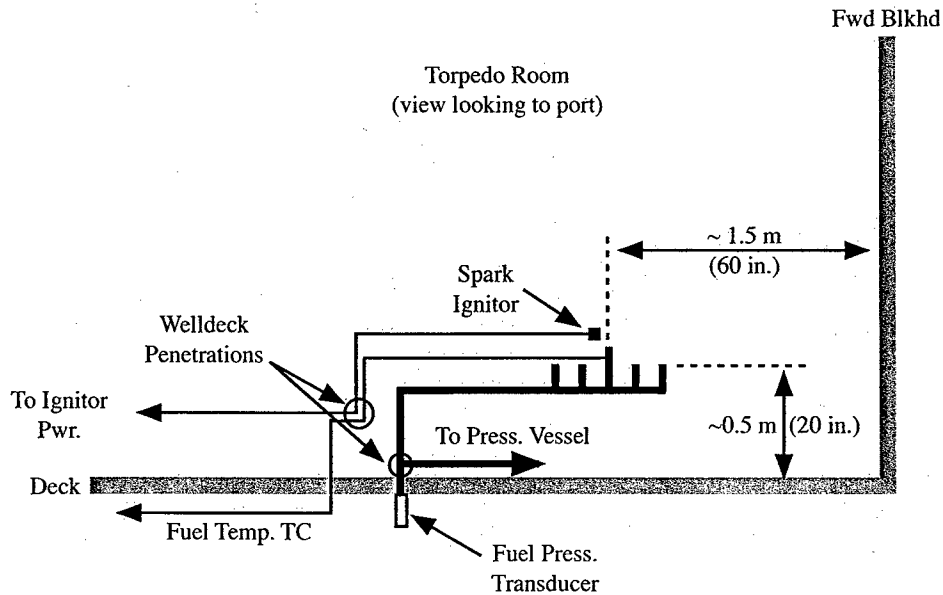

Figure 3A. Side View of Torpedo Room Nozzle Array

Five nozzle positions were provided, with a fuel temperature thermocouple located at the center position. A pressure transducer was installed outside the test compartment at the bulkhead penetration.

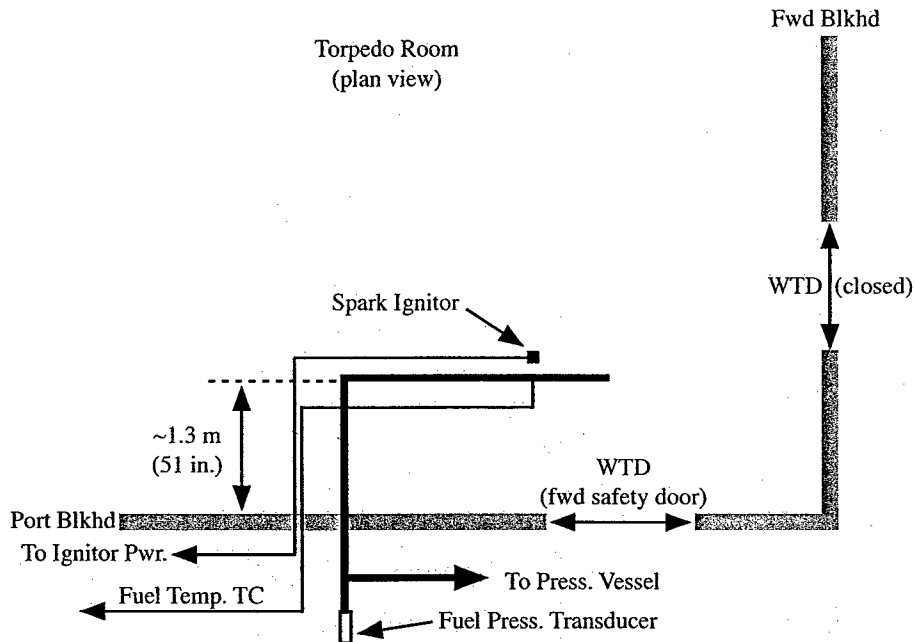

Figure 3B. Plan View of Torpedo Room Nozzle Array

The watertight door (WTD) in the forward bulkhead was always closed and the forward safety door in the starboard bulkhead was either dogged down or covered with a smoke blanket. The aft WTD (not shown) was always closed.

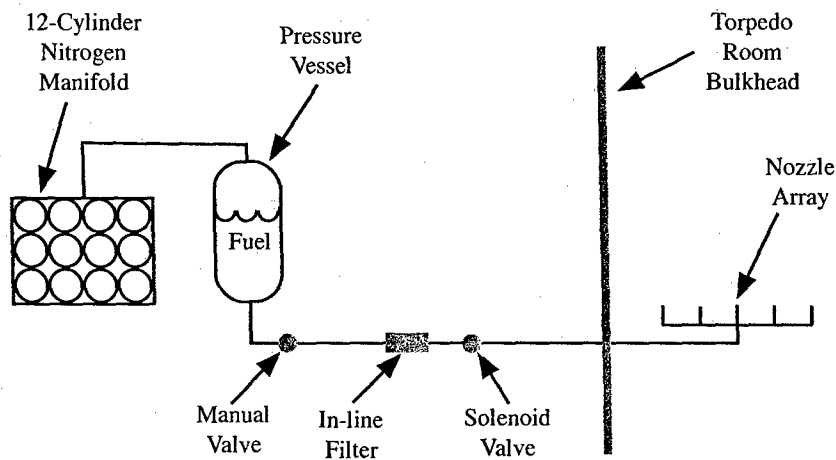

Figure 4. Fuel System Configuration

Hydraulic fluid was stored in a vessel (rated at 1500 psi) pressurized by a nitrogen manifold. Fuel flow was controlled by on-off valves; the flow rate was dependent on the pressure and the nozzle characteristics. An in-line filter removed particulates to prevent clogging of the nozzles and solenoid valve.

3.3 Instrumentation

The standard SHADWELL/688 instrument suite included thermocouples, gas sample loops (with oxygen, carbon dioxide and carbon monoxide analyzers for each loop), radiometers, calorimeters, optical density meters (ODMs), pressure transducers, biflow velocity probes and both infrared (IR) and visible light video cameras. Instrument locations are shown in Appendix A.

In the sections below, we discuss those instruments that were significant for the present analysis. For the fire experiments, the primary interests were the temperatures in the torpedo room and habitability of the critical spaces. Habitability is largely determined by the temperature, oxygen and toxic gas concentrations and visibility. Accordingly, the primary instruments in these tests were the thermocouples in the torpedo room, control room and combat systems space, the gas sample loops in the torpedo and control rooms and the control room ODMs. For the explosion tests, the focus was on the fast pressure transients within the torpedo room.

In addition to the above, thermocouples and pressure transducers were installed in the pressure vessel and in the fuel line near the nozzles in order to monitor the bulk fuel properties and the nozzle operating conditions.

3.3.1 Thermocouples

Three thermocouple trees were located in the control room², two in the combat systems space, four in the torpedo room, three in the laundry passageway and four in crew living. Each tree had five thermocouples at approximately 0.5 m (1.7 ft.) vertical intervals from 0.5 m (1.7 ft.) to 2.5 m (8.2 ft.). Some trees had an additional thermocouple located at an elevation of 5.0 centimeters (2.0 in.).

In addition, a thermocouple was placed above the center nozzle (near the overhead) in the torpedo room. Because the flame impinged on this thermocouple during most test, it was not useful for measuring ambient temperatures but did provide verification of ignition and extinguishment, independent of the torpedo room video cameras.

3.3.2 Gas Sample Loops

Two of the three available gas sample loops were installed in the control room, one at an elevation of 0.46 m (1.5 ft.) and the other at 2.3 m (7.5 ft.). To monitor the oxygen availability near the fire location, the third gas sampler was placed in the torpedo room 1.0 m (3.3 ft.) above the deck and 0.6 m (2.0 ft.) aft of the forward bulkhead.

3.3.3 Optical Density Meters

Two ODMs were located in the control room at elevations of 1.0 m (3.3 ft.) and 2.0 m (6.6 ft.). These provided an indication of optical transmission, which is a measure of visibility.

3.3.4 Fast-Response Pressure Transducers

Normally, pressure transducers are placed in the instrumentation node rooms (the node room closest to the torpedo room is located in the storeroom immediately forward) and connected by one-quarter inch copper or stainless steel tubing to the desired sample position within the test area. Due to the long runs and the small diameter of these tubes, this arrangement has a relatively long time constant and is not suitable for measuring fast transient events.

In order to overcome this problem, a 0 — 15 psi pressure transducer was installed in the well deck outside the torpedo room and connected to a short [approximately 25 cm (10 in.)], large-bore [2.5 cm (1 in.) diameter] stainless steel tube that penetrated the well deck bulkhead into the aft portion of the torpedo room.

3.3.5 Video Cameras

Video cameras were placed at various locations within and around the test area. In addition to the normal, visible light camera, an IR video camera was also used in the torpedo room so that the fire could be monitored even after visibility had been lost due to smoke accumulation. The torpedo room video provided a means of verifying ignition and extinguishment of the fires.

² The control room was divided into two regions, the control space (which had two thermocouple trees) and the navigation equipment space (which had one). For convenience, the term "control room" refers to both.

For the fire tests, the most important video sources were the cameras (visible and IR) installed in the aft portion of the torpedo room and oriented to view forward, toward the nozzle array. For some of the explosion tests, cameras located in the well deck and on the island adjacent to the port side of the ship captured images of the external effects of the explosions.

3.4 Data Acquisition

The MassComp data acquisition system used at the ex-*USS Shadwell* facility is limited to a one Hertz scan rate. Although more than adequate for fire experiments, this is much too slow to obtain meaningful pressure transient data for explosions. As a consequence, the primary data system for explosion experiments used custom software to control a National Instruments (NI) SCXI 1001 chassis containing an NI model SCXI 1100 analog input module with an attached NI model SCXI 1303 signal conditioner block.

The data acquisition software was written for National Instruments LabVIEW (version 6) and was executed on a computer running Windows 2000. In order to reduce the operating overhead during data acquisition, raw binary data, representing the transducer outputs in volts, were stored on disk during the experiments. At the end of each run, this data file was converted to an ASCII text file, still in volts; conversion to engineering units (psi) was performed off-line. With this approach, it was possible to acquire data at millisecond intervals.

One channel was used for the torpedo room pressure data and another was allocated to monitor the state of a logic switch that was triggered when the ignitor fired. Because the switch was also monitored by the MassComp, this provided a mechanism for synchronization of the two data systems.

3.5 Test Matrices

Tables 4 and 5 list the tests conducted during Series 1a and 1b, respectively. For the fire tests, the variables were the number of nozzles and the ventilation configuration. In the case of explosion scoping tests, the spray time prior to ignition was also a parameter.

For the explosion tests, the torpedo room was isolated from the remainder of the SHADWELL/688 test area. This was done for two reasons: (1) the spread of potentially explosive vapors to other spaces was minimized; and (2) by confining the fuel mist, the explosive over-pressure was increased, allowing larger explosions to be simulated with minimal quantities of fuel.

However, setting too many closures could have produced dangerously high over-pressures, potentially risking injury to test personnel and severe damage to the test facility. To address this issue, closure settings, number of nozzles and fuel flow times were varied to progressively increase the severity of the explosions.

Test	Nozzles	Ventilation	Classification
HFH-01	1	Secured; dampers closed; exterior scuttles open; torpedo room safety doors open	Shakedown test
HFH-02	1	Secured; dampers closed; scuttles open; safety doors open	Shakedown test
HFH-03	1	Recirculation on; secured at +10 sec.	Operational test w/ secured ventilation
HFH-04	1	Recirculation on; not secured.	Operational test w/o secured ventilation
HFH-05	3	Recirculation on; not secured.	Operational test w/o secured ventilation
HFH-06	3	Recirculation on; secured at +10 sec.	Operational test w/ secured ventilation
HFH-07	5	Recirculation on; secured at +10 sec.	Operational test w/ secured ventilation
HFH-08	5	Recirculation on; not secured.	Operational test w/o secured ventilation
HFH-09	1	Secured; dampers closed; exterior & bilge scuttles open; torpedo room safety doors open	Modeling test
HFH-10	1	Secured; dampers closed; exterior scuttles open; bilge scuttles closed; torpedo room aft safety door open	Modeling test
HFH-11	1	Secured; dampers closed; exterior scuttles open; bilge scuttles closed; torpedo room aft safety door open	Modeling test
HFH-12	1	Secured; dampers closed; exterior scuttles open; bilge scuttles closed; torpedo room aft safety door open	Modeling test

Table 4. Series 1a Fire Test Matrix

The number of nozzles and the ventilation conditions are indicated for each of the Series 1a fire tests. The last column indicates the classification of each test, as discussed in the text.

Test	Nozzles	Time (sec)	Ventilation	Classification
HFH-13A	1	5	SD1, SD2, H8 & D10 open	Scoping test
HFH-13B	1	10	SD1, SD2, H8 & D10 open	Scoping test
HFH-13C	1	15	SD1, H8 & D10 open; SD2 smoke curtain	Scoping test
HFH-13D	1	15	SD1, H8 & D10 open; SD2 smoke curtain	Scoping test
HFH-14A	3	5	SD1, H8 & D10 open; SD2 smoke curtain	Scoping test
HFH-14B	3	5	SD1, H8 & D10 open; SD2 smoke curtain	Scoping test
HFH-14C	3	10	SD1, H8 & D10 open; SD2 smoke curtain	Scoping test
HFH-15A	5	10	H8 & D10 open; SD1. SD2 smoke curtains	Scoping test
HFH-15B	5	15	H8 & D10 open; SD1. SD2 smoke curtains	Scoping test
HFH-15C	5	20	H8 & D10 open; SD1. SD2 smoke curtains	Scoping test
HFH-16A	5	10	D10 open; SD1. SD2 smoke curtains	Scoping test
HFH-16B	5	15	D10 open; SD1. SD2 smoke curtains	Scoping test
HFH-16C	5	20	D10 open; SD1. SD2 smoke curtains	Scoping test
HFH-16D	5	30	D10 open; SD1. SD2 smoke curtains	Scoping test
HFH-17A	5	10	SD1. SD2 smoke curtains	Scoping test
HFH-17B	5	20	SD1. SD2 smoke curtains	Scoping test
HFH-17C	5	30	SD1. SD2 smoke curtains	Scoping test
HFH-18A	5	10	SD2 smoke curtain	Scoping test
HFH-18B	5	20	SD2 smoke curtain	Scoping test
HFH-18C	5	30	SD2 smoke curtain	Scoping test
HFH-19A	5	15	All closed	Scoping test

Table 5. Series 1b Explosion Scoping Test Matrix

The number of nozzles and the pre-ignition spray time is indicated for each of the Series 1b explosion tests. The last column indicates the classification of each test, as discussed in the text.

The conditions for the Series 2 tests are shown in Table 6. Based on the results of the Series 1b scoping tests, the ventilation configuration of HFH-19A was used for these tests, except that all of the frame bays were closed to prevent hydraulic mist from spreading throughout the test area.

Also, the forward torpedo room safety door (SD2) was opened and a smoke curtain was installed for both Series 2 demonstrations (HXH-Demo1 and HXH-Demo2). This arrangement allowed the fireball generated by the explosion to be photographed more readily while still containing the mist prior to the explosion.

3.6 Fire Test Procedures

For each fire test (Series 1a), the number of nozzles installed was as specified in Table 4. Single-nozzle experiments always had the nozzle in position three (center) and nozzles were added in positions one (forward) and five (aft) for the three-nozzle test. All positions were occupied for the five-nozzle tests. Closures were set in accordance with Table 4 and the fuel vessel pressure was adjusted to maintain the nozzle pressure at about 1000 psi.

Data collection on the MassComp was initiated approximately two minutes prior to ignition in order to establish a background for each test and was continued for several minutes after extinguishment.

3.6.1 Ventilation

Three different configurations of the recirculation system were used for the Series 1a fire tests. In the "off" state, the supply and exhaust fans were not activated and the ventilation dampers were closed to prevent passive smoke movement through the system. This configuration was used during shakedown tests and for the fire modeling tests.

For the "operational" tests, the recirculation system was initially turned on. The supply and exhaust fan controller settings were 36% and 42%, respectively, which were the approximate values that had previously been found to provide balanced flows [20]. In half of these tests, the fans were secured 10 seconds after ignition, in accordance with the current "secure ventilation upon fire detection" doctrine. In the other half, the fans were left running to simulate cases in which securing the ventilation was not possible.

During all Series 1 tests, the two frame bays that connect the laundry passageway to the control room were obstructed while the other six were open.

3.6.2 End-of-Test Criterion

In order to prevent the buildup of potentially hazardous fuel vapors, the fuel supply was secured when the fire self-extinguished due to reduced oxygen concentration in the torpedo room. This determination was made by the test director, based on observation of the visible and IR fire images and on the flame temperature thermocouple readings, all of which were displayed in the test control center in real time.

Test	Nozzles	Spray Time (sec)	Classification
HXH-00	5	15	Shakedown test
HXH-01	5	5	Shakedown test
HXH-Demo1	5	120	Demonstration
HXH-Demo2	5	120	Demonstration
HXH-02	1	15	Pressure transient test
HXH-03	1	15	Pressure transient test
HXH-04	2	15	Pressure transient test
HXH-05	2	15	Pressure transient test
HXH-06	2	15	Pressure transient test
HXH-07	3	15	Pressure transient test
HXH-08	3	15	Pressure transient test
HXH-09	4	15	Pressure transient test
HXH-10	4	15	Pressure transient test
HXH-11	3	15	Pressure transient test
HXH-12	3	15	Pressure transient test
HXH-13	3	15	Pressure transient test
HXH-14	4	15	Pressure transient test
HXH-15	4	15	Pressure transient test
HXH-16	5	15	Pressure transient test
HXH-17	5	15	Pressure transient test
HXH-18	5	15	Pressure transient test
HXH-19	2	15	Pressure transient test
HXH-20	4	15	Pressure transient test
HXH-21	4	15	Pressure transient test
HXH-22	5	15	Pressure transient test

Table 6. Series 2 Explosion Test Matrix

The number of nozzles and the pre-ignition spray time is indicated for each of the Series 2 explosion tests. With the exception of HXH-Demo1 and HXH-Demo2, the ventilation configuration for these tests was similar to that of HFH-19A (see Table 5). The last column indicates the classification of each test, as discussed in the text.

3.7 Explosion Test Procedures

During the Series 1b explosion scoping tests, the nozzles were installed in the same manner as in Series 1a, and the closures were set in accordance with Table 5. For a given number of nozzles, fuel concentration was varied by changing the spray time prior to ignition. Again, the nominal nozzle pressure was 1000 psi.

Because of the in-line fuel filter installed prior to Series 2, the nozzle operating pressures were typically about 100 — 300 psi lower than the vessel pressure during these tests. To compensate, the vessel operating pressures were increased to ~1400 — 1450 psi, resulting in a net increase in nozzle pressure to about 1100 — 1350 psi, depending on the fuel flow rate and other operating conditions. This improved the realism of the tests by more closely approximating the operating pressure of a real submarine hydraulic system.

In Series 1b, both the number of nozzles and the spray time were varied. This changed the mist concentration, but also changed the time available for the droplets to “rain” out. To minimize the variability between experiments, an alternative approach was used in which the spray time was held constant at fifteen seconds but the number of nozzles was varied from test to test (except for the shakedown tests and demonstrations). Any nozzle positions not used in a specific test were plugged.

MassComp data collection was initiated approximately two minutes prior to the start of fuel flow. This system was used to record parameters that did not change rapidly, such as the fuel pressure. For the pressure transient data, the LabVIEW system was used but, due to the large amount of data generated, it was only run for approximately ten seconds, starting five seconds before ignition (not prior to the start of fuel flow). At a one kilohertz data rate, each test produced approximately 10,000 data points for each of the data channels.

3.7.1 End-of-Test Criterion

Each explosion test was terminated, by securing the fuel flow, immediately after the explosion. Due to the length of fuel pipe between the control valve and the nozzles, there was a pressure bleed period after the valve was secured. As a result, the fire did not go out instantly but, in most cases, extinguishment occurred within a few seconds. In some cases, residual fuel in the pan below the nozzles was ignited during the explosion event and, in those cases, the fire continued to burn for a period on the order of one minute after the fuel was turned off.

4.0 DATA ANALYSIS

4.1 Fire Tests

As was previously indicated, the primary parameters of interest for the fire tests were the temperatures and atmospheric data for the torpedo room, control room, combat systems space, crew living and laundry passageway. For all thermocouple trees, gas analysis channels and ODMs in those compartments, the data were plotted and inspected for indications of any experimental problems — broken or shorted transducers, for example. At this stage, several bad

channels were detected and removed from the analysis.

In fires, it is common to find that the atmosphere is segregated into a hot upper layer and a (relatively) cool lower layer. Furthermore, the composition of the two layers is often different, with the upper layer containing higher concentrations of fire products and lower concentrations of oxygen than the lower layer. Rather than attempt to quantify the layer height for each test, our analysis focused on estimating the atmospheric conditions above and below a defined threshold. This threshold, 1.5 m (4.9 ft.), was chosen as a reasonable demarcation between people sitting at consoles and those standing.

4.1.1 Temperature Data

Some of the thermocouple channels exhibited excessive noise due to the combination of long cable runs, millivolt level signals and an electronically noisy shipboard environment. A five-point sliding average significantly improved the signal to noise ratio (SNR) for those channels. Many thermocouple channels had an acceptable SNR without any processing but, in order to provide a uniform analysis procedure, the same sliding average was applied to all thermocouple channels.

As expected, for a given thermocouple tree, the temperatures usually increased with elevation. In addition, for the same elevation, there were temperature differences among trees within a given compartment. In order to obtain more meaningful estimates of the overall compartment environment, separate averages were calculated for all thermocouples above and below the threshold elevation.

The mean temperature in the test area before the start of fire testing varied from one experiment to another. In part, this was due to differences in ambient temperature but the largest component was caused by heating of the spaces due to prior testing — with, typically, three tests per day, there was not enough time for the test area to cool between fires.

To correct for this effect, pre-ignition mean temperatures were normalized to a standard pre-test temperature of 25 °C (77 °F). This was accomplished by calculating the upper and lower layer mean temperatures for the period preceding ignition and subtracting the difference between the means and 25 °C (77 °F) from the upper and lower layer temperatures, as shown by Equation 2

$$T_{\text{cor}} = T_m - (T_0 - 25) \text{ °C} \quad \text{Eqn. 2}$$

where T_{cor} is the mean layer temperature, corrected for the difference in initial temperature, T_m is the uncorrected mean layer temperature and T_0 is the mean pre-ignition temperature for the layer. Temperature data for the fire tests are given in Appendix B.

4.1.2 Atmospheric Data

There were two gas sampling points in the control room, one at an elevation of 2.4 meters (7.8 ft.) and the other at 0.46 m (1.5 ft.). The carbon dioxide analyzer attached to the low elevation gas sample loop malfunctioned and, therefore, only one carbon dioxide value was obtained

during these tests. However, even though the gas measurements were made at very different elevations, it was found that, for oxygen and carbon monoxide, the values were very similar at both elevations. Thus, it is likely that the missing carbon dioxide concentrations would have been essentially the same as the single set of values that were obtained. Because of the similarity of the upper and lower gas concentrations, we have chosen to combine the data from both elevations and report only average values.

A single gas sample loop was available in the torpedo room. Gas measurements were made in the vicinity of the fire at an elevation of approximately 1 m (3.3 ft.).

Optical density was measured as percent transmittance, which is approximately related to visibility [21] by

$$V = -3 L / (\ln T/100) \quad \text{Eqn. 3}$$

where L is the optical path length of the ODM instrument in meters (one meter for the ODM instruments used in these tests) and T is the transmittance in percent. The factor of three applies for normal front illumination³. Due to fluctuations in the instrument outputs, the ODMs produced some values in excess of 100% transmittance, which is physically meaningless. To circumvent this problem, Equation 3 was only applied to those values that were less than 100%.

The two ODM instruments in the control room both suffered from intermittent malfunctions, probably due to deposition of soot on their exposed optical components during the test. Where data from both instruments were available, mean values were calculated and are reported here.

A five-point sliding average was applied to the gas and optical density data to reduce the noise and an offset correction was applied, similar to that used for temperature data, to adjust the pre-ignition offsets to standard values (21% oxygen, zero percent carbon dioxide and carbon monoxide and 100% transmittance⁴). Graphs of the gas concentrations, optical densities and visibilities are presented in Appendix C.

4.1.3 Event Timelines

The major events of interest are those that adversely effect the habitability of the fire compartment or a critical space. For this analysis, we selected the following threshold criteria:

1. air temperature greater than 100 °C (212 °F);
2. visibility less than 1.7 meters (5.6 feet).

These criteria have been used for tenability estimates in previous work [22]. The air temperature

³ For backlit situations, such as "Exit" signs, a factor of eight is suggested in reference [21].

⁴ There was a problem with the ODMs during test HFH-07 that resulted in full-scale readings of about 70% (rather than 100%). Since this appeared not to be an offset issue, the pre-ignition mean correction was not applied to this test.

threshold is a reasonable upper limit for unprotected personnel (*i.e.*, those not wearing fire fighting ensembles) while the visibility threshold is representative of the obscuration at which egress from the space would become problematical. Oxygen, carbon dioxide and carbon monoxide concentrations were not included in the habitability estimates because it was assumed that emergency airline breathing (EAB) masks would be donned immediately at the first indication of a contaminated atmosphere.

The processed temperature and visibility data (*i.e.*, after data smoothing and averaging) were parsed to find the first values that exceeded the appropriate threshold and the corresponding times were used as the event times. A table of event times was then compiled for each compartment and a set of event timelines was constructed from the table.

4.2 Explosion Tests

For the explosion tests, only the instruments within the torpedo room were of interest because that space was effectively isolated from the other compartments. In addition, due to the short time scale of the explosion events (on the order of milliseconds), only the fast response pressure transducers were able to capture useful data.

4.2.1 Pressure Transient Data

Analysis of the pressure transient data was performed off-line. For each experiment, the raw pressure transducer output voltages were read from the ASCII data file generated by the LabVIEW software. Since data acquisition times were hardware-controlled by the SCXI chassis, it was known that each scan represented one millisecond. Therefore, a time track was added by creating a column of numbers starting with zero and incrementing by one for each row of data. This was then corrected to the ignition time by shifting the time track so that time zero corresponded to the time at which the logic switch was toggled, as indicated by a transition from zero to five volts on the ignition logic channel.

For each test, the raw data were smoothed, using a five-point sliding average, to improve the signal-to-noise ratio. The baseline transducer output was calculated as the mean of the pre-ignition values and this offset was subtracted from the smoothed data to correct for the experiment-to-experiment drift in the transducer output. This had the effect of converting all voltages to delta values representing the change in output due to the explosion. A laboratory-measured transducer calibration factor was then applied to convert from voltage to pressure.

Pressure transients for all of the pressure transient experiments (see Table 6) were plotted and, for each experiment, the maximum over-pressure was estimated as the average over a 100 millisecond interval centered on the peak of the curve. A typical example of the pressure versus time curve is shown in Figure 5 (all of the curves are included in Appendix D).

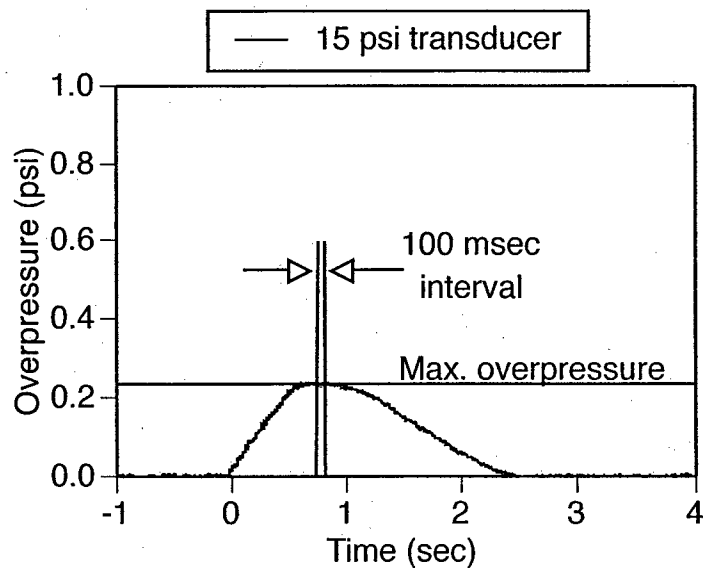

Figure 5. Typical Pressure Transient

This pressure transient, from experiment HXH-02, was typical. The maximum over-pressure was estimated as the mean of the values over a 100 millisecond period centered on the peak of the curve.

5.0 RESULTS & DISCUSSION

5.1 Fire Tests

In this section, we discuss the fire test results for the torpedo room, crew living space, combat systems space, laundry passageway and control room. The order corresponds to the expected spreading pattern of the combustion products — primarily, directly upward from the fire compartment and, secondarily, horizontally to an adjacent compartment and then upward from there. For each of these compartments, we consider the temperatures and, where available, the gas concentration and visibility. Timelines for events relevant to loss of habitability are also discussed.

5.1.1 Flame Temperature and Burning Time

Figure 6 shows the flame temperatures for the three fires in which the ventilation system was secured at +10 seconds, in keeping with current doctrine. The corresponding data for those cases in which the ventilation was not secured is shown in Figure 7.

The maximum temperature is primarily dependent on the adiabatic flame temperature, which is a function of the fuel and is relatively insensitive to the burning conditions. Therefore, as we would expect, the peak temperatures are very similar for most of the tests, regardless of the ventilation conditions. Test HFH-04 was an exception. In that test, the flame apparently was not

impinging on the thermocouple, resulting in an anomalous reading. However, the duration of burning, which was the purpose of this thermocouple, was correctly measured.

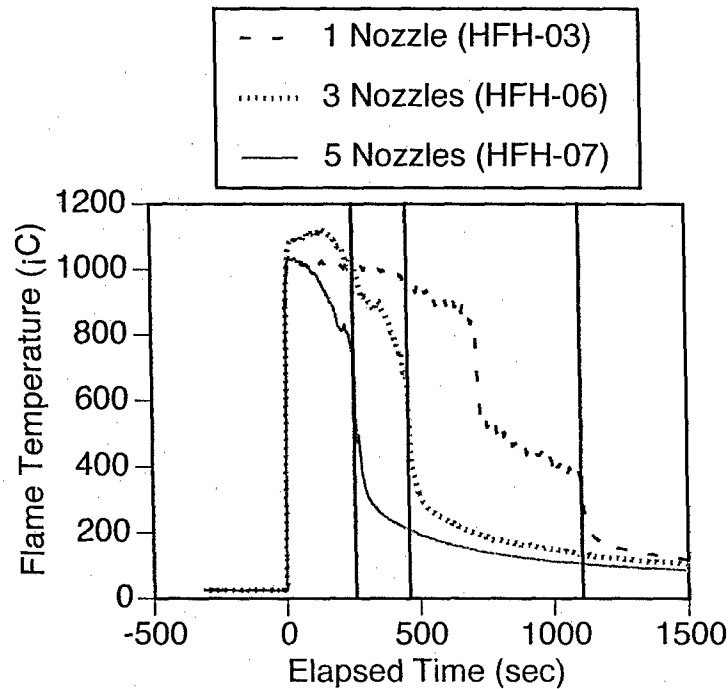

Figure 6. Flame Temperature vs. Time With Ventilation Secured at +10 Seconds

The flame temperature is shown as a function of time for the three tests in which the ventilation system was secured at +10 seconds. The vertical lines indicate the approximate fire extinguishment time for each test. Note that burning time is inversely related to the number of nozzles.

Approximate extinguishment times are indicated by the vertical lines superimposed on the temperature curves at the point at which the flame temperature begins to drop exponentially. As is readily apparent, there are large differences in burning times for different numbers of nozzles, with larger fires burning for shorter periods. This is attributed to the more rapid depletion of oxygen for the larger fires, leading to earlier self-suppression. However, the burning times are very similar, for a given fire size, regardless of whether the ventilation was or was not secured. Under our test conditions, the forced ventilation contribution was negligible relative to the natural (convection-driven) circulation. The approximate burning times for all six operational tests are shown in Table 7.

Because the data indicate that the fire conditions were essentially the same for both ventilation cases, only data for the more realistic (ventilation secured) case are considered in the following sections.

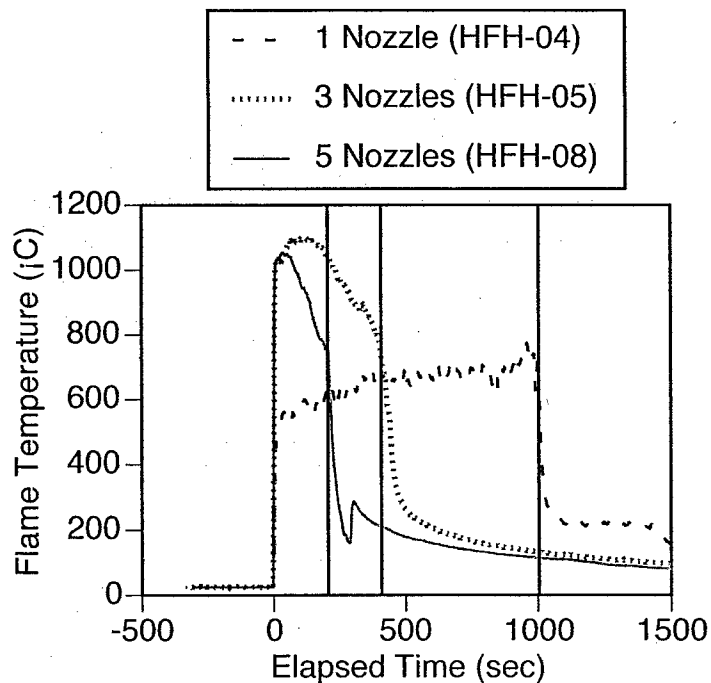

Figure 7. Flame Temperature vs. Time With Ventilation Not Secured

The flame temperature is shown as a function of time for the three tests in which the ventilation system was not secured at +10 seconds. The vertical lines indicate the approximate fire extinguishment time for each test. Note that burning time is inversely related to the number of nozzles.

		Number of Nozzles		
		1	3	5
Ventilation Config.	Secured	1100	450	250
	Not Secured	1000	400	200

Table 7. Approximate Burning Times

The burning times (in seconds), estimated as the time from ignition to the sudden drop in temperature near the end of each test, are given for the 1-, 3- and 5-nozzle cases for the two ventilation scenarios.

5.1.2 Torpedo Room Habitability

As previously discussed, the standard temperature analysis involved segregating the thermocouples into upper and lower layer instruments. However, in the case of the torpedo room, it was found that there was also a pronounced difference between the forward and the aft thermocouple trees. As a result, the thermocouple trees for this compartment were divided into forward and aft sets and the data for these sets were analyzed separately.

Figure 8 shows the air temperatures in the lower and upper portions of the forward part of the torpedo room. The two thermocouple trees represented in these figures were very close to the fire and the upper thermocouples were actually within the flame during portions of the tests. Figure 9 presents similar data for the aft part of the torpedo room. Because the thermocouples in this region were not directly exposed to the flame, these readings are considered to be a more accurate estimate of the overall compartment conditions.

The oxygen and carbon monoxide concentrations are shown in Figures 10 and 11, respectively. Due to a malfunction of one of the analyzers, no carbon monoxide data were obtained for test HFH-03 (single nozzle case). However, the remaining gas data indicate that, irrespective of the temperatures, the atmosphere in the torpedo room rapidly became both anoxic and toxic.

The times at which the habitability threshold temperature was reached are given in the timeline shown in Figure 12, where the symbols represent the upper (down-pointing triangles) and lower (up-pointing triangles) layers. The key observation is that even the smallest of the test fires, with a fuel flow of only 2.0 liters/min. (0.54 gpm), very quickly rendered the torpedo room uninhabitable.

5.1.3 Crew Living Space Habitability

In the case of the crew living space, the temperatures increase much more slowly for the small fire than for the other two, as may be seen in Figure 13. This is due to the significantly different upper layer temperatures in the forward portion of the torpedo room (Figure 8) for the different fire sizes. As a result, the temperature threshold is reached much more quickly in the three- and five-nozzle tests than in the single nozzle test (Figure 14).

The flow from the torpedo room into crew living is in the form of a vertical jet through the connecting scuttle (H8). Because the quantity of gas flowing through the scuttle is restricted by the relatively small area of the scuttle, the temperature rise in crew living is less than might have been anticipated.

For each test, the upper and lower layer temperatures are similar, partly due to the limited temperature energy deposited in the compartment and partly due to turbulence created by the vent jet, which tends to mix the two layers.

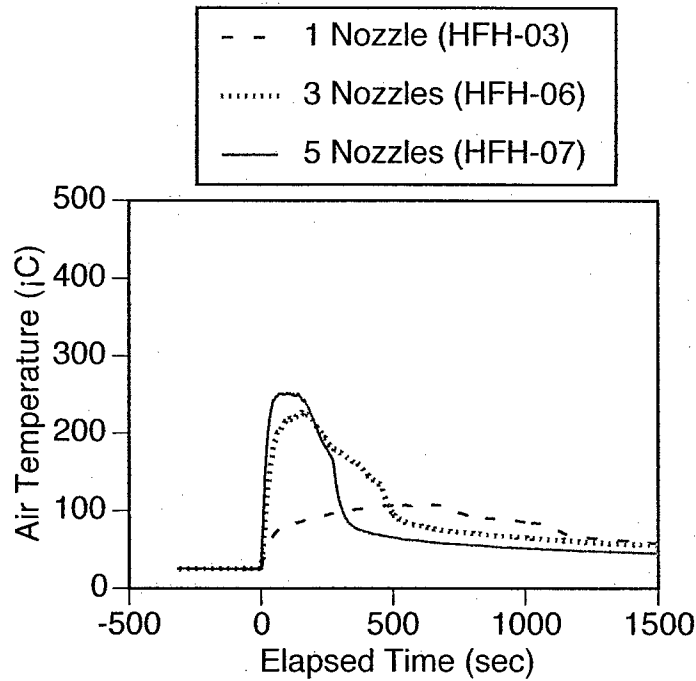
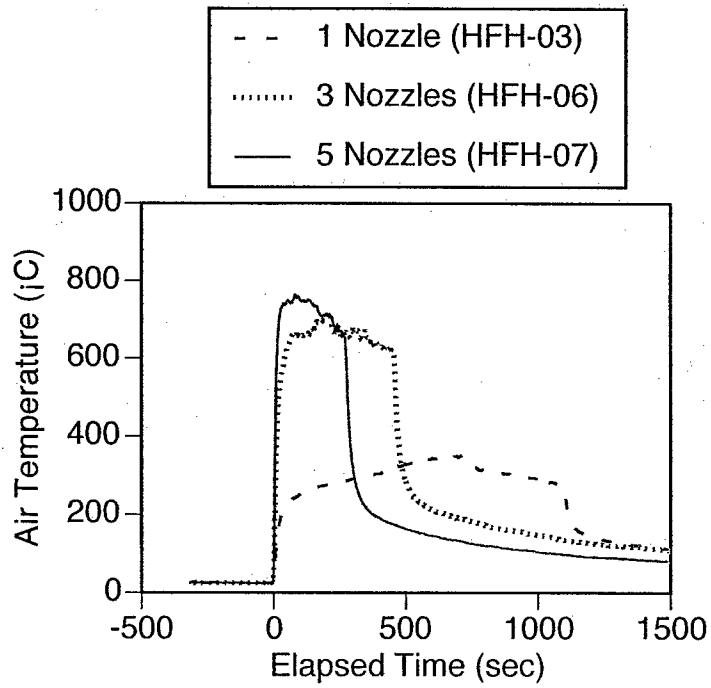

Figure 8. Torpedo Room Air Temperature (Forward Section)

Air temperatures in the forward part of the torpedo room for elevations greater than (upper graph) and less than or equal to (lower graph) 1.5 m (4.9 ft.) with ventilation secured at +10 seconds.

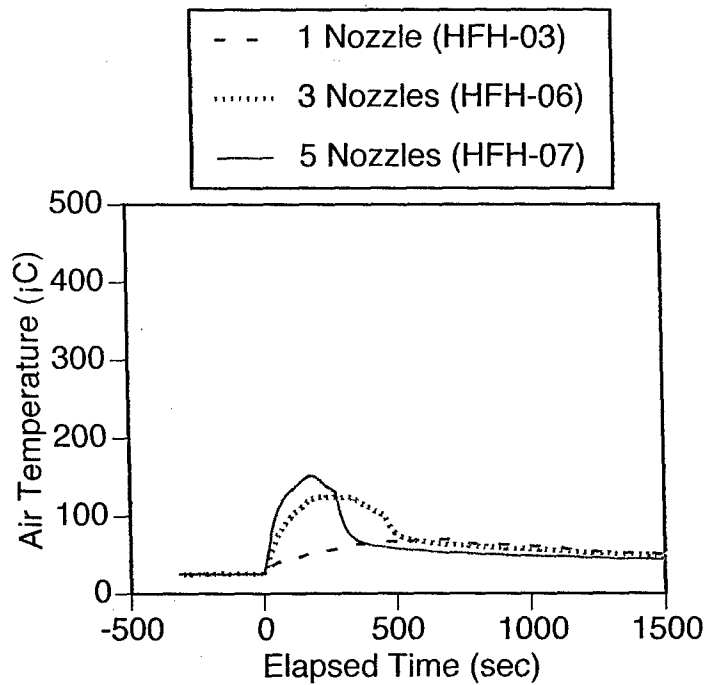
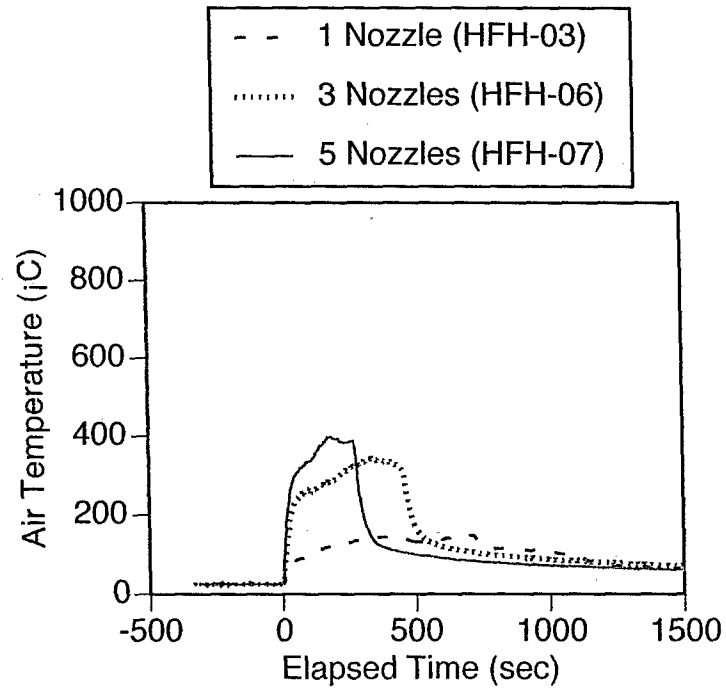

Figure 9. Torpedo Room Air Temperature (Aft Section)

Air temperatures in the aft part of the torpedo room for elevations greater than (upper graph) and less than or equal to (lower graph) 1.5 m (4.9 ft.) with ventilation secured at +10 seconds.

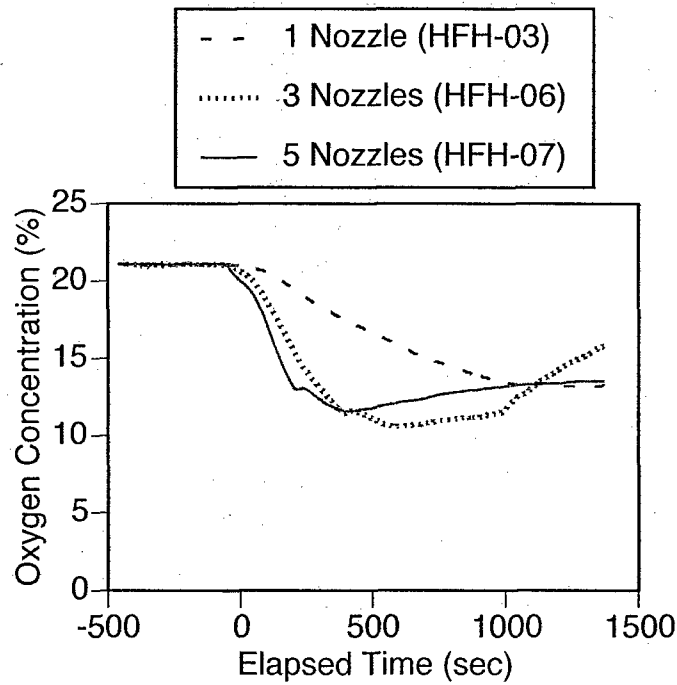

Figure 10. Torpedo Room Oxygen Concentration

Oxygen concentration measured in the torpedo room for tests with ventilation secured at +10 seconds. The gas sample point was located 0.61 m (2 ft.) aft of the forward bulkhead, at an elevation of 1 m (3.3 ft).

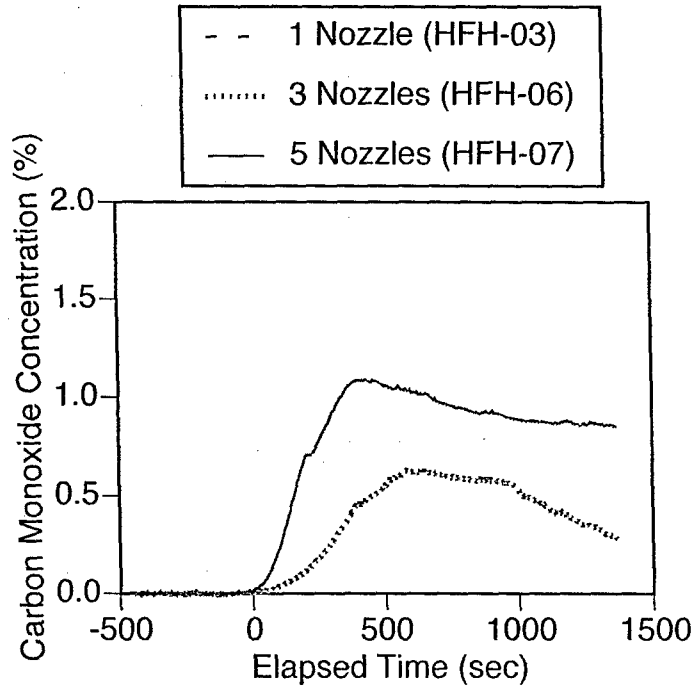

Figure 11. Torpedo Room Carbon Monoxide Concentration

Carbon monoxide concentration measured in the torpedo room for tests with ventilation secured at +10 seconds. The gas sample point was located 0.61 m (2 ft.) aft of the forward bulkhead, at an elevation of 1 m (3.3 ft). Due to a malfunction, no data were obtained for the HFH-03 test.

Compartment	-60	0	60	120	180	240	300	360	420	480	540	600	660	720	780	840	900
Torpedo Room																	
HFH-03		▽															
HFH-06		▽	△														
HFH-07		▽	△														

Figure 12. Torpedo Room Event Timelines

Times at which the torpedo room temperature reached the temperature habitability threshold discussed in the text are shown for tests in which the ventilation was secured at +10 seconds. The tests used one, three and five nozzles, in descending order. Down-pointing triangles indicate upper layer temperatures and up-pointing triangles are for lower layer temperatures. The horizontal time scale is in seconds, with time zero at ignition.

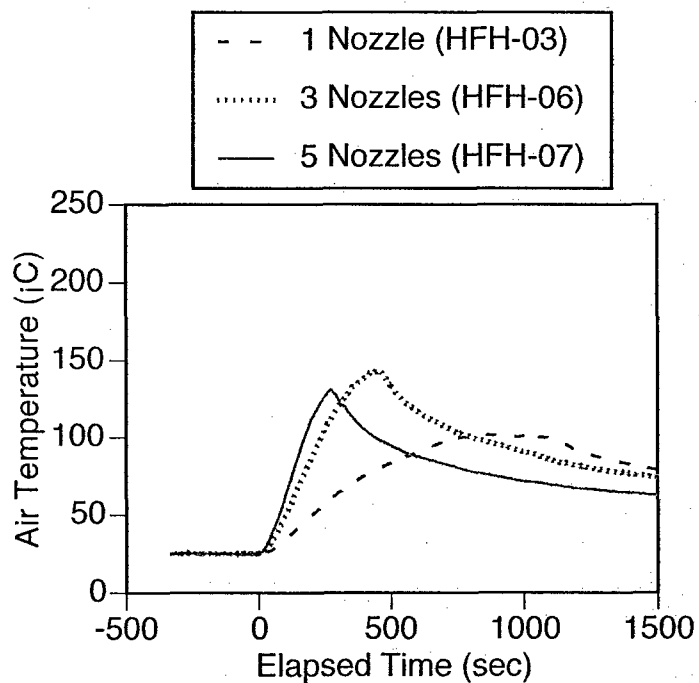
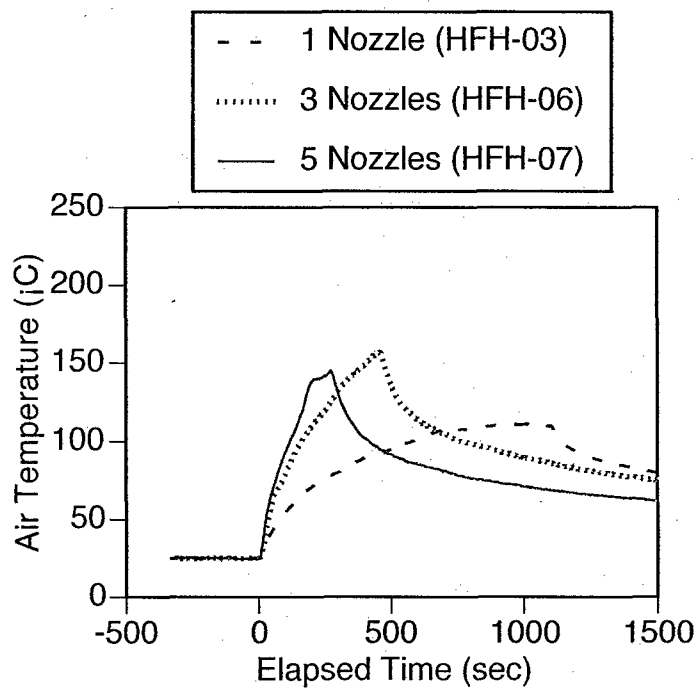

Figure 13. Crew Living Space Air Temperature

Air temperatures in the crew living space for elevations greater than (upper graph) and less than or equal to (lower graph) 1.5 m (4.9 ft.) with ventilation secured at +10 seconds.

Compartment	-60	0	60	120	180	240	300	360	420	480	540	600	660	720	780	840	900
Crew Living Space																	
HFH-03												▽					
HFH-06				▽											△		
HFH-07			▽		△												

Figure 14. Crew Living Space Event Timelines

Times at which the crew living space temperature reached the habitability thresholds discussed in the text are shown for tests in which the ventilation was secured at +10 seconds. The tests used one, three and five nozzles, in descending order. Down-pointing triangles indicate upper layer temperatures and up-pointing triangles are for lower layer temperatures. The horizontal time scale is in seconds, with time zero at ignition.

5.1.4 Combat Systems Space Habitability

It is interesting to note that the air temperatures in the combat systems space (shown in Figure 15) are higher than those in the crew living space, even though combat systems is further from the fire. This is due to the presence of the frame bay ducts that directly connect the torpedo room and combat systems. As a result, the combat systems space is subjected to an inflow of a significant quantity of gas taken directly from the upper layer of the fire compartment as well as a flow of cooler gas from the crew living compartment.

The event timelines for this compartment, shown in Figure 16, indicate that habitability would have been lost within two minutes, except for the case of the lower layer during the smallest fire. This is attributed to the fact that the smaller fires produce lower source gas temperatures and less intense frame bay jets. As a result, the gas plumes from the frame bays are cooler and there is less turbulent mixing into the lower layer of the Combat Systems Space.

5.1.5 Laundry Passageway Habitability

As we have seen above, the fire in the torpedo room drives hot gases upward through the scuttle (H8) and into the crew living space. The resulting convective flow draws makeup air through door D10. Due to this flow of cool, clean air through the laundry passageway, it is expected that conditions in the laundry passageway should be relatively benign. This expectation is confirmed by the low temperatures shown in Figure 17. As illustrated in Figure 18, the habitability threshold temperature was not exceeded in any of the tests for either the upper or lower layers.

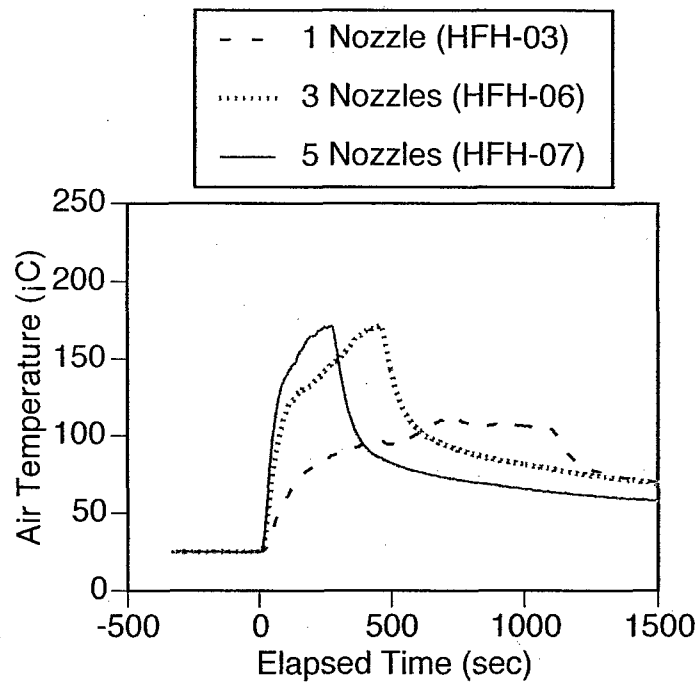
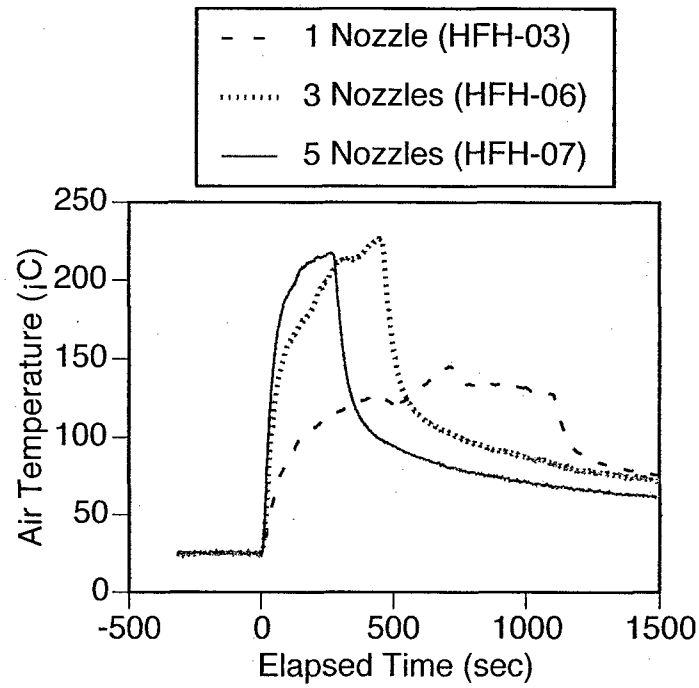

Figure 15. Combat Systems Space Air Temperature

Air temperatures in the combat systems space for elevations greater than (upper graph) and less than or equal to (lower graph) 1.5 m (4.9 ft.) with ventilation secured at +10 seconds.

Compartment	-60	0	60	120	180	240	300	360	420	480	540	600	660	720	780	840	900
Combat Systems																	
HFH-03					▽							△					
HFH-06			▽														
HFH-07			▽	△													
			△														

Figure 16. Combat Systems Space Event Timelines

Times at which the combat systems space temperature reached the habitability thresholds discussed in the text are shown for tests in which the ventilation was secured at +10 seconds. The tests used one, three and five nozzles, in descending order. Down-pointing triangles indicate upper layer temperatures and up-pointing triangles are for lower layer temperatures. The horizontal time scale is in seconds, with time zero at ignition.

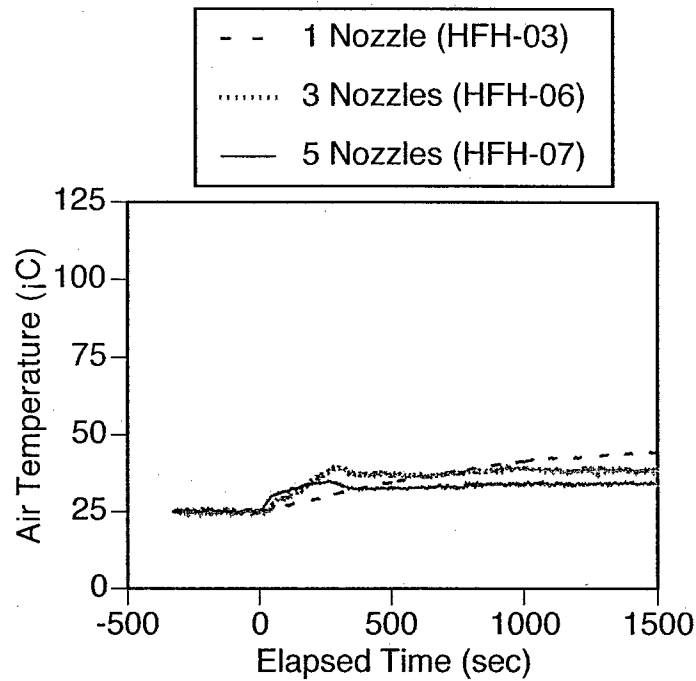
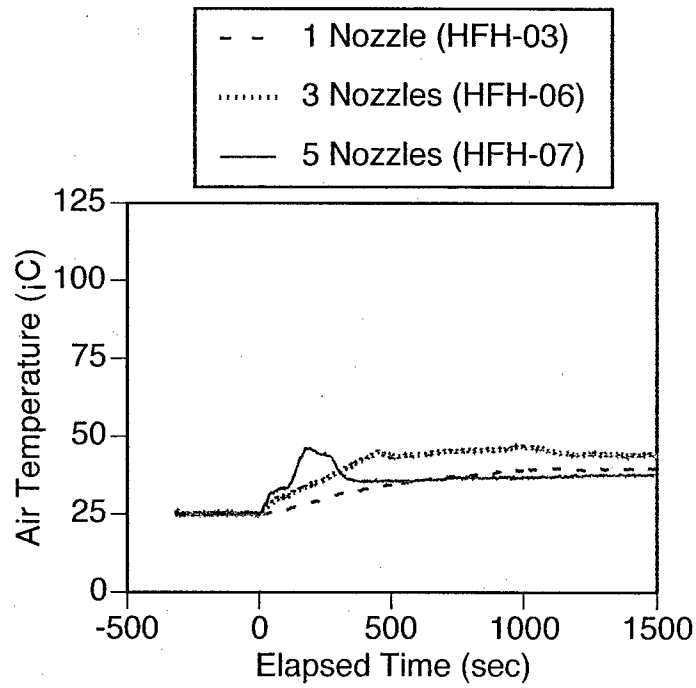

Figure 17. Laundry Passageway Air Temperature

Air temperatures in the laundry passageway for elevations greater than (upper graph) and less than or equal to (lower graph) 1.5 m (4.9 ft.) with ventilation secured at +10 seconds.

Compartment	-60	0	60	120	180	240	300	360	420	480	540	600	660	720	780	840	900
Laundry Passageway																	
HFH-03																	
HFH-06																	
HFH-07																	

Figure 18. Laundry Passageway Event Timelines

Times at which the laundry passageway temperature reached the habitability thresholds discussed in the text are shown for tests in which the ventilation was secured at +10 seconds. The tests used one, three and five nozzles, in descending order. Down-pointing triangles indicate upper layer temperatures and up-pointing triangles are for lower layer temperatures. The horizontal time scale is in seconds, with time zero at ignition.

Note: For this space, the threshold temperatures were never exceeded in any test.

5.1.6 Control Room Habitability

Figure 19 show that air temperatures in the control room were relatively low but still high enough to be of some concern, especially in the upper layer. There were two routes by which fire gases reached the control room: through the forward door (D3) from combat systems and via the frame bays connecting to the laundry and laundry passageway. As we have seen, the laundry passageway temperatures were only slightly greater than ambient, so we can rule out the frame bays as a significant source of hot gas. Most of the observed temperature increase in the control room was due to hot gas rising through the torpedo room frame bays into the combat systems space and then moving aft into the control room through the connecting doorway.

However, the most critical issues relating to the habitability of the control room were the precipitous decline in oxygen concentration (Figure 20) and increase in carbon monoxide (Figure 21). Finally, Figure 22 shows that the control room visibility dropped sharply and, for even a moderate fire size, reached near zero within seconds after ignition.

Event timelines for the control room are shown in Figure 23, with red symbols for temperature and gray for visibility. Note that, for the smallest fire (HFH-03), the temperature never exceeded the habitability threshold and, for the larger fires, did so only in the upper layer.

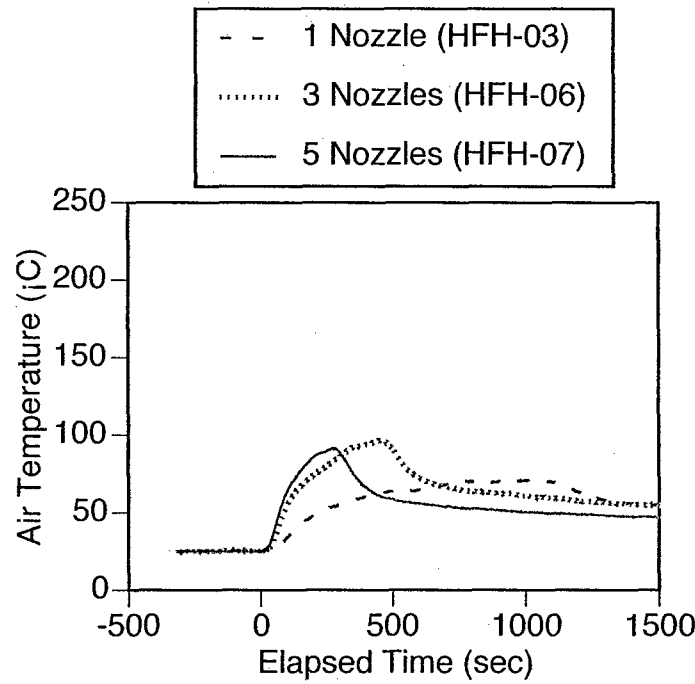
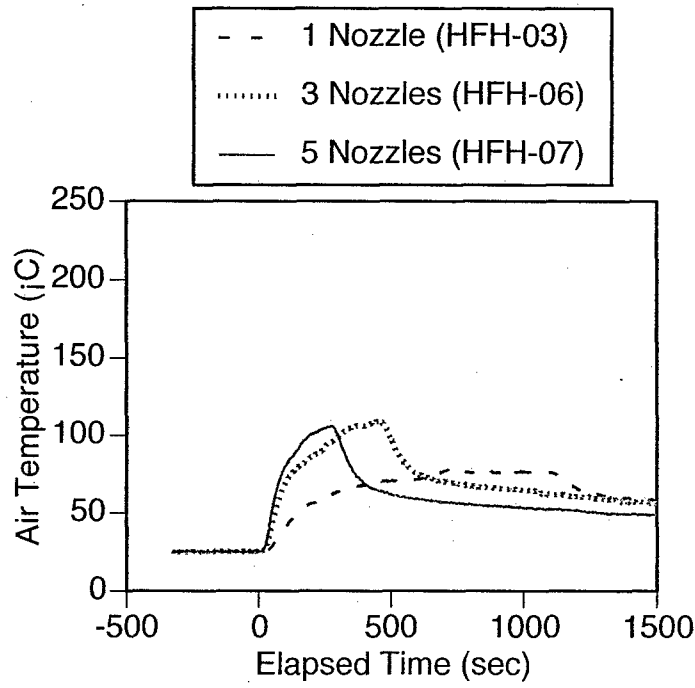

Figure 19. Control Room Air Temperatures

Air temperatures in the control room for elevations greater than (upper graph) and less than or equal to (lower graph) 1.5 m (4.9 ft.) with ventilation secured at +10 seconds.

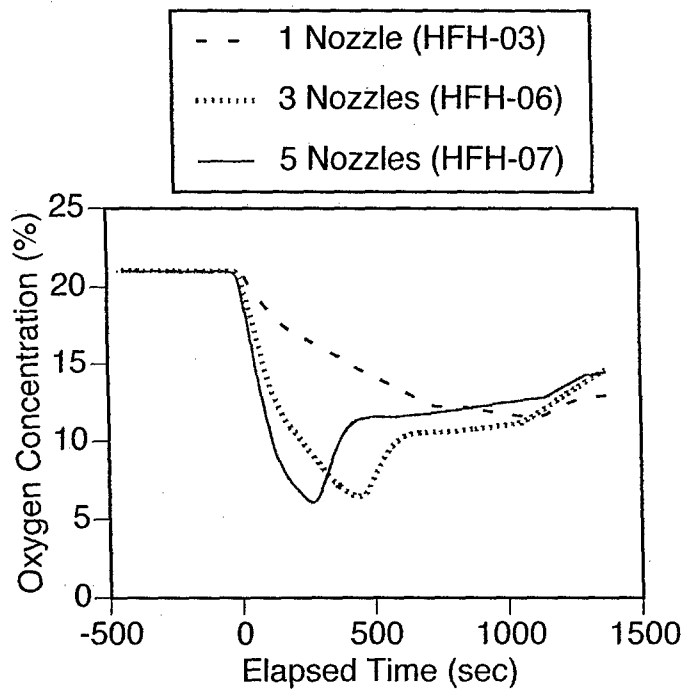

Figure 20. Control Room Oxygen Concentrations

Mean oxygen concentration measured in the control room for tests with ventilation secured at +10 seconds. The gas sample point was located 0.6 m (2 ft.) aft of the forward bulkhead, at an elevation of 1 m (3.3 ft).

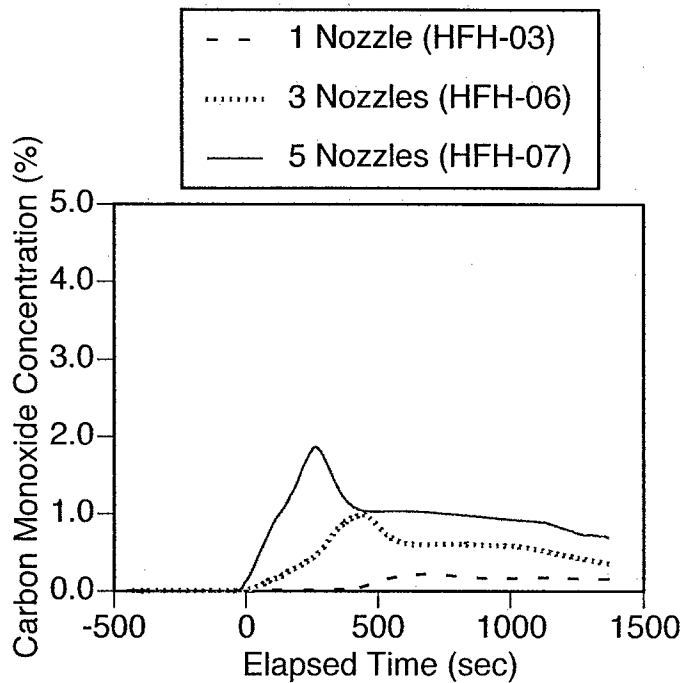

Figure 21. Control Room Carbon Monoxide Concentration

Mean carbon monoxide concentration measured in the control room for tests with ventilation secured at +10 seconds. The gas sample point was located 0.6 m (2 ft.) aft of the forward bulkhead, at an elevation of 1 m (3.3 ft)

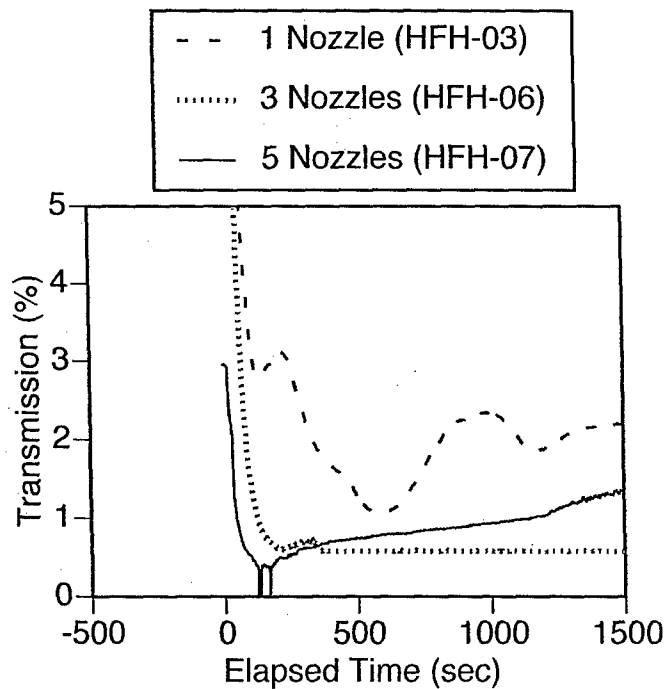

Figure 22. Control Room Visibility

Visibility, estimated from optical transmission measurements (using Equation. 3) for tests with ventilation secured at +10 seconds.

Compartment	-60	0	60	120	180	240	300	360	420	480	540	600	660	720	780	840	900
Control Room																	
HFH-03									▼								
HFH-06				▼				▼									
HFH-07		▼	▲			▼											

Figure 23. Control Room Event Timelines

Times at which the control room conditions reached the habitability thresholds discussed in the text are shown for tests in which the ventilation was secured at +10 seconds. The tests used one, three and five nozzles, in descending order. Down-pointing triangles indicate upper layer values and up-pointing triangles are for lower layer values. Open symbols refer to temperatures and solid symbols indicate visibility. The horizontal time scale is in seconds, with time zero at ignition.

5.2 Explosion Tests

In this section, we present the experimental results from the Series 2 explosion tests. Following that, we briefly discuss the theoretical basis for estimating explosive over-pressures and compare the predicted and measured pressure transients. Finally, we consider some of the ramifications of the theory in the context of an operational submarine.

5.2.1 Experimental Pressure Transients

The explosion tests proved that, given the presence of a suitable ignition source, hydraulic sprays can explode. As an illustration of the hazard potential of an hydraulic mist explosion, Figure 24 shows the development of a fireball during one of the demonstration tests. For this demonstration, fuel was allowed to flow for 120 seconds prior to ignition and a smoke curtain was clamped over the frame of the forward safety door. The photographs, captured at approximately 100 millisecond intervals from a video of the test, show the smoke curtain being blown off the door and the fireball expanding into the welldeck. In an hydraulic mist explosion aboard an actual submarine, a similar fireball could propagate down the laundry passageway aft of the torpedo room.

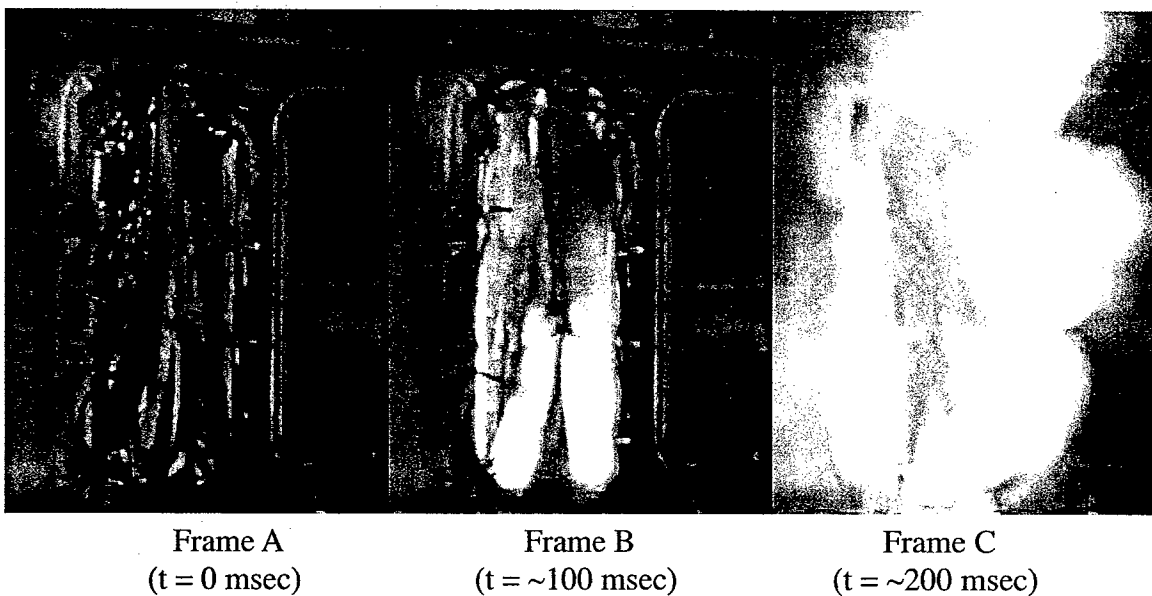

Figure 24. Development of the Fireball

This sequence of video frames illustrates the development of the fireball following an explosion. Frame A shows the smoke curtain in place on the forward safety door immediately prior to ignition. Frames B and C show the developing fireball at intervals of three video frames (approximately 100 milliseconds).

The data from all replicate explosion tests were averaged. Figure 25 shows these mean pressure transients for each nominal explosion size (as determined by the number of nozzles). In addition, the maximum over-pressures were estimated for each test, using the method outlined previously, and are reported in Table 8.

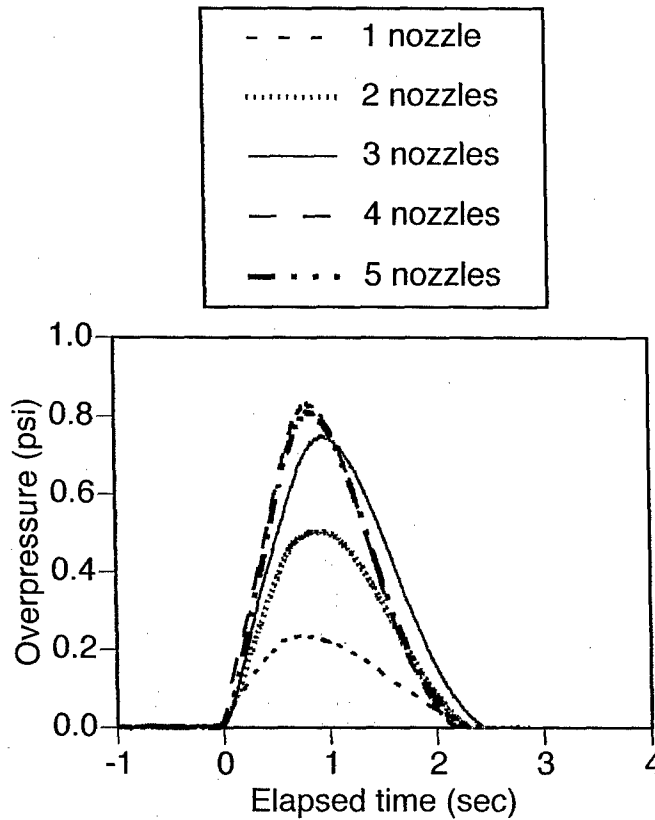

Figure 25. Explosion Transients

Explosion pressure transients were averaged, for each of the five nominal explosion sizes, to obtain these plots.

Finally, the peak pressures were plotted as a function of the quantity of fuel used. Peak pressures were averaged over the replicate tests. Nozzle fuel flow rates were calculated by applying Equation 1 to the nozzle pressures, as recorded by the MassComp data system; these were multiplied by the number of nozzles and the flow time prior to ignition to obtain the total amount of fuel available to the explosion (residual fuel that continued to flow after ignition did not contribute to the explosion). The results are shown in Figure 26, where the error bars represent one standard deviation.

Test	Fuel (liters)	15 psi Transducer	Test	Fuel (liters)	15 psi Transducer
HXH-02	0.6	0.23	HXH-14	2.2	0.82
HXH-03	0.6	0.23	HXH-15	2.3	0.83
HXH-04	1.2	0.48	HXH-16	2.8	0.65
HXH-06	1.2	0.52	HXH-17	2.8	0.90
HXH-07	1.7	0.88	HXH-18	2.8	0.92
HXH-08	1.7	0.78	HXH-19	1.2	0.50
HXH-11	1.7	0.68	HXH-21	2.3	0.77
HXH-12	1.7	0.68	HXH-22	2.8	0.82
HXH-13	1.7	0.72			

Table 8. Observed Maximum Over-pressures

The maximum over-pressures, estimated as described in the text, are given for each pressure transient experiment in Series 2.

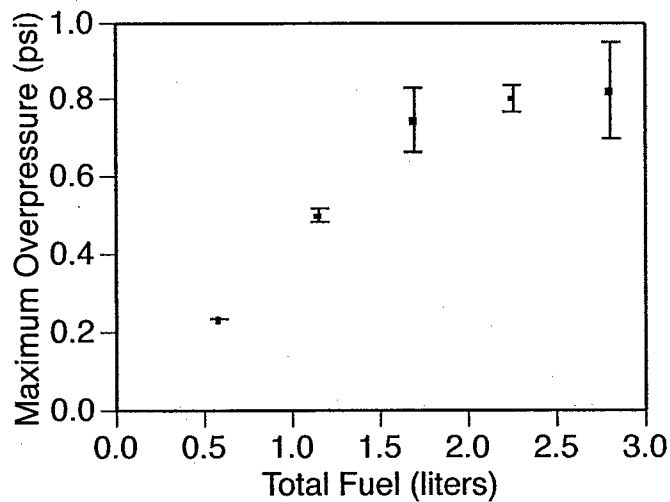

Figure 26. Experimental Peak Pressures

Peak pressures were estimated for each test and the means and standard deviations were calculated for all replicates. The total fuel involved in each test was calculated from the spray time and the nozzle flow rates.

In absolute terms, the over-pressures produced in these tests were relatively low, on the order of one psi and, as was shown in Figure 26, were not linear with the amount of fuel for fuel quantities greater than about 2 liters (0.5 gal.). The reason for the flattening of the over-pressure versus fuel quantity curve may be related to the fraction of fuel that rains out of the cloud. This is dependent on the droplet size distribution and concentration — higher droplet concentrations may lead to greater drop coalescence and, therefore, to a larger fraction of the fuel precipitating out of the suspension.

5.2.2 Theoretical Pressure Transients

For comparison, we have estimated the theoretical maximum pressures that might be expected from hydraulic fluid mists. It is known that, for most hydrocarbons, the maximum over-pressure will be approximately 115 psi for a compartment completely filled with a stoichiometric mixture of air and hydrocarbon vapor (approximately 90 gm/m³ for typical hydrocarbons) [6]. For spaces that are only partially filled or which are filled with a non-stoichiometric mixture, the over-pressure will be reduced linearly.

Droplets less than about 20 μm diameter behave as a gas but larger droplets do not. For mists containing large droplets, the effective amount of fuel is reduced by a factor that depends on the volatility of the fluid and is inversely dependent on the molecular weight of the fluid. For hydraulic fluid, this reduction factor is expected to be about four [6]. Thus, the theoretical over-pressures for hydraulic fluid sprays are estimated to be

$$P_{\text{ovr}} \sim 115 R (V_f / V_s) \text{ psi} \quad \text{Eqn. 4}$$

where P_{ovr} is the estimated over-pressure (psi), R is the volatility correction (thought to be approximately 0.25 for hydraulic fluid), V_f is the actual volume of fuel used and V_s is the volume that corresponds to a stoichiometric quantity for the amount of air in the compartment. The results of these calculations, applied to the volume of the torpedo room [86.6 m³ (3059 ft³)] are given in Table 9.

The observed over-pressures were much lower than the theoretically predicted values, as may be seen in Figure 27. This discrepancy is believed to be primarily due to a combination of three factors:

1. some of the droplets were so large that they rapidly precipitated out of the air, reducing the amount of fuel involved in the explosion;
2. the estimated value of the volatility correction, R , in Eqn. 4 may have been too high; and
3. the torpedo room was not air tight, due to the frame bays connecting with the combat systems space.

Test	Fuel (liters)	Theoretical Overpressure (psi)	Test	Fuel (liters)	Theoretical Overpressure (psi)
HXH-02	0.6	2.1	HXH-14	2.2	7.8
HXH-03	0.6	2.1	HXH-15	2.3	7.9
HXH-04	1.2	4.1	HXH-16	2.8	9.8
HXH-06	1.2	4.1	HXH-17	2.8	9.9
HXH-07	1.7	6.1	HXH-18	2.8	9.9
HXH-08	1.7	6.0	HXH-19	1.2	4.1
HXH-11	1.7	5.9	HXH-21	2.3	8.0
HXH-12	1.7	6.0	HXH-22	2.8	9.9
HXH-13	1.7	6.0			

Table 9. Theoretical Maximum Over-pressures

The theoretical maximum over-pressures for each pressure transient experiment in Series 2 were estimated from Equation 4 based on the actual fuel quantities.

All of these errors would have the effect of decreasing the actual over-pressures relative to the theoretical estimates.

However, in an actual submarine hydraulic casualty, there is a potential for the mean droplet diameter to be smaller than that of our tests (due to the higher shipboard hydraulic pressure). By reducing the amount of fluid lost to precipitation, this would offset the first of the above factors contributing to the discrepancy between theory and experiment. Since these smaller droplets would act more like gases, the volatility correction factor would also likely have less effect.

Finally, we note that the maximum quantity of fuel involved in these tests was only about 2.8 liters (0.75 gal.) and that the capacity of each of the three hydraulic headers on a SSN 688 class submarine is about 50 times greater than this. All of this leads to the conclusion that the over-pressures produced in a real casualty could be significantly higher than those seen in these tests.

6.0 CONCLUSIONS & RECOMMENDATIONS

6.1 Fires

Based on the analysis in the preceding sections, it is evident that even a rather small hydraulic spray [the largest used in these tests was approximately 10.2 liters/min (2.7 gpm)] can produce severe results in a submarine environment. In these tests, the torpedo room was effectively

destroyed and the combination of high temperatures, high carbon monoxide, low oxygen and essentially zero visibility rapidly made the control room uninhabitable. Thermal conditions (and, presumably, toxic gas levels and obscuration) in the combat systems space were even worse, and degraded more quickly, than in the control room. Even in the best case, that of the single nozzle fire, evacuation of both spaces would likely have been necessary within a matter of a few minutes, at most.

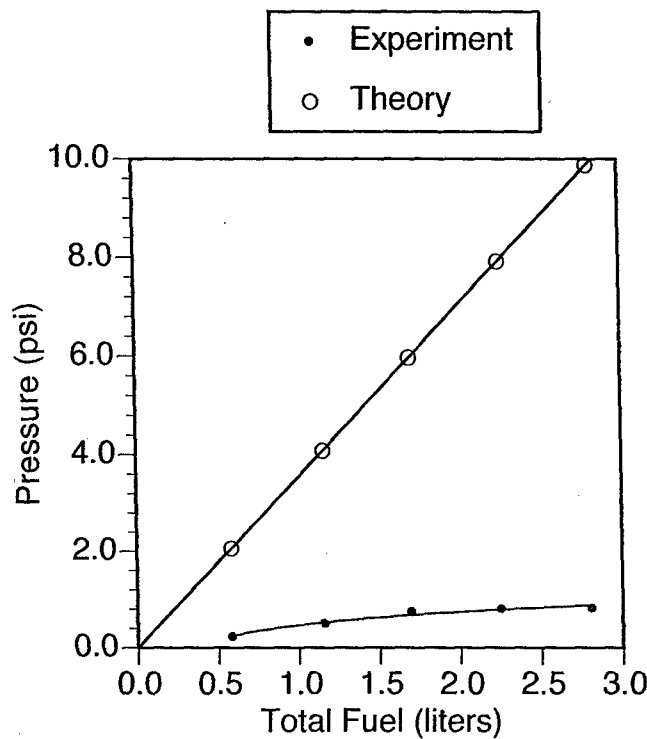

Figure 27. Comparison of Theoretical and Experimental Peak Pressures

Points represent the mean experimental over-pressures and the line shows the corresponding theoretical predictions.

Conditions in compartments on the middeck were less severe, due to the fact that the frame bays permitted much of the hot gas to bypass that level. Also, conditions in the laundry passageway leading to the torpedo room (and even in the aft part of the torpedo room) were much less severe than might be expected. This was due to the fire-induced flow that carried combustion products upward and out of the fire compartment and drew cleaner, cooler air in from more remote parts of the ship.

6.2 Explosions

These tests have shown that 2190 TEP hydraulic fluid sprays can result in a significant explosion event in spite of its low volatility. In an actual hydraulic system casualty, it is theoretically

possible that the explosions could have been larger (by as much as an order of magnitude) if the "casualty" conditions had been such that smaller droplets had been produced. On the other hand, the volume available for expansion was limited in our tests because the torpedo room was closed. In an operational submarine, essentially the entire volume of the forward compartment would have been available and, therefore, the over-pressure pulse would probably have dissipated so that the explosion damage might have been confined to a small region in and adjacent to the torpedo room. The lesson from this is that the extent and location of damage that could result from an hydraulic fluid spray explosion is critically dependent on the details of the casualty.

It is also possible that an explosion would ignite the hydraulic spray, and any hydraulic fluid that had accumulated in a pool. Thus, in addition to the over-pressure damage, an explosion of this type also has the potential to cause major fire damage, as discussed in the previous section. Although the initial explosion may result in casualties and severe damage in the compartment of origin, it is likely that the secondary fire effects would be a more important contribution to overall damage.

6.3 Further Work

These experiments were limited to an evaluation of the potential for an hydraulic mist to explode. Issues relating to aerosol formation, ignition and the theoretical explosion magnitude were not addressed. The results make it clear that the submarine hydraulic system could, potentially, be the source of serious problems.

The fact that conditions have not yet conspired to trigger such a catastrophe should not be a cause for complacency. The reality is that the actual probabilities of many of the events that could result in a major hydraulic fluid fire or explosion are not known. As a practical matter, a fault tree analysis should be performed on a complete submarine hydraulic system in order to estimate the probabilities of various casualty scenarios, especially those resulting from combat operations.

This analysis would permit estimates to be made regarding the probability of various fire or explosion events. However, in order to address the overall risk, it is necessary to also estimate the amount of damage that could be expected should the casualty occur. Better predictive tools are needed for this.

From an engineering perspective, several avenues for further investigation are possible. In the short term, it may be possible to develop techniques to reduce the adverse effects of an hydraulic spray fire after the fact. The extremely rapid progression of these fires provide only a very narrow window for any such efforts and, therefore, it is not certain that this approach will be feasible, or even possible.

An alternative approach would be to address the ignition issues — are there ways to prevent ignition in the event that a hydraulic system rupture occurs? This is also a difficult problem because of the large number of possible ignition sources. It may be possible to lower the probability of ignition, perhaps significantly, but it does not seem likely that it can be eliminated entirely.

Finally, the most elegant approach would be to remove the hazard by eliminating the fuel. Since hydraulic systems are necessary, this approach requires that a non-flammable hydraulic fluid be developed. This is an extremely difficult problem, due to the many competing requirements that hydraulic fluids must meet, and a long-term effort would be needed.

From a more scientific perspective, there are significant gaps in fundamental knowledge about the combustion behavior of hydrocarbon aerosols. In order to develop the improved predictive tools alluded to above, these gaps must be filled. For example, in order to predict droplet distributions from a knowledge of the hydraulic system operating conditions, work is needed to characterize the droplet forming behavior of 2190 TEP as a function of pressure, temperature, additives and other parameters. Likewise, the relationship between droplet sizes and ignition potential must be studied, including investigation of the minimum energy requirements for ignition of hydraulic sprays as a function of the droplet size distribution. The theoretical pressure equation presented above is the gas explosion equation with the introduction of a fudge factor to correct for the effects of droplet volatility. Further work needs to be done to better relate explosion over-pressures to parameters (such as specific surface area and number density) that describe droplet distributions. Some of this information may be available in the literature but additional data will have to be obtained through small scale testing.

6.0 REFERENCES

1. Naval Sea Systems Command, "Submarine Fire Summary," 1 July 1994.
2. Department of the Navy, "Lessons of the Falklands Summary Report," February 1983.
3. Commander Naval Sea Systems Command, SEA 05Q, "Performance Specification, Lubricating Oil, Steam Turbine and Gear, Moderate Service," Military Specification MIL-PRF-17331J, 09 September 2003 (Superseding MIL-PRF-17331H (SH))
4. P.A. Tatem, F.W. Williams, R.A. Brown and C.C. Ndubizu, "Flammability Tests of 2190 TEP in Submarine Lube Oil Application," NRL Letter Report 6180/0698, 13 December 1999.
5. W. Hammer, "Missile Base Disaster Blamed on Welding Mishap," Heating, Piping and Air Conditioning, Vol 40, No 12, pp 94-99, December 1968.
6. A. Mitcheson, "Investigation of an Explosion on a North Sea Production Platform," International Conference on Fire Engineering and Loss Prevention in Offshore, Petrochemical and Other Hazardous Applications, 2nd Proceedings, Bedford, UK, Gulf Publishing Co., Houston, TX, D.N. Smith, Editor, pp 97-111, 1989.
7. Sentinel, "Decade After Decade, Losses Occur Due to Combustible Hydraulic Oil," Sentinel, Vol 36, No 3, pp 3-7, May/June 1980.

8. John B. Hoover, Jean L. Bailey and Frederick W. Williams, "Test Plan: Submarine Hydraulic Explosion and Fire Hazards (Version 2.0)," NRL Letter Report 6180/0337, 25 July 2003.
9. MMC Mathews, personal communication, SUBTRAFAC, Norfolk VA, 18 April 2003.
10. MMCS Downham, personal communication, NAVSAFCEN, Norfolk VA, 22 April 2003.
11. F.W. Williams, D. Satterfield and J.L. Scheffey, "Submarine Fire Protection Proposed Test Plan, Phase I — Baseline Mock-up and Outline Test Plan for Ventilation Doctrine," NRL Letter Report 6180/0340, 15 June 1994.
12. F.W. Williams, P.A. Tatem, W.M. Cummings and J.L. Scheffey, "Submarine Firefighting Program Test Plan," NRL Letter Report 6180/0134, 20 June 1995.
13. W.M. Cummings, P.A. Tatem, J.L. Scheffey, and F.W. Williams, "Amendment 1 to Revision 1 of Test Plan; Submarine Ventilation Doctrine — Phase I (Fire Physics and Preliminary Ventilation System Testing)," NRL Letter Report 6180/0042, 28 February 1996.
14. J.L. Scheffey, M.J. Ferreira, F.W. Williams, and P.A. Tatem, "Test Plan for Submarine Ventilation Doctrine Testing — August 96 Test Series," NRL Letter Report 6180/0514, 19 August 1996.
15. Commander, Naval Sea Systems Command, "Qualified Products List of Products Qualified under Military Specification MIL-PRF-17331 Lubricating Oil, Steam Turbine and Gear, Moderate Service," QPL-17331-103, 21 February 2003.
16. Vicky Larimore, personal communication, NSWV/CD-SSES, Philadelphia PA, 2 June 2003.
17. John B. Hoover, unpublished data, June 2003.
18. R. Moore, personal communication, Bete Fog Nozzles, Greenfield, MA, 28 January 2004.
19. Bete Fog Nozzles, Catalog 105.2 USA, undated.
20. J.L. Scheffey, M.J. Ferreira, S.A. Hill, P.A. Tatem and F.W. Williams, "Results of May 1996 Submarine Ventilation Doctrine Testing," NRL Letter Report 6180/0383, 25 July 1996.
21. G. W. Mulholland, "Smoke Production and Properties," Section 1, Chapter 25 in "Handbook of Fire Protection Engineering," 1st Edition, Society of Fire Protection Engineers, National Fire Protection Association, Quincy, MA, J.L. Linville, Editor, p. 1-373, 1988.

22. P.A. Tatem, E.K. Budnick, S.P. Hunt, J. Trelles, J.L. Scheffey, D.A. White, J. Bailey, J. Hoover and F.W. Williams, "Verification and Validation Final Report for Fire and Smoke Spread Modeling and Simulation Support of T-AKE Test and Evaluation," Figure B-8, NRL Memorandum Report NRL/MR/6180--04-8745, 30 January, 2004.

ACKNOWLEDGMENTS

The authors would like to acknowledge the many people who provided critical assistance in the preparation of this report. Thanks especially to the following: Dave Satterfield (NAVSEASYS COM) for arranging access to the Naval Sea Systems Command technical library; MMC Mathews (SUBTRAFAC, Norfolk), MMCS Downham and MMC Houck (NAVSAF CEN) for providing information regarding operating procedures and fire history data for submarines; George Mushrush (NRL), Tim Bowen and Vicky Larimore (NSWC/CD-SSES) for useful discussions regarding the 2190 TEP hydraulic fluid.

This work would not have been possible without the hard work of the men and women assigned to the ex-USS SHADWELL facility. We would especially like to thank Robert Burgess, Vonnie Byrd, Matt Harrison, Carl Krueger, Xuanan Nguyen, Josh Odem, Hung Pham, Russell Robertson, Manton Smith and the many students who prepared the test area, installed the instruments and helped conduct the tests.

Finally, our thanks to the safety officers, Chelbi Cole and John Farley, and to Brad Havlovick and the personnel of Havlovick Engineering Services for their support.

APPENDIX A. INSTRUMENTATION DIAGRAMS

This Appendix includes drawings showing the instrument layouts for the critical compartments discussed in this report. Instrument types are given by the symbols shown in the legend.

CONTENTS

1.0	Instrument Legend.....	A-2
2.0	Instruments in the Combat Systems Space.....	A-3
3.0	Instruments in the Control Room	A-4
4.0	Instruments in the Crew Living Space	A-5
5.0	Instruments in the Laundry Room	A-6
6.0	Instruments in the Torpedo Room	A-7

- Ⓣ Thermocouple Tree, nominal 50 cm intervals from deck
- Ⓥ Video Camera, location approximate
- Ⓡ Infrared Camera, location approximate
- Ⓟ Pressure Transducer, location approximate
- Ⓝ Center Nozzle, 104 cm from deck (Series 1)
52 cm from deck (Series 2)
- Ⓞ Optical Density Meters, 99 and 201 cm from deck
- Ⓞ Gas Sample Point, 99 cm from deck (Torpedo Room)
46 and 239 cm from deck (Control Room)

Figure A-1. Instrument Legend

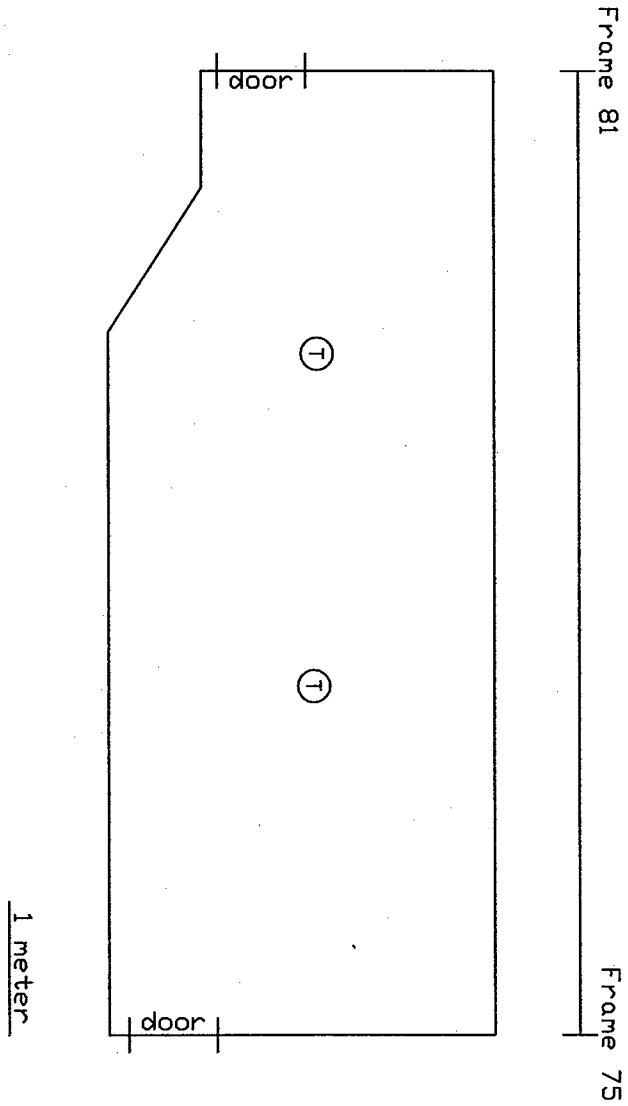

Figure A-2. Instruments in the Combat Systems Space

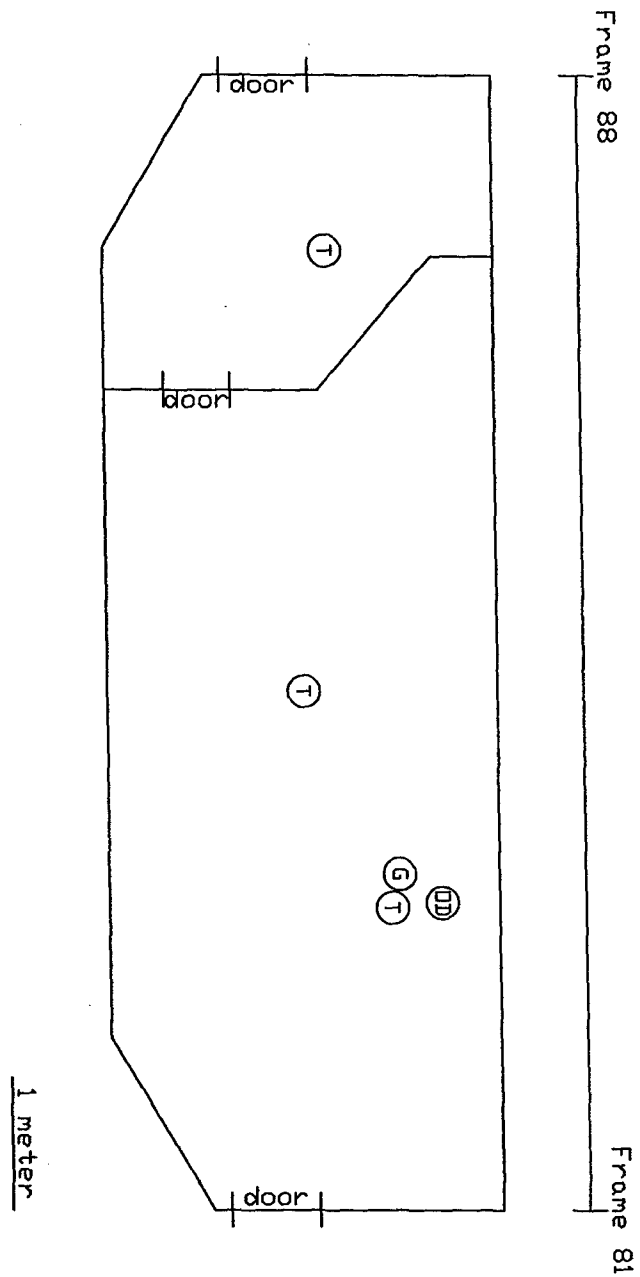

Figure A-3. Instruments in the Control Room

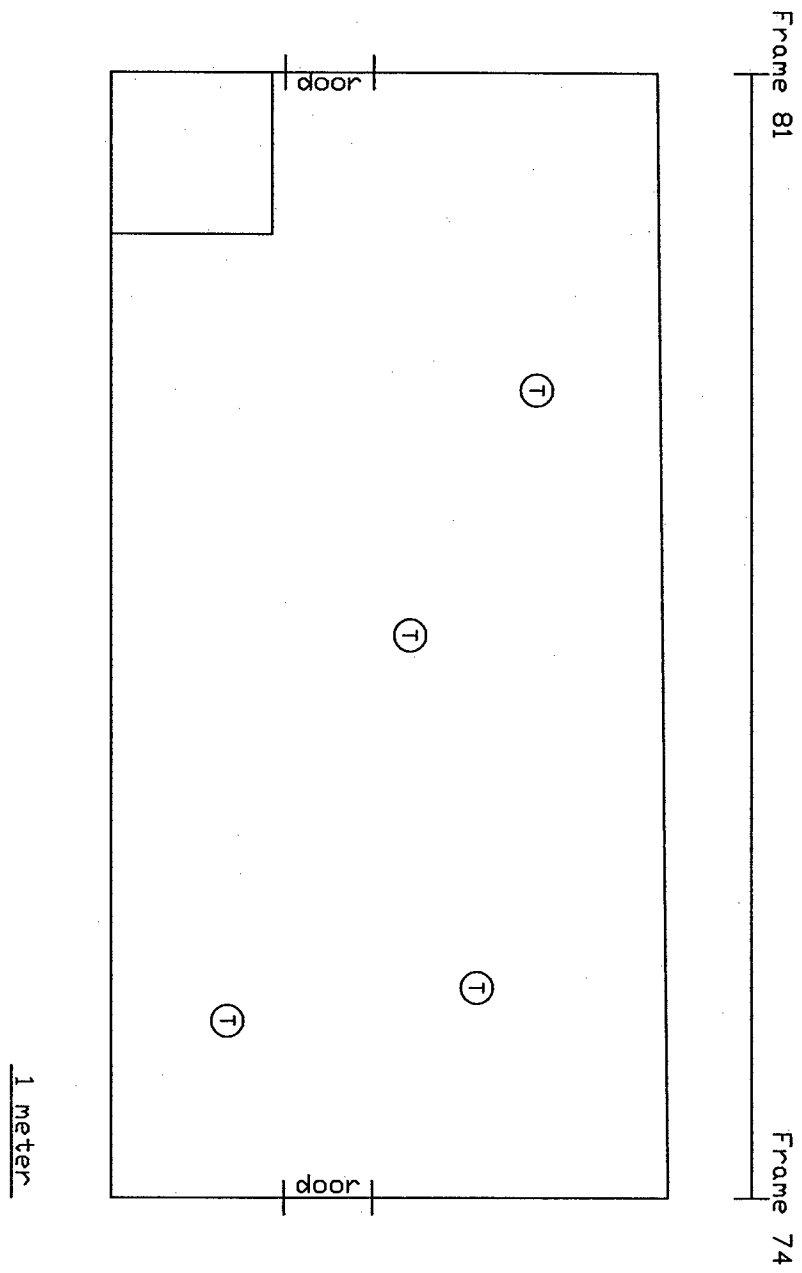

Figure A-4. Instruments in the Crew Living Space

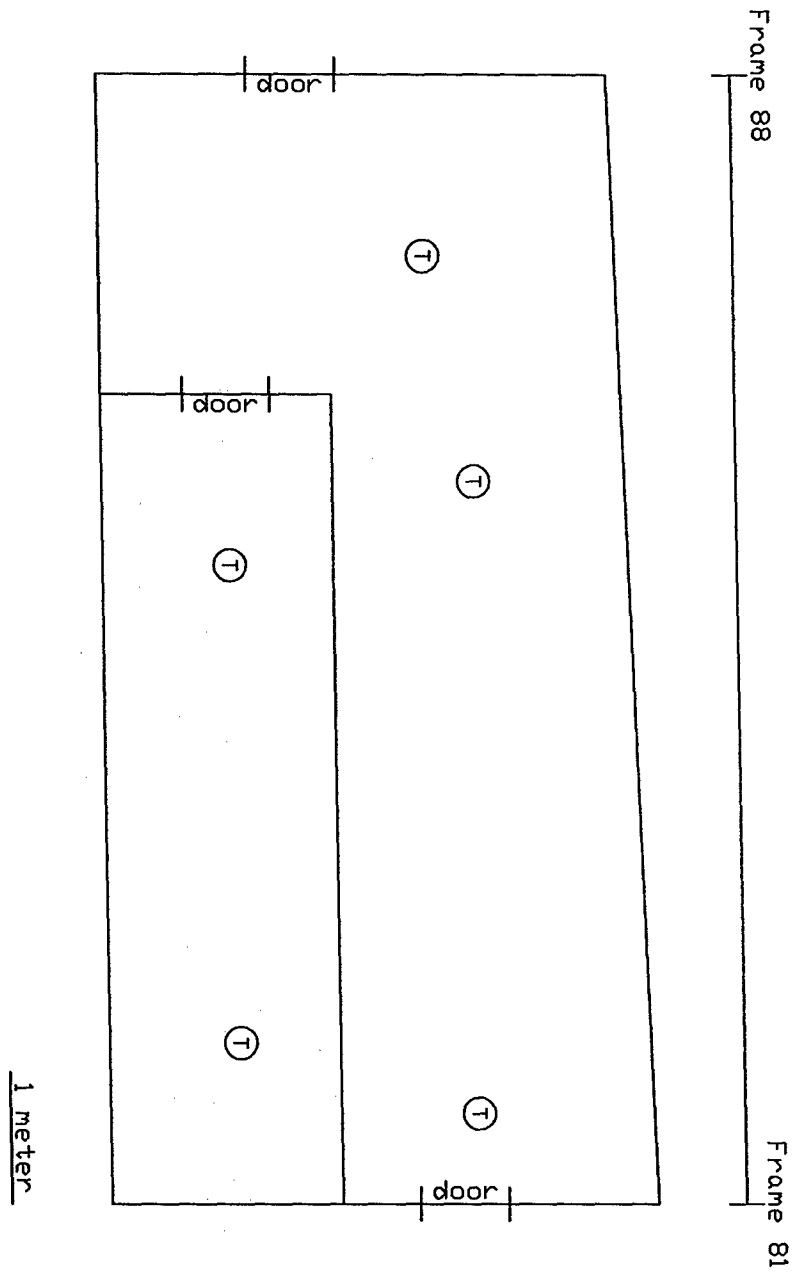

Figure A-5. Instruments in the Laundry Room

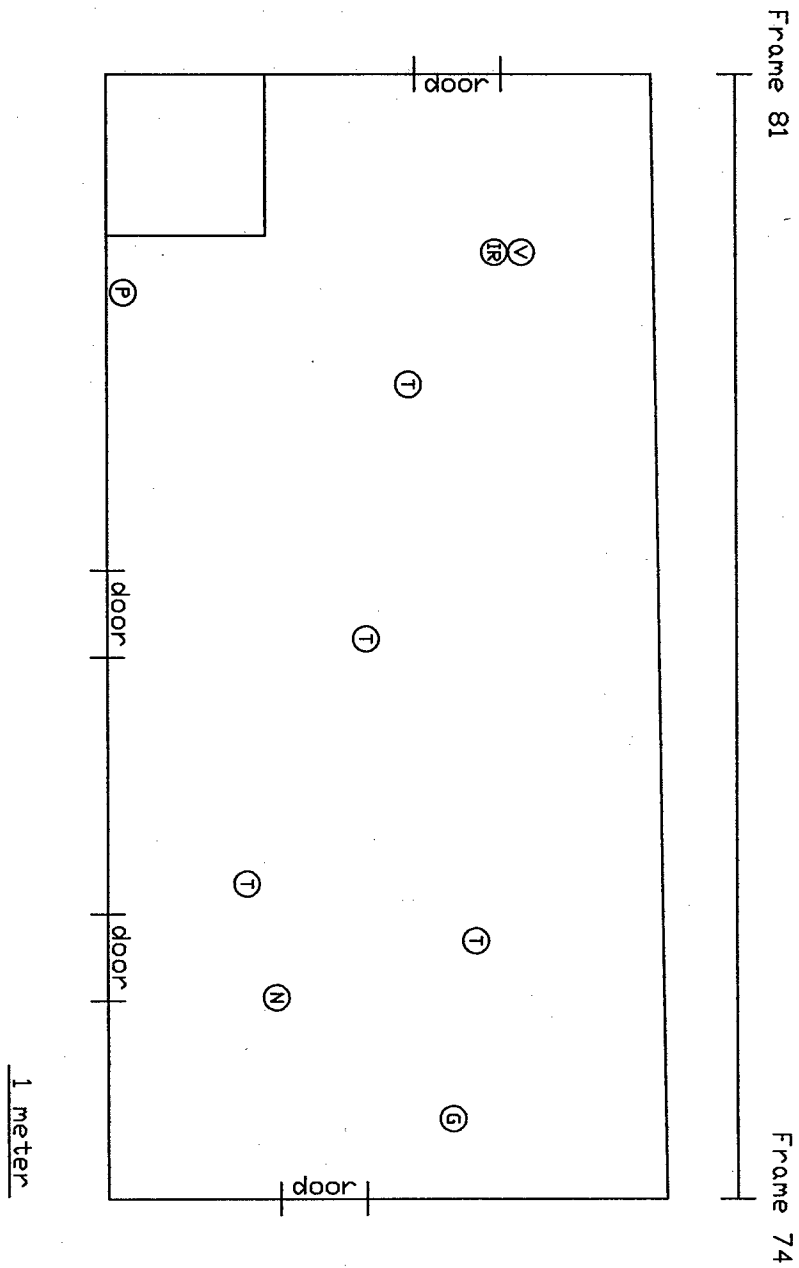

Figure A-6. Instruments in the Torpedo Room

APPENDIX B. TEMPERATURE DATA

This Appendix includes graphs of temperature data for the torpedo room, crew living space, combat systems space, laundry passageway and control room . Plots are provided for one, three and five nozzles for each of the two ventilation cases (ventilation secured at +10 seconds and ventilation not secured).

Data for individual channels were smoothed using a five-point sliding average. For air temperatures, valid data from all thermocouple trees in a given compartment were segregated into upper and lower zones, with an elevation of 1.5 m (4.9 ft) as the demarcation. All channels within a zone were then averaged to produce mean upper and lower temperature estimates for each compartment. For the case of the torpedo room, there were significant differences between the temperatures in the forward half of the compartment (near the fire) and those in the aft portion. Accordingly, we have included all four quadrants in the figures below.

CONTENTS

1.0	Flame Temperatures.....	B-3
2.0	Torpedo Room Air Temperatures.....	B-4
2.1	Upper, Forward Quadrant.....	B-4
2.2	Lower, Forward Quadrant.....	B-5
2.3	Upper, Aft Quadrant	B-6
2.4	Lower, Aft Quadrant	B-7
3.0	Crew Living Space Air Temperatures.....	B-8
3.1	Upper Layer.....	B-8
3.2	Lower Layer.....	B-9

4.0	Combat Systems Space Air Temperatures.....	B-10
4.1	Upper Layer.....	B-10
4.2	Lower Layer.....	B-11
5.0	Laundry Passageway Air Temperatures.....	B-12
5.1	Upper Layer.....	B-12
5.2	Lower Layer.....	B-13
6.0	Control Room Air Temperatures.....	B-14
6.1	Upper Layer.....	B-14
6.2	Lower Layer.....	B-15

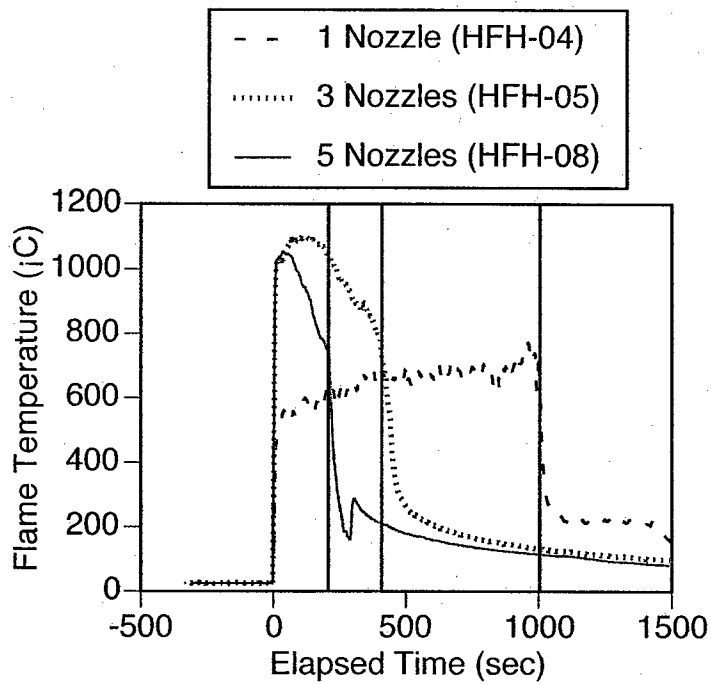
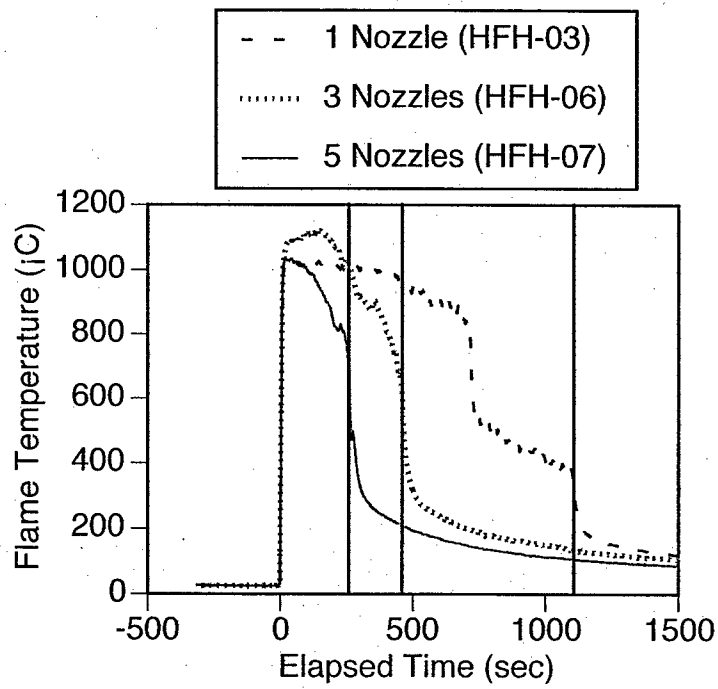

Figure B-1. Flame Temperatures

Flame temperatures for tests with ventilation secured at +10 sec (upper) and not secured (lower). The vertical lines indicate the approximate end of the burn period.

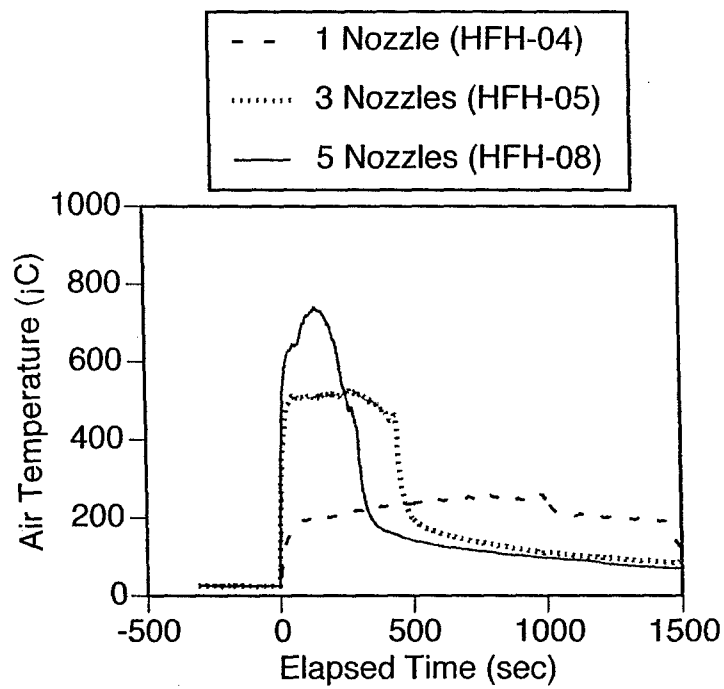
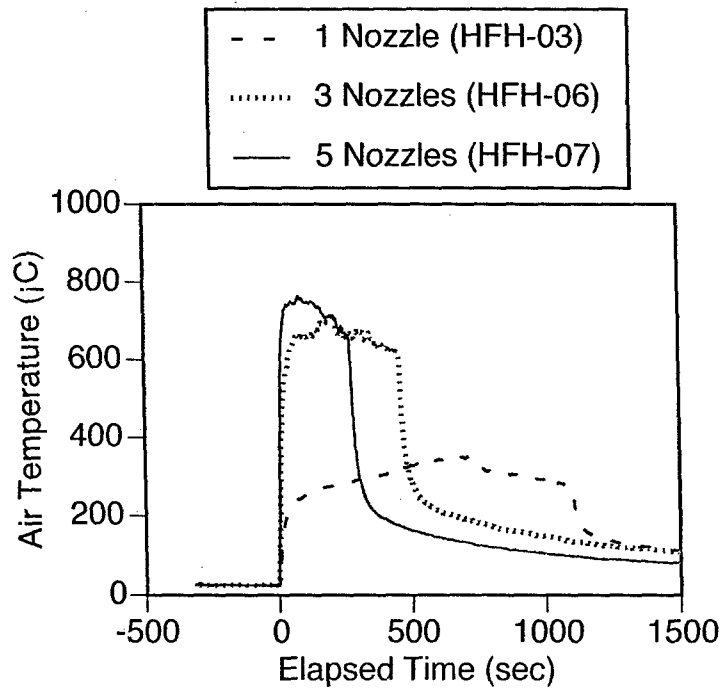

Figure B-2. Torpedo Room Air Temperatures (Upper, Forward)

Air temperatures in the upper, forward quadrant of the torpedo room for tests with ventilation secured at +10 sec (upper) and not secured (lower).

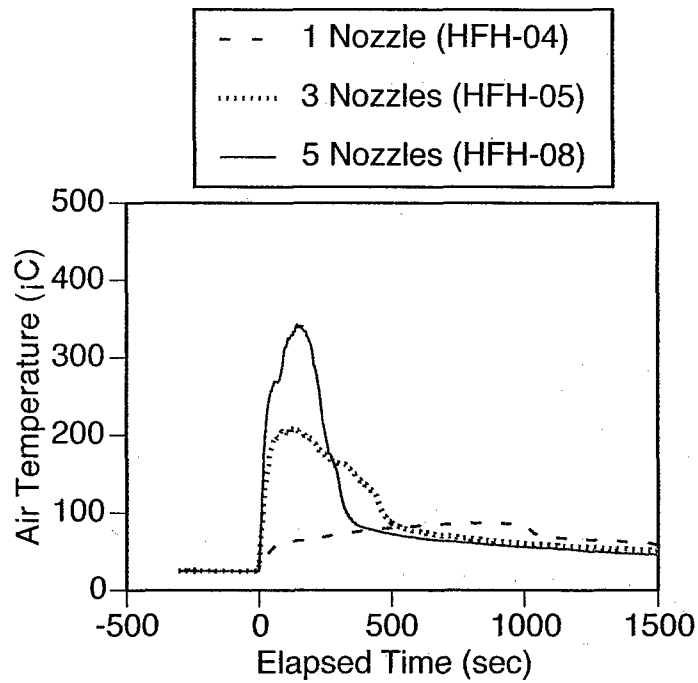
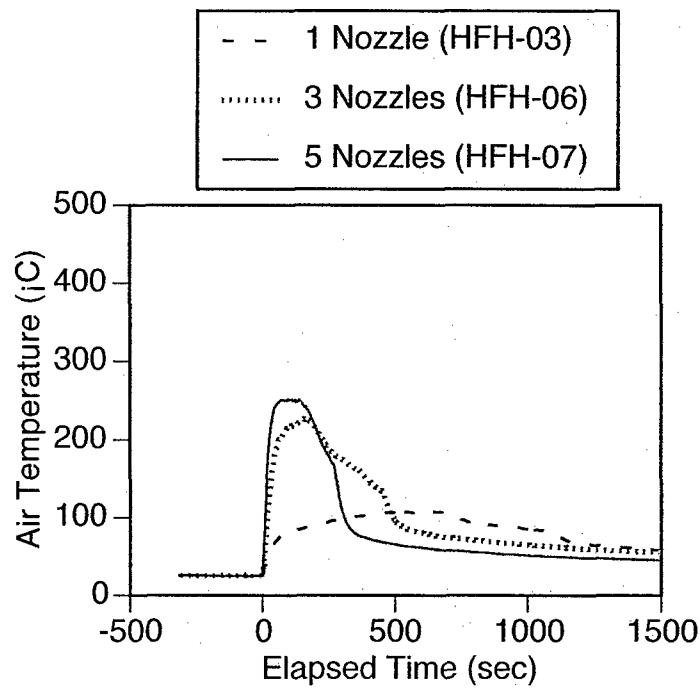

Figure B-3. Torpedo Room Air Temperatures (Lower, Forward)

Air temperatures in the lower, forward quadrant of the torpedo room for tests with ventilation secured at +10 sec (upper) and not secured (lower).

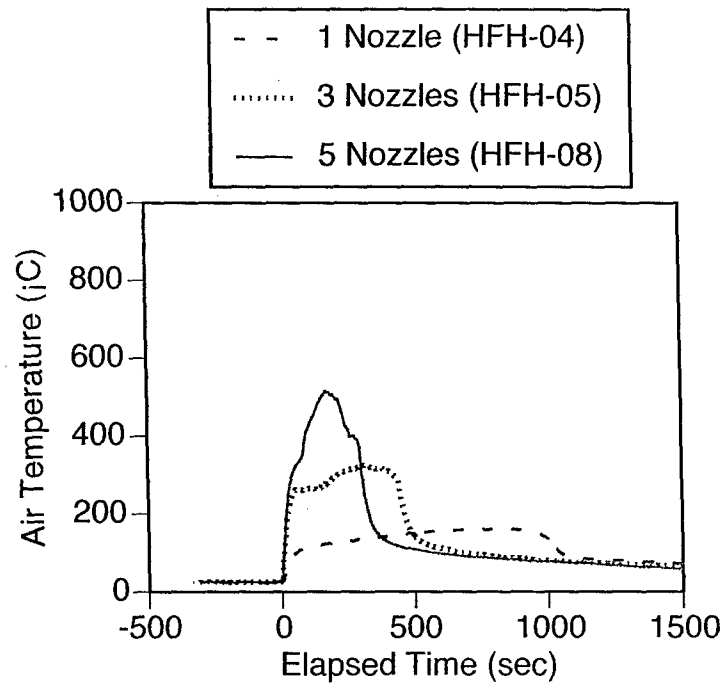
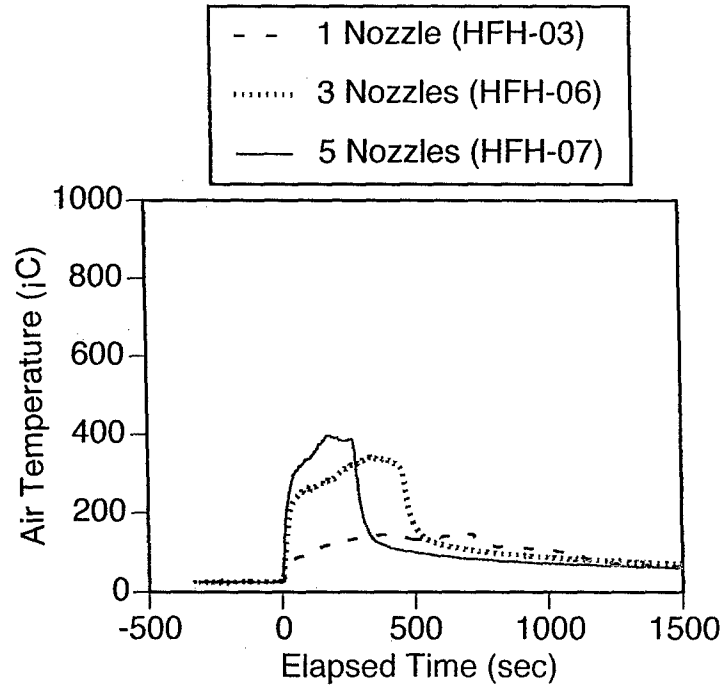

Figure B-4. Torpedo Room Air Temperatures (Upper, Aft)

Air temperatures in the upper, aft quadrant of the torpedo room for tests with ventilation secured at +10 sec (upper) and not secured (lower).

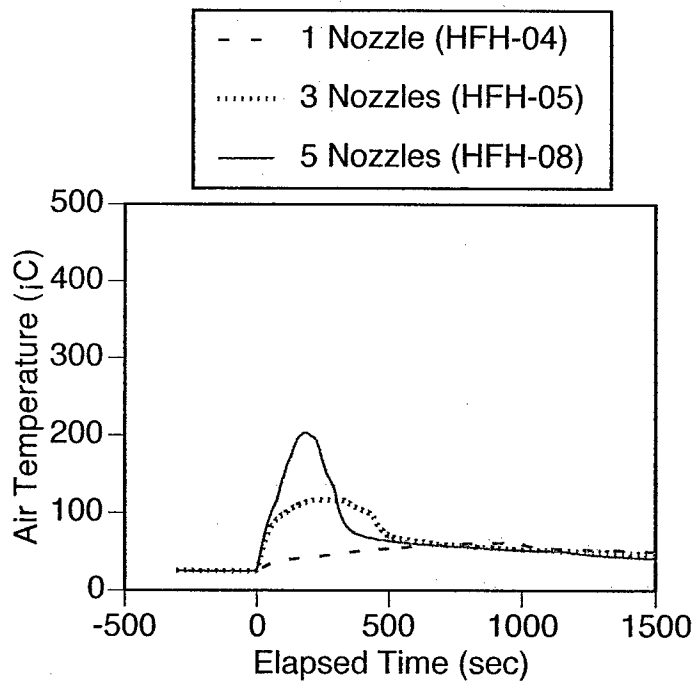
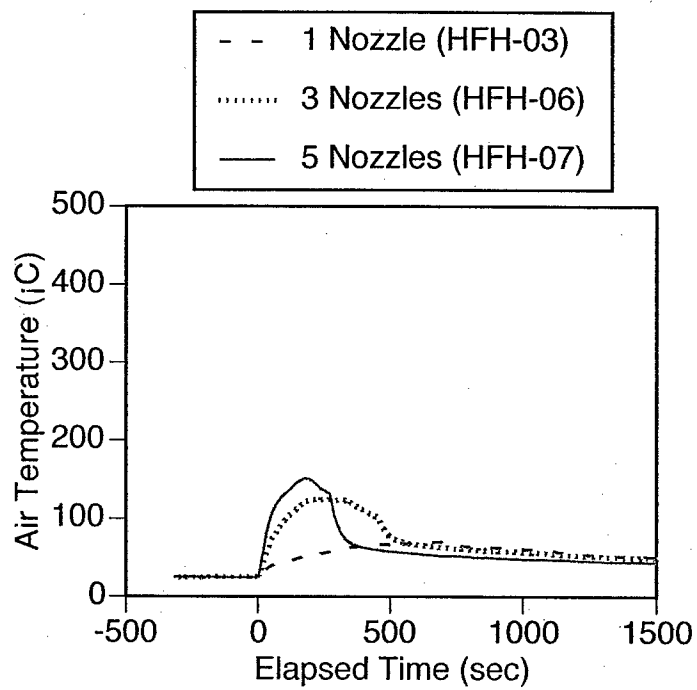

Figure B-5. Torpedo Room Air Temperatures (Lower, Aft)

Air temperatures in the lower, aft quadrant of the torpedo room for tests with ventilation secured at +10 sec (upper) and not secured (lower).

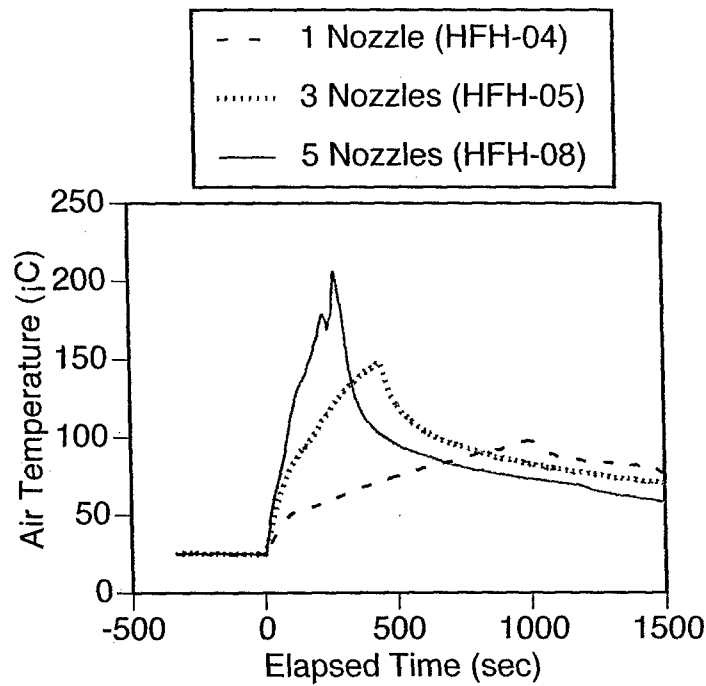
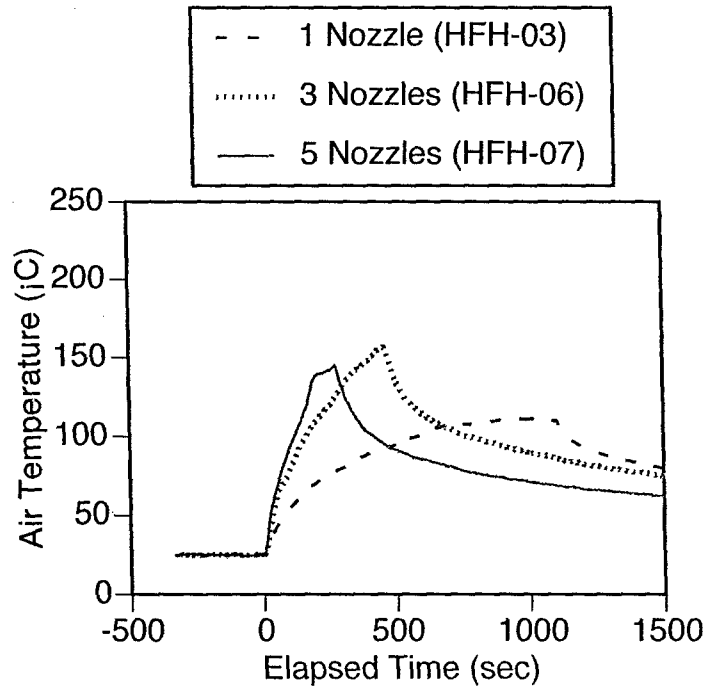

Figure B-6. Crew Living Space Air Temperatures (Upper)

Air temperatures in the upper layer of the crew living space for tests with ventilation secured at +10 sec (upper) and not secured (lower).

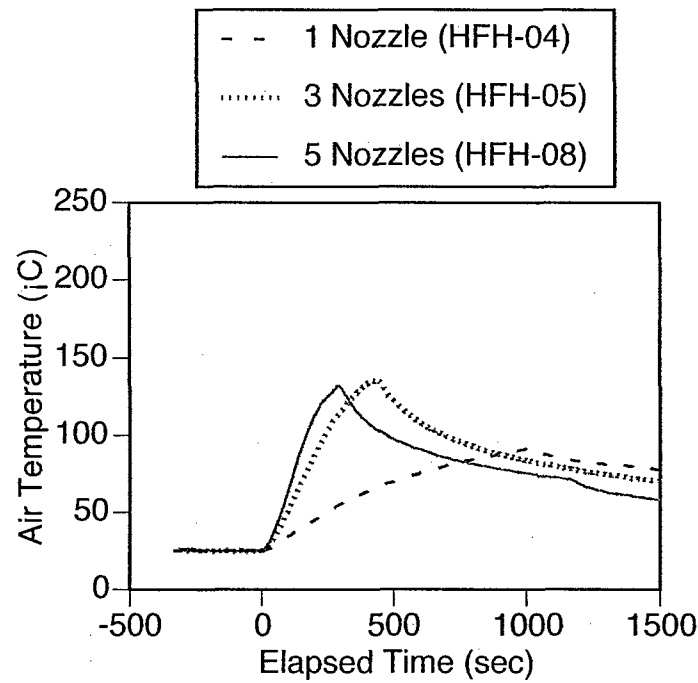
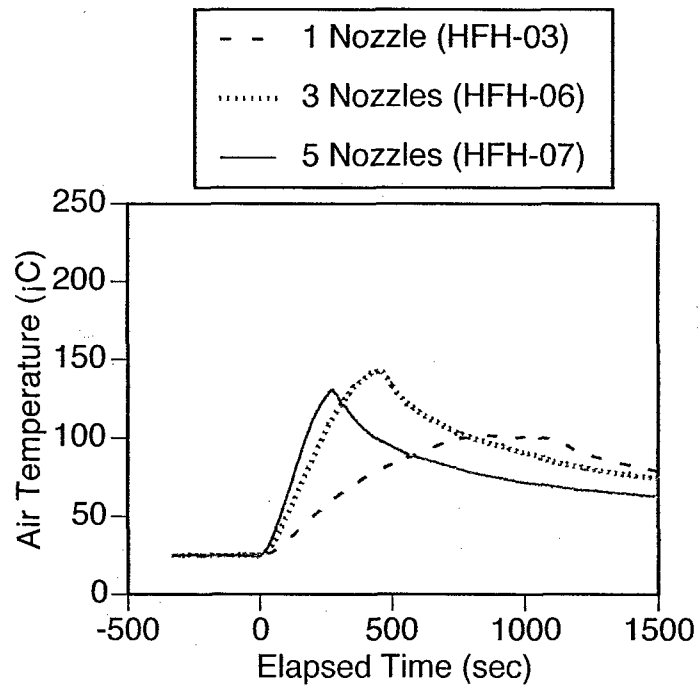

Figure B-7. Crew Living Space Air Temperatures (Lower)

Air temperatures in the lower layer of the crew living space for tests with ventilation secured at +10 sec (upper) and not secured (lower).

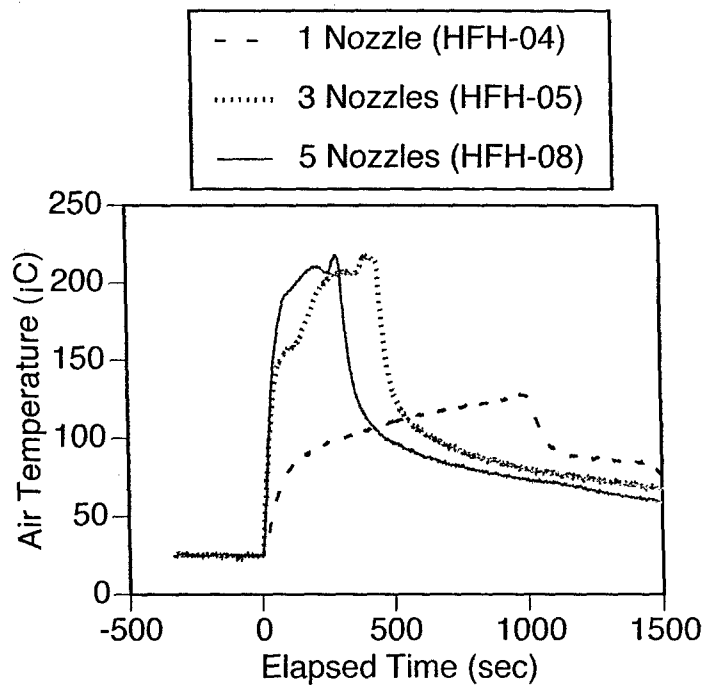
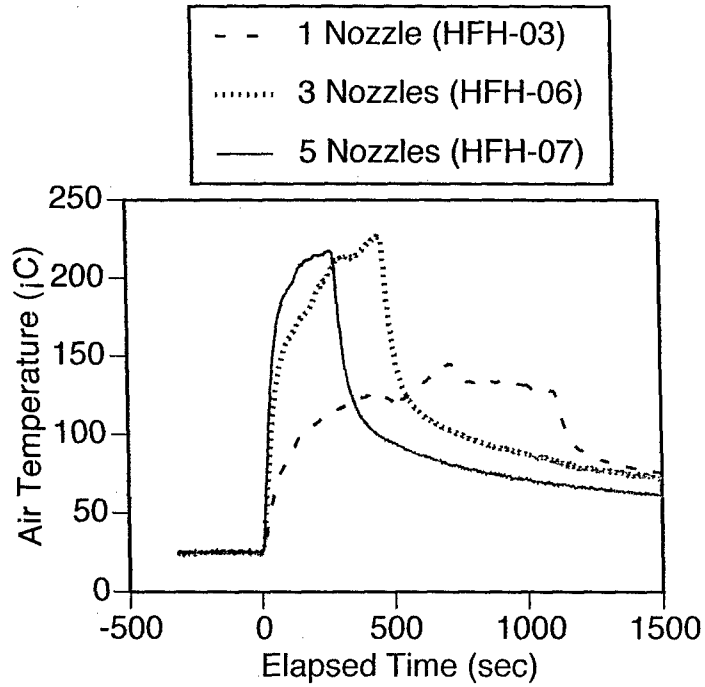

Figure B-8. Combat Systems Space Air Temperatures (Upper)

Air temperatures in the upper layer of the combat systems space for tests with ventilation secured at +10 sec (upper) and not secured (lower).

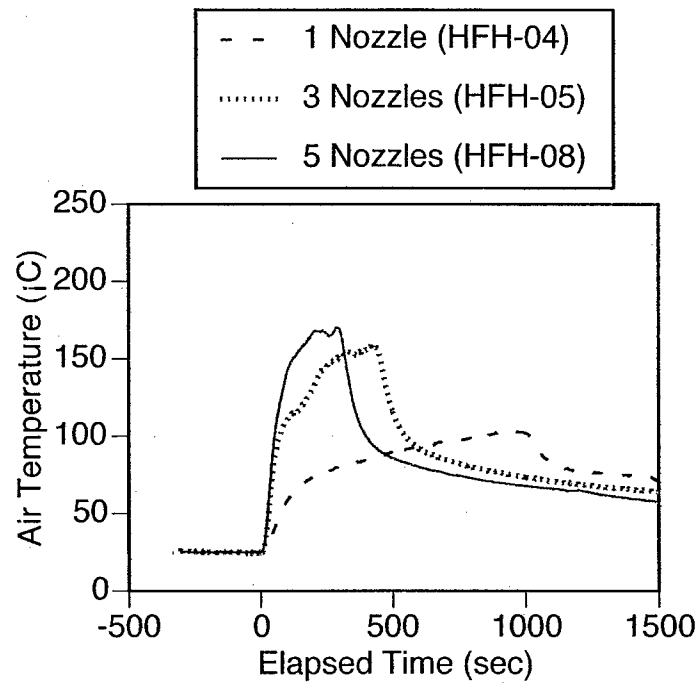
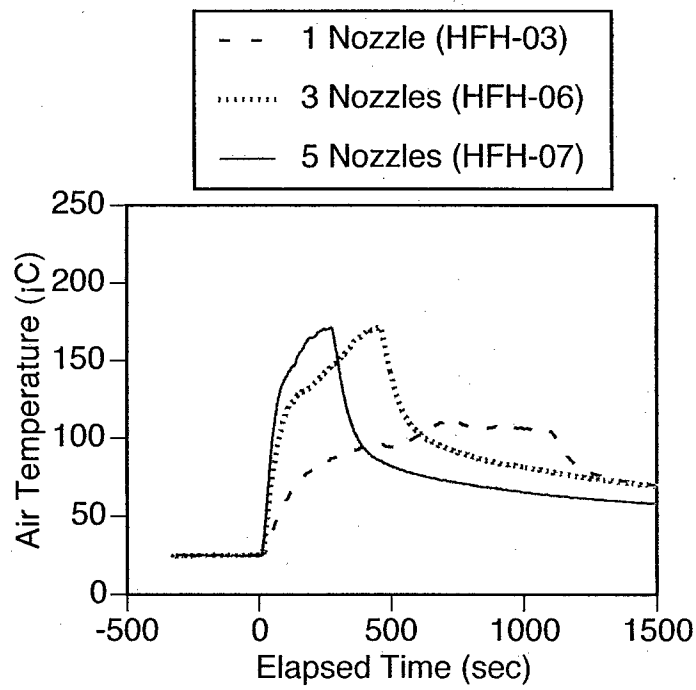

Figure B-9. Combat Systems Space Air Temperatures (Lower)

Air temperatures in the lower layer of the combat systems space for tests with ventilation secured at +10 sec (upper) and not secured (lower).

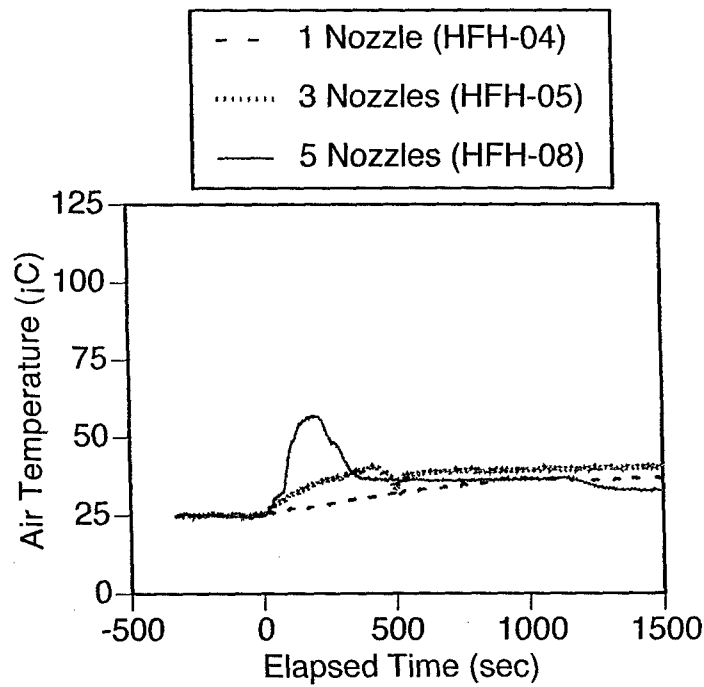
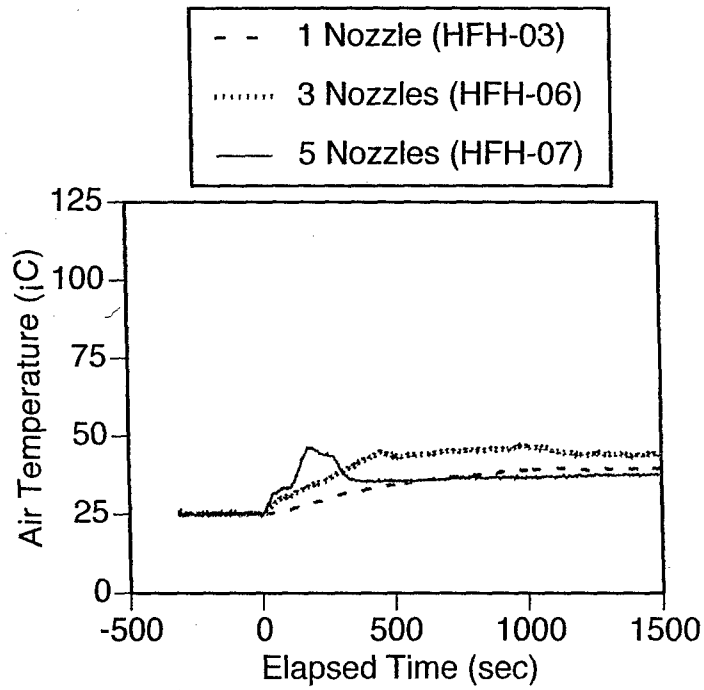

Figure B-10. Laundry Passageway Air Temperatures (Upper)

Air temperatures in the upper layer of the laundry passageway for tests with ventilation secured at +10 sec (upper) and not secured (lower).

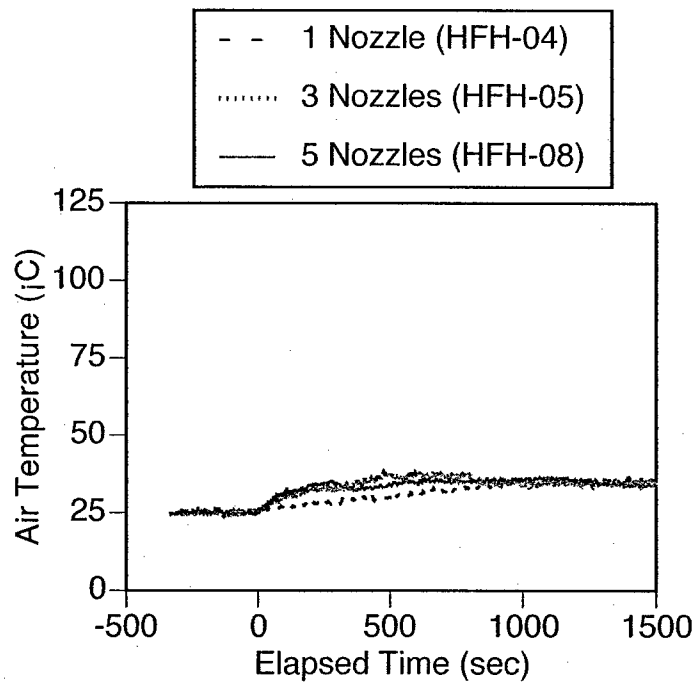
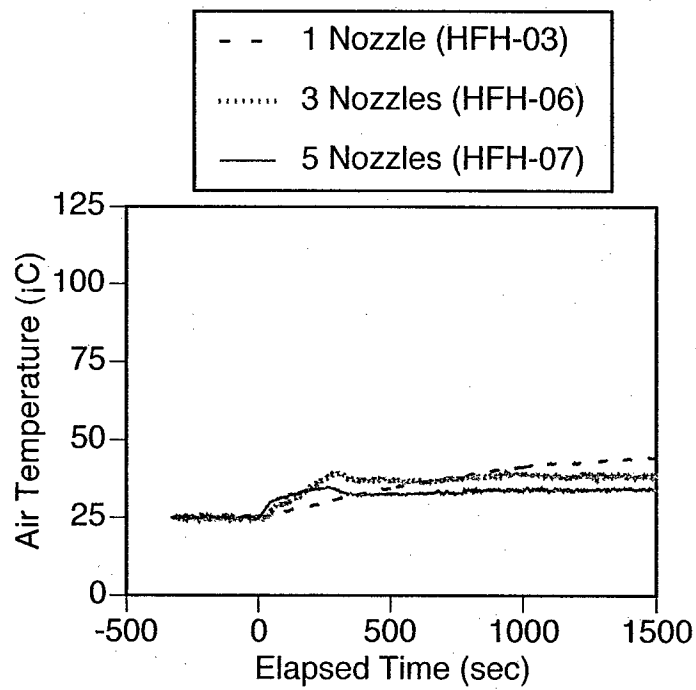

Figure B-11. Laundry Passageway Air Temperatures (Lower)

Air temperatures in the lower layer of the laundry passageway for tests with ventilation secured at +10 sec (upper) and not secured (lower).

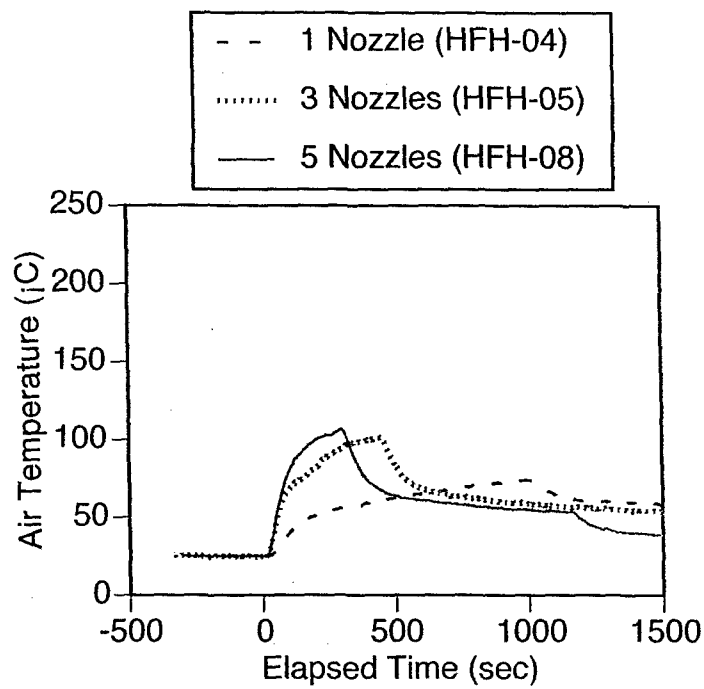
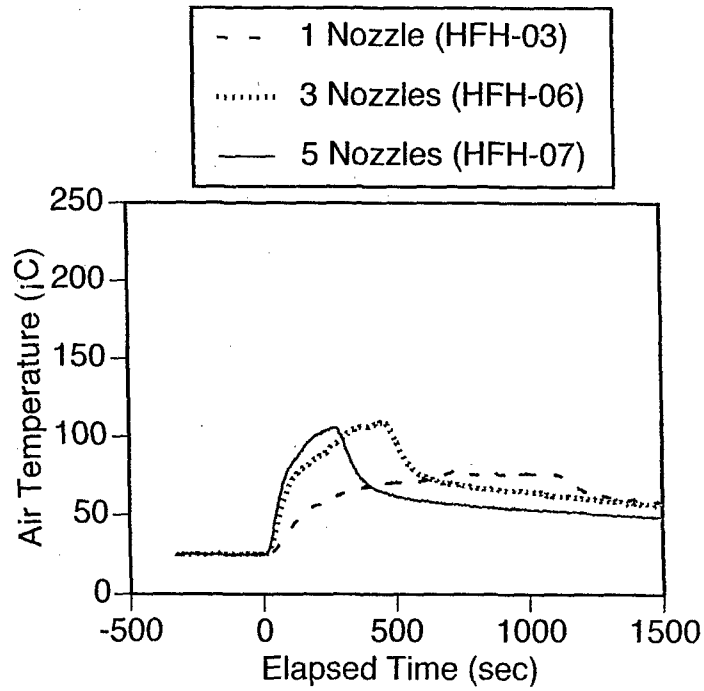

Figure B-12. Control Room Air Temperatures (Upper)

Air temperatures in the upper layer of the control room for tests with ventilation secured at +10 sec (upper) and not secured (lower).

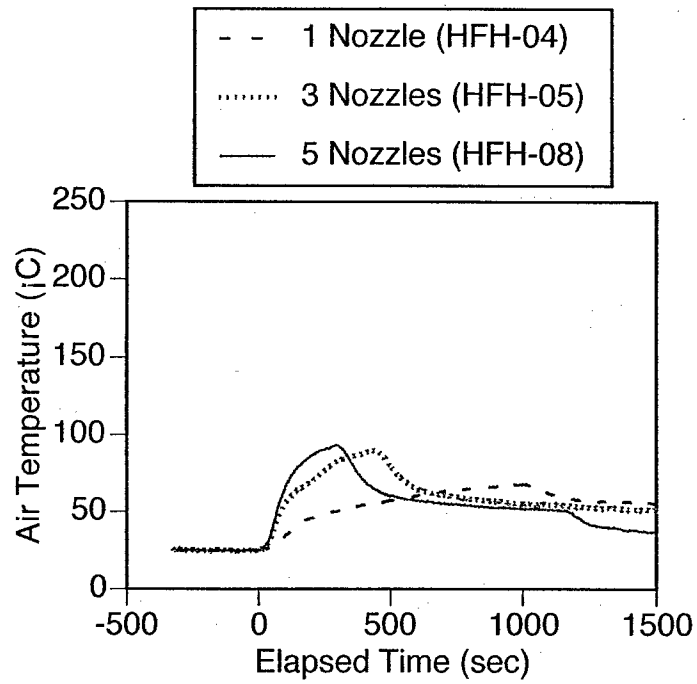
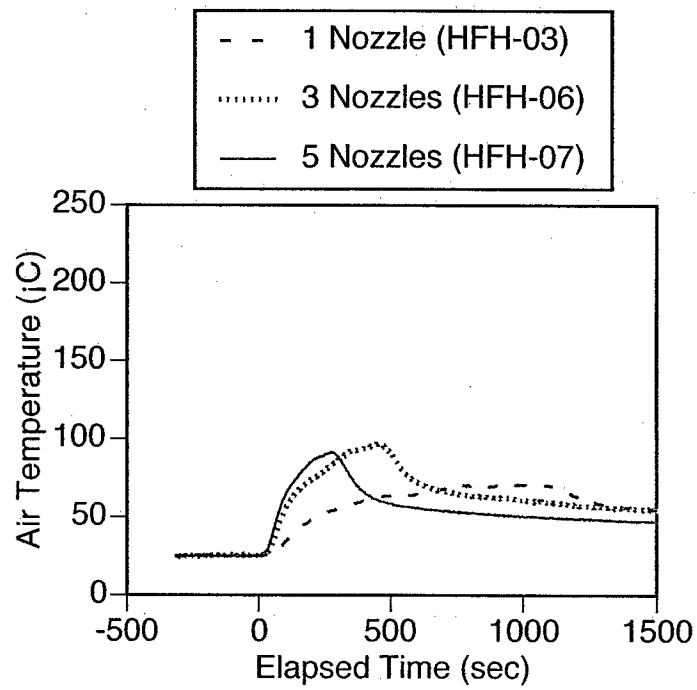

Figure B-13. Control Room Air Temperatures (Lower)

Air temperatures in the lower layer of the control room for tests with ventilation secured at +10 sec (upper) and not secured (lower).

APPENDIX C. ATMOSPHERE DATA

This Appendix includes graphs of atmosphere composition data (oxygen, carbon dioxide and carbon monoxide) for the torpedo room and control room. visibility data are also presented for the control room. Plots are provided for one, three and five nozzles for each of the two ventilation cases (ventilation secured at +10 seconds and ventilation not secured).

Data for individual channels were smoothed using a five-point sliding average and, for the control room, upper [2.4 m (8 ft)] and lower [0.5 m (1.6 ft)] level gas analysis results were averaged. The torpedo room had a single gas sampling point located at an elevation of 1 m (3.3 ft). The control room optical data are the average of values from instruments at 2.0 m (6.5 ft) and 1.0 m (3.3 ft).

CONTENTS

1.0	Torpedo Room Atmosphere.....	C-2
1.1	Oxygen.....	C-2
1.2	Carbon Dioxide.....	C-3
1.3	Carbon Monoxide.....	C-4
2.0	Control Room Atmosphere.....	C-5
2.1	Oxygen.....	C-5
2.2	Carbon Dioxide.....	C-6
2.3	Carbon Monoxide.....	C-7
2.4	Visibility.....	C-8

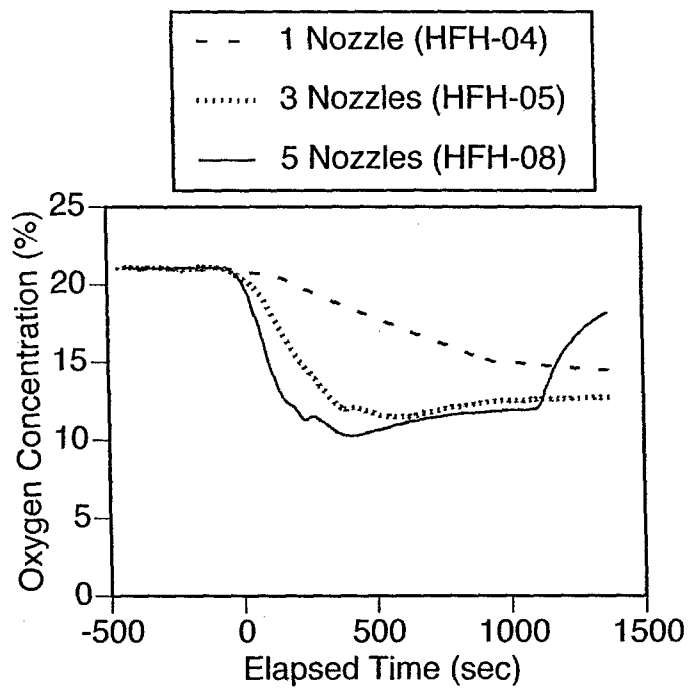
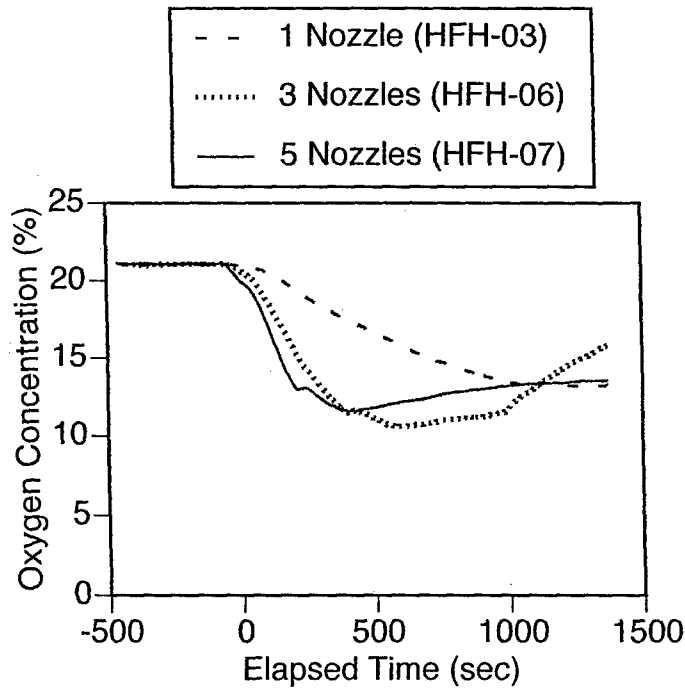

Figure C-1. Torpedo Room Oxygen

Oxygen concentrations in the torpedo room for tests with ventilation secured at +10 sec (upper) and not secured (lower).

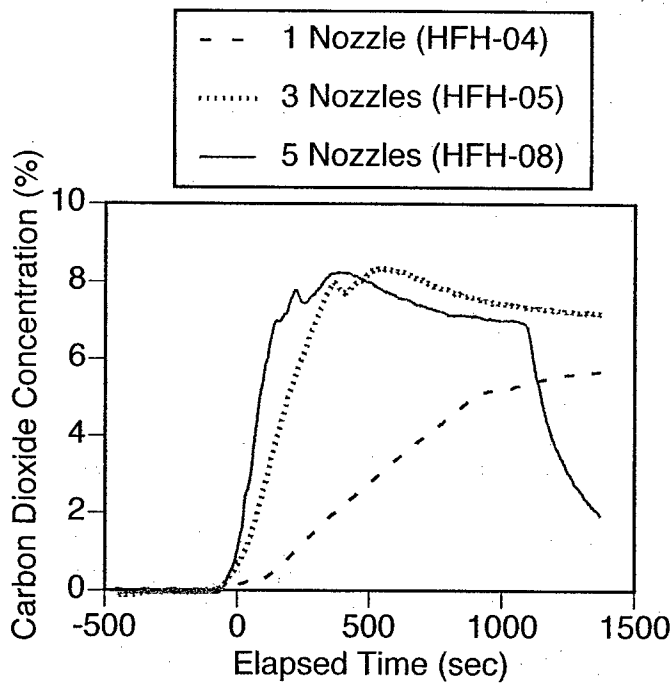
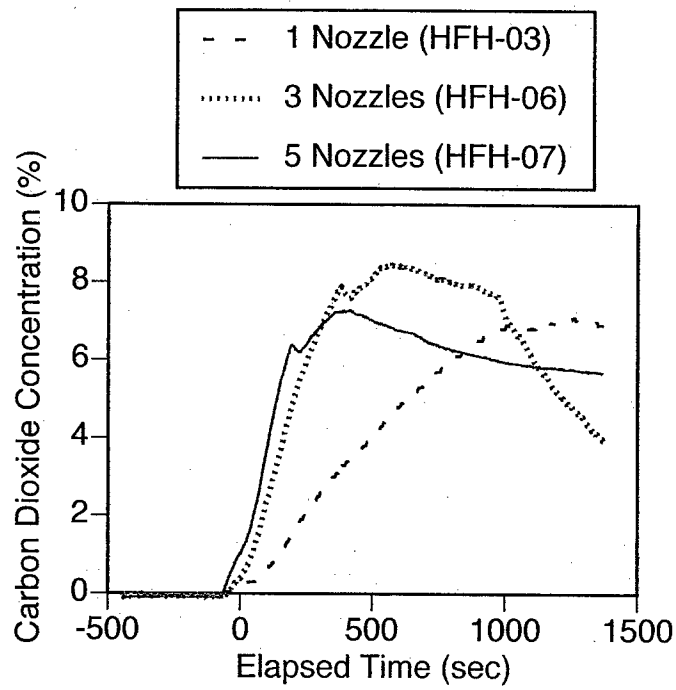

Figure C-2. Torpedo Room Carbon Dioxide

Carbon dioxide concentrations in the torpedo room for tests with ventilation secured at +10 sec (upper) and not secured (lower).

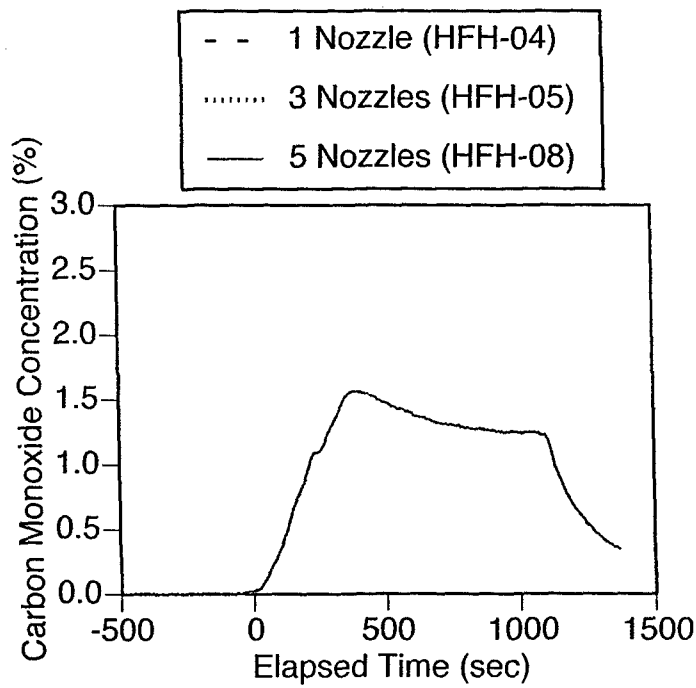
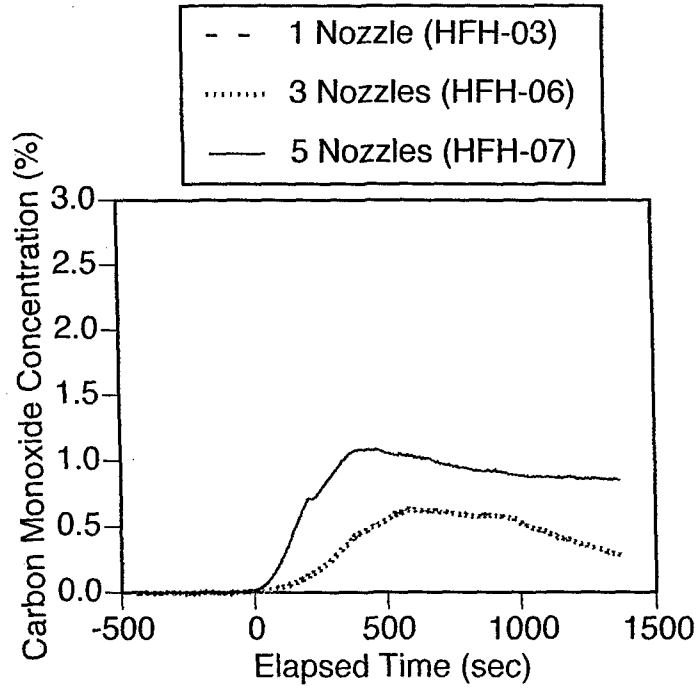

Figure C-3. Torpedo Room Carbon Monoxide

Carbon monoxide concentrations in the torpedo room for tests with ventilation secured at +10 sec (upper) and not secured (lower). Data for some tests are missing due to instrumentation failures.

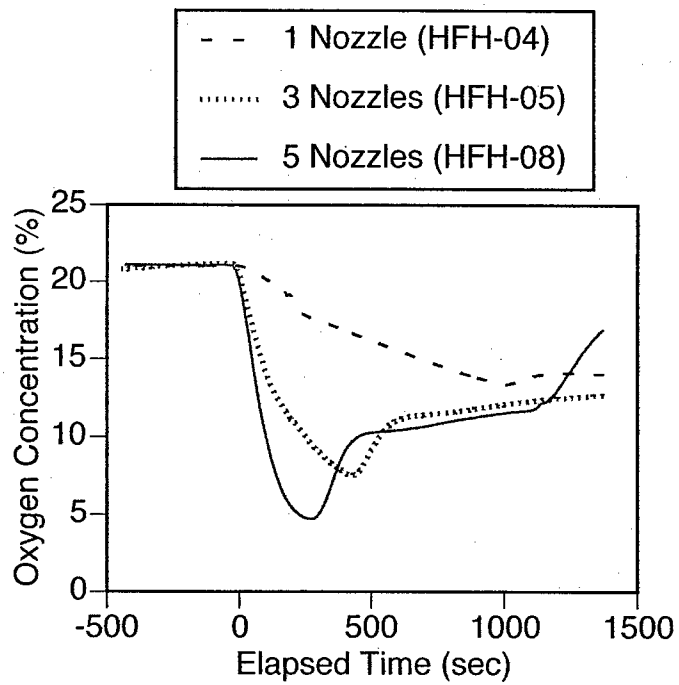
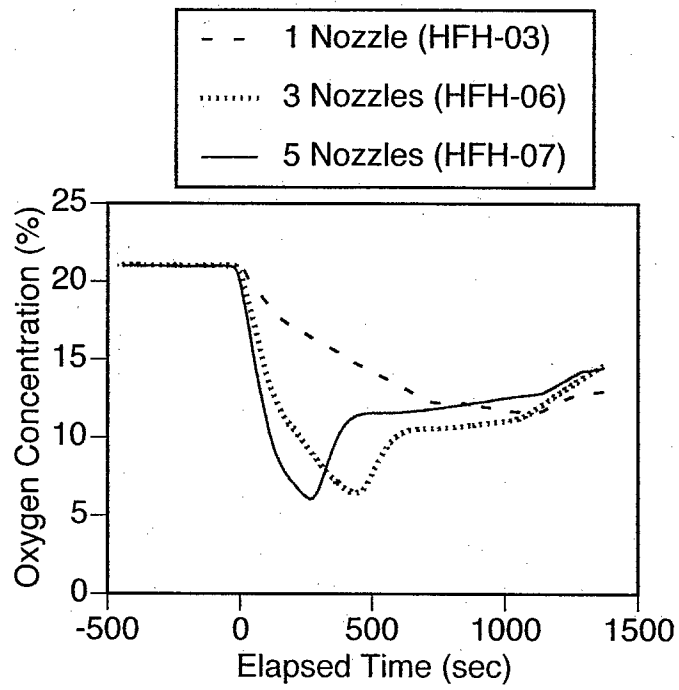

Figure C-4. Control Room Oxygen

Oxygen concentrations in the control room for tests with ventilation secured at +10 sec (upper) and not secured (lower).

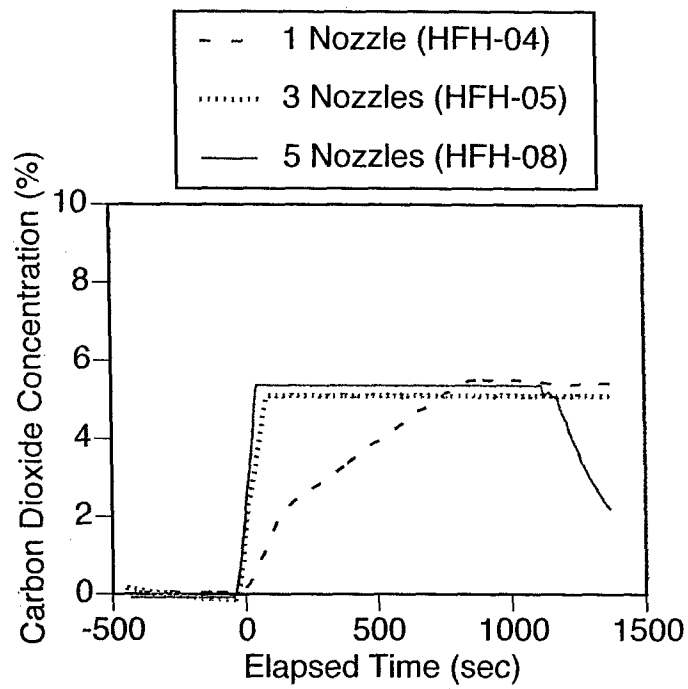
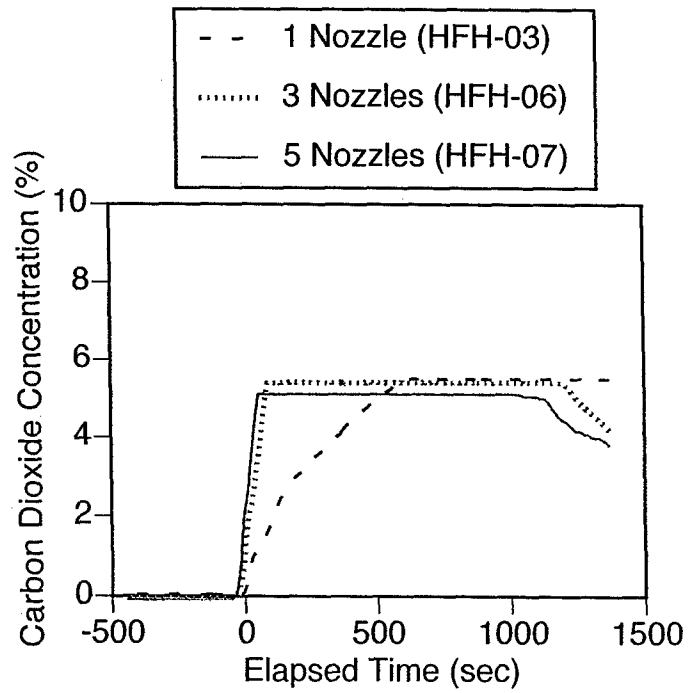

Figure C-5. Control Room Carbon Dioxide

Carbon dioxide concentrations in the control room for tests with ventilation secured at +10 sec (upper) and not secured (lower). The instrument saturated at slightly greater than 5%.

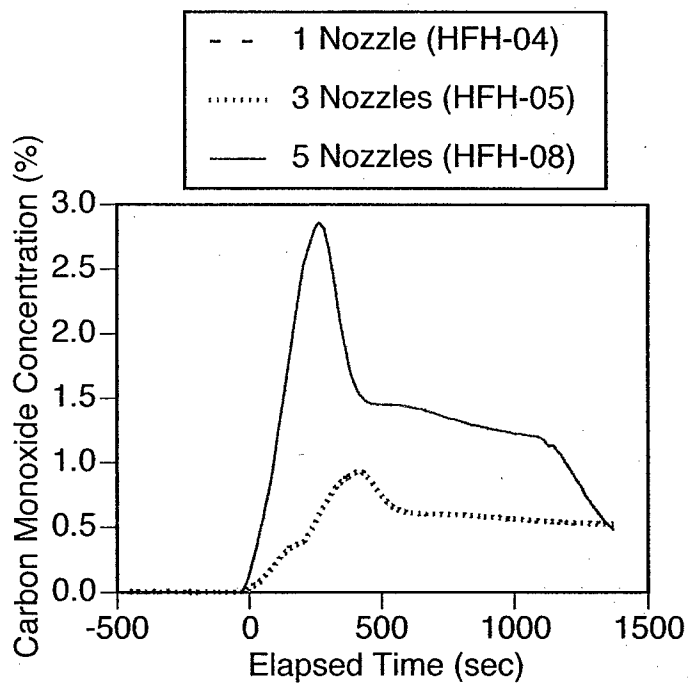
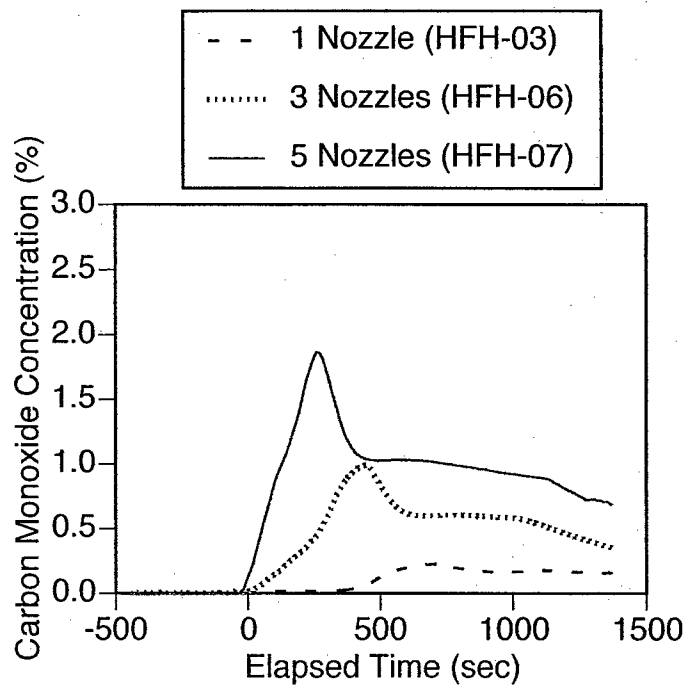

Figure C-6. Control Room Carbon Monoxide

Carbon monoxide concentrations in the control room for tests with ventilation secured at +10 sec (upper) and not secured (lower). Data for test HFH-04 are missing due to an instrumentation failure.

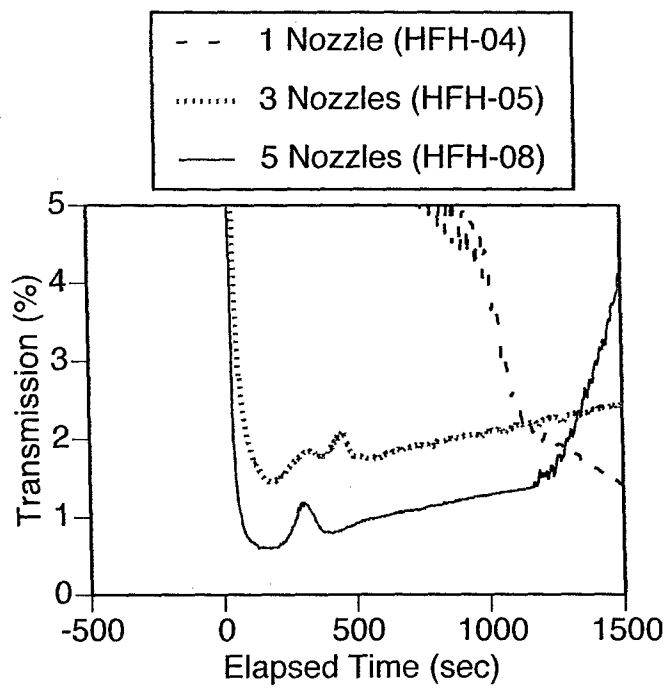
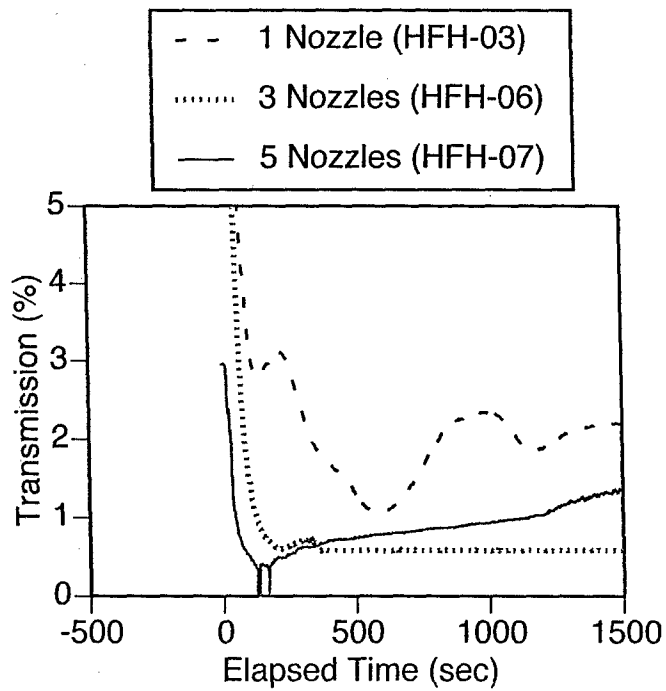

Figure C-3. Control Room Visibility

Visibility concentrations in the control room for tests with ventilation secured at +10 sec (upper) and not secured (lower)

APPENDIX D. OVER-PRESSURE TRANSIENTS

This Appendix includes graphs of the pressure transients caused by hydraulic fluid explosions for all of the explosion hazard (Series 2) tests.

For all pressure transient data, the time track was shifted so that time zero corresponded to the ignition time and the times were converted from milliseconds to seconds. A five-point sliding average function was applied to the data to reduced the noise and the baseline transducer output (*i.e.*, the average of all pre-ignition values) was subtracted to correct for instrument drift. Raw voltages were then converted to pressures using the measured response curve for the transducer.

CONTENTS

1.0	One-Nozzle Tests.....	D-3
1.1	Test HXH-02.....	D-3
1.2	Test HXH-03.....	D-3
2.0	Two-Nozzle Tests.....	D-4
2.1	Test HXH-04.....	D-4
2.2	Test HXH-06.....	D-4
2.3	Test HXH-19.....	D-5
3.0	Three-Nozzle Tests.....	D-6
3.1	Test HXH-07.....	D-6
3.2	Test HXH-08.....	D-6

3.3	Test HXH-11.....	D-7
3.4	Test HXH-12.....	D-7
3.5	Test HXH-13.....	D-8
4.0	Four-Nozzle Tests	D-9
4.1	Test HXH-14.....	D-9
4.2	Test HXH-15.....	D-9
4.3	Test HXH-21.....	D-10
5.0	Five-Nozzle Tests.....	D-11
5.1	Test HXH-16.....	D-11
5.2	Test HXH-17.....	D-11
5.3	Test HXH-18.....	D-12
5.4	Test HXH-22.....	D-12

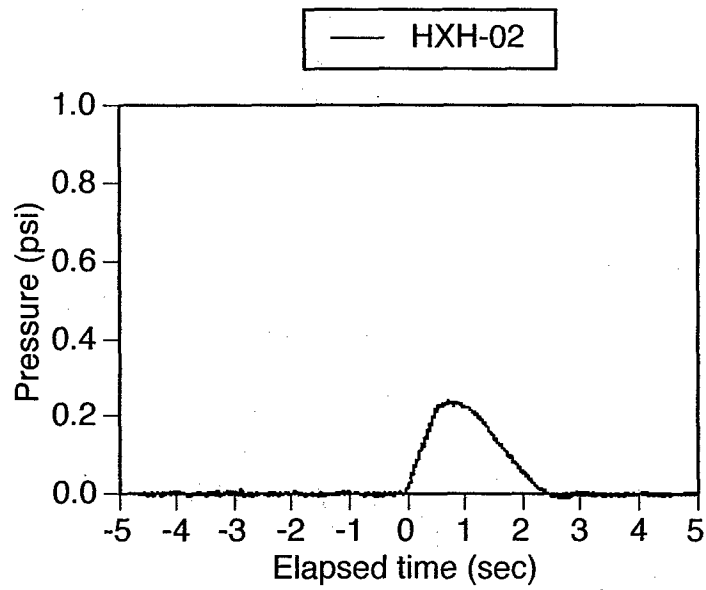

Figure D-1. Pressure Transient for Experiment HXH-02

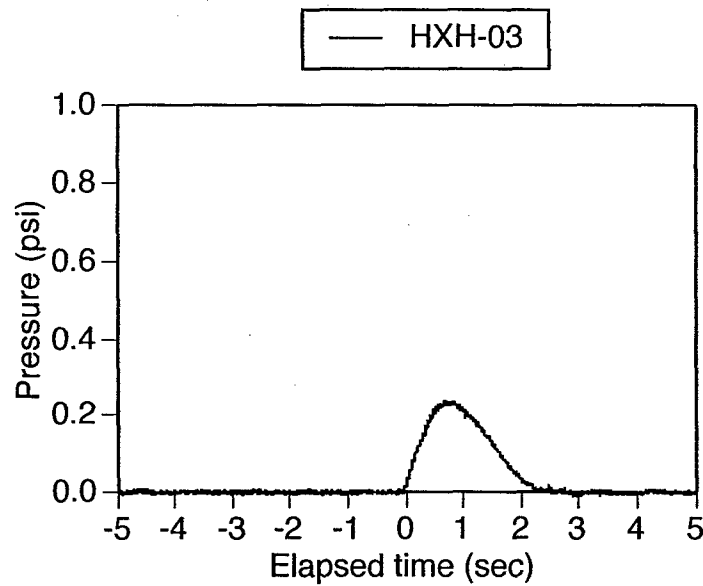

Figure D-2. Pressure Transient for Experiment HXH-03

Over-pressure curves for 15 second flows through a single nozzle [total fuel quantity approximately 0.59 liters (0.16 gal)].

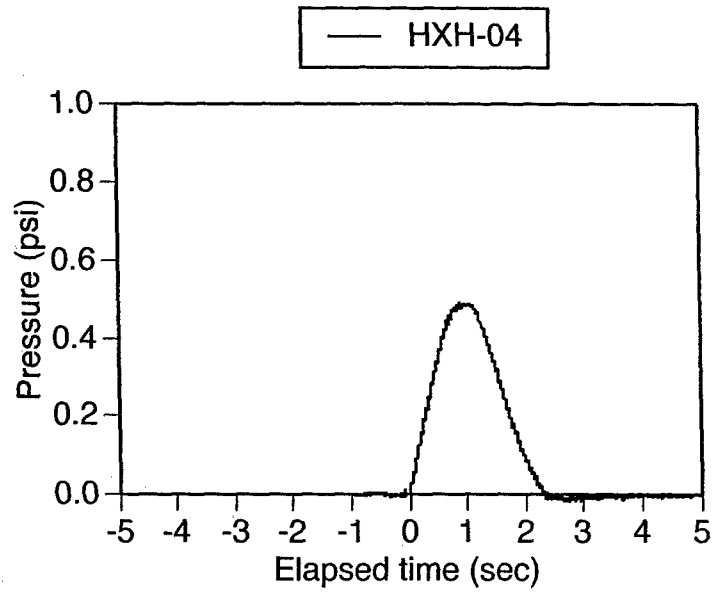

Figure D-3. Pressure Transient for Experiment HXH-04

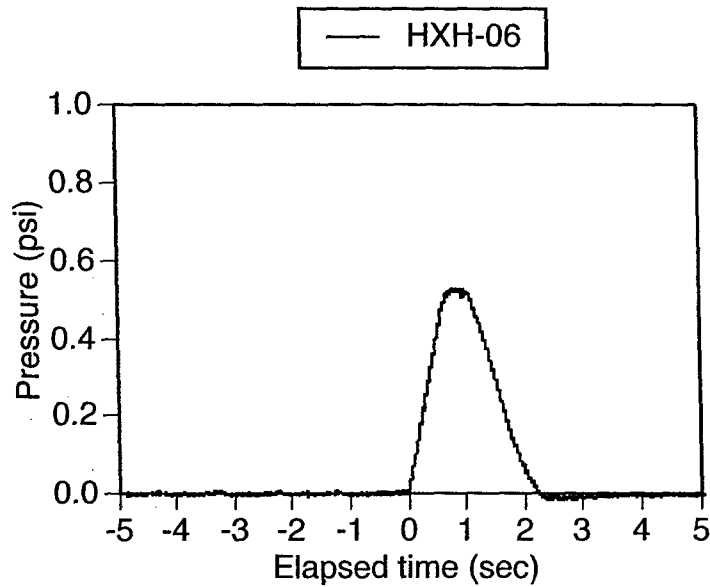

Figure D-4. Pressure Transient for Experiment HXH-06

Over-pressure curves for 15 second flows through two nozzles [total fuel quantity approximately 1.16 liters (0.31 gal)].

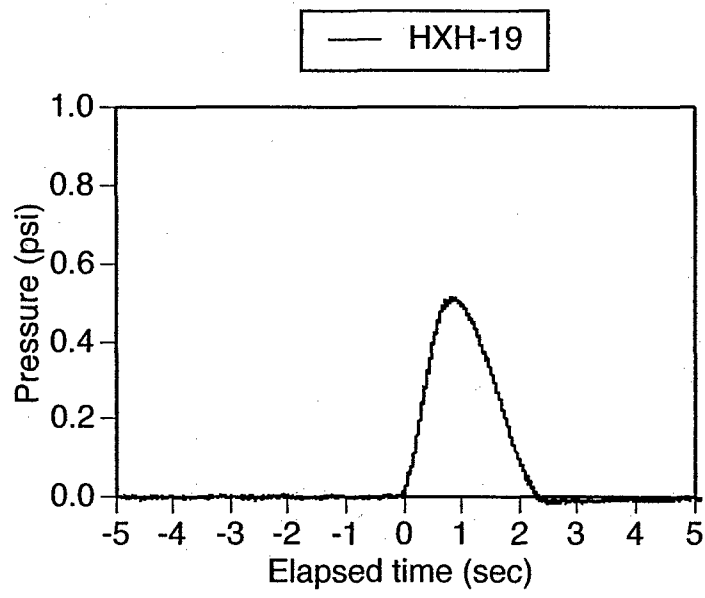

Figure D-5. Pressure Transient for Experiment HXH-19

Over-pressure curves for 15 second flows through two nozzles [total fuel quantity approximately 1.16 liters (0.31 gal)] (Continued).

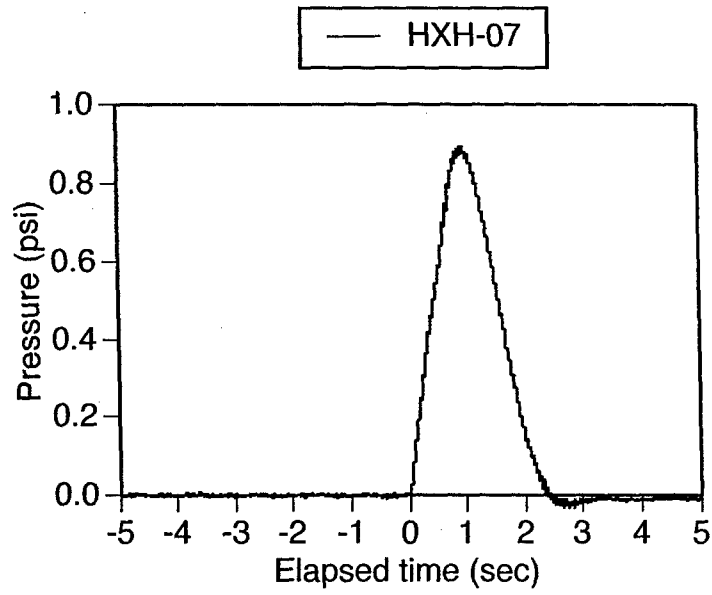

Figure D-6. Pressure Transient for Experiment HXH-07

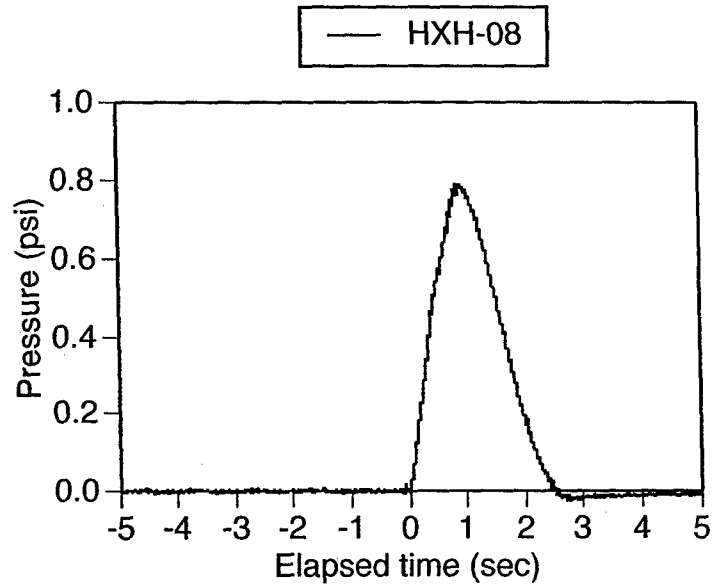

Figure D-7. Pressure Transient for Experiment HXH-08

Over-pressure curves for 15 second flows through three nozzles [total fuel quantity approximately 1.72 liters (0.45 gal)].

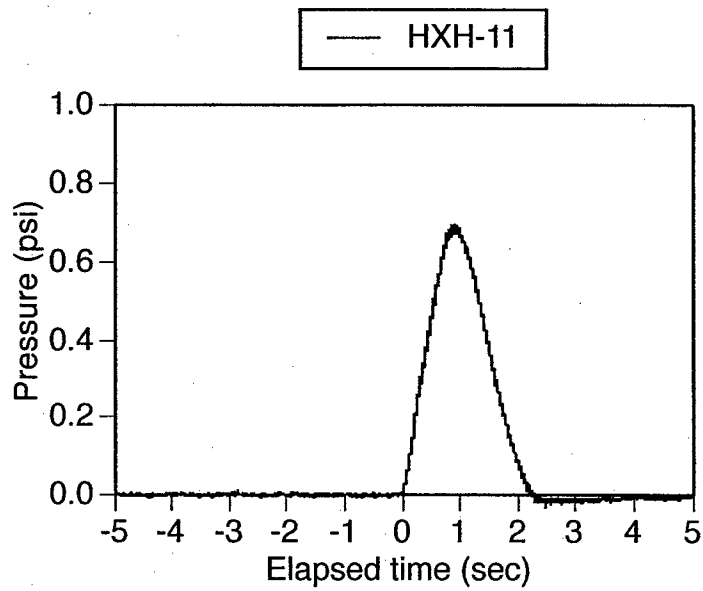

Figure D-8. Pressure Transient for Experiment HXH-11

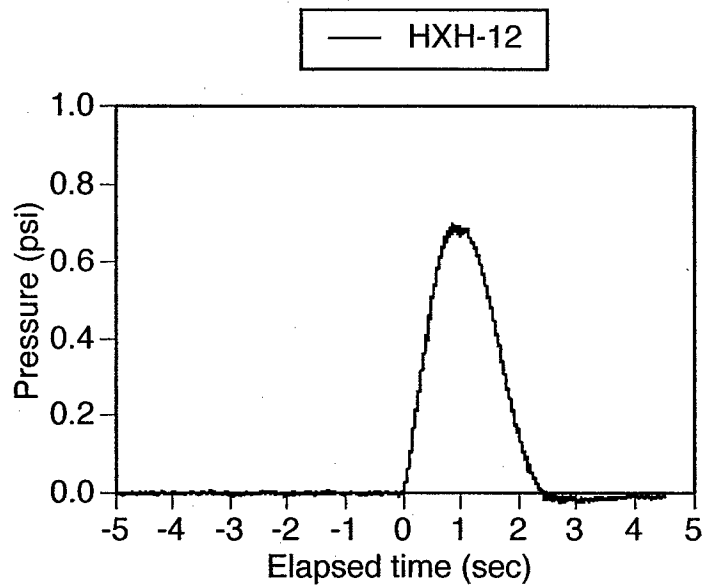

Figure D-9. Pressure Transient for Experiment HXH-12

Over-pressure curves for 15 second flows through three nozzles [total fuel quantity approximately 1.72 liters (0.45 gal)] (Continued).

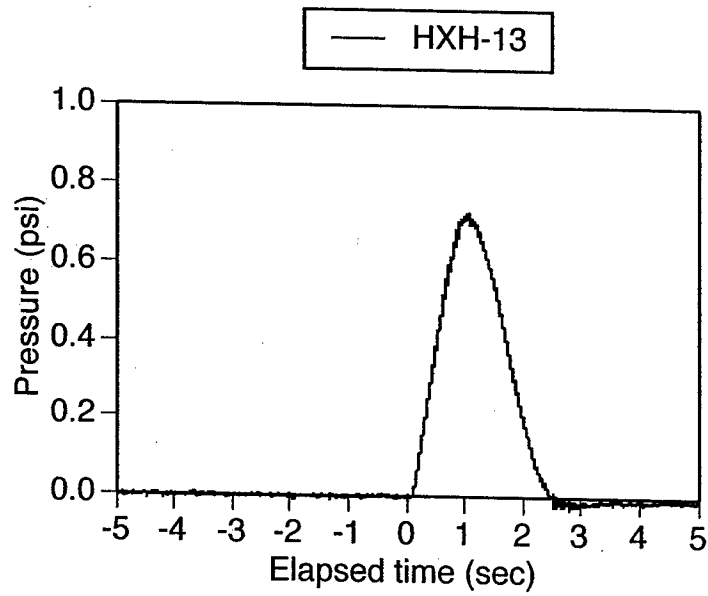

Figure D-10. Pressure Transient for Experiment HXH-13

Over-pressure curves for 15 second flows through three nozzles [total fuel quantity approximately 1.72 liters (0.45 gal)] (Continued).

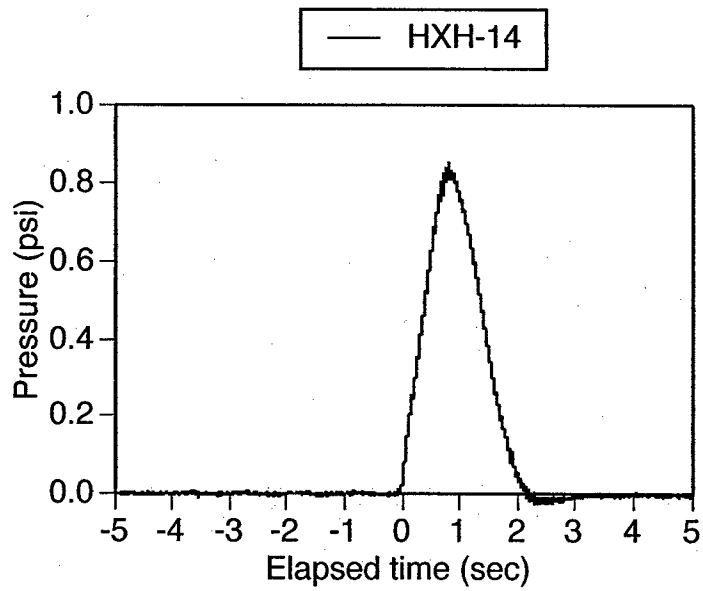

Figure D-11. Pressure Transient for Experiment HXH-14

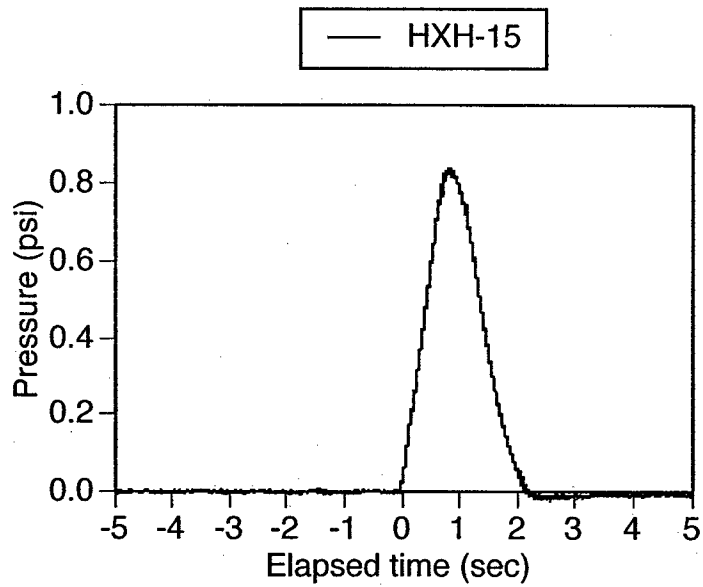

Figure D-12. Pressure Transient for Experiment HXH-15

Over-pressure curves for 15 second flows through four nozzles [total fuel quantity approximately 2.23 liters (0.59 gal)].

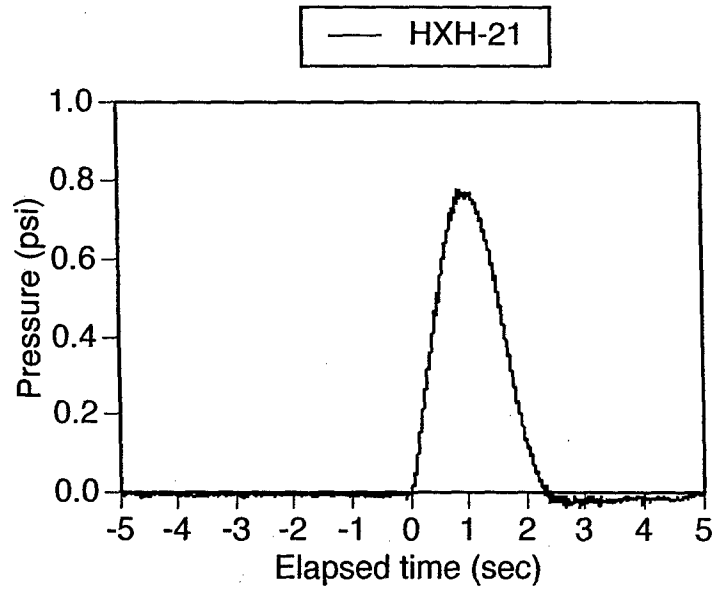

Figure D-13. Pressure Transient for Experiment HXH-21

Over-pressure curves for 15 second flows through four nozzles [total fuel quantity approximately 2.23 liters (0.59 gal)] (Continued).

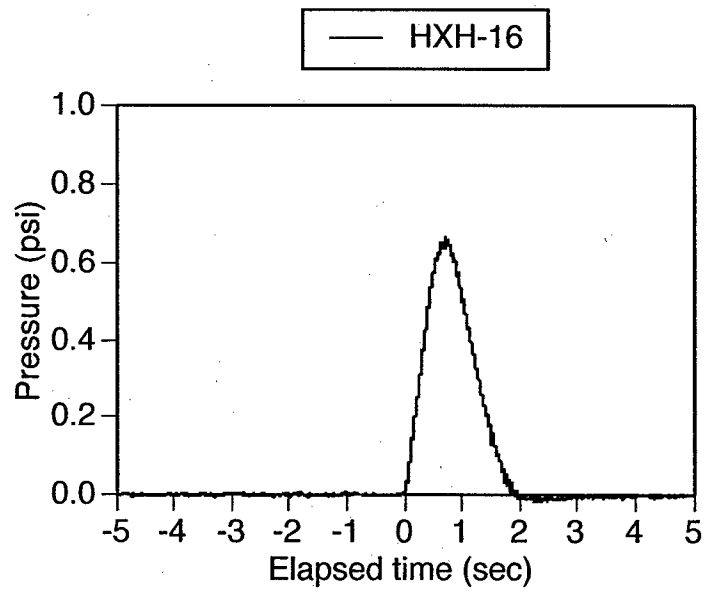

Figure D-14. Pressure Transient for Experiment HXH-16

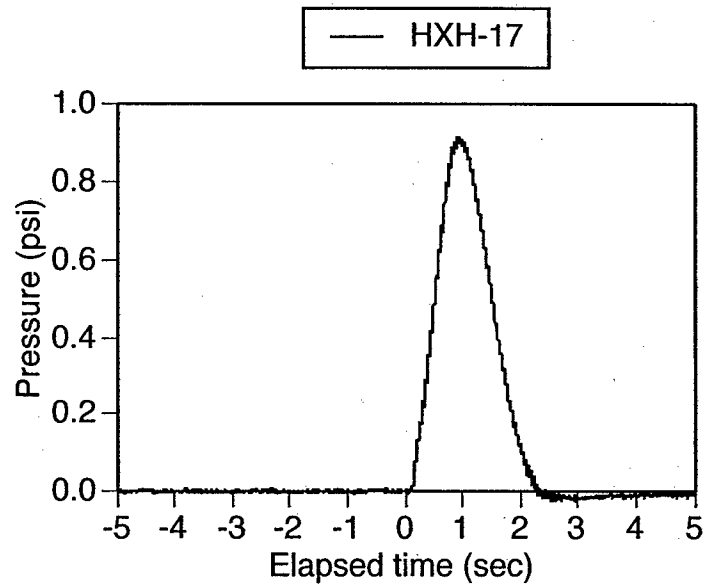

Figure D-15. Pressure Transient for Experiment HXH-17

Over-pressure curves for 15 second flows through five nozzles [total fuel quantity approximately 2.82 liters (0.74 gal)].

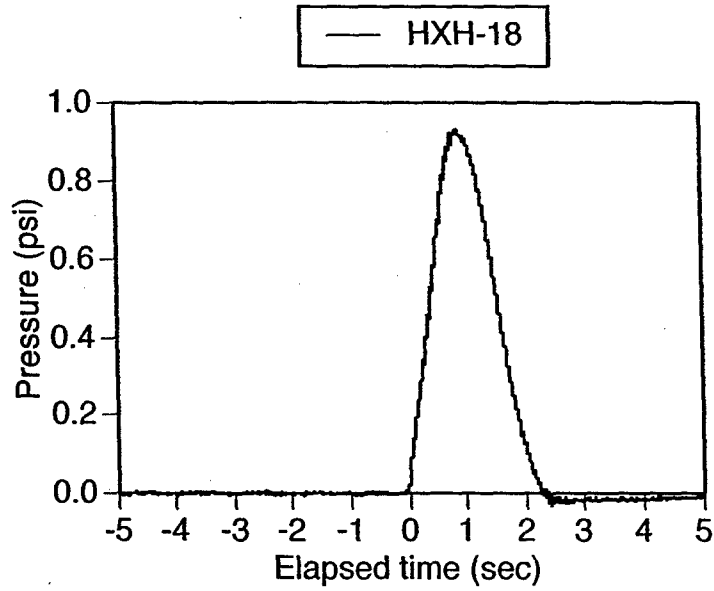

Figure D-16. Pressure Transient for Experiment HXH-18

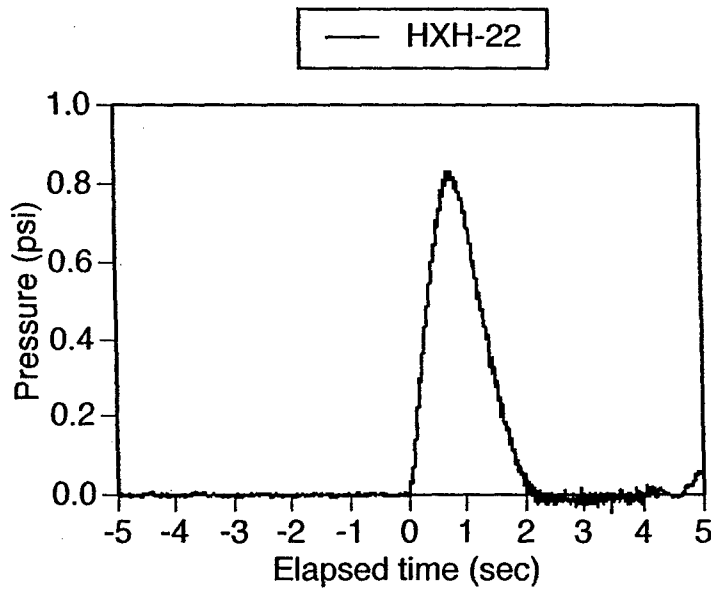

Figure D-17. Pressure Transient for Experiment HXH-22

Over-pressure curves for 15 second flows through five nozzles [total fuel quantity approximately 2.82 liters (0.74 gal)] (Continued)