

REPORT DOCUMENTATION PAGE

Form Approved OMB No. 0704-0188

Public reporting burden for this collection of information is estimated to average 1 hour per response, including the time for reviewing instructions, searching existing data sources, gathering and maintaining the data needed, and completing and reviewing the collection of information. Send comments regarding this burden estimate or any other aspect of this collection of information, including suggestions for reducing the burden, to Department of Defense, Washington Headquarters Services, Directorate for Information Operations and Reports (0704-0188), 1215 Jefferson Davis Highway, Suite 1204, Arlington, VA 22202-4302. Respondents should be aware that notwithstanding any other provision of law, no person shall be subject to any penalty for failing to comply with a collection of information if it does not display a currently valid OMB control number.
PLEASE DO NOT RETURN YOUR FORM TO THE ABOVE ADDRESS.

1. REPORT DATE (DD-MM-YYYY) 14-09-2006	2. REPORT TYPE Conference Proceedings	3. DATES COVERED (From – To) 13 September 2006 - 15 September 2006
--	---	--

4. TITLE AND SUBTITLE The role of dosimetry in high-quality EMF risk assessment	5a. CONTRACT NUMBER FA8655-06-1-5063
	5b. GRANT NUMBER
	5c. PROGRAM ELEMENT NUMBER

6. AUTHOR(S) Conference Committee	5d. PROJECT NUMBER
	5d. TASK NUMBER
	5e. WORK UNIT NUMBER

7. PERFORMING ORGANIZATION NAME(S) AND ADDRESS(ES) Institute of non-ionizing radiation Pohorskega bataljona 215 Ljubljana 1000 Slovenia	8. PERFORMING ORGANIZATION REPORT NUMBER N/A
--	--

9. SPONSORING/MONITORING AGENCY NAME(S) AND ADDRESS(ES) EOARD PSC 821 BOX 14 FPO 09421	10. SPONSOR/MONITOR'S ACRONYM(S)
	11. SPONSOR/MONITOR'S REPORT NUMBER(S) CSP 06-5063

12. DISTRIBUTION/AVAILABILITY STATEMENT
Approved for public release; distribution is unlimited. (approval given by local Public Affairs Office)

13. SUPPLEMENTARY NOTES

14. ABSTRACT
The Final Proceedings for The role of EMF dosimetry in high quality risk assessment, 13 September 2006 - 15 September 2006
In the last three decades, the use of devices that emit electromagnetic fields (EMF) has increased dramatically. The proliferation of EMF devices has been accompanied by increased concern about ensuring the safety of their use. Thus, accurate dosimetry represents an essential element of the research in determining the biological effects of electromagnetic fields. The seminar is covering the state of the science in the numerical and experimental dosimetry, exposure assessment and problems in assessment of the corresponding uncertainty. It is extremely important to assess the uncertainty of the results due to the compliance requirements of the Directive of the European Parliament and of the Council 2004/40/EC. The aim of the EMF seminar is a proactive discussion of upcoming issues of human exposure assessment to reassure high-quality of the assessment and reliable results, which can further on contribute to the needed human health protecting strategies. The seminar is organized in following areas: numerical and experimental methods oriented to deal with uncertainty, exposure assessment in environment and workplaces, standardization, legislation and accreditation.

15. SUBJECT TERMS
EOARD, Electromagnetic Fields, Biology

16. SECURITY CLASSIFICATION OF:			17. LIMITATION OF ABSTRACT UL	18. NUMBER OF PAGES 92	19a. NAME OF RESPONSIBLE PERSON ROBERT N. KANG, Lt Col, USAF
a. REPORT UNCLAS	b. ABSTRACT UNCLAS	c. THIS PAGE UNCLAS			19b. TELEPHONE NUMBER (Include area code) +44 (0)20 7514 4437

International seminar on

The Role of Dosimetry in High-Quality EMF Risk Assessment

ABSTRACT BOOK

ORGANIZED BY:

- Intitute of Non-Ionizing Radiation (INIS), Slovenia
- University of Zagreb, Faculty of Electrical Engineering and Computing
- National Institite of Occupational Health, Poland (CIOP-PIB)
- Project COST 281
- Project EMF NET
- World Health Organization (WHO)
- Project Forum EMS
- University of Ljubljana, Faculty of Electrical Engineering



International seminar on The Role of Dosimetry in High-Quality EMF Risk Assessment

Ljubljana, Slovenia and Zagreb, Croatia; September 13 - 15 2006

Organizing committee:

- dr. Dina Šimunič
- dr. Jolanta Karpowicz
- dr. Peter Gajšek

Chairs:

- dr. Dina Šimunič
- dr. Jolanta Karpowicz
- dr. Kresimir Malaric
- dr. Peter Gajšek

Abstract book

Editors: Blaž Valič and Peter Gajšek

PREPARED UNDER THE PATRONAGE:

- Slovenian Ministry of Environmental and Civil Planning
- Croatian Ministry of Science
- Croatian Ministry of Health
- Croatian Accrediation Agency
- Post and Electronic Communications Agency of the Republic Slovenia
- Croatian Agency for Telecommunications
- City of Zagreb

SPONSORS:

- EOARD European Office of Aerospace R&D
- Ericsson-Nikola Tesla d.d.
- ETP Elektrotehniško podjetje za engineering, trgovino, proizvodnjo
- DEM Dravske elektrarne Maribor
- Mobitel
- Narda-STS
- Simobil
- Slovenia Control Slovenian Air Navigation Services
- Telekom
- VIPnet

"We wish to thank the following for their contribution to the success of this conference: European Office of Aerospace Research and Development, Air Force Office of Scientific Research, United States Air Force Research Laboratory (www.london.af.mil)."



Slovenian Air Navigation Services, Ltd.
Kofnikova 19a, SI - 1000 Ljubljana
Slovenia
phone: +386 1 47 34 850
fax: +386 1 47 34 860
e-mail: info@sloveniacontrol.si
<http://www.sloveniacontrol.si>



<http://www.sloveniacontrol.si/n?idc=9233783>

 International seminar on **The Role of Dosimetry in High-Quality EMF Risk Assessment**

Wednesday, September 13 2006, Ljubljana FACULTY OF ELECTRICAL ENGINEERING, TRZASKA 25, LJUBLJANA		
Dosimetry Fundamentals Chairs: Dina Simunic Joe Wiart	09.00	WELCOME AND OPENING REMARKS
	09.30	THE ROLE OF DOSIMETRY IN HIGH QUALITY RESEARCH AND RISK ASSESSMENT: Paolo Ravazzani
	10.00	OVERVIEW OF LEGAL ASPECTS AND INTERNATIONAL STANDARDIZATION FOR EMF: Phil Chadwick
	10.30	COFFE BREAK
	11.00	WHO - GAPS, CHALLENGES AND RESEARCH NEEDS IN DOSIMETRY: Michael Repacholi
	11.30	EMPIRICAL VALIDATION OF SAR PREDICTED BY NUMERICAL CODE: Peter Gajšek
	12.00	MODELING AND ANALYSIS OF THE SAR AND TEMPERATURE RISE: Joe Wiart
	12.30	LUNCH
Numerical Dosimetry Chairs: Phil Chadwick Paolo Ravazzani	13.30	HOW TO DETERMINE COMPLIANCE WITH DIRECTIVE'S EXPOSURE LIMITS FOR WORKERS: Yngve Hamnerius
	14.00	PROBLEMS AND GAPS FOR THE HUMAN EXPOSURE ASSESSMENT IN REAL ENVIRONMENT: Jolanta Karpowicz
	14.30	INFLUENCE OF IMPLANTS ON FIELDS DISTRIBUTION IN HUMANS: Blaz Valic
	15.00	COFFE BREAK
	15.30	SPECIAL PANEL: Commercial Codes for EMF computation in Bioelectromagnetics - Applications, state of the art and future Perspectives; Moderator Paolo Ravazzani NUMERICAL SOLUTIONS FOR SCIENTIFIC AND INDUSTRIAL COMPUTATIONAL DOSIMETRY FOR THE FUTURE: P. Futter SAR, BIOLOGICAL MODELS AND APPLICATIONS IN CST STUDIO SUITE™ 2006: T. Wittig, M. Italiani, A. Di Pasquale, A. Orlandi
	17.00	CONCLUSION OF THE FIRST DAY
	20.00	SOCIAL EVENT: DINNER

Thursday, September 14 2006, Zagreb FACULTY OF ELECTRICAL ENGINEERING, UNSKA 3, ZAGREB		
	12.00	LUNCH
Experimental Dosimetry Chairs: Jolanta Karpowicz Yngve Hamnerius	13.00	WELCOME AND OPENING REMARKS
	13.30	UNCERTAINTY ASSESSMENT OF EMF EXPOSIMETRY AND DOSIMETRY IN PRESENT RF TECHNOLOGIES: Dina Simunic
	14.00	OVERVIEW OF EXISTING DOSIMETRY AND EXPOSIMETRY METHODS: Georg Neubauer, Gernot Schmid
	14.30	IN SITU MEASUREMENTS AND PERSONAL EXPOSIMETERS IN EMF ENVIRONMENT: Gyorgy Thuroczy
	15.00	IEC STANDARD FOR EVALUATING RF FIELDS NEAR BASE STATIONS: Peter Zollman
	15.30	COFFE BREAK
Short Communications and Posters Chairs: Georg Neubauer Peter Zollman	16.00	RELATION BETWEEN STATIONARY AND PERSONAL MAGNETIC FIELD EXPOSURE IN THE VICINITY OF HIGH VOLTAGE TRANSMISSION LINES AS A MODEL FOR THE OCCUPATIONAL PERSONAL EXPOSURE ASSESSMENT: Gilbert Decat
	16.10	MEASUREMENTS OF MAGNETIC FIELDS, SURROUNDING DIFFERENT EAS SYSTEMS: Jimmy Trulsson, Gert Anger, Ulrika Estenberg
	16.20	ASSESSMENT OF EXPOSURE TO RADIO BASE STATIONS IN KOREA: Kim Byung Chan, Choi Hyung Do
	16.30	INTERCOMPARISON OF HUMAN ESPOSURE ASSESSMENT IN ENVIRONMENT BY BROAD BAND MEASUREMENTS: Giovanni D'Amore
	16.50	EXAMPLE OF A CONFIDENCE-BUILDING-MEASURE IN BTS-SITING BY EVALUATION OF PUBLIC-EMF-EXPOSURE BEFORE SITING THE MOBILE-TELEFONE-ANTENNAS: Eva Marsalek
	17.00	EMF RISK FOR OPERATORS MOUNTING, ADJUSTING AND MAINTAINING BASE STATIONS: M. Israel, T. Shalamanova, I. Iliev, M. Ivanova
	17.10	RF ELECTROMAGNETIC FIELDS MEASUREMENTS IN GREECE: Efthymios Karabetsos, George Filippopoulos, Dimitrios Koutounidis, Chrysa Govari, Nektarios Skamnakis
	17.20	PRIMARY AND SECONDARY EMF STANDARDS – ACTIVITIES AND EXPERIENCES IN CALIBRATING EMF METERS: Pawel Bienkowski, Hubert Trzaska
	17.30	ELF ELECTRIC AND MAGNETIC FIELDS MEASUREMENTS IN GREECE: Efthymios Karabetsos, George Filippopoulos, Dimitrios Koutounidis, Chrysa Govari, Nektarios Skamnakis
	17.40	RESULTS OF LEGISLATIVE EXPOSURE ASSESSMENT IN CROATIA: Srecko Grgic, Dina Simunic
	poster	MEASUREMENTS OF ELECTROMAGNETIC FIELD AND INDUCED CURRENT TO ASSESS EXPOSURE OF ELECTROSURGEONS: Krzysztof Gryz, Jolanta Karpowicz
	poster	ASSESSMENT OF RADIOFREQUENCY (RF) RADIATION LEVELS AROUND GSM BASE STATIONS IN SOME CITIES FROM REPUBLIC OF SERBIA: Branislav Vulevic
	Poster	DATA OF RF RADIATION AROUND BASE STATIONS FOR MOBILE COMMUNICATIONS IN BULGARIA: M. Israel, T. Shalamanova, V. Zaryabova
	Poster	ELECTROMAGNETIC FIELD LEVELS IN THE WORKING ENVIRONMENT IN RADIO AND TV STATIONS: M. Ivanova, M. Israel, V. Zaryabova, T. Shalamanova

	Poster	FREQUENCY SELECTIVE MEASUREMENTS OF RADIOFREQUENCY RADIATION EMITTED BY SOURCES IN THE VHF AND UHF BAND IN CONNECTION WITH HUMAN EXPOSURE: Simona Miclaus, Paul Bechet, Emil Teodoru
	poster	ACCURACY LIMITATION FACTORS IN NEAR FIELD EMF METROLOGY: Pawel Bienkowski
Workshop on Exposure Assessment Uncertainty Workshop Phase I Chairs: Alastair McKinlay Michael Repacholi	18.00	ROLE OF EMF EXPOSURE ASSESSMENT UNCERTAINTY ANALYSIS IN THE PROCES OF TESTING THE COMPLIANCE WITH REGULATIONS: Jolanta Karpowicz
		CORRELATION ANALYSIS OF THE CHILDREN'S RESIDENTIAL EXPOSURE IN BELGIUM: Gilbert Decat
		DOSIMETRY UNCERTAINTY OF PRESENT RF TECHNOLOGIES: Katja Pokovic
		UNCERTAINTY OF MEASUREMENT DEVICES CALIBRATION: Krzysztof Gryz
		INVESTIGATIONS WITH PERSONAL RF DOSIMETER: Gyorgy Thuroczy
		PHASE I for the International Interlaboratory Certificate
20.00	SOCIAL EVENT: ZAGREB GUIDED VISIT AND "CHIP-IN DINNER"	

International seminar on The Role of Dosimetry in High-Quality EMF Risk Assessment

Friday, September 15 2006, Zagreb FACULTY OF ELECTRICAL ENGINEERING, UNSKA 3, ZAGREB		
Workshop on Exposure Assessment Uncertainty Workshop Phase I	9.00	JOINT EFFORT IN INTERLABORATORY MEASUREMENTS /PRACTICAL COMPANIES WORKSHOP/ ALL REGISTERED PHASE II for the International Interlaboratory Certificate
	13.00	LUNCH
EMF NET Round Table	14.00	EMF NET ROUND TABLE ON EXPOSURE ASSESSMENT IN EU AND NON-EU COUNTRIES Moderator: Gyorgy Thuroczy
	13.00	ADJOURN Festivity and certificates

THE ROLE OF DOSIMETRY IN HIGH QUALITY RESEARCH ON EMF AND HEALTH AND RELATED RISK ASSESSMENT

P. Ravazzani

Istituto di Ingegneria Biomedica ISIB, Consiglio Nazionale delle Ricerche, Milano, Italy

EMF-NET is a Coordination Action established by the European Commission in the 6th Framework Programme (further information at: <http://emf-net.isib.cnr.it>), that aims to provide a framework for the coordination and the interpretation of the results of the research activities related to the biological effects of electromagnetic fields (EMF). The main objectives of EMF-NET can be summarized as follows:

- Provide a framework for the co-ordination, the interpretation and the dissemination of the results of the ongoing research activities
- Provide policy relevant interpretation/advice for the facilitation of policy development options by the EU (and other bodies)
- Support informed decision-making by health and environmental authorities, industry and consumer associations as well as individuals.
- Support informed decision-making for regulation and risk communication and risk perception
- Provide an inventory of all the ongoing research in the field. Identify research priorities and needs.
- Provide European Commission and other bodies appropriate information for policy making.

The EMF-NET Consortium involves more than 40 participants, including all the coordinators of the EC (FP5) on-going projects, representatives of research projects at European national level (Finland, France, Germany, Greece, Hungary, Italy, UK), and representatives of other EC and international activities, such as EC COST ACTION 281 and the WHO EMF project, associations of industries and manufactures, trade union associations, regulatory bodies and scientific associations.

Aims of this paper is to provide an overview on EMF-NET activities in the definition of recommendations on engineering requirements aspects for experimental research and on quality assurance in Bioelectromagnetics. This activity recently resulted in the organization of the International Workshop "EMF Health Risk Research: Lessons Learned and Recommendations for the Future", called by EMF-NET, the Swiss Agency for the Environment, Forests and Landscape (BUWAL) and the Swiss Federal Office of Public Health (BAG) and in an EMF-NET interpretation report, prepared by EMF-NET Main Task 3 *Improvement of specific common aspects of the research on EMF and health*, chaired by Theodoros Samaras (see at <http://emf-net.isib.cnr.it>).

The role of dosimetry in high quality research on EMF and health is strictly linked to the technical and engineering characteristics of the research in bioelectromagnetics. As a matter of fact, many published studies suffer from inappropriate engineering implementations and a lack of dosimetric information. To address this issue, the basic engineering and dosimetric requirements to conduct scientifically sound EMF experiments investigating biological effects and/or health responses should be defined. That was one of the main goals of the International Workshop on "EMF Health Risk Research: Lessons Learned and Recommendations for the Future", mentioned above, that was held in Monte Verità on November 21-24, 2005. In the course of the Workshop, the minimal requirements regarding specific setups for the various research fields (in vitro, animal, human exposure and epidemiologic studies) were explored, and the main outcomes on this issue were as follows (Samaras et al., 2006):

- Since effects are expected to be small, the likelihood of evoking effects should be maximized, i.e., maximum exposure levels close to the thermal threshold, uniform tissue exposure, optimized modulation, minimization of the biological noise level and of artefacts possibly introduced by the setup without RF should be adopted. The latter should be verified by sham-sham experiments.
- The exposure system or setup must be designed to enable the intended experiments according to a standard protocol, meeting all dosimetric needs and avoiding any EMI/EMC issues. Since protocols differ from endpoint to endpoint, setups cannot be standardised.

- Blinding of the exposure is desirable for any setup but it is mandatory for human provocation studies. Regarding in vitro and in vivo experiments at least the evaluation should be blinded.
- True sham exposure is mandatory. Incubator controls for in vitro experiments and positive controls will depend on the experiment.
- In general, close collaboration between biological/medical and engineering parties is required throughout the design phase of exposure setups.
- The dosimetry characterisation of the exposure should include the distribution of the induced electric field or SAR as well as that of the magnetic field in space and time, including an experimental worst-case evaluation of temperature increase within samples. If the increase is not negligibly small from a biological point of view, arrangements for temperature control must be provided in the setup. The minimal requirements regarding SAR information should include the average value in the exposed volume (whole-body exposure vs. local exposure for in vivo experiments), spatial peak values averaged over appropriate masses, organ peak and average values for all tissues/cells exposed (whole-body and spatial peak values are only sufficient if global thermoregulatory responses are investigated). When micro-dosimetric information is of interest, a two-step procedure is appropriate, i.e., 1) characterization of the field distribution at the macroscopic level (macrodosimetry) from which 2) microdosimetry data can be derived.
- An important part of dosimetry is the analysis of uncertainty and variation. Uncertainty describes the uncertainty of the determined mean value of the exposure distribution (e.g., uncertainty of measurements and numerical tools, inappropriate average animal model, dielectric parameters of tissue and setup components, secondary coupling effects, etc.). Variation describes the variations from the mean as a function of changes during the exposure (e.g., position within the exposure system, anatomy of animals/humans (size, weight, etc.) or amount of medium, posture, variations of dielectric parameters between samples, animals and setup, amplifier drifts, etc.). Uncertainties and variations should be provided for whole-body, spatial peak as well as tissue-specific SAR values, H-field and temperature increases (if not demonstrated to be negligible).
- Dosimetry should be based mainly on numerical dosimetry. Numerical dosimetry must be verified by experimental measurements, the agreement between which must be within the combined uncertainty of both techniques. Numerical dosimetry also constitutes an essential part in the development and optimization of exposure setups.
- Basic procedures to obtain minimal dosimetric data as described in the literature are considered to be sufficient for most exposure setups. More guidelines are needed to address large scale in vivo studies.
- The current, commercially available numerical tools are sufficient for dosimetric studies. Since most dosimetric evaluations involve greatly non-homogenous structures, FDTD was defined as the most suitable technique (FIT is considered to be equivalent). Other methods, e.g., FEM, are also appropriate if the required discretisation can be obtained.
- The current, commercially available experimental and dosimetric tools are sufficient for the characterization of the exposure setup and the validation of numerical dosimetry.
- Animal and human models with enhanced resolutions have become available. Nevertheless, models still pose the largest limitations for dosimetry and therefore enhancements should be of top priority, such as improved animal models or the generation of a "virtual family".
- Shortcomings have been identified regarding sound procedures and equipment for exposure assessments in epidemiological studies of the general population. Substantial progress has been made in the last years, especially regarding dosimeters and the estimation of exposure from handsets. The assessment of low-level in situ exposure is more difficult and a consensus about suitable techniques could not be found, regarding, in particular, how to combine SAR with time, and how to combine different exposure sources.
- In general, retrospective dosimetry is difficult to conduct and aggravates the difficulty of evaluating past studies with insufficient dosimetric data.

Acknowledgements

This paper is supported by the Coordination Action "EMF-NET Effects of the Exposure to Electromagnetic Fields: From Science to Public Health and Safer Workplace", European Commission FP6, Thematic

Priority 8, Policy support and anticipating scientific and technological needs, Contract N° SSPE-CT-2004-502173 (2004-2008).

References

1. Samaras T, Kuster N, Negovetic S., 2006, Recommendations on Engineering requirements/aspects for experimental research in Bioelectromagnetics and Recommendations on quality assurance in Bioelectromagnetics research, EC FP6 Coordination Action EMF-NET, Deliverables D36 and D37 - (<http://emf-net.isib.cnr.it/>)

OVERVIEW OF LEGAL ASPECTS AND INTERNATIONAL STANDARDISATION FOR EMF

Philip Chadwick

Chair CENELEC TC106X, MCL, Newbury, UK, phil.chadwick@mcluk.org.

Introduction

This paper describes the way in which EMF assessment standards are integrated into a legally-binding framework throughout the European Union. This framework links the ICNIRP exposure guidelines for the general public and for workers(1), the technical measurement standards produced by CENELEC and IEC and a range of European Directives.

The general public

All products which are sold or "put on the market" in the EU have to be safe. Apart from those products that have their own specific Directives, such as Automotive or medical Devices, equipment that emits electromagnetic fields must comply with the requirements of either the Low Voltage Directive (LVD) or Radio Telecommunications Terminal Equipment (RTTE) Directive. Between them these two Directives cover the majority of devices used or accessed by the general public. They require that the EM emissions from these products are "safe", but they do not themselves set limits on EM emissions or specify what "safe" actually means. That is where CENELEC has a role.

CENELEC – the European Electrotechnical Standardisation Committee – sets standards on a wide range of technical device and system performance parameters. Technical Committee 106X writes standards for EMF emissions from products, under a mandate from the European Commission. Commission Mandate M/305 instructs CENELEC to produce emission standards for devices. Specifically:

The compliance of a product with the emission limits given in the harmonised standards asked for in this mandate, will ensure that the measured EMF exposure of the human body originating from this apparatus, will not under normal use exceed the limits given in the Council Recommendation.

So Mandate M/305 links CENELEC product standards to the levels in the 1999 EU Recommendation on public exposures to EMF. The levels in the Recommendation are based on the advice of ICNIRP.

Dosimetric basis of product assessment standards

The philosophical basis of product EMF standards reflects the structure of the ICNIRP guidelines. The underlying principle is to show compliance with the basic restrictions of ICNIRP, and some assessment standards require that this is done directly, for example the IEC and CENELEC standards for mobile phones. For these devices, SAR is measured directly. For other products it is very difficult to assess compliance with the basic restrictions directly and instead the reference levels are used – for example the standards for putting base stations into service and for the assessment of domestic appliances. In general though, the approach of product standards is to use the reference levels first, and only if these are not met to assess compliance with the basic restrictions. An example would be the CENELEC standard for radiofrequency identification (RFID) devices. This standard encourages the use of reference levels, but allows computational modelling to assess SAR or induced current density if the reference levels are not met.

There are also Generic and Basic product standards which fully employ the ICNIRP structure of reference levels and basic restrictions.

Specific examples of the dosimetric approaches used in these CENELEC standards will be described, and in particular how SAR is measured in mobile phone standards, how field strength values can be used to determine compliance with basic restrictions even when reference levels are exceeded – for example in the RFID standards – under certain very specific conditions. Finally, the scope and extent of

computational modelling will be discussed with specific reference to standards that allow it, such as the domestic appliances standard.

Workers

The Occupational EMF Directive (3) was published in April 2004, with a requirement that it be implemented in national legislation within four years. The EMF Directive applies only to workers, and it is important to realise that it is the workers themselves to which it applies, not the processes or equipment that they use.

The limits in the Directives are threshold quantities. That means that as long as exposures do not exceed them, the Directive does not require an employer to restrict exposure further.

The EMF Directive requires that employers undertake risk/exposure assessments using CENELEC standards: CENELEC now has a new mandate, Mandate M/351, from the Commission to develop these standards. CENELEC Technical Committee 106X is leading the work programme under this mandate and its standards will be listed in/under the Directive.

There will be one "umbrella" standard listed in/under the Directive, and this will give the overview of how an employer should carry out a risk assessment. It will explain the need to identify sources of exposure, where to find information and how to approach an assessment. Any detailed assessment procedures will be called up from existing standards for the assessment of exposures or emissions from particular technologies; where necessary, dedicated new assessment standards will be written.

As well as the existing CENELEC and/or IEC product standards for mobile phones, base stations, RFID and low-power devices, the Directive will call up new standards covering industrial heating(Induction heating and dielectric heating), welding, trains, broadcast (high power TV and radio transmission, radio microphones, video links etc) and effects on active implanted medical devices.

References

1. ICNIRP, 1998. Guidelines on limiting exposure to time-varying electric, magnetic and electromagnetic fields. *Health Physics*, 74(4) 494.
2. European Council Recommendation of 12 July 1999 on the limitation of exposure of the general public to electromagnetic fields 0 Hz to 300 GHz, *Official Journal of the European Communities*, 30-7-99c
3. Minimum health and safety requirements regarding the exposure of Directive 2004/40/EC of the European Parliament and of the Council on the workers to the risks arising from physical agents (electromagnetic fields) (18th individual Directive within the meaning of Article 16(1) of Directive 89/391/EEC).

KEY GAPS, CHALLENGES AND RESEARCH NEEDS IN DOSIMETRY

Dr Mike Repacholi

Former Coordinator, Radiation and Environmental Health Unit, World Health Organization, Geneva
mrepacholi@yahoo.com

Introduction

Since the International EMF Project commenced at WHO in 1996, dosimetry was promoted as being as important as the research into biological and health effects of EMF exposure. When compiling its EMF research agendas, dosimetry is always given as an overarching topic; without good dosimetry the quality of the research is considered sub-standard and the results considered as preliminary until the study is replicated with adequate dosimetry.

Accurate dosimetry is especially necessary when EMF exposure is found to produce adverse consequences to health at levels below existing guideline levels. Without a good knowledge of the dose producing the effect the exposure limits on which they could be based will be less precise. This would then result in larger safety factors in the exposure limits to compensate for this lack of precision in the dosimetry. When one considers the vast improvement in dosimetry over the past decade, studies conducted prior to this time must be viewed with suspicion as effects found could have been due to artefacts or imprecision in the exposure system such as hot-spots in a supposedly uniform field.

Fortunately the encouragement by WHO towards multidisciplinary research teams has meant that dosimetry specialists are included in good studies, or at least such specialists are contracted to oversight the exposure system. This has led to greatly improved dosimetry and more reliable results.

The current dosimetry research needs to improve to improve the health risk assessment process are discussed below drawing from the WHO research agendas (see: www.who.int/emf).

Radiofrequency fields

With the rapid advances in technology, research is needed to document changing patterns of wireless communication usage and exposure to different parts of the body (especially for children and foetuses), including multiple exposure from several sources. Experimental exposure conditions should be based on information gathered from exposure surveys (in contrast to simple source evaluations), especially for children. Little information exists on individuals' exposure in the general population which makes it problematic to estimate the exposure from all radio frequency emitting sources. Communication devices used in close proximity to the body are becoming popular including among children and pregnant women; however dosimetry of different parts of the body in each organ is still limited.

Further work is needed on dosimetric models of children of different ages and of pregnant women. The relationship between SAR and temperature elevation should be better modelled to predict potential hazards associated with specific RF exposure conditions and improve the quality of the exposure systems.

Micro-dosimetry research (i.e., at the cellular or subcellular levels) is needed that may yield new insights concerning biologically relevant targets of RF exposure. Little is known about the field distribution at the micro-scale or the consequences of non-uniformity of fields on sub-cellular structures and molecules in terms of mechanisms of interaction.

Extremely low frequency fields

There is a need for further computational dosimetry relating external EMFs to internal electric fields, particularly from combined electric and magnetic fields in different configurations. Previously most laboratory research was based on induced electric currents in the body as a basic metric. More recently work has commenced to explore the relationship between external exposure and induced electric fields. For a better understanding of biological effects and for the development of exposure guidelines, more

data on internal electric fields under different exposure conditions are needed. This is also needed to assess basic restriction compliance issues.

Calculation of induced electric fields in pregnant women and in the foetus is urgently needed. Very little computation has been carried out on advanced models of the pregnant human and the foetus with appropriate anatomical modelling. It is important to assess possible enhanced induction of electric fields during foetal life in relation to the childhood leukaemia issue.

There is a need to further refine microdosimetric models to take into account the cellular architecture of neural networks and other complex sub-organ systems identified as being more sensitive to induced electric field effects. This modelling needs to take into account influences in cell membrane electrical potentials and on the release of neurotransmitters.

Static magnetic fields

WHO recently sent a request to the European Commission to consider in the 7th Framework program research on the possible health effects of exposure to static magnetic fields as the WHO Task Group on Static Fields considered current information inadequate to conduct health risk assessments at fields above about 2 T. The following dosimetry research requests were sent to the EC:

There are fine resolution, anatomically realistic, voxel phantoms of adult men available that have been widely used in studies with time-varying electromagnetic fields but very little work has been done with static fields. Further work on the use of different sized phantoms, and the use of female phantoms, is considered important, as is the use of pregnant phantoms with fetuses of differing ages. Similar studies could be performed with phantoms of pregnant animals to aid the interpretation of the results of developmental studies with these models.

A fine resolution head-and-shoulder phantom should be developed and used to investigate the electric fields and currents associated with visual phosphenes and vertigo. This model could also be used to investigate the fields and currents generated by head and eye movements in strong static magnetic fields. The latter is considered of particular relevance to interventional MRI procedures where reduced head movements of surgeons and other clinical staff may necessitate increased movement of the eyes. Gross body movement by staff around the interventional system should also be simulated.

Computations using a detailed model of the heart and modelling of common cardiac pathologies are considered important. This model should include the micro-architecture of the heart as well as the smaller blood vessels within the heart that might produce fields and currents that could have some influence on pacemaker rhythm generation and the propagation of depolarisation. In addition, calculations are necessary to estimate the magnitude and spatial distribution of currents that are induced in the heart as a consequence of field and field gradient exposure. Multiple orientations to the field should be studied to allow comparison with the currents that have been calculated to induce cardiac effects.

Although there is a reluctance to use high field MRI on pregnant women at present, it is acknowledged that this situation may change. It would therefore be advisable to carry out modelling studies investigating the currents induced in a foetus by maternal or intrinsic foetal movement in a high field. These calculations (and similar studies with gradient and radiofrequency fields) would allow an estimate to be made of the likelihood of possible effects on the foetus.

EMPIRICAL VALIDATION OF SAR PREDICTED BY NUMERICAL CODE

Dr. Peter Gajšek

Institute of Non-Ionizing Radiation, Ljubljana, Slovenia

Abstract

The development of mathematical dosimetry modeling techniques and powerful computer hardware has resulted in dosimetry modeling as a principle tool in determining EMF exposure. The results of any anatomical model are questionable if the model has not been validated with empirical data obtained from *in vivo* or *in vitro* experiments. Validation of the theoretical with empirical results and the subsequent refining of a model are essential in order to earn the credibility when using these models to establish or revise exposure standards. The increasing acceptance and use of FDTD modeling within the EMF community make it imperative that predictions be compared, and validated against experimental data. With the development of the Finite-Difference Time-Domain (FDTD) code, it is possible to predict whole body and localized SAR values under a wide range of exposure conditions in phantoms and laboratory animals, as well as humans.

Theoretical estimations clearly demonstrated that the size of an exposed object is an important parameter in the potential formation of "cold and hot" spots. Comparison between numerical solutions (FDTD, Mie theory) and empirical data showed good agreement in SAR distributions across the sphere diameters. For the larger size spheres (diameter of 105 mm), the maximum heating was at the leading edge of the sphere, whereas for the smaller sizes (diameter of 66 mm) the heating was sharply peaked inside the sphere.

A systematic series of experiments with rats was performed to validate theoretical predictions with empirical results on influence of orientation on regional brain and whole body SAR values. This paper concentrated on four orientations for whole body SAR and eight for localized SAR validation (see Figure 1). Whole body SAR was also determined calorimetrically and compared to theoretical predictions obtained by FDTD. Mutual comparison showed a good agreement in whole body SAR values and remained within 20 % for all applied orientations. For one orientation (PKEH), the match between two methods was even better ($\pm 5\%$).

Localized SAR values were obtained from rats implanted with temperature probe in the hypothalamus and cortex and exposed to eight different orientations in the far field. Comparison between these data and FDTD predictions showed a good matching among localized SAR values for both brain regions especially for KHE orientation where the difference was within 10%. It was demonstrated that orientation, relative to the RF source, has a profound influence on the regional SAR in both methods. Mismatches between methods occurred, in particular, when the FDTD predicted relatively high or low SAR in a small volume (E orientation). This could be due to confounding factors such as thermal loss or gain from surrounding regions with dissimilar SAR values. In these cases, the extremes in localized SAR were not reflected in the empirical data obtained by temperature measurements. Thus, high and low FDTD predicted localized SAR values corresponded to under- or overestimation of experimentally calculated SAR values, respectively. The PEKH and MEKH orientations provide the best example of this situation where the ratio between FDTD and empirical data in hypothalamus was greater than a factor of two.

Overall, the results of this validation study show a good relationship between empirical and theoretical methods and, thus, offer a relatively high confidence in SAR predictions obtained by digital anatomical models based on FDTD numerical code. It was clearly demonstrated that FDTD method for determining whole body or localized SAR offers an attractive and useful supplement to laborious experimental methods. Since it is not practical to empirically determine regional SAR for all experimental conditions of interest, it would be expected that applications for numerical predictions of SAR would increase rapidly in the future.

References:

1. Dimbylow PJ, and Mann SM (1994): SAR Calculations in an Anatomically Based Realistic Model of the Head for Mobile Communication Transceivers at 900 MHz and 1.8 GHz," *Physics in Medicine and Biology*, vol. 39, 1537-1553.
2. Furse CM, and Gandhi OP (1998): Calculation of Electric Fields and Currents Induced in a Millimeter Resolution Human Model at 60 Hz Using the FDTD Method, *Bioelectromagnetics*, Vol. 19, 293-299.
3. Furse CM, Mathur SP, and Gandhi OP (1990): Improvements in the Finite Difference Time Domain Method for Calculating the Radar Cross Section of a Perfectly Conducting Target, *IEEE Transactions on Microwave Theory and Techniques*, Vol. 38, no. 7, 919-927.
4. Furse CM, Yu SQ, Gandhi OP (1997): Improvements in the FDTD method for near field bioelectromagnetic simulations, *Microwave and Optical Technology Letters*, Vol.16, 341-345.
5. Gajšek P, Ziriak JM, Hurt WD, Walters TJ, and Mason PA (2001): Predicted SAR in Sprague-Dawley rat as a function of permittivity values, *Bioelectromagnetics* 24, 1-17.
6. Gandhi OP, and Chen JY (1992): Numerical Dosimetry at Power Line Frequencies using Anatomically Based Models, *Bioelectromagnetics Supplement*, 1, 43-60.
7. Gandhi OP, and Chen JY (1995): Electromagnetic Absorption in the Human Head from Experimental 6 GHz Hand Held Transceivers, *IEEE Transactions on Electromagnetic Compatibility*, vol. EMC 37, 547-558.
8. Gandhi OP, Lazzi G, Tinniswood A, and Yu Q, (1999): Comparison of numerical and experimental Methods for determination of SAR and Radiation patterns of Handheld Wireless Telephones, *Bioelectromagnetics*, No. 20, 93-101.
9. Mason PA, Hurt WD, Walters TJ, D'Andrea JA, Gajšek P, Ryan KL, Nelson PA, and Ziriak JA (2000): Effects of frequency, permittivity, and voxel size on predicted specific absorption rate values in biological tissue during electromagnetic field exposure, *IEEE Microw. Theory & Techn.*, Vol.48, No 11, 2050-2057.
10. Taflove A., Umashankar KR, and Jurgens TG (1985): Validation of FD TD Modeling of the Radar Cross Section of Three Dimensional Structures Spanning up to Nine Wavelengths, *IEEE Transactions on Antennas and Propagation*, pp. 662-666, June 1985.
11. Umashankar KR, and Taflove A (1982): A Novel Method to Analyze Electromagnetic Scattering of Complex Objects, *IEEE Transactions on Electromagnetic Compatibility*, vol. EMC 24, pp. 397-405.
12. Walters TJ, Blick DW, Johnson LR, Adair ER, and Foster KR (2000): Heating and pain sensation produced in human skin by millimeter waves. *Health Phys.*, Vol. 78, No.3, 259-267.
13. Walters TJ, Ryan KL, Belcher JC, Doyle JM, Tehrany MR, and Mason PA (1998): Regional brain heating during microwave exposure (2.06 GHz), warm-water immersion, environmental heating and exercise, *Bioelectromagnetics* 19, 341-353.

Modeling and Analysis of the SAR and Temperature Rise

Joe Wiart & Man Fai Wong

France Telecom RD , Issy Les Moulineaux France Joe.Wiart@orange-ft.com

Introduction

The assessment, numerically or experimentally, of tissues exposure is fundamental in bioelectromagnetism. Because of that the last ten years have seen large improvement of tools used in numerical dosimetry. Numerical methods have been created or adapted to calculate the Specific Absorption Rate in biological tissues. For instance many studies have been done using finite difference in time domain (FDTD). In spite of that, efforts are still on going since the estimation of the accuracy of any numerical assessment is still a problem due to the complexity and variability of biological tissues and human morphology.

Modeling of SAR and Temperature Rise

The specific absorption rate (SAR) can be assessed using the Root Mean Square estimation of the electric field (E) in the tissues, the conductivity (σ) and the density (ρ) of the exposed structure. With these parameters the SAR is given by the well known equation $SAR = \sigma E_r^2 / 2\rho$. The electric field strength in the volume can be calculated using many numerical methods. The most popular is the FDTD (Finite Difference in Time Domain) based on discrete representation of Maxwell's equations on numeric grids but other approaches such as the FIT (Finite Integration technique) or the FVTD (Finite Volume in Time Domain) can also be used. The FIT uses a pair of staggered grid which can have a more general structure as the standard "Yee cell" of usual FDTD where Electric and Magnetic fields are estimated at different location of a cubic cell known as Yee Cell. Because of that the FDTD grid is orthogonal. The stability of the FDTD is governed by the Courant-Friedrichs-Lewy criterion that imposes a relationship between the spatial grid increments and the time increment. Since the computational domain is limited by the computer memory Absorbing Boundary Conditions (ABC's) have to be applied at the limits to avoid spurious reflections. Nowadays the Perfect Matching Layer (PML) are the most popular and efficient ABC's. To estimate the electromagnetic field in fine heterogeneous structure (such as the inner ear) studies have been carried out on graded mesh, conformal approach and local refinement (subgridding). More recently studies have been carried out on Alternate Derivative Implicit (ADI) to overshoot the stability constraint.

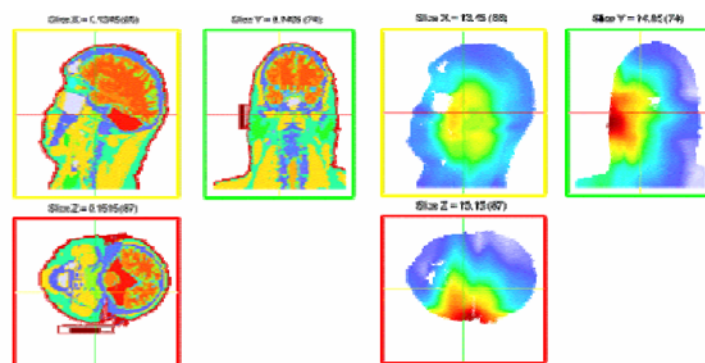

Figure 1: Estimation of the SAR induced in the head of a handset user.

Using these numerical tools and adequate numerical model of the body and handset the electric field in the tissues can be estimated and by the way the SAR assessed. The modelling of the temperature rise has to take into account the contribution of the power deposited by RF sources (SAR) but the evolution and the distribution of the temperature inside the living tissues are governed also by the heat-exchange such as the heat conduction, the blood flow and the metabolism that can be modelled by the Bio Heat Equation (BHE). The BHE is a partial differential equation that can be solved using different numerical methods based on finite differences. Explicit Methods and Implicit Methods can be used. The

Alternating-Direction-Implicit (ADI) method as demonstrated its efficiency in this domain and is often used. This approach separates the operators into one-dimensional components schemes, through three steps (for three-dimensional problems). Each step involves only the implicit operations originating from a single coordinate. Since the computational domain is limited Absorbing Boundary have to be used, ABC have often been used on the skin in this case evaporation, radiation and convection are matched altogether. The main disadvantage of this approach is the impossibility to take into the influence of object close to the skin. For instance influence of the handset itself requires more complex modelling where evaporation, radiation and convection are taken into account and ABC's put far away.

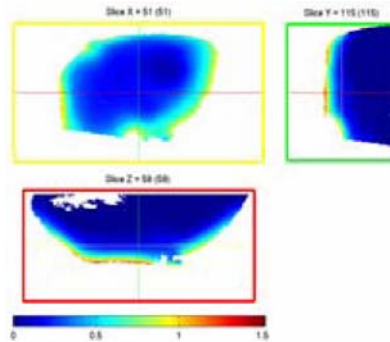

Figure 2 Temperature rise induced by a handset emitting no RF (left) and the RF induced alone (right)

Accuracy and Representativeness of the model.

Nowadays the numerical methods allow E field assessment with quite good accuracy, moreover the recent developments in the use of graphic card have speed up the FDTD calculation. But it is well known now that the accuracy of the numerical RF exposure assessment does not only depend on the numerical methods used but also on the accuracy of the head and on the positioning of the mobile phone relative to the body. For instance dealing with child and handset wrong head model could induce wrong conclusion. The head of children are different from those of adult and a child head is not a small adult head. Because of that effort have to be carried out to built a foetus model

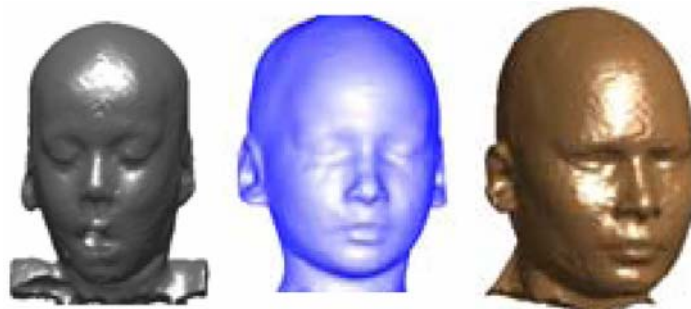

Figure 3: example of child head at different age.

If the accuracy of the model is important the representativeness is a fundamental question. and is nowadays the weak point of the exposure assessment. The SAR in heterogeneous adult head models is often performed on the "Visible Human" (http://www.nlm.nih.gov/research/visible/visible_human.html), whose segmentation was performed by Brook's Air Force Base in the United state. SAR calculations were performed on three different head models derived from MRI data. Besides the visible human two other French models were used with a handset having a patch antenna, the maximum SAR over 10 g was calculated and compared at 900 and 1800 MHz, showing large differences between the head models. At 1800 MHz the maximum SAR over 10 g varies from 0.14 to 0.49 W/kg with a mean value of 0.34 W/kg, and at 900 MHz the values vary from 0.61 to 1.24 W/kg with a meanvalue of 0.85 W/kg.. Dealing with children, using morphing technique the head of different 12 years old children have been created. In this case the difference between minimum and maximum is more than 30%. These results beg the question of how representative any of these head models are and the approach that can be used to handle this question.

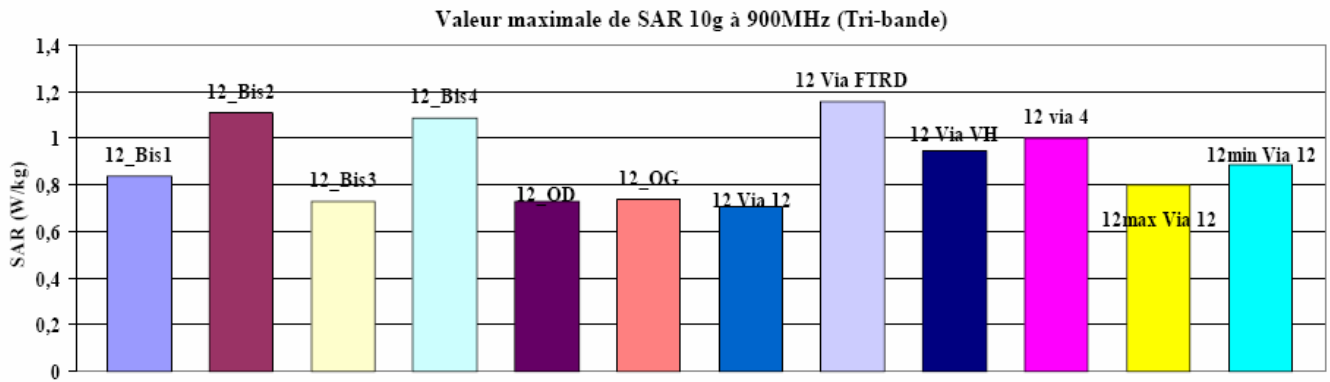

Figure 4 SAR over 10 g assess in different head models of a 12 y.o child.

Conclusion

The numerical methods used to assess the SAR or the temperature rise have reach very good accuracy but the exposure assessment does not depend only on the numerical method. The accuracy, the representativeness of the model, the variability of the position of the handset relatively to the body are key questions that are future challenges.

HOW TO DETERMINE COMPLIANCE WITH THE DIRECTIVE'S EXPOSURE LIMIT VALUES FOR WORKERS

Yngve Hamnerius

Signals & Systems, Chalmers University of Technology, Goteborg, Sweden

Introduction

Exposure of the human body to time varying electric and magnetic fields may potentially cause health problems. The International Commission on Non-Ionizing Radiation Protection (ICNIRP) has set international guidelines for limiting the exposure ICNIRP (1998). Based on these guidelines the European Union released the "Directive 2004/40/EC of the European Parliament and of the Council of 29 April 2004 on the minimum health and safety requirements regarding the exposure of workers to the risks arising from physical agents (electromagnetic fields)". In this directive it is stated:

"It is now considered necessary to introduce measures protecting workers from the risks associated with electromagnetic fields, owing to their effects on the health and safety of workers. However, the long-term effects, including possible carcinogenic effects due to exposure to time-varying electric, magnetic and electromagnetic fields for which there is no conclusive scientific evidence establishing a causal relationship, are not addressed in this Directive. These measures are intended not only to ensure the health and safety of each worker on an individual basis, but also to create a minimum basis of protection for all Community workers, in order to avoid possible distortions of competition".

Most European member states already have some regulations for radiofrequency field but usually not for low frequency fields. I therefore focus on the demands on low frequency electric and magnetic fields. Exposure to time varying electric and magnetic fields result in induction of internal body current, and the known adverse effects are associated with nerve excitation. ICNIRP's basic restriction therefore limits the induced current density in CNS. In the frequency range 4 Hz – 1 kHz, the limit is set at 10 mA/m² (rms, averaged over a cross-section of 1 cm² perpendicular to the current direction) for occupational exposure, a value not to be exceeded at any time. From this basic restriction, reference levels (RL) have been calculated assuming a worst case scenario. For pure 50 Hz sinusoidal electric fields the RL is 10 kV/m and for magnetic fields the RL is 500 μT. However, if it can be shown that the basic restriction is not exceeded, although the exposure level exceeds the RL, continued exposure is allowed.

Measurements

We have measured the electric field strength in 400 kV substations and found that values up to 15 kV/m are quite common, while the magnetic fields were well below the RL. ICNIRP states "For the specific case of occupational exposures at frequencies up to 100 kHz, the derived electric fields can be increased by a factor of 2 under conditions in which adverse indirect effects from contact with electrically charged conductors can be excluded." ICNIRP has a RL for contact currents which for the frequency range 0 – 2500 Hz is 1 mA. This means that the electric field RL at 50 Hz can be increased to 20 kV/m if the contact currents are less than 1 mA.

The work in a substation involves touching of control units of circuit breakers and disconnectors as well as other grounded metallic objects exposed to high electrical fields. Our measurements (Cedergren 2006) show that most work in a 400 kV substation gives rise to steady state contact currents of less than 0.2 mA, see table 1.

However when simultaneously touching a grounded object and an ungrounded metallic object such as a vehicle, contact currents above 1 mA were measured (Cedergren 2006).

Table 1. Measured averaged value of body potential when standing in front of a control unit of a breaker and steady state contact current when touching the control unit. *The asterisk indicates that this cubicle was not in use as one can see from the lower value of the current.

Group (3 breaker units in each)	Number	Average voltage [V]	Average current [uA]
BA – 400 - J	1-3	1860	94
ABC 400 S	4-6 *	580	25
FL 15 S5 - S	7-9	1410	88
T2 – 400 - S	10-12	1667	92
FL5 S4 - S	13-15	1583	101
T3 – 400 - S	16-18	1953	113
FL 18 - S	19-21	1613	97
T400 - S	22-24	1267	84

Industrial spot welding equipment can give rise to high magnetic fields at the operator's position. Spot welding makes use of very high currents during some tens to hundreds of milliseconds for each weld, which may give rise to field strengths exceeding the RLs recommended by ICNIRP. Therefore, compliance of these devices with the ICNIRP basic restrictions must be investigated.

Measurements performed on four different spot welding machines are shown in table 2. Machine A – C are AC welders while D is of the MFDC type. The currents ranged from 15 to 76 kA. The magnetic flux density measured at operator position (35 cm from the electrodes) where above the reference levels in that point. This means that a more detailed investigation must be performed to see if the exposure is within the basic restriction.

Table 2. Magnetic field as a function of frequency for different welding machines. The ratio between the measured value and the reference value is given for each frequency and totally.

Machine	Current (kA)	Frequency (Hz)	B _{measured} (μT)	B _{ref} (μT)	Ratio
A	38	50	2827	500,0	5,65
		150	130	166,7	0,78
		250	101	100,0	1,01
					7,44
B	15	50	1661,0	500,0	3,32
		150	210,0	166,7	1,26
		250	113,0	100,0	1,13
		350	63,0	71,4	0,88
					6,59
C	31	50	1538,0	500,0	3,08
		150	392,0	166,7	2,35
		250	160,0	100,0	1,60
		350	66,0	71,4	0,92
			7,95		
D	76	2000	57,4	30,7	1,87
		4000	3,0	30,7	0,10
		6000	6,1	30,7	0,20
		8000	1,7	30,7	0,06
		10000	2,0	30,7	0,06
		12000	1,2	30,7	0,04
			2,32		

Calculations

To determine if the basic restrictions are violated the induced body currents for a welder have been calculated using the impedance method, Nadeem et al (2004). The welding current affects the body through Biot-Savart law and Faraday's law of induction, and the current is distributed in accordance with Ohm's law.

We have used a full 3D human model with 3 mm resolution to simulate the welder. The model was obtained from Brooks Air Force Laboratory, USA, Mason et al., (2000). The calculated current distribution in the operator is illustrated in figure 1.

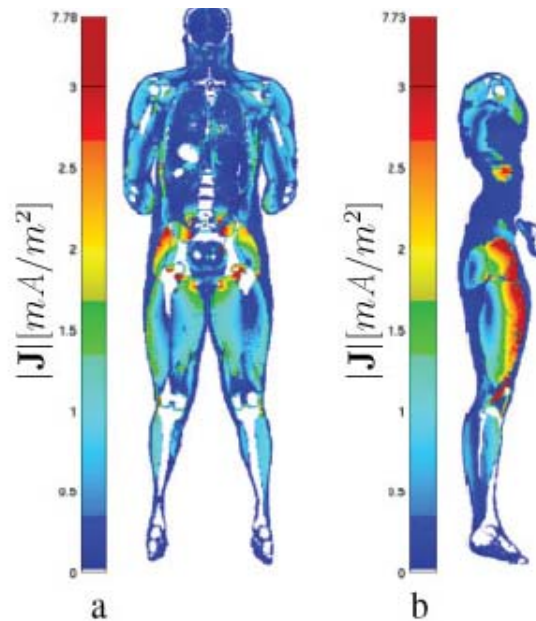

Figure 1. The induced current density in two cross sections.

Discussion

The measurement in 400 kV substations indicate that the RL at 50 Hz can be raised to 20 kV/m if simultaneous touching of grounded and ungrounded metallic objects can be avoided.

When using the reference levels ICNIRP states, "the reference levels are intended to be spatially averaged values over the entire body of the exposed individual, but with the important proviso that the basic restrictions on localized exposure are not exceeded." We have in one 50 Hz case calculated the spatially averaged values from the absolute value of the magnetic flux density in each voxel averaged over all voxels of the man model. This gave an average value of 87 μT , which should be compared with the RL of 500 μT . The calculated maximum current density in the trunk was 14 mA/m^2 , which exceeds the basic restriction of 10 mA/m^2 . Thus, although the averaged value of the magnetic flux density is well below the RL, the basic restriction might not be fulfilled. This demonstrates that conclusions concerning fulfilment of the basic restrictions, from the averaged field values, must be done with most care in the case of spatially inhomogeneous fields.

The current density in the CNS shall be averaged over 1 cm^2 . The spine is surrounded by spinal fluid, which has a higher conductivity than the spine. This means that the current density is higher in the spinal fluid than in the spine. When making the 1 cm^2 averaging the spinal fluid will in many cases be included, giving rise to higher value. ICNIRP gives no guidance how this shall be treated.

The conclusion is that exposures over the reference levels need careful investigations to determine if the basic restrictions are met.

References

1. Cedergren J. 2006 "Human Contact Currents in Swedish 400-kV Substations" Master thesis, Chalmers University of Technology, Dept. of Signals and Systems.
2. ICNIRP 1998 "Guidelines for limiting exposure to time varying electric, magnetic, and electromagnetic fields (up to 300 GHz). Health Physics 74:494–522
3. Mason PA, Ziriak JM, Hurt WD, Walters TJ, Ryan KL, Nelson DA, Smith KI, D'Andrea JA. 2000 In: Recent advancements in dosimetry measurements and modeling. Klauenberg BJ, Miklavcic D, editors. Radio frequency radiation dosimetry. Norwell, MA: Kluwer. pp 141–155.
4. Nadeem M, Hamnerius Y, Hansson Mild K and Persson M 2004 "Magnetic Field from Spot Welding Equipment - Is the Basic Restriction Exceeded?" Bioelectromagnetics 25: 278-284.

PROBLEMS AND GAPS FOR THE HUMAN EXPOSURE ASSESSMENT IN REAL ENVIRONMENT

Jolanta Karpowicz, Krzysztof Gryz

CENTRAL INSTITUTE FOR LABOUR PROTECTION – NATIONAL RESEARCH INSTITUTE, LABORATORY OF ELECTROMAGNETIC HAZARDS, WARSZAWA, POLAND jokar@ciop.pl

Keywords: EMF exposure, exposure assessment, measurements, numerical calculations

Introduction

The majority of population is subject to simultaneous exposure to electromagnetic fields (EMF) from broadcasting and power distribution installations, as well as various electrical appliances. EMF in the workplace has often very specific characteristics in comparison with the fields from general environment. In working conditions not only the locations of the EMF source and worker's body, but also the geometry of the source, frequency and level of produced EMF in its vicinity, can change significantly, exposure level can be high, even exceeding international safety guidelines.

EMF's exposure assessment adequate to the real exposure level is the crucial step towards appropriate risk assessment for occupational safety and health (OSH) engineering, epidemiological studies of EMF-exposed groups, environmental monitoring. The highest requirements concerning detailed EMF exposure assessment come from the legislations concerning mandatory control of occupational or environmental EMF exposure, e.g. European Directive on workers EMF exposure limitation 2004/40/EC. The classical assessment of EMF's exposure is based on the results of spot measurements of current value of electric or magnetic field strength from selected frequency range. In most cases low frequency/50 Hz or radio/microwave are taken into the consideration separately. Modern EMF's measurement devices offer the possibility of more detailed investigations of exposure parameters.

The provisions of the Directive 2004/40/EC permit the employer to use exposure level (external measures of exposure like electric and magnetic field strength, E and H) or dosimetric quantities (internal measures of exposure results like induced current, J , and Specific Absorption Rate, SAR) for the mandatory risk assessment. IEEE standards offer also the use of E field induced in exposed tissues. Both parameters can be used till low MHz frequencies. The use of internal measures require numerical calculations and detailed analysis and interpretation of data obtained from modelling.

Method

Professional activities of authors are focused on the detailed analysis of occupational EMF exposure characteristics in various enterprises and application of EMF measurements and/or numerical calculations technique for workers exposure assessment. The presentation is based on analysis of the fundamental problems defined for the use of numerical calculations for workers exposure assessment in real occupational situations.

Results

It is still significant lack of epidemiological and biomedical studies taking into consideration real complex parameters of EMF's exposure. Investigation concerning EMF from ELF and RF ranges is very important for epidemiological studies, especially when all components of exposure are weak, and should be taken into consideration. The "environmental" exposure pattern is so complicated that carrying out an experimental study of all possibilities of simultaneous exposure is absolutely impossible. The first step of such a study could be a good quality epidemiological study based on appropriate dosimetry, taking into consideration all exposure components.

For the practical EMF exposure assessment (especially at workplace), first of all it should be discussed when it is acceptable to make the EMF exposure assessment by spot measurements with a broad-band RMS meter (i.e. the most convenient and less expensive method). For the other situations, it should be

decided the use of more complicated (and more expensive) exposure assessment method: more detailed measurements or dosimetric calculations.

The analysis of detailed data obtained from various situations and experience with the numerical calculations modelling realistic exposure scenarios for the assessment of the exposure following the internal measures' limitations have shown a number of practical problems, identified for the EMF exposure assessment. The examples will be presented.

In the most of cases of high level exposure, it is caused by the need for hand operation of the EMF sources. For the exposure assessment of such cases the modelling of realistic posture of exposed body and possible simplifications of it to reduce the complication and costs of exposure assessment process is of high priority. For the wider use of numerical calculations for the assessment of workers EMF exposure, it is of high priority to obtain well verified scientific data concerning the possibility to use simplified numerical models of working places and EMF exposure conditions and the uncertainty of exposure assessment for checking the compliance with the regulations. The practical use of numerical calculations for the EMF exposure assessment is also problematic because it was not defined when various software packages can be used, and none of currently available software is specialized for workers exposure. Additionally, a few commercial human body models are applicable for selected specialized software only. Separate problem is the calculations of induced and contact currents, which can be also measured.

Conclusion

The use of internal measures of exposure results for risk evaluation is possible only by simulation computational methods, with the use of adequate representation of the exposed environment (e.g. workplace) and human body models. Such calculations for particular exposure situations require highly skilled professionals and specialized software. The modelling of real exposure scenario, validation of calculations result and interpretation of obtained data is usually very time-consuming and currently achievable by research centres only. These are reasons why, the possibility of practical use of numerical modelling by the particular employers, especially from SMEs is very limited in contrast to the relatively effective use of such technique for large series manufacturing (e.g. common use electrical devices, like mobile phones handsets). In this respect, the question arises if more simple models are powerful enough for performing roughly assessment of the occupational EMF sources and workers exposure level, while every day's occupational safety and health practice.

Acknowledgment

This review has been prepared from results obtained from the investigations supported by the State Committee for Scientific Research and Ministry of Economy, Labour and Social Policy of Poland (individual grants focused on occupational EMF exposure investigations).

INFLUENCE OF IMPLANTS ON FIELDS DISTRIBUTION IN HUMANS

Blaž Valič^{1,2,3}, Damijan Miklavčič², Peter Gajšek³

E-NET OKOLJE, Ljubljana, Slovenia
 University of Ljubljana, Faculty of Electrical Engineering, Ljubljana, Slovenia
 Institute of Non-ionizing Radiation (INIS), Ljubljana, Slovenia

Introduction

Electric field distribution inside human body is altered by an implant. The extent of the alteration of electric field distribution because of the implant depends on:

- size, shape and material properties of the implant;
- body shape, size and dielectric properties of tissues in the body;
- position of the implant inside the body and
- electromagnetic field frequency, direction, polarization and strength.

Because of variety of their purpose, implants are made from materials with different dielectric properties, have different shapes and sizes. More, also present electromagnetic fields vary in their characteristics.

The limit values of electromagnetic field in the area with public access are proposed in various documents. Among others, the most important document is the Guidelines for limiting exposure to time-varying electric, magnetic, and electromagnetic fields (up to 300 GHz) [ICNIRP, 1998]. When preparing ICNIRP Guidelines the authors focused on normal healthy human being without an implant: "Compliance with the present guidelines may not necessarily preclude interference with, or effects on, medical devices such as metallic prostheses, cardiac pacemakers and defibrillators, and cochlear implants. Interference with pacemakers may occur at levels below the recommended reference levels. Advice on avoiding these problems is beyond the scope of the present document but is available elsewhere (UNEP/WHO/IRPA 1993)" [ICNIRP, 1998]. In the mentioned Environmental health criteria 137 Electromagnetic fields (300 Hz to 300 GHz) [UNEP/WHO/IRPA, 1993] the problem of implants is only shortly discussed and limited to cardiac pacemakers only.

Most of the literature about implants in electromagnetic field deals with EMC problems of active implants and their safety [Kainz et al., 2001; Kolb, 2003; Kainz et al., 2005; Trigano et al., 2005] or with tissue and implant heating during MR imaging [Chou, 2000; Shellock, 2001; Finelli *et al.*, 2002; Luechinger *et al.*, 2005; Shellock *et al.*, 2005] whereas about other types of exposures we found limited literature. In the [McIntosh *et al.*, 2005] they calculated SAR distribution and temperature change around a metallic plate in the head of a RF exposed Worker. They performed the calculations at frequencies between 100 and 3000 MHz for external power flux density of 10 W/m² and at the values of ICNIRP reference levels for occupational exposure and found that SAR is enhanced by a metallic plate. When averaged over 10 g (in the shape of the cube) it reached 4.87 W/kg, but is lower than ICNIRP basic restriction for occupational exposure (10 W/kg). The temperature increase is even less notable, being lower than 1°C. Virtanen and colleagues [2005] calculated SAR enhancements due to ring and rod shaped metallic implants at mobile frequencies (900 and 1800 MHz). Depending on the orientation, the 10 g averaged SAR enhancement was always under 3 (ratio between SAR with implant and without it), whereas non averaged increase was up to 700.

To determine the influence of an implant on electromagnetic field distribution inside a human we used numerical modelling to calculate electromagnetic field distribution in a human with intramedular nail in the low frequency (50 Hz) electromagnetic field. Nevertheless that unperturbed electric field was at ICNIRP reference levels for general public (5000 V/m, 0.1 µT), current density in the tissue at the end of the intramedular nail was higher than ICNIRP basic restrictions for general public (2 mA/m²).

Because of different implants, persons and exposures there is no general answer on the question about the influence of implants on field distribution in human body. For a given situation, a detailed analysis and calculation should be performed to give the answer whether basic restrictions are met.

Literature

1. Chou CK. 2000. Use of Full Size Human Model for Evaluating Metal Implant Heating During Magnetic Resonance Imaging. V: Klawtenberg BJ, Miklavčič D (ur). Radio Frequency Radiation Dosimetry and Its Relationship to the Biological Effects of Electromagnetic Fields. Proceedings of NATO Advanced Research Workshop on Radio Frequency Radiation Dosimetry and Its Relationship to the Biological Effects of Electromagnetic Fields, Gozd Matuljek, Slovenia, 12 – 16 October 1988. Kluwer Academic Publishers, Dordrecht/Boston/London.
2. Finelli DA, Rezai AR, Ruggeri PM, Tkach JA, Nyenhuis JA, Hrdlicka G, Sharan A, Gonzalez-Martinez J, Stypulkowski PH, Shellock FG. 2002. MR Imaging-Related Heating of Deep Brain Stimulation Electrodes: In Vitro Study. *Am J Neuroradiol.* 37: 1795-1802.
3. ICNIRP. 1998. Guidelines for limiting exposure to time-varying electric, magnetic, and electromagnetic fields (up to 300 GHz). *Health Phys* 74: 494-522.
4. Kainz W, Neubauer G, Alesch F, Schmid G, Jahn O. 2001. Electromagnetic compatibility of electronic implants – review of literature. *Wien Klin Wochenschr.* 113/23-24: 903-914.
5. Kainz W, Casamento JP, Ruggera PS, Chan DD, Witters DM. 2005. Implantable Cardiac Pacemaker Electromagnetic Compatibility Testing in a Novel Security System Simulator. *IEEE Trans Biomed Eng.* 52: 520-530.
6. Kolb, C, Schmieder S, Lehmann G, Zrenner B, Karch R, Plewan A, Schmitt C. 2003. Do Airport Metal Detectors Interfere With Implantable Pacemakers or Cardioverter-Defibrillators? *J. Am Coll Cardiol.* 41: 2054-2059.
7. Luechinger R, Zeijlemaker VA, Pedersen EM, Mortensen P, Falk E, Duru F, Candinas R, Boesiger P. 2005. In Vivo heating of pacemaker leads during magnetic resonance imaging. *Eur Heart J.* 26: 376-383.
8. McIntosh RL, Anderson V, McKenzie RJ. 2005. A numerical evaluation of SAR distribution and temperature change around a metallic plate in the head of a RF exposed Worker. *Bioelectromag.* 26: 377-388.
9. Shellock FG. 2001. Metallic Neurosurgical Implants: Evaluation of Magnetic Field Interactions, Heating, and Artefacts at 1.5-Tesla. *J Magn Reson Imaging.* 14: 295-299.
10. Shellock FG, Gounis M, Wakhloo A. 2005. Detachable Coil for Cerebral Aneurysms: In Vitro Evaluation of Magnetic Field Interactions, Heating, and Artifacts at 3T. *Am J Neuroradiol.* 26: 363-366.
11. Trigano A, Blandeau O, Souques M, Gernez JP, Magne I. 2005. Clinical Study of Interference With Cardiac Pacemakers by a Magnetic Field at Power Line Frequencies. *J Am Coll Cardiol.* 45: 896-900.
12. UNEP/WHO/IRPA. 1993. Environmental Health Criteria 137 Electromagnetic Fields (300 Hz to 300 GHz). WHO, Geneva.
13. Virtanen H, Huttunen J, Toropainen A, Lappalainen R. 2005. Interaction of mobile phones with superficial passive implants. *Phys Med Biol.* 50: 2689-2700.

IN SITU ASSESSMENT USING NUMERICAL TOOLS: CHALLENGES AND LIMITS

Joe Wiart, Azedine Gati, Man Fai Wong

France telecom Division RD, Issy les Moulineaux, France

Last years large efforts have been carried out to develop experimental tools to measure the exposure in situ. The different signals pattern, the time and space variations have been analysed and European recommendation or draft standard such as ECC or prEN50492 provides methods to evaluate in situ the exposure.

The main limitation of the measurement is linked to the complexity of the equipments and the time required to perform the measurement at different locations as requested by the standards. Moreover some time, in close environment such as apartment, measurements are difficult to perform.

Numerical assessment should be an alternative. Since few years efforts are devoted to develop numerical code to assess the in situ exposure. In the near field region, numerical models of antenna have been developed and allow accurate predictions. In the far field region, the variability of the environment and the lack of information about the dielectric properties of building induce large uncertainties.

In both cases, the main challenge is to assess the uncertainty of the prediction. The present presentation will cover the state of the art and the future perspectives

NUMERICAL SOLUTIONS FOR SCIENTIFIC AND INDUSTRIAL COMPUTATIONAL DOSIMETRY FOR THE FUTURE

P. Fütter

Schmid & Partner Engineering AG, Zurich, Switzerland info@speag.com

SPEAG and the IT'IS Foundation have been at the forefront of dosimetric applications, providing state-of-the-art, standard compliant numerical (SEMCAD X) and experimental (DASY5, iSAR) tools. Active contributions are made on new safety requirement and compliance standard committees, investigating applications ranging from exposure setups, wireless and medical devices, to base station antennas and power lines. Huge progress in numerical tools like SEMCAD X enables straightforward, accurate and efficient electromagnetic and thermal simulation for these applications.

Offering seamless import of CAD models and an extensive high resolution anatomical phantomsdatabase (male, female, children, animals), SEMCAD X enables real-world modelling, e.g., in 64 bit without simplification. High performance FDTD solvers (FIT/C-FDTD, ADI-FDTD) and SAR routines can be accelerated using novel hardware solutions, reducing simulation times by factors of 10 to 50 or more. Coupled EM-thermal simulation allow investigation of thermal effects, including blood flow and non-linear tissue parameters. The most advanced SAR assessment routines offer comprehensive dosimetric evaluation and compliance testing, which can be further validated using DASY5 or iSAR SAR measurement systems. Furthermore, the introduction of numerical computational standards (e.g. IEEE 1528.1, .2 , .3) will further strengthen the role of simulation to solve industrial design issues. SEMCAD X now offers GA based optimization routines, enabling complete design optimization with impedance, radiation efficiency, SAR and thermal goals.

The role of numerical simulations tools like SEMCAD X in extending scientific research, understanding complex electromagnetic and thermal field interactions for dosimetric assessment and compliance testing of current and future technologies is indisputable.

SAR, BIOLOGICAL MODELS AND APPLICATIONS IN CST STUDIO SUITE™ 2006

T. Wittig¹, M. Italiani², A. Di Pasquale², A. Orlandi²

Computer Simulation Technology, Darmstadt, Germany
UAq EMC Laboratory, Univ. of L'Aquila, L'Aquila, Italy

The correct prediction of the Specific Absorption Rate (SAR) by means of electromagnetic simulation tools is becoming more and more an issue in the development of radiating devices which interact with biological tissues such as mobile phones or pacemakers, etc. In order to avoid long prototype testing and measurement phases and to shorten the "time to market" of a new product, efficient and reliable simulation is crucial.

For the numerical procedure of SAR simulations several critical points need to be considered. These issues range from the correct modelling of the device as well as the capability to build up and import biological models from medical imaging, the accurate calculation of the primary electromagnetic variables (electric and magnetic field) inside tissues and other materials with specific electric and magnetic properties, the correct, consistent and robust procedure for the evaluation of the mass averaged SAR according to the international standards, and finally, the visualization of the results in a meaningful form.

CST STUDIO SUITE™ 2006 uses an accurate and flexible technique not only for the computation of the primary variables but also for the mass-averaged SAR comparable to the IEEE C95.3 standard. Alternatively own procedures are offered that show improved consistency for structure rotations.

The capability of CST STUDIO SUITE™ 2006 to import voxel models is exploited by a simple application that allows the user to build up three dimensional CST STUDIO SUITE™ 2006 models from the collection of medical imaging.

UNCERTAINTY OF EMF EXPOSURE ASSESSMENT IN PRESENT RF TECHNOLOGIES

Dina Simunic

University of Zagreb, Faculty of Electrical Engineering and Computing,
Unska 3, HR-10000 Zagreb, Croatia

The methods of electromagnetic fields (EMF) exposimetry and dosimetry are expanding, due to the enlivened interest of general population to the EMF exposure assessment. The standardization organizations are developing in-situ measurement standards of human exposure near various sources of EMFs. Except of a measurand, which is a specific quantity and a subject to measurement, for a complete result of measurement, it is necessary to present a quantitative statement of its uncertainty. In certain cases of exposimetry and dosimetry, this is extremely difficult due to complexity of the task.

Uncertainty of measurement is defined three-folds: as a parameter, associated with the result of a measurement, that characterizes the dispersion of the values that could reasonably be attributed to the measurand; as spread of values about the measurement result within which the value of the measurand may be expected to be found; and, a measure of the possible error in the estimated value of the measurand as provided by the result of a measurement.

The uncertainty of the result may be grouped into two categories according to the method used to estimate their numerical values: type A encompasses those which are evaluated by statistical methods, whereas type B, those which are evaluated by other means. All the uncertainty components are represented by an estimated standard deviation, termed standard uncertainty. The standard uncertainty u is standard deviation of the results. Combined standard uncertainty, $U_c(y)$, is a standard uncertainty of the result of a measurement when that result is obtained from the values of a number of other quantities, equal to the positive square root of a sum of terms, the terms being the variances or covariances of these other quantities weighted according to how the measurement result varies with changes in these quantities. Expanded uncertainty, U , is quantity defining the interval about the result of a measurement within which the values that could reasonably be attributed to the measurand may be expected to lie with a high specified level of confidence. Expanded uncertainty is obtained by multiplying the combined standard uncertainty by a coverage factor k . With value of $k = 2$, the confidence level approximates 95 %.

Differences in test results can be a consequence of several factors, e.g., insufficient testing standards to afford more repeatability, test personnel's inability to repeat the test; variation in product profiles; test instrumentation drift or change in calibration with use or age of the instrumentation; or, all of the above.

The contributions of each component of uncertainty are components of the uncertainty table, which consists of their name, probability distribution, weighting or sensitivity coefficient and uncertainty value. The combined uncertainty is evaluated by using sensitivity coefficient, c_i :

$$u_c = \sqrt{\sum_{i=1}^m c_i^2 \cdot u_i^2}$$

For exposimetry, the considered error sources are measurement equipment, calibration, isotropy, linearity, measurement device, noise, drift in output power of the EUT, probe, temperature and humidity, perturbation by the environment, influence of the body, post-processing and spatial averaging.

References:

1. Draft prEN5092: "Basic standard for the in-situ measurement of electromagnetic field strength related to human exposure in the vicinity of base stations," CENELEC, 2006
2. P. Zollman, Convenor IEC PT 62232 IEC Standard for evaluating RF Fields near base stations RF Fields near base stations, COST 281 Seminar "The Role of Dosimetry in High-Quality EMF Risk Assessment", 13-15 September 2006, Zagreb/Ljubljana
3. ISO/IEC Guide to the Expression of Uncertainty in Measurement, 1993

OVERVIEW OF EXISTING DOSIMETRY AND EXPOSIMETRY METHODS

Dr. Georg Neubauer, Dr. Gernot Schmid

Business Unit Mobile Communications Safety, ARC Seibersdorf research

Introduction

Reliable dosimetry and exposimetry are fundamental requirements for both EMF research and EMF exposure evaluation. In particular when looking at EMF research the available scientific evidence on possible health effects from EMF exposure was often defined as inadequate. One of the reasons for this situation was the not accurate or even inadequate description of exposure and dosimetry in many scientific experiments. Before discussing existing dosimetry and exposimetry methods it is worthy to look at definitions of these terms. In the context of non ionising radiation (0 – 300 GHz) dosimetry can be defined as the measurement or the determination by calculations of the internal electric field strength or induced current density, or of the specific absorption (SA) or specific absorption rate (SAR) distributions, in humans or animals, organs or in vitro samples exposed to electromagnetic fields. The term exposimetry is not that common. A possible definition would be to define it as the measurement or the determination by calculations of the external electric or magnetic field strengths or power densities at the locations of exposed humans or animals, organs or in vitro samples.

There are different methods to assess exposure and to perform dosimetry in the low frequency and radiofrequency range. In this paper we first discuss the low frequency range and then the RF range. In both cases measurement and numerical tools are available.

Different types of assessments can be distinguished both for the low frequency and radio frequency range: spot measurements, long term measurements and individual exposure assessment. Spot measurements are performed at a given location for a very short period of time and provide therefore only information on the exposure conditions at a given moment. In contrast, long term measurements and individual exposure assessment are typically determined over a certain period of time, e.g. 24 hours using adequate sampling intervals. Individual exposure is assessed using body worn devices that are often called dosimeters. A less common, but more consistent definition is the term exposimeter.

Low frequency fields

The most common approach to assess electric and magnetic field is based on the effect of induction. Sensors for magnetic fields probes are very often three coils perpendicular to each other, for electric fields three perpendicular dipoles or capacitors are used. When assessing exposure in the low frequency range one has to be aware that exposimetry is sophisticated when dealing with electric fields and less complex when measuring magnetic fields. The human body is a good electrical conductor and has neutral magnetic properties, therefore the electric fields are distorted by the body of the measuring engineer, but not the magnetic ones.

Existing measurement systems can be subdivided in frequency selective and broadband systems. Broadband systems integrate all signals over a defined frequency band (and depending on the system, sometimes also so called out of band signals) and are therefore often not suited to give information on the exposure arising from a certain electromagnetic source. Another approach is to use frequency selective devices. Some devices are broadband systems with additional integrated filter systems, another possibility is to make measurements in the time domain and to perform a Fourier transformation.

For bio-experiments it is an essential requirement to use highly elaborated exposure facilities to guarantee controlled exposed conditions. In the low frequency range very common approaches are the use of coil systems, e.g. Helmholtz or Merritt coils. To examine dosimetric conditions in the exposed biological samples, e.g. test animals or cell cultures it is state of the art to use powerful numerical tools. Possible approaches are to use the impedance method, quasi static finite different time domain (FDTD)

or the scalar potential finite difference (SPFD) method. Due to the availability of powerful computer systems high resolution models of the biological sample, e.g. the human body can be used.

The highest induced current densities in the human body can be expected in the pathways of body fluids as, e.g., blood or cerebrospinal fluid (along the spinal cord) because the conductivity of body fluids is usually higher than those of solid tissues. The magnitude of the induced currents depends not only on the dielectric parameters of the exposed tissue, but also on the orientation of the exposed biological object in the field and in grounding conditions, too.

Radiofrequency fields

Very often there is need to investigate a large frequency band including different services, e.g. mobile communication and broadcasting systems when assessing exposure in the RF range. Most of the ubiquitous sources are operated in the frequency range from 30 MHz to 2.5 GHz. Independent from the service and its specific properties, e.g. bandwidth, the power content of specific signals or the sum of all signals has to be determined using adequate measurement tools. Basically three different types of measurement methods can be distinguished: broadband field probes, frequency selective systems and code selective systems. Similar as in the low frequency range broadband systems cannot give spectral information on the exposure condition. When making an exposure evaluation the total field strength has to be compared to the lowest limit value in the investigated frequency band. Common E – field probes are available up to 60 GHz, magnetic field probes up to 1 GHz. Another approach is to use frequency selective systems, e.g. spectrum analysers. Such systems are dedicated to capture the total power of every relevant signal and separate different channels. A typical example is a super heterodyne spectrum analyser used in combination with adequate antennas. When making worst case exposure extrapolation of some broadband signals, e.g. UMTS it is necessary to use code selective systems to be able to extrapolate exposure based on the power measurement of specific channels, i.e. the pilot channel.

When designing exposure facilities for RF experiments there are different possible approaches: quasi open exposure apparatus and guided wave exposure set ups. The selection of a specific set up depends on different aspects, e.g. exposure frequency, requirements regarding coupling efficiency or requirements in respect of exposure variability. In any case it is imperative to validate dosimetric conditions by using adequate tools. It is very common to use both measurement and numerical tools in the same experiment. One has to be aware that well defined exposure conditions are the basis of reproducible and therefore scientifically valuable results.

References

1. Kuster, N., Schönborn, F.: Recommended Minimal Requirements and Development Guidelines for Exposure Set Ups of Bio – Experiments Addressing the Health Risk Concern of Wireless Communications, *Bioelectromagnetics* 21:508-514, 2000
2. Valberg, P. A.: Designing EMF Experiments: What is Required to Characterise "Exposure"?, *Bioelectromagnetics* 16: 396 – 401, 1995
3. Kuster, N., Schuderer, J., Christ, A, Futter, P, Ebert, S: Guidance for Exposure Design of Human Studies Addressing Health Risk Evaluations of Mobile Phones, *Bioelectromagnetics* 25: 524-529, 2004
4. Neubauer, G, Lamedschwandner, K, Tuschl, H, Schmid, G, Schüz, J, Ruiz, I, Leitgeb, N, Kunsch, B: Studie Dokumentierter Forschungsergebnisse über die Wirkung Niedrigerfrequenter Elektromagnetischer Felder, ARC Report 0141, July 2006-09-04
5. Giczi, W, Neubauer, G: Development and Adaptation of Reliable and Applicable RF Measurement Procedures, BASEXPO Report, ARC Report 0148, March 2006-09-04
6. Kainz, W, Nikoloski, N, Oesch, W, Berdiñas-Torres, V, Fröhlich, J, Neubauer, G, Kuster, N: Development of novel whole-body exposure setups for rats providing high efficiency, National Toxicology Program (NTP) compatibility and well-characterized exposure, *Physics in Medicine and Biology*, in press

-
7. Neubauer, G, Feychting, M, Hamnerius, Y, Kheifets, L, Kuster, N, Ruiz, I, Schüz, J, Überbacher, R, Wiart, J, Rössli, M: Feasibility of future epidemiological studies on possible health effects of mobile phone base stations, *Bioelectromagnetics*, in press

IN SITU MEASUREMENTS AND PERSONAL EXPOSIMETERS IN EMF ENVIRONMENT

György Thuróczy

National Research Institute for Radiobiology and Radiohygiene, Department of Non-Ionizing Radiation, H-1221
Budapest, Anna u.5, Hungary, e-mail: thuroczy@hp.osski.hu

Different sources of RF fields have been introduced over a long period of time. The time of introduction has varied both between and within countries. Fixed outdoor sources that have been present for up to a century are the radio and TV broadcast antennae. The public analogue portable phone system was introduced in most European countries during the nineteen seventies and eighties. Later mobile phones systems, first the analogue and later the digital systems, (i.e. in Europe the Global System of Mobile communication (GSM)), have been built for near 100% coverage of both urban and rural areas. Most typical so far have been the base stations with antennae mounted on buildings and on masts to cover relatively large area. The exposure depends on several factors starting with the characteristics of the signal emitted from the RF source have to be taken in account. The output power, as well as the directional characteristic of the antenna, is important. Some antennae are omni-directional (i.e. the field strengths are the same in all directions) while others may have a relatively narrow main beam, and little power is emitted in other directions. Also the frequency, or the frequency range, and the modulation describe the RF signal characteristics.

Most commonly exposed people are in the far field of the signal from fixed RF sources. Then the electromagnetic waves propagate from the source and to the individual. The field strength, and thus the power density decreases with increasing distance. In addition, absorption and reflections due to hills, buildings etc. determine the exposure level at a certain position. The attenuation of the RF signals in vegetation, house, walls etc. degree of decrease is also frequency dependent.

In the extremely low frequency (ELF) range the exposure nearby the high voltage power lines has wide range of level of electric and magnetic field. Many epidemiological studies found an association between childhood leukemia and proximity of home address at birth to high voltage power lines. However the exposure is low (below few mikrottesla) the apparent risk extends to a greater and greater distance (even 600 m) than would have been expected from previous studies. Otherwise in Hungary it is typical that 10 kV to 4 kV step-down (10/04 kV) transformer stations are being installed in multistory residential and office buildings. Similar technology has been recognized in other countries as well, i.e. in Finland, France, part of Italy, Israel. Magnetic fields (MFs) up to several tens of μT have been measured in apartments or offices located close to transformers. It is also important to provide systematic exposure assessment of residents living above transformer stations, not only with spot measurements but using ELF personal exposimeters.

RF exposure measurements

Within the present study the measurement of the RF exposure at the location accessible to public with site measurements and the exposure to RF with personal dosimeter has been performed. The site measurements were spot measurements (n=292 sites) with spectrum analyzer and broadband RF antenna in three axis and the resultant was calculated according to the sum of E-field strength vector components. The area and type of the measurement sites were also classified.. The RF exposure levels, at the living area of general public were collected and evaluated according to the EU Recommendation (1999/519/EC) and ICNIRP reference levels. At the present state of data collection and evaluation, the median value of exposure in GSM band was $0.025 \text{ mikrowatt/cm}^2$ at outdoor, $0.013 \text{ mikrowatt/cm}^2$ at indoor sites respectively. Within 300 m of the base station no clear expression could be found between the exposure levels and distances similarly to other recent studies.

In the other part of the study the applicability of the RF Dosimeter (RF Personal ExpositMeter - PEM) for human exposure assessment in the real urban environment was investigated. In the present stage 21 participants were involved in the RF personal exposimetry study. All of them have residency in Budapest

(capital, 2.5 million inhabitants). The participants had to manage their time-activity diary following the form designed for the study. The time period of the survey was June-July, 2005, for 24 hours recording by each subject. The results from personal exposure showed that one third of the participants spent 40-70 % percent of 24h recording time above the detection limits (0.05 V/m) and half of subjects spent less than 10 %. The highest exposure was detected during the travelling period and the lowest in the bed at home.

ELF exposure measurements

In the ELF Range the aim of the present study was to provide systematic exposure assessment of residents living above transformer stations. Out of 41 addresses provided by the electricity supplier, current load of 21 transformers and magnetic field in 21 apartments was measured. Spot magnetic fields at 1m height and time weighted average 24-hour magnetic field exposure at bed height was measured. All day magnetic field personal exposure was measured at waist and HOME exposure was calculated. BED exposure was measured at bed height. Participants kept time-activity diary. The time weighted average 24-hour magnetic field exposure (3.03 μT) exceeded the usual residential exposure (<0.2 μT). The mean HOME and BED personal exposure above transformers was 0.825 μT and 1.033 μT , respectively. During the 24h measurements we experienced an approx. two-fold rise of the magnetic field exposure in the evening, compared to the early morning level. Spot survey measurements were performed in the morning hours, when medium-sized current loads were present. Seasonal changes in currents are expected to be low, since there are no air-conditioners in these apartments, and the central heating of the building is not based on electricity. Earlier studies emphasize the importance of 24-hour spot measurements as "gold standard" to differentiate between exposures. Because of the spatial variability of the MF (the transformer acts as a point source) choosing the right measurement location is important. We chose to perform 24-hour spot measurements at the peak MF (above the bus-bars) at bed height for comparability with bed PE and for measuring the worst case scenario. The TWA 24-hour spot MF above the bus-bars was comparable to bed PE (3.03 μT and 1.033 μT , respectively). The bed PE exceeded the home PE, due to i) the lower (bed) height of measurements at night and due to ii) the preferred location of the bed (i.e. being closer to the bus-bars). Home PE included bed exposure, and correlated statistically significantly to bed PE ($p < 0,001$). This study provides exposure assessment of a cohort with a wider exposure range, compared to power-line epidemiological studies.

RELATION BETWEEN STATIONARY AND PERSONAL MAGNETIC FIELD EXPOSURE IN THE VICINITY OF HIGH VOLTAGE TRANSMISSION LINES AS A MODEL FOR THE OCCUPATIONAL PERSONAL EXPOSURE ASSESSMENT

Gilbert Decat

Vito, Belgium

The registration of the residential as well as the stationary occupational ELF magnetic induction field (B-field) is, though it is often the worst case exposure situation, conservative. The present abstract suggests a more dynamic approach by investigating the relation between the stationary and the personal exposure (dynamic exposure). The relation between the residential and the personal exposure in the vicinity of power lines will be an optimal starting model for investigating the association between the stationary workplace and the individual exposure of the workers. The method offers the advantage that the reduction of the B-field exposure of the worker can be explained by his mobility. By knowing the relation between both variables, in the long run it should be possible to develop a simulation model to estimate the real individual exposure of the worker. The only things we have to know are the technical specifications of the occupational source.

MEASUREMENTS OF MAGNETIC FIELDS, SURROUNDING DIFFERENT ELECTRONIC ARTICLE SURVEILLANCE (EAS) SYSTEMS

Jimmy Trulsson, Gert Anger, Ulrika Estenberg

Swedish Radiation Protection Authority 171 16 Stockholm, Sweden

Background and Purpose

EAS systems are commonly used in Swedish shops and libraries. It is known that the magnetic fields around the EAS gates are nonuniform and that the field strength depends on the type of system. The purpose of this study was to measure the general public's actual exposure to magnetic fields generated by EAS systems in shops and libraries.

Method

Measurements were performed on nine EAS systems, including acousto-magnetic (AM), electromagnetic (EM), radio frequency (RF) systems and a radiofrequency identification (RFID) system. The systems were chosen to represent the most common models and brands used in Sweden and covered a frequency range of 17 Hz to 13.6 MHz. The measurements of the magnetic fields were carried out according to the CENELEC standards EN 50357 and EN 50364. The arithmetic mean of 45 measurement points, starting 20 cm from the post, should comply with ICNIRP's reference levels for general public. Measurements were also carried out closer to the EAS post.

Results

Measurements according to the standard show that the magnetic field can exceed the reference levels by a factor of 3 to 7 for the EM and AM systems, while the RF systems are well below the reference levels. For the RFID system, the exposure exceeded the reference level by a factor of 1.6, but at this frequency (13.6 MHz), the exposure should be averaged over a six-minute period according to ICNIRP's guidelines. At measurements closer to the post, starting 5 cm from the post, the mean of the 45 measurement points increased by a factor of 1.6 to 2.2. For one of the EM systems, the maximum of these 45 values exceeded the reference level by a factor of 30. The overall uncertainty for the measurements was estimated to +/-3 dB.

Conclusions

The results indicate that measurements according to the standard do not always give an accurate estimation of the exposure. The exposure can be heavily underestimated, for example when a person is leaning with its back against the EAS post. Calculated induced current densities in the human body, not only according to the standard, but also closer to the post are therefore needed to ensure that the basic restrictions are not exceeded even close to the EAS post. Waiting for these results, the Swedish Radiation Protection Authority advises the general public to avoid unnecessary exposure by simply not linger near the gate and to make sure that children do not climb on the posts. In case that the basic restrictions are not exceeded even close to the post, there should be reference levels adapted specifically for EAS exposure situations.

References

1. ICNIRP statement related to the use of security and similar devices utilizing electromagnetic fields, *Health Phys.* 87(2):187-196; 2004

Assessment of Exposure to Radio Base Stations in Korea

Byung Chan Kim, Hyung Do Choi

Radio Broadcasting Research Division, ETRI bckima@etri.re.kr

Introduction

There has been an increase in public concern about the electromagnetic field radiated from radio base stations. In order to protect people to electromagnetic fields from base stations, some organizations such as IEEE (Institute of Electrical and Electronics Engineers) and ICNIRP (International Commission on Non-Ionizing Radiation Protection) have recommended levels of exposure - basic restrictions. Especially, related to the assessment of exposure to human in far field, ICNIRP recommend the whole body averaged SAR (specific absorption rate) assessment. In the case of in situ measurement we perform generally electromagnetic field strength assessment since SAR is difficult to assess directly. In far field, the electromagnetic field wave front is assumed to be flat theoretically but due to the multi-path between radio source and investigation location the field vary spatially [1~5]. This is why we should average the acquired field strength values. The determination of the number of measurement points is very important since the mean value varies with those used in averaging process. Even though there had been many related research with averaging process, the standard method was not established so far. The purpose of this study is to derive the optimal number of points of investigation when assessing the compliance with reference levels in vicinity of base stations.

Key words: base station, exposure, basic restriction, reference level, averaging

Approach

In order to investigate the variations of mean value with the number of points we performed in situ measurement in the vicinity of 7 base stations. At each base station we had 27 position data of electric field and then calculated mean value using 6, 9, and 27 points. Fig.1 represents the positions of measurement. Because the purpose of measurement is to observe the spatial variations, we choose the distance between base station and investigation location randomly. Additionally, for the purpose of investigating the effects of environments as well, we classified the location that base stations were installed into three groups; urban, rural, sub-center. By comparing the mean value we shall determine the number of points that is necessary for averaging process.

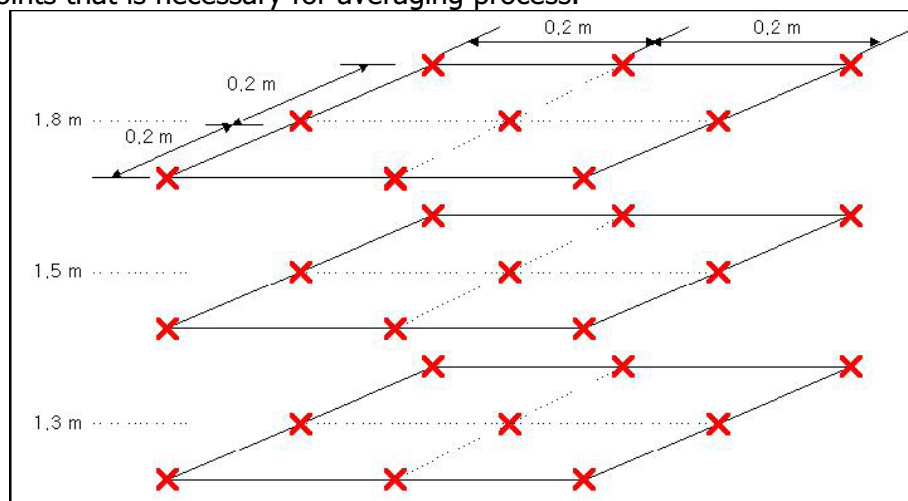

Fig.1. Electric field strength measurement positions

Evaluation

Electromagnetic field measurements of the emission from base stations have been required to demonstrate the compliance of exposure with safety limits. In this survey, we made use of an isotropic electric field probe and a spectrum analyzer package manufactured by NARDA as main receiver system and a GPS receiver to estimate the distance between base station and investigation location. The distance between base station and investigation location have the range of from 50 to 450 m. While measuring the electric field, we retained the condition of line of site (LOS), which means we can see the base station directly from investigation location. The most important spectrum analyzer setting is RBW (resolution bandwidth): 1.2 MHz. The height of receive antenna was 1.3 m, 1.5 m, and 1.8 m above ground which is nearly identical to the human's upper body size including head. We averaged the electric field over 6-minutes in RMS (root mean square) mode. Since each FA has nearly same power level we performed the measurement based on base station's FA (frequency allocation). By performing post-processing we can calculate the total electric field of the base stations. Fig 2 represents a scene of measurements and the electric field variations with position at one of 7 base stations.

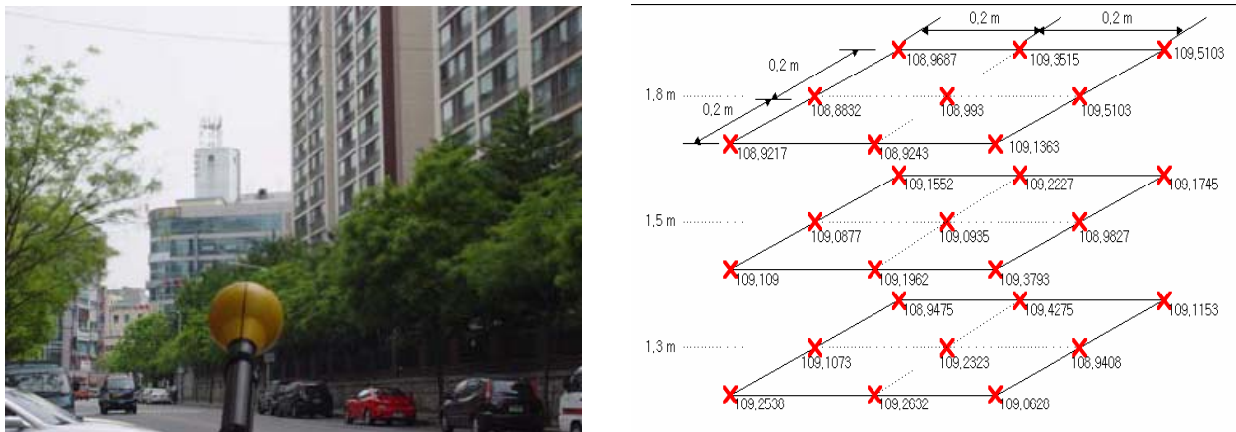

Fig.2. Picture of measurement and spatial variation of base station 1 (Location: urban/open site, unit: dBuV/m)

Summary

As we can see in Table 1 the spatial variation is larger at non-open site (NOS) than at open site (OS). The maximum variation at non-open site is 7.9502 dB (BS5) however the variation has tendency to decrease at open site, in that case, the minimum level of variation is 0.0575dB (BS2). This difference may be caused by objects around the investigation location. Reflected by the object, the electromagnetic fields undergo phase variation that causing arrival time delay at the same points. From the data shown in Table 1 we can say that it is sufficient to average three points (one point at each height) at the open site since there are little variations with position. In the other side when we are performing at the house region or non-open site we are necessary to increase the number of points which would be used in the averaging process.

Table 1 Spatial variations

		BS1	BS2	BS3	BS4	BS5	BS6	BS7
Base station Location		Urban	Subcenter	Subcenter	Subcenter	Subcenter	Rural	Rural
Measurement site		LOS, OS	LOS, OS	LOS, OS	LOS, NOS	LOS, NOS	LOS, OS	LOS, OS
Max. variation (dB, V/m)	Width	0.5326 0.0177 @ 1.8 m	0.0725 0.0220 @ 1.5 m	0.3978 0.0110 @ 1.8 m	2.4579 0.1123 @ 1.8 m	4.7576 0.004 @ 1.5 m	2.4556 0.0110 @ 1.5 m	2.9315 0.0256 @ 1.3 m
	Length	0.4272 0.0140 @ 1.8m	0.0575 0.0017 @ 1.5 m	0.2462 0.0068 @ 1.8 m	3.7914 0.1612 @ 1.8 m	3.5434 0.001 @ 1.5 m	3.2686 0.017 @ 1.8 m	1.8151 0.0206 @ 1.5m
	height	0.5605 0.0186	0.1236 0.0037	0.859 0.0232	3.5057 0.1514	7.9502 0.023	4.1372 0.021	4.5077 0.0433

In order to determine the reasonable number of points in case of non-open site (BS4 and BS5) we calculated various mean value by adjusting number of points either 6 or 9. As a result we could get the data like Table 2 where the Ave. (-) means if we go to the (-) direction we can close to the base stations

and if we go to the (+) direction the distance from base station is increasing. In Table 2 we can see the maximum mean value occur when 6 or 9 points are used in averaging process. By considering the measurements time we can select whether we use 6 or 9 points.

Table 2 Mean value with number of points (unit:V/m)

		BS4	BS5
27 points	Tot.	3.3340	0.0242
	Ave.	0.3514	0.0299
9 points	Tot. (-1)	1.1773	0.0067
	Ave.(-1)	0.3616	0.0274
	Tot. (0)	1.1095	0.0098
	Ave.(0)	0.3511	0.0331
	Tot. (+1)	1.1773	0.0067
	Ave.(+1)	0.3616	0.0274
6 points	Tot. (-1)	0.7171	0.0054
	Ave.(-1)	0.3457	0.0300
	Tot. (0)	0.7734	0.0059
	Ave.(0)	0.3590	0.0315
	Tot. (+1)	0.8827	0.0045
	Ave.(+1)	0.3835	0.0275
Number of Max. average point		6	9

Conclusion

This study described the result of measurement and spatial variation of electromagnetic field strength radiated from base stations. To acquire the exposure amount of human we performed in situ measurements and through the averaging process we calculated the mean value with different number of points. In open site averaging with three points is sufficient since there are little spatial variations. But at the house concentrated region the variations are larger than open site therefore we should increase the number of points either 6 or 9.

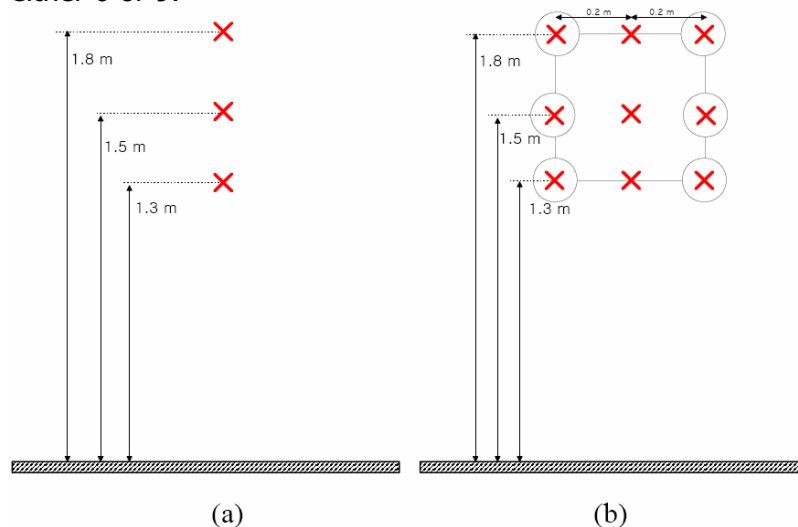

Fig 3. The measurement position at open site (a) and non-open site (b) (circles are applied when 6 points are used)

References

1. IEEE Std C95.3, "IEEE recommended practice for measurements and computations of radio frequency electromagnetic fields with respect to human exposure to such fields, 100 kHz-300 GHz," 2002
2. ITU-T K.61, Guidance to measurement and numerical prediction of electromagnetic fields for compliance with human exposure limits for telecommunication installations, " September 2003
3. EN50383, "Basic standard for the calculation and measurement of electromagnetic field strength and SAR related to human exposure from radio base stations and fixed terminal stations for wireless telecommunications system (110 MHz-40 GHz)," 2002
4. IEC61566, "Measurement of exposure to radio frequency electromagnetic fields –Field strength in the frequency range 100 kHz to 1 GHz," June 1997

INTERCOMPARISON OF HUMAN ESPOSURE ASSESSMENT IN ENVIRONMENT BY BROAD BAND MEASUREMENTS

Giovanni d'Amore

ARPA Piemonte (Regional Environmental Agency in Piemonte)

Human exposure to radiofrequency fields in environment can be assessed by different methods. Even if methods for the measurement of electromagnetic fields with reference to the human exposure were standardized in a national guideline, experimental exposure assessment by different operators in the same environment lead to great differences in results. Particularly in presence of complex field pattern due to diffraction effects, small changes in position of the measurement point or in the orientation of the triaxial survey meter have great influence on exposure assessment; Furthermore the choice of which measurement point in a given monitored area is significant for human exposure assessment represents a very critical step of the adopted procedure.

In this work are presented methods adopted in a national intercomparison, involving 14 laboratories of Regional Environmental Agencies, on human exposure assessment to EMFs by broad band meters and the obtained results

Intercomparison was organized in three steps: verification of meter response to standard electromagnetic field generated in accredited metrological laboratory of ARPA Piemonte; intercomparison of in situ measurements on multiple source, multiple frequency electromagnetic fields; analysis of the results according procedure proposed by ISO/IEC 43-1 standard.

Data analysis shows a good agreement both with compatibility index and z score tests.

EXAMPLE OF A CONFIDENCE-BUILDING-MEASURE IN BTS-SITING BY EVALUATION OF PUBLIC-EMF-EXPOSURE BEFORE SITING THE MOBILE-TELEPHONE-ANTENNAS

Eva Marsalek

PMI Plattform Mobilfunk-Initiativen, Klosterneuburg-Kierling, Austria eva.marsalek@utanet.at

Keywords: Exposure-evaluation, exposure-minimisation- and conflict-solution-strategies, base-station-siting, public health, Precautionary Principle

Due to the actual procedures in base-station-siting and the growing number of base-stations needed for the still developing mobile services, citizen-protests against base-stations are on-going and a solution to assure mobile telephony-services, public health and social peace is urgently needed.

The absence of public involvement in the planning process of BTS-siting is a major cause of grievance, fears (for good or less good reasons) and frustration in people and more and more also in local authorities, potentially also causing negative effects on people's health and well-being ref. WHO-health-definition.

So what kind of risk communication, which kind of regulations would be necessary to avoid "rien-ne-va-plus" situations and raise trust between all the involved parties: mobile phone industry, authorities, local politicians, citizens?

Since 1996/1997 a lot of different examples for conflict-solution-concepts, successfully applied in practice, have been developed and experienced on a local basis:

- Austria/Salzburg: two years – Public Relation award.
- Exposure-control with BAKOM-Swiss federal office for telecommunication, Switzerland,
- With EMC-software Quick_Plan TM of TeS, Roma, Italy and ARC Seibersdorf, Austria
- Italy
 - governments response: 6 V/m for areas where people can be more than 4 hours,
 - local agreements between providers, local politicians and citizens incl. redevelopment of existing installations (Venezia, Genova, Region of South-Tirol,...)
 - exposure-evaluation before siting the antennas (ARPA)
- Switzerland – regulation
- Germany = local agreements for exposure-minimisation-concepts (ICOM, Munich,..)
- "Freiwillige Selbstverpflichtung" of the providers
- France- and Paris-agreements (2 V/m in Paris)
- 21. 12. 2005-Israel-law, etc.

Conclusion

Even in the actual situation where

- ICNIRP-recommendations 1998 exclude protection against interferences with or effects on medical devices such as metallic prostheses,
- science is still not able to provide "certainty" as well as the absence of epidemiologic long-term-studies for BTS-situation,

an always increasing number of local agreements between all involved parties demonstrates that there are conflict-solution-strategies:

As in the past voluntary and/or non-regulatory approaches have not been successful, they have to be considered as an insufficient/unsuitable way to implement/guarantee the application of the Precautionary Principle to EMF and to avoid social conflicts.

Therefore a "best practice- exposure-evaluation-model" should become, as a "practical application" of the Precautionary Principle and confidence-building measure towards the citizens, an international established procedure for installation of mobile-communication-infrastructure.

EMF RISK FOR OPERATORS MOUNTING, ADJUSTING AND MAINTAINING BASE STATIONS

M. Israel, T. Shalamanova, L. Iliev, M. Ivanova

National Centre of Public Health Protection, Sofia, Bulgaria

In the recent years concerns whether exposure to electromagnetic fields (EMF) from base station antennae can cause adverse health effects are grown. Great attention is paid on risk of EMF exposure to people living in a close proximity of base stations. In this issue, a point of interest is the personnel mounting, adjusting and maintaining base stations. Their working tasks require stay in high EMF levels' conditions.

There are few studies concerning this specific occupational group. The results from our previous investigation (COST 281 – Graz, 2006) show that in many cases on performing some specific tasks operators are overexposed according to our national legislation, and ICNIRP guidelines.

Here, we present an extended study covering more base stations and more precise scenario for performed tasks and working positions. Results of exposure assessment are presented. They include energetic load calculations on the basis of Bulgarian national legislation, and the corresponding SAR values. Data are used to determine permissible time duration for each particular work operation and served as a base for limiting the exposure and proposal for protective measures for the personnel.

RF ELECTROMAGNETIC FIELDS MEASUREMENTS IN GREECE

E. Karabetsos, G. Filippopoulos, D. Koutounidis CH. Govari, N. Skamnakis

Non ionizing radiation office, Greek atomic energy commission, P. O. BOX 60092, 15310 Agia Paraskevi, Greece

Abstract

The Greek Atomic Energy Commission (EEAE) is the competent national authority for the protection of the general public and the environment from artificially produced non-ionizing radiation. To this end, EEAE carries out measurements in the vicinity of all kinds of sources emitting RF electromagnetic fields (e.g. audio, radio and television antennas, mobile phone base stations, radar and satellite earth stations and other microwave communication systems), in order to monitor whether the general public exposure limits are being adhered to. The safety limits in Greek legislation for the electromagnetic fields emitted by antenna stations, were recently set to 70% of the ICNIRP's values and to 60% of them if the antenna station is closer than 300m from the perimeter of kindergartens, schools, hospitals or eldercare facilities. There are a few exceptional cases where measurements of RF fields conducted by EEAE in the vicinity of radio and TV broadcasting antennas have revealed excess of ICNIRP's reference levels. The results of one such case are presented. About 70% of the RF measurements conducted by EEAE concern cellular phone base stations. EEAE has conducted measurements in the vicinity of 1200 such stations and virtually in all measurements the results are from tens to thousands times below ICNIRP's reference levels for general public protection.

Introduction

The proliferation of wireless communication technologies caused a radical change on the modern society. In Greece the penetration of cell phones is about 80% that is close to the average of the developed world. At the same time there is an increasing concern among people residing nearby cell phone base stations about adverse health effects caused by the presence of the station.

In order to protect against known effects of the exposure to electromagnetic fields, competent committees as ICNIRP have developed exposure guidelines, [1]. In the recommendation, [2], issued in 1999, the EU Council adopted ICNIRP's guidelines for the protection of the general public. Implementing this recommendation, Greece put into force a national legislative act concerning the protection of the public from exposure to electromagnetic fields emitted by all kinds of land-based antenna stations, [3] in 2000. The limits in Greek legislation were set to 80% of the European Recommendation values. Recently, however, the Greek Parliament has voted the Law [4] setting the Greek limit values at 70% of the European Recommendation values, in general, and 60% of them, if the antenna station is closer than 300m from kindergartens, schools, hospitals or elder-care facilities.

The competent national authority for the protection of the general public and the environment from artificially produced non-ionizing radiation in Greece is the Greek Atomic Energy Commission (EEAE). To this end, the EEAE carries out measurements in the vicinity of all kinds of facilities emitting RF electromagnetic fields (e.g. audio, radio and television antennas, mobile phone base stations, radar and satellite earth stations and other microwave communication systems), in order to monitor whether the general public exposure limits are being adhered to. The EEAE has been accredited in accordance with the requirements of the EN ISO/IEC 17025 standard for performing this kind of measurements. Figure 1 shows the number of annual audits conducted by the Non Ionizing Radiation Office of EEAE regarding RF sources. There is an incremental tendency in these measurements reflecting the increasing interest for them.

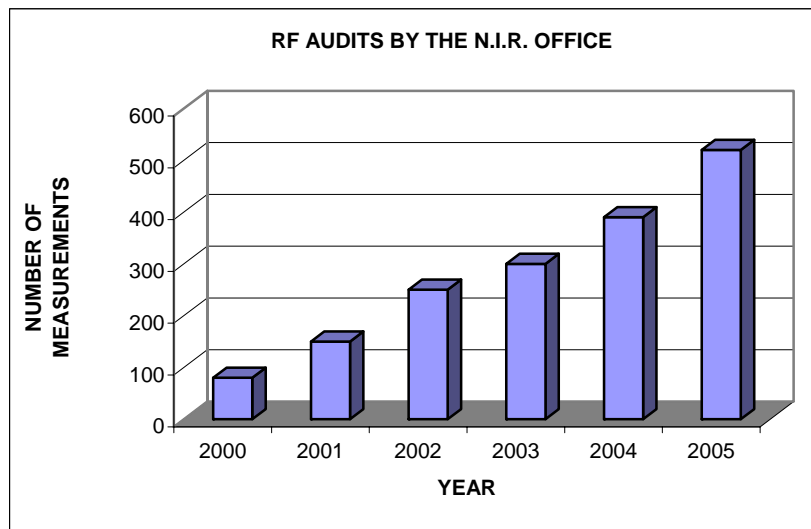

Fig. 1. Annual audits conducted by the Non Ionizing Radiation office of EEAE concerning RF sources.

In the next paragraphs results of measurements conducted by EEAE in the vicinity of the most common types of antenna stations are presented. Though the use of mobile phones is the major source of exposure to RF electromagnetic fields, mobile phones are not treated in this paper. That is because the measurements conducted by EEAE generally concern fixed antenna stations as mobile phone base stations, radio and TV broadcasting stations radar and satellite earth stations and other microwave communication systems. The purpose of these measurements is to check compliance with the limits set in the Greek legislation. Figure 2 shows the percentage of the measurements conducted in the vicinity of mobile phone base stations, radio and TV broadcasting antennas as well as radar facilities. The majority of measurements concern mobile phone base stations. This big ratio is due to the constantly increasing relevant requests from municipal authorities, individual citizens and even the mobile phone network operators.

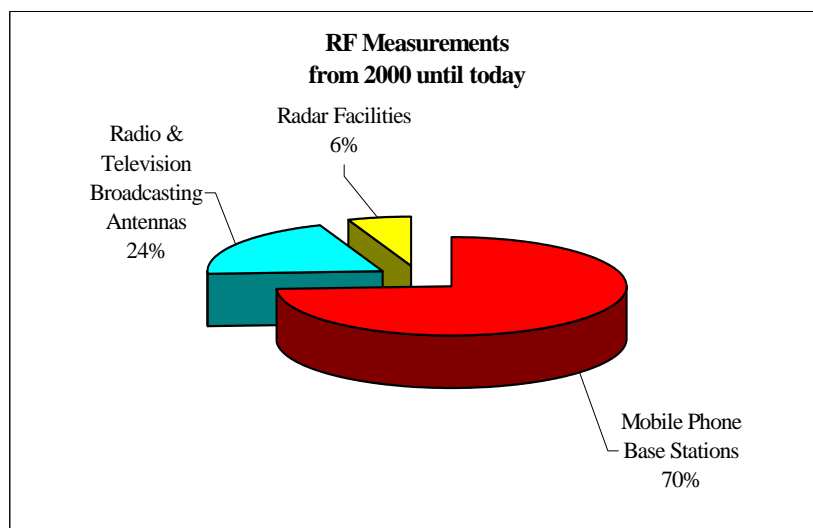

Fig. 2. Percentage of the measurements conducted by EEAE regarding mobile phone base stations, radio and TV broadcasting antennas and radar facilities.

Mobile phone base stations

Mobile phone base station antennas in Greece are, as everywhere else, placed either on top of large metal pylons (in rural places) or on poles on top of buildings (in urban areas). Nowadays, it is also common to find micro antennas in the interior of big buildings such as airports, metro stations, stadiums, etc, where a lot of people are assembled. Throughout the country there are about 6000 base

stations installed until now, including the new UMTS stations. The EEAE has conducted measurements in the vicinity of almost 1250 such stations and practically in all cases the results were found to be from tens to thousands times below ICNIRP's reference levels for general public exposure. Table 1 shows typical maximum levels of the electromagnetic fields measured in the vicinity of mobile phone base stations in Greece. It is noted that these values refer to the maximum value at worst-case selected areas in the vicinity of the base station. These areas are usually on the roofs of nearby tall buildings in the main lobe directions of the base station's antennas. The levels of the electromagnetic fields caused by these stations at areas where people normally dwell or work are, as a rule, much lower.

		Electric field (V/m)	Magnetic field (A/m)	Equiv. Power Density (W/m ²)
Typical maximum values		0.25 – 5	0.0005 – 0.01	0.0002 – 0.05
Reference levels for GSM-900*	70%	34.5	0.0929	3.1
	60%	31.9	0.0860	2.7
Reference levels for GSM-1800*	70%	48.8	0.1313	6.3
	60%	45.2	0.1216	5.4
Reference levels for UMTS* (2100MHz)	70%	51	0.1339	7
	60%	47.2	0.1239	6

* The Greek limits are set to 70% of ICNIRP's values for the electromagnetic fields in the vicinity of antenna systems further than 300m from the perimeter of day nurseries, schools, hospitals or elder-care facilities and to 60% of ICNIRP's values closer than 300m from these facilities. The Greek reference levels are calculated from corresponding basic restrictions set to 70% and 60% per case of ICNIRP's basic restrictions.

Table 1. Typical maximum values of electromagnetic radiation in the vicinity of mobile phone base stations and the reference levels imposed by the Greek legislation for the frequencies used in mobile phone systems.

Radio and TV broadcast stations

In many cases, a great number of powerful radio and TV broadcasting installations have been assembled in one place forming an antenna park. In some of these places, measurements conducted by EEAE have revealed excess of ICNIRP's reference levels. Usually, the excess is limited a few meters away from the antenna installations. In a specific and exceptional case, the side lobe of a powerful installation in an antenna park near Herakleion, Crete Island radiates a nearby, elevated area where an army camp is situated, causing excess of ICNIRP's reference levels in almost half of the camp (see figure 3).

EEAE was called upon to examine the levels of the electromagnetic radiation caused by this antenna park. The measurements performed by EEAE revealed levels of electromagnetic fields much in excess of Greek reference levels (and ICNIRP reference levels as well). After that, the area where the excess occurs was defined and special signs were temporally set in order to warn the personnel of the high EMF levels, until the competent authorities take all the appropriate remedial actions. Figure 3 indicates the area where the electromagnetic fields exceed the Greek reference levels and the points where measurements have been taken. Besides measuring the levels of the electromagnetic fields spectral analyses were also performed in order to specify the contribution of each source to the measured levels. Figures 4 and 5 show the results of spectral analyses per service and per FM radio station, respectively, conducted at point M1 (a typical point). These analyses revealed that the major contribution at the measured fields came from FM radio stations and particularly from a single radio station operating at 97.5MHz.



Fig 3. A sketch of the camp and the surrounding area showing the points of measurement (M1- 12) and the area in red where the RF radiation exceeds the Greek reference levels. The photo shows the radio station antenna causing the high radiation levels.

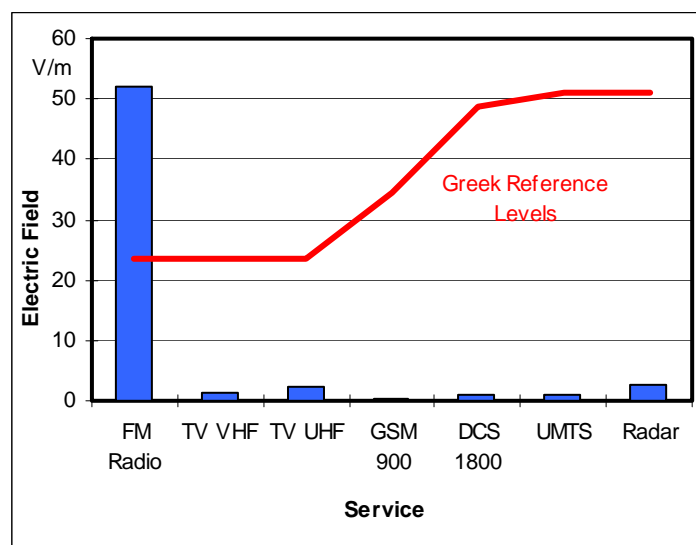

Fig. 4. Spectral analysis per service for the electromagnetic radiation at point M1.

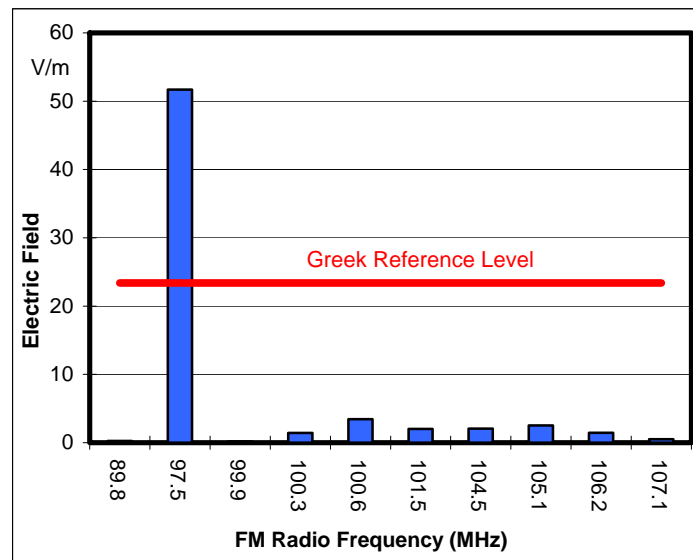

Fig. 5. Spectral analysis per FM radio station for the electromagnetic radiation at point M1.

Radar Stations

EEAE has also conducted measurements in the vicinity of radar installations. Despite the powerful emitted pulses the exposure in the vicinity of these installations is in general some hundreds to thousand times lower than ICNIRP's reference values for general public protection. It is noteworthy that the measurement process in these cases is much more difficult and time requiring because the instrument's response to pulsed modulated fields has to be taken into account and the peak and average exposure has to be calculated.

Conclusions

EEAE carries out measurements in the vicinity of all devices emitting RF electromagnetic fields throughout Greece in order to check compliance with the limits imposed by the Greek Legislation. To that end over one and a half thousand audits have been performed. It is noted that the Greek limits were recently set to 70% of ICNIRP's values in general, and 60% of ICNIRP's values for exposure caused by antenna station at a distance lower than 300m from the perimeter of day nurseries, schools, hospitals or elder-care facilities.

The results of RF electromagnetic field measurements show that there might be cases where powerful radio or TV broadcasting antennas cause levels of these fields greater than the established reference values for human exposure, if proper care were not shown during their design and installation phases. Regarding the electromagnetic field levels in the vicinity of mobile phone base stations, the measurements conducted by EEAE show that the maximum values of electromagnetic fields are typically hundreds to thousand times lower than ICNIRP's reference levels.

References

1. International Commission on Non Ionizing Radiation Protection (ICNIRP), Guidelines for limiting exposure to time – varying electric, magnetic and electromagnetic fields (up to 300 GHz), Health Physics, Vol. 74, No 4, April 1998, pp 494 – 522.
2. European Union Council Recommendation of 12th July 1999 on the limitation of exposure of the general public to electromagnetic fields (0Hz to 300 GHz) (1999/519/EC).
3. Greek legislation: Common Ministerial Decision, Protection measures for the exposure of the general public to all land based antenna stations, Act No.1105/Vol. B/6-9-2000.
4. Greek legislation: Law No 3431 About electronic communications and other provisions, Act No.13/A/03-02-2006.

PRIMARY AND SECONDARY EMF STANDARDS – ACTIVITIES AND EXPERIENCES IN CALIBRATING EMF METERS

Pawel Bienkowski, Hubert Trzaska

EM Environment Protection Lab., Technical University of Wroclaw, Poland pawel.bienkowski@pwr.wroc.pl
www.lwimp.pwr.wroc.pl

Abstract

The paper presents activities The EM Environment Protection Lab of Institute of Telecommunication, Teleinformatics and Acoustics, Technical University of Wroclaw in the field of wide understood EMF metrology, especially in EMF (electromagnetic field) standards.

Introduction

For years the EM Environment Protection Lab (EMEPL) and its accredited laboratory LWIMP is involved in EMF measurements, especially for labor safety and environment protection purposes. Here was written the first book devoted to the issues [1]. Experimental activities in the field require an EMF that parameters are well known - standard EMF. It has caused our involvement in the area of primary and secondary EMF standards in some sense a "by-product". Apart from application of many typical approaches the involvement has lead the Lab to several new concepts and solutions.

As examples of the Lab activities in the paper are presented among others:

- uncertainty analysis of directional antennas calibration on an OATS;
- E-field by H-field, a proposal especially useful while whip antennas at low frequencies are being calibrated;
- development of the double calibration method;
- the role of spectral purity of the standard;
- a proposal of new exposure system that reflects simultaneously exposure to LF and HF fields while a cellular phone is used;
- "trinary" EMF standard – basic exposure system for daily checking EMF measurements equipment.

Directional antenna calibration

Some doubts were formulated in the literature as regards as a possibility to calibrate directional antennas on an OATS (Open Area Test Site). The problem was analyzed on the ground of a logo-periodic (LP) antenna calibrated on an OATS [2] in geometry of propagation as shown in Fig 1. Radiation pattern of the LP antenna was approximated in analytical form in order to make it possible a presentation of closed-form formulas.

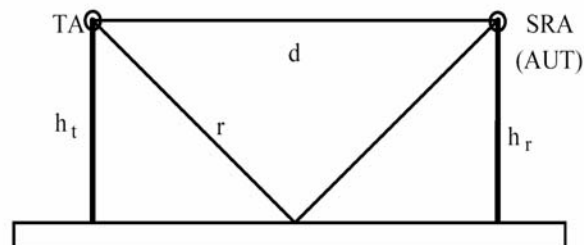

Fig.1 Geometry of propagation on an OATS

The use of SRA (substitution) method was here suggested. The analyses were performed for two cases, i.e.: while the transmitting antenna (TA) was a dipole and while identical LP as the calibrated one. The uncertainty of the method is shown in Fig.2 as a function of distance between antennas. It is directly connected with angle of reflected ray. Continuous line expresses the uncertainty in the first case while dashed the latter.

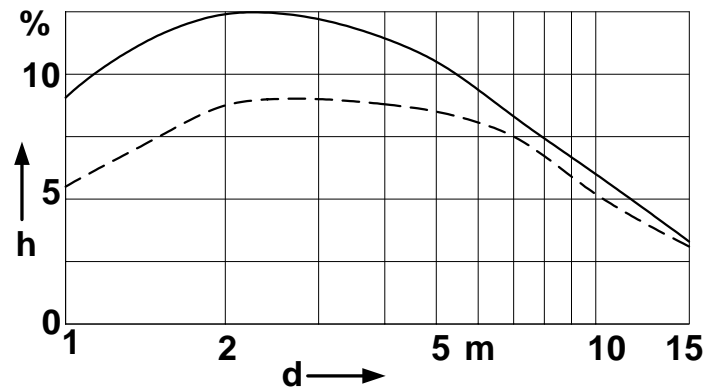

Fig.2 Uncertainty of the method versus separation

The considerations were performed for LP antenna; however, the method is valid for analysis of the calibration procedure uncertainty in the case of any other antenna type. The curves in Fig. 2 were obtained in pure theoretical way. Their correction is possible if use measured radiation pattern of the directional antenna instead of that approximated in analytical form. Of course, if the calibration is performed in an anechoic chamber the error discussed vanishes as does not exist a reflected ray. It is place here to remind that with no regard to fully correct (within frames of the analysis) calibration of directional antennas, their application in real environment requires appropriate experience.

Other new proposals of the calibration methods include: magnetic field probes calibration in wide frequency range in a traveling wave device, sets for calibration E- and H-field probes in conditions of arbitrarily polarized EMF, i.e.: the sets make it possible to generate linearly, circularly, elliptically, spherically and ellipsoidal polarized fields.

E-field by H-field in whip antennas calibration

EMF meters with whip antennas usually are used for the electric field measurement at frequencies, say below 30 MHz in the far field. Till now these antennas were calibrated on an OATS in the standard EMF generated by another whip antenna. The method is very sensitive to presence of reflections, requires quite large and uniform space (the OATS) and, especially at the lowest frequencies, creates problems with matching the capacitive whip to a source of its excitation. All the disadvantages of the method disappear while in the role of the standard transmitting antenna a loop is applied instead of the whip [3]. Apart of the advantages mentioned the standard is simultaneously the electric- and the magnetic field standard and formulas for both the field components are almost identical. An example of the test set for symmetrical dipole calibration is shown in Fig.3.

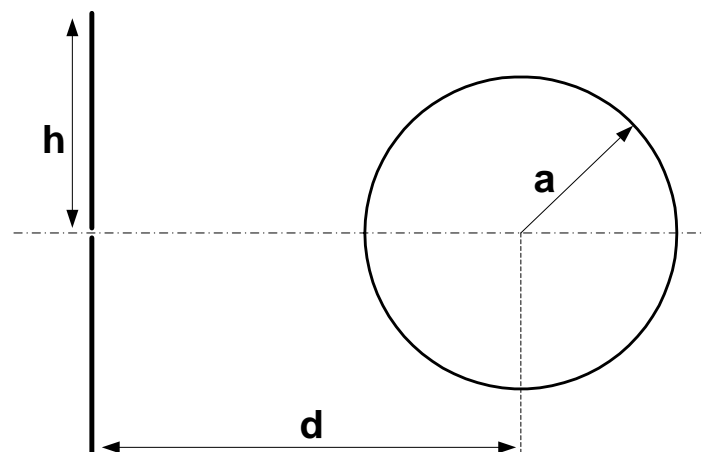

Fig.3. A dipole antenna calibration with a standard loop.

E-field in the plane of the loop, averaged at the standardized antenna, is given by:

$$E = \frac{\pi a^2 Z_0 I}{2 \lambda d D} \sqrt{1 + k^2 D^2} \quad (1)$$

where: $D = \sqrt{d^2 + a^2 + h^2}$

I - current in the loop,
other indications as in Fig.3

To remind; the magnetic field in similar set is given by:

$$H = \frac{60 \pi a^2 I}{Z_0 D^3} \sqrt{1 + k^2 D^2} \quad (2)$$

Both the formulas were introduced with similar assumptions as regards as the accuracy of the field (2-nd order approximation).

Double calibration method

On the ground of the above solution we'll demonstrate an idea of the double standardized field (Fig.4).

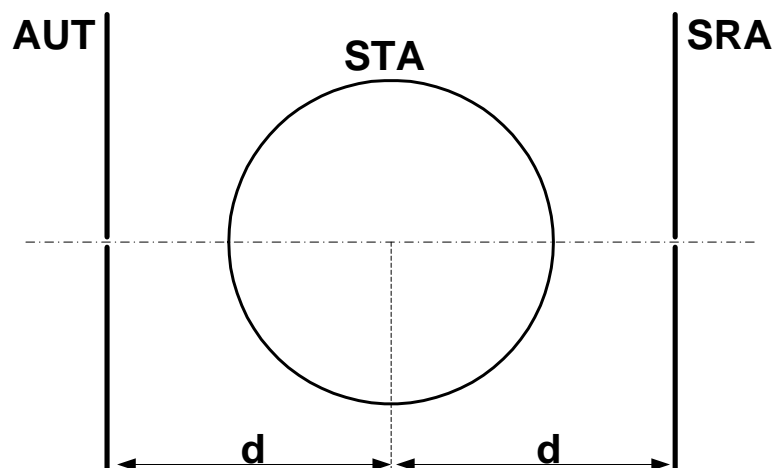

Fig.4. Double standardized EMF

The idea of the concept is based upon a simultaneous use of the standard EMF method (the standard transmitting antenna) and the standard antenna method (the standard receiving antenna). A standard transmitting antenna (STA) is placed at the same distance (d) between a standardized antenna (AUT) and the standard receiving antenna (SRA). The approach was in use in the case of a dipole-, loop-, and whip antennas calibration. Its use makes it possible to increase calibration accuracy and, what is of primary importance in calibration procedures, assures a measuring team that a gross error does not appear while the calibration is performed. Fig.5 presents H-field doubly standardized sets used in the EMEPL.

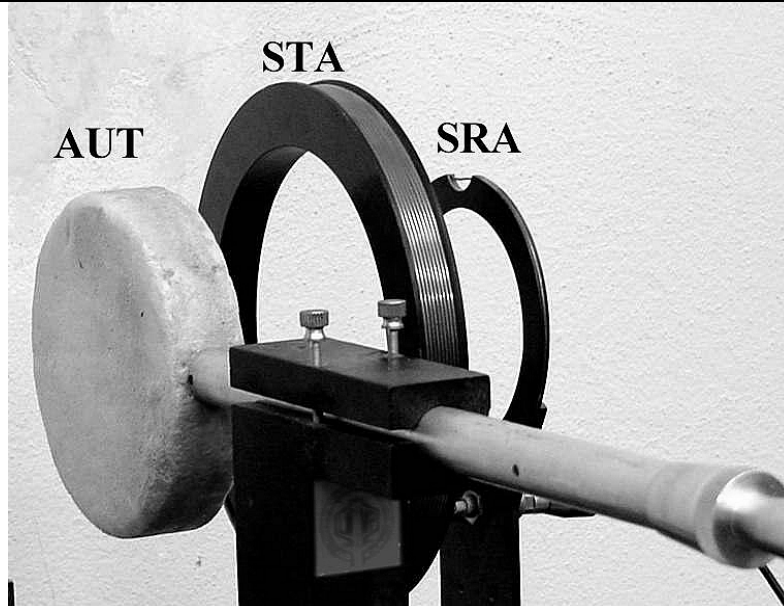

Fig.5. EMEPL H-field standard.

Spectral purity of the standard

The role of the spectral purity of the standard exciting source has never been analyzed before. It is usually assumed that the source is 'ideal' in this aspect. It is not true, especially in the case of power generators and power amplifiers as well as while generators with frequency synthesis are in use. Their spectral purity is often unknown. Sometimes, especially in nontechnical labs, due to attempts to increase the output power of the generators, the purity of their spectrum may be remarkably reduced. A similar story is when a microwave oven plays a role of the exciting generator. As a result, the accuracy of the standard (exposure system) may be remarkably degraded. An analysis shows that the most intensive degradation takes place in the case of wideband magnetic field probes calibration. The reduction of the standard's accuracy in this case may exceed the clear factor of the exciting signal. A method to reduce this problem is the use of resonant H-field standards, based upon the serious resonance of the standard loop antenna. This allows Q-times higher intensity of the generated H-field compared to a nonresonant antenna (and at nonresonance frequencies). The method is especially useful for H-field probe calibration that does not require a high power source, but we must remember that in resonance standards, both magnetic and electric EMF components appear. It is important in the case when, for example, an H-field probe is sensitive to the E-field.

Exposure system in biomedical investigation

Standard field sets are usually used in biomedical investigation of the interaction between EMF and living organisms. Typical systems range in frequency from static fields to microwaves. Within low frequencies, it is possible to make a clear distinction between EMF components generated in the exposure systems. The sources of the magnetic field are usually coils in different configurations (e.g., single loop antenna or Helmholtz coils). The sources of the electric field are plate condensers. For radio waves (up to a few hundred MHz), exposure systems with whip antennas and segments of transmission lines – especially TEM cells – are used. In the microwave range, aperture antennas and waveguides are usually used as basic sources of EMF. Simple exposure systems are not always able to reproduce work conditions of EMF sources generating complex fields. A simple example of such a source is a cellular phone or handheld terminal, which are sources of radio frequency (RF) and low frequency magnetic fields [4]. RF fields are produced by the terminal's antenna as a useful signal. Magnetic fields in the proximity of a handheld terminal appear because of current flowing from the battery to the RF power amplifier. The battery is typically located at the bottom of the terminal and the power amplifier at the top, whereby the supply current flows from the bottom to the top of the phone. A proposed new exposure system allows exposing an object simultaneously to RF EMF and LF H-field equivalent to the modulation standard. It makes possible the checking of the role presented by the H-field phenomenon in the total influence between

EMF and biological object. The main idea of proposed "animal" system is showed at Fig.6 [5]. This is typical RF "wheel" exposure system with additional block to generate magnetic field. It consists of power amplifier loaded by loop antenna. Input signal of amplifier is generated by RF envelope detector. In this case H-field is proportional to RF power and corresponds with envelope of RF signal. Particularly for GSM it is pulsed magnetic field with repetition frequency 217 Hz (Fig.7).

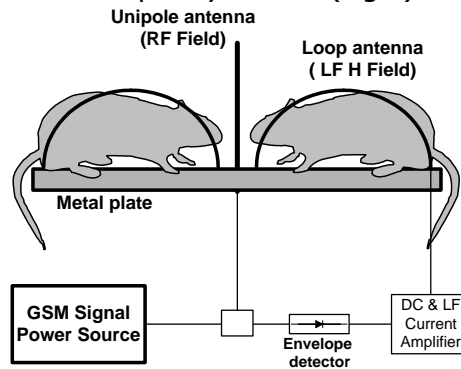

Fig.6. "Animal" GSM-like exposure system

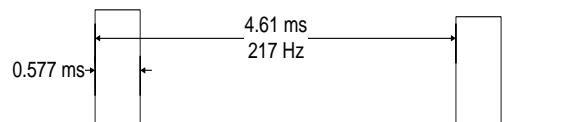

Fig.7. Envelope of GSM Trx amplitude modulated signal

In "human" model for experiments with voluntaries as an exposure setup may be used model of mobile phone with typical GSM antenna and loop connected to DC & LF amplifier (Fig. 8)

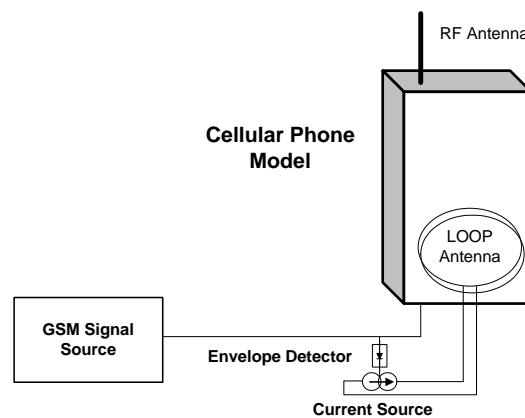

Fig.8. "Human" GSM-like exposure system

"Trinary" EMF standards

The special standard sets designed in EMEPL are "trinary", portable standard that allow daily checking EMF probes. The first USMEH were designed thirty years ago, but there are in use to today. USMEH is able to check only two basic probes: one for E-field and one for H-field. The new one – UTEST is designed for checking E- and H-field probes as well as S-ones at selected frequencies in four frequency ranges: ELF, VLF, RF and MW (microwave). The probes are "one point" tested in stable conditions. Of course using of "trinary" standards can't replace full calibration, but it is very useful for accreditation testing laboratories, which make measurements in environment and work places and has to checking meters just before and just after the measurements. Presented models are mechanically dedicated for EMF meter MEH with probes (designed and produced in EMEPL and very popular in Poland EMF measurement system). There are possibilities to mechanically adapt for any meters, eg. PMM, Holaday or Narda.

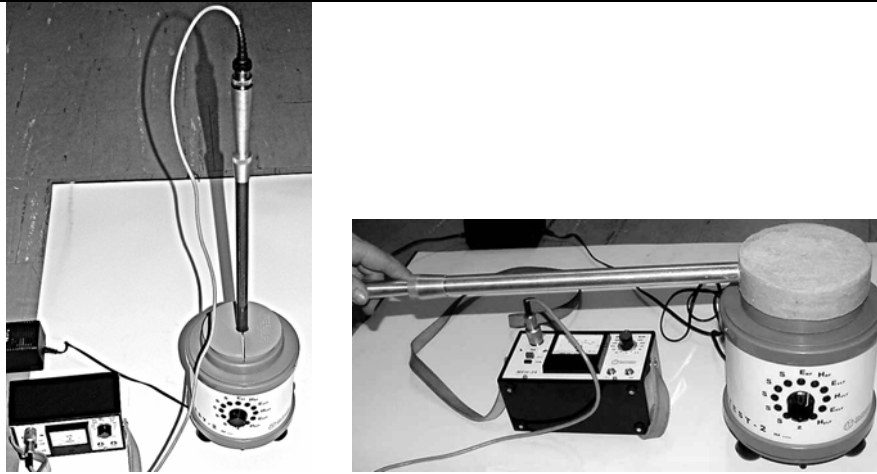

Fig.9. UTEST-2 – "trinary" portable EMF standard

Summary

Presented above activities of EMEPL are only examples of our work. Any our activities are a customer-oriented ones and, usually, our theoretical studies and practical solutions are modified along with the customer requirements. Several examples:

- The use of resonant antennas makes indoor measurements impossible. A special solution of small-size, active antennas for the measurements in wide frequency range were worked out and applied in practice. It has allowed precise studies of the environment for the National Sanitary Inspection purposes and it has radically changed our opinions upon the EM smog.
- Probes, meters and antennas calibration is our permanent offer as well as EMF measurements in the conditions while other labs are unable to perform or/and interpretate them.
- Some times we are the "anchor sheet" for many miserable that feel intentionally or unintentionally attacked by a real or an imaginary aggressor. This activity, in the majority of cases, is done on unpaid basis as a form of our service to the society. Such help has never been offered by official institutions.

References

1. H. Trzaska, Electromagnetic Field Measurements in the Near Field, Noble Publ. Corp. 2001.
2. H. Trzaska, "Calibration of Directional Antennas and Their Use". IEEE Trans. vol. IM, Oct.2000, pp.1112-1116.
3. H. Trzaska, "Low-frequency E-field standard". Proc.1994 Intl. EMC Symp. Wroclaw, pp.202-205.
4. H. Trzaska, "Radiation from a portable terminal". Asia-Pacific Conference on Environmental Electromagnetics. CEEM '2003. Proceedings, China, Nov. 4-7, 2003. pp. 111-114.
5. P. Bieńkowski "The new GSM-like exposure system". Electromagnetic Compatibility 2004. Seventeenth International Wroclaw Symposium and Exhibition, Wroclaw, Poland, June 29-July 1 2004, pp. 74-75

ELF ELECTRIC AND MAGNETIC FIELDS MEASUREMENTS IN GREECE

E. Karabetsos, G. Filippopoulos, D. Koutounidis CH. Govari, N. Skamnakis

Non ionizing radiation office, Greek atomic energy commission, P. O. BOX 60092, 15310 Agia Paraskevi, Greece

Abstract

The Greek Atomic Energy Commission (EEAE) is the competent national authority for the protection of the general public and the environment from artificially produced non-ionizing radiation. To this end, EEAE carries out measurements in the vicinity of all kinds of sources emitting ELF electric and magnetic fields (e.g. power lines and substations), in order to monitor whether the general public exposure limits are being adhered to. The limit values for the ELF fields in Greece are set exactly the same as those in ICNIRP's guidelines. EEAE has conducted many measurements regarding the levels of ELF electric and magnetic fields in Greece around the elements of the electric power grid where the main interest of the public is focused. Theoretical estimations and typical values based on actual measurements of the fields in the vicinity of all the power lines used in Greece are presented. Measurement results in the vicinity of substations are also presented. In general, the levels of the magnetic field in the vicinity of the power grid elements are well below the established limits; whereas the levels of the electric field may reach values comparable to the safety limits very close to extremely high voltage lines. However, there is no case where the measured values of electric or magnetic fields were higher than the safety limits.

Introduction

Extremely low frequency or ELF electric and magnetic fields are omnipresent in modern societies. The possibility that long-term exposure to these fields might cause adverse health effects is a source for concern, especially for those people residing or working nearby high voltage lines or substations. Competent international scientific committees are watching the scientific developments in order to reach general conclusions about the health effects of these fields, [1].

In 2002, Greece put into force a legislative act, [2], implementing the recommendation, [3], of the Council of the European Union, adopting ICNIRP's limit values, [4], for the protection of the general public. The competent national authority for the protection of the general public and the environment from artificially produced non-ionizing radiation in Greece is the Greek Atomic Energy Commission (EEAE). To this end, the EEAE carries out measurements in the vicinity of all kinds of facilities emitting ELF electric and magnetic fields (e.g. power lines, high voltage substations) in order to monitor whether the general public exposure limits are being adhered to. The EEAE has been accredited in accordance with the requirements of the EN ISO/IEC 17025 standard for performing this kind of measurements. Figure 1 shows the number of annual audits conducted by the Non Ionizing Radiation Office of EEAE in the vicinity of ELF sources. There is an incremental tendency in these measurements reflecting the increasing interest for them.

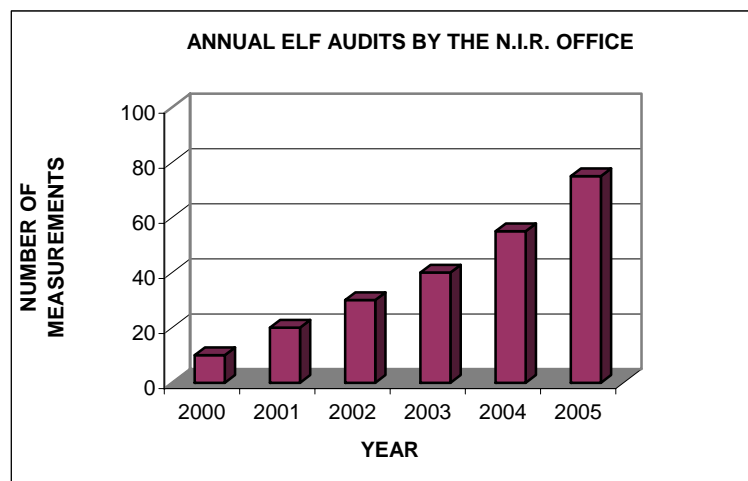

Fig. 1. Annual audits conducted by the Non Ionizing Radiation office of EEAE concerning ELF sources.

In the next paragraphs the main sources of ELF electric and magnetic field exposure of the general public are presented. Domestic sources as the electrical appliances, internal wiring and currents on large grounded metallic objects as water pipes, drains and rails are presented. Also, the exposure resulted from the electric power transmission and distribution system is examined. Special emphasis is given to the situation in Greece and its particularities in relation to other parts of the world. That is because the levels of the electric and magnetic fields are to an important extent depending on the practices applied at electrical installations and on the electric power grid construction and operation, which might be quite different from country to country, [5].

Domestic Sources

In domestic environments the most common sources of ELF fields are the electric appliances, the internal wiring as well as the currents in large grounded objects as water pipes, drains and rails. These sources mainly create magnetic fields in their vicinity, because the created electric field is small due to the low voltage and is further attenuated by closures, walls etc.

The magnetic fields produced by appliances are rapidly attenuated with increasing distance from them and are noteworthy at distances much lower than 1 meter. The field at the surface of the appliance might be very strong, reaching values of hundreds μT . However, in most practical cases the human exposure takes place at much greater distances. Exceptions to this are devices that require their operator to be in close vicinity as electric shavers and hair driers. However, these devices are usually used for short time-periods each day and so the exposure of their operators is limited. Furthermore, exposure from these devices is locally focused in a small area of the body and the coupling of the field with the human body is weak. Taking into account these special exposure situations it is rather impossible that exposure from these sources might be capable to stimulate the neural or muscle cells.

The internal electrical wiring usually does not create important magnetic field levels in its vicinity. The involved practices applied at the construction of these installations are described in the electrical safety codes for the avoidance of the electrocution and other dangers. According to the safety code in Greece, [6], but also in many other parts of the world, the currents at the internal wirings create magnetic fields that at a great extent cancel each other. However, in the rare cases of installations not complying with the terms of the safety code, it is possible to find unusually strong magnetic fields, due to faulty connections or leakage currents. The existence of strong magnetic fields from the internal wiring might be an indication of an installation not complying with electrical safety codes and even hiding risks for electrocution or other dangers (as initiation of a fire).

It is noteworthy that in Greece the main supply is 50Hz and 220V ac voltage (as in the rest of Europe). That means that the currents used in electric appliances and the magnetic fields associated with them are roughly half of those that are used in other parts of the world (as the North America) where 110V are used. Furthermore the 50Hz magnetic fields in Europe induce 20% less internal fields and currents in the body of an exposed individual in relation to the 60Hz used in North America.

Another important source of domestic ELF magnetic fields might be the existence of ground currents at large grounded objects as water pipes, drains and rails. These currents create elevated levels of background magnetic fields, i.e. fields that decay relatively slowly with the distance from their source. These currents are actually a portion of the returning currents normally located at the neutral conductor. However, the multiple ground connections of the neutral conductor allow alternative paths for the flow of the returning currents back to the power grid through large grounded metallic objects as water pipes, figure 2. Ground currents typically flow if there is a fault on the power system or they can be a normal condition, if there are many connections of the neutral conductor to the ground. However, the use of non-conductive parts at the water supply system significantly reduces the levels of the return currents.

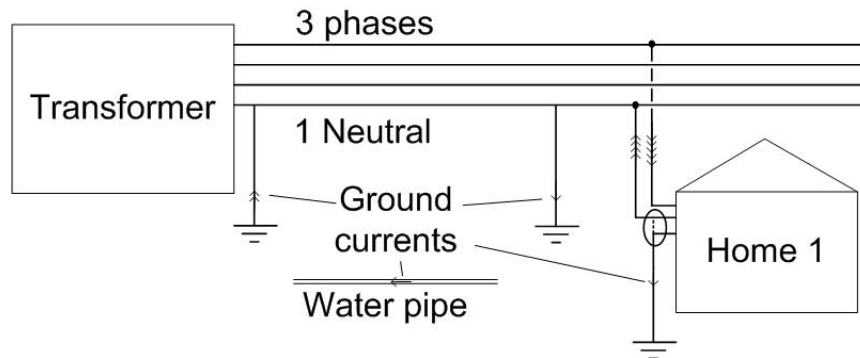

Fig. 2. Mechanisms for the creation of ground return currents. The connection of the neutral conductor with the protective earth (ground) at the beginning of each consumer installation is either prohibited or imperative in Greece, depending on the geographic area.

Electric power distribution

The electric power distribution network is consisted of the low and medium voltage network used for the delivery of the electric power as well as the medium to low voltage substations. In Greece the low voltage is at the nominal level of 220/380V. The medium voltage is at various nominal levels but the last years it is being standardized to 20kV.

The low voltage network is the final piece of the electric network used for the delivery of the electric power at home level. This network consists of overhead and underground lines. These lines create mainly magnetic fields in their vicinity. The created magnetic fields may reach values up to a few μT close to the conductors and attenuate at much lower levels a few meters away from the lines. However, the low voltage loads are usually not well balanced on the three phases of the system and that causes the appearance of currents on the line neutral conductor. A portion of this current might flow on large grounded metallic objects in the vicinity of the line but in special circumstances also far from it, with the results described in the previous paragraph. That also means that there is a net current on the line producing magnetic fields that decay relatively slow with the distance from it.

The medium voltage network is used for the power supply of the substations feeding the low voltage network as well as for the immediate supply of large consumers. The voltage in this network is many times higher than that in low voltage network and so the currents are many times lower for the same amount of transferred power. Table 1 includes typical EMF values found in the vicinity of medium voltage lines in Greece.

Arrangement		Magnetic field (μT)	Electric field (V/m)
400 kV lines	Worst-case scenario	25	5000
	Typical (underneath the conductors)	1 – 4	2000 – 4000
	Typical (25m aside from line)	0.5 – 2	200 – 500
150 kV lines with lattice towers	Worst case scenario	15	2000
	Typical (underneath the conductors)	0.5 – 2	1000 – 2000
	Typical (25m aside from line)	0.1 – 0.2	100 – 300
150 kV compact lines on poles	Worst case scenario	10	1200
	Typical (underneath the conductors)	0.3 – 1.5	500 – 1000
	Typical (25m aside from line)	0.05 – 0.2	50 – 100
150 kV underground cables	Worst case scenario	20	-
	Typical (above the cable)	3 – 6	-
	Typical (25m aside from cable)	< 0,01	-
20 kV overhead lines (medium voltage network)	Worst case scenario	5	700
	Typical (underneath the conductors)	0.2 – 0.5	50 – 200
	Typical (25m aside from line)	0.01 – 0.05	10 – 20

Table 1. Electric and magnetic field levels at the vicinity of the power lines used in Greece. The values refer at a distance of 2m above ground level in the vicinity of overhead lines and at ground surface in the vicinity of underground cables.

It is noteworthy that the medium voltage lines do not suffer from the unbalances mentioned for low voltage lines, because the medium voltage loads are usually well balanced and the medium to low voltage substations act as barriers not allowing the low voltage unbalance to pass on the medium voltage side.

The medium to low voltage substations are usually sources of public concern. The attention is mistakenly focused on the transformer, which is used for power transmission from one voltage level to another. However, the transformer itself is not producing any significant levels of electric and magnetic fields in its vicinity. It is the medium and low voltage conductors connected to the transformer that create the electric and magnetic fields. Typically, the medium voltage equipment is the dominant source of the electric fields and the low voltage one is the dominant source for the magnetic fields close to a substation. The electric and magnetic fields produced by these substations does not extent further than a few meters from it. However, the current on the low voltage lines, which are fed by the substation, is higher close to the substation than far from it, as the electric power is dispatched to the various consumers along the line's way.

Electric power transmission

High and extremely high voltage lines are used to carry vast amounts of electric power. In Greece the main centers for electric power generation are located at the north part of the country; whereas the main consumption is occurring at the south part nearby Athens metropolitan area. Three double circuit 400kV (extremely high voltage) power lines are used to carry the electric power from the north to the south. Also, 400kV power lines are used for the interconnections with the neighbour countries at the north. The rest of the transmission is mainly accomplished with 150kV (high voltage) single or double circuit power lines.

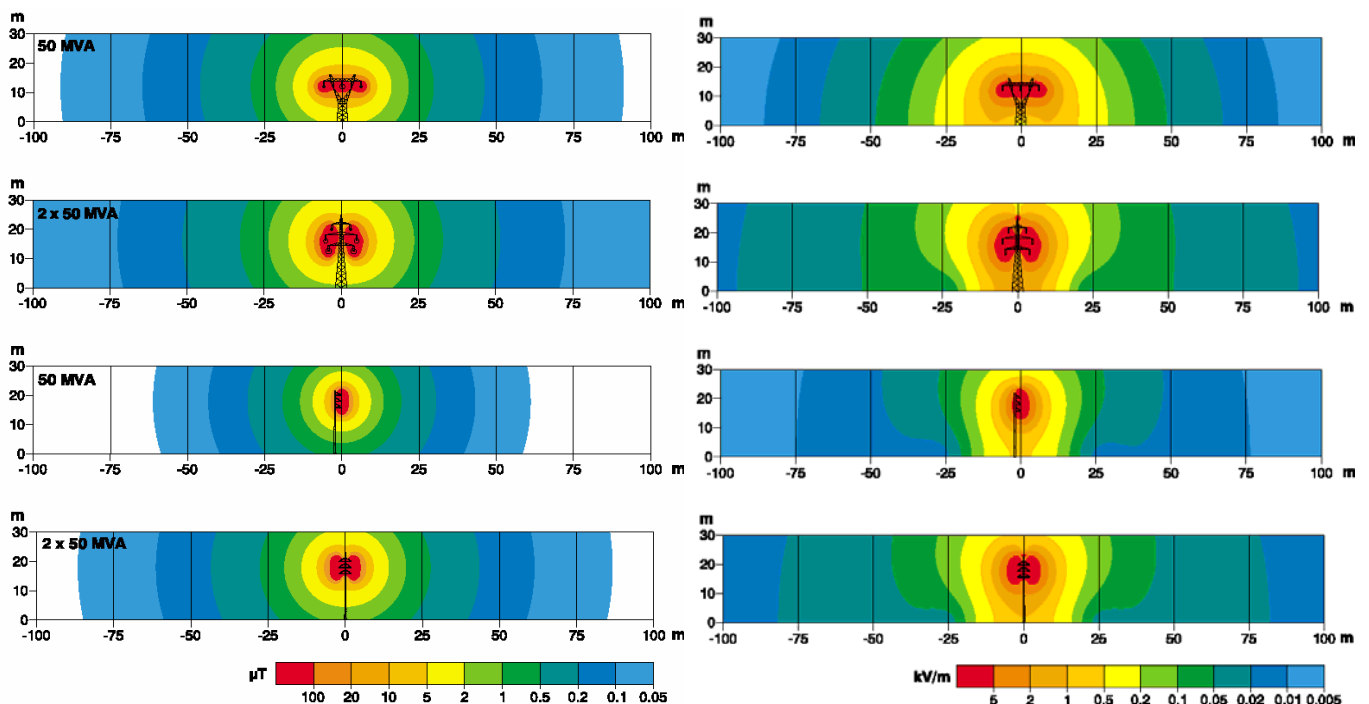

Fig 3. Typical levels for the magnetic field (on the left) and electric field (on the right) in the vicinity of the 150kV overhead power lines used in Greece. The considered clearance of the conductors to the ground was 12m and the indicated power line types are: 1st row: single circuit line on steel lattice towers; 2nd row: double circuit line on steel lattice towers; 3rd row: compact single circuit line on poles; 4th row: compact double circuit line on poles

Figure 3 shows typical levels of the electric and magnetic fields in the vicinity of the 150kV overhead power lines used in Greece. The magnetic field calculations refer to 50MVA apparent transferred power, which is considered typical for this level of voltage. The capacity for power transmission of these lines reaches 202MVA per three-phase circuit. In the 3rd row of this figure the fields in the vicinity of compact

single circuit line are shown. This line creates the least field levels in its vicinity as it was also shown in [7].

Similarly, figure 4 shows typical levels of the electric and magnetic fields in the vicinity of 400kV power lines used in Greece. For these lines the magnetic field calculations refer to a typical level of apparent transferred power of 350MVA (typical capacity is 1400MVA per three-phase circuit). In the 2nd and 3rd row of this figure the fields in the vicinity of a double circuit line with different phase arrangements are shown. The double circuit 400kV power lines in Greece used to be constructed with the symmetrical phase arrangement on the two circuits (2nd row). However, for the barrel type double circuit lines used in Greece, this phase arrangement is not the optimum for the reduction of the produced electric and magnetic fields (actually for the parallel operation of the two circuits this phase arrangement is the worst one) and this led to elevated levels of electric and magnetic fields. The new 400kV double circuit lines are now constructed with opposite phase sequence on the two circuits, which is the optimum phase arrangement (3rd row) for this type of lines and leads to reduced electric and magnetic fields, [7]. Also, the phase sequence on the existing power lines of this kind were switched to the optimum one causing significant reduction of the produced fields, [8].

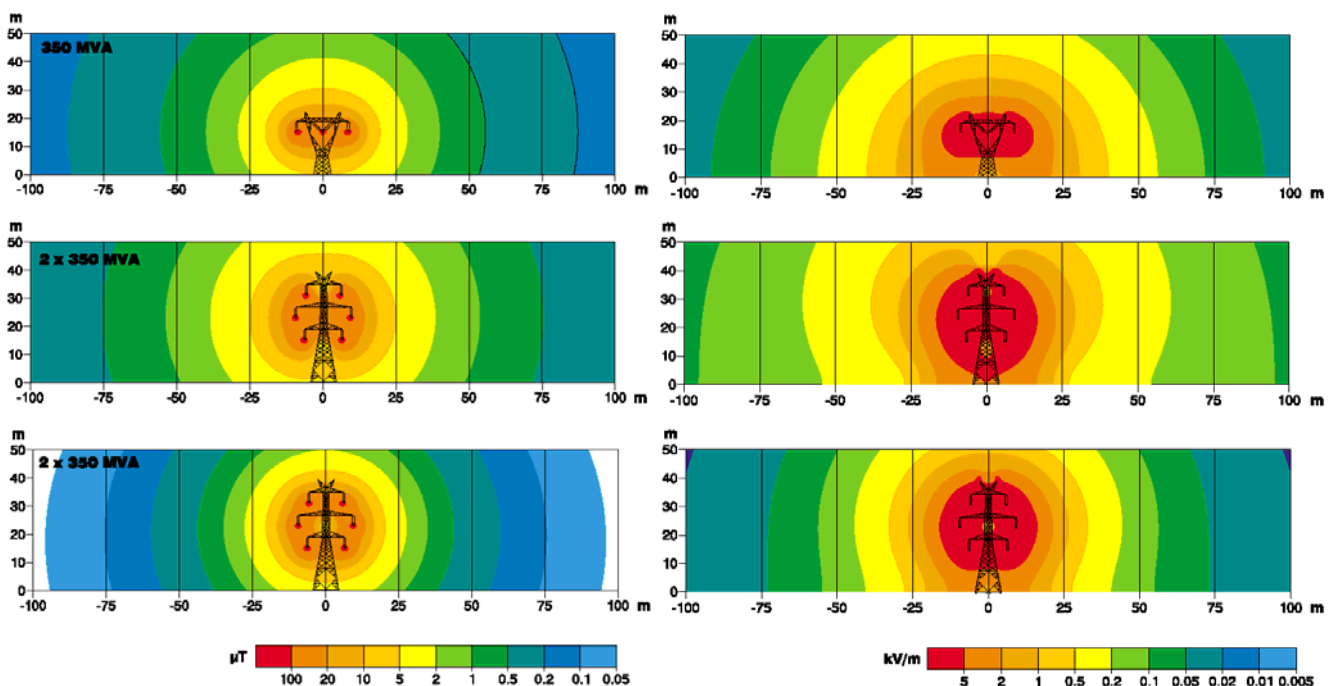

Fig 4. Magnetic field (on the left) and electric field (on the right) in the vicinity of the 400kV overhead power lines used in Greece. The considered clearance of the conductors to the ground was 15m and the indicated power line types are: 1st row: single circuit line; 2nd row: double circuit line with the symmetrical phase arrangement; 3rd row: double circuit line with the optimum phase arrangement

In Greece there are about 10000km of overhead high voltage power lines (400kV and 150kV) as well as 200km of underground high voltage power lines (150kV). The later are used for transferring high voltage power in the dense populated urban areas. Underground cables do not produce any electric field above the ground. Comparing the magnetic fields produced by an overhead and an underground high voltage line, carrying the same power, the underground cable produces a higher magnetic field value in a narrow area right above it (figure 5).

Table 2 shows worst-case values (based on theoretical estimations) and typical values (based on actual measurements) of electric and magnetic fields in the vicinity of the power lines used in Greece. The levels of the magnetic field are, as a rule, much lower than ICNIRP's reference level for general public exposure to 50Hz magnetic fields (100 μ T), [4]. The levels of the electric field can reach values close to 5kV/m (ICNIRP's reference level for general public exposure to 50Hz electric fields) under 400kV lines

and under worst-case considerations. However, in no case the measured values for the electric field were higher than ICNIRP's reference level.

High Voltage Substations

Regarding the electric and magnetic fields produced in the vicinity of high voltage substations the measurements conducted by EEAE have shown that the equipment installed into the substation does not produce any significant values of electric and magnetic fields outside the substation. It is the power lines connected to it, that produce the levels of electric and magnetic fields measured in the vicinity of the substations. Figure 6 shows a satellite photo of Agios Stefanos 400kV substation of the Greek power transmission system. EEAE was called upon to examine the levels of the produced fields outside this substation and performed measurements around the perimeter of it. The routes of the power lines connected to the substation as well as the measurement points are indicated in figure 6. These measurements verified that far from the power lines there are insignificant levels of fields, whereas close to the power lines the typical electric and magnetic field levels in the vicinity of the corresponding lines are found.

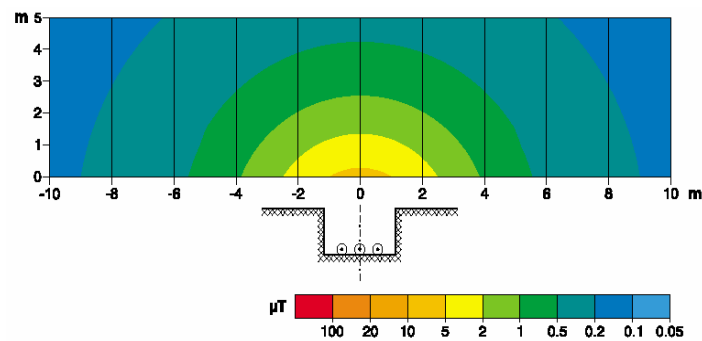

Fig. 5. Magnetic field in the vicinity of a 150kV underground cable carrying 50MVA. The considered cable is buried at 1.5m depth and the distance between the neighbor pole centers is 25cm.



Fig. 6. Satellite photo of Agios Stefanos 400kV substation (Greece) where the routes of 150kV and the 400kV power lines connected to it and the locations where EEAE have conducted measurements outside its perimeter are indicated.

Conclusion

The main sources of ELF magnetic field exposure of the general public in domestic environments are the electrical appliances, the internal wiring and the return currents on large grounded metallic objects as water pipes, drains and rails. The electrical appliances produce fast decreasing fields with distance that typically are considered important only for those devices where the operator must be in the close vicinity of them. The internal wiring normally does not produce any significant levels of magnetic fields, unless there is a faulty connection or a leakage current. The return currents on large grounded metallic objects as water pipes, drains and rails cause elevated levels of background magnetic fields.

Unbalanced loads at low voltage lines might cause net currents on them creating magnetic fields that decay relatively slowly with the distance. The medium voltage network does not suffer from these unbalances. The medium to low voltage transformer does not actually produce any fields in its environment. It is the lines connected to it that produce the electric and magnetic fields in its vicinity.

The electric and magnetic fields in the vicinity of high and extremely high voltage power lines depend on the type of line, its load and the distance from it. In Greece the application of the optimum phase arrangement at double circuit 400kV power lines caused a significant reduction of EMF levels around them. Furthermore, the use of compact lines also reduces the produced fields in relation to lines with normal dimensions. Underground cables create magnetic fields that decay very fast with distance from them. However, the magnetic field might be higher than that of an overhead line in a narrow zone above the cables.

References

1. G. Filippopoulos, E. Karabetsos, D. Koutounides, Ch. Govari: Health effects of ELF electric and magnetic fields – WHO/IARC evaluation and other recent reviews, Second International Workshop on Biological Effects of Electromagnetic Fields, Rhodes, Greece, October 7-11, 2002.
2. Greek legislation: Common Ministerial Decision, Protection measures for the exposure of the general public to all low frequency electric and magnetic fields emitting devices, Act No.512/Vol. B/25-4-2002.
3. European Union Council Recommendation of 12th July 1999 on the limitation of exposure of the general public to electromagnetic fields (0Hz to 300 GHz) (1999/519/EC).
4. International Commission on Non Ionizing Radiation Protection (ICNIRP), Guidelines for limiting exposure to time – varying electric, magnetic and electromagnetic fields (up to 300 GHz), Health Physics, Vol. 74, No 4, April 1998, pp 494 – 522.
5. J. Swanson, W.T. Kaune: Comparison of residential power-frequency magnetic fields away from appliances in different countries, Bioelectromagnetics, Vol 20, No 4, pp 244-254, 1999.
6. Hellenic Organization for Standardization, Requirements for electrical installations, EAOT HD 384, 2004.
7. D. Tsanakas, G. Filippopoulos, J. Voyazakis, G. Kouvarakis: Compact and optimum phase conductor arrangement for the reduction of electric and magnetic fields, CIGRE Symposium Report 36 – 103, Paris 2000.
8. E. Mimos, D. Tsanakas, G. Filippopoulos: Measurements of electric and magnetic fields produced by 400kV overhead power lines during the symmetrical and the optimum phase conductor arrangement, 3rd International Workshop on Biological Effects of Electromagnetic Fields, Kos, Greece, October 4-8, 2004.

RESULTS OF LEGISLATIVE EXPOSURE ASSESSMENT IN CROATIA

Srecko Grgic¹, Dina Simunic²

Ministry of Health and Social Welfare, Ksaver 200a, Zagreb, Croatia
Faculty of Electrical Engineering and Computing, University of Zagreb, Zagreb, Croatia

Regulatory acts in the world are mostly based on ICNIRP guidelines, and they are implemented in a direct or indirect way. Republic of Croatia also implemented them indirectly through European Recommendation 1999/519/EC. The Croatian Ministry of Health and Social Welfare coordinates the work in the legislation of biomedical effects of ionizing and non-ionizing radiation. The existing act is: Non-ionizing radiation protection law („Zakon o zaštiti od neionizirajućih zračenja“, NN 105/99), and the related ordinances: Ordinance on electromagnetic fields protection („Pravilnik o zaštiti od elektromagnetskih polja“, NN 204/2003), and Ordinance on basic requirements for devices which produce optical radiation and measures for optical radiation protection („Pravilnik o temeljnim zahtjevima za uređaje koji proizvode optičko zračenje te uvjetima i mjerama zaštite od optičkog zračenja“, NN 204/2003). Ordinance on ultrasound protection and Ordinance on occupational non-ionizing radiation protection are being drafted and will be issued soon as well. The law defines a general framework, whereas the Ordinance provides limit values of electromagnetic field in harmonization with the 10th Article of Law, methods for checking values of electromagnetic field in the human environment and conditions for getting permission for applying the methods, as well as special requirements for devices, industrial areas and buildings that are sources or contain sources of electromagnetic field.

The ordinance defines sources of electromagnetic field and more detailed conditions that health institutions and companies have to fulfil for a circulation, placing and usage of sources of electromagnetic field. The terms and the way of periodic measurements for checking the given conditions are also given.

Insofar, approximately 10% of all the existing sources have been checked. The sources include base stations of mobile telephony, radio and TV stations and of Croatian Air-Traffic Control.

The next phase encompasses performance of the statistics of the controlled sources.

MEASUREMENTS OF ELECTROMAGNETIC FIELD AND INDUCED CURRENT TO ASSESS EXPOSURE OF ELECTROSURGEONS

Krzysztof Gryz, Jolanta Karpowicz

Central Institute for Labour Protection – National Research Institute, Laboratory of Electromagnetic Hazards
Warszawa, POLAND, e-mail: krgry@ciop.pl

Introduction

The electromagnetic field (EMF) measurements have been performed to assess the medical staff exposure to EMF during the use of electro-surgery devices. Electro-surgery is used for various surgical treatments - to cut or to coagulate a patient's tissues. The sources of the occupational exposure of frequency above 300 kHz (up to approx. MHz) are mainly: the active electrode at a high electric potential, the cables connecting the generator with the active electrode, kept in the hand by a surgeon, and with the passive electrode (grounded plate), mounted to the patient's body. The waveforms of EMF produced in the vicinity of cables depend on a type of a device and its selected mode of a device operation.

Methods

The measurements of RMS electric and magnetic field strength have been conducted according to the Polish Standard PN-T-06580:2002 with the use of broadband electric and magnetic field strength meter EMR 300 from Wandel & Goltermann with H-field and E-field probes.

Measurements of RMS current flowing through surgeon's hand keeping the active electrode (Holaday HI-3702 clamp-on meter) and through feet (Narda 8850 stand-on meter) have been also conducted. This current should be considered rather as induced current than contact current.

Measurements were performed for more than 30 types of common-used electro-surgery devices: various types of ERBE, Aesculap, Bovie, Valleylab and Olympus operated in the various modes. Measurements have been performed during a simulated operation - absorbent cotton with saline has been used as phantom equivalent to the patient's body.

Results

The results obtained have shown that the surgeon is usually exposed to non-homogenous electric field (table 1). In the worst case (the use of a monopolar electrode and non-shielded cables, approx. 100-150 W output power), surgeon's hand can be exposed to E-field exceeding 1000 V/m, head and torso up to a few tens of V/m. When the cables touch the surgeon's body then the torso exposure is stronger, up to the level of the exposure of hand keeping electrode. H-field is usually below 1 A/m in the distance of 5-10 cm from electrodes and cables. For the operation with output power less than 50 W or with the use of bipolar electrode, electric field exposing the hand is less than 80 V/m and less than 30 V/m in the case of head and torso exposure.

The execution of electro-surgical treatment with an electric arc burned under the active electrode lead to significant increase of electric field affecting on medical staff. The level of exposure during electric arc-surgery can be 4-fold higher in comparison to the operation without arc. Waveform of EMF as well as the level of exposure in the vicinity of active electrode and supplying cables depend on the mode of electro-surgery devices operation.

The measurements of current in surgeon's body show that current in the hand keeping the active electrode can be of order 5 - 18 mA in the case of electric field strength of approx. 70 V/m in the distance of 5-10 cm from a monopolar active electrode and significantly depends on the location of cable towards the hand. Current in the feet of surgeon, insulated by shoes from ground and without direct contact with cables, is below 20 mA when electric field strength in the vicinity of monopolar active electrode is approx. 250 V/m. Taking into account the possibility of exposure to a stronger field (app. 1000 V/m or even higher) or a contact of the body with the cables, the current flowing through the arm of surgeon keeping the electrode can exceed the permissible values established in the Directive 2004/40/EC for contact current (40 mA). The results obtained also indicate that current measured by

clamp-on meter in the hand keeping the active electrode is approx. 2-fold higher than current measured by stand-on meter in the feet.

Conclusion

The obtained results have shown the strong exposure of surgeon to electric field. In the worst case of cable's location and electrosurgery device's output power, the EMF overexposure can occur. The surgeon's EMF exposure assessment for the case of the use of a monopolar electrode should be supplemented with measurements or calculation of currents flowing through the body.

If weak electric field near the electrode is found (usually in the case when output power is approx. 50 W or less, the use of bipolar electrodes or shielded cables) measurements of electric field strength can be considered as sufficient to confirm a low level of exposure there. The measurements uncertainty and the consequences of a high modulation of EMF from electrosurgery devices for the measurement's results should be analysed very carefully in every case when a relatively high level of exposure is found at the workplace.

The investigations supported by the State Committee for Scientific Research of Poland and Poland's Ministry of Economy, Labour and Social Policy (grant 1.A.03)

Table 1. Surgeons' exposure to electromagnetic fields during the use of various electrosurgery devices

Device	Maximum values of electric field strength, E [V/m]			
	The exposure of hand (in the vicinity of cable and electrode)	The exposure of head and torso	The exposure of hand (in the vicinity of cable and electrode)	The exposure of head and torso
	monopolar electrode (output power 60-150 W)		bipolar electrode (output power 20-60 W)	
A	1660	200	-	-
B	920	130	-	-
C	670	50	-	-
D	300	20	65	10
E	520	55	-	-
F	1380	80	-	-
G	1000	80	80	20
H	460	50	-	-
I	-	-	80	30
J	-	-	10	4

- maximum values of the fields with electric arc under the active electrode

ASSESSMENT OF RADIOFREQUENCY (RF) RADIATION LEVELS AROUND GSM BASE STATIONS IN SOME CITIES FROM REPUBLIC OF SERBIA

Branislav Vulević

"VINCA" INSTITUTE OF NUCLEAR SCIENCES, Belgrade, Republic of Serbia

The use of wireless communications devices has been increasing rapidly over the past decades. Simultaneously with development of these technologies, increase public concerns about health risks of exposure to RF radiation, particularly for people residing in the vicinity of the GSM base station antennas. It is expected that more and more base stations will be erected and concern of the general public relating to the health effects of exposure to RF radiation will increase since the recent launch of third generation (3G) GSM system.

During the last four years, "VINČA" Institute of Nuclear Sciences – Radiation and Environmental Protection Laboratory are performing environmental "spot" broadband measurement of electric and magnetic fields (to 50 GHz) in 24 cities in Serbia in the areas where people live and work. These investigations are motivated by the population and workers who are claiming information about levels for general public and occupational exposure to time-varying electric and magnetic fields in their living spaces.

This paper presents summary values for over 600 measuring points, especially around GSM base stations near residence areas in Belgrade and 12 cities of Serbia. These measurements will be useful in determining the exposure levels of the general public and this in turn determines whether the exposure levels are within reference levels recommended by International Commission on Non-Ionizing Radiation Protection (ICNIRP) Guidelines.

It has turned out that maximal measured values ("worst-case") are well below ICNIRP recommended levels.

This work presents only one part of efforts from the author on purpose that Non-Ionizing Radiation Protection (NIRP) starts to develop in Republic of Serbia.

DATA OF RF RADIATION AROUND BASE STATIONS FOR MOBILE COMMUNICATIONS IN BULGARIA

M. Israel, T. Shalamanova, V. Zaryabova

National Centre of Public Health Protection, Sofia, Bulgaria

The paper presents data from measurements and evaluation of safety zones around base stations of mobile operators in Bulgaria. The database contains information on 1554 base stations subjected to preliminary sanitary control (on planning stage), and 703 with recorded measurements in the period May 2001 – May 2005. The Bulgarian legislation sets two stages of hygiene control of EMF in the surroundings of base stations for mobile communication. The first stage covers check of the design documentation with calculation of the safety zone around the source at designing the base station for mobile communication. The estimated safety zones vary from 10 to 70 m; and for most of the base stations they are approximately 50 m. The second stage covers measuring the EMF values. The measurements are made by standard methods in the surroundings of stationary transmitter antennae of all types servicing systems for mobile communications. The measurement points are determined by the deployment, mounting and possible population access to emitting equipment.

The paper presents results from measurements and assessments of antennae emissions for more than 700 base stations. The measurement data are sorted by type of mounting of base stations antennae namely on:

- Facades;
- Slope roofs;
- Telecommunication masts;
- Masts of different height on roofs of residential and public buildings depending on the distance to the source.

Data for 2 m and 5 m around of the antennae mounted on the roofs are presented. The results are compiled, statistically processed and presented as graphs.

The mean values of EMF power density on a distance 2 m reach up to $150 \mu\text{W}/\text{cm}^2$ in front of the antennae, $25.0 \mu\text{W}/\text{cm}^2$ to the side of the antennae, and up to $15.0 \mu\text{W}/\text{cm}^2$ behind them. The power density values for antennae mounted on telecommunication towers or on slope roofs of residential buildings exceed $10 \mu\text{W}/\text{cm}^2$ in few cases. As a conclusion, the population is exposed to low levels of microwave radiation according to the ICNIRP recommendations. The Bulgarian legislation requires more strict limits, and many times higher levels exist around base stations situated in residential areas.

ELECTROMAGNETIC FIELD LEVELS IN THE WORKING ENVIRONMENT IN RADIO AND TV STATIONS

M. Ivanova, M. Israel, V. Zaryabova, T. Shalamanova

National Centre of Public Health Protection, Sofia, Bulgaria

Electromagnetic field sources used for communication always are subject of serious interest. There are many publications concerning exposure and risk assessment of the working in such environment. Results of epidemiological study performed in Bulgaria in 90s (Varna, Proceedings 2001) show exceeding of the maximal permissible values especially in radio stations for the personnel in 24 h working shift.

In the last years the situation is strongly influenced by the development of the technology which leads to changes in equipment in radio and TV stations, using lower power, facilitate the working regime.

Paper presents data of exposure assessment of different professional groups in selected radio and TV stations. Assessment is being performed on basis of EMF parameters values and energetic load calculations according to the national legislation. Additionally, the corresponding SAR values are presented. Data are compared with the results of previous investigation to evaluate the new situation in this branch. Exposure levels are much lower than those in the last study, and lower compared to the exposure limits, as well.

FREQUENCY SELECTIVE MEASUREMENTS OF RADIOFREQUENCY RADIATION EMITTED BY SOURCES IN THE VHF AND UHF BAND IN CONNECTION WITH HUMAN EXPOSURE

Simona Miclaus¹, Paul Bechet², Emil Teodoru¹

Land Forces Academy, Sibiu, Romania miclaus@armyacademy.ro
Center for Communication and Informatics, Sibiu, Romania

Abstract

EMF exposure of population became of intense interest in Romania, especially in the last 2-3 years. Mobile phone BTS antennas debate have become of unprecedented public health concern, starting with the end of 2005. Numerous newspapers at central and local level published articles on the issue under the pressure of citizens (more or less "scientific"). A number of population complaints were received at Local Consumer Protection Agencies of various Romanian counties, Environmental Agencies and Guards. As a result, some local authorities adopted decisions for national budget financial support dedicated to some EMF measurements campaigns in 2006 and the subject is pretty sensitive at the moment.

Our study is part of a national research project (under the "Excellence Research Program" of the Romanian Ministry of Research and Education). It is devoted to RF exposure assessment by using the frequency-selective method.

Two systems were used in our (preliminary) measurement campaign, namely the Rohde&Schwarz TS-EMF system, and the Field-Nose system developed by ARC Seibersdorf.

The measurement protocol took into account the objectives of the research, which were either compliance verification, or in situ measurements. A third objective was the refinement of the methodology, by following also the system settings' influence on the results. And the fourth objective was the results comparison, by using in parallel both measurement systems for the same exposure conditions and simultaneously.

We used the measurement method described in "ECC RECCOMENDATION (02)04 revised: Measuring non-ionising electromagnetic radiation (9kHz-300GHz)".

Measurements were made around various RF sources: a) outdoor: GSM900, GSM1800 BTS antennas, FM Radio Broadcasting antennas, VHF RF special sources (for workers exposure assessment), etc; b) indoor fields emitted by a 8011.g technology wireless access point antennas and also GSM signals indoors.

None of the measured values of partial or total exposure exceeded the reference level given in ICNRP guidelines (which are adopted in Romania), at least for population. Generally, especially for GSM exposure, they are far beyond the accepted limit, for the sites we visited. In the case of workers, the imposed short-distance needed in some cases relative to the RF source, may approach the limit.

Concerning settings influence of detected values, the resolution bandwidth, the sweep time, detector type, detector mode, etc., they decisively influence results. The RF signal characteristics are very important in this regard, for a well-set measurement system. Comparison between results of the two measurement systems gave good agreement, for similar settings.

Results of present study showed the importance of a refined measurement methodology/protocol from the perspective that frequency and/or signal specific characteristics turned out to be relevant for biological impact. The exposure circumstances are of great interest in our opinion, for a reliable result. This can also be connected to the aspect that ICNIRP reference levels are based on studies of short term exposure, and not on long term, and at some point in the future, they might be improved. A key aspect regarding the value of epidemiological or health-related studies should be the quality of RF exposure assessment. Despite the ubiquity of new technologies using RF, little is known about population exposure from RF sources and even less about the relative importance of different sources.

ACCURACY LIMITATION FACTORS IN NEAR FIELD EMF METROLOGY

Pawel Bienkowski

EM Environment Protection Lab., Technical University of Wroclaw, Poland
pawel.bienkowski@pwr.wroc.pl, www.lwimp.pwr.wroc.pl

Abstract

The paper presents theoretical analyses and measurements results of factors affecting the precision of near field EMF measurements. Presented problems are connected mainly with errors of a method and imperfection of the measuring device. In particular: using probes with non-zero geometrical dimensions, difference between conditions of calibration and measurement (eg. modulated and pulse fields), uncertainty of calibration, nonlinear dynamic characteristic, frequency response and deviations of the isotropic characteristic.

Introduction

The development of contemporary civilisation is associated with the consumption of more and more quantities of energy transformed to forms applicable in technology, science, medicine and in the household. One of the forms of energy, which role has been rapidly growing in every branch of everyday life, is energy of RF currents and fields. The intentional or unintentional irradiation of a part of the RF energy, which results in contamination of the whole environment and the interference in wide frequency range is take place in those processes. Because of the fact that the electromagnetic field is not detectable by organoleptic methods, EMF detection and every works and investigations connected with the field require the use of the specific tools to detect it. Moreover, since the EMF is directly nonmeasurable it is a necessary to transfer it to another quantity that would be able to measure (voltage, heat).

EMF measurement in the far-field (Fraunhofer zone) is one of the less accurate as compared to measurements of other physical quantities. The near-field conditions (Fresnel region) cause further degradation of the near-field EMF measurements accuracy as compared to the far-field one. An additional problem is the accuracy of the EMF standards and as a result low accuracy of measurement devices.

Specificity of the near-field EMF measurements

Generally EMF is described by electric field vector - E , magnetic field vector - H and Poynting's vector S , but only in the limited level. In the far field these vectors are strictly connected by the impedance of free space. In the near source fields their relations are more complicated and depend on the type of EMF source and distance from source to sensor. In this case it is necessary to measure E , H and S vectors independently. To find S vector we have to know value of E and H vectors and phase shift between them. In technical practice vector S is usually calculated from E or H vectors, but there are some interpretation problems in this method.

EMF measurement methods

In order to optimally select a method of the EMF measurement in the near-field it is initially necessary to find quantities that would characterize the field in the best way and would be possible to use in a practical application. The dominating technique of EMF measurement is the use of an antenna (mainly a dipole or a loop) loaded by a detector (diode or, more rarely, thermocouple) and transfer of DC voltage from the probe to an indicator (in the case of the most popular designs of two-piece meters) through a high resistance (transparent) transmission line (Fig. 1). There are usually wideband probes.

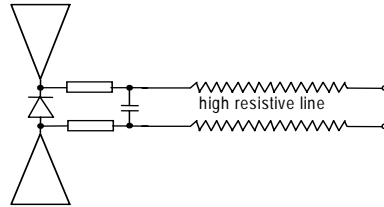

Fig.1. E-field wideband sensor

The basic method of the electric field measurement, especially in the near field, is measuring the electromotive force induced by E component of EMF in an electrically small symmetrical dipole antenna. There are some restrictions in using antennas as an EMF probes.

Size of probes

Every EMF measuring probe causes the measured EMF integration by finite sizes of a probe. In the case of the far-field measurements the integration is usually negligible as the probe standardization is done in similar conditions as measuring ones. The near-field probes are standardized in similar conditions (in a TEM cell, on an open site) and then the change of the measuring conditions to those during standardization must be taken into account. As it was previously shown the EMF integration may be divided into two phenomena, i.e.: the phase integration and the amplitude integration [5].

The phase integration is based upon a current distribution in a measuring probe and the phase integration error δ_p may be defined in the form:

$$\delta_p = \frac{1}{2} \left(1 - \frac{2kh}{\sin 2kh} \right) \quad (1)$$

where: k - propagation constant, $2h$ - probes length.

In order to make it possible to compare the measuring band of limiting factors the formula is plotted in Fig. 2.

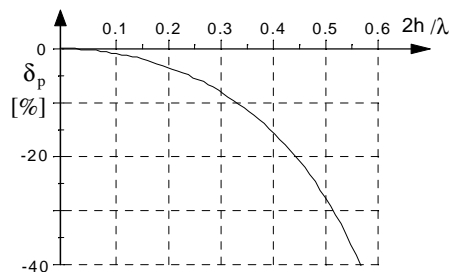

Fig. 2. Phase integration error versus $2h/\lambda$

The error presented supports the widely accepted point that the measuring antenna (for the near-field purposes) should be 'electrically small'. It may be seen from the diagram that this means that the antenna length should not exceed, say, 0.2λ . It is not necessary to call the power line frequency example to show the role of the limit at microwave ones (which are here of concern).

To illustrate probes' size limitations at lower frequencies we should take into account the amplitude integration error δ_a . The error depends upon the EMF curvature. If present, for instance, the electric (E) field in the near-field in the form:

$$E = \frac{\text{const}}{R^\alpha} \quad (2)$$

where: R - distance between a source and a probe, α - wave type indicator.

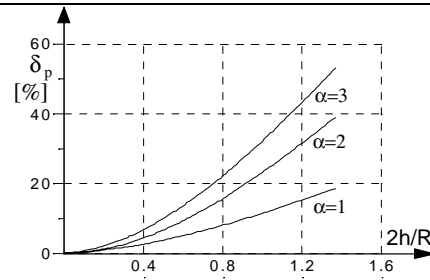

Fig. 3. Amplitude integration error versus $2h/R$

For spherical wave $\alpha = 3$, cylindrical wave $\alpha = 1$ and for the plane one (TEM wave) $\alpha = 0$.

The error as a function of $2h/R$, for three values of α is plotted in Fig. 3.

It may be summarized that δ_p play the main role in high frequencies and δ_a in measurements in source proximity, independent of frequency range.

For magnetic field measurement one usually uses probes consisting of a circular loop antenna loaded with a detector of shaped frequency response. Analogically to electric field it is possible here to follow the discussion related to the measuring antenna sizes limitation which results from the error of a quasi-point value of the magnetic field measurement and the results are almost the same.

EMF probe frequency response

The structure of a typical probe E-field near-field is presented in Fig 1. and its equivalent circuit in Fig. 4.

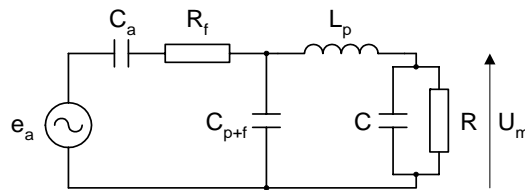

Fig.4. Detailed equivalent circuit of E-field sensor

Source e_a represents the voltage induced in the antenna. The voltage value depends on field intensity E in the measurement site and on the effective height of the antenna h_{ef} (3):

$$e_a = E \cdot h_{sk} \quad (3)$$

For the electrically short dipole ($2h < 0.1 \lambda$) the effective height is a constant in the frequency function and equals the half of the geometrical length of the antenna. Its input impedance is purely of the capacitance nature. The input signal of the detector, simultaneous to the voltage at antenna load equals (4):

$$U_0(f) = e_a \cdot \frac{Z_0(f)}{Z_0(f) + Z_a(f)} \quad (4)$$

where: U_0 – voltage in load impedance, Z_a – input impedance of the antenna, Z_0 – load (detector and monitor) impedance

In Fig. 4 impedance $Z_0 = C_a$, Z_a are represented by C_f , R_f , C_a , C_p and L_p . C and R are detector parameters, C_f and R_f are the element of the low-pass filter that allows modification of the probes' frequency characteristic, especially in high frequencies to reduce an influence of fields from beyond of probe measuring band causing parasitic reactance of probe elements that are connected with parasitic capacities and inductances related to the montage and imperfections of the elements. As a result probe sensitivity rapidly increases near resonance frequency. I will only mention here that the measuring band of the probe must be artificially limited to frequencies below resonance of these reactances and the

resonance of the antenna (very important in loop antennas). Results of use high frequency filter is presented in Fig. 5

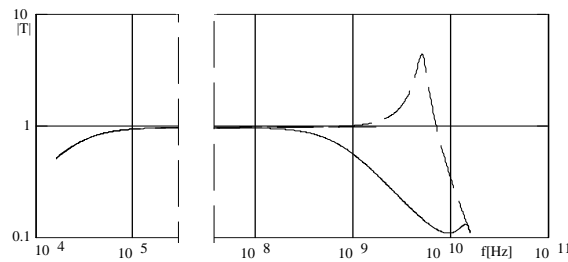

Fig.5. Frequency response of E-field probe without- (dashed line) and with RC filter.

Analysis circuit from Fig. 4 in the frequency function allows distinguishing three typical sub-ranges:

- low frequency range, in which transmittance increase with frequency
- medium frequency range, in which transmittance is a constant:

$$U(f) \cong \frac{C_a}{C + C_a + C_{p+f}} \quad (5)$$

This range is the most interesting one from the metrological point of view -high frequency range, in which the influence of the antenna filter is visible, and where the transmittance decreases while the frequency increases.

By changing the values of particular elements of the probe, we can modify both the shape of the frequency characteristic and the values of transmittance, having a direct influence on sensitivity of the system.

Examples of frequency response of different commercial E-field probes are presented in Fig. 6.

Error! Objects cannot be created from editing field codes.

Fig.6a. Measured frequency response of E-field probe 1MHz-40GHz,

Error! Objects cannot be created from editing field codes.

Fig.6b. Measured frequency response of E-field probe 0,1MHz-1GHz

Typically deviation from flat frequency response is from $\pm 5\%$ in kHz and MHz up to $\pm 40\%$ in GHz. Of course it is possible to use frequency correction factor in measurements, but it is difficult or even impossible eg. where fields from different sources working on different frequencies are measured simultaneously.

Dynamic characteristic of EMF probes

Dynamic response of passive EMF sensors depends on used detector characteristic. For typically used diode detector, the probe's dynamic characteristics consist of three segments:

square-law characteristic for low measured field intensity. In this area it is RMS detector;
transitional characteristic for medium field intensity (characteristic changes from square-law to linear);
linear characteristic for high intensity, where can be observed the peak detection.

Dynamic characteristic changes are negligible when monochromatic harmonic fields are measured (this complies with calibration conditions), but it is very important in measurements of the complex (eg. multifrequency source) and pulsed fields. It is possible to prove that in square-law area measured effective field intensity can be estimated as (6):

$$E_w = \sqrt{\sum_n E_n^2} \quad (6)$$

where: E_w – effective intensity of E or H-field, E_n – field intensity of n

Typically RMS detection is only for 15-30% of probe's measuring range. The results of experiment carried out to check this thesis are presented in table 1. In laboratory conditions measured signal from two EMF sources 900MHz and 1800MHz were simulated. Measurements were performed in three conditions: works only 900MHz source, works only 1800MHz source and both of them work simultaneously. The error of RMS measure was defined as (7):

$$\delta_{rms} = 20 \lg \left(\frac{E_w}{\sqrt{E_{900MHz}^2 + E_{1800MHz}^2}} \right) [\text{dB}] \quad (7)$$

Tab.1. Results of complex E-field measurement

probe 3AS-1 (MEH)					probe EP-300 (PMM)				
E900M	E1,8G	E900+1800	Erms	δ [dB]	E900M	E1,8G	E900+1800	Erms	δ [dB]
3,4	3,4	4,8	4,8	0,00	5,2	3,8	6,4	6,4	0,09
5,1	5,1	7,3	7,2	0,04	7,5	5,5	9,5	9,3	0,16
8,3	8,3	11,8	11,7	0,05	12,2	9,0	15,5	15,2	0,16
11,6	11,6	16,6	16,5	0,06	17,9	12,9	22,5	22,1	0,17
16,8	16,8	23,9	23,8	0,04	24,7	18,5	33,3	30,9	0,66
24,2	24,2	34,6	34,2	0,10	36,0	27,4	50,0	45,2	0,87
45,5	45,5	64,7	64,4	0,04	56,7	56,7	92,7	80,2	1,26
69,5	69,5	100,0	98,2	0,15	103,0	66,0	142,5	122,3	1,33

The error δ_{rms} as a function of indicated E field intensity for three commercial available probes is plotted in Fig.7.

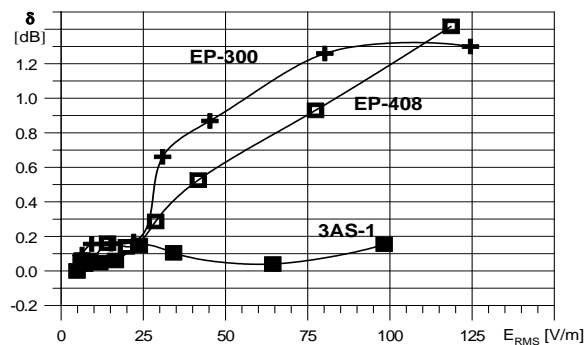

Fig. 7. Error of RMS field intensity measurement

The next problem is connected with no-rms detection is probe's response for pulse fields. Theoretically simulation and experiments results show that pulse response depends on detector characteristic and time constant of all measurement system (probe and monitor). Fig. 8 presents example results of measured probes response for pulse CW signal with pulse duration from 1% to 100% (pure CW). Experiment carried out for different frequencies of pulse repetition (10Hz- 1kHz) and for three power densities of CW field: 1W/m^2 , 10W/m^2 and 40W/m^2 .

Generally the error increases with decreasing pulse duration and increasing value of measured field.

a)

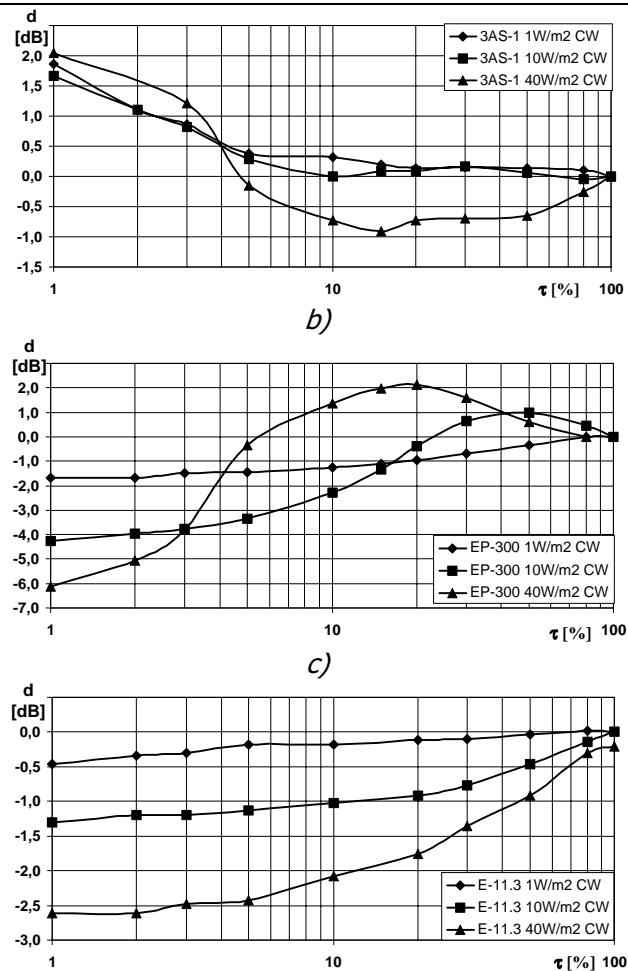

Fig. 8. Error δ_p of pulse field measurement
 a) 3AS-1 – Wrocław Univ of Technology, b) EP-300 – PMM, c) E-11.3 - Narda

Summary

In the paper author presented short review of the main factors that decrease accuracy of near-field EMF metrology. Except technical factors we have to take into an uncertainty budget a „human factor” that author defines as influence of skills, experiences and perfection of person who done the measurement on his results.

Based on laboratory practice one can estimate the importance of this factor to be a $1/3 \div 1/2$ of the total uncertainty of measurements and total average inaccuracy of survey measurements better than $\pm 2-4$ dB is successful result.

References

1. H. Trzaska, Electromagnetic Field Measurements in the Near Field, Noble Publ. Corp. 2001.
2. P. Bienkowski, Spectrum electromagnetic field measurements for labour safety and environment protection purposes., Radioelektronika 2001. 11th Intern. Czech-Slovak Conference. pp. 425-428
3. P. Bienkowski, Parameters of wideband electromagnetic field sensors and possibilities of their modification, Applied Electronics 2005. International conference. Pilsen, 2005 pp. 41-44

ROLE OF EXPOSURE ASSESSMENT UNCERTAINTY ANALYSIS IN THE PROCESS OF TESTING THE COMPLIANCE WITH REGULATIONS

Jolanta Karpowicz, Krzysztof Gryz

Central Institute for Labour Protection – National Research Institute, Laboratory of Electromagnetic Hazards
Warszawa, Poland jokar@ciop.pl

Abstract

The process of electromagnetic fields (EMF) exposure or emission assessment is composed of the following main steps:

- A – EMF parameters identification
- B – selection of EMF assessment criteria
- C – selection of measurements protocol
- D – selection of measurements device
- E – measurements execution
- F – analysis of the results of measurements
- G – interpretation of the level of the assessed exposure or emission situation
- H – decision on the need for further action

Sufficient identification of parameters of the EMF taken into consideration (Step A) is the one of the most important actions for the process. Any mistake at this step can totally destroy the EMF assessment process and results in many-fold over- or under-estimation of the exposure.

The results of Step A allow selection of EMF assessment criteria, measurements protocol and measurements device in harmony with the parameters of assessing EMF. The main types of the criteria for various purposes (Step B) can be:

- mandatory legislations, voluntary standardizations or guidelines for general public, workers or medical patients EMF exposure assessment
- mandatory legislations, voluntary standardizations or guidelines for assessing the EMF emission from electrical appliances or environmental EMF exposure assessment
- EMF exposure assessment guidelines for scientific research.

Measurements protocol (Step C) and measurements devices (Step D) should be harmonised with the EMF assessment criteria taken into the consideration. For example, for laboratory testing of EMF emission from large-scale manufacturing electrical appliance (e.g. mobile phone handsets), the measurements protocol can be very detailed and time-consuming because the testing work refer to the huge number of similar devices and costs of the testing procedure per each individual appliance will be significantly reduced by their number. At the opposite side of the problem, the protocol for the EMF exposure assessment for the individual workplace should be reasonably simplified to reduce the costs and make the assessment possible in small and medium size enterprises.

Execution of measurements (Step E) and analysis of the obtained results (Step F) - e.g. spatial and time averaging of EMF affecting human body or modification of the measurements results with the use of correction factors taking into consideration pulse modulation of assessing EMF – should result with a value of the EMF level parameter selected before for the assessment (e.g. spatially averaged RMS value of magnetic field in selected volume of workplace) and the estimated uncertainty for this value. All steps of the EMF assessment (Step A – F) influence on the total uncertainty of knowledge concerning the EMF-level parameter.

The interpretation of the obtained results (Step G) should be focused on the decision if the EMF level is:

- to high and reduction action should be initiated, in the case of human body exposure usually it should be started immediately
- high but with acceptable range and reduction action can be initiated, but not necessary and even human body exposure can be reduce later
- low and no needs for reduction action.

All cases of EMF assessment can include the decision process considering the uncertainty and can need decision concerning the uncertainty analysis model, e.g. so-called "shared uncertainty" model of

decision. The highest requirements for the uncertainty analysis come from the mandatory legislations of the "threshold type". In such case, if the EMF assessment is exceeding the EMF threshold (fixed by legislation) this will automatically lead to serious consequences as financial punishments or obligation for switch-off the EMF emitting devices. For such legislative model of EMF assessment protocol, there is a very strong need for detailed analysis of assessment uncertainty and also the arbitrary decision concerning the maximum acceptable uncertainty and decision model (e.g. shared uncertainty). On the contrary – the lowest requirements for the uncertainty analysis come from the "continuous quality improvement type" of legislations, standards or guidelines. In such case, the EMF assessment results should always be analysed with consideration the possibility for EMF reduction, but the reduction should be stronger and should be initiated faster, when the EMF level is higher. In such model, the level of uncertainty can be accepted even of very high value and not calculated in details. The only important requirements are: it can be guaranteed that EMF identification, selection of the assessment criteria, measurement device and measurement protocol were executed properly.

EXPOSURE OF CHILDREN BETWEEN 0 AND 15 YEARS OLD TO A 50 HZ MAGNETIC FIELD OF 0.2, 0.3 AND 0.4 MICROTESLA IN BELGIUM AND SOME CONSIDERATIONS ABOUT UNCERTAINTY

Decat G.¹, Van Den Heuvel I.¹ and Mulpas L.²

VITO, Mol, Belgium
ELIA, Brussels, Belgium

Introduction

The present study is based on the initial work of Wertheimer and Leeper (1979) reporting a relative increased leukaemia risk for children living in the vicinity of power lines. Since then a lot of laboratory and epidemiological studies were published on the possible association between the B-field exposure generated by power lines and childhood leukaemia. Mainly the epidemiological pooled analyses publications of Ahlbom et al. (2000) and Greenland et al. (2000) reporting that the relative risk on childhood leukaemia if exposed to an average B-field of 0.4 μT is about twice that of the one if children are exposed to less than this average level, enforced the debate on the possibility of the association. Because the "International Agency for Research on Cancer (IARC, 2002)" classified the ELF magnetic fields as 'possibly carcinogenic', the discussions about this topic are even stronger than before. Anyway, it has to be stressed that the IARC-classification is based on epidemiological grounds and not on causal relationship between both variables.

Since there also seems to be confusion about the 0.4 μT exposure it has to be noted that the 0.4 μT is not only associated with power lines but with all EMF sources we meet in our daily life. In this respect the results of the present investigation concern the cut-off points of all possible sources of our living environment at which children might be exposed.

Material and methods

Figure 1 is a schematic representation of the methodology we used in order to measure and evaluate the B-field exposure of the children at home, at school or at the kinder garden.

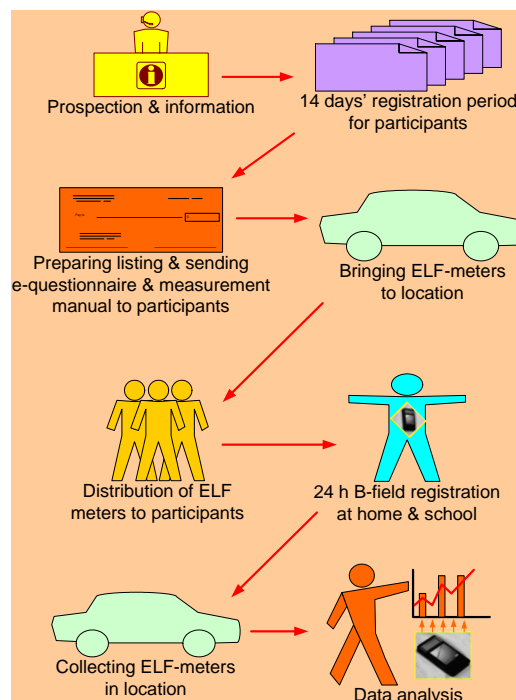

Figure 1: Schematic representation of a whole measurement cycle

Prospection, information and listing

Once a company was selected and has agreed to participate in the measurement survey, the staff members were informed about the aim and the protocol of the measurement. Then a 14 days' registration period for the staff members who wanted to participate in the survey took place. When this period was closed a listing of all the participants together with the corresponding sampling dates was prepared and sent by e-mail to each participant, as well as a measurement manual, a log form and an electronic questionnaire.

- Log form,
This was used for recording the time and the place of the child's exposure
- Electronic questionnaire

The participants used this tool for listing their electrical household appliances, electricity consumption, income possible outdoor EMF-sources etc. In this way we could get some insight in the possible correlation between the explanatory variables and the B-field response. A second goal of the e-questionnaire was to gain insight in the geographic distribution of the participants by means of a GIS-map.

Registration of the B-field

Once the participants were listed they received an ELF-monitor (only one monitor per family) for recording the B-field exposure in one of their children between 0 and 15 years old. The B-field was recorded by means of an EMDEX Lite (Enertech) ELF monitor. The sampling time was 24 hours and the sampling rate 1 minute. The objective was to perform 24 h measurements in fifteen children per sampling week. Each 24 h B-field registration was split up in three different magnetic field exposure phases:

- a) exposure recorded before and after school time at home (dynamic exposure)
- b) exposure recorded during the sleeping time of the child (stationary exposure)
- c) exposure during the school or crèche time of the child (dynamic exposure)

For each sampled child, the place and the time of the different exposures phases were recorded in the log-form.

After being downloaded the recorded magnetic field data were analyzed by means of the EMCALC 2000 software (Enertech), statistics were performed by means of the STATISTICA software package.

Results and discussion

Sample size

The personal B-field exposure has been recorded with 251 children (between 0 and 15 years old) from which one of the parents is a staff members of 7 institutes/companies selected for sampling

Location distribution of the sampling

The GIS-map of figure 2 shows the distribution of the locations where the participating children are living. The sampling locations are still unevenly distributed over Belgium. Up to now, no sampling has been performed in the south and the west part of the country and in the other parts the sample is incomplete.

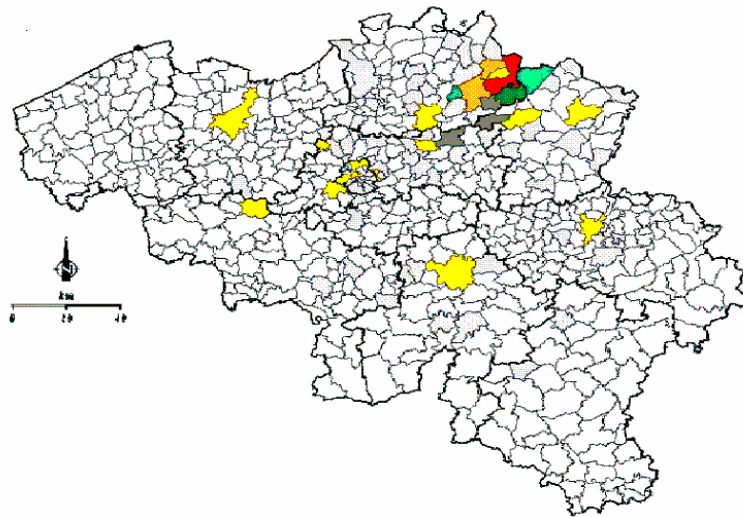

Figure 2: GIS-map demonstrating the sampling distribution in Belgium

Data Analysis

Descriptive statistics and distribution fitting

Table 1 summarizes the weighted location and dispersion statistics for the different exposure conditions. For example the weighted arithmetic mean (Ar. Mean) of OVAM is the average of the 251 overall 24 h measured magnetic field exposure means. The one of ASLE is the average of the 251 magnetic field recorded during the sleeping time of the child etc. The interpretation of the weighted median is the same as the one for the weighted arithmetic mean.

Table 1: Location and dispersion statistic of the magnetic field exposure recorded under different conditions.

	N	Arithmetic. Mean	Conf. -95%	Conf. 95%	Median	Min.	Max.	D
1 OVAM	251	0,09	0,06	0,12	0,04	0,01	2,48	0,03
2 ABAS	249	0,09	0,07	0,11	0,05	0,01	1,96	0,03
3 ASLE	251	0,12	0,06	0,19	0,03	0,00	5,74	0,02
4 OAMH	251	0,10	0,07	0,13	0,05	0,01	2,41	0,02
5 AMSC	232	0,05	0,03	0,06	0,02	0,00	1,15	0,02
6 OVM	251	0,04	0,03	0,05	0,02	0,00	0,48	0,01
7 MBAS	248	0,05	0,04	0,06	0,03	0,01	0,47	0,04
8 MSLE	251	0,16	0,05	0,27	0,02	0,00	12,4	0,01
9 OMH	251	0,08	0,05	0,11	0,03	0,01	3,15	0,02
10 MSC	232	0,04	0,03	0,04	0,02	0,00	0,56	0,09
11 OGM	251	0,04	0,03	0,04	0,02	0,00	0,35	0,09
12 GBAS	247	0,04	0,04	0,05	0,03	0,01	0,37	0,06
13 GSLE	250	0,15	0,05	0,26	0,02	0,00	11,3	0,02
14 OGH	250	0,07	0,04	0,10	0,03	0,01	2,92	0,03
15 GGSC	230	0,03	0,03	0,04	0,02	0,00	0,48	0,08

Legend of the table

1. OVAM: overall arithmetic mean of the 24 h measurements (2+3+4+5)
2. ABAS: arithmetic mean of exposure of activities before and after school
3. ASLE: arithmetic mean of exposure during sleep
4. OAMH: overall arithmetic mean at home (2 + 3)
5. AMSC: arithmetic mean during school or crèche time
6. OVM: overall median of the 24 h measurements (7+8+9+10)

7. MBAS: median of exposure of activities before and after school
8. MSLE: median of exposure during sleep
9. OMH: overall median at home (7 + 8)
10. MSC: median during school or crèche time
11. OGM: overall geometric mean of the 24 h measurements (12+13+14+15)
12. GBAS: geometric mean of exposure of activities before and after school
13. GSLE: geometric mean of exposure during sleep
14. OGH: overall geometric mean at home (12 + 13)
15. GSC: geometric mean during school or crèche time

Conf. -95% & +95%: the lower and upper 95% confidence limits of the arithmetic mean

D: the Kolmogorov-Smirnov test statistic for distribution fitting

Table 1 shows that the magnetic field exposure varies from 0 μT up to 12,44 μT . The latter extreme field strength is an "outlier" (observations so far away from the rest of the sample that they should be discarded) since the father of this child didn't respect the measurement protocol and performed his own small measurement campaign by placing the monitor near some household devices whereas the 24 h registration had already started. Such operations result in bias that influences the summarizing statistics like the arithmetic mean which becomes then an un-reliable estimator of the real B-field exposure. In order to decide if the best estimator of the real exposure is a parametric (arithmetic mean), a parametric transformed (geometric mean) or a non-parametric (median) one, the Kolmogorov-Smirnov one sample hypothesis test was performed. The D-statistic of this test (last column of table 2) shows that the distribution of the data doesn't fit a normal distribution ($p < 0.05$). Since the assumption of population normality isn't valid the non-parametric "median" statistic is preferred as the best estimator of the real B-field exposure in every situation. The "Box and Whisker plot" (figure 3) confirms the Kolmogorov-Smirnov test and shows that the median isn't influenced by the extreme recorded maximal B-field values.

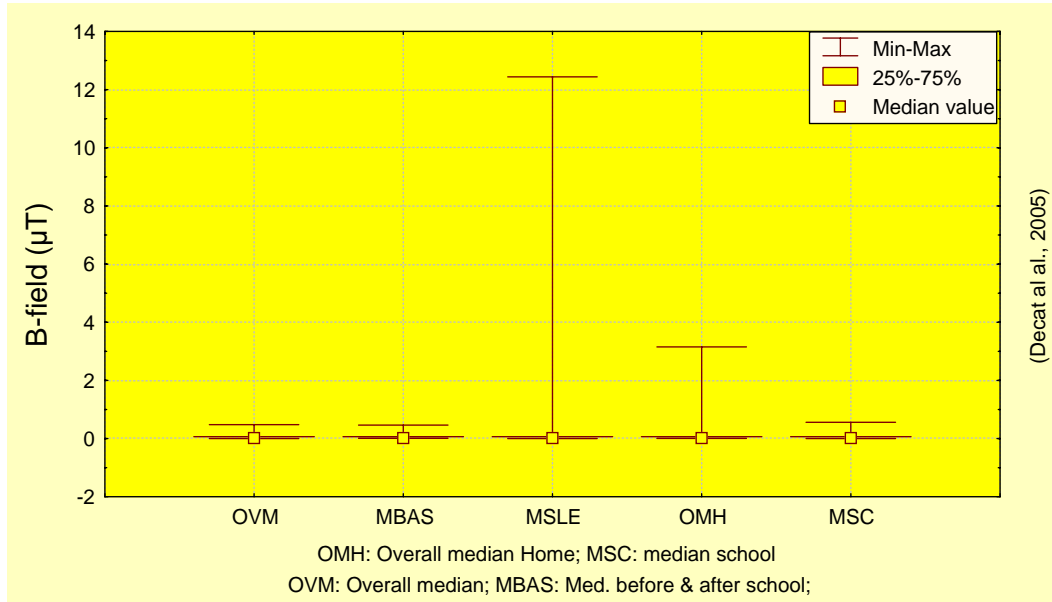

Figure 3: Box and Whisker plot of the median exposure

By calculating the relative frequency distribution of the overall median exposure (figure 4) we see that about 95% of the 251 medians of the 24 h B-field registrations is equal to 0.05 μT (midpoint between 0 and 0.1 μT), the remaining 5% is larger than 0.1 μT .

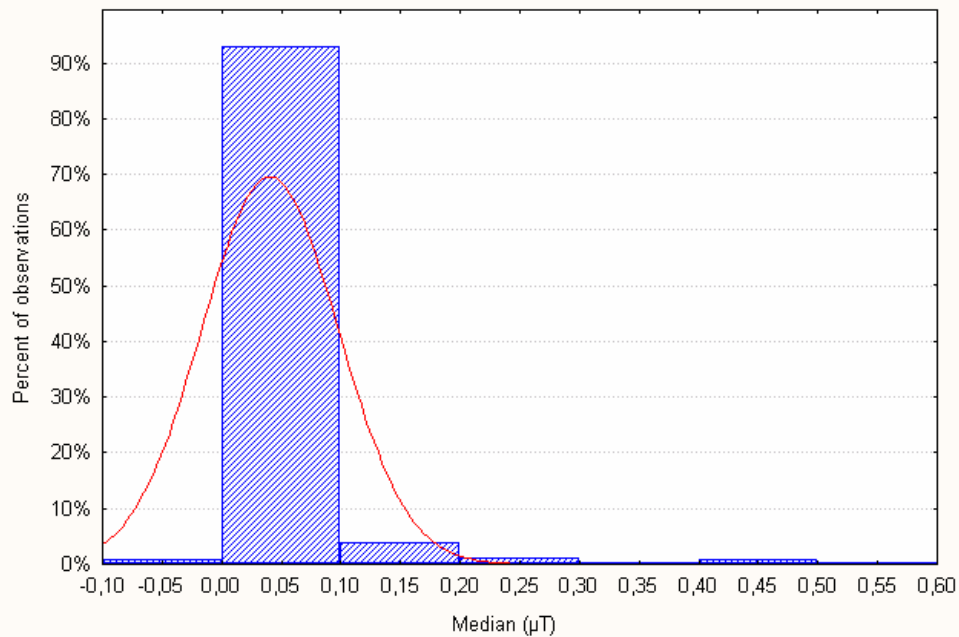

Figure 4: Relative frequency distribution of the median overall B-field exposure of the children

Remember, the overall median summarizes the B-field exposure derived from the registration at home and at school or the kinder garden or the crèche (see point 6 (OVM) of the legend of table 1)

Proportion of children exposed to different epidemiological cut-off points

Table 2 summarizes the percentage of children under different conditions exposed to at least 0.1, 0.2, 0.3 and 0.4 μT respectively. In percentages are recorded for the three different location statistics: the arithmetic mean, the median and the geographic mean.

Table 1: Percentage of children exposed to the different cut off points

Exposure conditions	Estimator	Percentage of children exposed to:			
		0,1 - < 0.2 μT	0,2 - < 0.3 μT	0,3 - < 0.4 μT	$\geq 0,4\mu\text{T}$
1 Before & after school	Ar. mean	13,39	2,36	0,79	3,5
	Median	6,15	2,05	1,23	0,4
	G. Mean	2,49	0,41	0,83	0,4
2 During sleep	Ar. mean	5,14	3,16	0,79	4,7
	Median	4	2	2	4,0
	G. Mean	3,69	2,46	1,23	4,5
3 Overall Home (1 + 2)	Ar. mean	11,46	1,58	0,79	4,3
	Median	6,88	0,81	1,21	2,4
	G. Mean	4,08	0,41	2,45	1,2
4 During school kinder garden or crèche	Ar. mean	5,98	1,28	0,85	2,1
	Median	3,19	0,40	1,20	1,2
	G. Mean	1,77	0,88	0,88	0,4
Averaged exposure (1+2+4) overall	Ar. mean	10,16	2,34	0,39	3,9
	Median	4,42	1,19	0,40	1,8
	G. Mean	4,05	0,40	0,81	0,8

Since nowadays, the 0.4 μT is the cut off of most public concern, the percentage of the lower cut off points of table 2 are not discussed and purely informative. Thus, the next discussion will only be focused on the 0.4 μT cut off point.

From table 2 we deduce that the percentage of the exposure equal or greater than 0.4 μT (last column: $\geq 0.4 \mu\text{T}$) between the different estimators is only coherent when the B-field is recorded during sleep. In this case the percentage of children exposed to at least 0.4 μT varies from 4% by taking the median as best estimator to 4.7% by taking the arithmetic mean as best estimator. When comparing the estimators associated with the exposure of the children before and after school on the one hand and during school, kinder garden or crèche time on the other hand, we observe a big variation in the percentage exceeding at least 0.4 μT . Since these exposure conditions can be considered as a kind of "dynamic exposure" where children can be close or far away from sources with elevated B-field emissions there is a real chance that extreme B-field values influencing the arithmetic mean might be recorded.

On the other hand it is quite normal that during sleep when the ELF-monitor always stays on the same place, bias occurrence is excluded and consequently the arithmetic mean, the median and the geometric mean are nearly equal and are all good estimators of the real B-field exposure of the children during sleep.

When considering the median as the best exposure estimator for estimating the percentage of children exposed to 0.4 μT we observe that:

- 0.4% of children are exposed to at least 0.4 μT at home before and after school, kindergarten or crèche time
- 4% during sleeping time
- 1.2% during school, kindergarten or crèche time
- 2.4% during overall home activities
- 1.8% during the overall home, school or kindergarten or crèche activities

Comparison with international literature

The B-field exposure for epidemiological purposes is recorded in the bed room during the sleeping time of the children. In this respect we have to compare the exposure frequency (%) of our data during sleep (table 2) with the international data (table 3). From this we can conclude that our data, whatever we take as best estimator, are consistent with those of the international literature.

Table 2: Percentage of children exposed to at least 0.4 μT in other countries

Country	Study	N	$\geq 0,4 \mu\text{T}$
Canada	McBride et al, 1999	399	1,6%
Germany	Michaelis et al, 1998	129	2
United Kingdom	UKCCSI, 1999	906	1
USA	Linet et al, 1997	629	3,4
Finland	Verkasalo et al, 1993	35	6,2
Sweden	Feychting & Ahlbom, 1993	39	3,7
Denmark	Olsen & al, 1993	833	6

It has to be stressed that the sample size (N) of the international data is generally small and in some cases much too small in order to draw reliable conclusions about the 0.4 μT exposed proportion in the respective countries.

Power lines' modelled exposure versus household measured exposure

VITO developed a GIS-model (Decat et al., 2003) for estimating the proportion of children living in the 0.4 μT contours produced by the air power line net (70, 150 and 380 kV) in Flanders. Table 4 shows the comparison between the modelled and the measured exposure median.

Table 4: Modelled data of power lines versus measured data of present study

Approach	Percentage of children exposed to 0.4 μT	
	Modelling (worst case situation)	Measurement (during sleep)
% children	1.4	4

It has to be stressed that no B-field emissions from underground cables or other electrical facilities are implied in the modelling. But if we suppose that the modelled percentage would double if these facilities were implied, the measured percentage is still more than 1% greater than the modelled one. This suggests that a relative important fraction of the 0.4 μT exposure is associated with a mixture of indoor and outdoor EMF producing sources. These sources can be underground power or distribution lines, transformer stations, currents in the residence grounding systems and electrical household appliances.

Correlation between field strength and indoor and outdoor explanatory variables

In order to verify if some household appliances, electricity consumption or other factors are related to the B-field exposure a series of correlation analyses has been performed. These analyses were based on the responses of the questioner.

Correlation between the residential exposure and electricity consumption

Figure 5 shows the correlation ($r = 0.14$) between the residential B-field exposure and the electricity consumption.

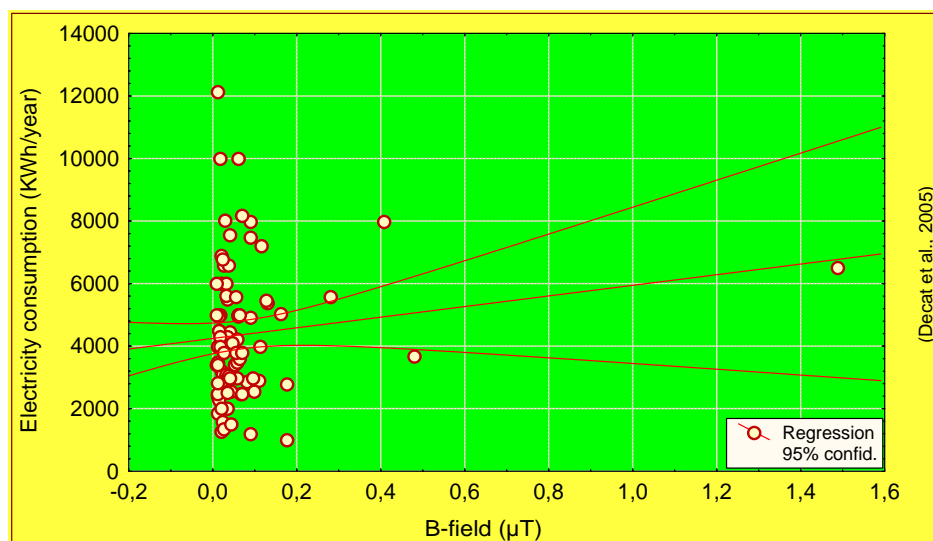

Figure 5: Correlation between the residential B-field exposure and electricity consumption

Since the probe-value ($p = 0.21$) of the t-statistic ($t = 0.3$) exceeds the 0.05 level of significance we have a certainty of 95% that the residential exposure is not correlated with the electricity consumption, however there is 5% chance of being wrong.

If a certain part of the 0.4 exposure would be explained by the B-field emission of household appliances the magnitude of the residential exposure could be expected to increase with increasing electricity consumption. However, since this is not the case it may suggest that:

- the sample size is too small for drawing conclusions about the population correlation
- the sampling wasn't enough randomized
- the participants didn't give the correct information about their electricity consumption

Correlation between the residential exposure and other explanatory

Variables

Table 5 summarizes the correlation between the B-field exposure and some other important explanatory variables. For these tests all categorical variables dealing with dwelling characteristics or locations were quantified by transforming them in dummy variables.

Table 5: Correlation between the residential exposure and different explanatory variables

Explanatory variable	Correlation coefficient (r)	t-statistic	Probe-value (p)
Family income	0.04	0.5	0.6
Dwelling type: flat, terraced house, semi detached house, detached house	0.01	0.14	0.9
House location: within agglomeration out of agglomeration	-0.04	0.5	0.63
Power line location: close to child's home far from to home	-0.03	-0.4	0.7

Since the probe-values all exceed the 0.05 significance level we are 95% confident that there is no correlation between the residential exposure and the tested explanatory variables.

However, mainly the lack of correlation between the power line location close or far away from the residence leads us to the same suggestion we made with the lack of correlation between the exposure and the electricity consumption:

- sample size too small
- sampling not enough randomized
- no correct information from participants

Some considerations about variability and uncertainty

The exposure assessment (EA) of children to the magnetic fields by measurements or calculation is a multi-step process starting with the experimental design (including the choice of instruments/models and corresponding protocols) and ending with data-analysis and reporting. Each step of the EA may be related in a more or less extend to variability and uncertainty. Variability is a property of nature that is related to the heterogeneity, homogeneity or consistency of the values over time, space and subjects. Uncertainty is generally defined as a lack of knowledge about the true value of the real exposure which might be due to the use of measurement errors or other factors. Since variability and uncertainty may have different implications for conclusions, recommendations and decisions one has to be careful not to interpret both concepts in the same way. With the exception of a few particular cases there is always a distinction between variability and uncertainty (Cullen and Frey, 1999). Therefore the two concepts have to be handled separately. Tables 6 and 7 summarise the main factors by which variability and uncertainty might be induced in the present study. Since measured data for the exposure assessment of the present study were compared with modelled data of a previous study (Decat et al., 2003), variability and uncertainty are listed for the measurement (table 6) and the modelling approaches (table 7) respectively.

Since the purpose of this study was not the analysis of the variability and uncertainty (it would be interesting to work on it in a specific uncertainty related study) no attempt was made for quantifying both concepts. Anyway, by taking into consideration the mentioned factors throughout the different steps of the present study, variability and uncertainty might be reduced to a minimum relative to EA's where they are not taken into account. However, exposure assessment will always be associated with variability and uncertainty and it should already mean a great progress if both concepts and mainly uncertainty could be quantified at a reasonable level of confidence.

Table 6: Factors influencing variability and uncertainty in the exposure assessment by measurement

Influencing steps/factors	Variability	Uncertainty about:
Measurement instrument	within certain limits	precision
Measurement protocol	between protocols	use of correct protocol
Experimental design		optimal coverage of all the EA steps for making powerful statistics & conclusions
Man made bias	might induce variation and unrealistic exposure statistics	application of the correct protocol by subject under test
Sampling methodology		optimal randomisation best estimator of real exposure
Sampling over time	temporal variation often occurs	duration of field registration recording (what is the optimal sampling time)
Spatial sampling of B-field in home	exposure often varies from location to location even in homes	the most representative location for defining the real exposure in the house
Individual/subjects	inter-individual variation for EMF-risks may exist	
Data-analysis		correct frequency or probability distribution best estimator of real exposure use of the most powerful statistical test outliers: are extreme data outliers or data generated by seldom occurring events

Table 7: Factors influencing variability and uncertainty in the exposure assessment by modelling

Power line (PL) specifications and configurations	there are a lot of different specifications and configurations which might produce variation	exact specifications and configurations
Current load (CL)	variation within the same type and between different types of PL	minimum, mean and maximum CL best estimator of real temporal CL
Current direction		same or opposite direction
Distance between cables of the same PL	varies with wind conditions	best estimator of the exact distance between cables
Effective voltage	small variation within big variation between PL	
Cable section	variation between PL	
Height of overhead PL	variation within and between PL	best estimator of the exact height between cables
Dept of underground PL		best estimator of the exact dept of cables
Configuration of underground PL	different cables placement producing different field strengths	cable placement configuration
Distance between PL and exposed subject	big variations may occur	

Conclusion

The conclusions of the measurement survey are that:

- the median is the 'best estimator' of the 24 hours' B-field registrations for assessing the real exposure at home, at school or at the kinder garden or crèche
- we are 95% confident that the averaged weighted median of the overall exposure is situated between 0.03 and 0.05 μT .
- our findings agree with those of the international literature: about 4% of the in Belgium living children is exposed to at least 0.4 μT
- the 4% exposure to 0.4 μT isn't a result of power line emissions only, but from a mixture of electromagnetic sources
- any correlation is found between the magnitude of the B-field exposure and the most common explanatory variables possibly related to the B-field exposure
- up to now the sample size is too small for drawing reliable conclusions about the objectives of the experiment
- man-made bias occurs
- there are doubts about the efficiency of the randomisation of the sample

However, since this is an ongoing measurement survey until 2009, the next protocol will be adapted in order to enhance the sample size and the randomisation efficiency and last but not least to avoid as much as possible the man-made bias.

Already at the present state of the survey and certainly at the end of it in 2009, the results are and will be very useful for governmental and non-governmental bodies, stakeholders and other decision makers about the impact of the B-field exposure on public health and/or town, country and environmental planning. In the meanwhile we can perhaps get more information about the emissions of other indoor and outdoor EMF-sources. Then we can make a more reliable comparison between the modelled and the measured data in order to explain which part of the exposure is explained by the transport and distribution of electricity and which part by other sources. Anyway, variability and uncertainty are two different but closely related concepts that researchers and decision-makers always have to keep in mind.

References

1. Ahlbom A, Day N, Feychting M. et al (2000), A pooled analysis of magnetic fields and childhood leukaemia. *Br. J. Cancer* 2000; 83(5):692-8
2. Cullen A.C. and Frey H.C. (1999), *Probabilistic Techniques in Exposure Assessment. A Handbook for Dealing with Variability and Uncertainty in Models and Inputs*. Plenum Press New York and London. ISBN 0-306-45956-6.
3. Decat G., Peeters E., Smolders R., (2003), Tijdsreeks en GIS-model om de blootstelling van de bevolking aan het 50 Hz magnetisch veld gegenereerd door bovengrondse hoogspanningslijnen in kaart te brengen. VMM, MIRA/2003/05. November 2003, p. 1 – 55. (<http://www.vmm.be/servlet/be.coi.gw.servlet.MainServlet/standard?toDo=open&id=3102&&>)
4. Greenland S, Sheppard AR, Kaune WT, Poole C, Kelsh MA. (2000). A pooled analysis of magnetic fields, wire codes, and childhood leukemia. *Epidemiology* 2000; 11(6):624-34.
5. Wertheimer N. and Leeper E. (1979), Electrical wiring configurations and childhood cancer. *Am. J. Epidemiol.* 1979; 109(3):273-84.

DOSIMETRY UNCERTAINTY OF PRESENT RF TECHNOLOGIES

K. Pokovic

SPEAG, Zurich, Switzerland

Human exposure evaluations become an eminent legal component when performed for demonstrating compliance with safety limits, especially in the context of strong public reservations against any electromagnetic exposure. Typical exposure values close to the legal limits place another quality of requirements on the evaluation equipment/procedures with respect to scientific soundness and reliability compared to other similar test requirements (e.g., EMC/EMI, radiation assessment, etc.). Hence, all current standards, guidelines and specifications for dosimetric evaluations of mobile telecommunications equipment request that the uncertainty must be considered in determination of compliance with the safety limits.

Methods for evaluating and expressing uncertainty in measurements can be found in the NIST Technical Note 1297. As explained in TN1297 the components of uncertainty may be categorized according to the method used to evaluate them. The evaluation of uncertainty by the statistical analysis of a series of observations is termed a Type A evaluation of uncertainty. The evaluation of uncertainty by other means is termed a Type B evaluation of uncertainty. Each component of uncertainty, however evaluated, is represented by an estimated standard deviation, termed standard uncertainty, equal to the positive square root of the estimated variance.

The combined standard uncertainty of the measurement result represents the estimated standard deviation of the result. It is obtained by combining the individual standard uncertainties of both Type A and Type B evaluations using the usual "root-sum-squares" method. Expanded uncertainty is a measure of uncertainty that defines an interval around the measurement result within which the measured value is confidently believed to lie. It is obtained by multiplying the combined standard uncertainty by a coverage factor. Typically, the coverage factor for EMC assessments is 2 reflecting approximately 95% confidence level.

The applications of these methods are not simple in case of complex measurement tasks. The objective of this presentation is to outline, as an example, the developed concept with which the total uncertainty of any SAR system for compliance testing can be analyzed and determined. The developed concept is based on specific approximation formulas that translate Type B tolerances (e.g., mm, conductivities, etc.) directly into SAR tolerances. Only when unavoidable, Type A tolerances are employed. This procure allow any test house to determine the total uncertainty in a straightforward manner.

UNCERTAINTY OF MEASUREMENTS DEVICES CALIBRATION

Krzysztof Gryz, Jolanta Karpowicz

Central Institute for Labour Protection – National Research Institute, Laboratory of Electromagnetic Hazards
Warszawa, Poland krzys@ciop.pl

Abstract

Reliable calibration of the various instruments used for measuring electromagnetic fields (EMF) is essential to ensure safety of exposed personnel and to assure compliance with exposure criteria and regulations, concerning EMF emission testing or EMF exposure limitation. Existing calibration methods are based on the premise that a known field strength can be established through measurement, calculation or a combination of both. Electromagnetic field meters can be calibrated with the use of different methods of calibration:

- calibration using the transfer standard known as the standard probe method
- calibration using calculated field strength known as the standard field method
- calibration using a primary standard sensor.

In the first method, the transfer standard is represented by field sensor probe or similar to the one being calibrated. The transfer standard is used to measure and calibrate the field used for calibrating the field sensor or probe under calibration.

In the second method, the probe under calibration is located in a reference field of the value calculated from the geometry of the field source structure and parameters of electrical signal supplying the field source.

In the third method, the primary standard contains no active or passive electronic devices with a response that is mathematically calculated from the shape, size and Maxwell's equations. A primary standard sensor is used to determine the field strength that is used to calibrate probe under calibration.

The choice of technique depends on the type and size of the probe, frequency range, available facilities and equipment, and the accuracy requirements.

The most popular is a calibration with the use of standard field method. Usually to generate the reference standard fields for probe and sensor calibration are used

- electromagnet for static magnetic field
- Helmholtz coils for static and time-varying magnetic field up approx. a few MHz
- parallel plate capacitor for electric field up to approx. a few MHz
- TEM cell for electric and magnetic field. up to approx 200 (500) MHz
- GTEM cell for electric and magnetic field. up to approx a few GHz.

Factors that could be taken into account while discussing the uncertainty of calibration are e.g.:

- field spatial distribution inside reference field source
- standing wave inside the reference field source
- field distortion and coupling between calibrated probe and reference field source's structure
- calibrated probe positioning
- uncertainty of measurements of current or voltage or power used to specifying the reference field strength value
- spectrum components of signal supplying the field source (from generator, amplifier).

The number of influenced factors and the uncertainty of calibration increase with the frequency of generating reference field. For low frequency, it is possible to carry out calibration of electric or magnetic fields meter with expanded uncertainty on the level of a few percent. Achievable expanded uncertainty of calibration in the radiofrequency range is no less than approx. 10-15%.

References

1. Guide to the Expression of Uncertainty in Measurements, ISO, 1995.
2. European cooperation for Accreditation. Expression of the Uncertainty of Measurements in Calibration, EA-4/02, December 1999.

-
3. IEEE Recommended Practice for Measurements and Computations of Radio Frequency Electromagnetic Fields with Respect to Human Exposure to Such Fields, 100 kHz-300 GHz. IEEE Std C95.3 2002.
 4. IEEE Standard for Calibration of Electromagnetic Field Sensors and Probes, Excluding Antennas, from 9 kHz to 40 GHz. IEEE Std 1309. 2005

INVESTIGATIONS WITH PERSONAL RF DOSIMETER

György Thuroczy

Natl. Research Institute for Radiobiology and Radiohygiene, Budapest, Hungary

More than ninety percent (90 %) of the population in Hungary has a mobile phone. The typical user lives in the capital, Budapest. In our earlier survey study we made spot RF measurements by portable spectrum analyzer and broadband field RF meters for exposure assessment in the living area. Within present study the aims were to investigate the applicability of the RF Dosimeter (RF Personal ExposiMeter - PEM) for human exposure assessment in the real urban environment, to investigate the proper protocols of the data recordings and the possible process in the evaluation of the recorded data. Moreover we intend to evaluate the weaknesses of the PEM device in order to provide advice for further technological improvement.

Methods

N=21 participants (plus 4 pilot study, 2 eliminated by technical reasons) were involved in the study, all of them having residency in Budapest (capital, 2.5 million inhabitants). All participants had to manage their time-activity diary following the form designed for the study. The time period of the survey was June-July, 2005, for 24 hours recording by each subject. Antennessa DSP-090 personal exposure meter was used in the study with 15 sec recording sample rate. The RF personal dosimeter has 0,05 V/m detection threshold and frequency selective RF exposure recordings with the following nine RF bands: FM (88 to 108 MHz), TV (174 to 223 MHz) and (470-830 MHz), GSM 900 Tx (up) (875-915 MHz) and Rx (935-960 MHz), GSM1800 Tx (1710-1795 MHz) and Rx (1805-1880 MHz) UMTS Tx (1920-1980 MHz) and Rx (2110-2170 MHz). The RF personal dosimeter was mounted on the body and /or in a carry bag. Fixed location was near the bed at night and close to subject indoors (i.e. on the desk, table etc.). The following parameters were evaluated: duration of (exposure, activity) time (min), field intensity (V/m): max., arithmetic mean, S.D., time weighted average (TWA). The exposure metrics were also analyzed according to: frequency bands (channels), different time periods by activity as (1)home (2)bed (3)travel (4)work (5)other/else.

Results

One third of the participants spent 40-70 % percent of 24h recording time above the detection limits ($E \geq 0.05$ V/m) and half of subjects spent less than 10 %. The highest exposure was detected during the travelling period and less in the bed at home.

Conclusion

Further discussion and investigation are needed for the development of the device in the size/weight, the co-channel response, isotropy close to the body and detection threshold.