

10TH INTERNATIONAL COMMAND AND CONTROL RESEARCH AND
TECHNOLOGY SYMPOSIUM
THE FUTURE OF C2

Command Post Anywhere Experiment – Exploiting the use of TeamSight for Ops
Concepts

Topic: Command & Control, Experimentation

Authors: Cheah, Mervyn; Chew, Lock Pin; Fong, Gwenda; Teh, Cheryl Ann;
Toh, Elsie

Singapore Armed Forces Centre For Military Experimentation
Future Systems Directorate
AFPN 1193
311 Stagmont Road
Singapore 688794

*Same affiliation and address applies to all authors of this paper

Telephone: 65-6761 1396

Fax: 65-6761 1396

Report Documentation Page

*Form Approved
OMB No. 0704-0188*

Public reporting burden for the collection of information is estimated to average 1 hour per response, including the time for reviewing instructions, searching existing data sources, gathering and maintaining the data needed, and completing and reviewing the collection of information. Send comments regarding this burden estimate or any other aspect of this collection of information, including suggestions for reducing this burden, to Washington Headquarters Services, Directorate for Information Operations and Reports, 1215 Jefferson Davis Highway, Suite 1204, Arlington VA 22202-4302. Respondents should be aware that notwithstanding any other provision of law, no person shall be subject to a penalty for failing to comply with a collection of information if it does not display a currently valid OMB control number.

1. REPORT DATE JUN 2005	2. REPORT TYPE	3. DATES COVERED 00-00-2005 to 00-00-2005			
4. TITLE AND SUBTITLE Command Post Anywhere Experiment - Exploiting the use of TeamSight for Ops Concepts		5a. CONTRACT NUMBER			
		5b. GRANT NUMBER			
		5c. PROGRAM ELEMENT NUMBER			
6. AUTHOR(S)		5d. PROJECT NUMBER			
		5e. TASK NUMBER			
		5f. WORK UNIT NUMBER			
7. PERFORMING ORGANIZATION NAME(S) AND ADDRESS(ES) Singapore Armed Forces Centre fro Military Experimentation,Future Systems Directorate AFPN 1193,311 Stagmont Road,Singapore 688794, ,		8. PERFORMING ORGANIZATION REPORT NUMBER			
9. SPONSORING/MONITORING AGENCY NAME(S) AND ADDRESS(ES)		10. SPONSOR/MONITOR'S ACRONYM(S)			
		11. SPONSOR/MONITOR'S REPORT NUMBER(S)			
12. DISTRIBUTION/AVAILABILITY STATEMENT Approved for public release; distribution unlimited					
13. SUPPLEMENTARY NOTES The original document contains color images.					
14. ABSTRACT					
15. SUBJECT TERMS					
16. SECURITY CLASSIFICATION OF:			17. LIMITATION OF ABSTRACT	18. NUMBER OF PAGES 35	19a. NAME OF RESPONSIBLE PERSON
a. REPORT unclassified	b. ABSTRACT unclassified	c. THIS PAGE unclassified			

ABSTRACT

The concept of Command Post Anywhere is to be able to disperse the Brigade Command Post (CP) footprint to the forces so that command is everywhere and the Command Post is no longer a place for the enemy to detect and destroy. Every functional cell of the Brigade CP operates physically apart from each other over wide distances in an area of operation, but is still connected wirelessly with one another via TeamSight – a collaborative environment consisting of a team operating picture and a suite of communication tools. This idea was fielded in an experiment in conjunction with an Armoured Brigade CP exercise conducted from 21-23 Oct 2004.

In evaluating the feasibility of CPA, several aspects were considered: sensemaking ability, situation awareness, operational tempo and survivability. The findings from this experiment, as determined by three measures (communication activity, situation awareness assessments and contextual inquiry) successfully demonstrated that CPA supported by TeamSight is indeed a viable concept.

INTRODUCTION

A Command Post is an organization of people and systems by which a commander exercises his Command and Control (C2) of forces. We often associate it with fixed physical structures but this mental construct is based on yesterday's technology and equipment that require fixed structures to contain and operate. In the NEW (Network-Enabled Warfare) age, a Command Post is more appropriately seen as an information structure supporting rich communication and collaboration between a Commander and his staff, regardless of physical separation. Modern technology affords the ability to reconstitute existing structures to overcome physical constraints and to improve the information flow between key personnel in a Command Post.

BACKGROUND

The concept of Command Post Anywhere (CPA) is an effort to move away from traditional tenets of what constitutes a command post, of which the major ones are described below.

Physical Co-location

It has long been accepted that a command post serves the function of a physical meeting place for the commander to confer with his staff. Each Principal Staff Officer (PSO) has dedicated sources of information and area of expertise to assist the commander in decision-making; hence the need for the command team to meet for the purpose of exchanging and sharing knowledge. Currently, the primary means to support the complex and interactive nature of discussions is face-to-face communication between a physically co-located team. However, with modern technology offering greater bandwidths for communication and data throughput, it is possible for individuals separated in space to communicate and collaborate via these tools as if they were physically co-located.

Command Brief

In a similar vein, the practice of conducting a command brief at periodic intervals – gathering of the principal staff to update each other and Commander on recent developments, exists in a command post of today. However, this may not be necessary if the team is constantly communicating with each other via the above-mentioned communication and collaboration tools. Collation and analysis of information can be performed and disseminated in real time among the command staff, instead of waiting for the scheduled briefs as is the current practice.

Hierarchical Command Structure

A conventional command post is organized hierarchically in order to handle the high complexity of war-fighting by delegation of authority to sub-commands – the principle of divide and conquer. This need for delegation is a function of the complexity of the problem space. It is manifested in the way PSOs currently update and receive guidance from Commander primarily at the scheduled command briefs, instead of being able to exchange information continually between Cells (including Commander cell).

Sequential Planning

In addition, it is assumed that hierarchical CPs have to work in sequence, i.e. higher commands cascade plans downwards to ensure higher-order intent is met by ground units. A process strings together the decision products of these hierarchical CPs. Hence, the Operations Order developed by a Brigade is handed to the Battalion HQ, which in turn will develop their sub-level intent and plans and so on. While some parallel planning is attempted today, the process is by and large sequential to ensure that coordination points are properly dealt with. This could be a result of current technology not being able to support the high degree of coordination that needs to occur between horizontal domains and vertical command structures.

Brigade Main vs. Tactical CP

Lastly, and perhaps most importantly, an organization like the Brigade commands and controls forces spanning 15-30 km in depth and 10-20 km in width. With such a wide area of operation, a Brigade CP is often separated into the Main and Tactical CPs. The Brigade Commander is usually positioned right up at the front with his front forces (manoeuvre units) to feel the battle, provide a command presence and to make critical decisions regarding activation of reserves or request for reinforcements. It would however be impractical for Commander to bring his entire command team with him as it would be too big a target and very immobile; hence, only the FSCOORD and the S2 follows him, while the rest remain static at the Brigade Main CP to manage resources. Clearly, in such an arrangement, the mobility of Commander and his team is constrained by the ability to establish communication links between the front forces, Brigade Main CP and the Commander.

COMMAND POST ANYWHERE

The idea of CPA is to be able to disperse the Brigade CP footprint to the forces so that command is everywhere and the Command Post is no longer a place for the enemy to detect and destroy. Every functional cell of the Brigade HQ operates physically apart

from each other¹ over wide distances in an Area of Operation (AO), but is still connected wirelessly with one another. This connection enables the sharing of a common operating picture and allows personnel in each cell to conduct meaningful collaboration at all times. The technological environment that supports this capability is described below under 'TeamSight'. In essence, CPA presents a fundamental contrast with the conventional concept of the Centralised Command Post, where the cells are physically co-located with the Commander and not usually mobile. It is founded on previous attempts at experimenting with a similar concept (Gorman, 1980), with the added benefit of technological advancements in our present times.

This move towards adopting the CPA concept is driven by two main impetuses. Firstly, there is a need to enhance battlefield survivability. In both the current and future battlefield, it is envisaged that the Brigade HQ's Tactical Ops Center's (BTOC) conventional centralized configuration would offer too large and lucrative a target for the adversary to identify and strike. There is therefore a real need to significantly reduce this operating footprint, so as to enhance the BTOC's battlefield survivability. One means afforded by technology is to physically distribute and disperse the cells, while remaining virtually connected.

Secondly, enhanced command and control could potentially be enabled by distribution. The ability of the Brigade Commander and Principal Staff Officers (PSOs) to operate physically distributed over a 25-30 km radius also allows the Brigade HQ to be positioned at decisive and critical points within the Brigade's Area of Operation (AO) to exercise command emphasis, allocate resource support to the battalions, CS and CSS elements, etc. More importantly, the distributed Brigade HQ's span of influence is likely to be more effective as compared to the conventional centralized BTOC, as the BTOC would no longer be bound to a single location². The distributed BTOC would allow the Commander and the respective PSOs to optimize their locations to exercise the most effective influence on the battlefield. To illustrate, the Commander could be positioned with the Brigade's main effort to offer command guidance; the S2 could be positioned at a vantage point to receive enemy input and offer updates to the fighting units; the S3 could be located with the Brigade's Reserve ABG, co-ordinating its launch at the decisive time and place; the S4 could remain with the Combat Service Support elements right behind and the FSCOORD with the forward FSO or with the guns. Regardless of their locations, the Commander and his PSOs would still be capable of virtual collaboration with one another through the TeamSight environment as described below.

¹ A typical Armoured Brigade HQ is composed of the Ops, Intelligence, CSS and FSCC cells, located at each corner of the Brigade Tactical Ops Centre (BTOC), with a Command and Control Centre in the middle.

² Currently, the location of the centralised BTOC is governed to a large extent by communications considerations. The centralized BTOC infrastructure is also cumbersome to deploy and displace, and could hamper the Brigade Commander's ability to effectively command and control the Brigade's fighting units.

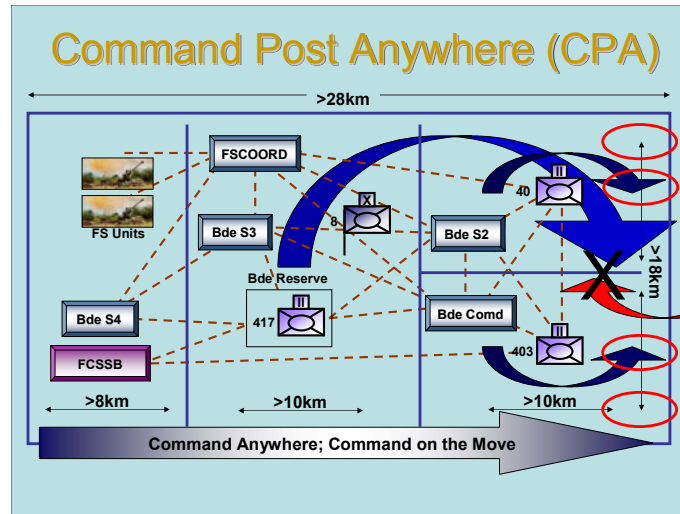

Figure 1. CPA concept

Essentially, CPA enables us to break mindsets that were structured by limitations in current technology and archaic ideas. It is the model of next warfare Command Team at the Battalion, Brigade and even Division levels, centered around the idea of Command on-the-move whereby the Command Post can be with the forces and optimal positioning of Brigade staff can increase battlefield co-ordination and command and control. CPA is effectively supported by the TeamSight environment, which attempts to level the sensemaking capability of the Command Team with that of the physical Command Post of today.

TEAMSIGHT

TeamSight enables the Brigade Commander, as the most experienced officer on the field, to have a separate view of each of his staff's screens, and not just an aggregated picture that may be missing some important details. Essentially, it consists of the Team Operational Picture, Team Power Board, and communication tools like video-conferencing, text-chat and emails that work together to provide the Command Team with continuous and shared situation awareness.

The Team Operational Picture (TOP) is a GIS-based collaborative tool that allows every individual to have his own workspace for situational constructs and collaboration, and at the same time able to see and understand, and collaborate on the situational constructs of others in his team by viewing their workspaces. One advantage of the TOP is that it reduces the need to disseminate information during a preset meeting, given that the user is able to monitor the current situation (the status of the various manoeuvre units are displayed) and real-time planning products of his counterparts in the Command Team.

Another main feature of TOP is the provision of each PSO and staff with individual workspaces as opposed to making everyone adopt a Brigade-level Operating Picture. By virtue of differing responsibilities and area of operations, the Manoeuvre CO would require more details in terms of terrain, forces and a zoom-in of his area of operations compared to the Brigade Commander. Similarly, the Brigade S2 is required to plot

detailed enemy deployment and perform terrain analysis, tasks that would clutter the Brigade Operating Picture screen. The solution adopted by TeamSight is to have separate workspaces for each staff, accompanied by an aggregated Brigade Operating Picture for the Brigade Commander to gain an overview of the situation. Such an environment allows the command team to actively fuse their individual pieces of information to generate new knowledge or to obtain a common value for existing information, thus giving rise to “collaboratively generated information” based on information elements actively shared via voice or video conferencing or simply placed on the network for retrieval when necessary (Kingston & Martell, 2004).

Having multiple workspaces available to be viewed by any user of the system is also in line with “the established wisdom that commanders and planners must visualize the battle two echelons down and understand it from the perspective of the commander two echelons higher” (de Czege & Biever, 2001) as well as that of adjacent organizations.

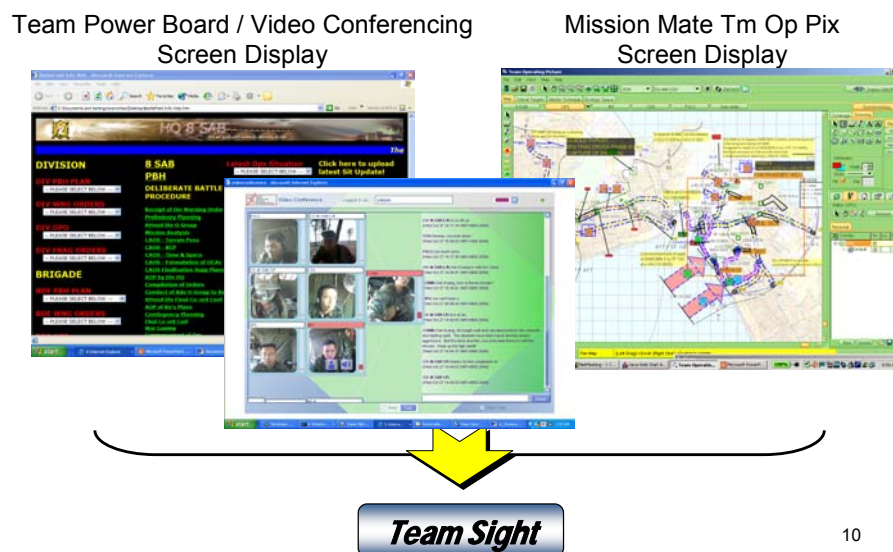

Figure 2. Components of TeamSight

DISTRIBUTED HUBBING (D-HUBBING)

As an operating concept, D-Hubbing is the first step towards attaining the larger goal of Command Post Anywhere – basically, it involves a distributed operation without the element of mobility.

This concept was tested in conjunction with an Armoured Brigade Command Post exercise conducted at Shoalwater Bay Training Area (Australia) from 21-23 Oct, 2004.

EXPERIMENT OBJECTIVES

There are three key hypotheses we wanted to investigate in this experiment:

- a. **D-hubbing augmented with TeamSight will have the same sensemaking ability as a Centralised CP.** For the purpose of this experiment, sensemaking is quantified in the form of situation awareness level possessed by members of the Brigade HQ, and indicated by the content of communication between and within the cells.
- b. **D-hubbing augmented with TeamSight will provide continuous situation awareness thereby increasing the operational tempo of the Brigade.** In addition to regularly administered situation awareness questionnaires, supporting evidence will largely be of an anecdotal nature
- c. **D-hubbing will enhance Brigade CP survivability with increased physical separation of the Cells.**

MEASURES & METHODS

A total of three measures were employed in the course of the experiment.

1. **Situation Awareness (SA) Assessment.** It was deemed instructive to obtain a measure of situation awareness (SA) levels in each cell for each setup. This would provide an indication of whether the PSOs were able to maintain a comparable level of SA (i.e. no significant difference between SA levels) regardless of the distance between the cells and the communication means made available to them. It is assumed that maintaining an awareness of the situation picture is necessary for making and executing decisions; however in this case, aspects of decision-making were not assessed. It is also assumed that a higher level of SA is correlated at least with the speed of decisions, if not quality, giving rise to superior ops tempo. Whether this relationship indeed exists will be investigated in subsequent experiments.

An adaptation of the Situation Awareness Global Assessment (Endsley, 1995) was used to evaluate level of SA. This measure is also based on Endsley's model of SA: Level 1 (Perception), Level 2 (Comprehension) and Level 3 (Projection) of information elements, and was first fielded in a similar Division-level exercise (Teo et al., 2004). At various times when an assessment of SA was deemed appropriate, SAGAT questionnaires were administered to the Brigade Commander and his principal staff officers.

2. **Analysis of Communication Patterns.** To better elucidate information flow at both the inter- and intra-cell levels, communication activity was monitored for the duration of each experimental run. This was done via two methods: observer ratings and recordings of all communication activity that took place.

- (i) The two observers in each cell monitored the communication activity that took place within the cell and between cells. Each observer kept a log of the transactions that

took place and completed a subjective rating template every 30 minutes to reflect the various types of communication in the most recent time interval:

- (1) Dissemination of Information
- (2) Clarification
- (3) Exchange of Ideas
- (4) Building of Shared Understanding
- (5) Team Monitoring and Self-Correction
- (6) Others

Behaviorally Anchored Rating Scale (BARS). An observation template was handed out to the observers at the start of each run. A Behaviorally Anchored Rating Scale (Alberts and Hayes, 2002) was employed to record the different proportions of each type of communication activity, where each number on a scale of 1-5 is associated with explicitly described behavioral indicators to guide judgment. This enabled a certain degree of numerical comparison based on the value averaged across all observers for each category.

(ii) In addition to observer ratings, all the communications that took place both face-to-face and via other means (text chat, video conferencing, voice via VHF radio) were also recorded to facilitate subsequent objective analysis of the communication patterns.

3. **Contextual Inquiry** (Holtzblatt and Jones, 1993). Post-hoc interviews with the Brigade Commander and PSOs conducted at the end of each experimental run according to a structured field interviewing method served to supplement and fill in the gaps in observations. At the end of the exercise, an AAR (After-Action Review) was held to elicit feedback from the Brigade PSOs on their perceived ease of operation in the various setups.

Preparation for Experiment

Prior to the exercise, the Brigade was trained for approximately 3 days in the usage of the MissionMate system for the purpose of employing TeamSight in a distributed environment. In addition, they had also gone through two exercises with the same system in the months leading up to this exercise. This ensured they were reasonably proficient in operating the system during Ex WALLABY 04.

EXPERIMENTAL CONDITIONS

The experiment took place from 21- 23 Oct 04 during Ex WALLABY 04. A total of 6 runs were conducted with 2 runs per day. Over the course of the runs each lasting 2.5-3 hours, the Brigade HQ had to plan, execute and co-ordinate Brigade-level tasks.

Run 1

The first run was conducted with the Brigade HQ operating in a centralized CP setup to serve as a baseline for comparison with subsequent D-hub setups. The layout was similar

to a conventional Armoured Brigade CP set-up with a footprint of 30m x 25m, clustered in a wired LAN environment (See figure 3 below).

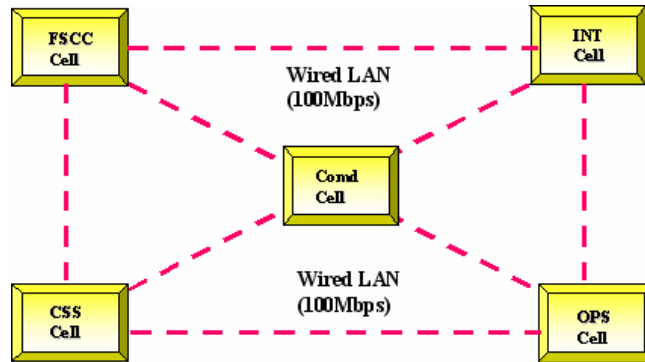

Figure 3. Centralised CP Configuration for Run 1

Run 2

Run 2 was not conducted due to inclement weather. Instead, the technology linkages were set up and tested in preparation for subsequent runs.

Run 3

For this and all three subsequent Runs, the Brigade was split up into 2 main clusters separated by a distance of 10 KM. The main cluster consisted of the Commander, the Int (S2) and Ops (S3) Cells, while the other cluster consisted of the FSCC and the CSS Cells. Within each cluster, the Cells were further separated from 1- 2 KM. To enable this layout, a high bandwidth wide area communications was employed. Within the cluster, wireless LAN of 802.11 standards was employed, while between the clusters, another form of wireless line-of-sight communications (OFDM) of 802.16 standards was used. See Figure 4 below.

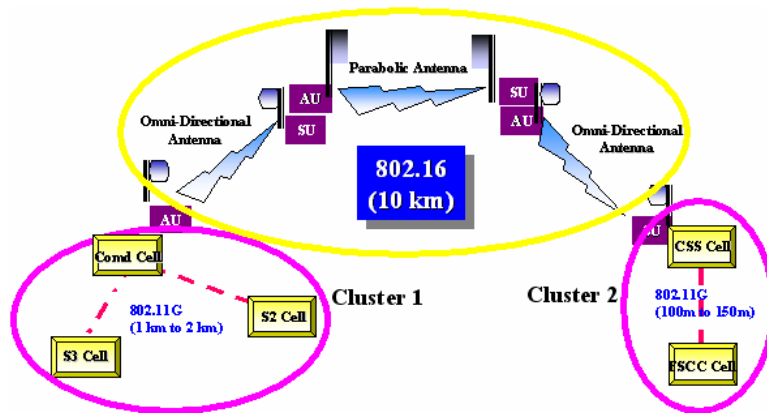

Figure 4. D-Hub Configuration for a 10 KM Brigade CP footprint

In each cell, the PSO (Commander, S2, S3, FSCOORD, S4 and OC Signal) was given 2 to 3 screens to support the TeamSight environment. For this run, all the communication means were activated – video conferencing, text chat and TOP, along with voice capabilities via VHF.

Run 4

In this run, the full suite of communication tools was again made available to the Brigade as in run 3. However, the Brigade Commander was not around; this provided an opportunity to observe the ability of the remaining Brigade staff to self-synchronize in the absence of Commander.

Run 5

For this run, it was intended to investigate the feasibility and success of operating in a D-hub environment under conditions of degraded network performance. The video conferencing and text chat capabilities were removed, with communication allowed only via VHF and the TOP.

Run 6

A number of different conditions were incorporated into the final run. Firstly, the ideal D-Hub configuration was further disrupted by disabling both VHF communication and video conferencing, resulting in purely ‘silent collaboration’ (via text chat) between the cells. Secondly, at two points during the run, the communications links to the various cells were intentionally disrupted: S2’s link was disabled from 1400 hrs to 1455 hrs; next, from 1500 to 1600 hrs, S2’s link was reestablished while S3’s link was disabled instead. The intent of these injects was to assess the Brigade HQ’s ability to quickly adapt, self-synchronize and assume additional responsibilities so as to continue the effective conduct of planning and execution.

FINDINGS

A. Communication Activity

Figure 5a shows a comparison of team communication activity between the Centralized CP setup (run 1) and the different D-Hub CP setups (runs 3-6) The percentages were derived from averaging all the observer ratings at various times in each setup.

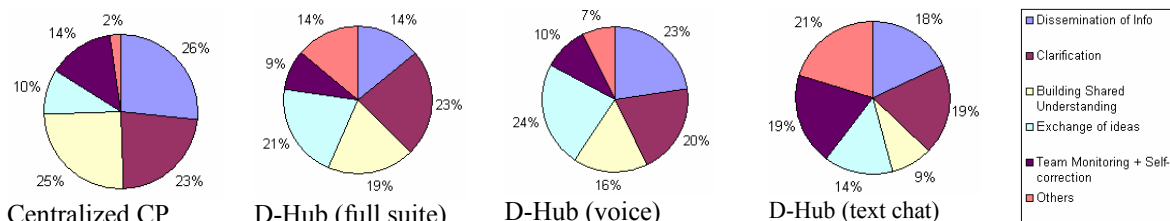

Figure 5a. Pie charts showing communication activity (observer ratings) in each setup

Significance Testing. A non-parametric test (Friedman test) for more than 3 matched sample groups was used to test for significant differences between observer ratings of each type of communication activity for the centralized versus D-hub CPs. The results are shown in Figure 5b below.

Test Variable	P value
Dissemination	0.345
Clarification	0.801
Exchange Ideas	0.145
Building Shared Understanding	0.122
Team Monitoring & Self-Correction	0.293

Figure 5b. Result of Friedman Test (centralized vs. various d-hub setups)

As can be seen from the p-values, the difference between the different setups (centralized and 3 D-hub setups) for each category of communication is not significant. When a pairwise comparison using Wilcoxon Signed Ranks test was performed on the setups, it was found that only the difference between the Centralized CP and D-hub (full suite) setup neared significance (at 90% level) in several categories of communication (see Appendix Figure 3). Specifically, there was greater proportion of communication devoted to exchange of ideas ($p=0.109$) with correspondingly lesser proportion on dissemination and building shared understanding ($p=0.109$, $p=0.102$ respectively) in the Centralized CP setup as compared to D-hub CP with full suite of TeamSight tools.

Inter-rater Agreement. For centralized CP setup, the inter-rater agreement between the 10 observers (all observing the same thing unlike in D-hub setups) was found to be moderate, as based on Kendall's coefficient of concordance, $W = 0.450$ (see Appendix Figure 2). Since there were only 2 observers per cell for each of the D-hub CP setups, this factor was not considered in analyzing the results from runs 3-6.

Communication Recordings

The following communication recordings were obtained – video of Commander's interactions during Run 1; text chat logs of Runs 3, 4, and 6; voice recordings of Runs 3, 4, and 5. Each of these recordings was first transcribed before it was analyzed according to the same categorization of communication activity as developed in the observation template (see Appendix Figure 1).

This method of tracking communication activity also provides a deeper insight into usage of the various communication means. During Runs 3 & 4, dissemination of information was achieved more via text chat (26% compared to 19% of voice communications) while the building of shared understanding was supported more through voice communications (45% compared to 30% of text chat).

Agreement with Observer Ratings. It was found that the agreement between the communication recordings and observer ratings for the centralized CP ratings is high (Kendall's Coefficient of Concordance, $W=0.886$). This statistic was not calculated for the D-hub setups since the observers were all in different cells.

B. Level of Situation Awareness

Comparison of SA levels across various setups. Figure 6 shows the comparison of the average SA levels of Commander, S2, and S3 across the various CP set-ups. SA levels decreased when fewer means of communication were made available to the Command Team. In each setup, Level 1 SA was higher than Level 2&3 SA, except for the setup with only text chat (no voice).

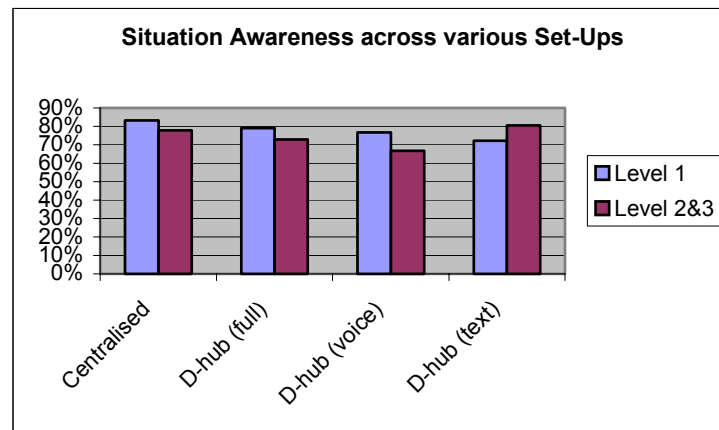

Figure 6. SA levels across various CP setups

Significance Testing. Again, the Friedman test for significance was used to identify significant differences between SA levels for each run. Across the 4 runs (not including run 4 due to only 1 SAGAT administration), there was no significant difference for both Level 1 and Level 2/3 SA levels ($p=0.591$, $p=0.202$ respectively) (see Appendix Figure 4).

Again, when a pair-wise comparison was performed using the Wilcoxon Signed Ranks test for 2 paired groups, it was found that Level 2/3 SA of D-hub (text chat only) was significantly higher than that of both the D-hub (full suite) and D-hub (voice only) ($p=0.066$, $p=0.102$ respectively). (see Appendix Figure 6)

Comparison between two SAGAT administrations in each run

Since 2 SAGAT questionnaires were administered for each run (except run 4), it would be interesting to observe whether there was a difference in scores between the two administrations, assuming an equal level of difficulty in questions for each SAGAT (see Appendix Figure 5).

The increase in SA levels going from the 1st to the 2nd administration for each run across all roles could perhaps be attributed to a better understanding of the situation picture with the availability of TeamSight as the run progresses.

DISCUSSION

The statistical findings coupled with anecdotal evidence support the hypotheses put forth prior to the experiment:

a. **D-hubbing augmented with TeamSight provides the Command Team with the same sensemaking ability as in a Centralised CP.** For this purpose, the nature of communication activity taking place within the team and their level of situation awareness are indicative of the sensemaking ability of the Command Team. Statistical tests on the SA levels and communication profiles showed no differences in the Centralised CP as compared to the various D-hub setups, suggesting that TeamSight effectively facilitates sensemaking despite distributed operation of the Bde CP.

Observations made during the experiment elucidated some differences in the communication patterns between the Centralised CP and D-hub CP. There was a greater proportion of communication devoted to the exchange of ideas with correspondingly lesser proportion on dissemination and building shared understanding in the Centralized CP as compared to the D-hub CP with full suite of TeamSight tools. This could be a result of operating in the TeamSight environment – aided by the TOP, there is a reduced need for Commander and the PSOs to explicitly disseminate information and build shared understanding, thus freeing up the time to exchange ideas.

The communication recordings provided an insight into the usage of the various communication tools for different purposes. It was observed that in the D-hub setup (full suite), dissemination of information was achieved more via text chat while the building of shared understanding was supported more through voice communications.

In an attempt to correlate communication means with SA levels, it was found that Level 2/3 SA of D-hub (text chat only) was significantly higher than that of both the D-hub (full suite). This could be a result of text chat generating a record of the updates, discussions and deliberations between the cells that transpired during the run, allowing Commander and PSOs to refer back when necessary. In fact, this was reported by some of the PSOs as a notable advantage of text chat over voice or video-conferencing, although others preferred video-conferencing for its interactive value.

Subsequent experiments will be conducted to further investigate the relationship between communication patterns, SA levels and sensemaking ability, as well as how they translate into performance measures such as decision quality.

b. **D-hubbing augmented with TeamSight will provide continuous situation awareness thereby increasing the operational tempo of the Brigade.** In the Centralised CP, the Commander walked around to confer with the various PSOs separately before the scheduled Command Brief. This was observed to be an information bottleneck – there were occasions when some PSOs worked on their respective plans without awareness of the relevant updated information due to the staggered meetings. Another issue of interest was the time-resource dilemma faced by the PSOs when

working in a Centralized CP setup - they had to attend the scheduled Command Briefs while dealing with the urgency of having to complete certain tasks or provide guidance to their staff.

With a D-hub CP setup, the PSOs and Commander are operating within the collaborative TeamSight environment. This would enable them to collectively be aware of the current situation, as well as switch rapidly between their specific responsibilities and updating the rest of the team.

The ability of TeamSight in support of D-hub setup was further tested in Run 6 where links to various cells were disabled in turn. It was found that the team was able to self-synchronize and compensate for the disabled cell. For example, when the S2 Cell was down for an hour, intelligence reports were disseminated to all other cells instead. This ensured that the rest of the CP was made aware of the enemy updates promptly, such that when the link to S2 cell was restored, he was able to reassume his role quickly.

Clearly, technology plays an integral role in enabling the success of a D-hub CP. This presents a challenge in that all systems and supporting components have to function optimally in order for situation awareness, sensemaking ability and operational tempo to be maintained.

c. **D-hubbing enhances Brigade CP survivability with increased physical separation of the Cells.** The Bde CP was distributed over a distance of 10KM, with each cell comprising only a tent and an armoured vehicle. The small size and distributed location of each cell greatly reduces the visual signature of the Command Post as compared to the conventional cluster of tents and vehicles, making it less detectable from the air (as noted by visitors who were flown in by helicopter). One potential drawback of the physical separation of cells is the accompanying high volume of communication traffic between cells that could possibly result in an increased electromagnetic signature. This will be investigated in subsequent experiments.

CONCLUSION

This experiment is a culmination of a series of smaller scale exercises in which the D-hub concept was tested in a TeamSight environment. The findings and observations indicate the feasibility of such a setup for a Brigade level Command Post, paving the way for subsequent experimentation to strengthen and extend this concept.

References

1. Alberts, D. & Hayes, R. (2002). *Code of Best Practice for Experimentation*. Washington D.C.: CCRP Publications Series.
2. de Czege, H.W. & Biever, J.D. (2001). Future battle command: Where information technology, doctrine and organization meet. *Army Magazine, Vol. 51 No. 8*.
3. Endsley, M.R. (1995). Measurement of situation awareness in dynamic systems. *Human Factors, 37(1)*, 65-84.
4. Gorman, P. (1980). A command post is not a place. Available at <http://cpof.ida.org/CPnotPlace.pdf>
5. Holtzblatt, K., and Jones, S. (1993). Contextual Inquiry: A Participatory Technique for System Design. In Schuler, D., and Namioka, A. (eds.) *Participatory Design: Principles and Practice* (pp. 180-193). Hillsdale, NJ: Lawrence Earlbaum Associates.
6. Kingston, G. & Martell, C. (2004). Degrees of shared awareness. Proceedings of 9th ICCRTS: Copenhagen, Denmark. Sept 2004.
7. Teo, L.H., Soo, K.T., Teh, C.A. & Seet W.K. (2004). Constructible assessment for situation awareness in a distributed C2 environment. Proceedings of 9th ICCRTS: Copenhagen, Denmark. Sept 2004.

Command Post Anywhere Experiment

Exploiting TeamSight for Ops Concepts

LTC Mervyn Cheah

LTC Chew Lock Pin

Gwenda Fong

Cheryl Ann Teh

Elsie Toh

Challenging Old Ways

- Fixed physical structures vs Information structure
- Physical co-location
- Command brief
- Sequential planning

Command Post Anywhere

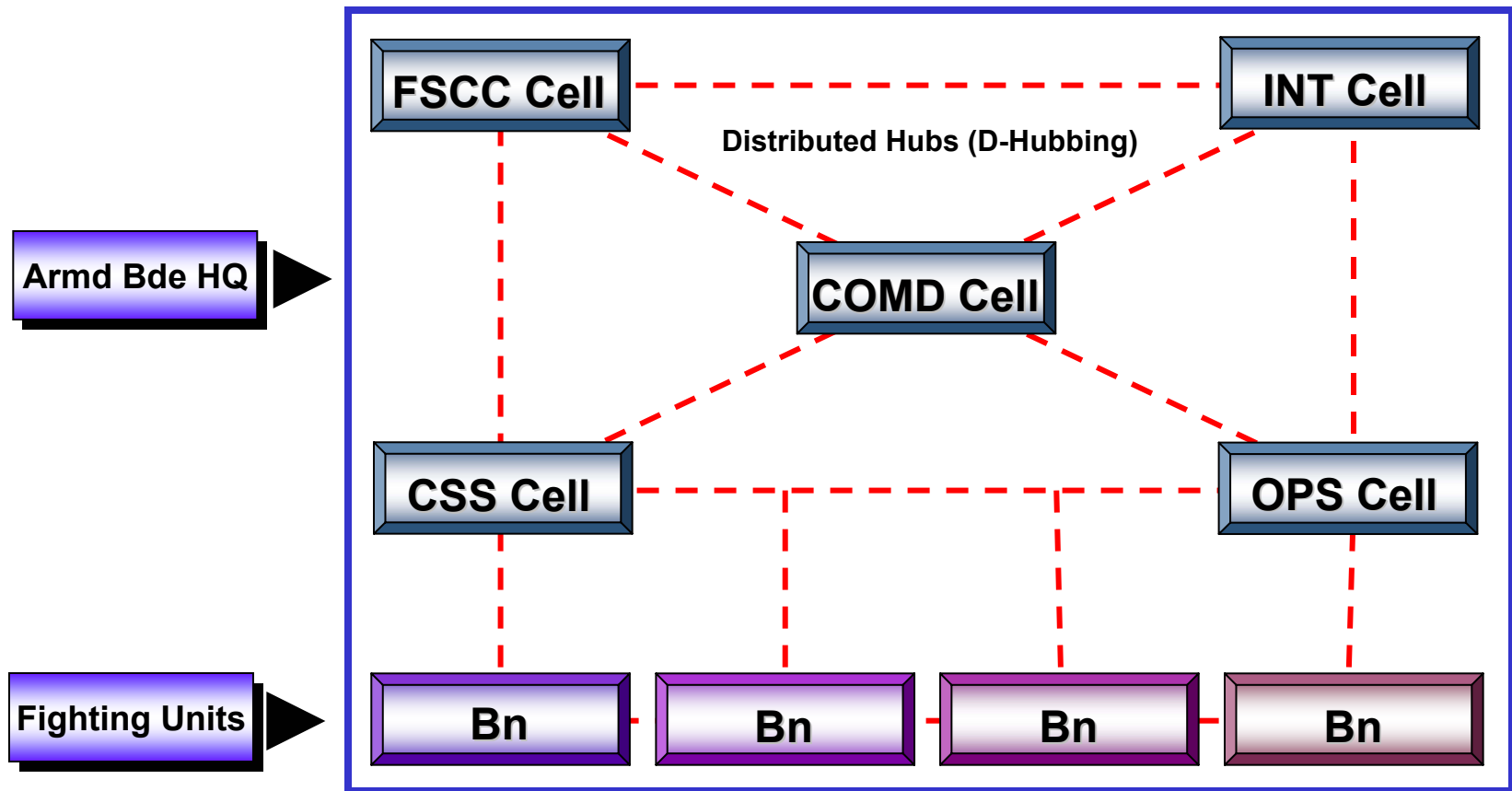

- Information structure that is *mobile, stable, continuous, self-synchronising, self-healing, survivable*
- Motivation is to enhance Bde HQ's **span of command & control**

TeamSight

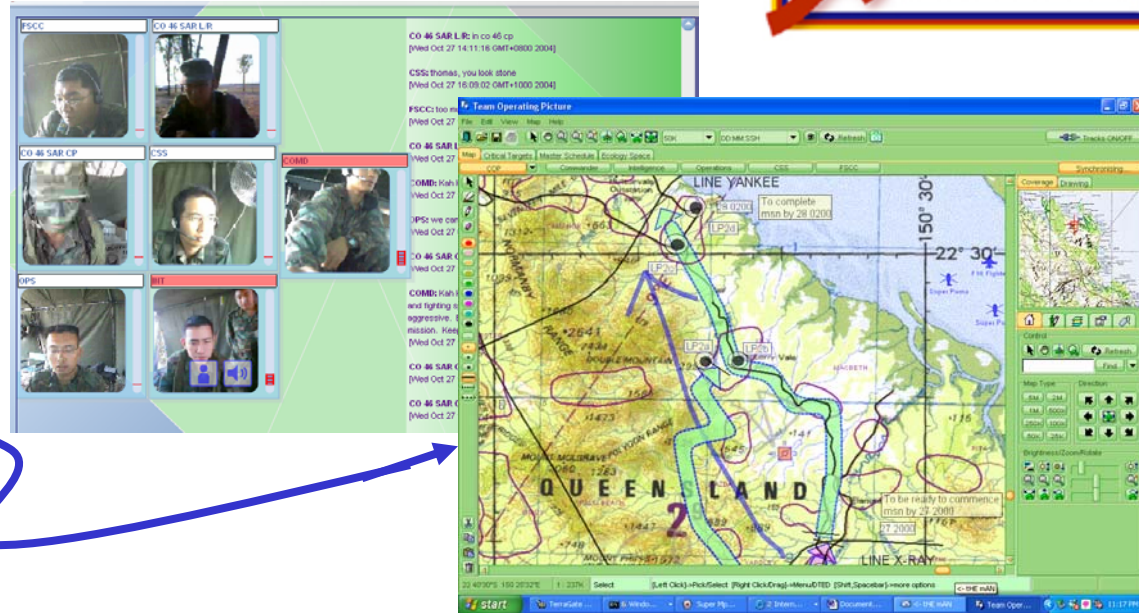

Projection Screens Display at COMD Cell in a Distributed CP set-up

- GIS-based collaborative tool with separate workspaces for each staff officer; Supplemented with video-conferencing, text chat, & e-mails
- Advantages:
 - Easy access to info thus reducing need for explicit dissemination
 - Individual workspace while maintaining Team Operating Picture
 - Visualize battlespace +/- 2 echelons as well as that of peers

Expt Future Might 04

How can we exploit the Power of IKC2 to enable a Future Armoured Bde TOC to **Enhance its Survivability** while generating **Superior Operating Tempo** for the Land Battle?

What kind of eXpt is this?

Three Types*

1. **Discovery Experiment**

- Designed to observe & catalogue the application of new technology, processes & organization to military scenarios.
- “Hypotheses generation” experiments, guided by innovation propositions.

2. **Hypothesis Testing Experiment**

Classic type as conducted by scientists to falsify hypothesis. Conduct of these experiments require specific hypotheses to be formulated and tested.

3. **Demonstration Experiment**

To demonstrate known truths, akin to experiments conducted at schools where chemistry or physics experiments demonstrates to students the truth of the theories.

eXpt Objectives

To investigate the following hypotheses:

- 1) D-hubbing augmented with Team-Sight will have the same sense-making ability as a Centralized CP
- 2) D-hubbing augmented with Team-Sight will provide continuous situation awareness thereby increasing the operational tempo of the Brigade
- 3) D-hubbing will enhance Brigade CP survivability

Conduct of eXpt

- Preparation for experiment
- Bde CP Operations
 - Condition 1: Centralised CP setup (Run 1)
 - Condition 2: D-Hub CP Concept (Runs 2-6, each with varying levels of connectivity)
- Measures:
 - Situation Awareness Assessment
 - Analysis of Communication Patterns
 - Contextual Inquiry

eXpt Conditions

- Within D-hub setup, ability to command and control with:
 - Full Network Performance (Video, Voice, Collaborative C2)
 - Degraded Network Performance (Less Video and Voice)
 - Loss of certain Network Performance (No links to some Cells)

Centralised CP Set-up (Run1)

COMD Cell



INT Cell



30 m

Wired LAN (100mbps)

30 m

30 m

Wired LAN (100mbps)

OPS Cell



FSCC/CSS Cells



D-hub CP Set-up (Runs2-6)

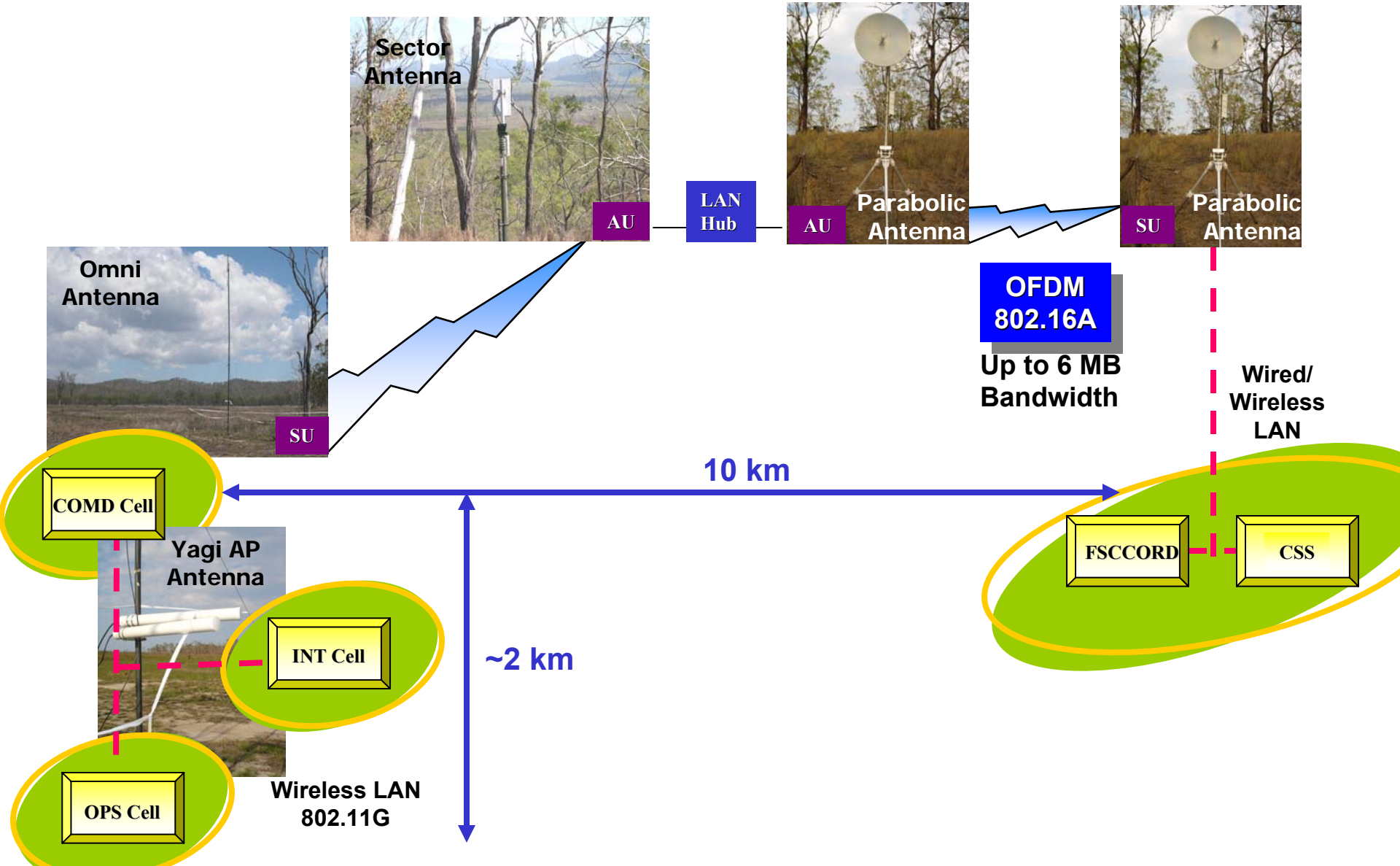

Findings - Communication Activity

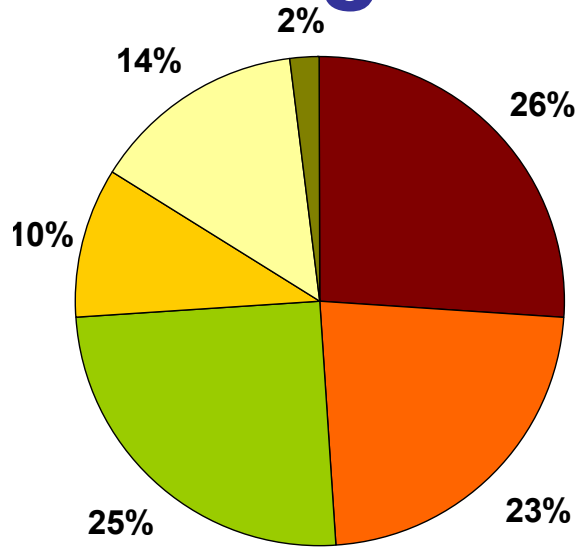

Centralised CP

Moderate inter-rater agreement
(Kendall's coefficient of concordance, $W = 0.450$)

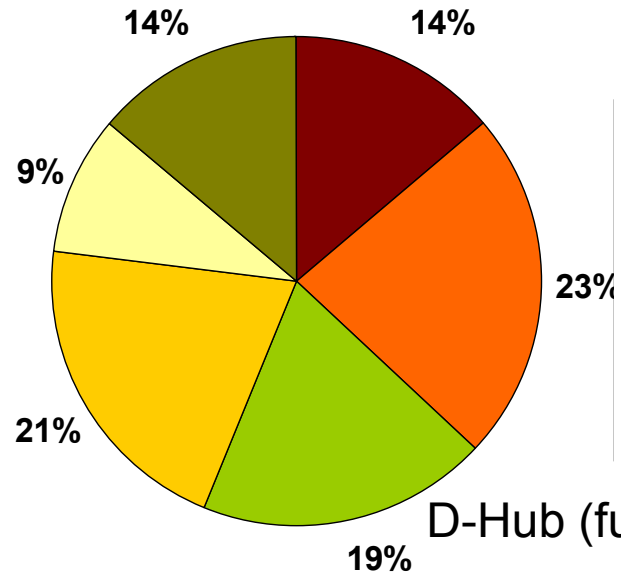

D-Hub (full suite)

Test Variable	p-value
Dissemination of Info	0.109
Building Shared Understanding	0.102
Exchange of Ideas	0.109

Wilcoxon Signed Rank Test

- Greater % of communication for exchange of ideas, less for info dissemination and building of shared understanding as compared to centralized CP
- TeamSight provides platform for information dissemination and building of shared understanding

Findings - Communication Activity

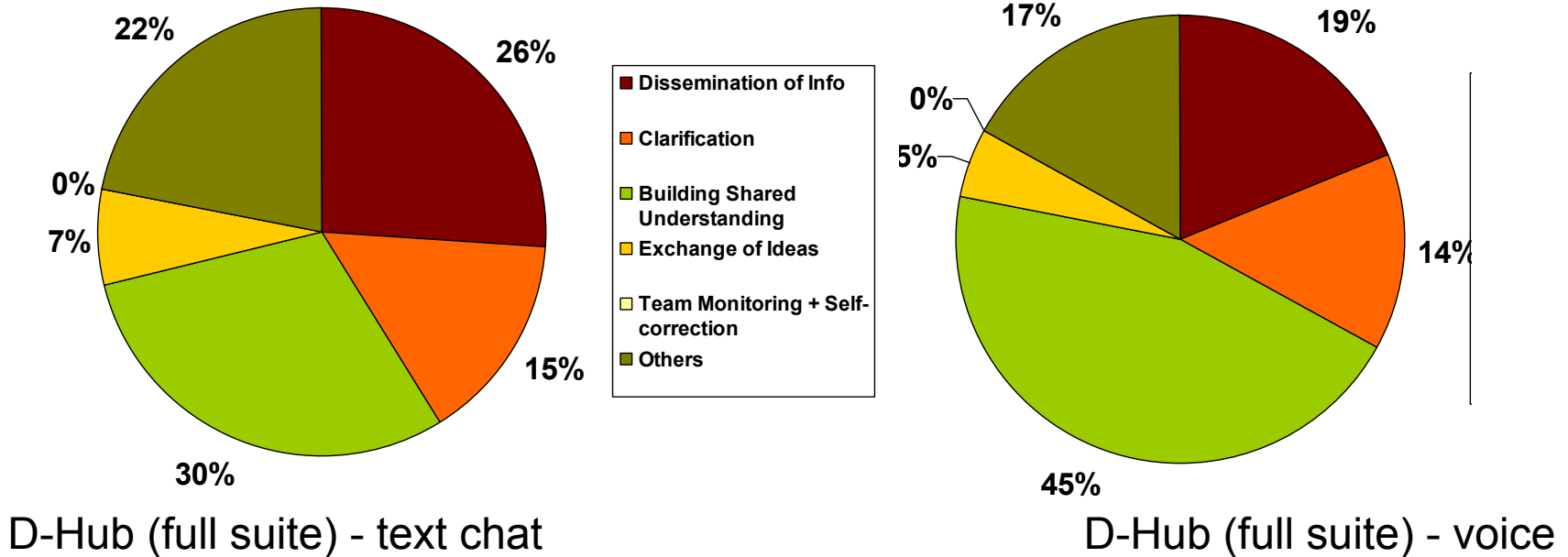

- Various communication tools for different purposes
- Dissemination of information via text chat
- Building of shared understanding via voice communications

Findings - Situation Awareness

Situation Awareness across various Set-Ups

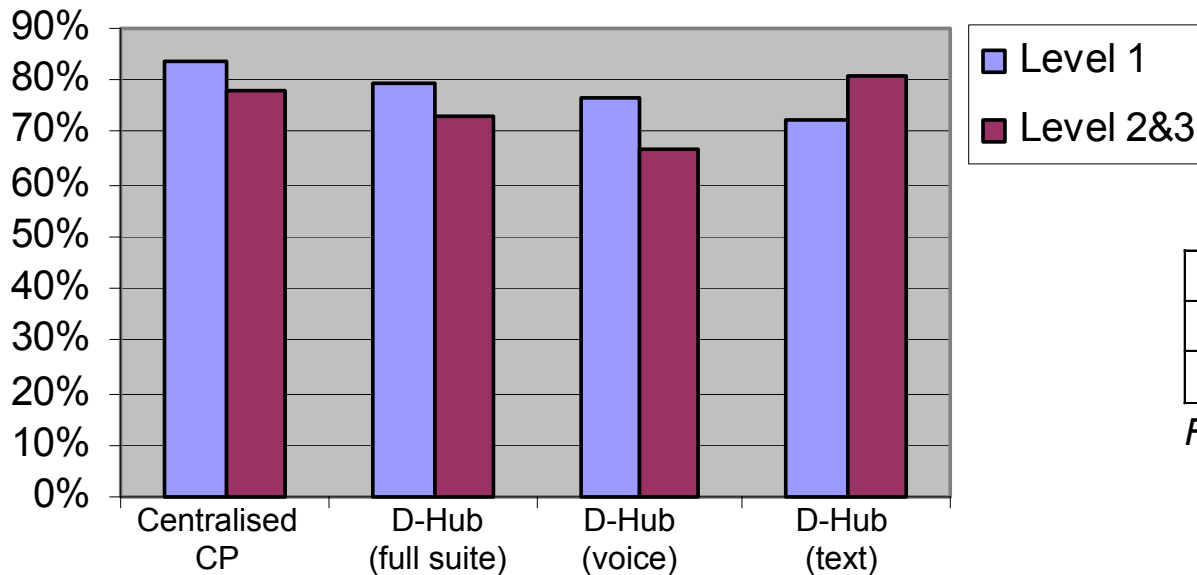

Test Variable	p-value
Level 1	0.591
Level 2&3	0.202

Friedman Test

- No significant difference in SA across all set-ups
=> TeamSight successfully mitigated distributed set-up
- Level 2&3 > Level 1 SA in D-Hub (text) because text chat serves as a record

Findings - Situation Awareness

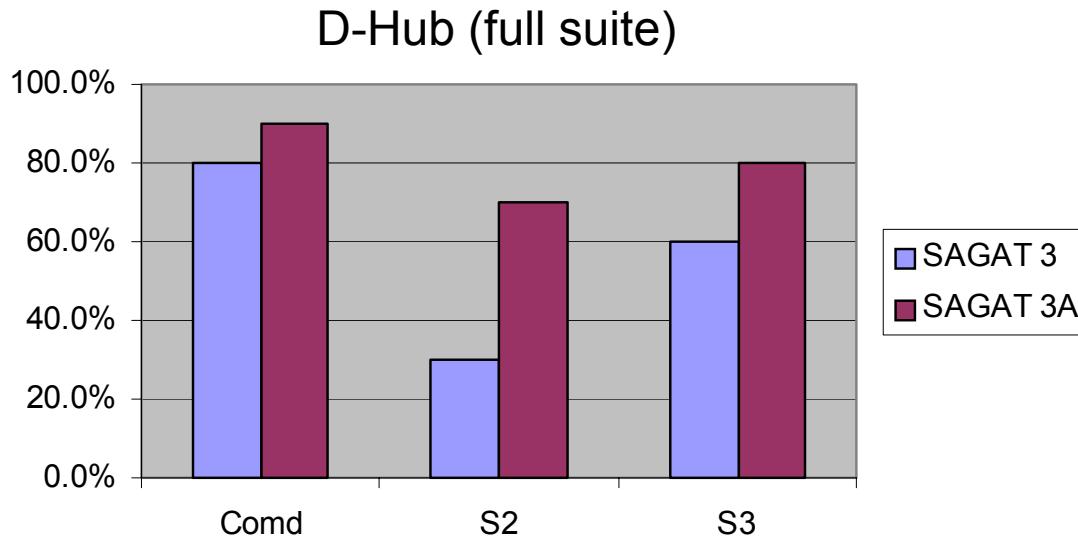

- Increase in SA levels going from the 1st to the 2nd administration for each run, across all roles
- Staff officers would have a better understanding of the scenario as it unfolds and with discussion
- Effect more pronounced in runs with TeamSight

Discussion

- Hypothesis 1: Same level of sense-making
- No significant difference in communication patterns.
 - D-Hub: Reduced info dissemination & building of shared understanding;
Increased exchange of ideas
- No significant difference in situation awareness levels



Discussion

- Hypothesis 2: Continuous SA leading to superior ops tempo
- No significant difference in situation awareness levels despite less frequent command briefs
 - Centralised CP: 80% of time spent working in own cell, 20% spent on P group meeting in Comd cell
 - D-Hub: Greater amount of concurrent activity
 - Commander able to oversee S2 and S3 action-reaction unobtrusively
 - Teamsight enables faster planning & re-planning – 1.5 hrs (without MCM, ADA, OPSCOORD) vs 4 hrs (doctrinal hrs for quick BP)
- Subsequent experiments need to look at quality of plans

Discussion

- Hypothesis 3: Enhanced survivability of Bde HQ
- Cells distributed across span of 10km
- Subsequent experiments need to measure EM signature



Conclusions

- Culmination of a series of smaller scale exercises that test CPA concept in a TeamSight environment
- Findings and observations indicate feasibility of such a set-up
- Paves the way for future experiments that seek to strengthen and extend the concept

Questions?