

REPORT DOCUMENTATION PAGE

Form Approved
OMB No. 0704-0188

Public reporting burden for this collection of information is estimated to average 1 hour per response, including the time for reviewing instructions, searching data sources, gathering and maintaining the data needed, and completing and reviewing the collection of information. Send comments regarding this burden estimate or any other aspect of this collection of information, including suggestions for reducing this burden to Washington Headquarters Service, Directorate for Information Operations and Reports, 1215 Jefferson Davis Highway, Suite 1204, Arlington, VA 22202-4302, and to the Office of Management and Budget, Paperwork Reduction Project (0704-0188) Washington, DC 20503.

PLEASE DO NOT RETURN YOUR FORM TO THE ABOVE ADDRESS.

1. REPORT DATE (DD-MM-YYYY) 21-12-2005		2. REPORT TYPE Presentation		3. DATES COVERED (From - To) 01-Apr-2005 to 30-Oct-2005	
4. TITLE AND SUBTITLE MEMS Shear Stress Sensor			5a. CONTRACT NUMBER		
			5b. GRANT NUMBER N00014-05-1-0535		
			5c. PROGRAM ELEMENT NUMBER 0601000N		
6. AUTHOR(S) Dr. Michael Jonson, Dr. Aman Haque, Mr. Amit Desai, Mr. Benedict Samuel, Mr. Todd Ziegler			5d. PROJECT NUMBER 13069		
			5e. TASK NUMBER 01		
			5f. WORK UNIT NUMBER 03210		
7. PERFORMING ORGANIZATION NAME(S) AND ADDRESS(ES) The Pennsylvania State University Applied Research Laboratory and Mechanical Engineering Department				8. PERFORMING ORGANIZATION REPORT NUMBER (None)	
9. SPONSORING/MONITORING AGENCY NAME(S) AND ADDRESS(ES) Office of Naval Research Ron Joslin				10. SPONSOR/MONITOR'S ACRONYM(S)	
				11. SPONSORING/MONITORING AGENCY REPORT NUMBER	
12. DISTRIBUTION AVAILABILITY STATEMENT Distribution Statement A					
13. SUPPLEMENTARY NOTES					
14. ABSTRACT A micro electro mechanical system (MEMS) was designed, manufactured, and vibrationally tested. The system consisted of a multitude of nearly identical shear stress sensors. The resonant frequency was measured to 57 sensors with a mean frequency of 90.037 KHZ and a standard deviation of 0.297 KHZ. Although attempted in water, only the air measurements were conducted.					
15. SUBJECT TERMS MEMS, Shear Stress Sensor					
16. SECURITY CLASSIFICATION OF:			17. LIMITATION OF ABSTRACT NONE	18. NUMBER OF PAGES 28	19a. NAME OF RESPONSIBLE PERSON Michael Johnson
a. REPORT U	b. ABSTRACT U	c. THIS PAGE U			19b. TELEPHONE NUMBER (Include area code) 814-863-3029

PENNSTATE

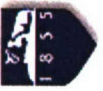

MEMS Shear Stress Sensor

Presented to Dr. Ron Joslin, ONR

Presented by Dr. Michael Jonson and Dr. Aman
Haque, Mr. Amit Desai, Mr. Benedict Samuel
and Mr. Todd Ziegler
December 21, 2005

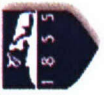

Statement of Work

Objective	Result
Measure sensor-to-sensor variability:	<ul style="list-style-type: none"> • Resonant frequency was determined for 57 sensors. • Mean Resonant Frequency = 90.037 KHz • Standard Deviation = 0.297 KHz
Measure effects of fluid loading:	<ul style="list-style-type: none"> • Resonant Frequency was determined for air and water • Resonant Frequency for Air = 90.037 KHz • Resonant Frequency for Water = ?????? KHz



Agenda

- Research Presentation
 - Objectives
 - Approach
 - Shear stress sensor design
 - Manufacturing Method
 - Experimental Results
 - Future Work



Objective

- **Fabrication of MEMS shear stress sensor.**
 - Investigate sensor-to-sensor stiffness variability.
 - Investigate effect of fluid loading.

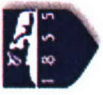

Approach

1. Design and fabricate an array of MEMS shear stress sensors
2. Shake sensors and base over frequency range encompassing regions below and above the in-plane resonance frequency
3. Conduct measurements in air and water.

Sensor Design Approaches

- Broadly classified as direct and indirect sensors.

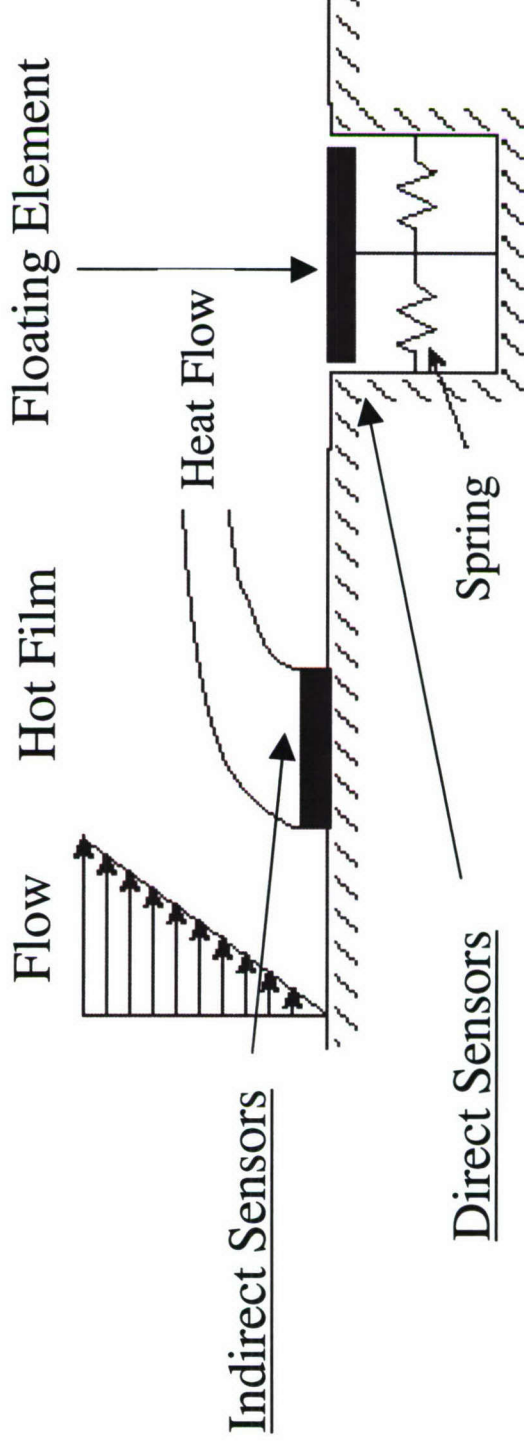

- Direct type sensor is being designed

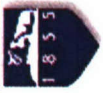

Design Philosophy

- Size of the plate comparable to length scale.
- Number of beams and mass of plate control sensitivity and dynamic characteristics.

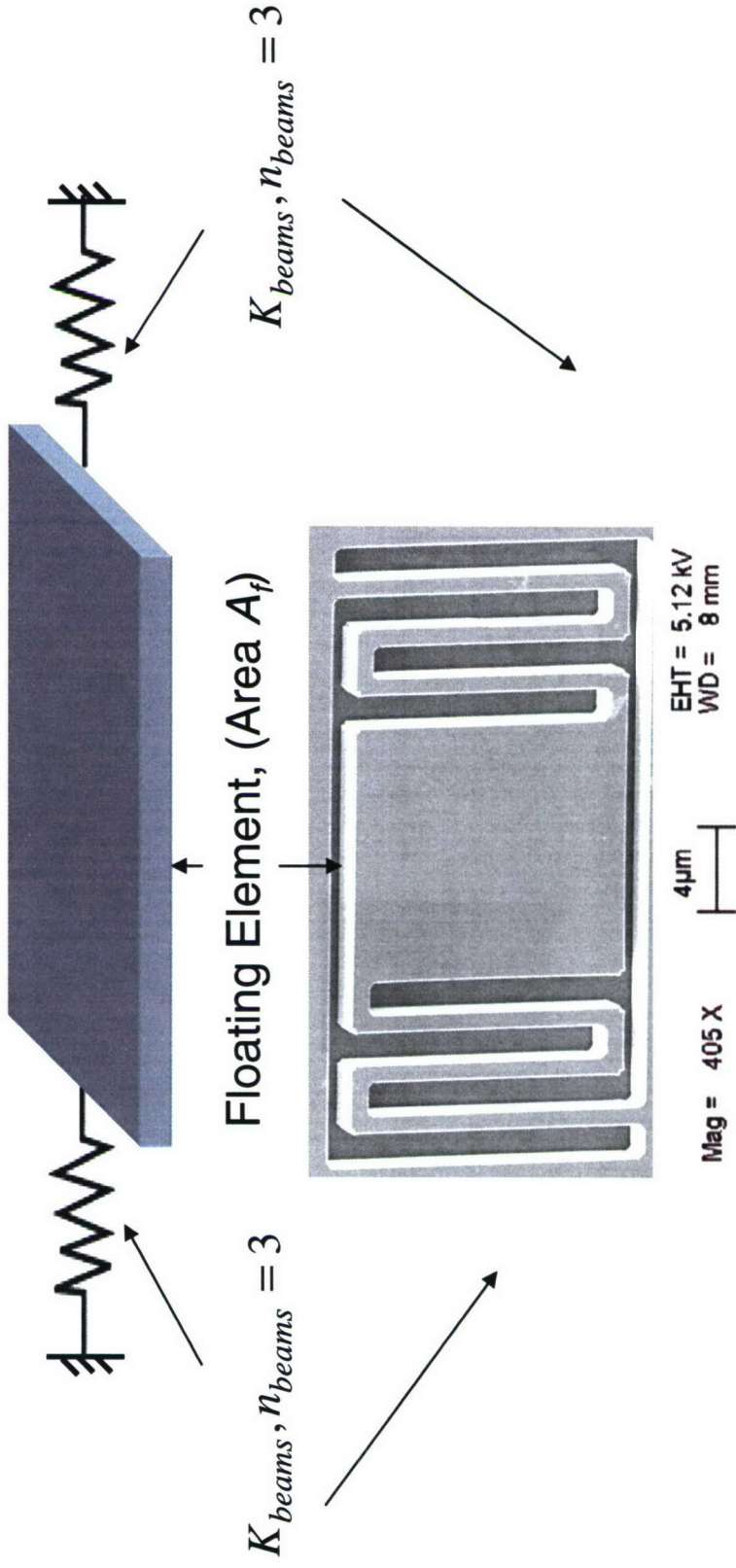

$$K_{device} = 2K_{beams} = \frac{1}{n_{beams}} \frac{24EI_{beam}}{3} \cdot f_{natural} = \frac{1}{2\pi} \sqrt{\frac{K_{device}}{m_{device}}}$$

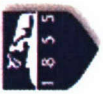

Sensor Designs

Design 1

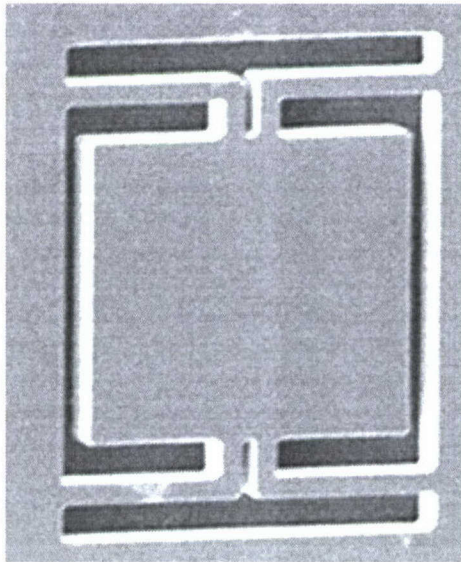

Design 2

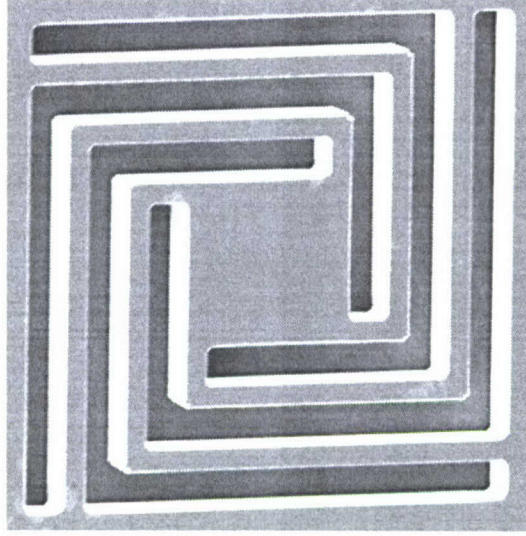

Design 3

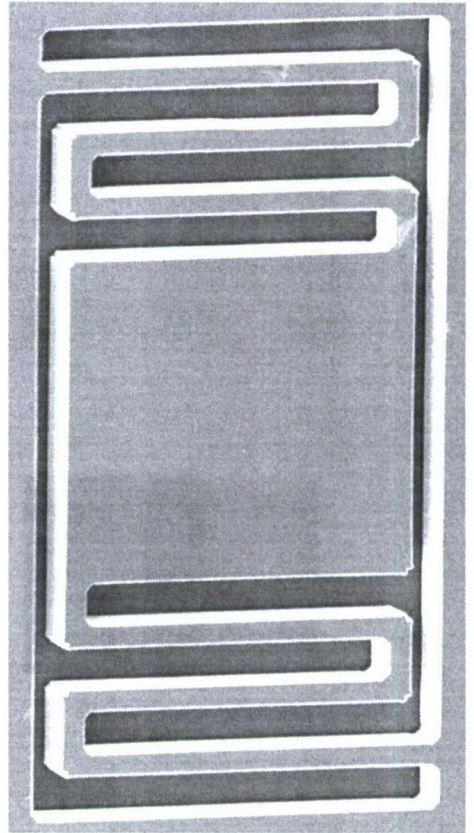

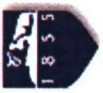

Sensor Performance Estimates

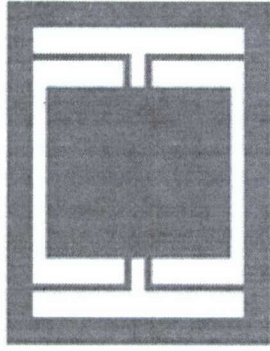

Design 1

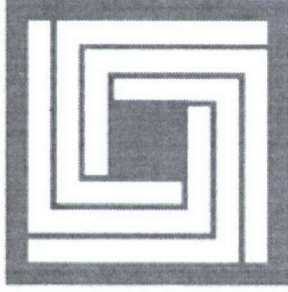

Design 2

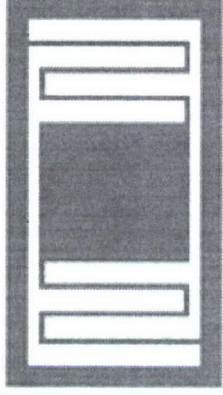

Design 3

ANSYS Modal Analysis

Design No.	Floating element area, A_f (μm^2)	Spring constant, K_{device} (N/m)	Natural frequency, ω_r (MHz)	Frequency 1 (MHz)	Frequency 2 (MHz)	Frequency 3 (MHz)
1.	182.25	503.7	3.29	3.527	6.301	8.616
2.	121	51.87	1.09	0.954	0.954	1.462
3.	144	20.5	0.69	0.628	1.12	1.33

Fabrication Process

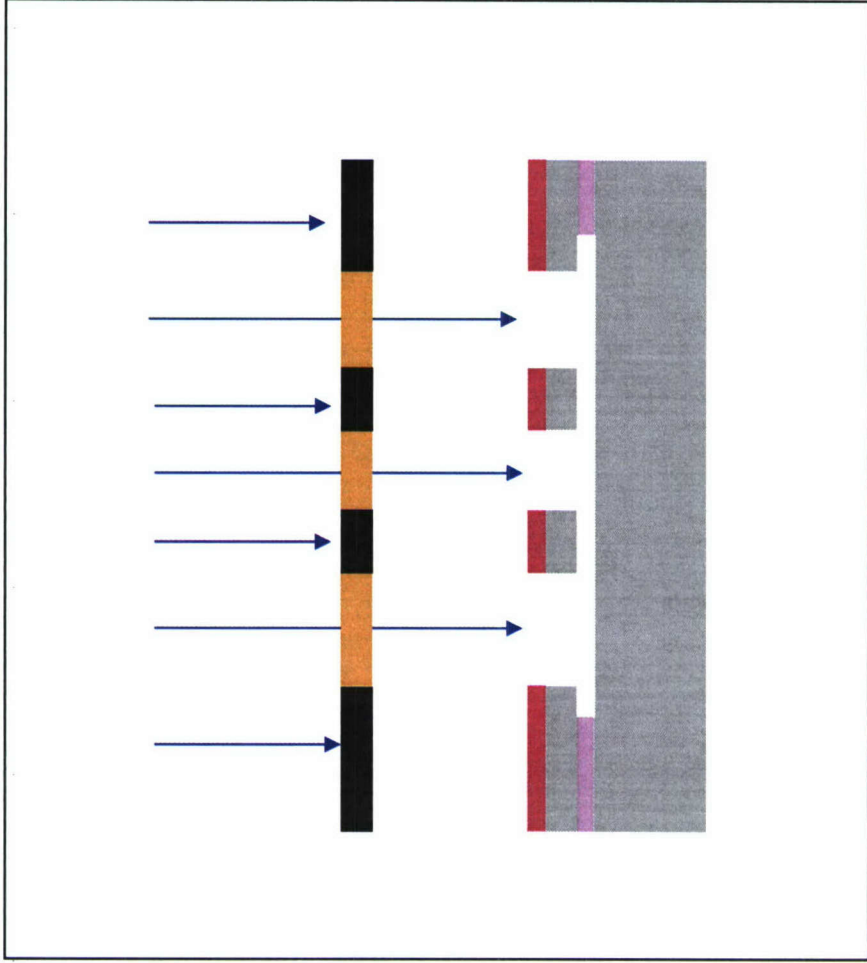



Fabrication Uniformity

Dimension (Design 3)	Dimension variation (%)	Expected Stiffness variation (%)	Expected Frequency variation (%)
Beam Length	1.3	3.75	1.1
Beam width	2.35	7.05	4.6

Variation in dimensions for 2 different sensors

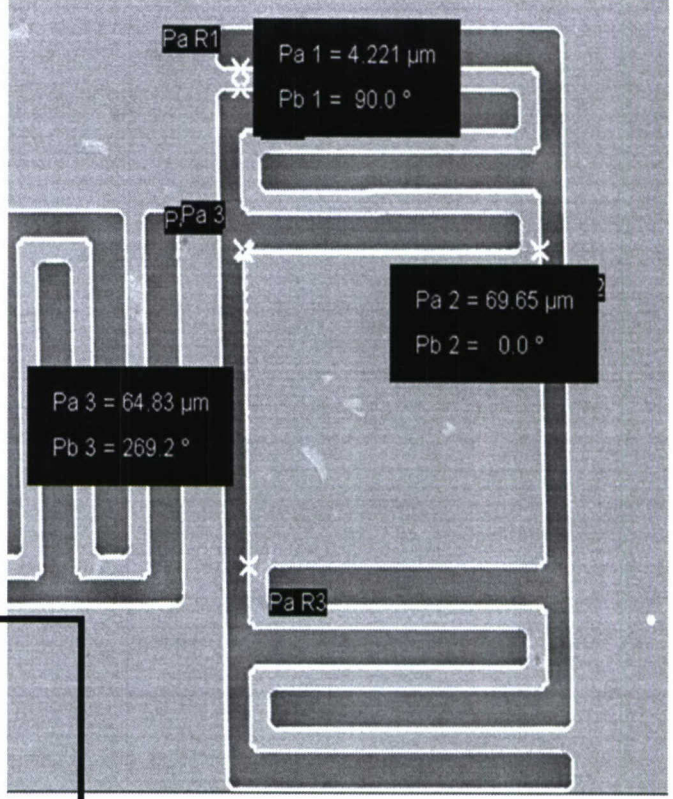
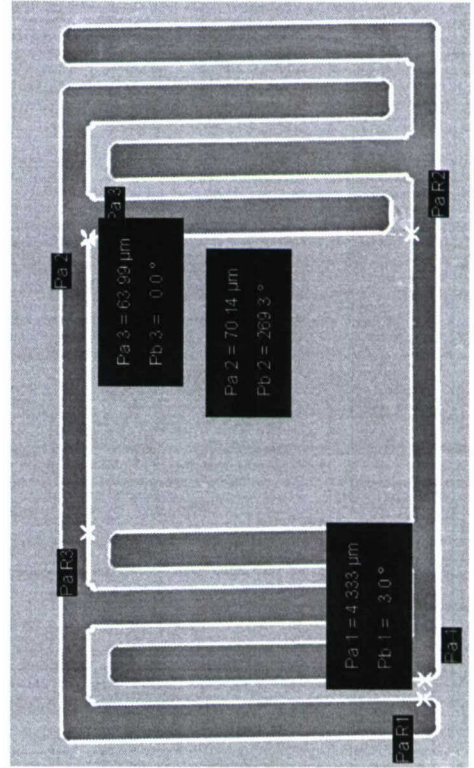

Property variations

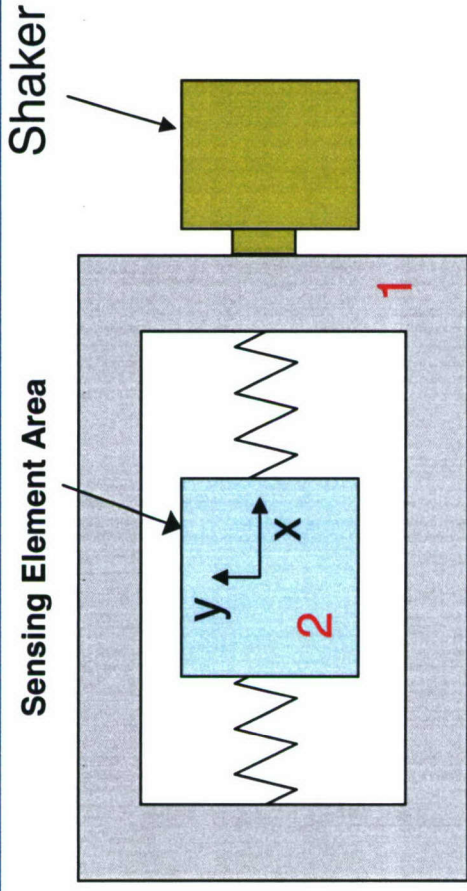

$$\omega_0 = (k/m)^{1/2}$$

$$\frac{d\omega_0}{\omega_0} = \frac{1}{2} \frac{dk}{k} - \frac{1}{2} \frac{dm}{m}$$

$$\frac{dk}{k} = 2 \frac{d\omega_0}{\omega_0} + \frac{dm}{m}$$

Variations in the stiffness will be assessed indirectly through measured variations in resonance frequency and mass variations.

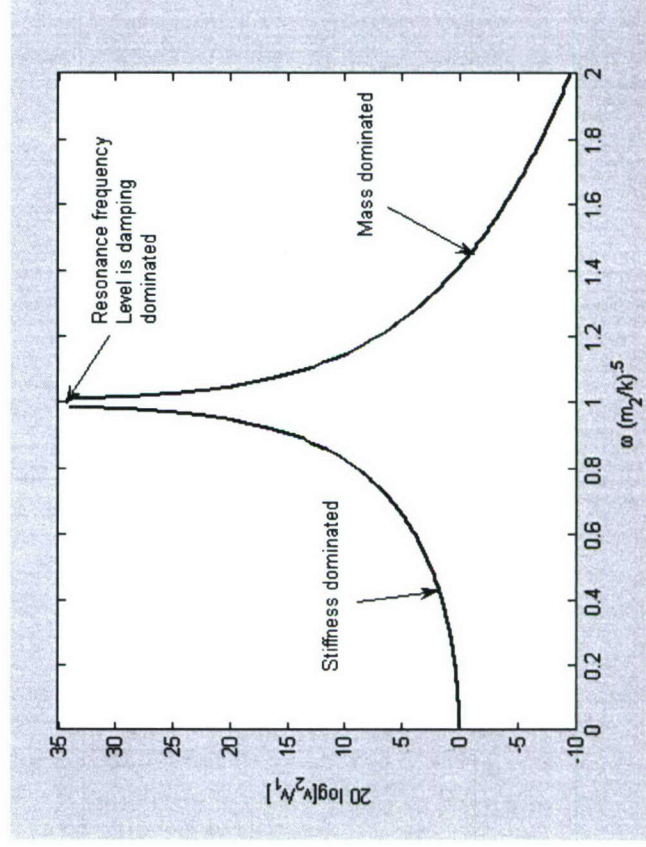



Scaled Model Testing

- Scaled prototype manufactured
 - Rough cut from Al at 450:1 scale
 - Investigate measurement method at macroscopic scale

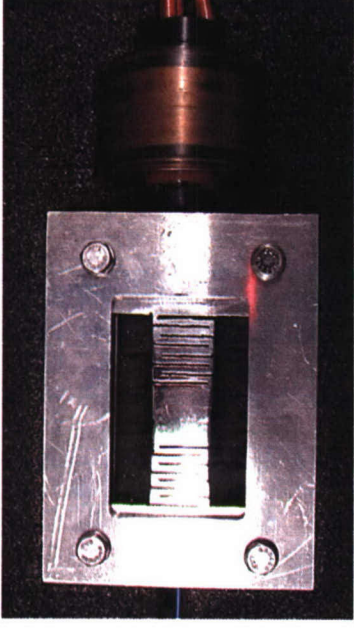

X-dir Spectrum

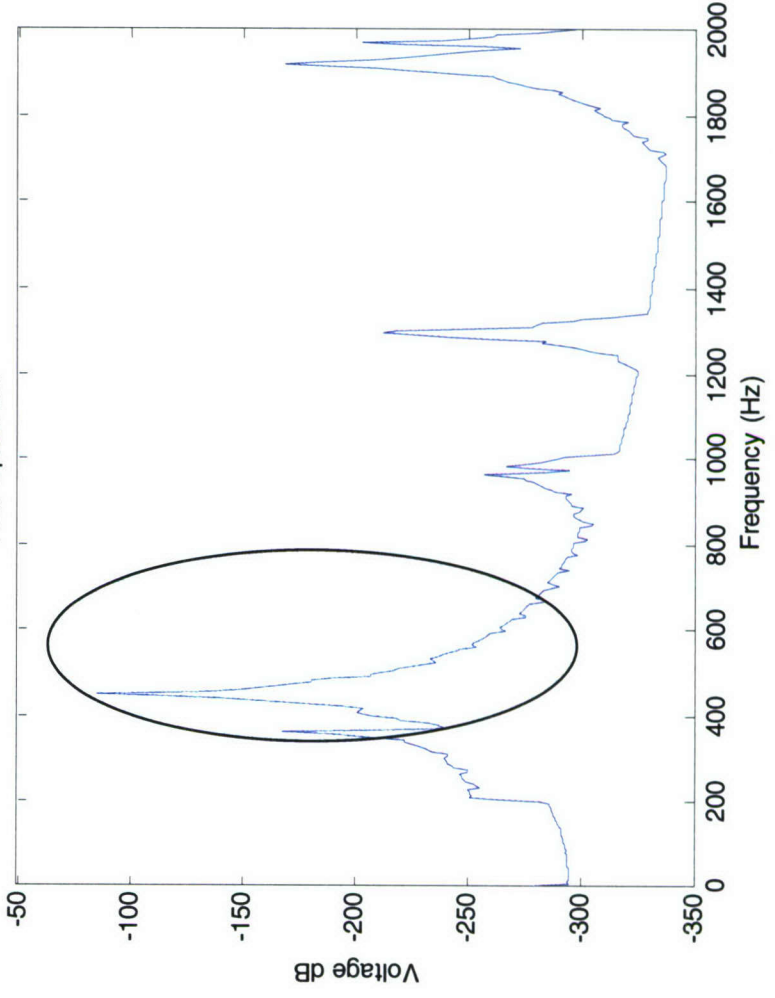

ANSYS Modal Analysis

Actual Model	112.3 KHZ
Scaled Model	141 Hz

Vibrometer Resolution

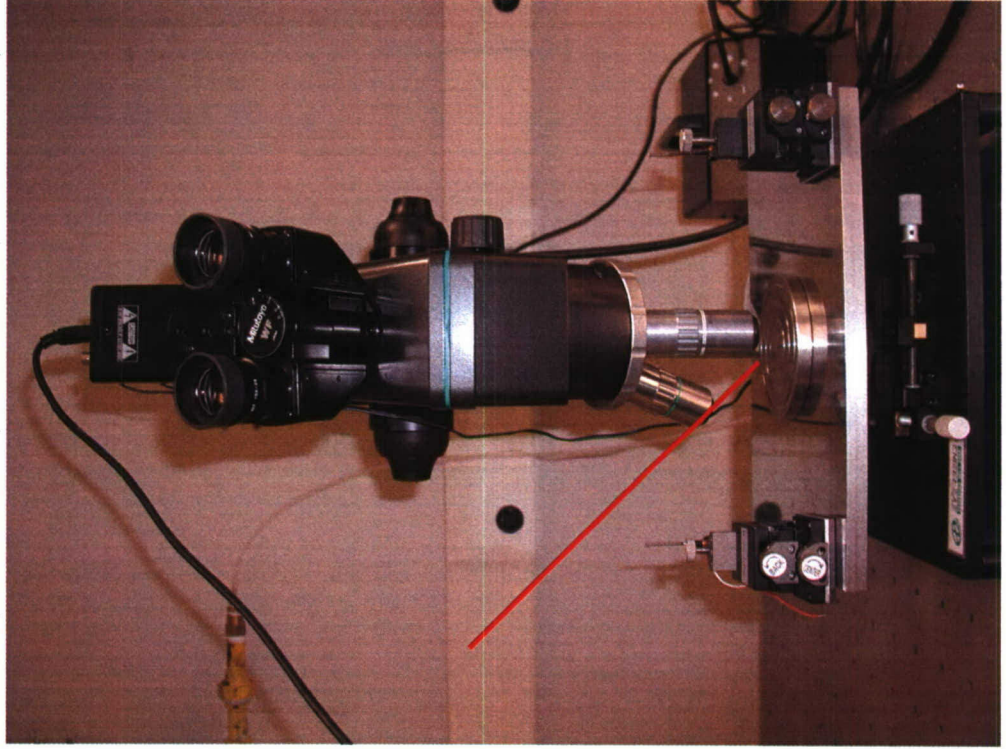
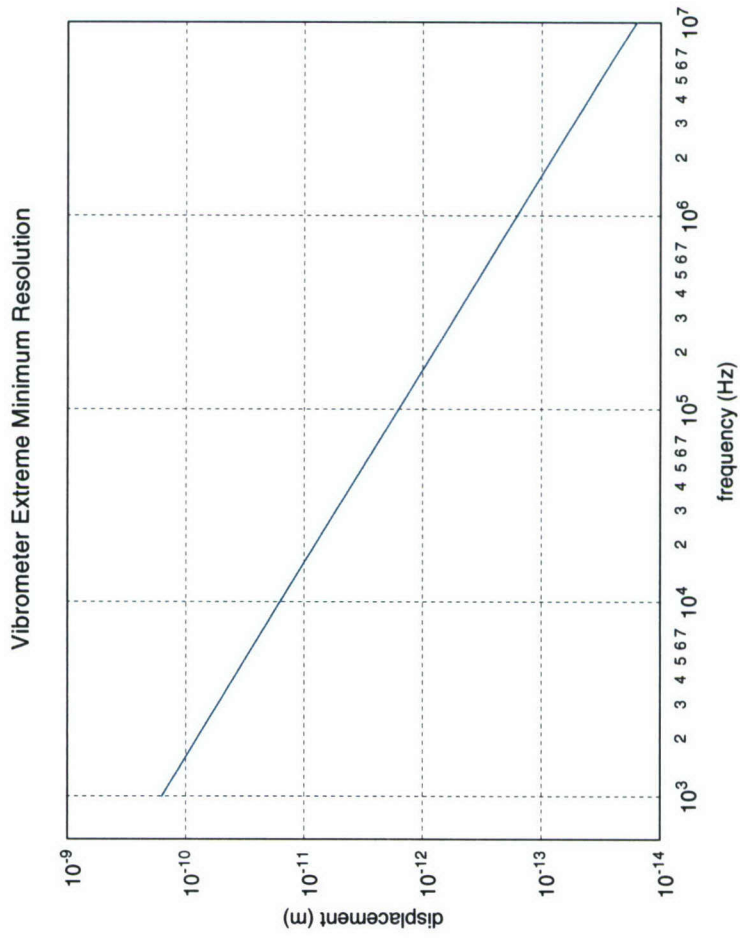

Proposed Laser Vibrometer Optics

- Transverse vibration must be measured
 - Backscatter insufficient to with silicon
 - Right angle mirror approach ongoing

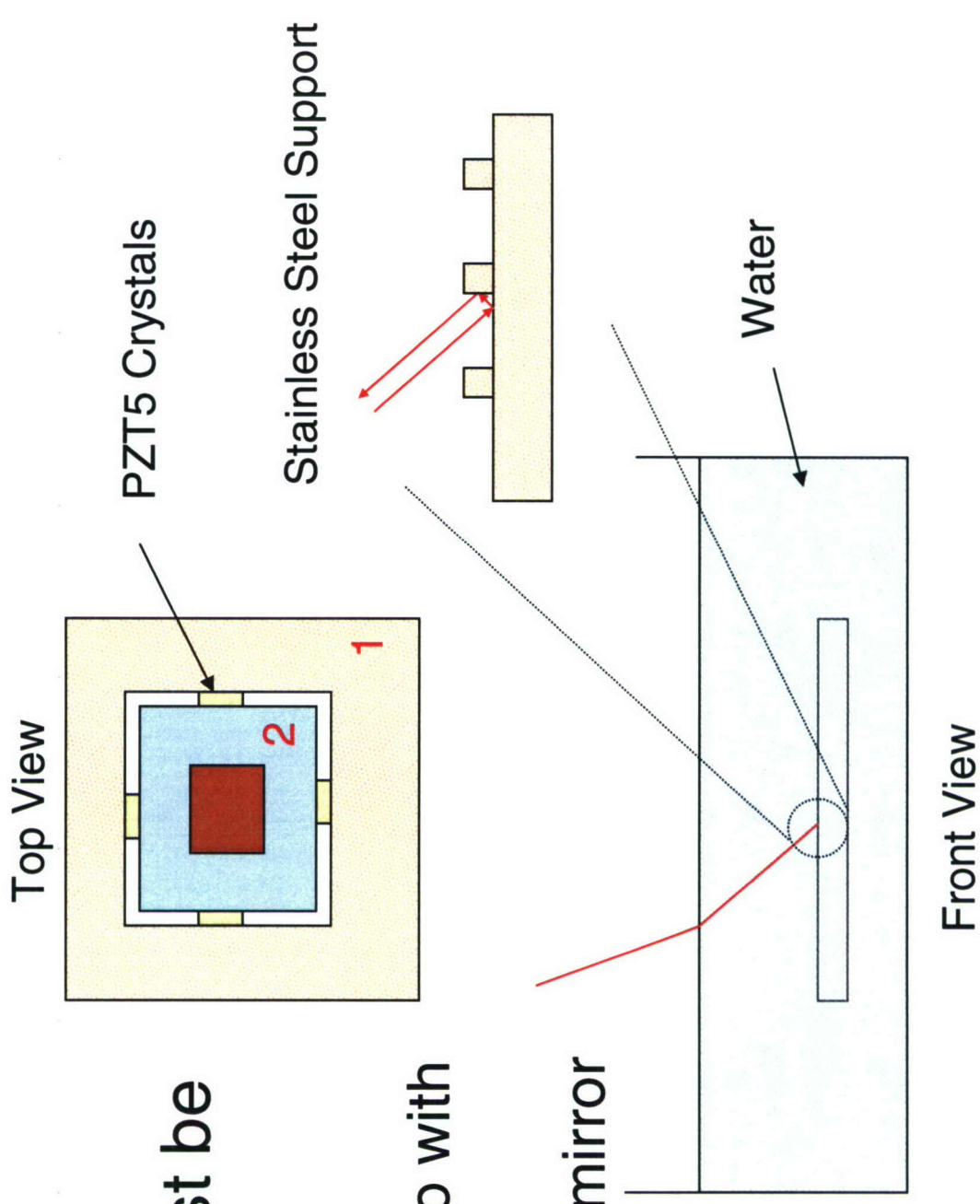

Measurement System Design

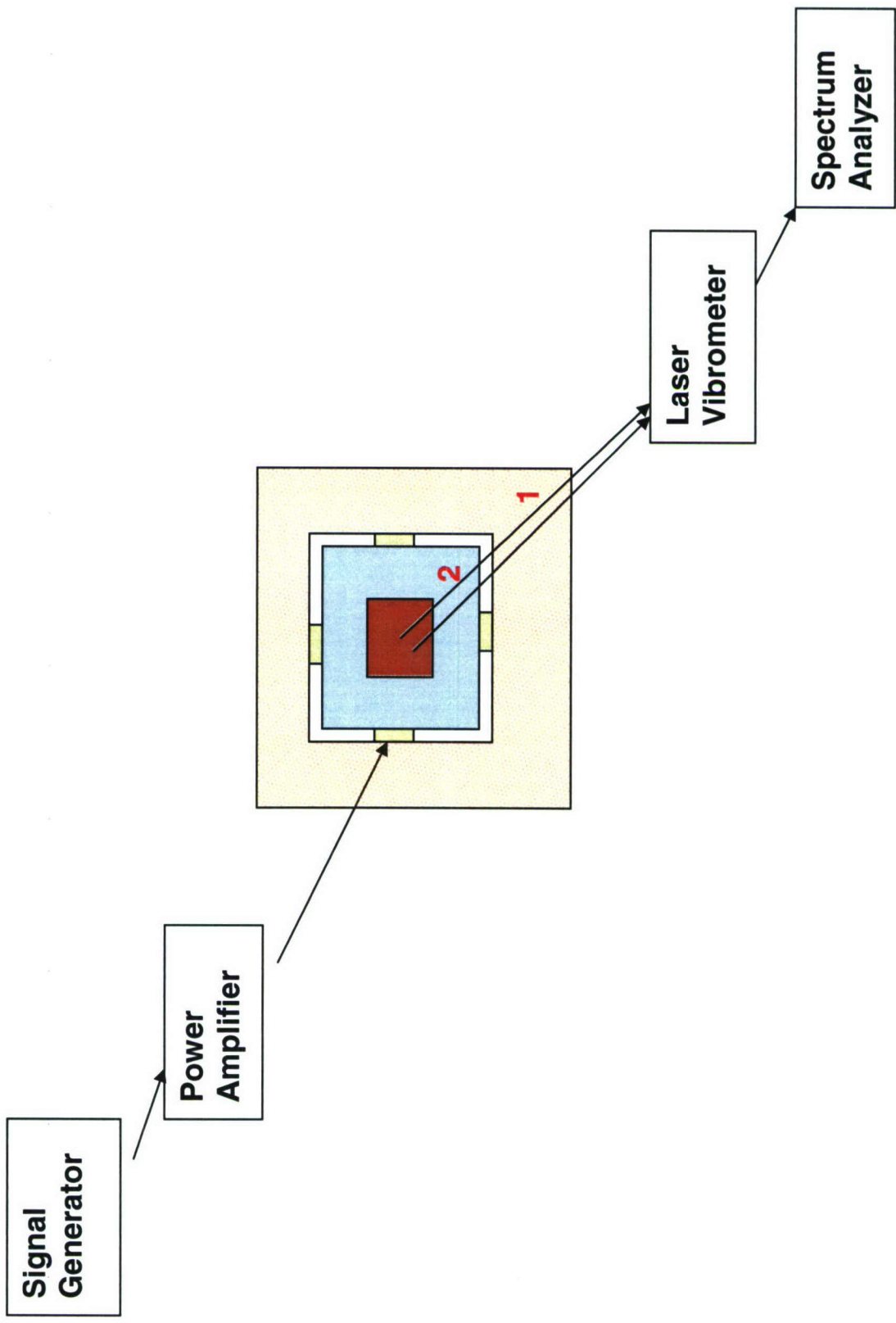



Statement of Work

- 1. Investigate sensor-to-sensor stiffness variability.**
- 2. Investigate effect of fluid loading.**



S.O.W 1 - Experimental Setup for Testing in Air

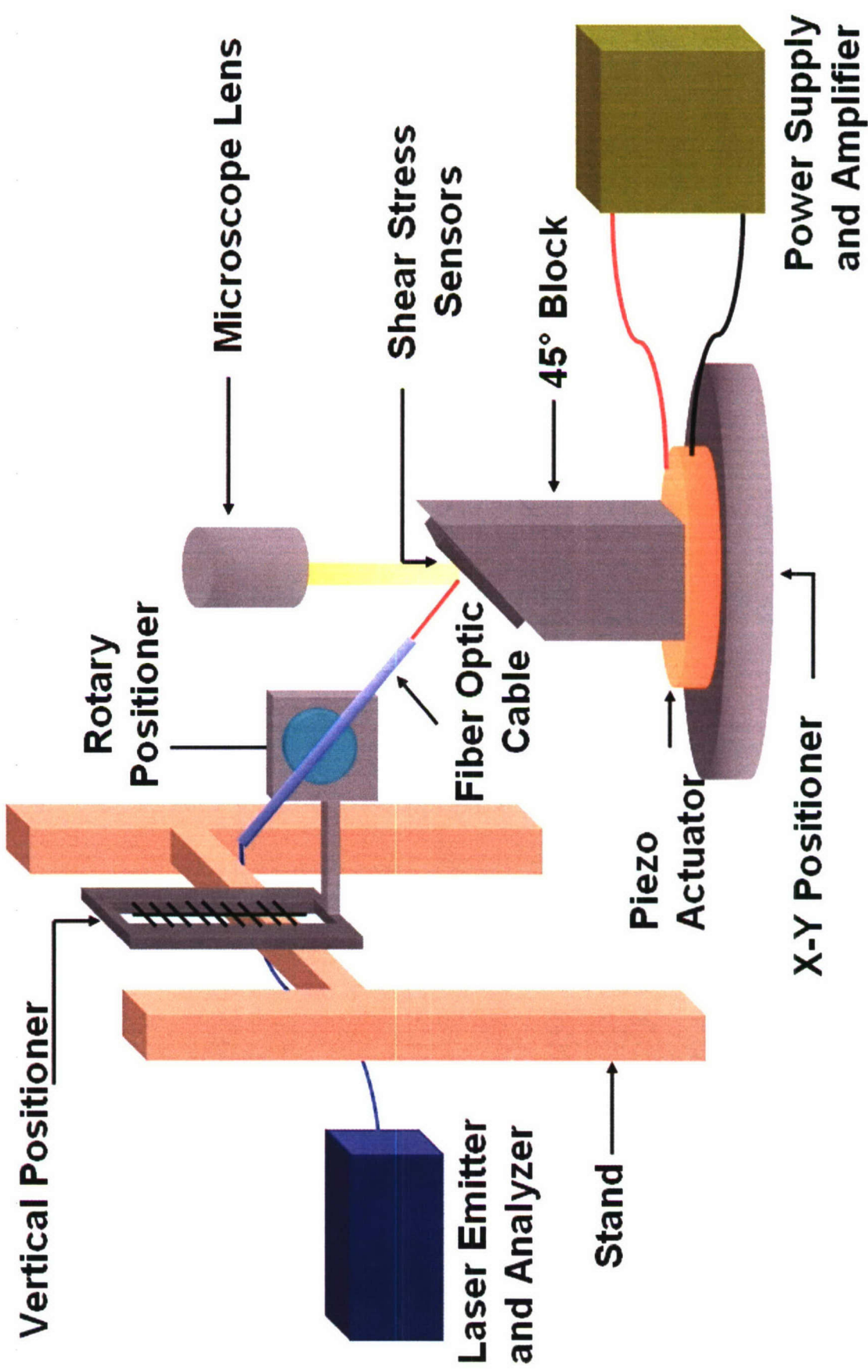

S.O.W 1 - Experimental Setup for Testing in Air

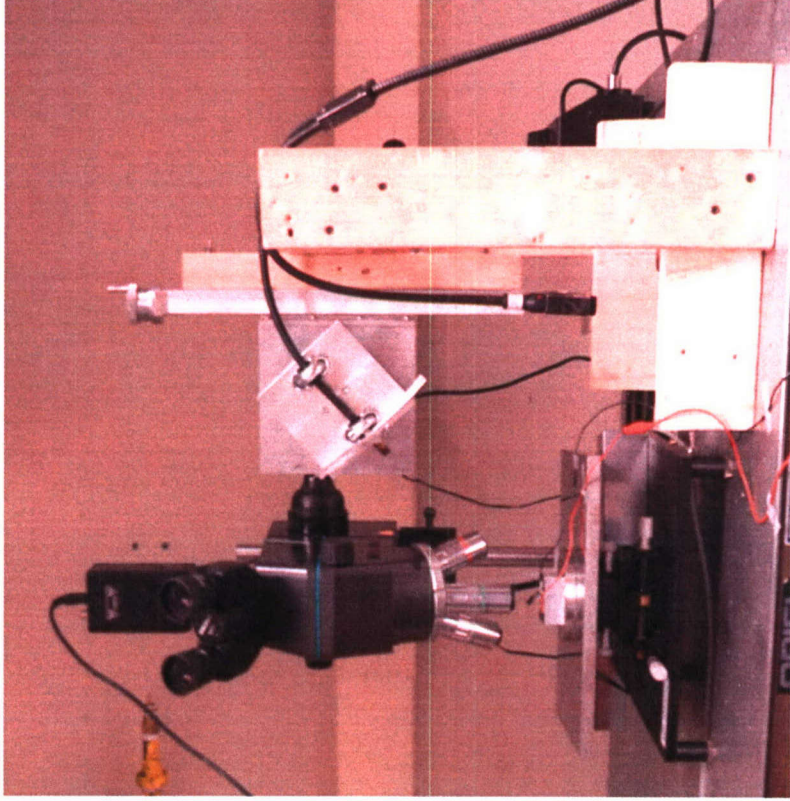

Microscope and the Vibrometer



Signal Generator, Amplifier and the Vector
Signal Analyzer



S.O.W. 1 - List of Equipment

- Polytec Laser Vibrometer, OFV-2200 and OFV-303.
- Stanford Research Systems DS345 Function Generator.
- Krohn-Hite 7500 Amplifier.
- Agilent 89410A Vector Signal Analyzer.
- Mitutoyo Optical Microscope.
- CTS PZT 5A & 5H Piezoelectric Actuator



S.O.W. 1 - Experimental Results for Sensor Vibration in Air

- Filtered white noise input.
- Analyzed the frequency spectrum.

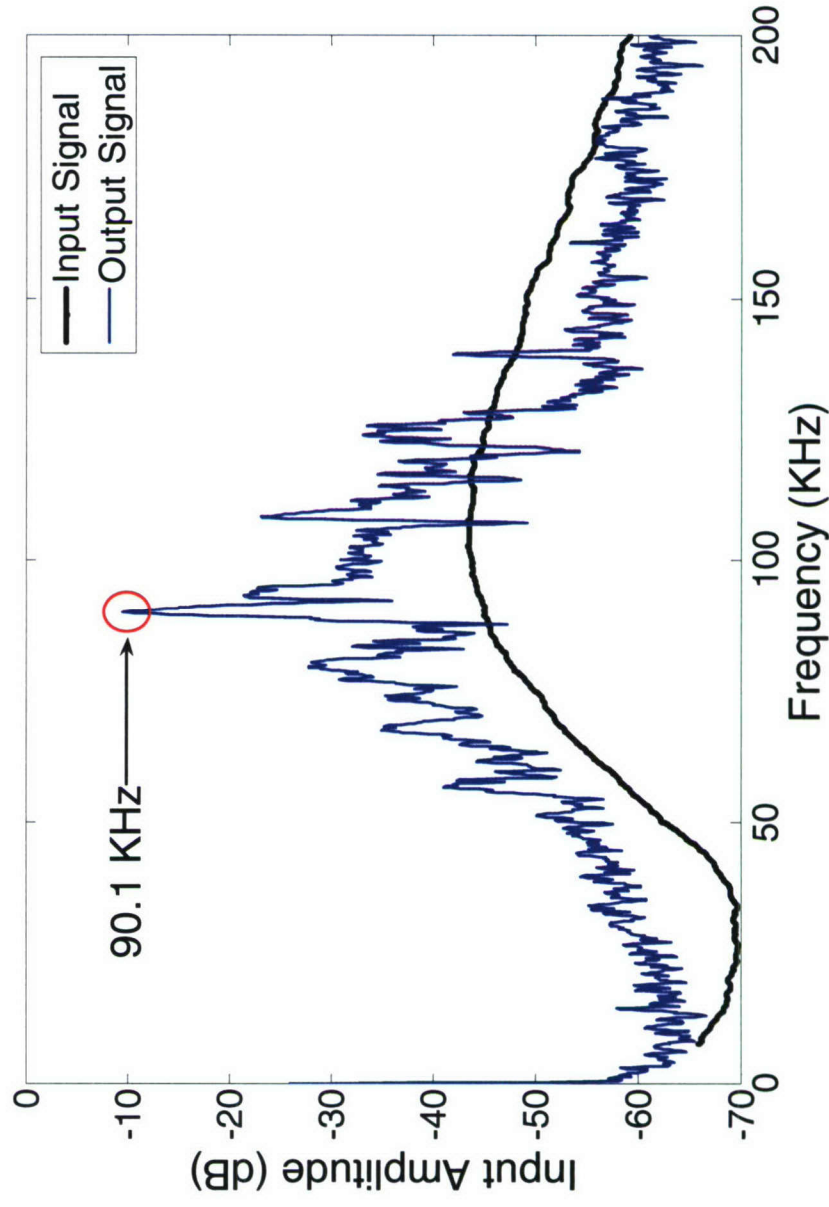



S.O.W. 1 - Experimental Results for Sensor Vibration in Air

Performed experiments on 57 sensors

- Mean Resonant Frequency = 90.037 KHz
- Standard Deviation = 0.297 KHz

Histogram Plot for the 57 sensors

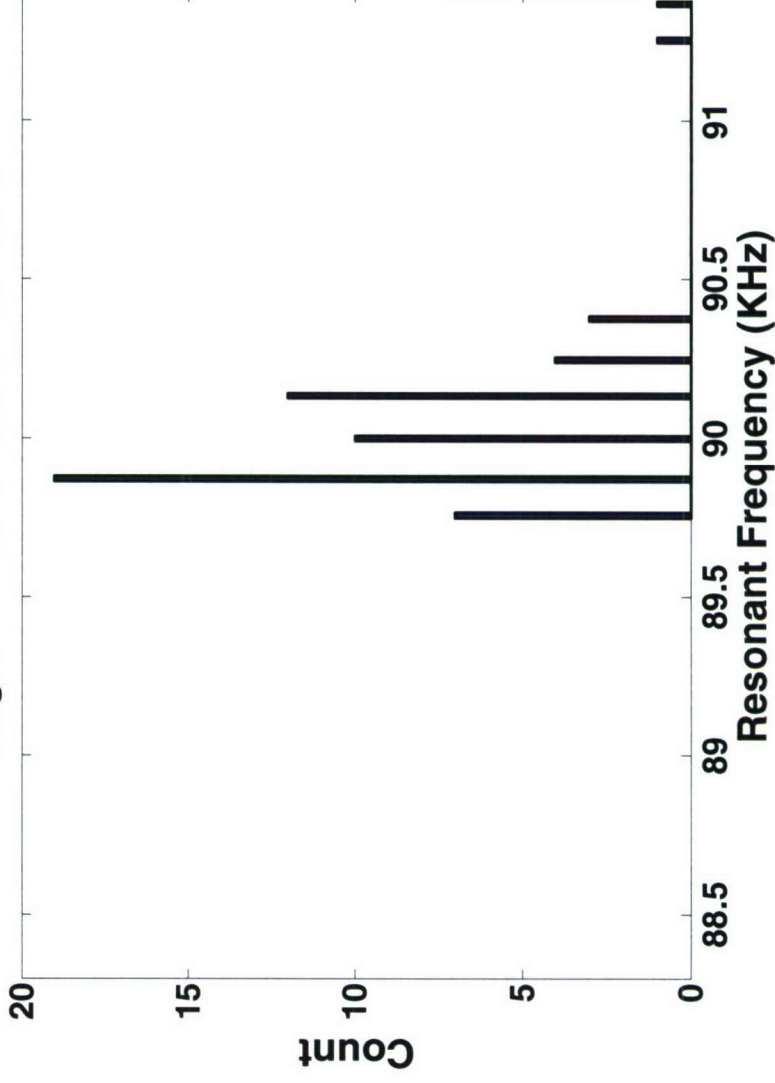



S.O.W. 1 - Experimental Results for Sensor Vibration in Air

There is a 19.8 % decrease in resonant frequency from design value (112.3 KHz) due to

- fabrication processes,
- material properties,
- squeeze film damping.

However the variation among different sensors is small and it suffices to calibrate 2 to 3 sensors only.



S.O.W. 2 - Effects of fluid loading

In Vacuo: 407.7 kHz
In Water: 379.6 kHz

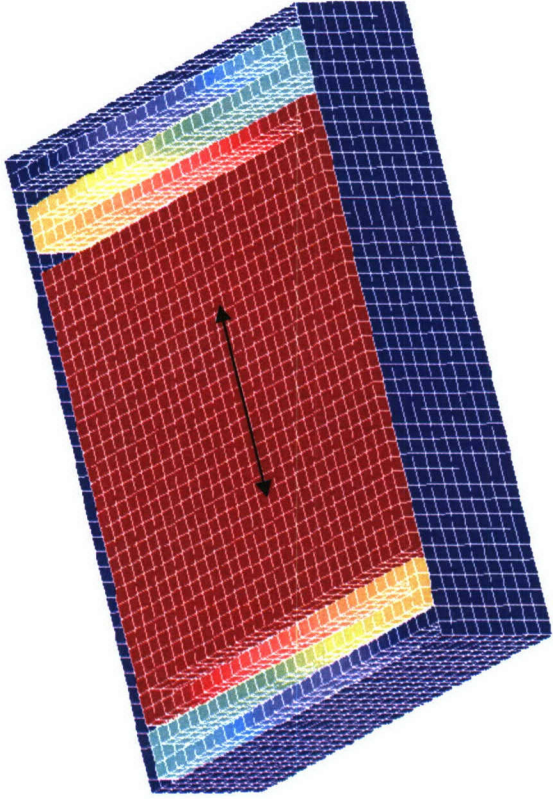

Shear Motion

In Vacuo: 1164.6 kHz
In Water: 570.6 kHz

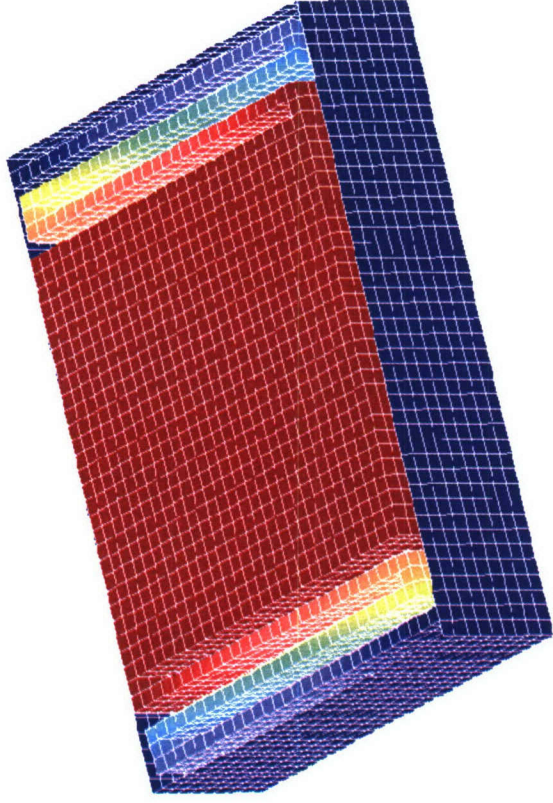

Out of plane motion

Design 3

S.O.W 2 - Experimental Setup for Testing in Water

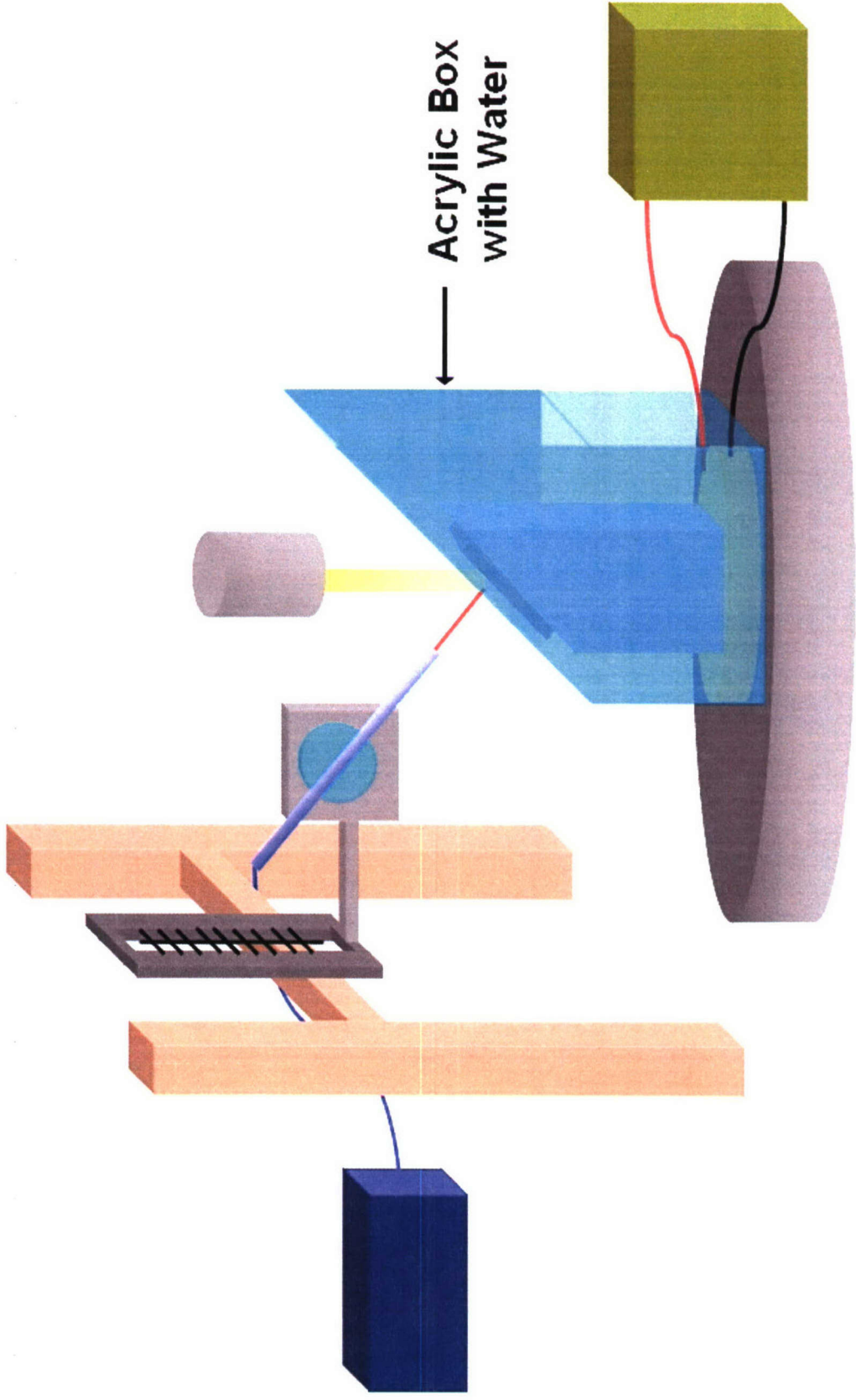

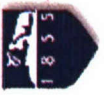

S.O.W. 2 - Experimental Results for Sensor Vibration in Water

Performed experiments on ?? sensors

- Mean Resonant Frequency = ?? KHZ
- Standard Deviation = ?? KHZ



S.O.W. 2 - Experimental Results for Sensor Vibration in Water

Due to fluid loading the resonant frequency decreased
from 90.037 KHz in air to ??? KHz in water.

(Explanation and comment on applicability in water)



Future Proposal

- **Modify existing shear stress sensor for water tunnel experiment**
 - **Optical sensing will require embedding fibers.**
 - **Capacitive sensing will require waterproofing.**