



US Army Corps
of Engineers®
Engineer Research and
Development Center

Resuspension Physics of Fine Particles

Chang W. Sohn

May 2006

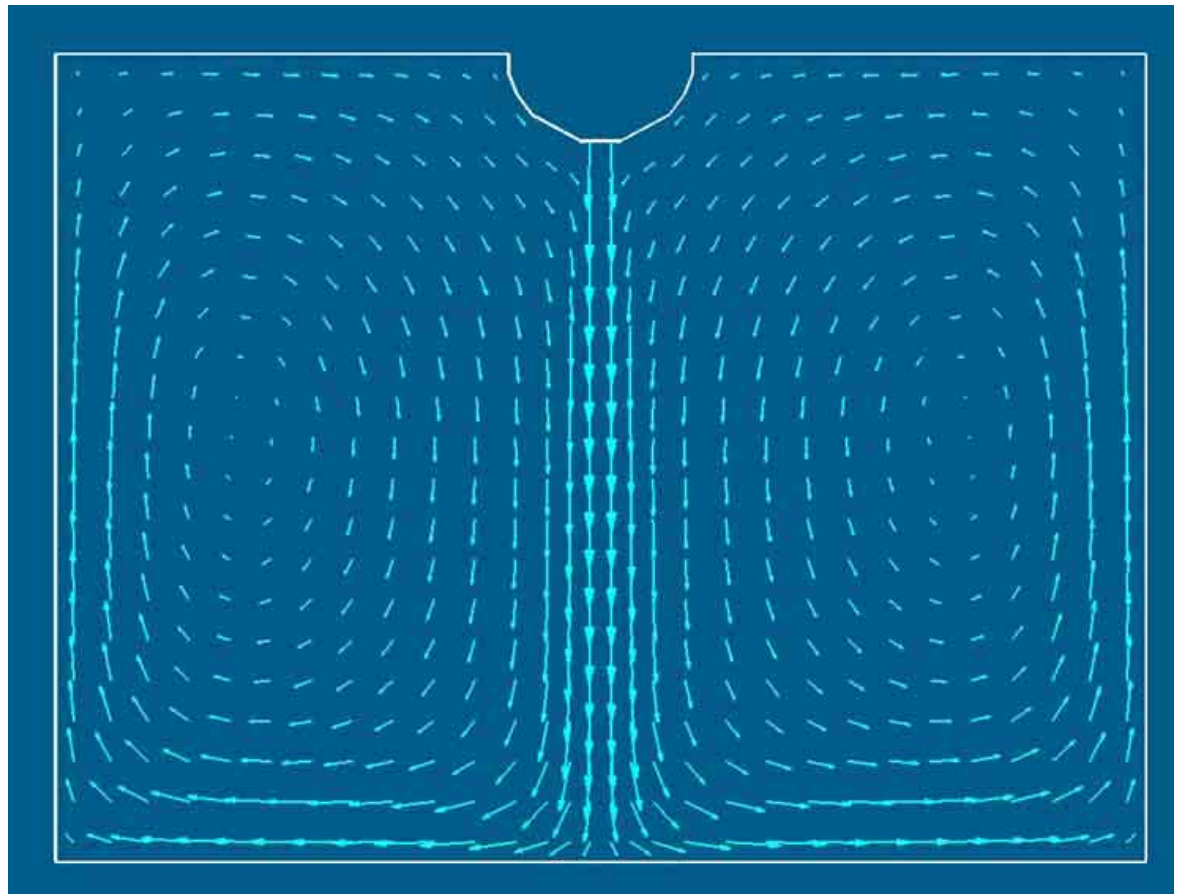

Resuspension Physics of Fine Particles

Chang W. Sohn

*Construction Engineering Research Laboratory (CERL)
U.S. Army Engineer Research and Development Center
2902 Newmark Dr.
Champaign, IL 61824*

Final Report

Approved for public release; distribution is unlimited.

Abstract: Different release models can yield significantly different dynamic concentration profiles in a room depending on the release rates chosen. Results from two different cases demonstrated significantly different concentration profiles in the room of interest. This work was undertaken to: (1) Critically review the current model, (2) formulate a new, 1st order Algebraic model, and (3) use experimental data to validate the modeled theory. This report documents preliminary work that was suspended after Fiscal year 2005 (FY05). No follow-on research is currently funded.

DISCLAIMER: The contents of this report are not to be used for advertising, publication, or promotional purposes. Citation of trade names does not constitute an official endorsement or approval of the use of such commercial products. All product names and trademarks cited are the property of their respective owners. The findings of this report are not to be construed as an official Department of the Army position unless so designated by other authorized documents.

DESTROY THIS REPORT WHEN NO LONGER NEEDED. DO NOT RETURN IT TO THE ORIGINATOR.

Contents

Figures and Tables	iv
Preface	v
1 Introduction	1
Background	1
Objective	1
Approach.....	1
Scope	2
2 Project Summary	3
3 Flow and Dispersion in a Pseudo-Rectangular Chamber	22
4 Summary	35
Appendix A: Experimental Measurement of Particle Re-Suspension by Airflow in a Bench-Scale Chamber: Preliminary Results	36
Report Documentation Page	45

Figures and Tables

Figures

A1	The average of the minimum, average and maximum air velocity in the (a) horizontal and (b) vertical direction measured at the nine measurement locations for the five different fan speeds	40
A2	Airborne mass concentration of particles measured by the APS during the re-suspension phase of Experiment 2. The data are 10-minute integrated concentrations collected during the following time intervals after the fan speed was increased to 75: (a) 0-10 minutes, (b) 10-20 minutes, (c) 20-30 minutes, (d) 30-40 minutes and (e) 40-50 minutes	42
A3	Fraction of deposited particle mass re-suspended from (a) linoleum and (b) carpet during 1 hour at a fan speed of 75	43
A4	Fraction of deposited particle mass re-suspended from (a) linoleum and (b) carpet during 1 hour at a fan speed of 110	43
A5	Fraction of deposited particle mass re-suspended from (a) linoleum and (b) carpet during 1 hour at a fan speed of 140	44

Tables

A1	Summary of experimental conditions.	38
A2	Summary of measured variable speed fan flow rates	39

Preface

This study was conducted for the Engineer Research and Development Center, Construction Engineering Research Laboratory (ERDC/CERL), U.S. Army of Corps of Engineers under 6.1 Basic Research, “Resuspension Physics of Fine Particles” The technical monitor was Dr. John M. Cullinane, CEERD-EM-J. This study was also supported in part by the Project GD1KGD “Bldg Chem-Bio Protection Modeling & Simulation.” The technical monitor was Dr. Paul Howdyshell, CEERD-CV-ZT.

The work was performed by the Energy Branch (CF-E) of the Facilities Division (CF), Construction Engineering Research Laboratory (CERL). The CERL Principal Investigator was Dr. Chang W. Sohn. Dr. Thomas J. Hartranft is Chief, CEERD-CF-E, and L. Michael Golish is Chief, CEERD-CF. The associated Technical Director was Dr. Paul A. Howdyshell, CEERD-CF-F. The Acting Director of CERL is Dr. Ilker R. Adiguzel.

CERL is an element of the U.S. Army Engineer Research and Development Center (ERDC), U.S. Army Corps of Engineers. The Commander and Executive Director of ERDC is COL James R. Rowan, and the Director of ERDC is Dr. James R. Houston.

1 Introduction

Background

Different release models can yield significantly different dynamic concentration profiles in a room depending on the release rates chosen. Results from two different cases demonstrated significantly different concentration profiles in the room of interest. There is a need to critically review the current model to:

1. Identify limitation of the zero-th order model (zero-th order model: $c = M/V = \text{uniform constant}$)
2. Establish time and length scales, identify field variables of significance based on typical HVAC operating conditions.

This ERDC Special Report includes documents several pieces of analysis accomplished in the first year of (what was planned to be) a 3-year effort. At ERDC management's direction, the project was stopped after completion of the following initial steps:

1. Project Summary Presentation (p 3)
 - a. Introduction
 - b. Synopsis of FY05 activities
 - c. Benefits to (other) projects
 - d. Ideas for follow-on work
2. Experimental and numerical comparisons
3. Experimental tests (Appendix A).

Objective

The overall objectives of this project were to:

1. Critically review the current model
2. Formulate a new, 1st order Algebraic model
3. Use Experimental data to validate the modeled theory.

Approach

Work in this project included:

1. Literature Review
2. Initial Research Results

3. Collaboration Development with Lawrence Berkeley National Laboratory [LBNL] Experimental Data)

Scope

This report documents preliminary work that was suspended after Fiscal year 2005 (FY05). No follow-on research is currently funded.

2 Project Summary



6.1 Project Wrap UP

CFEMD05AT23GasParticleDisp
17 Oct 2005

Resuspension physics of fine particles

Dr. Chang W. Sohn, ERDC-CERL



One Corps, One Regiment, One Team . . . Serving Soldiers, the Army, the Nation



Contents of Presentation

1. Introduction

2. Synopsis of FY05 Activities
Literature Review
Initial Research Results
Collaboration Development

3. Benefits to Current Projects
Partial Validation of PAR3D

4. Ideas for Follow On Works
with ERDC
with Others (e.g., DTRA, NSF,...)



One Corps, One Regiment, One Team . . . Serving Soldiers, the Army, the Nation



US Army Engineer Research & Development Center



One Corps, One Regiment, One Team . . . Serving Soldiers, the Army, the Nation

1. Introduction

-Problem Statement

-FY05 Scheduled Activities

-Impact of Source BC
on dispersion modeling



US Army Engineer Research & Development Center



One Corps, One Regiment, One Team . . . Serving Soldiers, the Army, the Nation

Problem Statement

- Formulate concentration field at the initial release of particles from source (0th, Algebraic, and differential models)

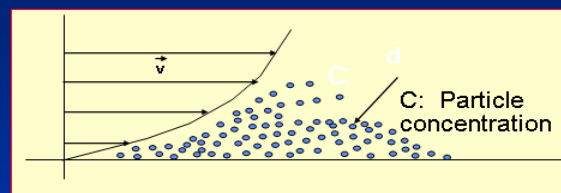

$$c(t) = f_1(t, x, V, P, S, A)$$

- where:
- Particle material property (P) $\rightarrow \rho_p, \sigma, r, d$
 - Surface property (S) $\rightarrow R, g, \dots$
 - Air stream property (A) $\rightarrow v, T, \rho_a, p, h$

- HYPOTHESIS: Higher order models provide realistic particle dispersion information in a given space**



Scheduled Activities (FY05)

US Army Engineer Research & Development Center



One Corps, One Regiment, One Team . . . Serving Soldiers, the Army, the Nation

1. Critical review of current model

- a. Identify limitation of the 0th order model ($c = M/V = \text{uniform constant}$)
- b. Establish time and length scales, identify field variables of significance based on typical HVAC operating conditions

2. Algebraic formulation (1st order model)

- a. Identify app dimensionless groups
- b. Dimensional analysis, algebraic formulation
- c. Dispersion simulation on PAR3D (CFD platform)

3. Experimental data for theory validation

- a. Laboratory exp data from LBNL



Impact of Source BCs on Dispersion Modeling

US Army Engineer Research & Development Center



One Corps, One Regiment, One Team . . . Serving Soldiers, the Army, the Nation

- Resuspension models (e.g., $c_0 = \text{const}$) result in significant differences in the dynamic concentration profiles in a room depending on the values chosen.
- Results from two different cases ($c_0 = 1$ gram/sec for 10 minutes, and $C_0 = 12$ gram/ms for 50 milliseconds) demonstrated significantly different concentration profiles in the room of interest.

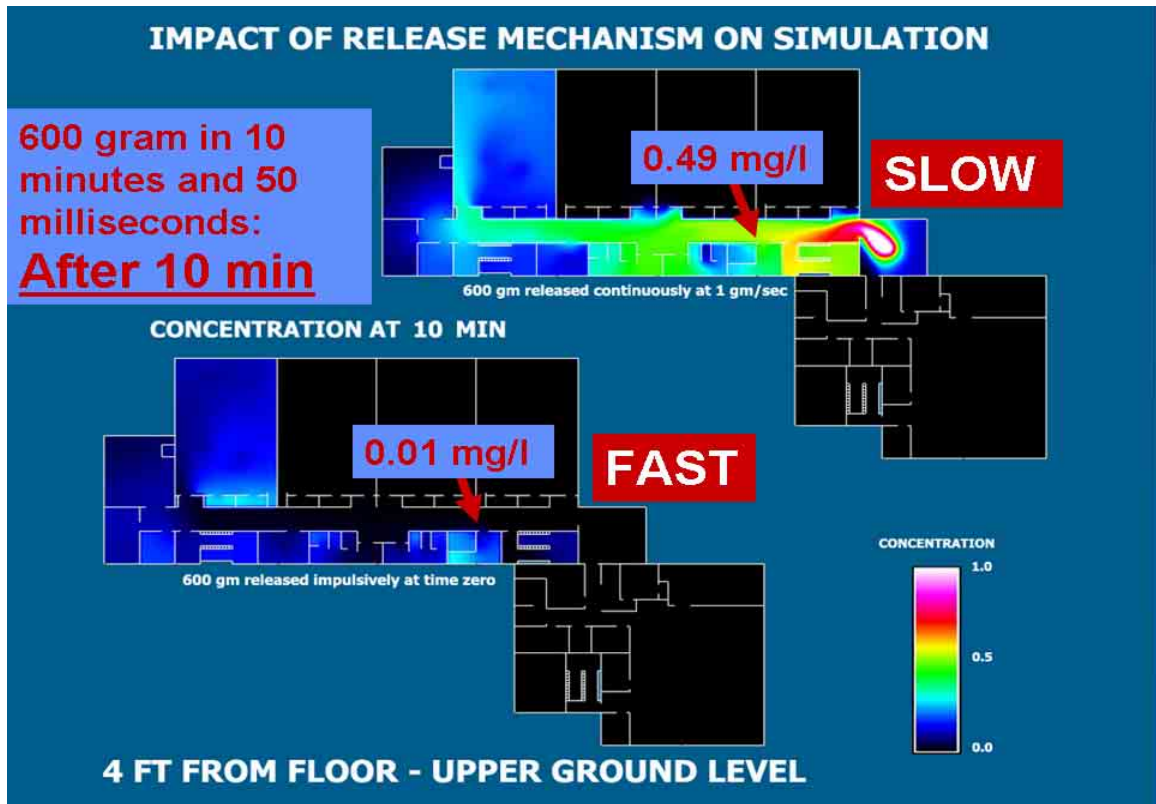
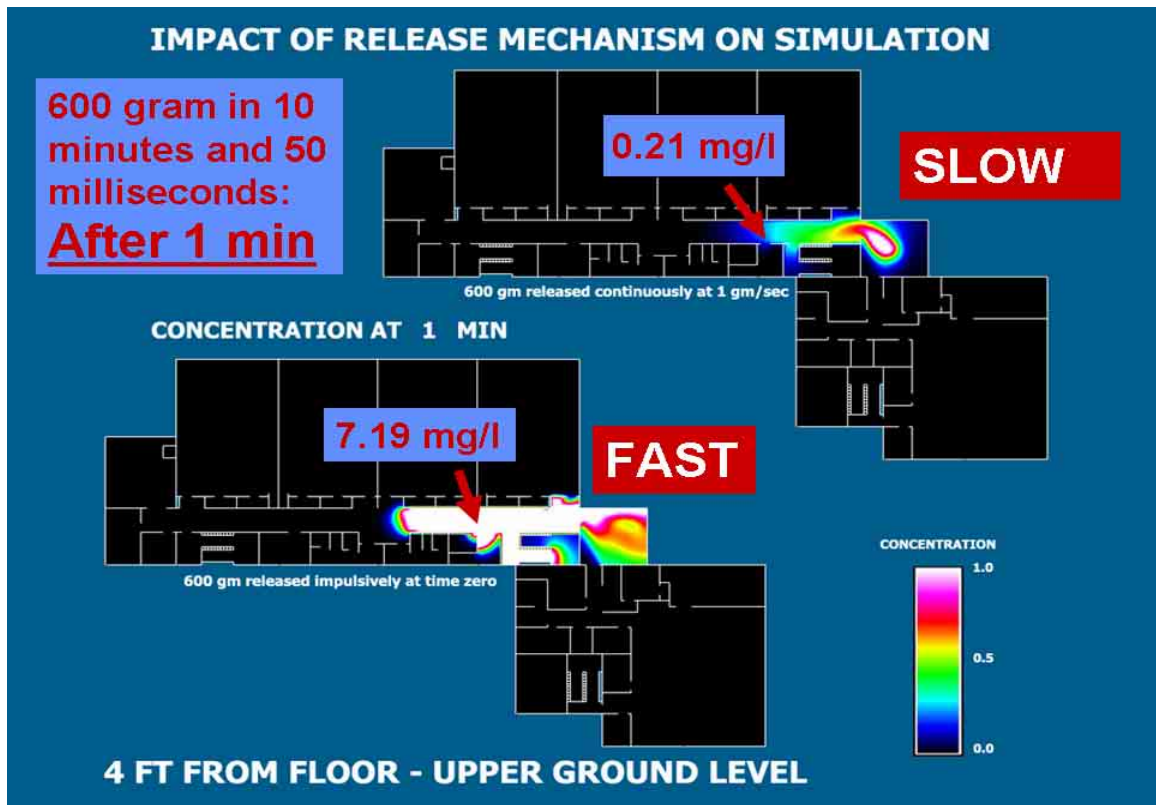



Identification of scales of field variables

Definition of scales of interest

- Length scale
 - Room dimension in m (L_r)
 - Particle dimension in μ (d_p)
 - Roughness dimension mm (R)
 - Boundary layer thickness in Cm (δ), based on Blasius solution
- Mass scale
 - Particle density in gram/Cm³ (ρ_p)
 - Air density in 0.0012 gram/Cm³ (ρ_a)
- Time scale in second
- Velocity scale
 - Room air bulk motion in m/sec (u_r)
 - Particle settling velocity in mm/sec (u_p), based on Stokes flow
 - Friction velocity in m/sec (u_*)
- Concentration scale in ppb (c)



2. Synopsis of FY05 Activities

- Literature Review
- Initial Research Results
- Collaboration Development
(LBNL Experimental Data)



Accomplishments - Literature Review

Literature review in the related areas:

- Indoor Air Quality Modeling
- Outdoor Resuspension Modeling
- Erosion and Sedimentation Modeling

(Slides on each topic are attached at the end of presentation.)



Accomplishments - Algebraic Model

Algebraic model development:

$$C(t) = f(Re^*)$$

Preliminary linear algebraic model:

$$\underline{C(t) / c_0 = \alpha Re^*(t) / Re^*_c}$$

- Note that $Re^*(t)$ is a function of time due to $u_*(t)$.
- Re^*_c is the critical Reynolds number for resuspension
- C_0 is specified by initial flux density, i.e., $C_0 = M/S$.
- α is an empirical constant determined from data.



Accomplishments - Experimental Validation

Collaboration with LBNL

MIPR (May-Sep 05) - Experimental Determination of Particle Resuspension from Room Surfaces due to Air Turbulence

“... scoping experiments will be performed to determine the potential significance of resuspension caused by turbulence in the indoor environment. The basic experimental procedure will involve the deposition of a known quantity of a well characterized poly-dispersed particle source (such as ISO 12103-1, A1 ultra-fine test dust) onto a surface, subjecting the test surface to well characterized turbulent flow inside an experimental chamber, and measuring the airborne concentration of resuspended particles within the chamber using a particle sizing instrument (TSI, Inc.: APS 3321) to determine the size dependent resuspension rate.”



One Corps, One Regiment, One Team . . . Serving Soldiers, the Army, the Nation



LBNL Test Chamber

Test chamber used in the LBNL experiments



Figure 1: Experimental Chamber (door removed)



One Corps, One Regiment, One Team . . . Serving Soldiers, the Army, the Nation

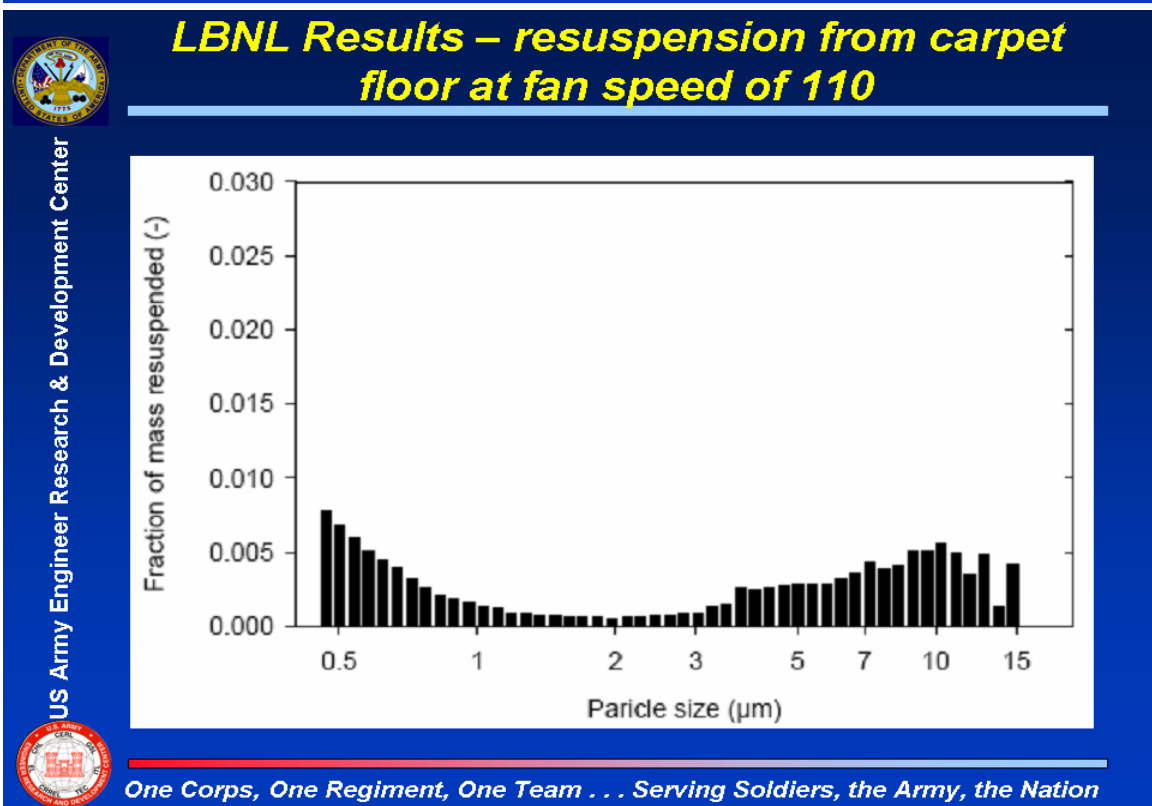
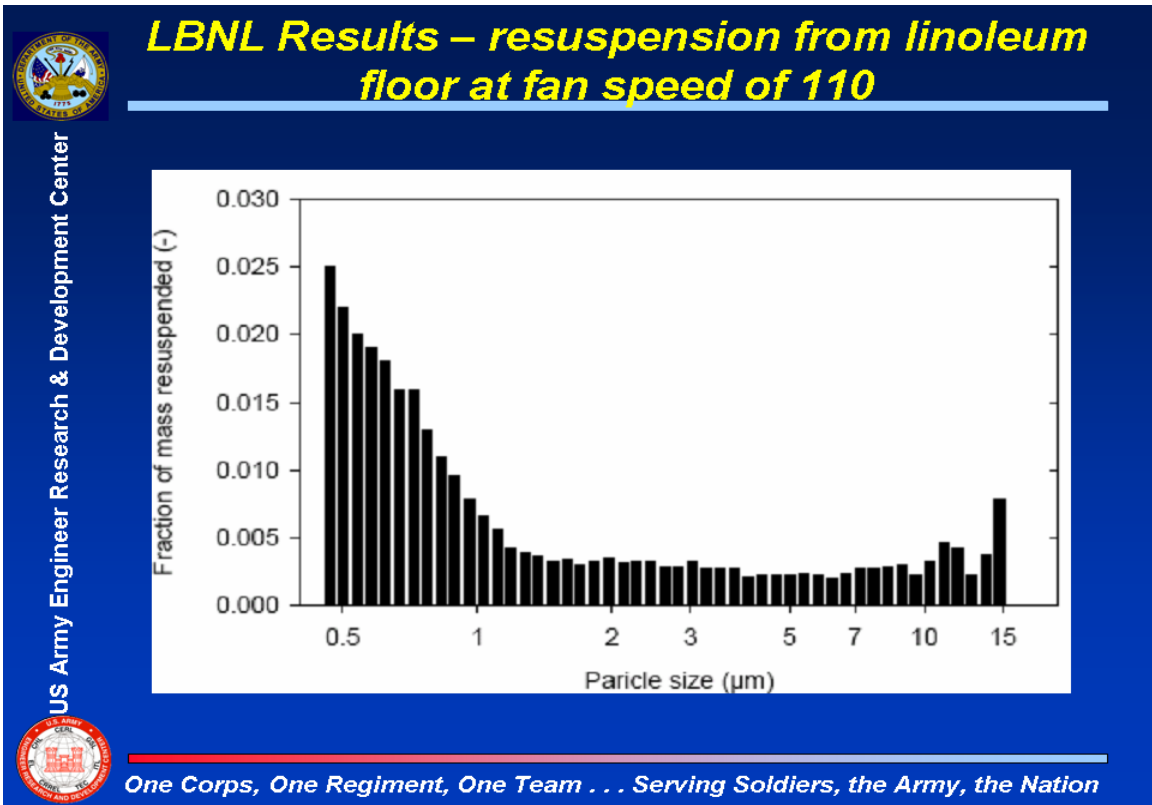



PRODUCTS in FY05

US Army Engineer Research & Development Center

1. White Paper, "White Paper on Gas/Particle Dispersion in Army Facilities (AT23-05-32)," 11 JAN 05
2. PAR3D Validation, "Flow and Dispersion in a Pseudo-Rectangular Chamber. Comparison of PAR3D Predictions with Experiments Conducted by Shimada et. al.," 6 Apr 05.
3. LBNL Experimental Data, "Experimental Measurements of Particle Resuspension by Airflow in a Bench-Scale Chamber: Preliminary Results," Sep 05
4. Project Wrap UP Briefing PP file, "Resuspension Physics of Fine Particles," 17 Oct 05.

(These products are provided in electronic files.)

One Corps, One Regiment, One Team . . . Serving Soldiers, the Army, the Nation



3. Benefits to Current Projects

US Army Engineer Research & Development Center

Product #2, "PAR3D Validation - Flow and Dispersion in a Pseudo-Rectangular Chamber. Comparison of PAR3D Predictions with Experiments Conducted by Shimada et. al.*" is used as a part of 6.2 M&S CFD platform Verification and Validation.

[* Shimada, M., K. Okuyama, S. Okazaki, T. Asai, M. Matsukura, and Y. Ishizu, "Numerical Simulation and Experiment on the Transport of Fine Particles in a Ventilated Room," Aerosol Science and Technology, Vol 25, Issue 3, October 1996, pp. 242-253]

One Corps, One Regiment, One Team . . . Serving Soldiers, the Army, the Nation



4. Ideas for Follow On Works

US Army Engineer Research & Development Center

1. Data Reduction of the LBNL Experiments in the form of $c(t) = f(Re^*)$
2. Review of the algebraic model $(C(t)/c_0) = \alpha Re^*(t)/Re^*_c$ in comparison to the LBNL experimental data
3. Refinement of the algebraic model for application to general dispersion transport modeling (multizone, CFD, etc.)



One Corps, One Regiment, One Team . . . Serving Soldiers, the Army, the Nation



4. Ideas for Potential Funding

US Army Engineer Research & Development Center

1. In ERDC - Another try in 6.1 competition?
2. In DoD – Look for basic research opportunities.
3. In Academia – Team up with academia (e.g., UIUC) for a proposal to NSF?
4. In Public – A Research Topic for ASHRAE TC 4.10 (Indoor Environmental Simulation)



One Corps, One Regiment, One Team . . . Serving Soldiers, the Army, the Nation



US Army Engineer Research & Development Center

Questions and Comments?



One Corps, One Regiment, One Team . . . Serving Soldiers, the Army, the Nation



US Army Engineer Research & Development Center

Additional Slides for Detailed Information



One Corps, One Regiment, One Team . . . Serving Soldiers, the Army, the Nation



Two Key Models in M&S: Dosage and source models

US Army Engineer Research & Development Center

Prediction accuracy of concentration can be only as accurate as the source strength input.

No accepted theoretical model of indoor resuspension yet :
(Subject of this Project)

Experiments currently on going for empirical model development (LBNL, LLNL)

Dosage = Concentration * Exposure time * Retention efficiency
(Time-varying concentration at a point is the Life Safety Issue.)
-Beyond the scope of this project.

“Source term models **and** dose response models are the two key technical elements” for “existing and future interior and exterior codes.” [SNL/ECBC, DHS Conf paper, Apr 05]



One Corps, One Regiment, One Team . . . Serving Soldiers, the Army, the Nation



Limitation of the 0th order model

US Army Engineer Research & Development Center

- Limitation of the 0th order model in dynamic simulation of concentration distribution in a room is demonstrated – The inherent assumption of “uniform concentration in a space, i.e., $c=M/V$ ” cannot provide desired concentration information in a room of interest.



One Corps, One Regiment, One Team . . . Serving Soldiers, the Army, the Nation

Accomplishment – Limitation of 0th order model
(Phase 1 Results)

- Uniform concentration (constant model)

The figure shows two side-by-side visualizations. On the left, 'CONTAM Output' displays a schematic floor plan of a building with various rooms and corridors. On the right, 'CFD calculation' shows a corresponding 3D heatmap of the same building. The heatmap uses a color scale from blue (low concentration) to red (high concentration) to show the distribution of CO2. A vertical color bar on the right of the heatmap is labeled 'CO2 concentration gradient' and 'Concentration (ppm) x 2000', with values ranging from -10000 to 2000. The CFD calculation shows a more detailed and varied concentration distribution compared to the uniform model shown in the CONTAM output.

US Army Engineer Research & Development Center

One Corps, One Regiment, One Team . . . Serving Soldiers, the Army, the Nation

Accomplishment – Algebraic Model

Identified Dimensionless groups

- $Re_d = u_p d / \nu$ (Particle Reynolds number)
- $Re_\delta = u_r \delta / \nu$ (Re based on turbulent boundary layer thickness, δ)
- $Fr = u_*^2 / g \delta$ (Froude number)
- $d_p / R =$ (Roughness factor)
- $St = \tau_p / \tau_L$ (Stokes number)
- $Gr = \rho^2 g \delta^3 \Delta \rho / \mu^2$ (Grashof number)
- $DF = u_{p,\infty} / u_*$ (drift factor)

["Numerical approaches for motion of dispersed particles, droplets and bubbles," E. Loth, 2000, Progress in Energy and Combustion Science, vol. 26, pp. 161-223]

US Army Engineer Research & Development Center

One Corps, One Regiment, One Team . . . Serving Soldiers, the Army, the Nation



Accomplishments - Literature Review

US Army Engineer Research & Development Center



Related Studies on Indoor Air Quality (IAQ) Modeling

In IAQ modeling, either by multizone or CFD models, ... -

”Contaminants introduced at the inlets can be specified as either constant or **varying according to user-defined functions**”

“An Analysis of Combined CFD and Multizone IAQ Model Assembly Issues,”
A. Musser, *ASHRAE Trans*, AT-01-1-3, pp. 371-382, 2001

“Choosing a Multiphase Model: User must know *a priori* the characteristics of flow: Flow regime, Laminar/turbulent, Dilute/dense, Particulate Loading, Stokes number, Secondary phase (??) diameter for drag considerations”

“FLUENT v6.0: Training Notes, pp. 9-8, Jan 2002”

One Corps, One Regiment, One Team . . . Serving Soldiers, the Army, the Nation



Accomplishments - Literature Review

US Army Engineer Research & Development Center



Related Studies on Outdoor Resuspension

Resuspension rate (Λ) and Resuspension factor (K):

Λ = fraction of surface deposits removed **per** unit time

K = (airborne concentration of deposited material) / (quantity of deposited material per unit area (projected) ground surface.

Experimental determination of Λ from wind tunnel **data**
does not provide onset criteria for particle resuspension.

[Ref: “Evaluation and development of models for resuspension of aerosols at short times after deposition,” G.A. Loosemore, *Atmospheric Environment*, vol 37, 2003, pp. 639-647]

[Ref: “Wind tunnel experiments on the resuspension of particulate material,” K.W. Nicholson, *Atmospheric Environment*, vol 27A, 1993, pp. 181-188]

One Corps, One Regiment, One Team . . . Serving Soldiers, the Army, the Nation



Accomplishments - Literature Review

US Army Engineer Research & Development Center

Outdoor Empirical Models (Current state of art):

$\Lambda = [u_*^{c1} d_p^{c2}] / [t^{c3} z_0^{c4} r_p^{c5}]$, where

Λ : Resuspension rate (Resuspension flux/Initial concentration)

u_* : friction velocity, d_p : particle diameter, t : time, z_0 : surface roughness, r_p : particle density, $c1, \dots, c5$: empirical constants

Current models are based on field and wind tunnel experimental data for soil, grass and concrete surfaces under typical atmospheric environment (Loosmore, 2003).

e.g., $\Lambda = 0.42^*(u_*^{2.13} d_p^{0.17} / t^{0.92} z_0^{0.32} \rho_p^{0.76}) [s^{-1}]$ (Loosmore, 2003)



One Corps, One Regiment, One Team . . . Serving Soldiers, the Army, the Nation



Accomplishments - Literature Review

US Army Engineer Research & Development Center

Related Studies on Erosion and Sedimentation

Resuspension Condition: Beginning of motion depends on **whether** the boundary layer shear stress (τ_0) becomes equal **to** or greater than the critical boundary layer shear stress (τ_c).

$$\tau_c^* = \tau_0 / \tau_c = f(Re^*); \quad Re^* = u_* d_s / \nu_m$$

Shields parameter (dimensionless shear stress, τ^*):

$$\tau^* = \tau_0 / (\gamma_s - \gamma_m) d_s = \rho_m u_*^2 / (\gamma_s - \gamma_m) d_s; \text{ where,}$$

τ_0 : boundary layer shear stress

u_* : shear velocity

γ_s : specific weight of a sediment particle

γ_m : specific weight of the fluid mixture

d_s : particle size

[Ref: "Fluid-Particle Interactions and Resuspension in Simple Shear Flow," Z. Feng and E. Michaelides, J. Hydraulic Eng, ASCE, Dec 2003, pp. 985-994]

[Ref: Erosion and Sedimentation, P. Julien, Cambridge University Press, 1995, pp. 114]

Grain Shear Reynolds number Re^* ($= u_* d_s / \nu_m$) is the deciding factor in the initiation of the particle motion.



One Corps, One Regiment, One Team . . . Serving Soldiers, the Army, the Nation

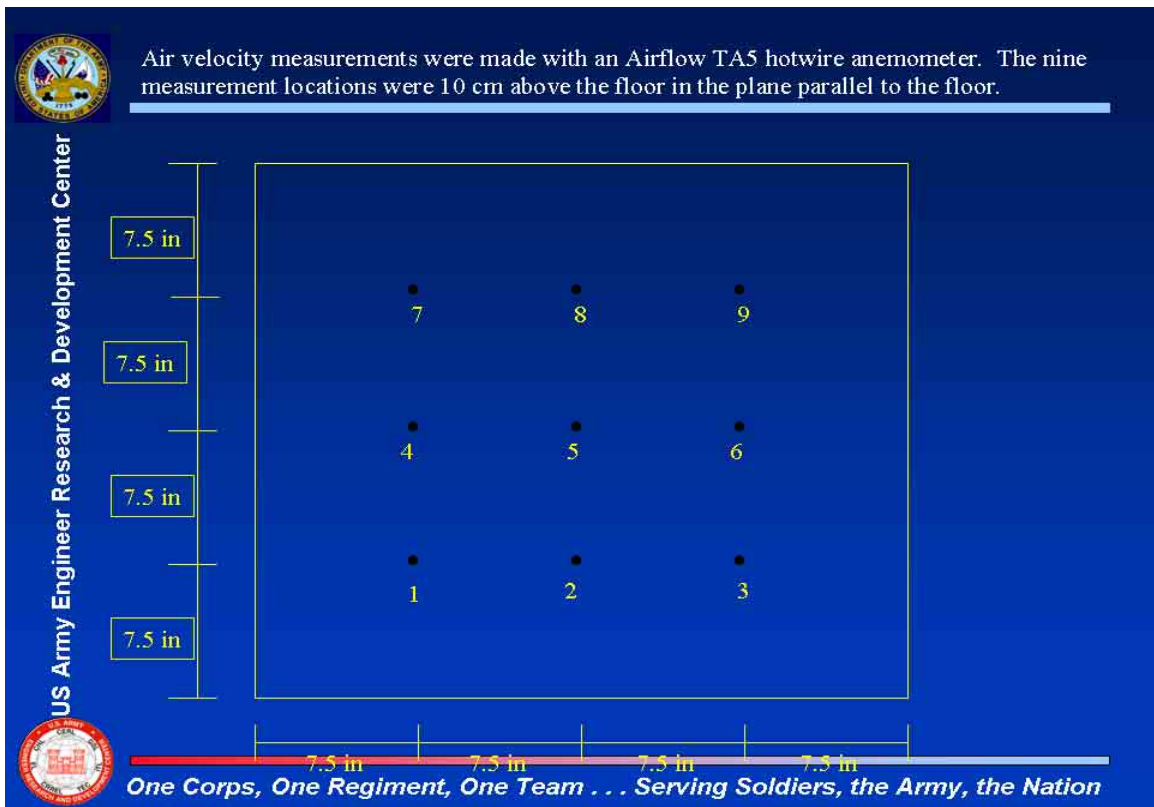

LBNL Results – flow field @Fans at 110

Velocities at each measuring point

	<u>7</u>	<u>8</u>	<u>9</u>
Min	0.35	0.15	0.14
Ave	0.48	0.19	0.27
Max	0.74	0.24	0.47
	<u>4</u>	<u>5</u>	<u>6</u>
Min	0.40	0.22	0.16
Ave	0.57	0.32	0.25
Max	0.72	0.41	0.34
	<u>1</u>	<u>2</u>	<u>3</u>
Min	0.34	0.26	0.20
Ave	0.49	0.49	0.32
Max	0.82	0.67	0.46

US Army Engineer Research & Development Center

One Corps, One Regiment, One Team . . . Serving Soldiers, the Army, the Nation

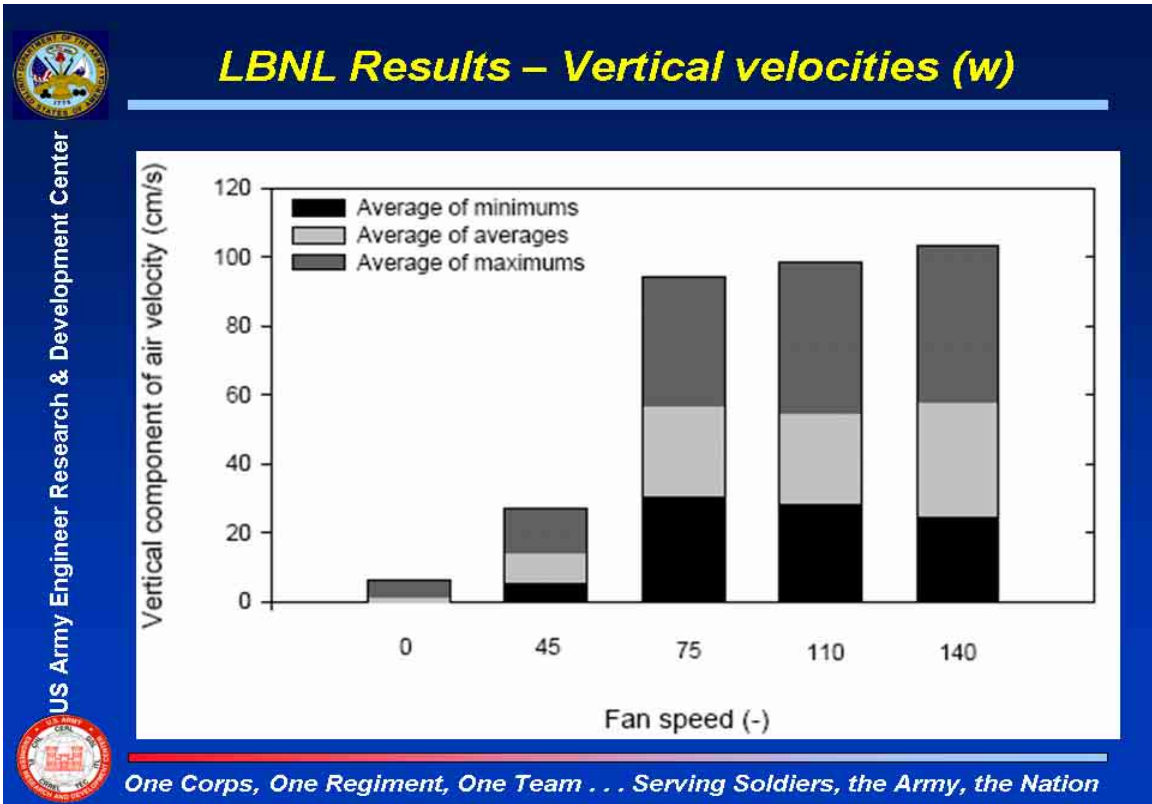
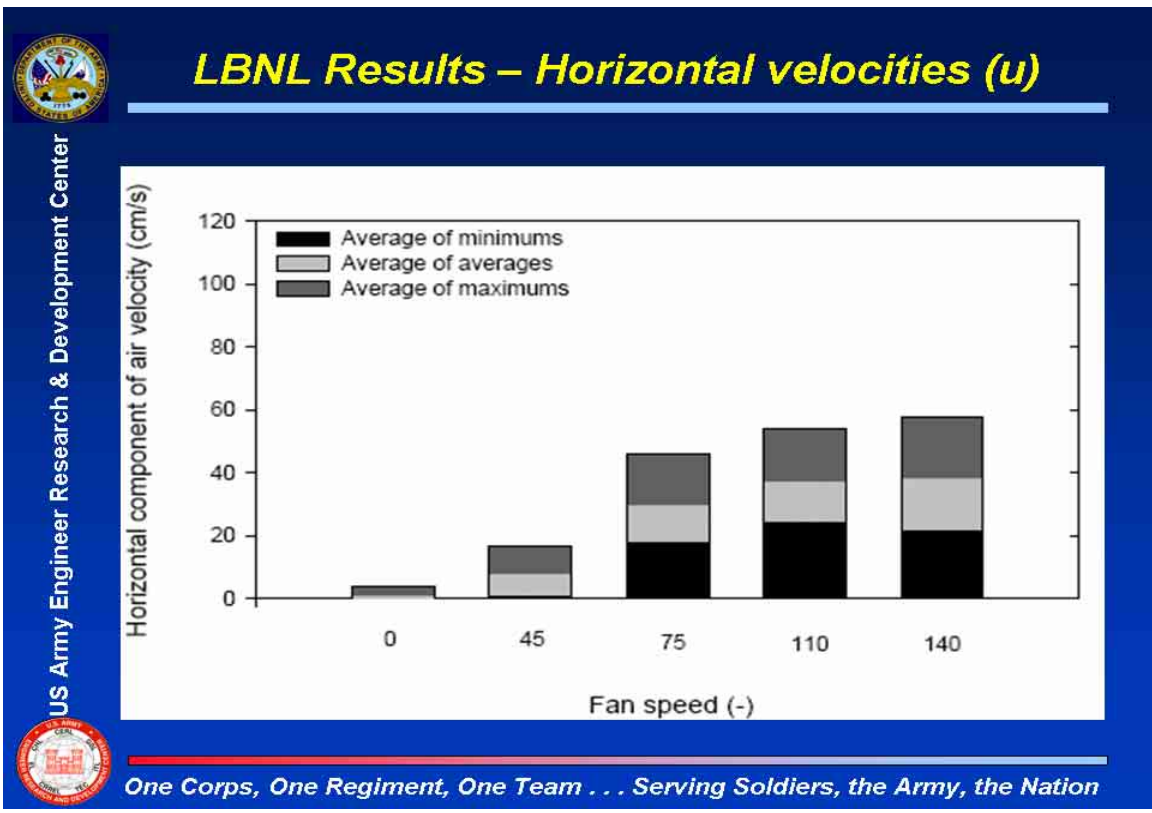





(Provisional) **Project Chronology**

US Army Engineer Research & Development Center

- 1 Oct 04: Project Start
- 19 Oct 04: TD e-mail on IPR prep "...focus on the science accomplished to obtain new knowledge and not on application of the knowledge."
- 28 Oct 04, BREP IPR: (Experimental validation required.)
- 14 Jan 05: White paper produced per comments from BREP IPR
- 28 Feb 05: 2-page Quad Charts briefing to ERDC PMB
- 21 Mar 05: PMB de-brief
- 12 May 05: Re-briefing to PMB (Relevant to the Army?)
- 12 Jul 05: 6.1 VTC scheduled/cancelled. This project will end in FY05. Wrap up FY05 activities in a tech report.
- 3 Aug 05: E-mail notice, FY06 Basic Research IPR on 13-16 Sep 05
- 19 Aug 05: E-mail (from Dr. Cullinane), Project Wrap UP VTC
- 17 Oct 05: Wrap Up briefing to BREP TD



One Corps, One Regiment, One Team . . . Serving Soldiers, the Army, the Nation



(Provisional) **On PMB Comments in May 05**

US Army Engineer Research & Development Center

"Why weaponized anthrax was de-ionized?"

... William C. Patrick III, a microbiologist* who designed germ weapons for the United States before President Richard M. Nixon renounced them in 1969, said he had learned details of the federal inquiry from a senior investigator. The Senate powder, Mr. Patrick said, was quite potent and capable of sailing far through the air to hurt many people. He said the makers of the anthrax spores sent to Mr. Daschle's office had produced a dry powder that was remarkably free of extraneous material. "It's high-grade," said Mr. Patrick, who consults widely on making germ defenses. "It's free flowing. It's electrostatic free. And it's in high concentration." Experts on germ weaponry agree that the removal of electrostatic charges is a major step toward making an effective munition. The Soviet Union and United States developed sophisticated ways of diminishing this attraction and helping the particles float more freely, increasing their ease of dissemination and likelihood of inhalation. Mr. Patrick said that whoever sent the Daschle letter had clearly achieved this step. "It's fluffy," he said, quoting experts who examined the powder. "It appears to have an additive that keeps the spores from clumping." Removing the charge, he added, is a black art, few details of which are known publicly. Assertions by some federal officials that the material was not the type that would be used in weapons are "nonsense," he said. "The only difference between this and weapons grade is the size of the production. ..."

[The New York Times, October 25, 2001, "Contradicting Some U.S. Officials, 3 Scientists Call Anthrax Powder High-Grade]

*William C. Patrick III, a microbiologist – Former Director of Operation at Ft. Detrick



One Corps, One Regiment, One Team . . . Serving Soldiers, the Army, the Nation



(Provisional) **On PMB Comments in May 05**

“Place fine material simulating anthrax on an accurate scale. Leave it alone over the weekend and see how much remains when you come back. Even such a back-of-the envelope approach has not been done to see if the effort would have even slight utility.”

LBLN experimental data in the Product #3 provide the answers to the comment.



US Army Engineer Research & Development Center

One Corps, One Regiment, One Team . . . Serving Soldiers, the Army, the Nation

3 Flow and Dispersion in a Pseudo-Rectangular Chamber

Flow and Dispersion in a Pseudo-Rectangular Chamber

Comparison of PAR3D Predictions with
Experiments Conducted by Shimada et al.

Performed by Robert S. Bernard, ERDC-CHL

Grid outline indicates shape of test chamber
and locations of inflow and outflow ports.

Chamber is 270 cm wide (x-direction),
330 cm long (y-direction), and
200 cm high (z-direction).

Air flows into chamber through slot (5 cm wide)
from elliptical supply duct along ceiling.

Air flows out of chamber through
40-cm square opening centered at
 $x = 135$ cm, $y = 0$, and $z = 35$ cm.

Airflow rate = 257 liters per second

Only steady-state results are shown for velocity.

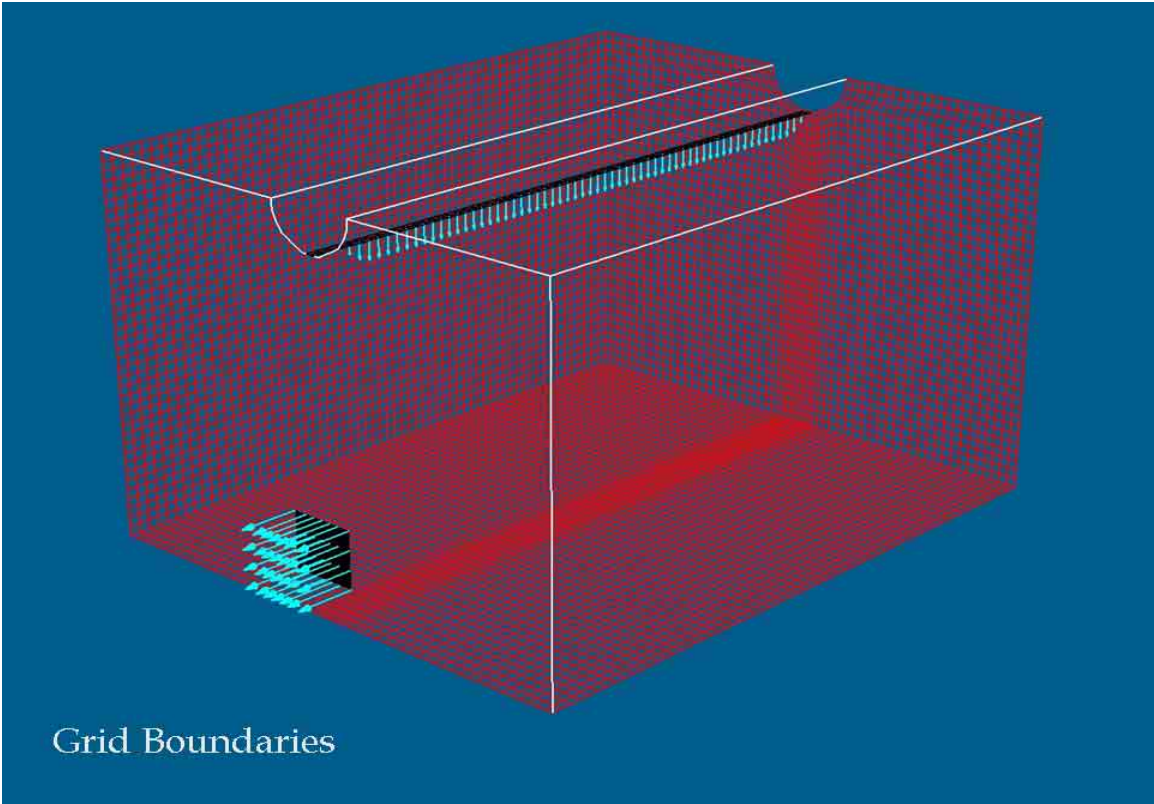
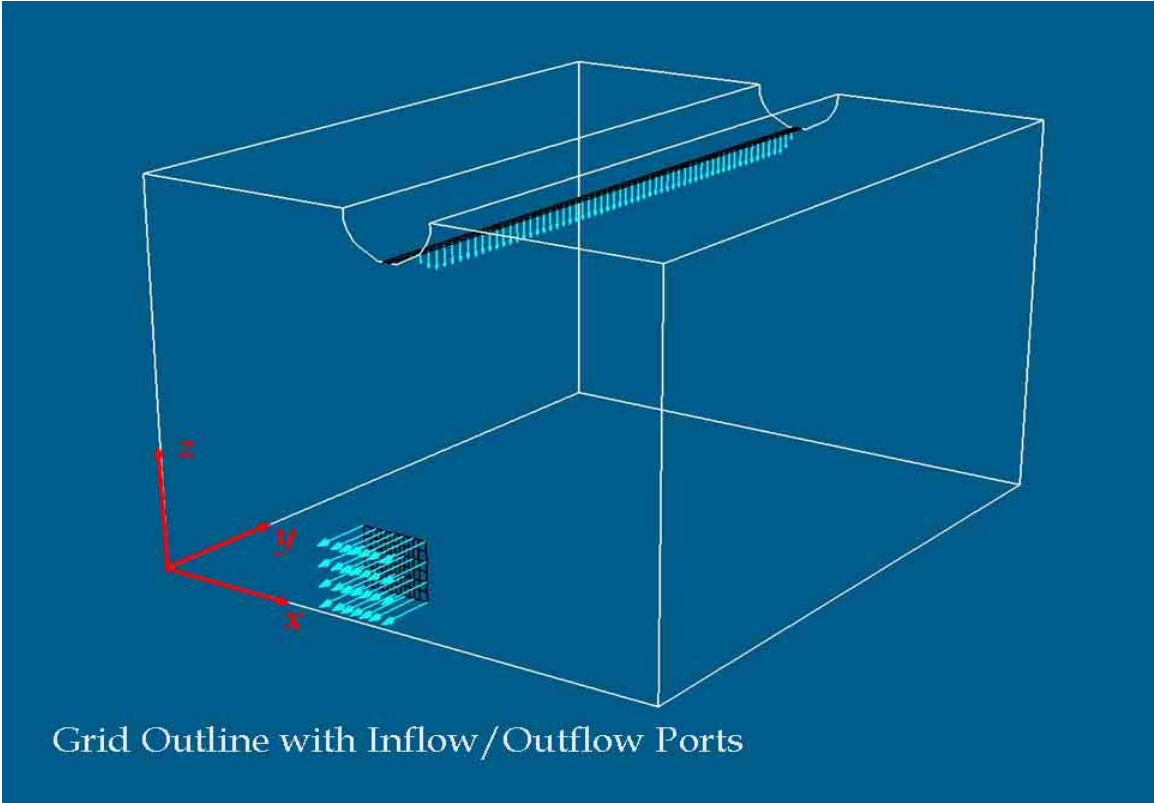

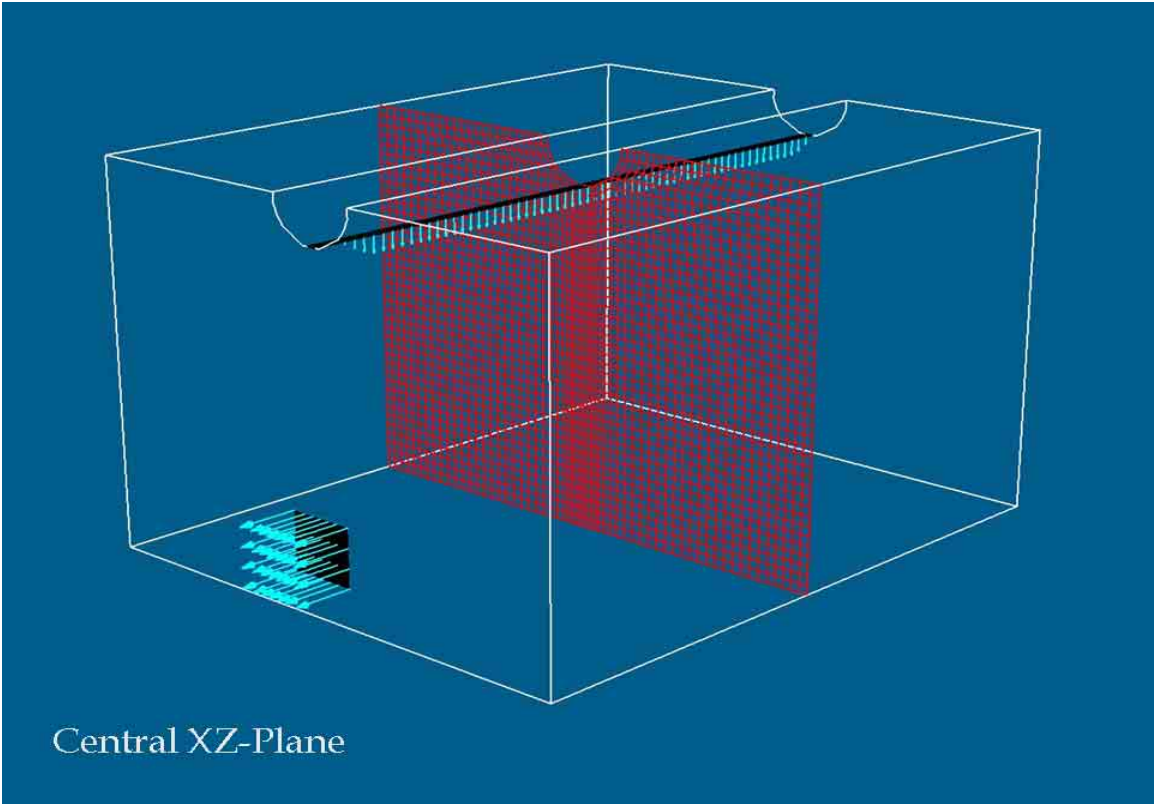
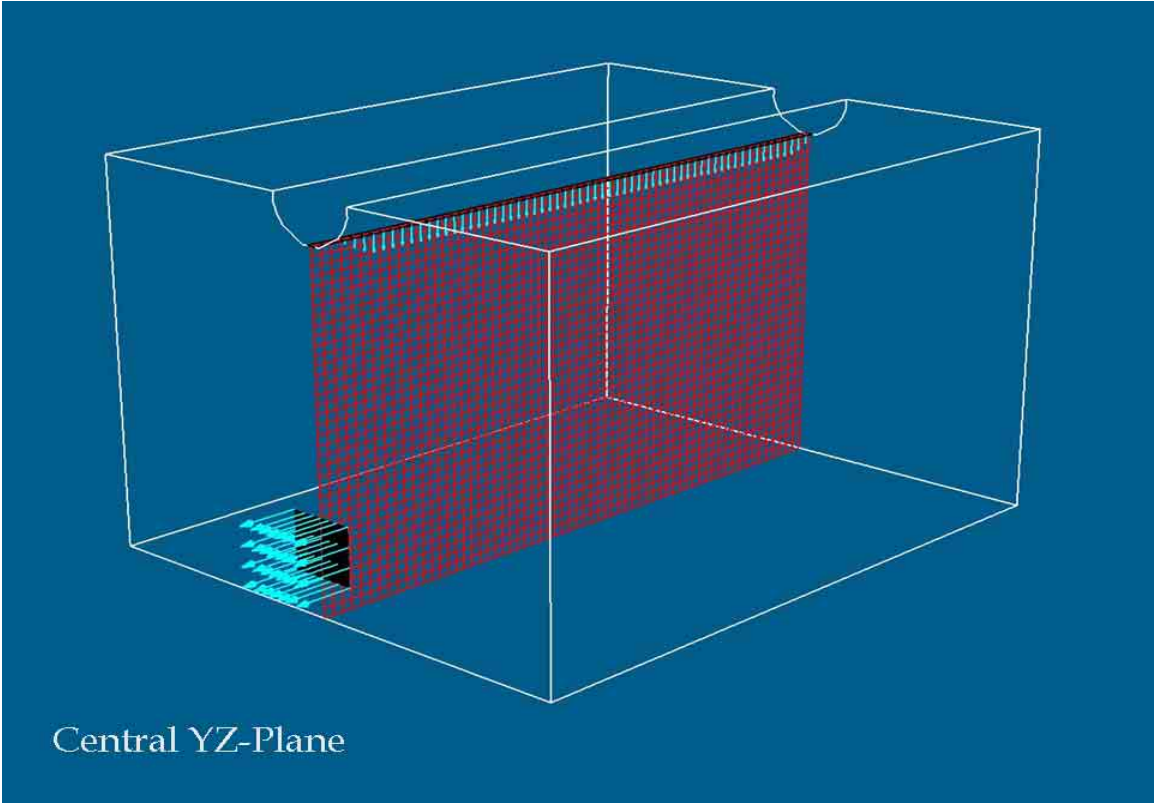

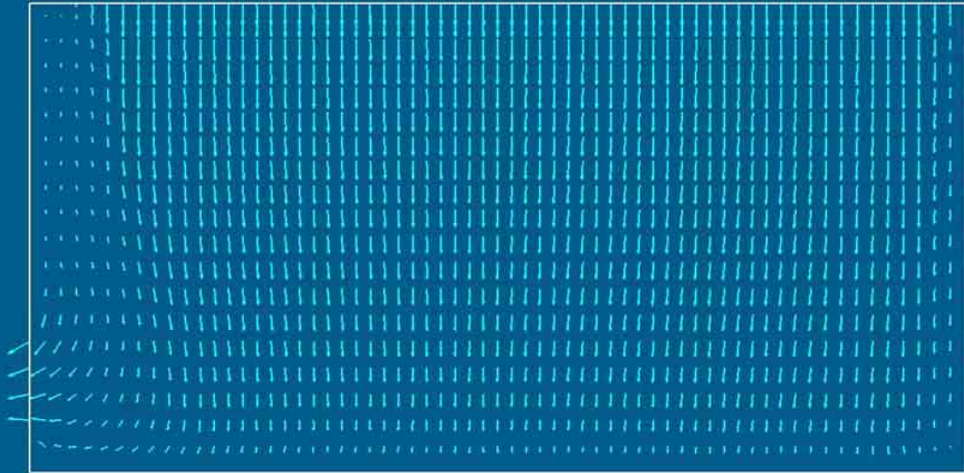

Velocity Vectors in Central YZ-Plane
Computed with no-slip condition

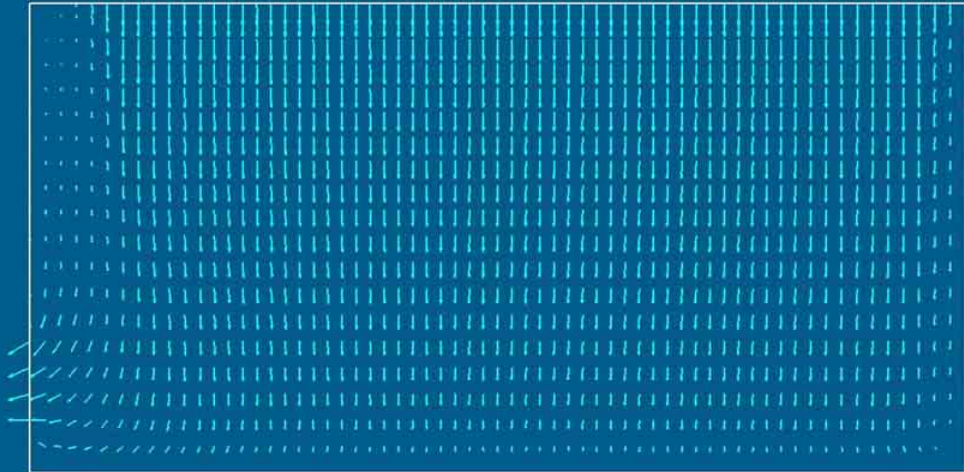

Velocity Vectors in Central YZ-Plane
Computed with slip condition

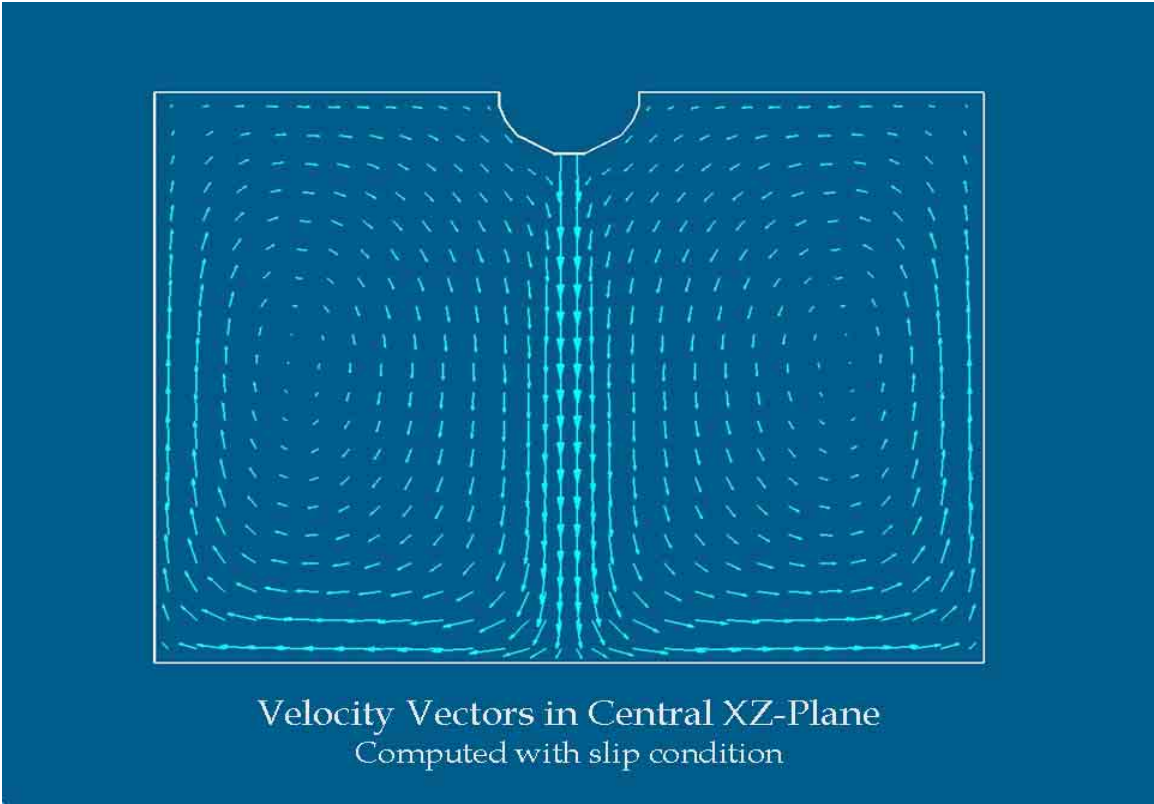
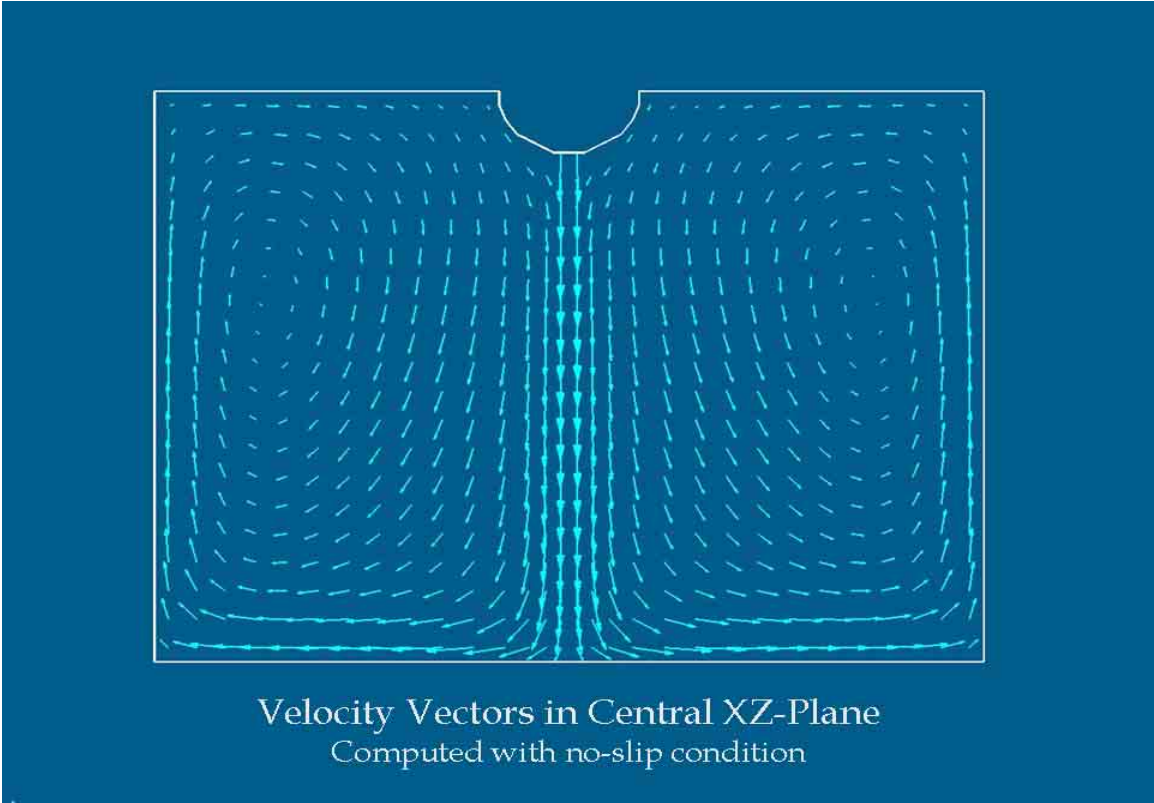

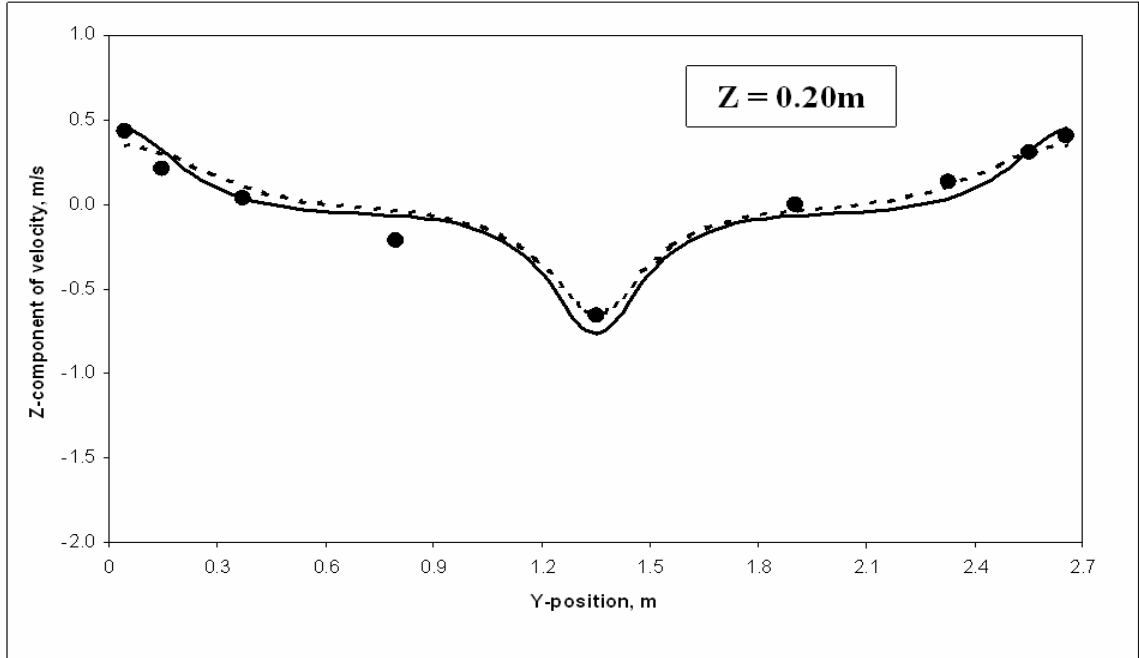

Experimental data for z-component of velocity in central xz-plane (●) compared with PAR3D predictions using slip condition (---) and no-slip condition (—)

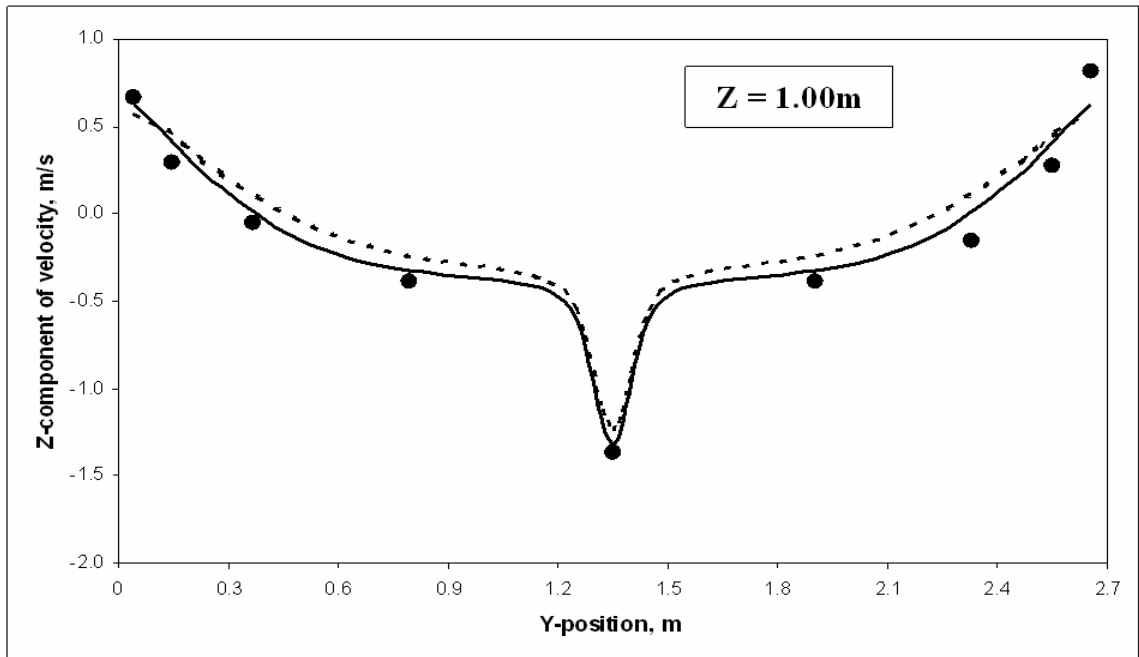

Experimental data for z-component of velocity in central xz-plane (●) compared with PAR3D predictions using slip condition (---) and no-slip condition (—)

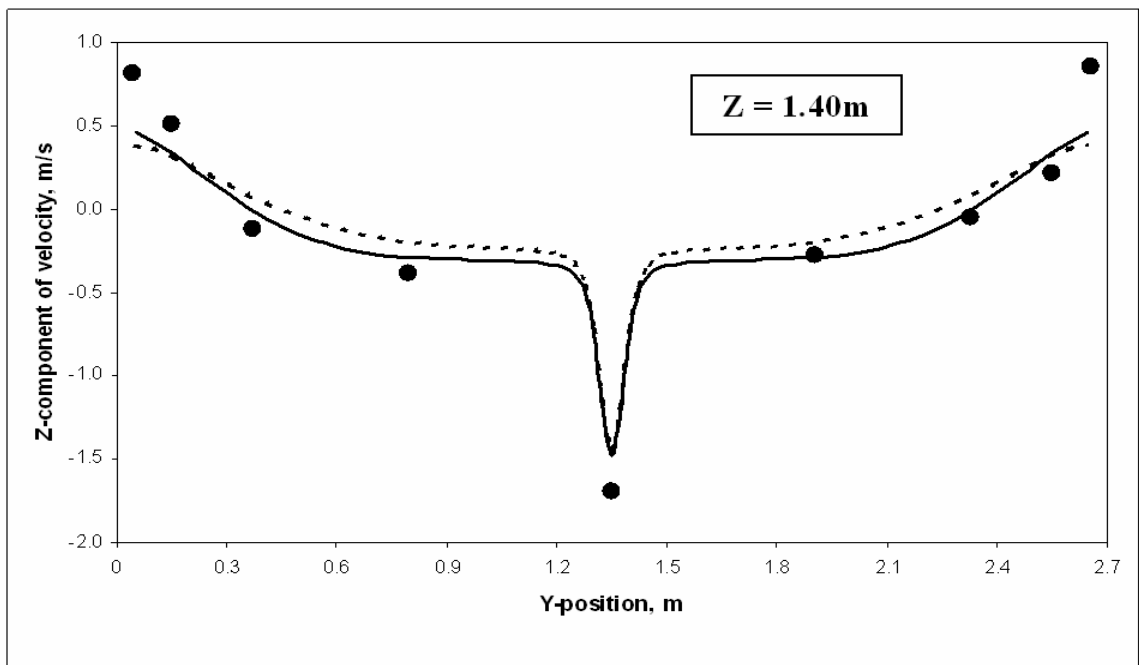

Experimental data for z-component of velocity in central xz-plane (●) compared with PAR3D predictions using slip condition (- - -) and no-slip condition (—)

A particle emitter is placed at the intersection of the central xz- and yz-planes, either 50 cm above the floor (emitter A) or directly on the floor (emitter B).

The normalized emission rate is 0.0167 units per second, equivalent to a concentration of 1.0 units per liter at an airflow rate of 0.0167 liters per second.

Particle concentrations shown here are concentrations relative to the concentration at the emitter.

Only steady-state results are shown for particle concentration.

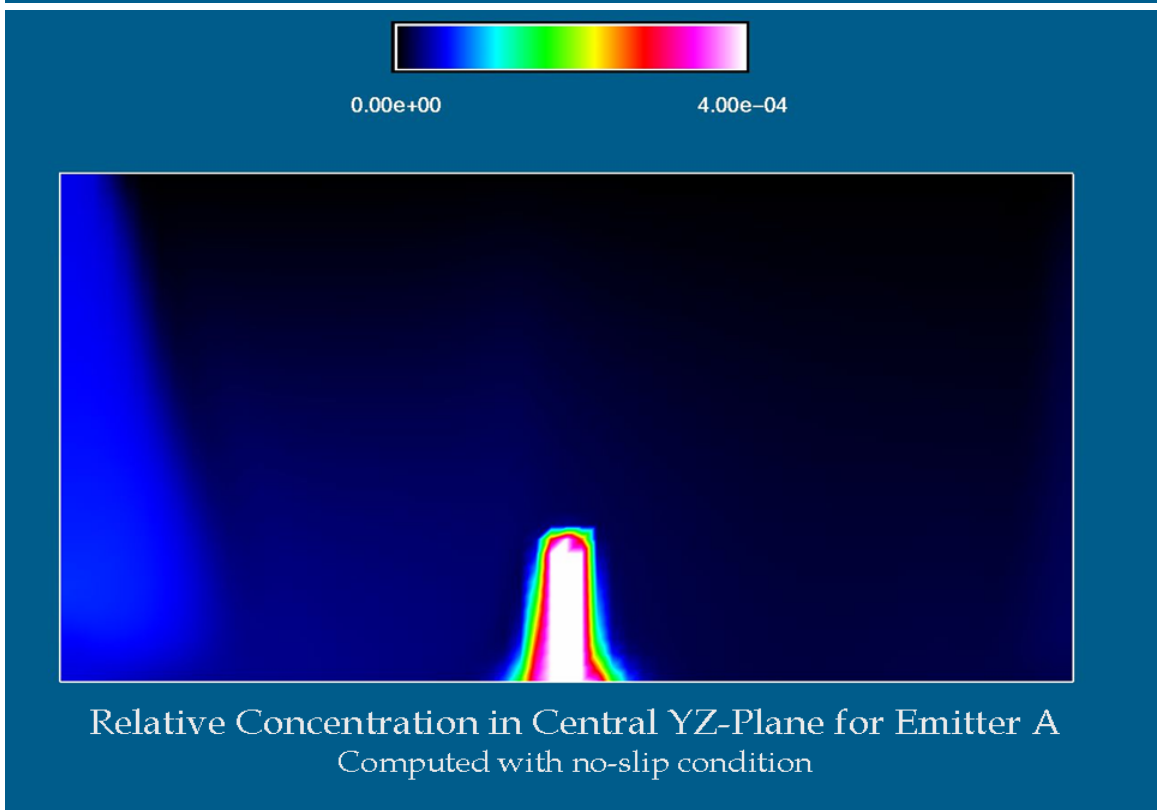
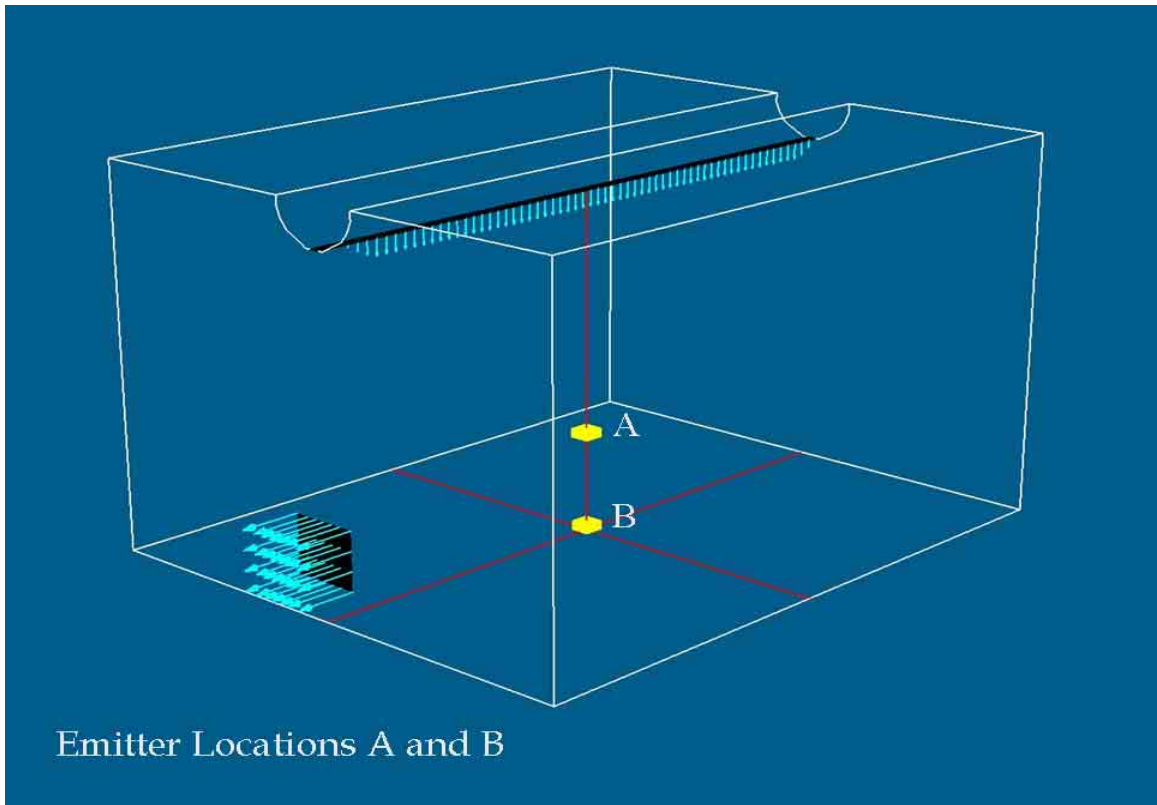

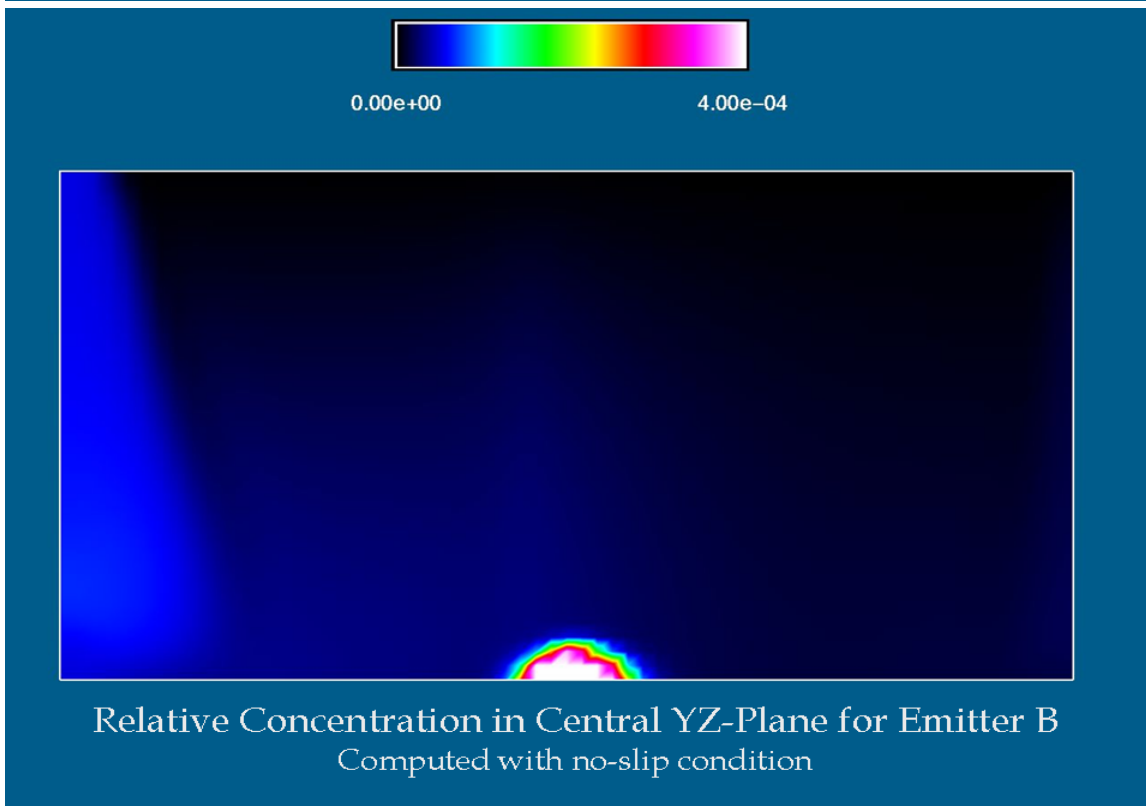
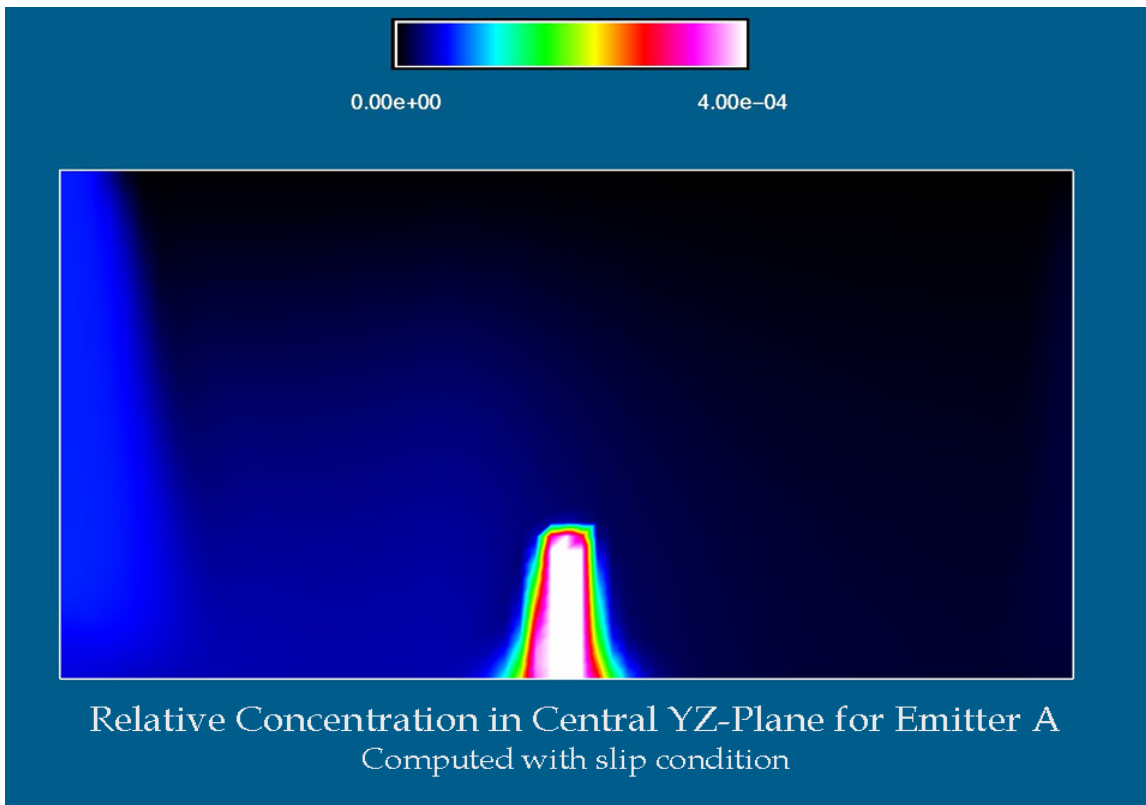

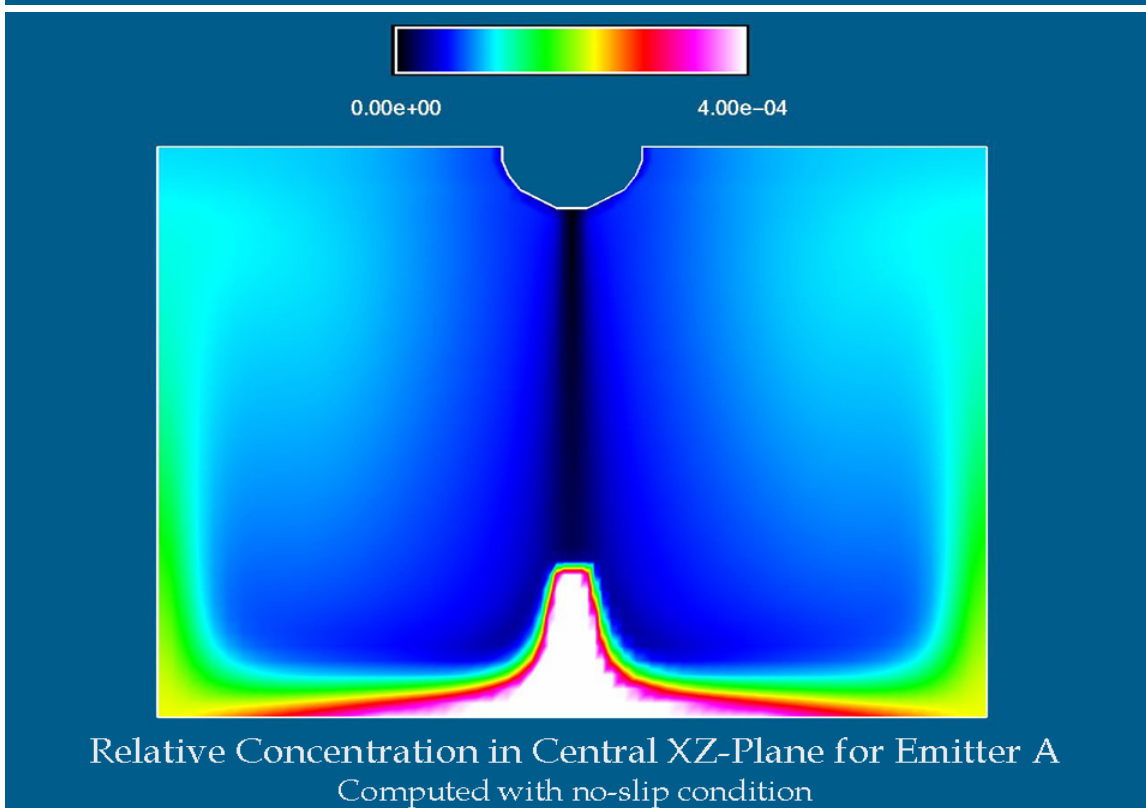
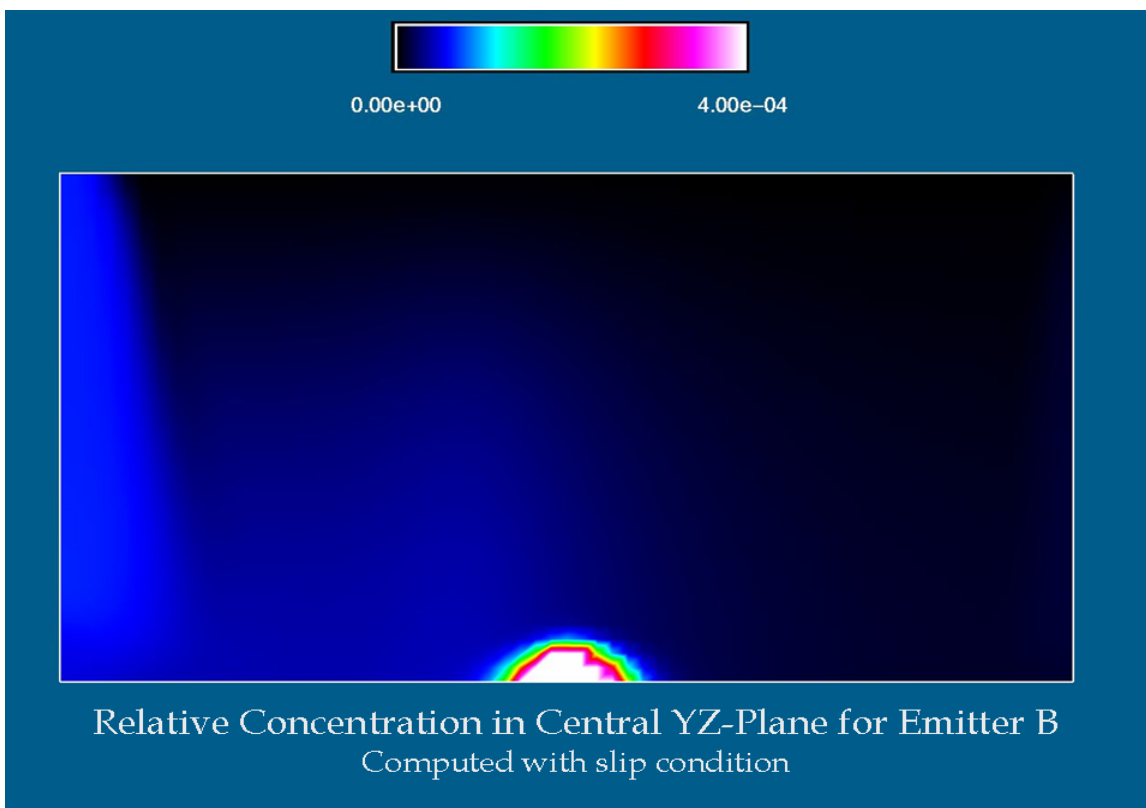

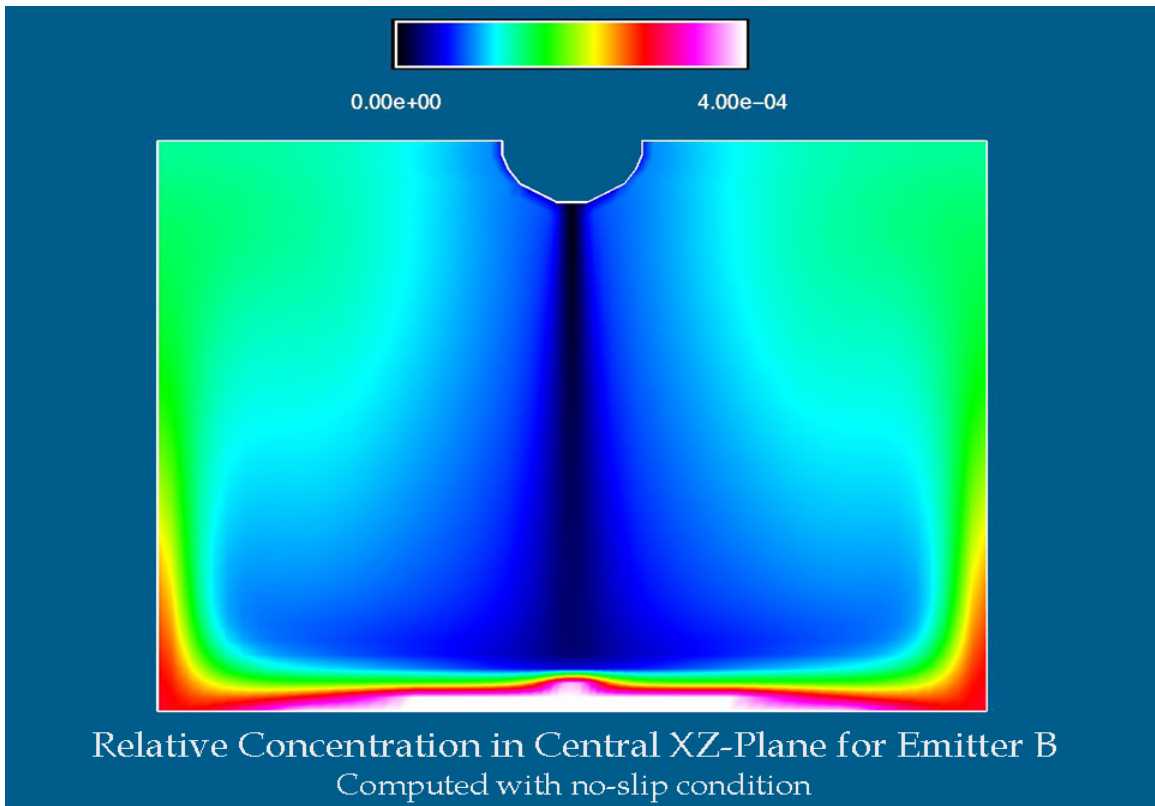
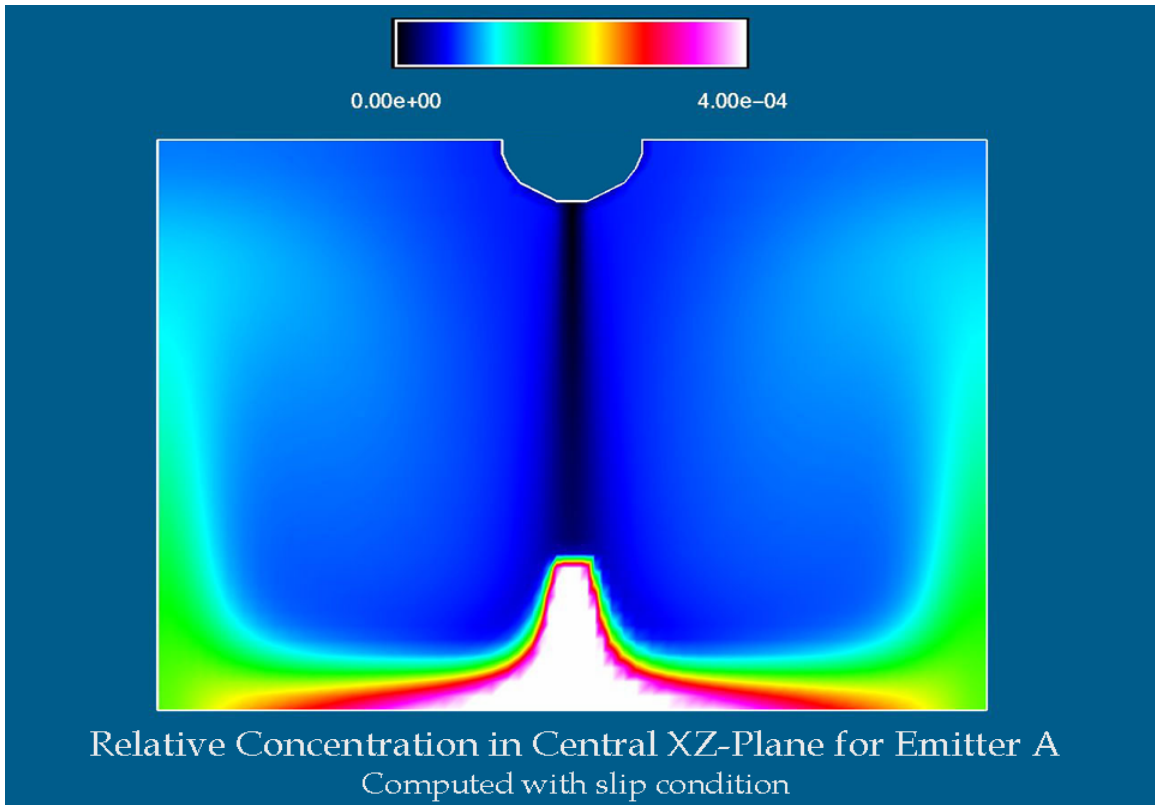

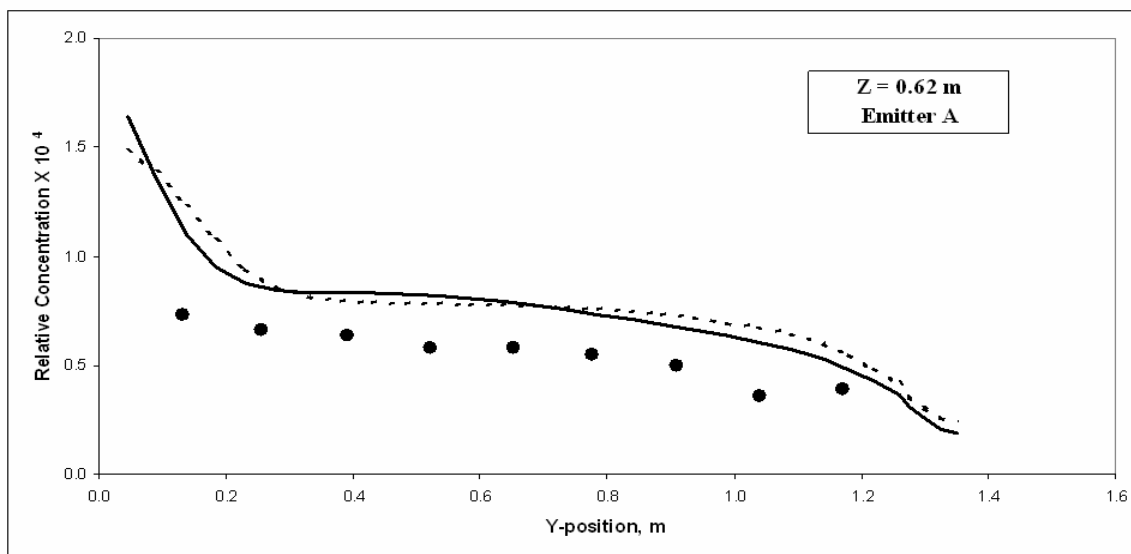
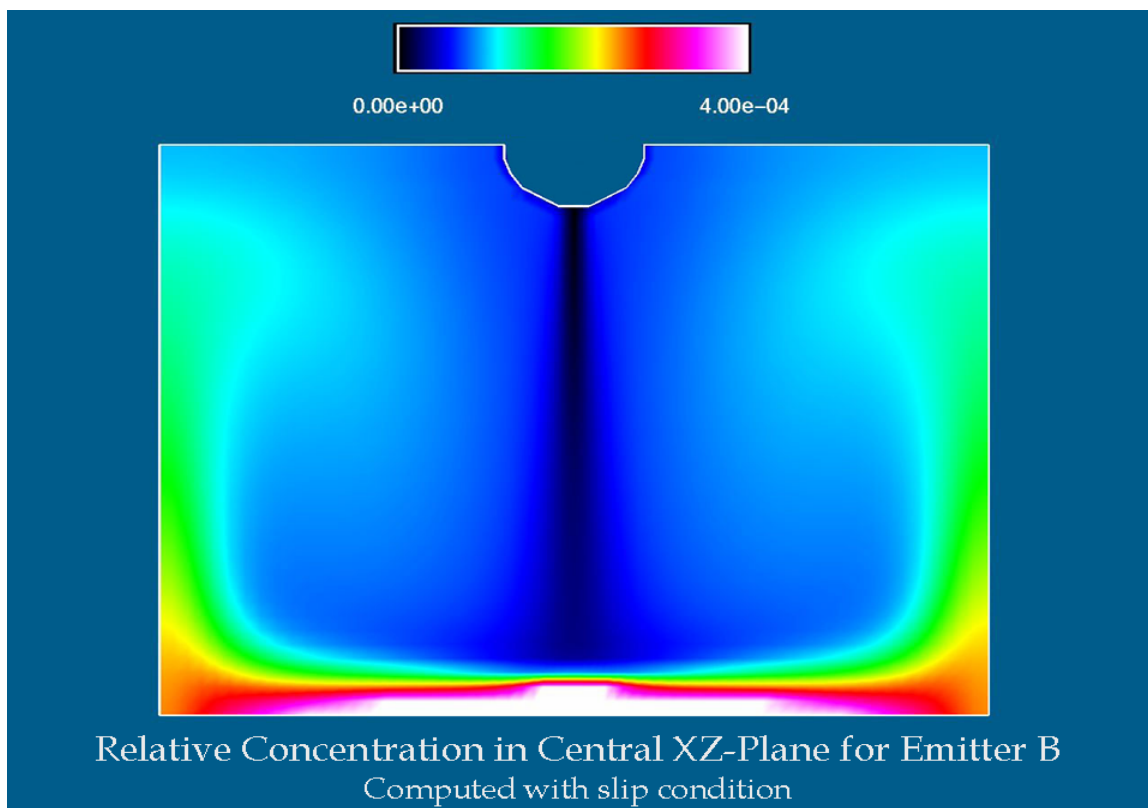

Experimental data for relative particle concentration in central xz-plane (●) compared with PAR3D predictions using slip condition (- - -) and no-slip condition (—)

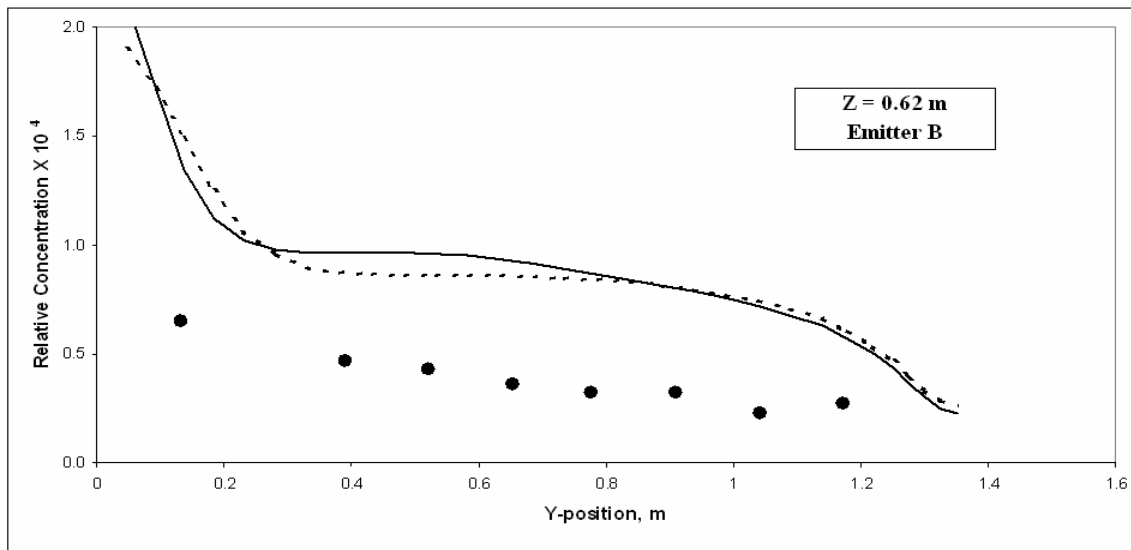

Experimental data for relative particle concentration in central xz -plane (●) compared with PAR3D predictions using slip condition (- - -) and no-slip condition (—)

4 Summary

A chronological summary of this research activity follows:

1. (1 Oct 04) Project Start
2. (19 Oct 04) TD e-mail on IPR prep “..focus on the science accomplished to obtain new knowledge and not on application of the knowledge.”
3. (28 Oct 04) BREP IPR: (Experimental validation required.)
4. (14 Jan 05) White paper produced per comments from BREP IPR
5. (28 Feb 05) 2-page Quad Charts briefing to ERDC PMB
6. (21 Mar 05) PMB de-brief
7. (12 May 05) Re-briefing to PMB (Relevant to the Army?)
8. (12 Jul 05) ERDC Direction: This project will end in FY05.
(Wrap up FY05 activities in formal report.)
9. (3 Aug 05) E-mail notice, FY06 Basic Research IPR on 13-16 Sep 05
10. (19 Aug 05) E-mail (from Dr. Cullinane), Project Wrap UP VTC
11. (17 Oct 05) Wrap Up briefing to BREP TD.

Appendix A: Experimental Measurement of Particle Re-Suspension by Airflow in a Bench-Scale Chamber: Preliminary Results

Mark Sippola

Indoor Environment Department, Lawrence Berkeley National Laboratory

Introduction

Particles that settle onto floors of indoor environments can re-suspend into the air and be transported to other locations. Particles are known to be re-suspended by human activities, but the extent to which particles may be re-suspended by airflows indoors is unclear. A set of exploratory experiments have been conducted to better understand the role that airflows may play in re-suspending particles settles on floor surfaces indoors.

Methods

Particle re-suspension by airflows was measured in a series of four experiments. The experiments investigated the re-suspension of particles in the size range 1.7-3.8 μm and 5.0-10.3 μm from floors covered with linoleum and carpet. The conditions of the experiments are summarized in Table 1.

The experiments were conducted in a 30x30x36 inch (LxWxH) chamber with two variable speed fans mounted on the interior to induce airflow within the chamber. The floor of the chamber was completely covered with either moderately textured linoleum or commercial grade olefin carpet. Please refer to the MS Word file Re-suspension – Physical description for a more detailed description of the chamber. Each experiment had four phases: pre-cleaning, deposition of particles onto floor surfaces, re-suspension of particles, and quantification of particle mass on floor samples. Please refer to the MS Word file Re-suspension – General procedure for a more detailed description of the experimental procedure.

During the particle deposition phase, the airborne particle concentration was measured with an Aerodynamic Particle Sizer (APS) (TSI, Inc., Model

3321). The APS measured airborne particle concentration in 51 size bins in the range 0.5-20 μm . Data collected by the APS were used to estimate the size distribution of particles deposited on the floor surfaces.

During the particle re-suspension phase, the airborne concentration was measured with both an APS and a filter sample. The re-suspension phase for each experiment lasted 5 hours, 1 hour with the fans off and 1 hour for each of four fan speeds (45, 75, 110 and 140). The fan speeds were incrementally increased each hour over the course of the experiment. Filters samples were collected for each hour at a given fan speed. The APS continuously collected data which was integrated over 10 minute time intervals.

Air velocities in the chamber were measured with a hotwire anemometer (Airflow TA5) for all 5 fan speeds. Measurements were made at 9 points in a plane 10 cm above the floor. The 9 measurement points were at the center points of a 9-square grid in the plane parallel to the floor. Measurements were made with the probe oriented in both the horizontal and vertical directions. The hotwire anemometer recorded a measurement about 3 times per second. It was held at each measurement location for 30 seconds and then the minimum, average and maximum air velocity in that 30 second time frame was recorded.

There are two potential weaknesses of these experiments. During the deposition phase, some particles may deposit to the walls and other surfaces within the chamber. These particles that are not deposited on the floor surface are potentially available for re-suspension. The fans lead to some vibration of the chamber when they were turned on, and the intensity of the vibration increased as the fan speed was increased. This vibration could potentially lead to particle re-suspension independent of the airflows. Further investigation will be required to understand the degree to which two these factors may have influenced the experimental results.

Results

The air velocities measured in the chamber for the 5 different fan speeds are presented in Figure 1. The values presented are the average values for the nine air velocity measurement locations. The inflow of make-up air and the outflow of sampled air to the APS and filter lead to the nonzero air velocities measured when the fans are off. The air velocities at fan speeds

of 75, 110 and 140 are similar. The fan speeds were originally selected based on the volumetric flow rates presented in Table 2.

Particle re-suspension was not observed in any experiment when the fans were off or at speed 45. In all four experiments, particle re-suspension was observed at fan speeds of 75, 110 and 140. Figure 2 shows a series of plots of airborne concentration versus particle size data collected by the APS during the re-suspension phase of Experiment 2. Each plot in the figure shows airborne particle concentration integrated over successive 10-minute intervals beginning at the point when the fans were increased from speed 45 to 75. This series of data displays trends that were also observed at higher fan speeds and during different experiments. Within a few seconds after increasing the fan speed to 75, a large increase in the airborne particle concentration was detected by the APS in the size range 1-5 μm . This concentration remained fairly constant for about 10 minutes and then began to decrease. Figures 2a through 2e show a decrease in airborne particle concentrations while the fan speed remains at 75.

Figure 3a shows the fraction of deposited particle mass that was re-suspended from the linoleum floor in 1 hour while the fans were at a speed of 75 for a range of particle sizes and Figure 3b shows the same information for the carpeted floor. The data in Figure 3a come from combining the data collected for smaller particles in Experiment 2 with data collected for larger particles in Experiment 4. The discontinuity in the data at a particle size of about 4 μm is where the two data sets meet but disagree. The data shown in Figure 3b come from small particle data collected in Experiment 1 and large particle data collected in Experiment 3.

Figures 4 and 5 show the same data as Figure 3 for fan speeds of 110 and 140, respectively. In these figures, the data for small and large particles agree and there is no strong discontinuity at the transition between the two data sets.

Table A1. Summary of experimental conditions..

Experiment # (-)	Floor surface (-)	Particle size range (μm)	Initial mass lading (ng/cm^2)
1	carpet	1-4	460
2	linoleum	1-4	160
3	carpet	5-10	5200
4	linoleum	5-10	6700

Table A2. Summary of measured variable speed fan flow rates.

Fan speed (-)	Flow rate (L/min)
45	6
75	20
110	40
140	70

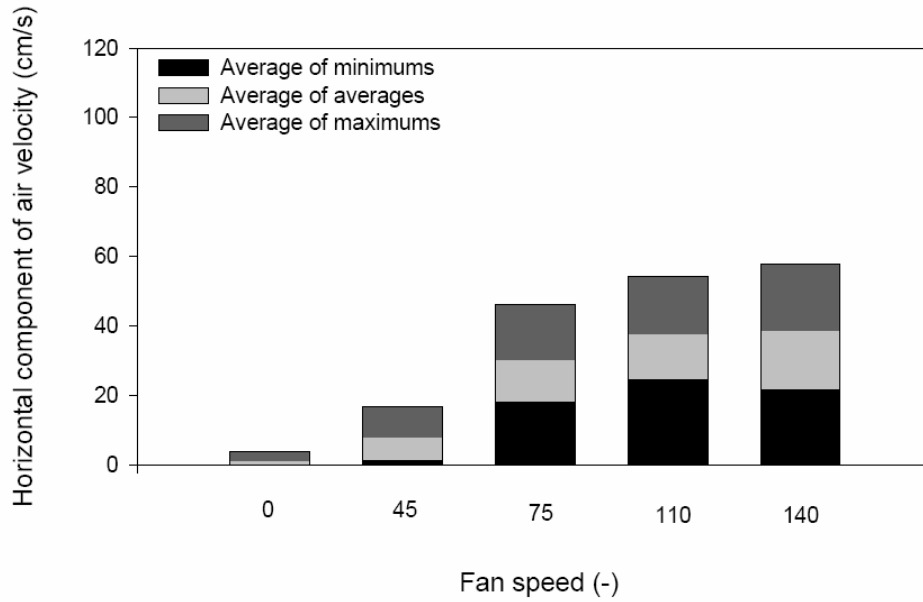

(a)

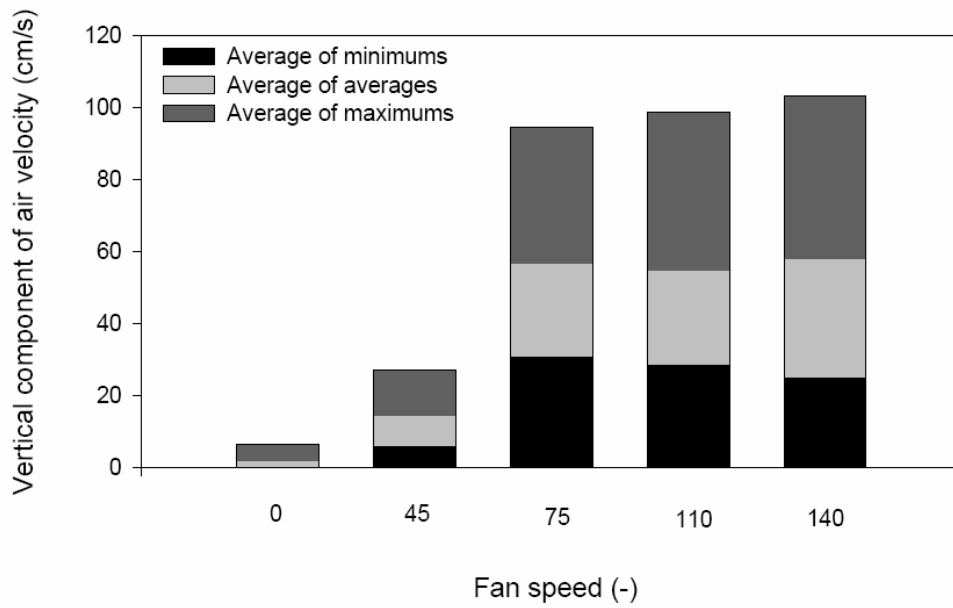

(b)

Figure A1. The average of the minimum, average and maximum air velocity in the (a) horizontal and (b) vertical direction measured at the nine measurement locations for the five different fan speeds.

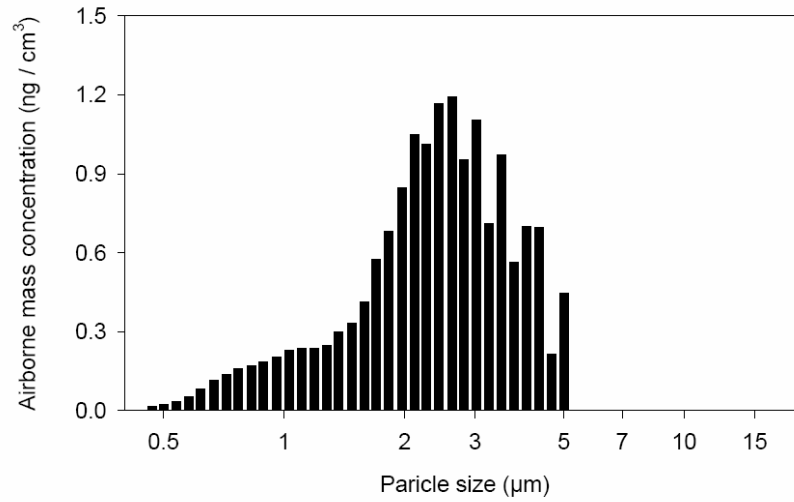

(a)

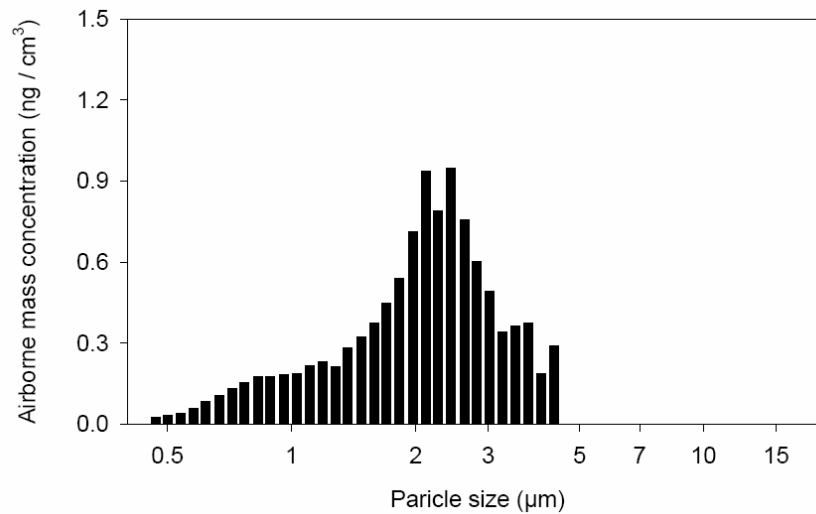

(b)

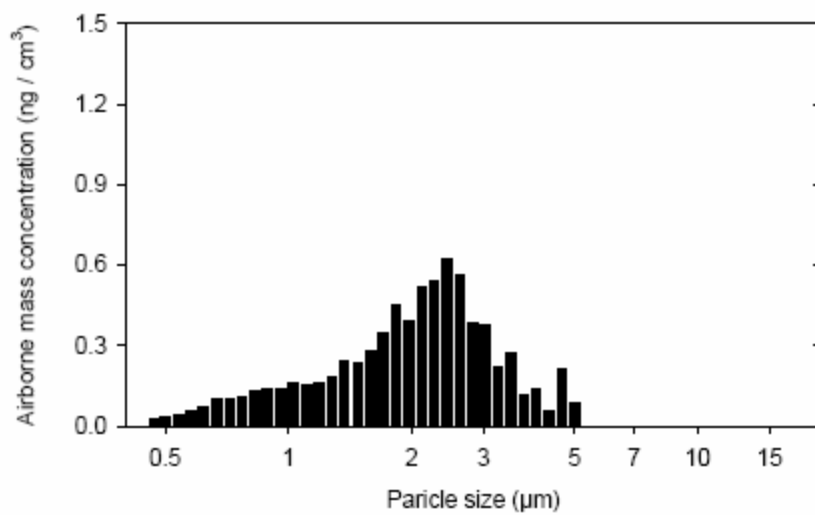

(c)

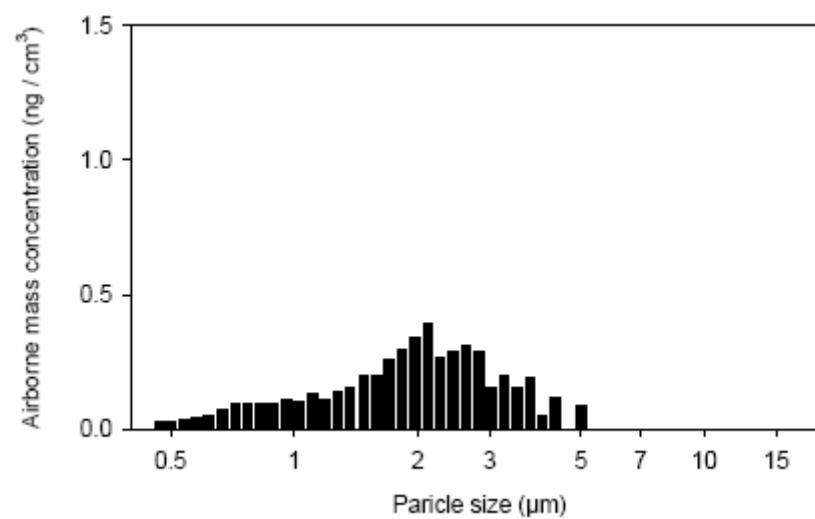

(d)

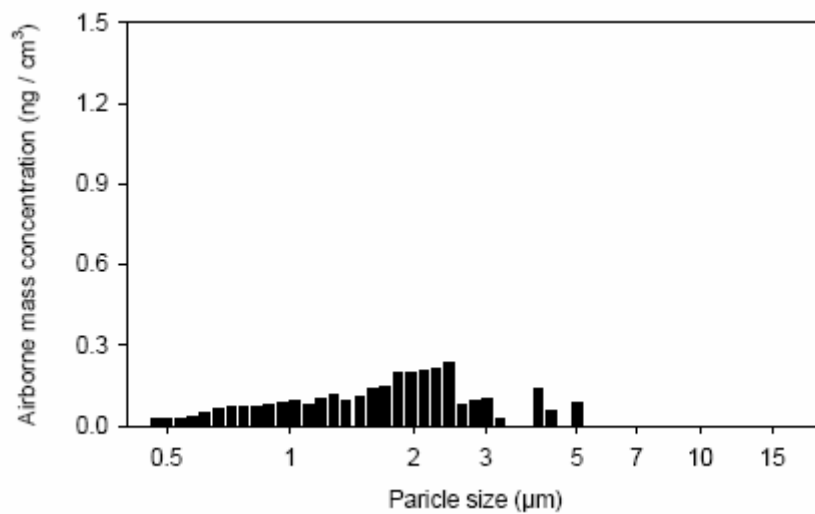

(e)

Figure A2. Airborne mass concentration of particles measured by the APS during the re-suspension phase of Experiment 2. The data are 10-minute integrated concentrations collected during the following time intervals after the fan speed was increased to 75: (a) 0-10 minutes, (b) 10-20 minutes, (c) 20-30 minutes, (d) 30-40 minutes and (e) 40-50 minutes.

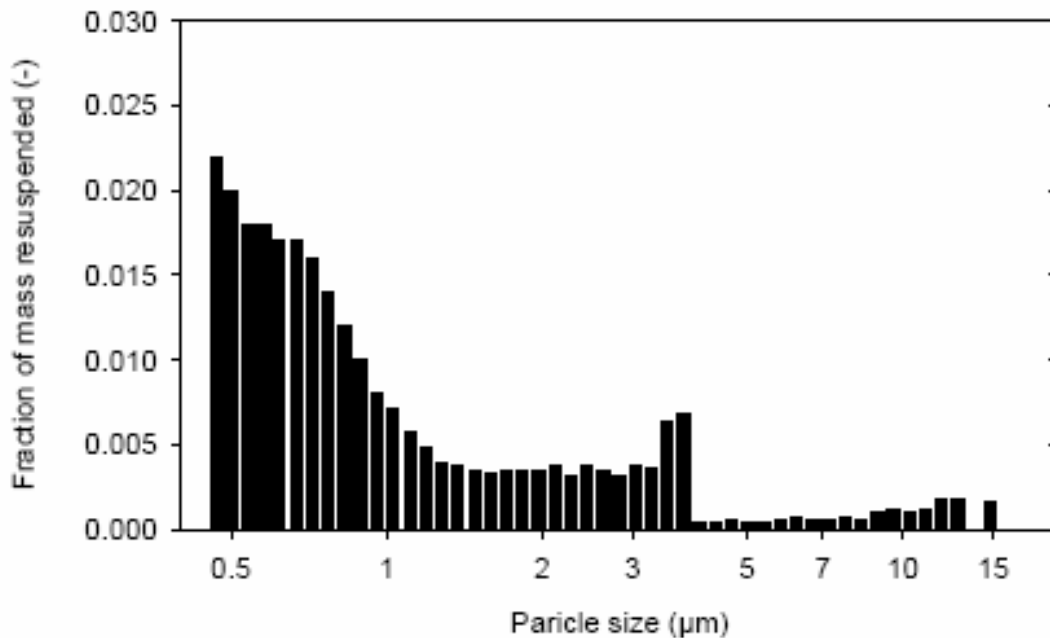

(a)

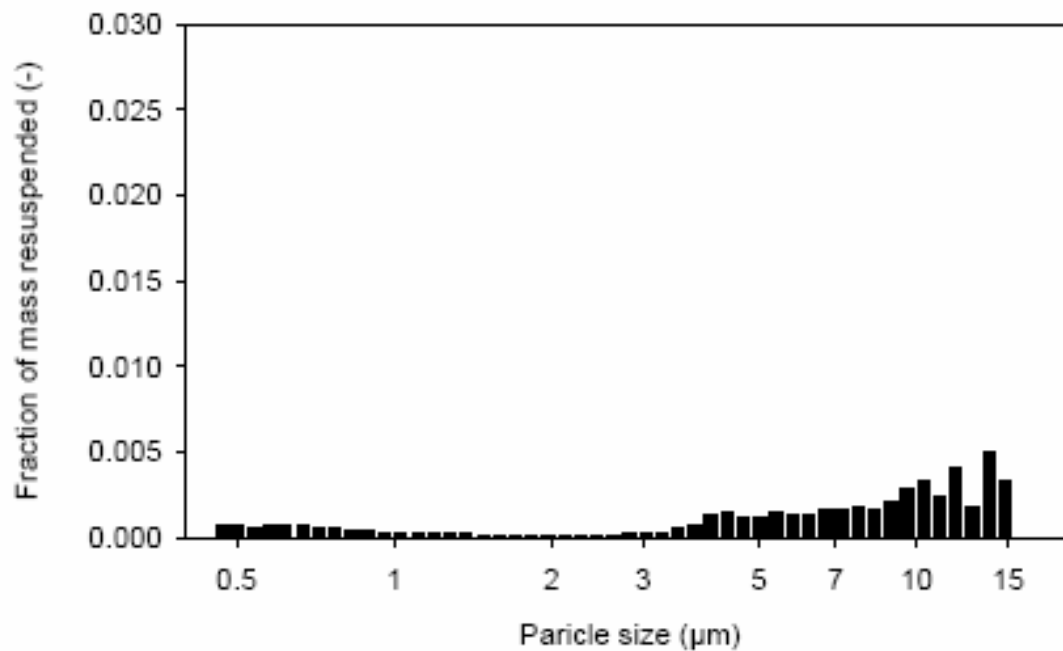

(b)

Figure A3. Fraction of deposited particle mass re-suspended from (a) linoleum and (b) carpet during 1 hour at a fan speed of 75.

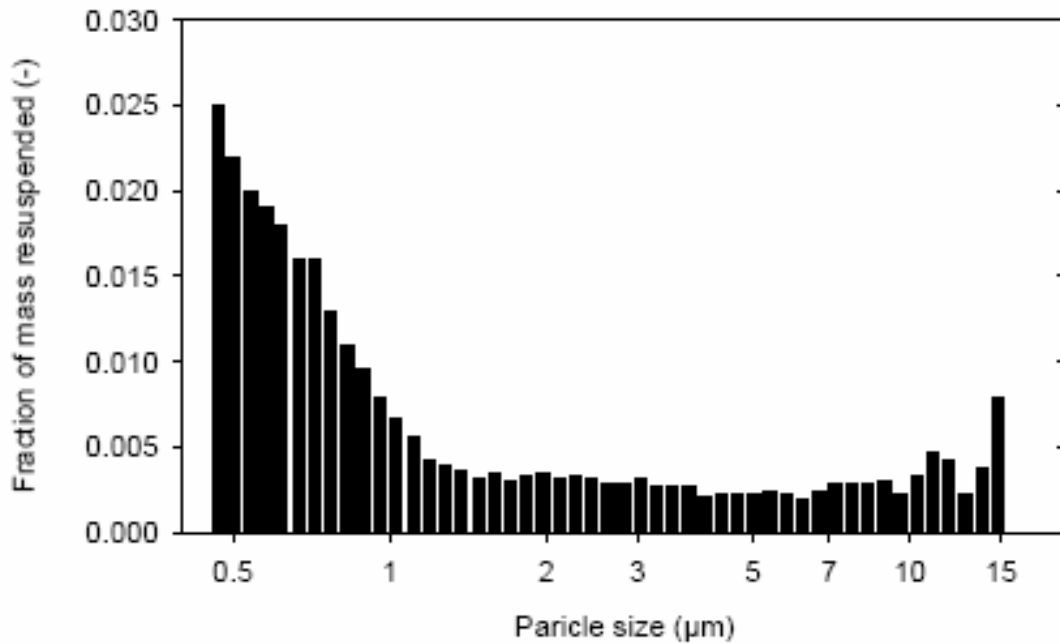

(a)

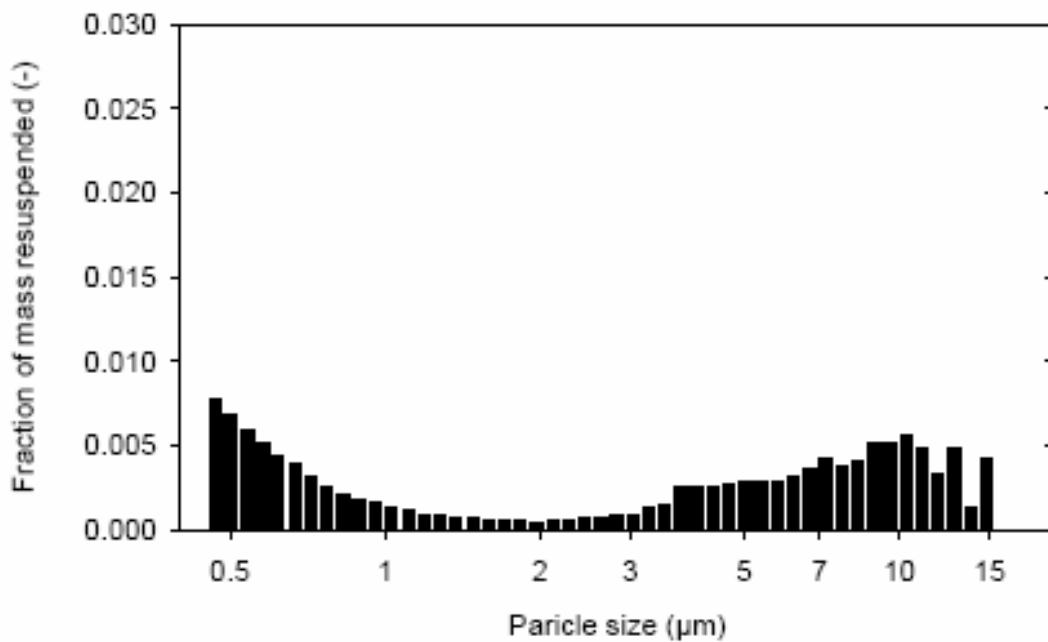

(b)

Figure A4. Fraction of deposited particle mass re-suspended from (a) linoleum and (b) carpet during 1 hour at a fan speed of 110.

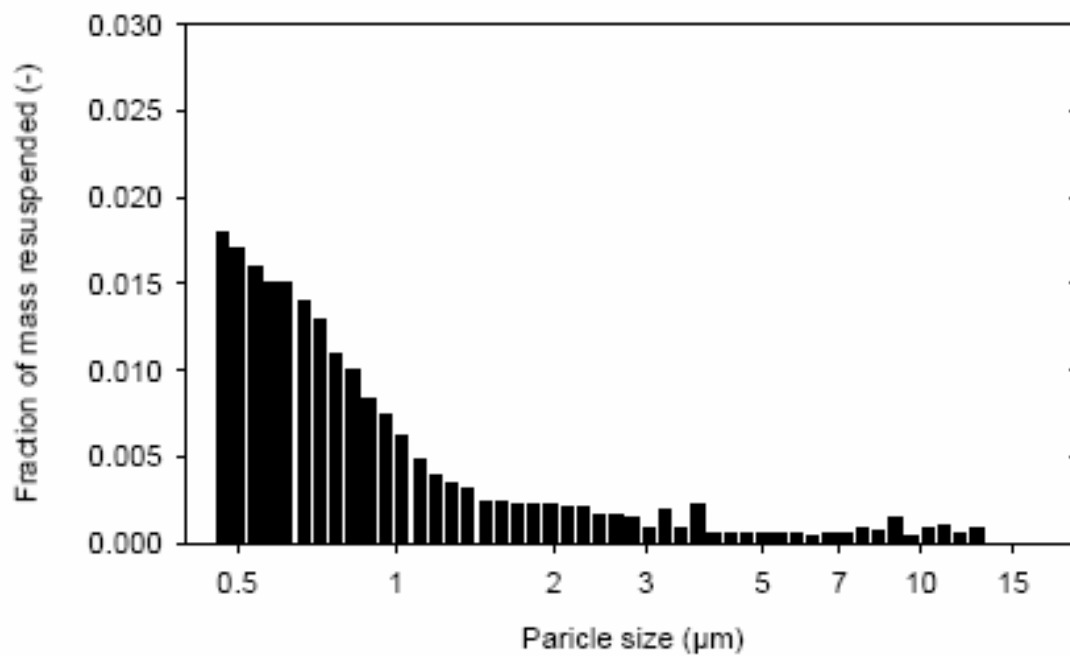

(a)

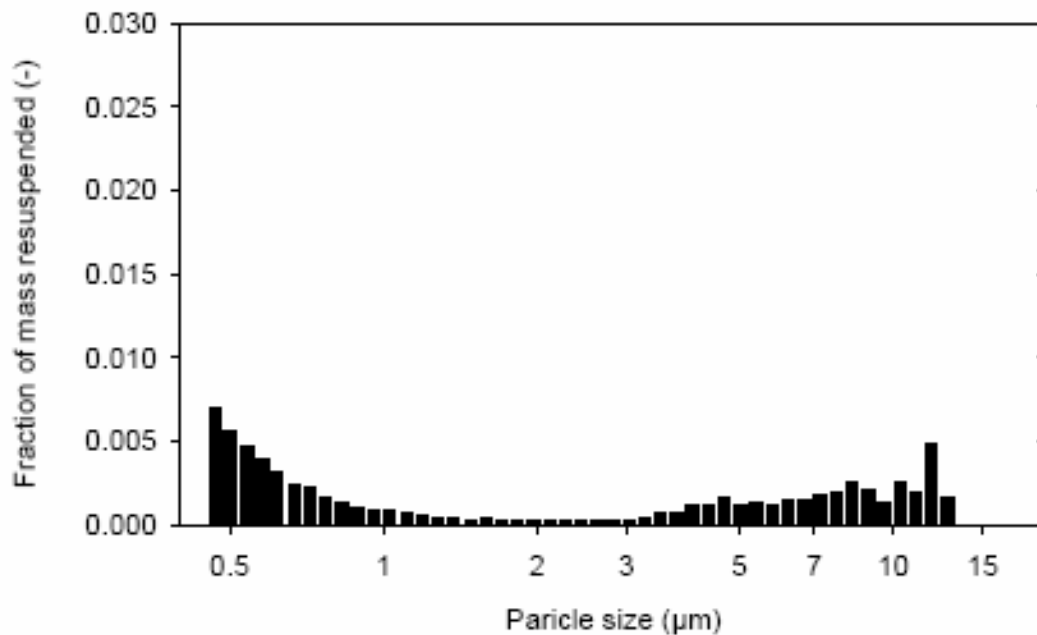

(b)

Figure A5. Fraction of deposited particle mass re-suspended from (a) linoleum and (b) carpet during 1 hour at a fan speed of 140.

