

REPORT DOCUMENTATION PAGE

Form Approved
OMB No. 0704-0188

Public reporting burden for this collection of information is estimated to average 1 hour per response, including the time for reviewing instructions, searching existing data sources, gathering and maintaining the data needed, and completing and reviewing this collection of information. Send comments regarding this burden estimate or any other aspect of this collection of information, including suggestions for reducing this burden to Department of Defense, Washington Headquarters Services, Directorate for Information Operations and Reports (0704-0188), 1215 Jefferson Davis Highway, Suite 1204, Arlington, VA 22202-4302. Respondents should be aware that notwithstanding any other provision of law, no person shall be subject to any penalty for failing to comply with a collection of information if it does not display a currently valid OMB control number. **PLEASE DO NOT RETURN YOUR FORM TO THE ABOVE ADDRESS.**

1. REPORT DATE (DD-MM-YYYY) 08-07-2001		2. REPORT TYPE Technical Paper		3. DATES COVERED (From - To)	
4. TITLE AND SUBTITLE Performance of a Linear Hall Discharge with an Open Electron Drift (Postprint)				5a. CONTRACT NUMBER	
				5b. GRANT NUMBER	
				5c. PROGRAM ELEMENT NUMBER	
6. AUTHOR(S) M.A. Cappelli, Q.E. Walker, N.B. Meezan (Stanford Univ.) and W.A. Hargus, Jr. (AFRL/PRSS)				5d. PROJECT NUMBER	
				5e. TASK NUMBER	
				5f. WORK UNIT NUMBER	
7. PERFORMING ORGANIZATION NAME(S) AND ADDRESS(ES) Air Force Research Laboratory (AFMC) AFRL/PRSS 1 Ara Road. Edwards AFB CA 93524-7013				8. PERFORMING ORGANIZATION REPORT NUMBER AIAA-2001-3503	
9. SPONSORING / MONITORING AGENCY NAME(S) AND ADDRESS(ES) Air Force Research Laboratory (AFMC) AFRL/PRSS 1 Ara Road Edwards AFB CA 93524-7013				10. SPONSOR/MONITOR'S ACRONYM(S)	
				11. SPONSOR/MONITOR'S NUMBER(S) AIAA-2001-3503	
12. DISTRIBUTION / AVAILABILITY STATEMENT Approved for public release; distribution unlimited.					
13. SUPPLEMENTARY NOTES Presented at the 37 th AIAA/ASME/SAE/ASEE Joint Propulsion Conference, Salt Lake City, UT, 8-11 July 2001. AIAA 2001-3503.					
14. ABSTRACT This paper presents a recent characterization of the thrust efficiency and specific impulse of a low power, linear-geometry (non-coaxial) Hall thruster with an open electron-drift current. The thruster was constructed with a boron-nitride insulating channel surrounded by a magnetic circuit served by four electromagnet coils, and was designed to operate in the 100-Watt power class. A survey of the thruster operation demonstrated promising performance ($T = 2.1$ mN, $\eta = 14.6\%$, $I_{sp} = 1070$ sec) in the very low power range (< 80 W). The thruster showed poor long-term stability at these operating conditions that demanded extremely high magnetic fields (~ 1.6 kG). Operation at lower magnetic field strengths ($\sim 300 - 400$ G) and therefore lower discharge power (< 50 W), allowed for continuous operation for extended durations, and permitted laser-induced fluorescence measurements of the ion velocities across and downstream of the linear exit channel. Velocities in excess of 3 km/s were measured at the discharge exit, and 8 km/s approximately 1.5 cm downstream of the discharge exit plane, consistent with measurements reported on for a similar co-axial discharge. The near exit-plane velocities were found to be somewhat sensitive to the xenon mass flow servicing the oversized hollow cathode, confirming the possible interferences that the cathode flow may have on the ion beam development in the near exit region as a result of possible charge-exchange collisions.					
15. SUBJECT TERMS					
16. SECURITY CLASSIFICATION OF:			17. LIMITATION OF ABSTRACT	18. NUMBER OF PAGES	19a. NAME OF RESPONSIBLE PERSON Dr. William A. Hargus, Jr.
a. REPORT	b. ABSTRACT	c. THIS PAGE			
Unclassified	Unclassified	Unclassified	SAR	7	19b. TELEPHONE NUMBER (include area code) N/A



A01-34237

AIAA 2001-3503

Performance of a Linear Hall Discharge
with an Open Electron Drift

M. A. Cappelli, Q.E. Walker, and N.B. Meezan

Mechanical Engineering Department
Stanford University
Stanford, CA

**37th AIAA/ASME/SAE/ASEE
Joint Propulsion Conference and Exhibit
8-11 July 2001
Salt Lake City, Utah**

Performance of a Linear Hall Discharge with an Open Electron Drift

M.A. Cappelli[†], Q.E. Walker[‡], N.B. Meezan[‡]

Mechanical Engineering Department, Stanford University, Stanford, California

W.A. Hargus, Jr.[¶]

Air Force Research Laboratory, Edwards Air Force Base, California

This paper presents a recent characterization of the thrust efficiency and specific impulse of a low power, linear-geometry (non-coaxial) Hall thruster with an open electron-drift current. The thruster was constructed with a boron-nitride insulating channel surrounded by a magnetic circuit served by four electromagnet coils, and was designed to operate in the 100-Watt power class. A survey of the thruster operation demonstrated promising performance ($T = 2.1$ mN, $\eta = 14.6\%$, $I_{sp} = 1070$ sec) in the very low power range (< 80 W). The thruster showed poor long-term stability at these operating conditions that demanded extremely high magnetic fields (~ 1.6 kG). Operation at lower magnetic field strengths ($\sim 300 - 400$ G) and therefore lower discharge power (< 50 W), allowed for continuous operation for extended durations, and permitted laser-induced fluorescence measurements of the ion velocities across and downstream of the linear exit channel. Velocities in excess of 3 km/s were measured at the discharge exit, and 8 km/s approximately 1.5 cm downstream of the discharge exit plane, consistent with measurements reported on for a similar co-axial discharge. The near exit-plane velocities were found to be somewhat sensitive to the xenon mass flow servicing the oversized hollow cathode, confirming the possible interferences that the cathode flow may have on the ion beam development in the near exit region as a result of possible charge-exchange collisions.

I. INTRODUCTION

Hall thrusters have been considered for use in satellite propulsion in the U.S. and former Soviet Union since the 1960's [1,2]. In a Hall thruster discharge, a low-pressure discharge is sustained within a dielectric channel in crossed electric and magnetic fields. Electrons emitted from a cathode external to the channel, or created by the ionization processes, drift along the channel towards the anode located at the channel base. The anode also serves as the source of neutral propellant (typically xenon). The transverse magnetic field is designed to be a maximum near the channel exit, and in this region, the electrons become highly magnetized. In the conventional co-axial configuration, the electrons are constrained to move in the azimuthal direction of the closed $\mathbf{E} \times \mathbf{B}$ drift, with cross-field migration providing the necessary electron current to sustain the discharge. A co-axial geometry allows for a "closed" electron drift in the Hall direction, and uninterrupted Hall current although there is no evidence that such a closed electron drift current is an absolute requirement for efficient thruster performance.

In this paper, we present a continued study of the performance of a low-power *linear-geometry Hall thruster* that has an open electron drift [3-5]. The linear thruster was scaled in size to operate at a power level that is 10-15% that of co-axial discharges built and tested in our laboratory in previous years [6,7]. In previous reports

[4,5], we compared the electrical discharge characteristics to those of co-axial thrusters. Here, we present recent measurements of thrust, specific impulse, and thrust efficiency, as well as preliminary laser induced fluorescence (LIF) measurements of ion velocities in the near exit-plane region.

II. EXPERIMENTS

A. Vacuum Test Facilities

The thrust measurements were made while the linear Hall thruster was operated in Chamber 2 of the AFRL Electric Propulsion Laboratory located at Edwards AFB, CA. Chamber 2 consists of a 2.4 meter diameter by 3 meter long mild steel chamber. The chamber is pumped by two baffled 50 cm oil diffusion pumps with a total pumping speed of approximately 3,000 l/s on xenon and a base pressure less than 10^{-6} Torr. The propellant flow system consisted of two Unit Instruments Model 8160 mass flow controllers. After the performance testing, the mass flow controllers were calibrated in the laboratory using a constant pressure fluid displacement method. The uncertainty of these measurements is believed to be less than $\pm 1.5\%$.

The laser induced fluorescence measurements were made while the discharge operated in the Stanford high vacuum test facility, which has been discussed extensively elsewhere [8,9]. It consists of a non-magnetic

[†] Associate Professor, Member AIAA

[‡] Graduate Research Assistant, Student Member AIAA

[¶] Member AIAA

stainless steel tank approximately 1 m in diameter and 1.5 m in length. The Stanford facility is pumped by two 50-cm diffusion pumps, backed by a 425 l/s mechanical pump. The base pressure of the facility is approximately 10^{-6} Torr as measured by an ionization gauge uncorrected for mass species. Thruster testing at xenon flow rates of 2-5 sccm results in chamber background pressures in the region of 4×10^{-5} Torr. This indicates that the facility has a xenon gas pumping speed of around 2000 ℓ/s . At the Stanford facility, the propellant flow to the thruster anode and cathode is controlled by two Unit Instruments 1200 series mass flow controllers factory calibrated for xenon.

B. Linear Hall Discharge

The design of the linear Hall thruster studied here is based on the scaling of a co-axial reference thruster recently built by our laboratory and operated at a nominal power of 400-700W [6,7]. A scaling factor of $\zeta=0.1$ was used in accordance with the scaling laws presented in Refs. 4 and 5, although the performance of the magnetic circuit precluded the use of a channel depth that was one-tenth the depth of the reference coaxial discharge. The channel depth deviated from strict scaling laws in order to reduce the magnetic field strength at the anode, and hence the anode fall losses. A schematic of the linear-geometry thruster is shown in Fig.1, and a photograph of the thruster outside of the vacuum chamber is shown in Fig.2.

The magnetic circuit includes four 90-mm long electromagnet windings consisting of a 9.5 mm diameter core of commercially pure iron with 6 layers of 22 gauge

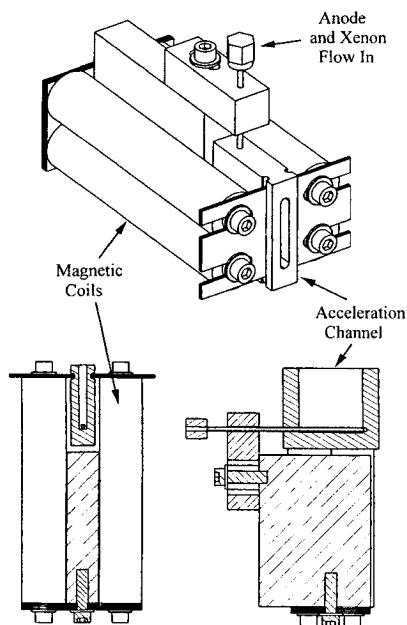

FIG. 1. Schematic of the linear-geometry open electron-drift Hall thruster.

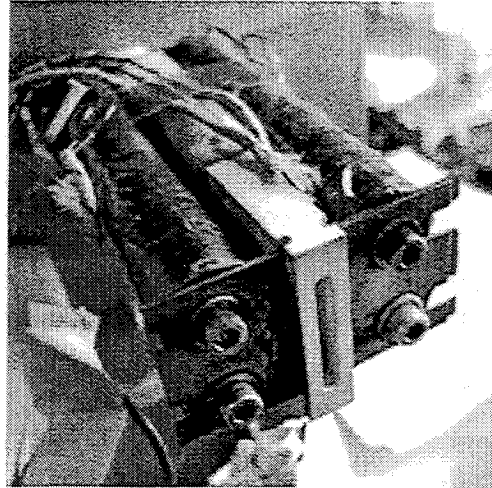

FIG. 2. Photograph of the linear-geometry open electron-drift Hall thruster.

insulated copper magnet wire. The magnetic bottom plate is 3-mm thick silicon steel, whereas the magnetic top plate is 1.5-mm thick silicon steel. The discharge channel was fabricated in two versions, one constructed of high purity alumina ceramic and the other of boron nitride. The anode is a 1.6-mm diameter stainless steel tube with 14 propellant holes, 0.2-mm in diameter spaced by 1.6-mm.

Measurements of the transverse component of the magnetic field show that the magnetic field near the anode is 23% of the peak value, which is located about 2 mm upstream of the channel exit. At a winding current of 1.25 A, the field has a peak value of 1500 G at room temperature but drops to less than 1400 G with a 100°C temperature rise. This is significant in that the temperature of the acceleration channel has been measured to be as high as 440° C by embedded thermocouples during operation in the thruster fabricated out of boron nitride [5].

The cathode used to neutralize the ion beam and support the necessary electric field is an Ion Tech. Inc. HCN-252 hollow cathode. It is capable of supplying a maximum current of 5A at xenon flow rates of 0.1 to 0.5 mg/s. It is mounted in front of the thruster such that the hollow cathode exit is 1 cm above the exit of the channel. The cathode is the exact same unit used in the higher power thrusters, and the flow rate used here is comparable to the flow rate through the thruster itself (2 sccm). We expect that the near exit plane xenon density due to the cathode flow will have a negative effect on the discharge performance. However, because the neutral gas density in this low power discharge is about a factor of 5-10 times that in the higher power prototype, the effect is expected to be no greater here than in the higher power version. No attempt at designing and fabricating an appropriately-scaled cathode has been made, although the future

development of low-power (<50W) Hall thrusters will rely on such a development.

The background pressure during discharge operation at a xenon flow rate of 2.3 mg/s is typically 10^{-4} Torr. Although this pressure is an order of magnitude lower than that of Janes and Lowder [1], it is still considerably higher than chamber pressures that are generally acceptable for the collection of accelerator performance data. The ingestion of background gas near the exit of the discharge channel may influence the discharge characteristics, as discussed below.

B. Thrust Measurements

The thrust stand used in these measurements has been described elsewhere [10]. It consists of a torsional-type thrust stand originally designed to measure the impulse bits of Pulsed Plasma Thrusters (PPT). It consists of swinging arm structure free to rotate about the vertical axis. The thruster is mounted on the arm, at a given radial distance from the center of rotation. The thrust axis is therefore tangent to the rotary motion of the arm. The rotary motion is opposed by a linear torsional restoring force. For measurements of constant thrust devices, the thrust is proportional to the rotary displacement. In this case, the displacement is measured by use of an LVDT. Calibration of the thrust stand was accomplished by hanging various weights of known mass from the rotary arm at the thruster location. During each of the thruster performance measurements, thrust stand thermal drift was minimized by performing a calibration immediately before and after each measurement.

C. Preliminary LIF Measurements

A complete description of the theory and experimental setup for laser-induced fluorescence is given in Refs. 8,9. Xenon ions (singly charged) were probed via the $5d[4]_{7/2} - 6p[3]_{5/2}$ ion transition at 834.7 nm. This transition was chosen for this study based on our previous experience with ion velocity measurements with Hall thrusters [8,9]. Since the isotopic and nuclear spin splitting constants of this transition are not fully known, the ion temperature cannot be measured accurately, and so no attempt is made here, to extract the random thermal energy component of the LIF signal. An advantage of

using this particular transition for LIF velocimetry is the ability to perform nonresonant fluorescence collection. The strong line at 541.9 nm that originates from the same upper state but terminates on a different lower electronic state, is used to collect the laser-induced fluorescence. A Coherent 899-21 Ti: Sapphire Ring laser pumped by a Coherent Verdi 5-W Nd: YAG produces narrowband tunable laser radiation centered at 834.7 nm. The laser wavelength is monitored with a Burleigh Instruments WA-1000 scanning Michelson interferometer wavemeter. The laser probe beam is focused into the plume of the linear Hall thruster, and the fluorescence is collected at a right angle to the excitation. The collected light is imaged onto the entrance slit of a monochromator, which is used as a narrow band filter for the 541.9 nm transition. The only difference between this experimental strategy employed here and that described in Ref. 9 is the scan time needed to collect the LIF signal with a reasonable signal to noise ratio. The LIF signal is much stronger with the linear thruster (owing to the expected higher species densities [4]) and as a result, a shorter integration time and scan time is needed to capture the lineshape. However, because of the strong oscillator strengths of this transition, it was difficult to obtain lineshapes that are not broadened due to partial saturation of the transition. These partially saturated lineshapes are not problematic for measuring velocity, but further prohibit the accurate determination of the ion temperature.

III. RESULTS AND ANALYSIS

A. Performance Characterization

Tests were performed at the AFRL for a range of mass flow rates, discharge voltage, and magnetic fields, as summarized in Table 1 below. In general, thrust efficiencies (cathode not considered), varied from 7 – 14%, which is quite respectable for a discharge power in the 75-200 W range, considering that this is a first prototype and not optimized yet for performance. Efficiencies seem to improve slightly for increased magnetic field (all other parameters constant), but decreased when mass flow to the anode was increased (at a constant voltage and magnetic field), as expected. The variation in the thrust, specific impulse, and thrust (anode) efficiency is plotted versus the overall variation in

Anode Flow Rate (mg/s)	Discharge Voltage (V)	Discharge Current (A)	Discharge Power (W)	Peak Magnetic Field (Gauss)	Thrust (mN)	I_{sp} (s)	Anode Efficiency (%)
0.41	151	0.83	125	1200	2.7	682	7.3
0.41	150	0.98	147	1570	3.3	824	9.1
0.3	150	0.66	99	1600	2.3	778	8.9
0.2	150	0.51	76.5	1600	2.1	1070	14.6
0.41	152	0.77	117	1800	3.1	770	10.0
0.41	202	0.93	188	1800	3.7	934	9.1

Table I. Discharge Operating Conditions

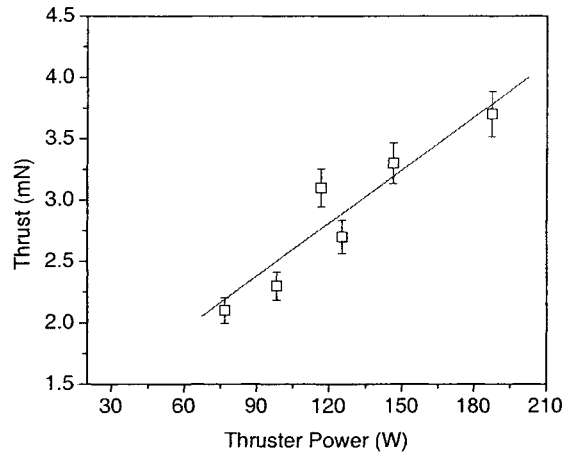

FIG. 3. Thrust performance over range of discharge power.

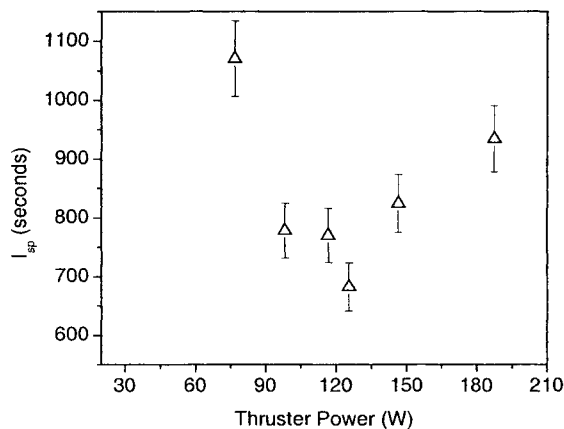

FIG. 4. Specific Impulse over range of discharge power.

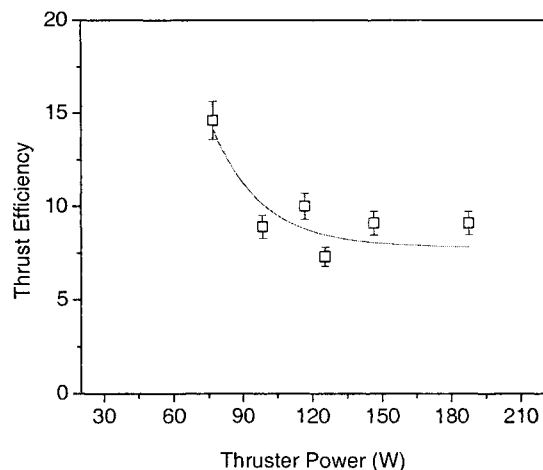

FIG. 5. Thrust efficiency over range of discharge power.

The highest efficiency realized was 14%, obtained for the lowest overall discharge power studied (76W). At this operating condition, the mass flow rate through the anode was at the lowest range studied, suggesting that the propellant utilization was at its highest level. The specific impulse achieved at this operating condition was nearly 1100 s, comparable to that seen in co-axial geometry thrusters, while at a modest operating voltage of only 150V. Despite the preliminary nature of these design and performance studies, the initial results obtained are quite encouraging, and warrant further research into these new types of Hall discharges.

B. Ion Velocity Measurements

As mentioned above, because of the relatively long integration times needed for the LIF studies, it was necessary to operate the discharge at lower magnetic field strengths for extended duration, to avoid heating of the magnetic circuit. It was observed that operating the discharge at the higher solenoid winding current (>0.25A) for extended duration needed for the LIF studies eventually led to discharge extinction, likely to be caused by a failure in the solenoid winding insulation. A new discharge with improved magnetic circuit design has been constructed and operated for extended time, but performance results were not yet available at the time of the preparation of this paper. The results of operating this second-generation linear Hall discharge will be presented at the conference.

The laser fluorescence velocimetry studies were performed at conditions given in Table II, below. Fig. 6 shows the ion velocity profile at the exit plane for conditions where the only property changed is the mass flow through the oversized cathode. Note that these data were taken along the centerline of the 25 mm long channel. While the velocities are comparable to those measured at the exit plane of a coaxial Hall thruster [8], it is noteworthy that the LIF probing of the exit plane clearly shows that the cathode flow has a significant effect on the performance – a higher cathode flow rate results in a higher discharge current, most likely due to an increase in electron conductivity across the magnetic field. While this results in a higher overall discharge power, the LIF measurements show that the ion velocity is in fact reduced. This reduction in ion velocity, presumably due to an altering of the potential distribution within the channel, will result in an overall decreased specific impulse. It is also noteworthy that both profiles show indicate that the ion velocities are higher near the top of the channel where the cathode is located.

Fig. 7 plots the variation in the ion velocity with downstream position. The measurements were taken at the midpoint of the channel, and the cathode plane (location of the cathode jet) is approximately 1 cm downstream from the thruster exit plane. As we reported first for coaxial geometry Hall thrusters, this linear

Cathode	Anode	Anode Voltage	Anode Current	Magnetic Field
0.3 mg/s	0.2 mg/s	100 V	0.45 - 0.40 A	300 G
0.1 mg/s	0.2 mg/s	100 V	0.21 - 0.17 A	300 G

Table II. Linear Hall thruster operating conditions for the laser induced fluorescence velocimetry studies.

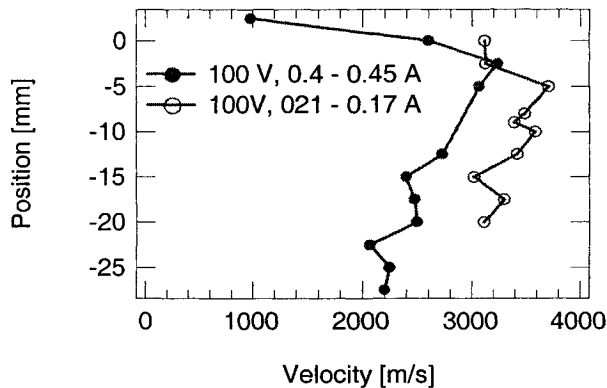

FIG. 6. Linear Hall Thruster Axial Exit Velocities at different operating conditions.

geometry Hall thruster also shows evidence of acceleration well beyond the exit of the discharge channel, and also beyond the geometric position of the cathode itself.

IV. SUMMARY

This paper presents a continued study of the operation characteristics and performance of a linear-geometry Hall thruster with an open electron drift.

- [1] G. S. Janes and R. S. Lowder, *Phys Fluids* **9**, 1115 (1966).
- [2] A. I. Morozov *et al.*, *Zh. Tekh. Fiz.* **42**, 612 (1972). [*Sov. Phys. Tech. Phys.* **17**, 482 (1972)].
- [3] W.A. Hargus and M.A. Cappelli, "Development of a Linear Hall Thruster," AIAA-98-3336, 34th Joint Propulsion Conference, Cleveland, OH, July, 1998.
- [4] M.A. Cappelli, D. Schmidt, N. B. Meezan, and W.A. Hargus Jr., "Continued Development of a Linear Hall Thruster," AIAA-99-2569, 35th Joint Propulsion Conference, Los Angeles, CA, June 20-24, 1999.
- [5] D.P. Schmidt, N.B. Meezan, W.A. Hargus, Jr., and M.A. Cappelli, "A Low-Power, Linear-Geometry Hall Plasma Source with an Open Electron-Drift," *Plasma Sources Sci. Technol.* **9**, 68-76, 2000.
- [6] R.J. Cedolin, W.A. Hargus, Jr., R.K. Hanson, and M.A. Cappelli, "Laser-Induced Fluorescence Study of a Xenon

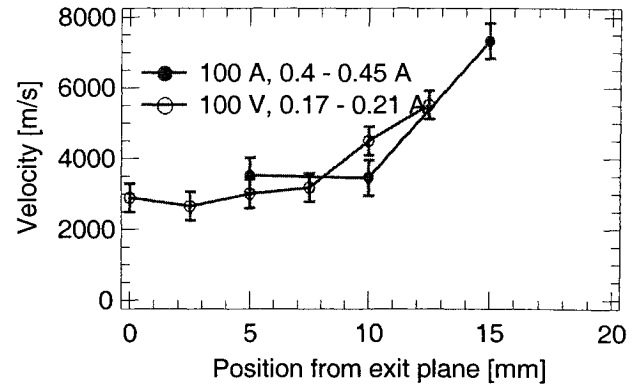

FIG. 7. Axial variation in the axial component of ion velocity.

Measurements of thrust, specific impulse, and thrust efficiencies, while lower than higher power coaxial geometry thrusters, are well within the level of performance expected for a first prototype thruster of such low power and small scales. An unusually high efficiency (14%) is achieved at powers as low as about 75W, resulting in a specific impulse approaching 1100s. This level of performance was not expected for such unusual discharge geometry, suggesting that this thruster is governed by the same physics as its coaxial counterpart. Measurements of ion velocities in the near exit region indicate that the ions are accelerated

ACKNOWLEDGEMENTS

This work was supported by the Air Force Office of Scientific Research. N. Meezan was supported by a National Defense Science and Engineering Graduate (NDSEG) fellowship. The authors wish to thank G. Spanjers for access to the facilities at the Air Force Research Laboratory to carry out the thrust measurements.

- [7] W.A. Hargus and M.A. Cappelli, "Laser Induced Fluorescence Measurements on a Laboratory Hall Thruster," AIAA-98-3645, 34th Joint Propulsion Conference, Cleveland, OH, July, 1998.
- [8] R.J. Cedolin, W.A. Hargus, Jr., P.V. Storm, R.K. Hanson, and M.A. Cappelli, *Applied Physics B - Lasers and Optics*, **65**, 459-469, 1997d
- [9] W.A. Hargus and M.A. Cappelli, "Laser Induced Fluorescence Measurements within a Laboratory Hall Thruster, AIAA 99-3436, 30th AIAA Plasmadynamics and Lasers Conference, Norfolk, VA, June 28-July 1, 1999.
- [10] T.W. Haag, "PPT Thrust Stand," AIAA-95-2917, 31st AIAA Joint Propulsion Conference, San Diego, July 10-12, 1995.