

DESIGN OF THE PRECISE TIME FACILITY FOR GALILEO

S. Bedrick¹, A. Bauch², A. Moudrak³, and W. Schäfer⁴

¹Kayser-Threde GmbH, Wolfratshauer Str. 48, 81379 Munich, Germany

E-mail: spacotech@kayser-threde.de

Phone: +49-89-72495-231, Fax: +49-89-72495-104

²Physikalisch-Technische Bundesanstalt (PTB), Braunschweig, Germany

³Deutsches Zentrum für Luft- und Raumfahrt (DLR),
Oberpfaffenhofen, Germany

⁴TimeTech GmbH, Stuttgart, Germany

Abstract

Under contract to the European Space Agency (ESA), an expert team lead by Kayser-Threde GmbH has elaborated a design concept for the Precise Time Facility (PTF) for Europe's satellite positioning system Galileo. The major purpose of the PTF is to generate, maintain, and distribute Galileo System Time (GST). The PTF is represented by an ensemble of atomic clocks (active H-maser, cesium) with appropriate measurement equipment and time algorithms. In addition, Two-Way Satellite Time and Frequency Transfer (TWSTFT) and GNSS Common-View (CV) equipment is included, since GST will be steered to TAI by linking the PTF master clock to selected European National Metrological Institutes (NMI). This process shall be managed by the yet to be established external Galileo Time Service Provider (GTSP).

During Galileo In-Orbit Verification (IOV), one PTF is planned to be physically implemented, whereas for Final Operational Capability (FOC) two identical and redundant PTFs at two different sites in Europe are foreseen. A preliminary PTF turn-key architecture has been proposed in 2003 by the team. This architecture has been further detailed during the 2004 Phase C0 study. The architecture is entirely based on the results of the previous Galileo system studies and the requirements derived thereof. In addition, the proposed turn-key design covers a number of features which are deemed key to successful and timely procurement, installation, and operations of the PTF during IOV and FOC.

Concerning the PTF design baseline, the redundancy mechanisms and a reliable

Report Documentation Page

Form Approved
OMB No. 0704-0188

Public reporting burden for the collection of information is estimated to average 1 hour per response, including the time for reviewing instructions, searching existing data sources, gathering and maintaining the data needed, and completing and reviewing the collection of information. Send comments regarding this burden estimate or any other aspect of this collection of information, including suggestions for reducing this burden, to Washington Headquarters Services, Directorate for Information Operations and Reports, 1215 Jefferson Davis Highway, Suite 1204, Arlington VA 22202-4302. Respondents should be aware that notwithstanding any other provision of law, no person shall be subject to a penalty for failing to comply with a collection of information if it does not display a currently valid OMB control number.

1. REPORT DATE DEC 2004		2. REPORT TYPE		3. DATES COVERED 00-00-2004 to 00-00-2004	
4. TITLE AND SUBTITLE Design of the Precise Time Facility for Galileo				5a. CONTRACT NUMBER	
				5b. GRANT NUMBER	
				5c. PROGRAM ELEMENT NUMBER	
6. AUTHOR(S)				5d. PROJECT NUMBER	
				5e. TASK NUMBER	
				5f. WORK UNIT NUMBER	
7. PERFORMING ORGANIZATION NAME(S) AND ADDRESS(ES) Kayser-Threde GmbH, Wolfratshausen Str. 48, 81379 Munich, Germany,				8. PERFORMING ORGANIZATION REPORT NUMBER	
9. SPONSORING/MONITORING AGENCY NAME(S) AND ADDRESS(ES)				10. SPONSOR/MONITOR'S ACRONYM(S)	
				11. SPONSOR/MONITOR'S REPORT NUMBER(S)	
12. DISTRIBUTION/AVAILABILITY STATEMENT Approved for public release; distribution unlimited					
13. SUPPLEMENTARY NOTES See also ADM001784. 36th Annual Precise Time and Time Interval (PTTI) Systems and Applications Meeting, Washington, DC on 7-9 Dec 2004					
14. ABSTRACT Under contract to the European Space Agency (ESA), an expert team lead by Kayser-Threde GmbH has elaborated a design concept for the Precise Time Facility (PTF) for Europe's satellite positioning system Galileo. The major purpose of the PTF is to generate, maintain, and distribute Galileo System Time (GST). The PTF is represented by an ensemble of atomic clocks (active H-maser, cesium) with appropriate measurement equipment and time algorithms. In addition, Two-Way Satellite Time and Frequency Transfer (TWSTFT) and GNSS Common-View (CV) equipment is included, since GST will be steered to TAI by linking the PTF master clock to selected European National Metrological Institutes (NMI). This process shall be managed by the yet to be established external Galileo Time Service Provider (GTSP). During Galileo In-Orbit Verification (IOV), one PTF is planned to be physically implemented, whereas for Final Operational Capability (FOC) two identical and redundant PTFs at two different sites in Europe are foreseen. A preliminary PTF turn-key architecture has been proposed in 2003 by the team. This architecture has been further detailed during the 2004 Phase C0 study. The architecture is entirely based on the results of the previous Galileo system studies and the requirements derived thereof. In addition, the proposed turn-key design covers a number of features which are deemed key to successful and timely procurement, installation, and operations of the PTF during IOV and FOC. Concerning the PTF design baseline, the redundancy mechanisms and a reliable connection between the PTF and the GTSP are considered to be more critical than the GST generation and steering algorithms, where valuable experience exists worldwide at the NMIs. The critical issues mainly refer to parametrization of the GST algorithm and its operational implementation (e.g. weighting of each clock in the ensemble, redundancy switching). Moreover, reliable determination of the GPS/Galileo Time Offset (GGTO), which is planned to be broadcast by both GPS and Galileo to the users, is considered to be a critical element. The paper reports about the team's PTF design concept and the latest results of the PTF algorithm prototyping activities.					
15. SUBJECT TERMS					
16. SECURITY CLASSIFICATION OF:			17. LIMITATION OF ABSTRACT	18. NUMBER OF PAGES	19a. NAME OF RESPONSIBLE PERSON
a. REPORT unclassified	b. ABSTRACT unclassified	c. THIS PAGE unclassified			

connection between the PTF and the GTSP are considered to be more critical than the GST generation and steering algorithms, where valuable experience exists worldwide at the NMIs. The critical issues mainly refer to parametrization of the GST algorithm and its operational implementation (e.g. weighting of each clock in the ensemble, redundancy switching). Moreover, reliable determination of the GPS/Galileo Time Offset (GGTO), which is planned to be broadcast by both GPS and Galileo to the users, is considered to be a critical element. The paper reports about the team's PTF design concept and the latest results of the PTF algorithm prototyping activities.

1 INTRODUCTION

Between November 2003 and August 2004, Kayser-Threde GmbH, together with its sub-contractors TimeTech GmbH, the UK National Physical Laboratory (NPL), the German Aerospace Research Centre (DLR), and the German Physikalisch-Technische Bundesanstalt (PTB), have been designing the Precise Time Facility (PTF) for Galileo during the so-called Phase C0 study. The major purpose of the PTF is to generate, maintain, and distribute Galileo System Time (GST). The PTF shall consist of an ensemble of atomic clocks with appropriate time and frequency (T&F) measurement equipment and S/W filtering algorithms. During the Galileo In-Orbit Verification (IOV) phase, characterized by a reduced number of spacecraft, one PTF is planned to be physically implemented, whereas for Galileo Final Operational Capability (FOC) two identical and synchronized PTFs at two different sites are foreseen.

A preliminary PTF turn-key architecture has been proposed in 2003 and further detailed during the Phase C0 study in 2004 by the team. The architecture is based on the results of the earlier Galileo system studies and trade-offs, in particular those of Phase B2, and the segment requirements derived thereof. In addition, our turn-key design covers a number of features that are deemed key to successful and timely procurement, installation, and operations of the PTF during IOV and FOC.

Concerning the technical PTF requirements and its present design baseline, the PTF redundancy mechanisms are considered more critical than the GST generation and steering algorithms, where valuable experience exists worldwide at National Metrological Institutes (NMI). Several outstanding critical issues refer to parametrization of the GST algorithms and their operational implementation (e.g. ensemble algorithm, redundancy switching). These issues are discussed in detail in the following chapters.

2 TECHNICAL REQUIREMENTS

The ground reference time system for Galileo which shall generate Galileo System Time (GST) has two primary functions:

1. Navigation timekeeping: this function is critical for fulfilling the navigation mission and is needed for Galileo spacecraft orbit determination and time synchronization (ODTS);
2. Metrological timekeeping: this function is uncritical to the mission, but needed to steer GST towards International Atomic Time (TAI) and to provide the UTC timing dissemination service to the user.

Navigation timekeeping is the core task of the PTF, whereas the metrological timekeeping shall be

performed by an external Galileo Time Service Provider (GTSP).

2.1 PTF REQUIREMENTS

In terms of performance requirements, the following list provides a comprehensive overview of all relevant figures as specified today.

1. GST Frequency Stability shall be optimized on short term ($\tau = 1$ day).
2. GST Time Stability shall be optimized to medium/long term ($\tau = 30$ days).
3. Based on above two requirements, the design baseline after [1] assumes 1+1 Active H-Maser clocks (AHM) for short-term timing plus 3+1 high-performance cesium (Cs) standards for long-term drift removal. This would result in a typical GST frequency stability performance as expressed in the following figure. The extra AHM and Cs clocks shall be included as hot spares. We propose 2+1 AHM, which would allow immediate isolation of any faulty AHM.

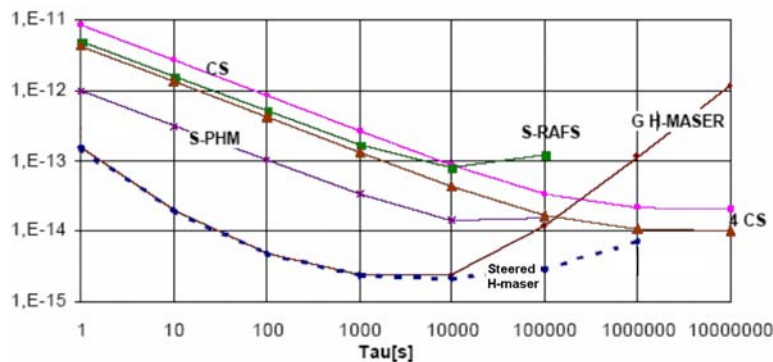

Figure 1. Specified GST time stability (dotted curve at bottom) based on clock ensemble of 1 AHM + 3 Cs (G- = ground, S- = space)

4. GST Frequency Offset (normalized to TAI): $< 5.5E-14$ (1 day)
5. GST Limits: accuracy of GST – TAI offset < 50 ns, 2σ (95% of any yearly interval)
6. GST Uncertainty: precision of GST – TAI offset < 28 ns, 2σ (95% confidence level)
7. GST Autonomy: accumulation of less than 28 ns (2σ) uncertainty over 10 days (95% conf. level)

To achieve above specified performance, a dedicated PTF environment is necessary, which basically should consist of a separate clock operations room with the following characteristics: room temperature $25 \pm 1^\circ\text{C}$, temperature slope $< 1^\circ\text{C/h}$, humidity $50 \pm 10\%$, dedicated means for magnetic shielding, air filtering and corrosion prevention, and uninterruptable power supply for at least two consecutive days.

2.2 GTSP REQUIREMENTS

The main reason to involve an external GTSP is simplification of the PTF core timekeeping system by outsourcing the metrological functions and relying on an – already existing – infrastructure. It will enable national timing labs UTC (k) and commercial providers to research and improve GST generation independently and to find the best approach for UTC dissemination via the Galileo FOC system.

This will most probably result in considerable cost savings for the PTF itself. Moreover, such shared task allocation will enable to continuously improve the timing service of Galileo without frequent changes of the core infrastructure, e.g. by involvement of new and better (external) clocks or better TAI prediction algorithms. This in turn will support the inevitable comparison with the ongoing and planned GPS modernisation initiatives in the US and will help to stabilize and promote GST in the long term. It is assumed that the challenge of an ever improved GPS time in the coming years can be faced best by such work share between PTF and GTSP and still create long-term confidence to the Galileo user in the quality and performance of the Galileo time product and services.

Based on these assumptions, all GTSP tasks are summarized in the following list:

1. install and operate two-way satellite T&F transfer (TWSTFT) and common-view (CV) equipment at the PTF, which shall be driven by the physical realization of GST
2. operate daily links to n UTC (k) labs (at least three; required for reliable determination of TAI offset) including periodic calibration of equipment as well as provision and/or leasing of external infrastructure (e.g. satellite transponder time)
3. receive GST parameters, individual clock data Ck_i and clock ensembling information from PTF
4. perform data analysis of all measurements $GST - Ck_i$ and $GST - UTC(k)$
5. develop and operate TAI_p prediction algorithm
6. provide daily predicted value of $(TAI_p - GST)$ time and frequency offset and daily frequency steering correction to PTF
7. provide current value of $UTC - TAI$ time offset (leap seconds) to PTF
8. interface with BIPM by exchange of all relevant clock data
9. support extended scientific activity.

Figure 2 summarizes the most important PTF and GTSP tasks and gives an overview of the relations between PTF and GTSP.

2.3 REQUIREMENTS FOR IOV

Concerning the requirements and the design baseline as defined in Phase B2 for Galileo IOV, [2] states that “due to the equivalent number and type of operative clocks in the PTF (i.e. 3 Cs and 1 AHM), which will be used both in FOC and IOV, the same algorithm and the same stability performances are expected both in FOC and IOV ... The following table summarizes the functions that can be tested during IOV and the level of verification achievable.”

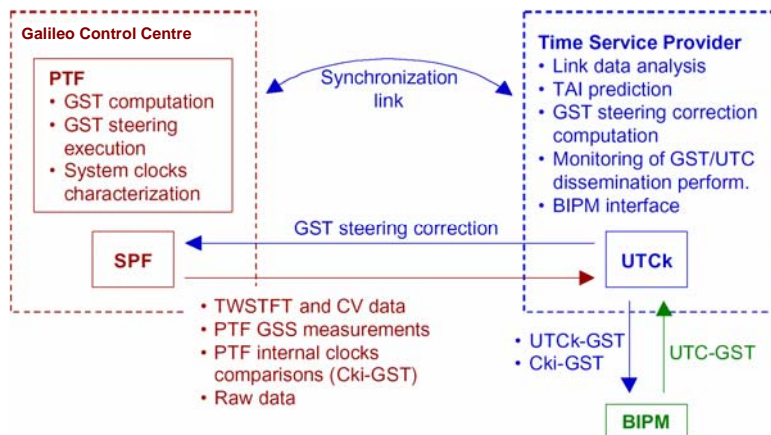

Figure 2. Task allocations and links between PTF (left) and GTSP (right) after [1]. SPF = “Service Products Facility”. I/F to GPS (USNO) not shown here.

Table 1. PTF functions testable during IOV after [2].

Function	Performance level achievable at IOV
GST Generation	FOC
Steering to TAI	To be agreed with GTSP
Determination of GGTO	~ FOC
Dissemination of GST to fixed user	~ FOC
Dissemination of UTC	Depending on GTSP
Switching from PTF1 to PTF2	Depending on UTC(k) lab to be used as PTF2

The above statements are valid as far as GST performance is concerned. As far as important other functions are concerned, in particular redundancy and master clock switching mechanisms, the PTF architecture baseline for IOV is deemed not sufficient. Assuming an adequately equipped and experienced UTC (k) lab with NMI functions is involved as GTSP, it would have to burden the three-fold

work load of acting as GTSP with all related tasks, providing and operating back-up master clock(s), and still providing national metrological service in the T&F area.

Since, moreover, the PTF redundancy mechanisms are considered more critical than the GST generation and steering algorithms, where valuable experience exists worldwide, the presently defined focus of the PTF related tasks during IOV should be reconsidered carefully.

Alternatively, facilities, equipment, and operational expertise available in non-NMI time labs and industry incl. the ESA deep space tracking facilities in New Norcia or Cebreros (both equipped with AHM clocks, CV/TWSTFT equipment, etc.) could be re-used to test:

- a) phase-synchronous switching between the master and the hot-spare AHM within the master PTF,
- b) steering of the slave to the master PTF and switching from the master to the slave PTF (will have non-negligible procedure/effect on ODS).

In addition, it is considered inevitable to evaluate operational PTF procedures and to gain hands-on experience with clocks and timing equipment at the earliest possible state of implementation. According to NMI experience, such processes generally last several years, in particular when covering detection of yearly changes to clocks, facilities, etc. It is, therefore, recommended to put in operation both the master PTF and the GTSP already for IOV.

3 ARCHITECTURE BASELINE

To fulfill the above objectives and specifications, the Galileo PTF should consist of the following major components/sub-systems:

1. Clock ensemble;
2. Local T&F measurement subsystem, consisting of:
 - core measurement equipment;
 - support measurement equipment.
3. GST/GGTO data processing subsystem;
4. GST realization subsystem;
5. T&F comparison subsystem (synchronization links);
6. Time data interfaces subsystem, made up of:
 - external communication I/F and
 - data storage/archiving facilities;
7. Monitoring & Control (M&C) subsystem, incl. environmental sensors.

Figure 3 shows a block diagram of the PTF architecture designed by the Phase C0 study team covering

Cs clocks. Considering this configuration, the generation of GST can be represented at the conceptual and physical levels as illustrated in Figure 4. Note that neither cabling, networks, processing units, nor the Monitoring and Control Subsystem are shown.

GST generation in FOC will follow the same scheme as in IOV, but will involve redundant elements [1, 3]. The most important of these elements are: second AHM clock, fourth Cs clock, second micro-phase-stepper, and redundant cabling. We propose to operate 3 AHMs, which would allow immediate isolation of any faulty AHM. Since two PTFs shall be operated, dedicated algorithms and procedures to manage the redundancies (failure detection, switching procedures, etc.) will be required for. These are discussed in Section 5.

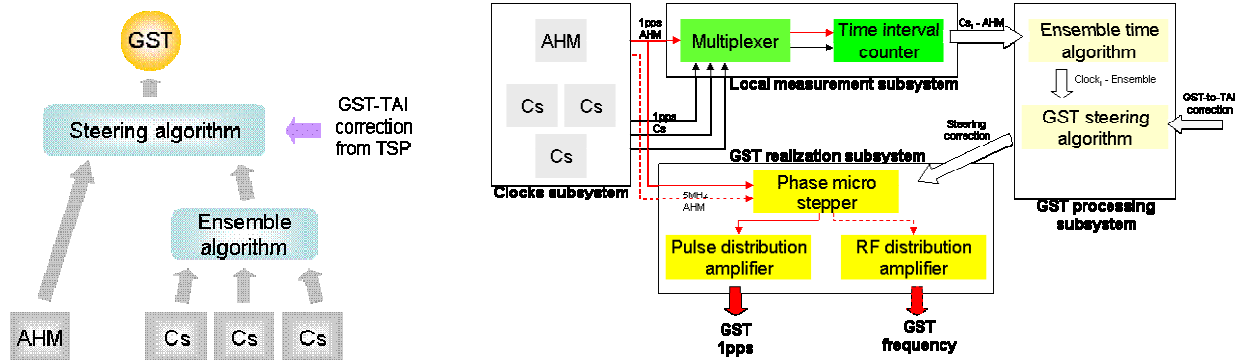

Figure 4. GST generation/steering chain: conceptual level (left), physical level (right).

4.2 GGTO DETERMINATION

Since Galileo will rely on its own internal time scale (GST), but future users most likely will (have to) handle a combination of both GPS and Galileo data, it has been decided to include a common pre-determined Galileo/GPS Time Offset (GGTO) parameter in the navigation messages of both systems. This will enable users with limited satellite visibility (e.g., two Galileo, two GPS) to process valid solutions without the need to solve for the time unknown.

A basic GGTO determination scheme has been worked out in Phase C0 and is shown in the figure below. It uses data of a GPS time receiver and TWSTFT equipment, both installed at the PTF and driven by GST. More details about the GGTO algorithm can be found in [5] and [6].

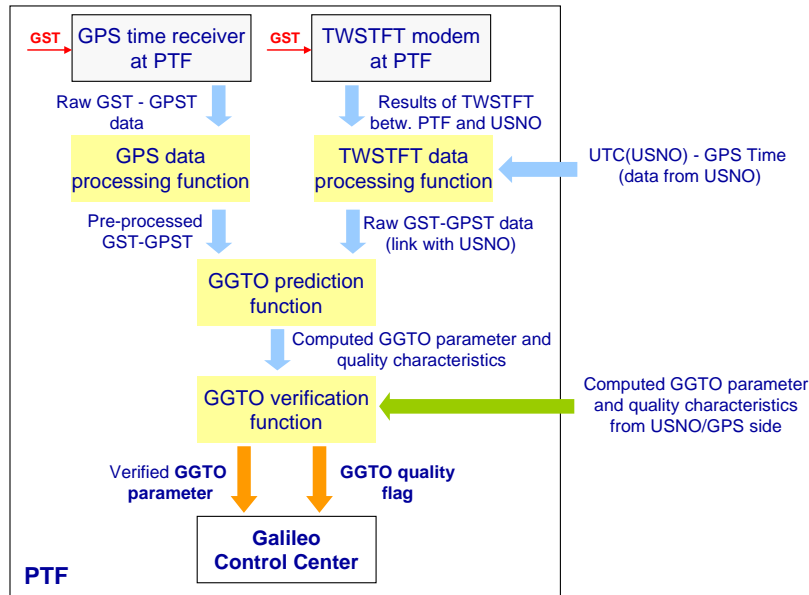

Figure 5. GGTO determination scheme as proposed by Phase C0 study team.

5 FAILURES AND REDUNDANCIES

5.1 FAILURE IDENTIFICATION

The following table illustrates possible failure events on PTF component level, which are relevant to the GST and GGTO generation chains in the context of the present PTF redundancy concepts as defined for IOV and FOC. The events were identified based on operational experience in NMIs and/or time laboratories.

The probability of events is designated as follows: “M” – medium (in order of a few times a year), “L” – low (in order of one or two times during the component lifetime). The probability of certain GST algorithm failures can presently not be estimated due to the lack of knowledge on failure detection procedures in these algorithms and their verification. Moreover, the failures/malfunctions of the following components are presently not considered:

- cables (which typically do not produce long-lead failures if they were initially properly tested);
- data collection/device control S/W (needs to be included in further detailed analysis).

Table 2. Possible failure events on PTF components (list not exhaustive).

Component	Pr	Event
AHM clock	M	Temporary malfunction (phase or frequency step) affecting both 1pps and RF outputs
	M	Degradation of performance (increase of frequency drift, increase of ADEV) affecting both 1pps and RF outputs
	L	Failure of single output (either 1pps or RF output is not available)
	L	Device failure (all 1pps and/or RF outputs are not available)
Cs clock	L	Temporary malfunction (phase or frequency step) affecting both 1pps and RF outputs
	L	Degradation of performance (increase of frequency drift, increase of ADEV), affecting both 1pps and RF outputs
	L	Failure of single output (either 1pps or RF output is not available)
	L	Device failure (all 1pps and/or RF outputs are not available)
Multiplexer	M	False switching (wrong input is connected to the device output)

Component	Pr	Event
	L	Degradation of performance of single input (e.g. loose contact on relay)
	L	Failure of single input (one 1pps or RF output is not available)
	L	Device failure (multiplexer not working)
TIC	L	Degradation of performance
	L	Device failure (TIC not working)
Micro phase stepper	L	Degradation of MPS output performance (e.g. increase of noise due to MPS H/W problems)
	L	Device failure (MPS not working)
GST Pulse distributor	L	Degradation of performance of one pulse distributor output (e.g. increase of noise in terms of ADEV)
	L	Failure of one distributor output
	L	Device failure (distributor not working)
GST RF distributor	L	Degradation of performance of one RF distributor output (e.g. increase of noise in terms of ADEV)
	L	Failure of one RF distributor output
	L	Device failure (distributor not working)

5.2 FAILURE HANDLING

Failure handling covers high-level measures that should preferably be undertaken automatically at the PTF following detection of a failure in the GST generation chain (maser – phase stepper – distributor – receiver) to restore generation of GST and to eliminate any impact on GST performance. We consider redundancy handling issues to be a critical point in GST generation; therefore, we propose to test the corresponding mechanism already during IOV to ensure their proper functioning at and after reaching FOC. Thus, the PTF configuration would be in IOV basically the same as in FOC (only one Cs clock less). The switching between the PTFs could be tested in collaboration with an existing time laboratory or NMI.

The current baseline [1] foresees the failure handling to be executed at the level of individual PTF components. This strategy implies the ability to detect a failed component and to execute the switching or other response measures within such a short interval of time that would make the failure non-critical for the overall system performance.

It is understood that this interval of time (which is basically the requirement of maximum Time-To-Repair for GST) is set mainly by the ODTS processing. Assuming that the navigation processing is executed in ODTS in 10 minutes batches, and the update (upload) rate of satellite navigation messages is 90 minutes, we consider the Time-To-Repair of GST to be equal to the interval that would lead in the worst case to a loss of two processing batches. Note that, in the current baseline, the PTF is not included in the integrity chain; therefore, we do not consider here requirements w.r.t. the integrity processing, which would lead to Time-To-Repair of GST of less than 1 s.

Figure 6 illustrates the logic of the switching and steering mechanism as proposed in Phase B2. It is

foreseen that one of the H-masers (AHM1a in Figure 6) represents GST the Master Clock (MC). The other AHM is working as hot spare MC, and the second PTF is operated on a master-slave basis with the primary one. Note that titles as “MC” or “primary” refer only to the role of a certain element and does not constitute a permanent designator; these roles may change during Galileo operations as a result of switching between individual elements or components.

We found that, in real operations, it will be hardly possible to make all switching operations automatic. It would be possible to some extent to automate the detection and corresponding switching for failures related to the lack of output signals on PTF components. However, such failures as performance degradation of a component or situations when a planned maintenance should be executed would involve certain manual operations that would require trained personnel.

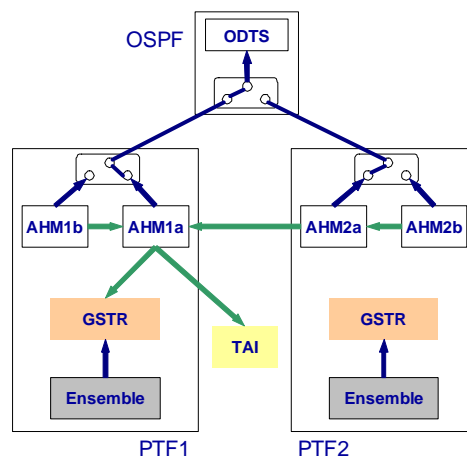

Figure 6. Baseline PTF switching and steering mechanism in FOC after [1].

Following these guidelines, our Phase C0 approach is deemed to be more reliable and much simpler in operation than the Phase B2 baseline. We propose to place the switch inside the ODTS functions (Figure 7). This way, the switching process load would be reduced to solely informing ODTS that switching has occurred and which AHM is the MC. ODTS should then derive GST from the corresponding data set.

In fact, each of the AHM could be connected to its “own” Galileo Time Receiver (collocated within each PTF) and the data from all four receivers (two at each of the PTFs) could be delivered to ODTS via standard data transfer interfaces.

The overall switching logic is rather simple, leaving individual modules and steering schemes unaffected by failures in other modules. Note that all AHM are steered to GSTR (which is the free-running ensemble time) as produced at the PTF, and that each GSTR is individually steered to TAI. Moreover, this concept allows a much higher flexibility and a simple, but powerful scalability throughout the various Galileo implementation phases.

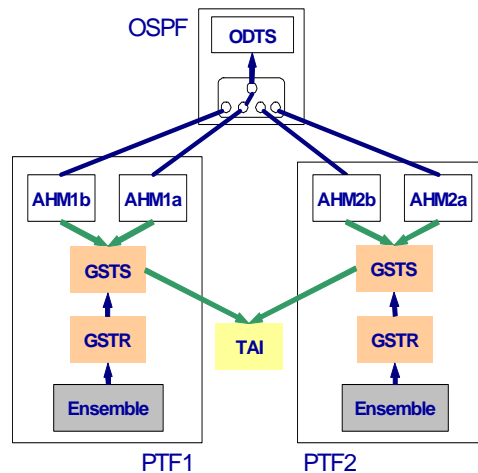

Figure 7. Alternative PTF switching and steering mechanism as proposed by Phase C0 study team.

To avoid phase and frequency steps in GST following any switching, it is advisable to use a GST model (e.g., a linear polynomial) within ODTS. The model should be activated following a switching to compensate the GST step. Its coefficients (time and frequency offsets between the AHMs) can be determined from PTF measurements and ODTS processing results.

Hardware realization of such switching scheme within one PTF is illustrated in Figure 8, showing the individual GST generation chains (AHM – stepper – distributor – receiver). Note that there is no H/W switching element on PTF side; thus, following a failure in one of the GST generation chains, personnel will have rather moderate time constraints for organizing repair or replacement of failed components. The system could always run without impact on GST performance (but with reduced reliability until the failed chain will have been repaired). Absence of H/W switching elements simplifies PTF operation and increases system reliability. This design has also benefits from the AIT point of view, as each module can be built, assembled, and tested separately without disturbance.

There is a need to define where the decision on selection of the master clock and on switching occurs. PTF is not a good candidate, since a) the two PTFs may come to contradictory decisions, and b) it is desirable to have a human supervision of the decision making. Thus, it is advisable to allocate the responsibility for GST definition and switching to one of the manned facilities of the Galileo Ground Control Centre (GCC). PTF should provide comprehensive clock monitoring data and warning messages to support the decision making.

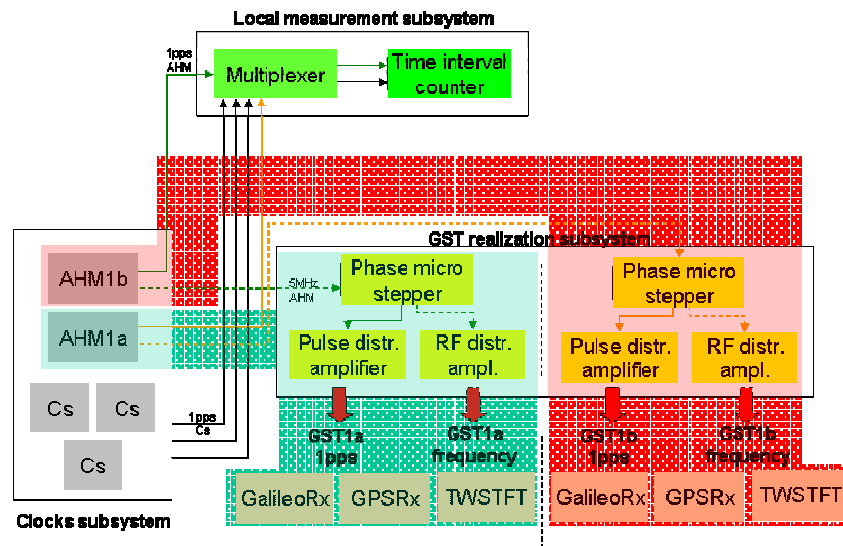

Figure 8. Independent hardware chains for each AHM.

6 SUMMARY AND CONCLUSIONS

The main recommendations worked out in the PTF Phase C0 design study can be summarized as follows. Due to limited experience on implementation of automatic redundancy/failure management systems, it is advisable to implement and test the corresponding mechanisms and algorithms already during IOV. Otherwise, there is a danger to enter FOC with a not thoroughly tested PTF that may fail to meet the requirements on availability and reliability of GST.

The mission of not only FOC, but also IOV critically depends on the availability and performance of GST. From practical experience, it is known that the most critical PTF components are at the same time long-lead items (6 months or more). Moreover, they are produced only by very few manufactures worldwide. In particular, the work horse of GST – the AHM clock – is known to be more a scientific than a commercial instrument, whose failure modes are not very well studied. Therefore, it is advisable to have hot spares for critical PTF components, including the AHM already in IOV. The impact of the procurement of PTF hot spares on the overall IOV costs is estimated to be rather moderate.

The Phase B2 baseline that foresees physical steering of all backup AHMs to the MC is rather complex in implementation and operation. Switching would in addition require skilled personnel to undertake certain activities within a rather short reaction time. Our alternative approach seems to be more attractive in terms of reliability and simplicity of operation. In our approach each GST generation chain (maser – phase stepper – distributor – Galileo receiver) will be operated separately and deliver its data continuously to the ODTs function. ODTs will then derive GST from the data relating to the AHM currently assigned as the MC. No hardware switching is needed and no immediate actions by the GCC personnel on PTF hardware are required to realize the switching. The switching itself is limited to some actions within ODTs that would have to derive GST from another set of observations corresponding to the new MC.

The Phase B2 baseline architecture foresees physical steering of all AHMs to the (current) master one. The stringent steering requirements can be hardly met due to intrinsic calibration errors of the measurement equipment. An alternative solution is to steer all AHMs to individual free-running ensemble time scales GSTRs produced at corresponding PTFs, and steer these GSTRs in turn to TAI. As a result, all AHMs will be kept very close to each other. To compensate for steps following any switching between the AHMs, a GST model (e.g., a linear polynomial) might be used in ODTS. Coefficients of this model can be determined using both the results of ODTS processing and the clock measurements made at the PTFs.

In any case, it is desirable that ODTS provides a feedback to PTF about its estimates of the quality of the PTF raw data and the quality of GST, since these effects are not immediately visible to PTF. This information would complement clock monitoring made at PTF and assist a reliable real-time assessment of the quality of GST.

ACKNOWLEDGMENTS

The work described in this paper has been funded by the European Space Agency (ESA).

REFERENCES

- [1] PTF Concept File (Phase B2 Consolidation), ESA document, November 2002.
- [2] Analysis of IOV System Configuration (Phase B2 Consolidation), ESA document, October 2002.
- [3] Galileo System Time Generation (Phase B2 Consolidation), GSTGENALG ID. 48, Issue 7, ESA document, October 2002.
- [4] Galileo Mission Segment Requirements (Phase C0), GMSREQ, Issue 9, ESA document, March 2004.
- [5] A. Moudrak, *et al.*, 2004, “*Determination of GPS/Galileo Time Offset to Support the System Operability*,” in Proceedings of the European Navigation Conference (ENC-GNSS), 16-19 May 2004, Rotterdam, the Netherlands, in press.
- [6] A. Bauch, D. Piester, A. Moudrak, and G. Petit, 2004, “*Time Comparisons between USNO and PTB: A Model for Determining the Time Offset between GPS Time and the future Galileo System Time*,” in Proceedings of the 2004 IEEE International Ultrasonics, Ferroelectrics, and Frequency Control 50th Anniversary Joint Conference, 24-27 August 2004, Montreal, Canada (IEEE), in press.