

**Integrated Design of Semi-Displacement Patrol Crafts**

By

**Andrew J. Gillespy**

B.E. Electrical Engineering

Vanderbilt University, 1998

Submitted to the Department of Mechanical Engineering and System Design and Management in  
Partial Fulfillment of the Requirements for the Degrees of Naval Engineer

and

Master of Science in Engineering and Management

at the

Massachusetts Institute of Technology

June 2008

© 2008 Massachusetts Institute of Technology. All rights reserved.

MIT hereby grants to the US Government permission to reproduce and to distribute publicly  
paper and electronic copies of this thesis document in whole or in part.

Signature of Author \_\_\_\_\_



Department of Mechanical Engineering and  
System Design and Management

Certified by \_\_\_\_\_

  
May 9, 2008

Patrick Keenan

Professor of Naval Architecture

Thesis Supervisor

Certified by \_\_\_\_\_



Richard W. Kimball

Thesis Supervisor

Accepted by \_\_\_\_\_



Lallit Anand

Professor of Mechanical Engineering

Chair, Departmental Committee on Graduate Students

Accepted by \_\_\_\_\_

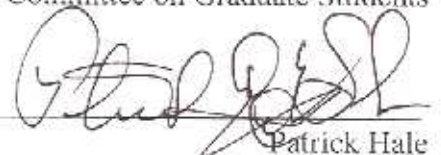

Patrick Hale

Director, System Design and Management Fellows Program

Engineering Systems Division

**REPORT DOCUMENTATION PAGE**

*Form Approved  
OMB No. 0704-0188*

The public reporting burden for this collection of information is estimated to average 1 hour per response, including the time for reviewing instructions, searching existing data sources, gathering and maintaining the data needed, and completing and reviewing the collection of information. Send comments regarding this burden estimate or any other aspect of this collection of information, including suggestions for reducing the burden, to Department of Defense, Washington Headquarters Services, Directorate for Information Operations and Reports (0704-0188), 1215 Jefferson Davis Highway, Suite 1204, Arlington, VA 22202-4302. Respondents should be aware that notwithstanding any other provision of law, no person shall be subject to any penalty for failing to comply with a collection of information if it does not display a currently valid OMB control number.

**PLEASE DO NOT RETURN YOUR FORM TO THE ABOVE ADDRESS.**

1. REPORT DATE (DD-MM-YYYY)		2. REPORT TYPE		3. DATES COVERED (From - To)	
4. TITLE AND SUBTITLE				5a. CONTRACT NUMBER	
				5b. GRANT NUMBER	
				5c. PROGRAM ELEMENT NUMBER	
6. AUTHOR(S)				5d. PROJECT NUMBER	
				5e. TASK NUMBER	
				5f. WORK UNIT NUMBER	
7. PERFORMING ORGANIZATION NAME(S) AND ADDRESS(ES)				8. PERFORMING ORGANIZATION REPORT NUMBER	
9. SPONSORING/MONITORING AGENCY NAME(S) AND ADDRESS(ES)				10. SPONSOR/MONITOR'S ACRONYM(S)	
				11. SPONSOR/MONITOR'S REPORT NUMBER(S)	
12. DISTRIBUTION/AVAILABILITY STATEMENT					
13. SUPPLEMENTARY NOTES					
14. ABSTRACT					
15. SUBJECT TERMS					
16. SECURITY CLASSIFICATION OF:			17. LIMITATION OF ABSTRACT	18. NUMBER OF PAGES	19a. NAME OF RESPONSIBLE PERSON
a. REPORT	b. ABSTRACT	c. THIS PAGE			19b. TELEPHONE NUMBER (Include area code)

## INSTRUCTIONS FOR COMPLETING SF 298

**1. REPORT DATE.** Full publication date, including day, month, if available. Must cite at least the year and be Year 2000 compliant, e.g. 30-06-1998; xx-06-1998; xx-xx-1998.

**2. REPORT TYPE.** State the type of report, such as final, technical, interim, memorandum, master's thesis, progress, quarterly, research, special, group study, etc.

**3. DATES COVERED.** Indicate the time during which the work was performed and the report was written, e.g., Jun 1997 - Jun 1998; 1-10 Jun 1996; May - Nov 1998; Nov 1998.

**4. TITLE.** Enter title and subtitle with volume number and part number, if applicable. On classified documents, enter the title classification in parentheses.

**5a. CONTRACT NUMBER.** Enter all contract numbers as they appear in the report, e.g. F33615-86-C-5169.

**5b. GRANT NUMBER.** Enter all grant numbers as they appear in the report, e.g. AFOSR-82-1234.

**5c. PROGRAM ELEMENT NUMBER.** Enter all program element numbers as they appear in the report, e.g. 61101A.

**5d. PROJECT NUMBER.** Enter all project numbers as they appear in the report, e.g. 1F665702D1257; ILIR.

**5e. TASK NUMBER.** Enter all task numbers as they appear in the report, e.g. 05; RFO330201; T4112.

**5f. WORK UNIT NUMBER.** Enter all work unit numbers as they appear in the report, e.g. 001; AFAPL30480105.

**6. AUTHOR(S).** Enter name(s) of person(s) responsible for writing the report, performing the research, or credited with the content of the report. The form of entry is the last name, first name, middle initial, and additional qualifiers separated by commas, e.g. Smith, Richard, J, Jr.

**7. PERFORMING ORGANIZATION NAME(S) AND ADDRESS(ES).** Self-explanatory.

**8. PERFORMING ORGANIZATION REPORT NUMBER.** Enter all unique alphanumeric report numbers assigned by the performing organization, e.g. BRL-1234; AFWL-TR-85-4017-Vol-21-PT-2.

**9. SPONSORING/MONITORING AGENCY NAME(S) AND ADDRESS(ES).** Enter the name and address of the organization(s) financially responsible for and monitoring the work.

**10. SPONSOR/MONITOR'S ACRONYM(S).** Enter, if available, e.g. BRL, ARDEC, NADC.

**11. SPONSOR/MONITOR'S REPORT NUMBER(S).** Enter report number as assigned by the sponsoring/monitoring agency, if available, e.g. BRL-TR-829; -215.

**12. DISTRIBUTION/AVAILABILITY STATEMENT.** Use agency-mandated availability statements to indicate the public availability or distribution limitations of the report. If additional limitations/ restrictions or special markings are indicated, follow agency authorization procedures, e.g. RD/FRD, PROPIN, ITAR, etc. Include copyright information.

**13. SUPPLEMENTARY NOTES.** Enter information not included elsewhere such as: prepared in cooperation with; translation of; report supersedes; old edition number, etc.

**14. ABSTRACT.** A brief (approximately 200 words) factual summary of the most significant information.

**15. SUBJECT TERMS.** Key words or phrases identifying major concepts in the report.

**16. SECURITY CLASSIFICATION.** Enter security classification in accordance with security classification regulations, e.g. U, C, S, etc. If this form contains classified information, stamp classification level on the top and bottom of this page.

**17. LIMITATION OF ABSTRACT.** This block must be completed to assign a distribution limitation to the abstract. Enter UU (Unclassified Unlimited) or SAR (Same as Report). An entry in this block is necessary if the abstract is to be limited.

# **Integrated Patrol Craft Design**

by

**Andrew J. Gillespy**

Submitted to the Department of Mechanical Engineering and the Department of  
System Design and Management in Partial Fulfillment of the Requirements for the Degrees of  
Naval Engineer  
and  
Master of Science in Engineering and Management

## **ABSTRACT**

Early stage ship design and assessment continues to be a challenge for naval architects and ocean engineers. The complex and multifaceted interactions between the different components of the ship and the broad spectrum of disciplines required in ship design make it difficult to fully realize the effects of any one change on the entire system. The initial design of smaller patrol craft is especially difficult due to the lack of design tools able to deal with ships of small size operating in the semi-planing region. This paper puts forth a method for narrowing the design space for patrol craft design. Using a systems approach, a Patrol Craft Assessment Tool (PCAT) was created and tested to aide designers in the initial design and assessment of patrol craft of < 200 ft. PCAT is an open source MATLAB code that incorporates resistance, engine selection, structures, and mission profiles into one design program to aide a designer in optimizing a patrol craft.

Thesis Supervisor: Richard W. Kimball

## **BIOGRAPHICAL NOTE AND ACKNOWLEDGEMENTS**

Andrew Gillespy is a Lieutenant in the U.S. Navy. He received his B.E. from Vanderbilt University in Electrical Engineering in 1998 and was commissioned as an Ensign in the U.S. Navy. Andrew Gillespy is qualified in submarines and served 3 years aboard the USS Pennsylvania (Blue). He transferred into the Engineering Duty Community where he will design, maintain, and acquire submarines for the U.S. Navy.

The author would like to thank Richard Kimball and Pat Hale for taking the time out to provide advice, ideas, and encouragement leading to the success of this project. Thanks is also due to CAPT Patrick Keenan for providing leadership and direction throughout all the coursework at MIT. Additionally, the author would like to thank Clint Lawler, whose work in planing craft design provided the framework for this project. Finally, the author would like to thank his beautiful wife Sharon and three wonderful children, Brendan, Helen, and Peter for always providing love and support.

# Contents

1.0	Introduction.....	8
1.1	Assessment of other Tools .....	9
1.2	Next Steps .....	10
1.3	Major Assumptions .....	11
2.0	Software Architecture .....	11
2.1	Program Architecture.....	12
2.1.1	Gathering User Inputs .....	12
2.1.2	Generating Variants .....	18
2.1.3	Build Variants .....	18
2.1.4	Final Analysis .....	19
2.1.5	Display Results .....	19
2.1.6	Completing Another Run.....	19
2.2	Data Architecture .....	20
3.0	Module Creation and Validation.....	21
3.1	Variant Creation.....	21
3.1.1	Possible Parent Hulls .....	22
3.2	Variant Geometry.....	22
3.3	Bare Hull Resistance.....	25
3.4	Appendage Resistance .....	28
3.5	Shaft Horse Power .....	29
3.5.1	Wake Factor and Thrust Deduction Factor .....	29
3.5.2	Propeller Efficiency .....	30
3.5.3	Efficiencies for Given Hulls .....	30
3.5.4	Shaft and Gearbox Efficiencies .....	30
3.6	Engine Selection .....	31
3.7	Fuel Loading and Efficiency.....	31
3.8	Structures .....	33
3.9	Weights .....	36
3.10	Balancing .....	37
3.11	Seakeeping .....	38
3.12	Cost .....	39
3.13	Performance .....	40
3.14	Rejection Criteria.....	41

4.0	Using PCAT.....	43
4.1	Inputs.....	43
4.2	First Run Outputs.....	44
4.3	Second Run Results.....	53
5.0	Conclusion.....	55
5.1	Areas for Future Work.....	55
5.2	Final Thoughts.....	56
6.0	Works Cited.....	57
	APPENDIX A – ABS Standards for vessels < 90m in length.....	59
	APPENDIX B – Global Variable Description.....	95
	APPENDIX C – Engine Library.....	110

## List of Figures

Figure 1-1 Screen Shots from PCAT .....	8
Figure 2-1 Overall Program Architecture .....	12
Figure 2-2 Geometry Inputs.....	13
Figure 2-3 Loading Inputs .....	14
Figure 2-4 Machinery and Manning Input.....	15
Figure 2-5 Weapons Input .....	15
Figure 2-6 Speed Input.....	16
Figure 2-7 OMOE Input.....	17
Figure 2-8 Cost Input .....	18
Figure 2-9 Build Variant Process.....	19
Figure 3-1 Accuracy of PCAT Resistance.....	28
Figure 3-4 Typical Fuel Efficiency.....	32
Figure 3-5 Sample t-beam.....	34
Figure 3-6 Midsection from POSSE.....	36
Figure 3-7 Original Offsets.....	38
Figure 3-8 Adjusted Offsets.....	38
Figure 3-9 Example MOE.....	41
Figure 4-1 Main Output Screen .....	44
Figure 4-2 Lifecycle Cost vs. OMOE.....	45
Figure 4-3 Weapon Group vs. OMOE.....	45
Figure 4-4 Parent Hull vs. Lifecycle Cost .....	46
Figure 4-5 Maximum Speed vs. Endurance.....	46
Figure 4-6 Geometry Summary .....	47
Figure 4-7 Speed, Range, and Manning Summary .....	48
Figure 4-8 Machinery Summary .....	48
Figure 4-9 Loading Weapons, and Cost Summary.....	49
Figure 4-10 Body Plan .....	49
Figure 4-11 Weight Report .....	50
Figure 4-12 Speed Profile .....	50
Figure 4-13 Powering Curves .....	51
Figure 4-14 Structures Graphical.....	51
Figure 4-15 Structures Summary .....	52
Figure 4-16 OMOE .....	52
Figure 4-17 Second Run Results .....	54
Figure B-1 USER variable breakdown .....	101
Figure B-2 Generic offset grid.....	102
Figure B-3 HULL Variable.....	108
Figure B-4 HULL Variable.....	109

## List of Tables

Table 2-1 Material Properties .....	14
Table 3-1 Validation of Geometric Data .....	25
Table 3-2 Validation of Geometric Data .....	25
Table 3-3 Compton Resistance Bounds .....	26
Table 3-4 Appendage Resistance Factors .....	29
Table 3-5 Structural Validation .....	36
Table 3-6 Weight Group Descriptions .....	36
Table 3-7 Default Costs .....	40
Table 4-1 Input Parameters for Weapons .....	43
Table 4-2 Changes for Second Run Inputs .....	53
Table B-1 HULL.weight description .....	106

# 1.0 Introduction

As with many tasks, determining the initial scope was critical to the success and robustness of the project. The goal of this thesis was:

*To aide ship designers in the early stage design of patrol craft of < 200 feet that operate in the displacement or semi-displacement regions by incorporating all major hull systems and design variables into a program that requires no manipulation of data by the user and displays results that aide the designer in making design decisions and assessing potential engineering tradeoffs in a timely manner.*

MATLAB was as the environment for creating the design tool. The user is required to put in preferences for several ranges of parameters such as hull form, length, length to beam ratio, material used, speed profile etc. The user preferences are then assigned to different variants, and each variant attempts to converge to a specific design. Finally each design is assessed for lifecycle cost, acquisition cost, and performance. The results of each variant are then provided to the user for further analysis. Figure 1-1 shows a user input screen, a cost performance results screen, the body plan, and the speed profile for a particular run of PCAT.

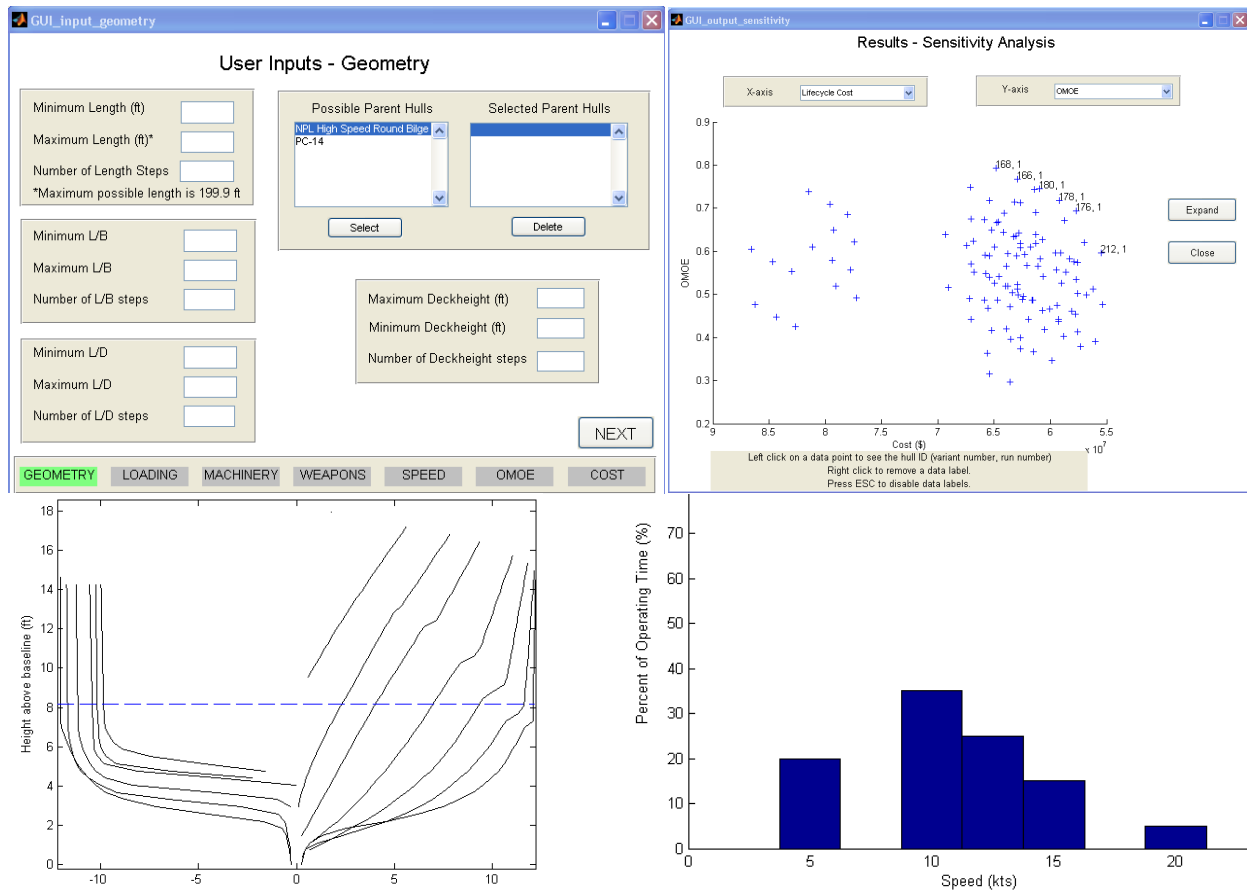

Figure 1-1 Screen Shots from PCAT

## **1.1 Assessment of other Tools**

Any program that satisfies all or part of the design goal would be of use in this project. Therefore, the first task was to look at current ship design tools and assess their ability to aide in fulfilling the project objective. It is worth noting that none of the codes listed are open source.

### **Maxsurf**

Maxsurf is a suite of products made by Formation Design Systems that aids ship designers in modeling hull forms and determining the full range of naval architectural requirements using a common graphical user environment. Linear strip theory is used extensively as the primary means of analyzing stability, seakeeping, and resistance. Structural analysis can be performed within the suite as well. All modules work consistently on a common ship model (1). Maxsurf would seem to be a very good product for the design of a patrol craft, it uses an interface that allows a smooth transition between modules such as seakeeping and resistance, and it even allows for detailed design. While Maxsurf is an excellent product, it does not allow for gross changes to be applied to a design in a simple manner. For instance, if the designer wanted to look at the performance effects of two different hull forms, the designer would first have to build two separate hull forms (which is a time consuming process), analyze the hull forms separately and then export the analysis information into a separate program for comparison. While an excellent analysis tool and later stage design tool, Maxsurf is not adequate for the early stage design.

### **The Program of Ship Salvage Evaluation (POSSE)**

POSSE is a structural analysis and salvage response software owned by the U.S. Navy's Supervisor of Salvage and maintained by Herbert Engineering Corporation that provides the capability to perform engineering analyses of complex structural and ship salvage situations, including assessments of ship stability, drafts/trim, intact or damaged structural strength, ground reaction and freeing force, oil outflow and flooding, lightering (weight removal) plan, and tidal effects (2). POSSE is another excellent analysis program, though it is limited in scope to primarily structures. It does not have the resistance or dynamic seakeeping analysis of a program like Maxsurf, but it does allow for easy analysis of ship structures to verify the user specified design requirements were met. This program does not have the breadth of ability to be used in a complete design package, and is sorely lacking the ability to receive a script input to allow for easier interface with other programs. Therefore POSSE was not used for this project.

### **Paramarine**

Paramarine, created by GRC Ltd., is an excellent object oriented program that allows for the designer to go from concept through final detailed design in one program. It is a very powerful and robust program. However it is not suited to early stage concept analysis. The designer must place every system on the ship from the main machinery all the way down to the fuel pump. This level of detail, while excellent for a complete design, is not ideal early in the design process. Unlike Maxsurf, Paramarine does have the ability to change major variables (such as hull length) with relative ease; however it is not able to compare different variants within the program.

Paramarine cannot be used to meet the objective of this project primarily due to the detail required to design a single variant and the time intensive nature of a single design process.

### **Advanced Surface Ship Evaluation Tool (ASSET)**

ASSET is a synthesis tool developed and maintained by the U.S. Naval Sea Systems Command, Carderock Division. It allows for the designer to input design variables such as hull form, ship subdivisions, and weapon system weights, and attempts to synthesize the design into a single ship. ASSET has the ability to take inputs from other programs such as a spreadsheet, manipulate the information, and return synthesized data. ASSET's capabilities match very closely with the objectives of this thesis. It incorporates all major hull systems and design variables into a program that requires no manipulation of data by the user and displays results in a timely manner. However ASSET has two major drawbacks that limit its use for the purpose of PCAT. It cannot perform analysis of different ships within the program; however this can be accomplished using a scripting function due to ASSET's ability to receive data at any stage of the design. Secondly, and more importantly, ASSET is not designed for patrol craft design. According to the ASSET web site, ASSET's surface combatant module is intended to design ships in between 1000 and 12,000 tons (3). The patrol craft concept will be less than 1000 tons thereby making ASSET unusable for this project.

### **Surface Wave Analysis (SWAN)**

SWAN uses the three dimensional Rankine Panel Method to determine fluid flow around high speed bodies. SWAN then uses pressure integration to determine forces on the hull of ship or other ocean body. While SWAN performs no structures calculations, it does provide valuable information on seakeeping and resistance for any arbitrary hull form. SWAN is cumbersome to use, though it does have the ability to interface with other programs, and because it uses theory as opposed to parametric analysis, SWAN can provide accurate values for a wider range of input parameters.

Ideally, SWAN would be used to provide the seakeeping and resistance data for this project. Its usefulness lies in its ability to take arbitrary hull forms and provide accurate data. Unfortunately, due to the time constraints of this project, SWAN was not used. Incorporating SWAN into this program is defiantly an area where the project could be enhanced to provide more accurate and robust results.

## **1.2 Next Steps**

The above list of design programs was not intended to be exhaustive, but rather a look at the tools available to the author. While each of the design tools does have its advantages, none are adequately suited to meet the stated design goal of this project. Therefore a new program had to be developed. Matlab was chosen as the coding environment because of the author's familiarity with the language and the ease of creating graphical interfaces. The program was named the Patrol Craft Assessment Tool or PCAT.

### **1.3 Major Assumptions**

To complete a project of this magnitude some major assumptions needed to be made especially in regard to the weights in the ship. Because every system is not placed on board the ship in PCAT, it is impossible to get an accurate system weight. Doing so would require the program to be similar to Paramarine in detail, accounting for every pump, motor, nut, bolt, and weld. Instead, PCAT uses the common practice of assuming that the weights can be estimated from similar ships. However, when estimating weights, it is difficult to estimate locations of weights. Therefore, the height of the center of gravity (KG) of the ship is not calculated. Instead the user inputs a range of values. In this way, the designer can design to a specific KG, or at the very least understand the effects of changing KG on the ship. Similarly, the longitudinal center of gravity (LCG) is not calculated, but rather is input by the user. It is reasonable to say that the LCG will be very near or directly over the longitudinal center of buoyancy (LCB). Therefore the user can default the LCG to LCB.

In the design of any ship a standard needs to be set for what is allowable and what is not. The U.S. Navy historically uses military specifications detailed in design data sheets (DDS). While using DDS as a standard would be completely justifiable, it is not optimal for this project. The U.S. Navy is moving away from DDS standards and incorporating their standards into the U.S. Naval Vessel Rules which is a controlled document, hence the author was unable to obtain a copy of the Naval Vessel Rules. Therefore with the exception of range calculations, the design standard used was the American Bureau of Shipping (ABS) rules for steel vessels < 90m in length. ABS standards are publicly available and can be downloaded from the ABS web site. A copy of the relevant ABS structural standards is available in Appendix A.

As in any design, the designer cannot go into a project blindfolded. They must have a clear idea of what needs they are trying to fulfill. While not specifically addressed in this paper, accurately determining the needs of the ship owners and operators and involving them in design decisions is vital to the success a ship. If the goal of a project is to provide value to a customer, and the customer needs are not adequately considered, the designer is guaranteed to have a suboptimal product in performance and cost. More information on gathering customer requirements can be found in reference (4).

## **2.0 Software Architecture**

With the software platform chosen, the next step was to layout the architecture of the program. Using systems engineering, the ship design was broken down into modules that had a specific set of requirements. The interfaces (variables passed to and from modules) were also defined, though they were not controlled as rigorously as they would be on a mechanical project because of the ease in changing the interface. A common heuristic for software architecture is "software architecture should be grown or evolved, not built." (5) This heuristic was used extensively in this program. While clearly laying out the a best guess for the initial function definitions of each module allowed the architect to better understand the requirements of each module and to ensure

each module was built as robustly as possible, the architecture was fluid and changed constantly throughout the design process. What follows is the final version of the software architecture.

The software architecture is divided into two equally important areas; the program architecture which details the flow of the program, the purpose of each module, and the interfaces required, and the data architecture which details how the data is stored, retrieved, and used. These two areas are discussed below.

## 2.1 Program Architecture

The overall flow of PCAT is shown in Figure 2-1. Each of the blocks was in turn divided into functions or modules that executed to create a specific variant.

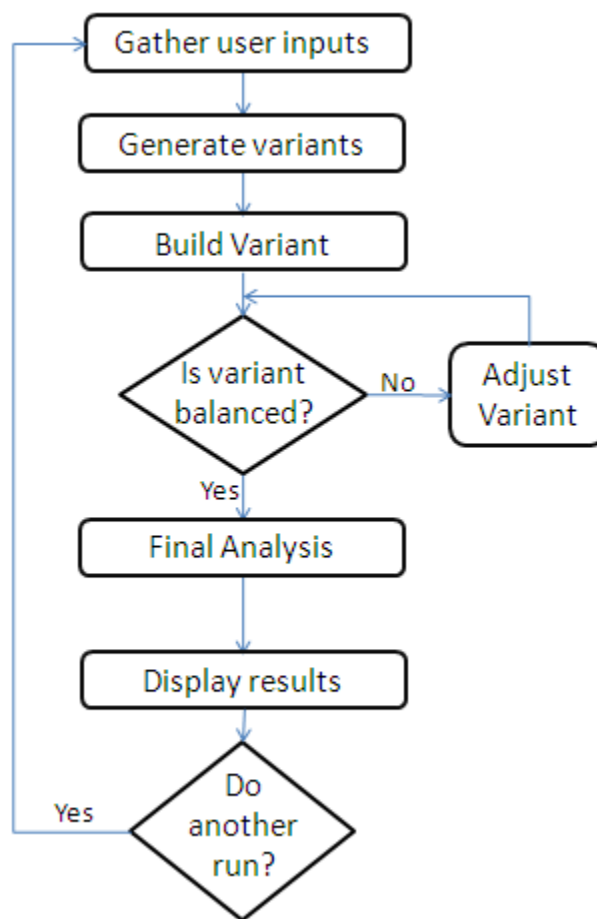

Figure 2-1 Overall Program Architecture

### 2.1.1 Gathering User Inputs

All user inputs were gathered using a graphical user interface (GUI). Matlab provides a function called *guide* that aides in the building of the GUIs. All GUIs used in PCAT were created using the *guide* function. The purpose of the user inputs section is *to gather user desires and store the information for use later in the program by querying the user for relevant data in an easy to*

*understand format using GUIs.* The user inputs were divided into seven segments: geometry, loading, machinery and manning, weapons, speed, overall measure of effectiveness (OMOE), and cost. Many of the user inputs provide the ability for a range of values. If a range of values is required, the user will be asked for a minimum value, a maximum value, and the number of steps. For instance if the minimum length is 90 ft, the maximum length is 110 ft, and the number of length steps is 3, ships will be tested with lengths of 90 ft, 100 ft, and 110ft.

The geometry segment of user inputs is responsible of gathering the user desires for length defined as length between perpendiculars (LBP)<sup>1</sup>, length to beam ratio (L/B), length to depth ratio at midships (L/D)<sup>2</sup>, the deck height or spacing between internal decks, and the parent hull or hull shape. The geometry segment will gather these variables and store them in a global variable for use later in the program. Figure 2-2 shows a screen shot of the geometry user input page.

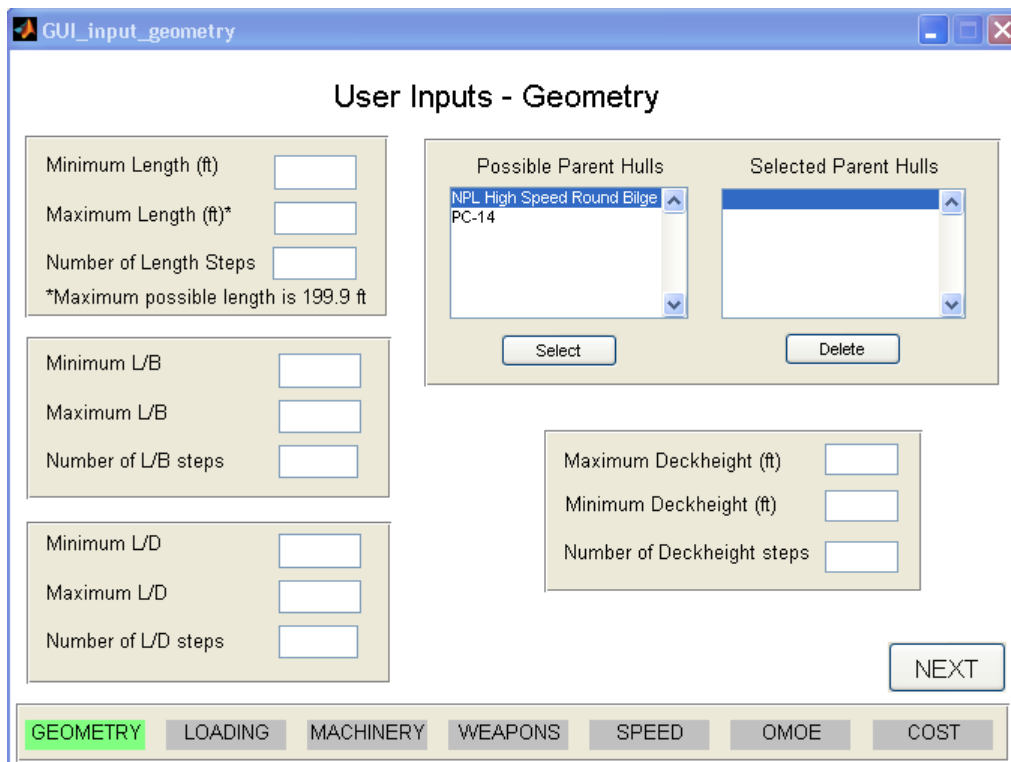

**Figure 2-2 Geometry Inputs**

The next segment is the loading segment. The loading segment is responsible for gathering the user desires for LCG, KG/D, frame spacing, and material used. The properties of the materials used are taken from ABS (6) with the exception of material density. While no specific density was listed in ABS, in a survey of several manufacturing sites, the densities of relevant steels were constant at 490 lbf/ft<sup>3</sup>. This value was used for the density of all three steels. Figure 2-3 shows a screen shot of the loading inputs screen.

<sup>1</sup> Throughout the program the ships "length" is the LBP, if the length used is instead the length overall (LOA), it is specifically listed as such

<sup>2</sup> In PCAT, depth is defined as the depth at station 10 or depth at midships unless specifically listed otherwise.

Ordinary Strength Steel	Yield Strength	34 ksi
	Ultimate Tensile Strength	66.5 ksi
	Density	490 lbf/ft <sup>3</sup>
Higher Strength Steel - AH32	Yield Strength	46 ksi
	Ultimate Tensile Strength	74.5 ksi
	Density	490 lbf/ft <sup>3</sup>
Higher Strength Steel - AH36	Yield Strength	51 ksi
	Ultimate Tensile Strength	80.5 ksi
	Density	490 lbf/ft <sup>3</sup>

**Table 2-1 Material Properties**

**User Inputs - Loading**

Most fwd LCG location  LCG should be input in percent of LWL fwd of midships. For example if the ship has a 100' LWL and the LCG is 55 ft aft of the fwd perpendicular, the LCG would be "-0.05".

Most aft LCG location

Number of LCG locations  Resistance calculation is designed for LCG's from -0.13 to -0.02. Values outside this range will result in a failed ship.

Default LCG? If LCB falls within above limits, default places LCG at LCB. Otherwise, the LCG is placed as near to the LCB as possible, but still within the allowable parameters.

**Possible Hull Materials**

- Higher Strength Strength Steel-AH32
- Higher Strength Strength Steel-AH36
- Ordinary Strength Steel

**Selected Hull Materials**

Hull material properties are as listed in ABS rule Part 2 Chapter 1

Maximum KG/D

Minimum KG/D

Number of KG/D Steps

Maximum frame spacing (ft)

Minimum frame spacing (ft)

Number of f.s. steps

GEOMETRY **LOADING** MACHINERY WEAPONS SPEED OMOE COST

**Figure 2-3 Loading Inputs**

The machinery and manning segment gathers data on the number of engines per shaft, the number of shafts, and the number and type of manning on board the ship. While the total value of the ship's crew can be changed over the variants, the breakdown is constant over all variants. A screen shot of the machinery and manning input screen is shown in Figure 2-4.

The screenshot shows a window titled "GUI\_input\_machinery" with the subtitle "User Inputs - Machinery and Manning". It contains several input fields and radio buttons:

- Minimum Number of Shafts:
- Max Number of Shafts:
- Minimum Manning:
- Maximum Manning:
- Number of Manning Steps:
- Radio buttons:
  - All ships have 1 engine per shaft
  - Ships can have either 1 or 2 engines per shaft
- Percent Officers (%):
- Percent CPO (%):
- Percent Enlisted (%):

At the bottom, there are "PREVIOUS" and "NEXT" buttons, and a navigation bar with tabs: GEOMETRY, LOADING, MACHINERY (highlighted), WEAPONS, SPEED, OMOE, and COST.

Figure 2-4 Machinery and Manning Input

The screenshot shows a window titled "GUI\_input\_weapons" with the subtitle "C4I, Combat, and Weapons Specifications". It contains input fields for various weapon properties and a table for specifications:

- ID:  (Group ID)
- Weight (LT):  (LT of weps)
- Deckhouse Area (sq. ft.):  (Area of Weps)
- In Hull Area (sq. ft.):  (Area of Weps)
- Power Req'd (kW):  (Pwr of Weps)
- KG/D:  (KG to Depth)
- MOE:  (MOE for group)
- Cost (\$1,000):  (Cost for group)

Below the input fields are "Enter" and "Clear All" buttons. To the right is a table with the following header:

ID	Weight	DH Area	IH Area	Pwr Req'd	KG/D	MOE	Cost

At the bottom, there are "PREVIOUS" and "NEXT" buttons, and a navigation bar with tabs: GEOMETRY, LOADING, MACHINERY, WEAPONS (highlighted), SPEED, OMOE, and COST.

Figure 2-5 Weapons Input

The weapons segment serves a different function than the other segments. The purpose of the weapons segment is not to receive a range of weights for weapons but rather to receive a list of independent sets of weapons, C4I (command, control, communication, computers, and information), navigation and communication systems to be used on board the ship. Each set of "weapons" will be used on each variant of ship. For each set, the user enters the total weight, required in hull area, required main deck or deckhouse area, power requirement, KG/D, measure of effectiveness for this set of systems (MOE), and cost of this set of systems (the power

requirement and the KG/D currently serve no purpose, but are there as place holders for future versions of the program). The user must enter all equipment that would normally be part of SWBS weight groups 400, 700, and variable loads with the exception of fuel loading. A screen shot of the weapons input screen is shown in Figure 2-5.

The speed segment gathers information on speed requirements. A speed profile is input to aide in lifecycle cost calculation. Additionally, maximum speed (or more accurately, the minimum speed that must be achieved at full power), endurance speed, and range are all gathered in this segment. Figure 2-6 shows the speed input screen.

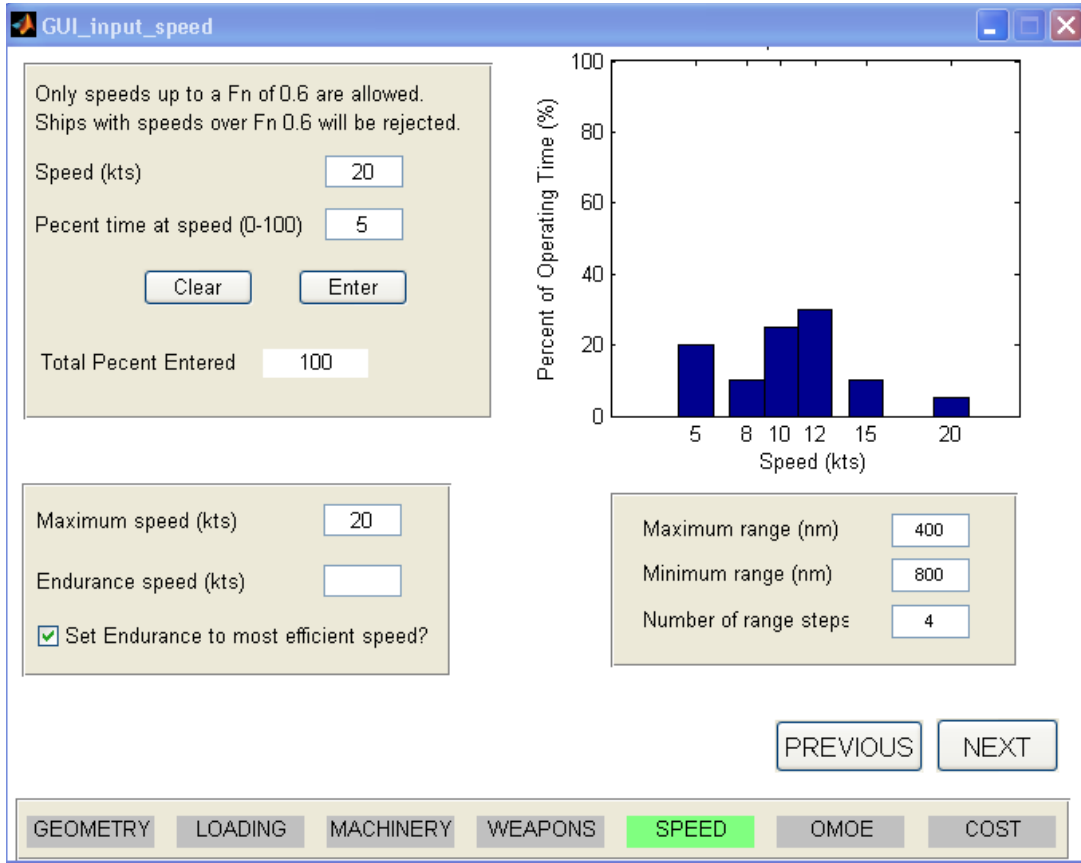

Figure 2-6 Speed Input

The OMOE segment allows the user to vary how performance is calculated. All performance variables are calculated on a linear scale with the threshold being zero and the goal being one. If a value falls below the threshold, it defaults to zero. If a value falls above the goal, it defaults to one. OMOE is divided into three primary groups: Operations, Mobility, and Weapons. The sum of the three primary groups MOE's is typically one. The operations and mobility groups are further sub-divided. Mobility is divided into maximum speed (note this is the actual maximum speed, not the maximum speed entered), the numbers of days the ship can be on patrol, the range of the ship, and the draft of the ship. Operations is divided into main deck space which is the deck area remaining after the weapons are accounted for, in hull space which is the amount of area remaining after the weapons and the prime movers are accounted for, total manning, and sea keeping which is represented by Bale's number (see seakeeping section for more information).

The total MOE of each set of subdivisions usually sums to one. While this is not a requirement, it is a good practice. The OMOE segment allows the user to default goal and threshold values to the minimum (or worst) and maximum (or best) values calculated respectively. Figure 2-7 shows the OMOE input.

The screenshot shows a window titled "GUI\_input\_omoe" with the main heading "User Inputs - OMOE". It is divided into three main sections: MOBILITY, WEAPONS, and OPERATIONS. At the bottom, there is a navigation bar with tabs for GEOMETRY, LOADING, MACHINERY, WEAPONS, SPEED, OMOE (highlighted in green), and COST. Two buttons, "PREVIOUS" and "NEXT", are located to the right of the OPERATIONS section.

MOBILITY				
	Threshold	Goal	MOE	Default
Maximum Speed (kts)	20	25	0.3	<input type="checkbox"/>
Endurance (days)			0	<input checked="" type="checkbox"/>
Range (nm)	400	800	0.5	<input type="checkbox"/>
Draft (ft)			0.2	<input checked="" type="checkbox"/>
Mobility MOE			0.4	

WEAPONS	
Weapons MOE	0.3

OPERATIONS				
	Threshold	Goal	MOE	Default
Main Deck Space (ft^2)			0.25	<input checked="" type="checkbox"/>
In-hull Deck Space (ft^2)			0.25	<input checked="" type="checkbox"/>
Manning (people)	15	25	0.4	<input type="checkbox"/>
Seakeeping			0.1	
Operations MOE			0.3	

Navigation: PREVIOUS, NEXT

Bottom Bar: GEOMETRY, LOADING, MACHINERY, WEAPONS, SPEED, OMOE, COST

Figure 2-7 OMOE Input

The final segment of user input is the cost segment. Accurately calculating the cost of a ship is something that even the ship design experts have a difficult time doing, therefore this program does not attempt to calculate the actual cost, rather it calculates a cost that compares known factors. The user inputs the cost of ordinary strength steel (OSS), AH-32, and AH-36 in \$/LT, cost of the engines in \$/hp, the cost of fuel in \$/lb, the cost of manning in \$/man-year, the expected life of the hull and the percent of time operating the ship is operating. Unlike other sections, the user is provided with default values because it is not expected that the user will have this information available. The cost function is described in more detail in the next chapter.

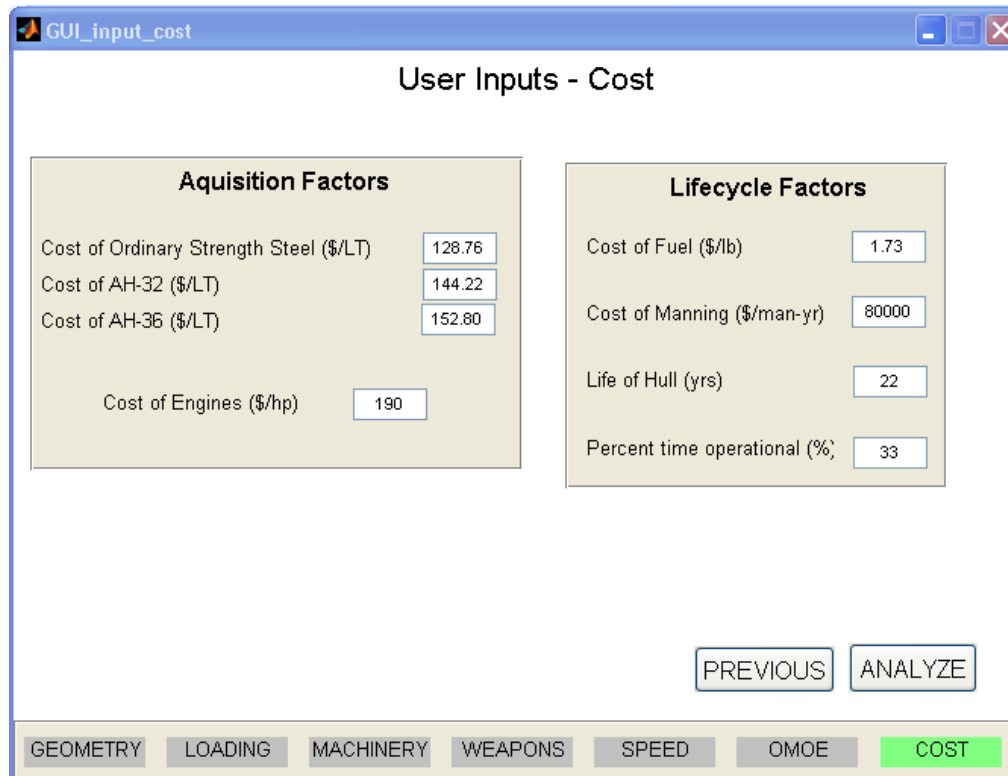

Figure 2-8 Cost Input

### 2.1.2 Generating Variants

The purpose of the generating variants block is *to take the user inputs and generate a set of hulls that completely saturates the user defined design space by assigning each parameter to a particular variant in a variable that can be accessed later*. This is accomplished through nested loops that receive data from the user inputs block such as an array of ship lengths and assigns each length to a different variant. The total number of ships built depends on the number of steps used in the different design variables.

### 2.1.3 Build Variants

After the design variables are assigned to a ship, the next step is to use that information to design the ship. The purpose of the building variants block is *to take the user inputs of each variant and construct a model of the ship by systematically adding components to the model*. This is done one variant at a time. The process for building variants is shown in Figure 2-9. Each of the steps is described in more detail in chapter 3.

The output of the build variants block is either a ship with all its design variables calculated, or a ship that has failed to complete and has an error message. With all the design variables calculated, there is one final check: does the weight of the ship equal the displacement? If it does not, the design waterline is adjusted and the build variant process is restarted at a new draft. If the displacement and the draft are equal (or nearly equal) then the ship has "converged" and final analysis can begin.

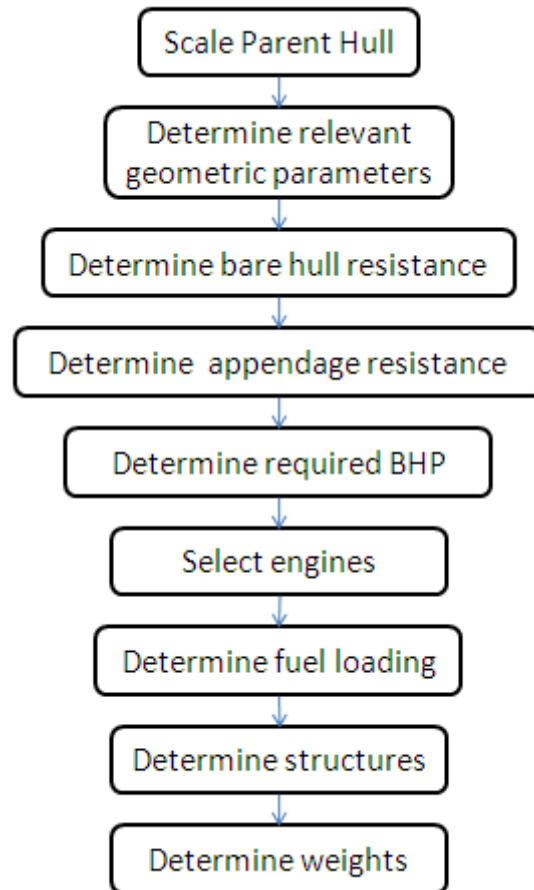

Figure 2-9 Build Variant Process

#### 2.1.4 Final Analysis

After the ship has converged, the final analysis can begin. The final analysis block calculates seakeeping response, life cycle and acquisition cost, and overall effectiveness while rejecting ships that converged to an "unbuildable" variant. Examples of unbuildable variants are ships without adequate internal or external deck space, or ships with a negative metacentric height. The final analysis section also prepares data for use by the display results block.

#### 2.1.5 Display Results

The last block is not one to be overlooked. If the results are not displayed in a manner that is useful to the designer, then PCAT is of little practical value. So the display results block seeks to aid the user in determining areas for future study, as well as areas that are fairly well resolved by showing comparisons of ships both graphically and listing individual ship results.

#### 2.1.6 Completing Another Run

PCAT allows the user to refine their inputs in a second "run" of the program. The results of the first run are not deleted; rather they are kept to allow for comparison with previous results. The

results of both runs are displayed simultaneously to allow the user to determine if the changes resulted in an improvement in the ship design over previous runs.

## 2.2 Data Architecture

In a program designed to run many thousands of ship variants with a few hundred parameters per ship, it is imperative that the data structure be well thought out. Naming of variables must be clear and apparent to allow for future growth of the program. Additionally, the use of global variables must be minimized to keep memory free, though there must be maximum flexibility in the use of variables over numerous functions.

To accomplish these diverse goals, a few key decisions were made. First, there would only be two global variables: the first holding the user inputs (called USER<sup>3</sup>), and the second holding the details of the variants (called HULL). Because there are multiple variants and multiple runs, HULL is a matrix of variables where each variant is represented by an element of hull. The 1<sup>st</sup> dimension of HULL is the variant number while the 2<sup>nd</sup> dimension is the run number. For example HULL(35, 1) refers to the 35<sup>th</sup> variant of the first run.

To keep the naming as clear as possible, structures were used. Matlab describes structures as, "arrays with named data containers' called fields. The fields of a structure can contain any kind of data. For example, one field might contain a text string representing a name, another might contain a scalar representing a billing amount, a third might hold a matrix of medical test results, and so on." The use of generic named data containers allows the storage of strings, such as the name of the parent hull, matrices, and scalars in a single clearly labeled data structure.

For example, the user inputs for the geometry segment are stored in the USER.geometry structure (note that USER is a structure with field geometry which is also a structure). In this way it is clear where the array of possible lengths is stored (USER.geometry.length). HULL is laid out in the same manner. For example HULL(42,2).geometry.depth holds the midships depth for the 42<sup>nd</sup> variant on the 2<sup>nd</sup> run. A detailed description of the two global variables is available in Appendix B.

---

<sup>3</sup> Matlab is a case sensitive code, and in PCAT, HULL and USER are capitalized to bring attention to the global variables. Virtually all of the rest of the variables and fields are in lowercase. To aide a person in editing the code, all variables discussed in this thesis are capitalized in the same way as in PCAT.

### 3.0 Module Creation and Validation

With all of the pieces defined, the next step was to create modules that would build a model of the ship. Each of these modules must be validated to ensure accuracy and then integrated into the program. While the collection of data from the user is not trivial, there is little to describe in the creation or validation process that was not discussed in chapter 2. Therefore this chapter begins with the creation of the variants.

Functions in PCAT are named in a consistent manner to make it easier for a user to improve the code in the future. To ensure the function names are clear, they are marked with italics in this paper. The first executable is *PCAT*, therefore to begin the program the user just types PCAT. The GUIs are divided into two different sections, the GUIs used for receiving data (input) and the GUIs used for displaying data (output). All functions that create GUIs are named *GUI\_input (or output)\_purpose*. For instance the GUI that gathers data on the geometry of the ship is named *GUI\_input\_geometry*. *PCAT\_execute* is the "main function" that creates the models of the hulls. It calls other functions that are named *PCAT\_purpose*. For instance the ship's structure is calculated in *PCAT\_structures*. All of the functions are described in more detail below.

### 3.1 Variant Creation

To create the variants the total number of possible ships is calculated. The user is permitted to allow 14 different variables to take multiple levels: LBP, L/B, L/D, deck height, the parent hull, KG/D, LCG/L, the material used, frame spacing, the number of engines per shaft, the number of shafts, the number of weapon groups, range, and total manning. The number of levels of each of these variables (the length of each array) is multiplied together to get the total number of ships to create. The number of possible ship types can grow very quickly with 14 different variables. Even if each variable only takes on 2 possible values, the total number of possible ships will still be  $2^{14}$  or 16,384. Therefore it is necessary for the user to have a rough idea of the boundaries of the design space before beginning, though functionality was added to aid the user in narrowing the design space while adding granularity to the possible designs through the use of multiple runs.

With the total number of designs known, PCAT then assigns design variables to each variant. This is done with nested loops running over each of the design variables listed above.

Once the hull parameters are set, the shape of the hull will not be changed throughout the program. Therefore, PCAT scales the parent hull before any computations begin. The scaling is done a function called *PCAT\_scale*. There are four dimensions that need to be scaled, the longitudinal offsets, the transverse offsets, the depth offsets, and the initial draft of the hull. The transverse and longitudinal offsets are scaled in the following manner (it is important to note that the functions below are not exact Matlab code in PCAT, but rather just show the process used):

$$\text{offsets.X} = \text{desired\_lbp} * X_o / \max(X_o)$$
$$\text{offsets.Y} = \text{desired\_beam}/2 * Y_o / \max(Y_o)$$

where  $X_0$  and  $Y_0$  are the original X and Y offsets and `offsets.X` and `offsets.Y` are the final offsets. The beam is divided by two because the offsets used in PCAT are half breadths.

Scaling the ships depth is slightly more complicated because it is likely that the ships depth is not maximum at the midsection. To account for this, the depth of the parent hull at midships must be determined. The first step is finding the index of the midsection in the longitudinal array (`offsets.X`). Then, at the ship's midsection, the index of the highest half breadth is found.

```
[temp, mid]=min(abs(X - LBP0/2))           %mid is the index of the midsection

for n=length(Z):-1:1
    if ~isnan(Y(mid, n))                   %this will break when the half breadth exists
        break                               %hence n is the index of the max depth at midships
    end                                     %and Z(n) is the maximum depth
end

Z = input.depth * Z0 / Z(n)               %Z0 is the original Z offsets
t = input.depth * t0 / Z(n)
```

This process is spelled out in detail because it arises many times throughout the course of PCAT. The assignment function and the scaling function were validated by inspection. All of this functionality is done in first half of the function *PCAT\_execute*.

### 3.1.1 Possible Parent Hulls

Two parent hulls were loaded into PCAT, the PC-14 hull and the NPL High Speed Round Bilge Hull. The NPL High Speed Round Bilge hull was designed for operation in the Froude number ( $F_N$ ) range of 0.3 – 1.2. According to Bailey, this hull could be used as a heavily loaded work boat, a fast patrol craft, or a small naval ship. The round bilge of the hull form allows for lower resistance than a flat bottomed planing hull in the semi-displacement region, while still providing more lifting than a typical surface combatant hull. The offsets for the NPL Hull were obtained directly from Bailey's work with the hull (7).

The primary mission of the PC is coastal patrol and interdiction surveillance. These ships also provide full mission support for Navy SEALs and other special operations forces. The PC ships, also known as the cyclone class, provide the U.S. Navy with a fast, reliable platform that can respond to emergent requirements in a low intensity conflict environment(8). The offsets for the PC-14 were taken from a converged ASSET model of the PC-14 created by the U.S. Navy (9).

Additional parent hulls can be easily inserted into PCAT in the *PCAT\_offsets* file. However, the user must also be able to model the hull interaction with the propulsion system to account for changes in resistance and powering due to changing flow around the hull. More information on this topic can be found in the shaft horse power section below.

### 3.2 Variant Geometry

With the variant hull defined, the next step is to determine the applicable geometric parameters for use in other modules later in the program. All geometric parameters were determined using

techniques described in *Principles of Naval Architecture* (10) and *Introduction to Naval Architecture* (11).

Most of the geometrical parameters apply only to the immersed section of the hull, so the first step is to insert interpolated offsets at the current waterline and shorten the waterline array (Z) and the half breadth array (Y) to include offsets only below the water line.

With no bounds on the spacing of the offsets, it would not be wise to attempt to use Simpson's multipliers to integrate sections and areas. Simpson's technique assumes a quadratic shape to find areas. However, for an arbitrary spacing of the offsets, this would be difficult. Therefore the trapezoidal rule was used for integration and interpolation. The trapezoidal rule assumes a linear shape for integration. This allows the offsets to be entered in whatever spacing is available to the user. The trapezoidal rule is used extensively throughout PCAT.

First the section areas are calculated.

$$Section\ area(x) = 2 * \int_{baseline}^{waterline} Half\ breadth(x, z) dz$$

The displaced volume ( $\nabla$ ) is calculated by integrating the section areas.

$$\nabla = \int_{length} Section\ Area(x) dx$$

The displacement ( $\Delta$ ) is then is calculated using a density of sea water (35 LT/ft<sup>3</sup>)

$$\Delta = \nabla * \rho$$

The longitudinal center of buoyancy (LCB) was calculated by integrating the moment of the section areas.

$$LCB = \frac{\int_{length} x * Section\ Area(x) dx}{\nabla}$$

The beam at the water line is simply twice the maximum half breadth of the immersed section. The block coefficient ( $C_b$ ) and prismatic coefficient ( $C_p$ ) are also calculated.

$$C_b = \frac{\nabla}{LBP * draft * beam\ at\ waterline}$$

$$C_p = \frac{\nabla}{LBP * maximum\ submerged\ section\ area}$$

The metacentric height (GM) is an excellent measure of initial static stability. GM is defined as the difference between the height of the metacenter (KM) and the height of the center of gravity

above the keel (KG). KM can be defined as the height of the center of buoyancy above the keel (KB) plus the height of the metacenter above the center of buoyancy (BM).

$$I_{transverse} = \frac{2}{3} \int_{length} (y(x))^3 dx$$

$$BM = \frac{I_{transverse}}{\nabla}$$

To find KB, the moment of areas of the water planes are integrated and divided by the volume.

$$waterplane\ area(z) = 2 \int_{length} y(x, z) dx$$

$$KB = \frac{1}{\nabla} \int_{baseline}^{waterline} z * waterplane\ area(z) dz$$

$$GM = KB + BM - KG$$

The wetted surface area (WSA) is the final variable calculated using the immersed offsets. The WSA is calculated by integrating the length of curves around the hull at a given longitudinal location.

$$length\ of\ curve(x) = \sum_{n=1}^{length(z)} \sqrt{(y(x, n) - y(x, n - 1))^2 + (z(n) - z(n - 1))^2}$$

$$WSA = \int_{length} length\ of\ curve(x) dx$$

The deck area calculations are also calculated in the geometry sections. The main deck area is calculated as the area of the surface that connects the highest offsets at every station. The user specifies the internal decks spacing (dh). The first internal deck is placed dh feet below height of the main deck at midships. All internal decks are parallel with the base line.

$$main\ deck\ area = \sum_{n=1}^{length(x)} \frac{1}{2} (y(n, z_0) + y(n + 1, z_1)) * \sqrt{(x(n + 1) - x(n))^2 + (z(z_1) - z(z_0))^2}$$

Where  $z_0$  is the maximum height at longitudinal point  $n$ , and  $z_1$  is the maximum height at the next longitudinal point.

To validate the geometry code, PCAT was run with only a 100 ft NPL series hull loaded. The actual values in Table 3-1 were gathered directly from the NPL series (7), while the actual values in Table 3-2 were calculated by hand using a quadratic approximation using Simpson's multipliers. The largest difference error is in the calculation of the wetted surface area. This is primarily due to the linearization of the hull around the curved bilge section.

	PCAT	NPL Series	% difference
Displacement (LT)	99.65	97.54	2.16%
Volume (ft <sup>3</sup> )	3487.8	3413.7	2.16%
LCB (ft fwd of midships)	-6.45	-6.4	0.78%
C <sub>b</sub>	0.396	0.397	-0.25%
C <sub>p</sub>	0.690	0.693	-0.43%
WSA (ft <sup>2</sup> )	1252.7	1339.4	6.4%

**Table 3-1 Validation of Geometric Data**

	PCAT	Actual	% difference
Main deck area (ft <sup>2</sup> )	1516.9	1486.3	2.06%

**Table 3-2 Validation of Geometric Data**

The calculation of wetted surface area is performed in the *PCAT\_surf\_area* the remainder of the geometry calculations are performed in *PCAT\_area\_displacement*.

### 3.3 Bare Hull Resistance

The resistance of each variant is required for several different speeds: the maximum speed, the endurance speed, and each speed entered in the speed profile. But if the user requires the endurance speed to be the most efficient speed, the resistance needs to be calculated at various speeds from minimum to maximum. Even if the user does not have this requirement knowing the fuel efficiency of the ship at different speeds is valuable to the user. To calculate all these resistances in a simple way, elements are added to the speed profile array. Recall that the speed profile array has two components, the speeds at which a ship will operate, as well as the percent of time a ship spends at each speed. Therefore speeds are added in 1 knot increments from a Froude number (Fn) of 0.1 to the maximum speed (as long as the maximum speed has a Fn < 0.6). The reason for the Fn requirements will be explained in detail in this section. For every element that is added to the speed array, a 0 is added to the percentage array in the same location. This represents the ship spending 0% of its time at any new speed added. This process occurs in *PCAT\_beefup*.

Froude hypothesized that resistance could be broken down into two basic areas. Frictional resistance which is a function of Reynolds number and residual resistance which encompasses all other resistance terms, primarily wave making resistance and form drag. The frictional resistance coefficient is calculated using the standard 1957 International Towing Tank Convention (ITTC) formula.

$$C_f = \frac{0.075}{\log_{10} R_N - 2}$$

Where the total frictional resistance is:

$$D_f = \frac{1}{2} \rho S U^2 (C_f + C_a)$$

Where S is the wetted surface area in ft<sup>2</sup>, U is the ships speed in ft/s, ρ is the density of water in slugs/ft<sup>3</sup>, and C<sub>a</sub> is the correlation allowance.

Calculation of the residual resistance can be done using several methods. The most accurate method is to build a model and test the hull; however that is impractical for this project. A discussion of possible methods for calculating residual resistance for patrol crafts follows (12)(13).

**Canadian Research Council – Fast Surface Ship** – This method is used to calculate residual resistance for ships operating in the displacement region. High speed slender ships that operate at Froude number below 0.83 are a good fit for this method. This method is based on regression analysis of model test data.

**Hamburg Ship Model Basin** – This method uses Telfer type regression of model data to predict residual resistance for small higher speed ships. This method is good for ships operating up to Froude numbers of 0.83.

**Semi Displacement Double Chine** – This method is based on regression data performed by the National Technical University of Athens on double chine, transom stern, semi displacement hull series. This series is intended for large high speed vehicles operating below Froude numbers of 0.53.

**Semiplaning Transom Stern** - This method is designed for the ships in the displacement and semi-displacement region for Froude numbers up to 0.53. Regression analysis was performed at the U.S. Naval Academy Hydrodynamics Laboratory on various hulls.

**Compton** – This algorithm is designed for typical coastal patrol, training, or recreational powerboat hull forms with transom sterns operating in the displacement or semi displacement regions. This resistance method is good for Froude numbers from 0.1 to 0.6(14).

Compton resistance method was chosen because of its availability, ease of use, and its applicability to vessels designed in PCAT. As with any regression analysis there is a range of values over which the resistance is applicable. Table 3-3 shows the limits of Compton Resistance methods. Any values that fall outside these limits will cause a particular variant to generate an error code and not converge.

	Lower Limit	Upper Limit
Speed (kts)/√LWL	0.35	2.00
$F_{N\sqrt{V}}$	0.3	1.5
$\Delta / (0.01 * LBP)^3$	105	150
LCG/LBP	-0.13	-0.02
LBP/B	4.0	5.2

**Table 3-3 Compton Resistance Bounds**

Where LWL is the length of the waterline and  $F_{NV}$  is the volumetric Froude number.

The residual resistance coefficient calculated using Compton's method is calculated using four constants, A, B, C, and D and several parametrics from the vessel. (14).

$$C_r = \left[ A + B \left( \frac{LBP}{B} \right) + C \left( \frac{\Delta}{(0.01 * LBP)^3} \right) + D \left( LCG * \frac{100}{LBP} \right) \right] * 10^{-3}$$

A, B, C, and D are coefficients derived through Compton's regression analysis. They are all functions of  $F_n$  and the presence (or absence) of a hard chine.

The total resistance ( $D_T$ ) and bare hull horse power (EHP) are calculated as follows.

$$C_T = C_f + C_a + C_r$$

$$D_T = \frac{1}{2} \rho S U^2 (C_T)$$

$$EHP_{BH}(U) = U * D_T(U)$$

Where S is the wetted surface area in  $ft^2$ , U is the ships speed in ft/s, and  $\rho$  is the density of water in slugs/ $ft^3$ . To validate the resistance subroutine, two methods were used. First the results were compared to Compton's results. Additionally, the results were compared to Maxsurf's Hull Speed module which has the ability to calculate residual resistance using Compton's method. The hull used was a 108 ft YP, the same hull as in reference (14).

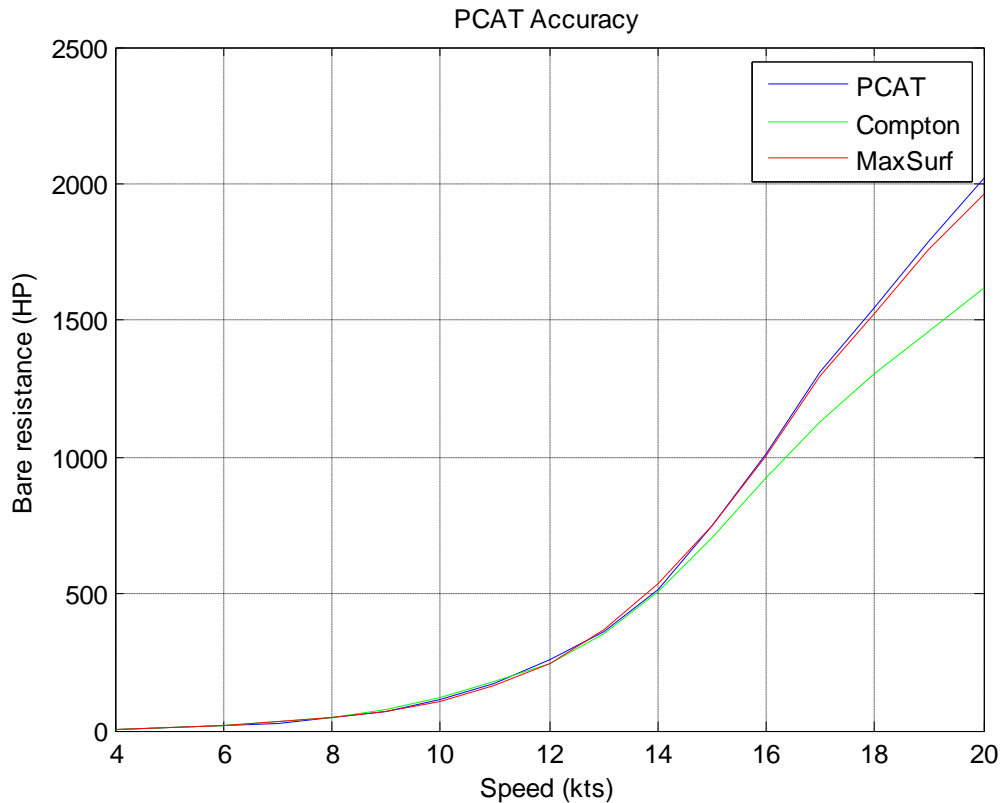

Figure 3-1 Accuracy of PCAT Resistance

The results from this routine were not incredibly pleasing. The three resistances should be virtually identical with very small differences possibly due to slightly different values for viscosity and density of the water. The unaccounted for variation in the bare hull resistances remains unresolved, however, the error between Maxsurf's Hull Speed module and PCAT is within 9% for all speeds, and within 5% for speeds where the resistance is significant. Additionally PCAT slightly overestimates the resistance at high speeds. If there is an error, it will be conservative at the design speeds. The resistance is calculated in *PCAT\_resistance*.

### 3.4 Appendage Resistance

Adding in the resistance of the appendages is the next step. Although there is little logic in it, appendage resistance is typically added as a percentage of bare hull resistance (15). This implies that the resistance of an appendage behind a high resistance ship is more than the resistance of an appendage behind a low resistance ship. A second method for calculating resistance suggested by Holtrop and Mennen calculates the appendage resistance based on their wetted surface area using the afore mentioned 1957 ITTC formula frictional resistance formula. The two methods are in reasonable agreement with one another, therefore the appendage resistance is calculated as a percentage of total resistance. The factors used ( $F_x$ ) are shown in Table 3-4.

Appendage	Fraction of Total Resistance
Twin Rudders	0.015
Twin bossing	0.10
Shaft brackets and open shafts	0.06

Table 3-4 Appendage Resistance Factors

The appendage resistance of the ship is given by

$$R_{appendage} = R_{BH} * (F_{rudders} + F_{bossings} + F_{shaft})$$

The appendage resistance is calculated in *PCAT\_appendage*.

### 3.5 Shaft Horse Power

Converting the resistance and power of a bare hull (with increased resistance for appendages) to a break horse power (BHP) is a non-trivial exercise. Changes in flow around the hull, losses due to power transmission, and power conversion all factor into BHP (16). The BHP required is calculated in *PCAT\_bhp*.

#### 3.5.1 Wake Factor and Thrust Deduction Factor

The thrust deduction factor (t) is fractional difference in the thrust generated by a ship and the resistance of the same ship.

$$t = \frac{kT - R}{kT}$$

Where k is the number of propellers, R is the ships resistance at a given speed and T is the thrust generated at that speed.

The wake factor accounts for the difference in the ships speed and the inflow to the propeller.

$$w = \frac{V_s - V_a}{V_s}$$

Where  $V_s$  is the ship velocity and  $V_a$  is the inflow to the propeller. Together they account for the differences between the testing of a model hull and a propeller separately in open water and integrating them into one unit. The hull efficiency ( $\eta_H$ ) is defined as the power required to move a ship at a certain speed ( $R * V_s$ ) divided by the propulsive power generated ( $k * T * V_a$ ).

$$\eta_H = \frac{R * V_s}{k * T * V_a} = \frac{1 - t}{1 - w}$$

This factor often is near or even exceeds unity. The hull efficiency is different for every hull. Therefore if the user inputs an additional hull, they must also determine the hull efficiency of that hull in different conditions.

### 3.5.2 Propeller Efficiency

A propeller delivers power in the form of torque ( $Q$ ) and a rotational speed ( $2\pi*n$ ). So the open water efficiency ( $\eta_o$ ) of a ship is defined as the power delivered ( $T*V_a$ ) over the power available ( $2\pi*Q*n$ ). This value typically falls between 0.3 and 0.7.

$$\eta_o = \frac{T * V_a}{2\pi * Q * n}$$

However the actual torque generated ( $M$ ) differs from the torque generated in a free stream. This difference is captured in the relative rotation coefficient ( $\eta_r$ ). Typical values for  $\eta_r$  fall between 0.98 and 1.02.

$$\eta_r = \frac{Q}{M}$$

### 3.5.3 Efficiencies for Given Hulls

The wake factor and thrust deduction factor for the PC hull were taken from the ASSET values. Both are assigned values of 0. The relative rotation coefficient is also taken from the ASSET model of the PC and is assigned a value of 1. The open water efficiency of the propeller is assigned a value of 0.65 based on Woud and Stapersma (16).

The hull efficiency and the relative rotation efficiency of the NPL series hull are provided by Bailey in reference (7). Bailey gives the two efficiencies as a function of  $\tilde{M}$ , the Froude length constant and  $Fn$ .

$$\tilde{M} = LBP / \left( \Delta * \frac{2240 \text{ lbf}}{1LT} \frac{s^2}{32.2 \text{ ft}} \frac{ft^3}{1.990 \text{ slugs}} \right)^{1/3}$$

The curves for  $P$  (which is  $\eta_H * \eta_R$ ) without a wedge from were used from Bailey and linearly interpolated in two dimensions,  $\tilde{M}$  and  $Fn$ . Similar to the PC, the open water efficiency is given a value of 0.65 for the NPL series hull.

### 3.5.4 Shaft and Gearbox Efficiencies

The final step in calculating the BHP of an engine is calculating the shaft and gear box losses. Shaft losses are typically 0.5% to 1% of total power per shaft. Gear box losses are typically 1% to 2% for simple reduction gears, but can be as high as 3% to 5% for more complex reduction gears.

For PCAT, the shaft efficiency was assigned a value of 99.25% per shaft (0.75% loss). The gear box efficiency was set to 97% for two engines per shaft, and 98.5% for one engine per shaft (16).

The total BHP needed by all the engines is given by

$$BHP = \frac{EHP}{\eta_H \eta_r \eta_o \eta_{shaft} \eta_{GB}}$$

### 3.6 Engine Selection

With the total load known for the engines, the engines can be selected. To simplify the selection process, it is assumed that all propulsion engines onboard the ship will be the same type. In reality it is likely that if there are two engines per shaft, one will be a cruise engine, and the second, a larger engine to achieve maximum speed. However, most ships of this size analyzed by PCAT only have one engine per shaft, so the simplification does not have that large an impact.

The smallest engine is selected from the engine library that meets the propulsion requirements of the ship. The engine library is contained in Appendix C.

### 3.7 Fuel Loading and Efficiency

With the engines selected and the resistance profile known, the total amount of fuel needed to reach a certain range can be calculated as well as the fuel efficiency at all the speeds.

To do this the engines on board the ship are loaded in one knot increments. Starting from the lowest speed, one engine is brought on line. When the BHP required to meet a new speed exceeds the power available of a single engine, an engine from another shaft is brought online. This continues until there is one engine on each shaft. If more than one engine exists per shaft, then the pairs of engines are brought online on each shaft next until the required BHP is met. This continues until the maximum speed is achieved.

At each speed the fuel consumption of the propulsion engines is calculated using the SFC.

$$\begin{aligned} \text{Propulsion Fuel Consumption Rate } \left( \frac{\text{lbs}}{\text{hr}} \right) \\ = SFC(\text{at given RPM}) \left( \frac{\text{lbs}}{\text{hp-hr}} \right) * BHP(\text{at same RPM})(\text{hp}) \end{aligned}$$

In this way the propulsion fuel consumption rate is a function of speed. However there is another component of fuel efficiency, the fuel used to power the electrical system. Because the calculation of the total power load is difficult when many of the systems remain undefined, all variants are assigned the same electrical generators; two Caterpillar 3412 diesel generators providing 400kW each. It is assumed that each variant can cruise on 400kW, the second generator is provided for battle conditions and as a spare for cruising. The electrical generator uses 32.5 gph (17) when at full load. Assuming a density of fuel of 7.35 lbf/gal, the electrical generator uses 53.95 lbf/hr of fuel.

To get the total fuel efficiency the propulsion fuel consumption rate is added to the electrical fuel consumption rate to get the total fuel consumption rate. Note that the fuel efficiency and the fuel consumption rate are both functions of speed.

$$\text{Fuel Efficiency} \left( \frac{\text{nm}}{\text{LT}} \right) = \frac{2240 \text{ lbf}}{\text{LT}} \frac{1}{\text{Fuel Consumption Rate} \left( \frac{\text{lbf}}{\text{hr}} \right)} \text{Speed} \left( \frac{\text{nm}}{\text{hr}} \right)$$

At low speeds the propulsion engine uses very little fuel, but the ship moves very slowly, so the hotel loads supplied by the electrical generator use a significant amount of fuel per nm. At high speeds the resistance of the ship increases more than cubically. Therefore it is expected that the most fuel efficient speed be low in the speed range, but not at minimum speed. A typical fuel efficiency curve is shown in Figure 3-2.

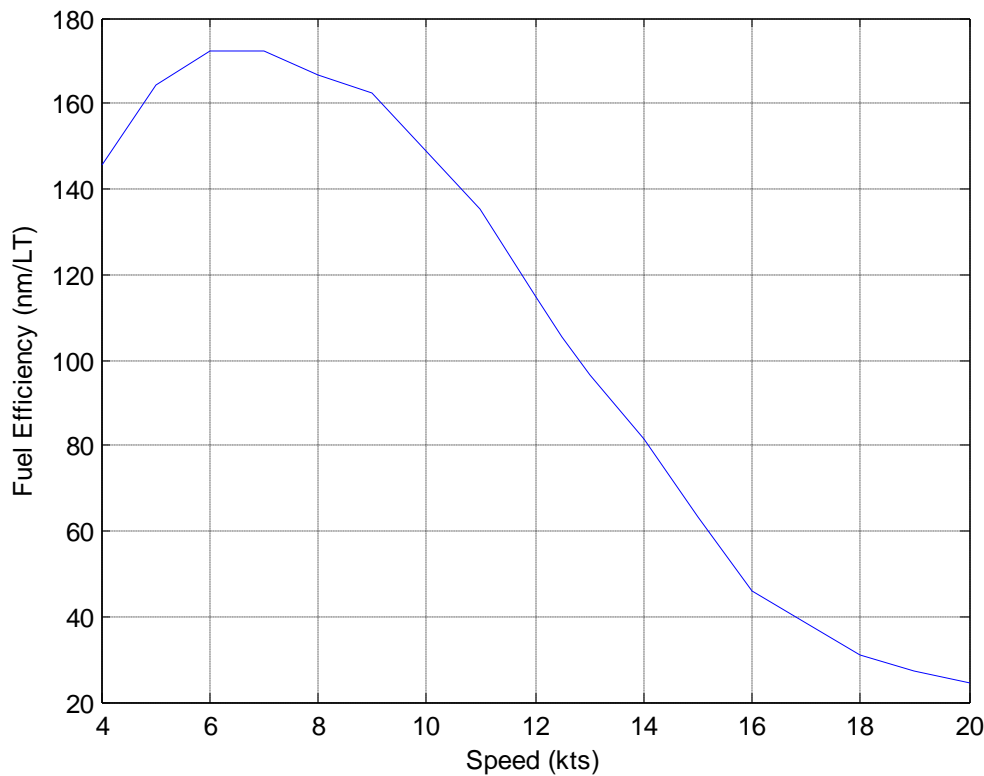

Figure 3-2 Typical Fuel Efficiency

If the user chose to default the endurance speed to the most fuel efficient speed, the endurance speed is chosen as the speed associated with the maximum fuel efficiency.

DDS 200-1, *Endurance Fuel Calculation*(18), was used as the standard for calculating the required fuel loading for the PCAT. The procedure is very similar to what has been done already with the exception of a few additional factors.

- Tailpipe allowance of 0.95 to 0.98 to account for the unavailable fuel remaining in the tank below the tailpipes. (0.95 is used for PCAT).
- Increase in endurance fuel rate by 5% to account for plant deterioration.

DDS 200-1 gives the fuel required to reach a certain range. However, the data sheet assumes that all the fuel is used, which is not realistic for operational purposes. While it is understood in the Navy that the fuel required (or range calculated) is not an accurate value, but rather just a number for comparison, that is not plausible or desirable for this program. Therefore an additional factor of 1.5 is used to ensure the ship can reach the design range with 33% of fuel remaining. The weight of fuel needed is calculated as follows.

$$Fuel\ Weight\ (LT) = \frac{Range(nm) * 1.05}{Efficiency\ or\ endurance\ speed\ \left(\frac{nm}{LT}\right) * 0.95} * 1.5$$

All of the fuel efficiency and loading calculations are performed in the *PCAT\_fuel* function.

### 3.8 Structures

The calculations of the structures of a variant are performed using the ABS rules for steel vessels < 90m in length. Applicable sections of the ABS rules can be found in Appendix A. In general the ABS rules require each piece to have either a certain thickness (such as deck plating) or a certain section modulus (such as hull girders). For this level of design the following pieces were designed.

- Bottom shell plating
- Side shell plating
- Main deck plating
- Internal deck plating
- Bottom framing
- Bottom girders
- Side Girders
- Side Framing

These pieces were then modeled to determine the overall moment of inertia and section modulus of a section, as well as the weight of the material in the structures weight group.

Several assumptions had to be made to adequately model a particular variant. Some ships use one material for the hull and a second, stronger material for decks or lighter material high in a ship to lower KG. However in PCAT, every variant only uses a single material. For a small hull, bending is not a major structural concern. Therefore, the necessity of strengthening certain sections is diminished, making it reasonable to assume that the hull will be made of a uniform material. Additionally, every frame, girder, and stiffener is a similarly shaped t-beam. This is also a reasonable assumption because t-beams have a high section modulus for the amount of material used.

Each t-beam is shaped as shown in Figure 3-3 with  $x$  being the "critical dimension" of the t-beam. With the section modulus of each frame, girder, or stringer limited to one degree of freedom and the required section modulus of each piece given by the ABS rules, each piece can be sized appropriately.

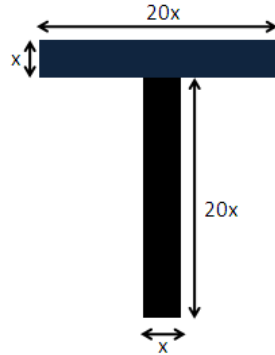

Figure 3-3 Sample t-beam

Calculating the section modulus of a beam requires first knowing the second moment of area, or moment of inertia ( $I_y$ ) as well as the location of the neutral axis. The neutral axis ( $\bar{z}$ ) is defined as the center of area(19).

$$I_y = \int z^2 dA$$

$$\bar{z} = \frac{\int z dA}{A}$$

For this particular t-beam,  $I_y$  and  $\bar{z}$  are defined as:

$$\bar{z} = 15.25x$$

$$I_y = \frac{10625}{6}x^4$$

The section modulus is defined as the  $I_y/c$  where  $c$  is the distance from the extreme fiber to the neutral axis. There are always two section moduli; the section modulus for the upper portion and the section modulus for the lower portion. Because the section modulus (SM) for the lower portion is the limiting case, that is the one used in PCAT. The SM for the t beam is given by:

$$SM = 116.12x^3$$

But ABS gives formulas for the section modulus. What is needed is the critical dimension,  $x$ .

$$x = \sqrt[3]{\frac{SM}{116.12}}$$

Now given a required section modulus from ABS, the size and bending rigidity of each piece is known.

ABS requires minimum section moduli and thicknesses for each piece and each section of hull and deck plating, but there is also a minimum section modulus for the entire section. With the scantlings of each piece known the total moment of inertia of the midsection can be calculated to verify that the variant has enough strength to withstand bending. This is done in 4 steps.

1. The sum of the area of all the pieces is calculated.
2. The sum of the moment of area of all the pieces is calculated.
3. The moment of inertia of each piece about the ships base line is calculated.
4. The total moment of inertia is shifted to the neutral axis.

To complete step 3, each object's moment of inertia has to be calculated about their own horizontal neutral axis. However many of the object have rotated because they are placed on the hull. Therefore the moment of inertia must be transformed.

$$I_{y\_new} = \frac{I_y + I_z}{2} - \frac{I_y - I_z}{2} \cos(2\theta)$$

Where  $\theta$  is the angle of rotation and  $I_z$  for the t-beam is the moment of inertia of the t-beam about the vertical plane.

$$I_z = \int y^2 dA = \frac{2005}{3} x^4$$

To complete steps 3 and 4 the parallel axis theorem must be used. The parallel axis theorem states that the moment of inertia for an object about an arbitrary axis is the moment of inertia of the same object about its own neutral axis added to the square of the distance between the neutral axis and the new axis times the area.

$$I_{baseline} = I_y + d^2 A$$

In step 3 the moment of inertia is shifted away from a piece's neural axis to the base line, so the  $d^2 A$  term is added. In step 4 however, the moment of inertia is shifted toward the section's neutral axis, so the  $d^2 A$  term is subtracted.

The final section modulus of the midsection is compared to the minimum section modulus. If the calculated section modulus is insufficient, all the scantlings are increased in 1% increments until the section modulus of the section is met.

The final calculation done in *PCAT\_structures* is the weight of the material used to make the hull. This will feed directly into the weight module. The weight of the material is calculated by finding the weight of the material at each section, and then numerically integrating the section weights along the length of the ship to get the total weight. This is added to the weight of the

transverse framing to get the total structure weight. Note that this does not include some of the structural weight such as the transverse bulkheads and the machinery foundations.

To validate the structures calculations, a midsection was built in POSSE's section modulus editor to match the one generated in *PCAT\_structures*. Table 3-5 shows the comparison between the POSSE parameters and the PCAT parameters.

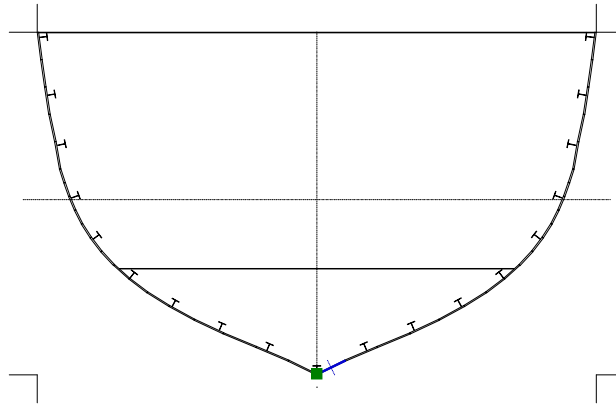

Figure 3-4 Midsection from POSSE

Parameter	POSSE	PCAT	Difference
Area (ft <sup>2</sup> )	2.9	2.9	0%
I (in <sup>4</sup> )	1.16*10 <sup>6</sup>	1.17*10 <sup>6</sup>	0.73%
SM (top) (in <sup>3</sup> )	1.52*10 <sup>4</sup>	1.53*10 <sup>4</sup>	0.67%
SM (bottom) (in <sup>3</sup> )	1.45*10 <sup>4</sup>	1.37*10 <sup>4</sup>	5.2%
NA(in)	85.68	85.53	0.18%

Table 3-5 Structural Validation

### 3.9 Weights

The weights in a ship are broken down into seven groups (called SWBS groups) for lightship and the variable load. The seven groups are shown in Table 3-6.

Group	Description
SWBS 100	Major Hull Structure: shell plating, bulkheads framing, decks, etc.
SWBS 200	Propulsion: Engines, shafting, lube oil
SWBS 300	Electric plant: engines, generators, distribution, switchboards, lighting
SWBS 400	Command and Surveillance: navigation, communication, radars, etc.
SWBS 500	Auxiliaries: freshwater, air systems, HVAC
SWBS 600	Outfit and furnishings: crew berthing, officer spaces, passenger spaces, etc.
SWBS 700	Armament: weapons, ammunition, missiles
Variable Load	Variable load items: Fuel, stores

Table 3-6 Weight Group Descriptions

So far in PCAT only two weight items have been calculated, the fuel loading and most of the structural weight. The rest of the weights need to be estimated using the weights of a similar

craft. The craft chosen as the baseline for ratios is the PC-14. All of the weights not previously calculated were estimated in accordance with the method put forth by the Society of Allied Weight Engineers (SAWE) (20). All weights are either a ratio of weights from the PC or a function of some parameter generated by PCAT such as manning or shaft horse power.

There are two areas where the changes were made to SAWE procedures. First, because the user input all items for SWBS 400 and 700, they are never separated. All group 400 and 700 items are stored under SWBS 400. Additionally, because very little of the electric system is modeled, the SWBS 300 weights are assumed to be a ratio of the power of the generators.

### 3.10 Balancing

With the weights of a variant known the next step is checking the balance of the weight of the ship and the displacement at the design draft. If the displacement and the draft are not within 1% of each other, the draft must be adjusted so the displacement more closely matches the weight. In general one of three cases can occur.

1. The variant's weight and displacement agree within 1%. If this occurs, the variant is complete and the final cost seakeeping and performance analysis can occur.
2. The variant's weight and displacement are not within 1%, but there is still adequate free board. If this occurs, two adjustments must be made to the variant. First the draft is set to a new level as shown below.

$$draft_{new} = draft_{old} * \left( 1 + 0.4 \frac{weight - \Delta}{\Delta} \right)$$

This is an empirical formula that was arrived at through trial and error. It essentially adjusts the draft as a function of the percent difference between the weight and the displacement. Because the engine sizes are not continuous, it is very important to increase the draft slowly so as ensure the smallest engine possible is used to power the variant. Increasing the draft too quickly could cause an unnecessary increase in resistance and hence an unnecessary step increase in weight due to skipping to the next larger engine. The minimum freeboard at midships is set to 4% of ships length.

While the vertical and transverse offsets do not need to be adjusted, the longitudinal offsets need to be moved so that the zero point is at the forward perpendicular. Figure 3-5 shows the offsets for a nominal hull. Figure 3-6 is the offsets for the same after being adjusted for having a weight that is more than the displacement. It is important to notice that while the size of the hull does not change, the LBP does. So the final LBP will many times not be the original value entered by the user, but the Overall length of the ship will not change.

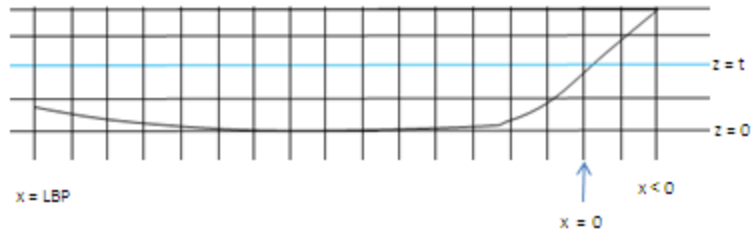

Figure 3-5 Original Offsets

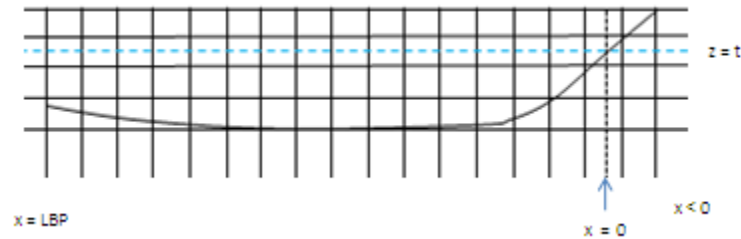

Figure 3-6 Adjusted Offsets

3. The final possibility is there is no longer adequate free board. If this occurs, the variant generates an error code and no further calculations will be performed on that variant.

The calculations for balancing are performed in *PCAT\_adjustoffsets* and *PCAT\_execute*.

### 3.11 Seakeeping

The seakeeping of a vessel is something so necessary that it cannot be overlooked, but so complex that it is difficult to calculate and capture in an early stage design program such as PCAT. The standard method for calculating the response of a vessel in a sea is to use linear strip theory to generate a transfer function for the vessel and apply the transfer function to the power spectrum of the waves at a given heading and speed. The sea state, heading, and speed of the vessel can all be altered to obtain an idea of how the ship performs in various scenarios. The responses in heave, pitch, and roll can be evaluated and combined to find a measure of the ship's dynamic stability in a sea (21).

However, this method is too complicated for a project of this size. Instead, a measure of the seakeeping of the vessel was calculated using Bales method (22). Bales performed a regression analysis on destroyer type hull forms in an attempt to optimize the hull form early in the design process. The fundamental premise of Bales method is that "a meaningful, comparative index of overall seakeeping performance could be defined and thence quantitatively related to a small number of conventional hull parameters."

Six parameters were selected for the Bales model. They are:

- Waterplane coefficient forward of amidships ( $C_{WF}$ )
- Waterplane coefficient aft of amidships ( $C_{WA}$ )
- Draft to length ratio (T/L)

- Cut up ratio ( $c/L$ ) where  $c$  is the distance from the forward perpendicular to the cut up point.
- Vertical prismatic coefficient forward of midships ( $C_{VPF}$ )
- Vertical prismatic coefficient aft of midships ( $C_{VPA}$ )

The "Bales estimator" can then be written as

$$R = a_0 + a_1 C_{WF} + a_2 C_{WP} + a_3 \frac{T}{L} + a_4 \frac{c}{L} + a_5 C_{VPF} + a_6 C_{VPA}$$

where  $a_i$  is solved for as part of the regression analysis. With the constants solved for and the variables broken down into measures of hull geometry, the Bales estimator can be written

$$R = 8.422 + 45.104 \left( \frac{2A_{WF}}{LB} \right) + 10.078 \left( \frac{2A_{WA}}{LB} \right) - 378.465 \left( \frac{T}{L} \right) + 1.273 \left( \frac{c}{L} \right) - 23.501 \left( \frac{\nabla_F}{A_{WFT}} \right) - 15.875 \left( \frac{\nabla_A}{A_{WAT}} \right)$$

The limits of the original analysis are shown below, but PCAT does allow extrapolation.

$$117.8 < \frac{L}{\mu} < 135.8 \text{ m}$$

$$12.68 < \frac{B}{\mu} < 14.98 \text{ m}$$

$$4.05 < \frac{T}{\mu} < 5.14 \text{ m}$$

$$\mu = \left( \frac{\nabla}{4300} \right)^{1/3}$$

The Bales estimator is calculated in *PCAT\_seakeeping*.

### 3.12 Cost

PCAT calculates two different costs, the acquisition cost and the lifecycle cost. Because cost estimating is something that is very difficult to do even when a ship is designed in great detail, the cost estimates in PCAT have been greatly simplified. **They do not represent an actual acquisition or lifecycle cost but rather a relative cost used only as a comparison to other PCAT variants.**

The acquisition cost is the sum of the weapons cost, which is entered by the user, the material cost, and the engine cost. The user inputs the cost of an engine in \$/hp. According to Caterpillar

Inc. sales representatives a good thumb rule to use for engine cost is 190\$/hp<sup>4</sup>. The material weight is also input by the user. The default values are taken from MITTAL's price (23) list for extras such as ABS certification and AH-32, and the general cost of steel of \$45.75 per CWT. An exchange rate of 1 euro = \$1.5689 was used to convert MITTAL's list to dollars.

The life cycle cost is the acquisition cost plus the manning cost and the fuel cost. The manning cost is simply a product of the hull life of the variant, the manning level, and the cost per man-year. A default value of \$80,000 per man year is used. The fuel cost is calculated by multiplying the SFC of an engine at a given horsepower times the BHP, time the percent of time the ship is operating at that speed. This result (lbs/hr) is then converted into (lbs/yr) and multiplied by the percent of time the ship is operational, the life of the hull in years, and the cost of fuel in (\$/lb).

$$Fuel\ Cost = \sum_n (SFC_n BHP_n Percent_n) \frac{24hrs}{day} \frac{365days}{yr} (\% \text{ time operational}) \\ * (Life\ of\ Hull) * (Cost\ of\ Fuel)$$

Where the index represents the number of elements in the speed profile array, and Percent<sub>n</sub> is the percentage of time the ship spends at speed n. Table 3-7 shows the default cost values used in PCAT. All default values can be adjusted by the user in the input GUIs. The cost calculations are performed in *PCAT\_cost\_lc* (lifecycle cost) and *PCAT\_cost\_aq* (acquisition cost).

Item	Default Cost
Ordinary Strength Steel (\$/LT)	1153.56
High Strength Steel, AH-32 (\$/LT)	1169.02
High Strength Steel, AH-36 (\$/LT)	1177.60
Engine Cost (\$/hp)	190
Fuel (\$/lb)	1.73
Manning (\$/man-year)	80000

Table 3-7 Default Costs

### 3.13 Performance

The performance of each variant is calculated using the overall measure of effectiveness (OMOE) input by the user. The OMOE is broken down into three primary MOEs: operations, mobility, and weapons. Each of the primary levels is assigned a weight of importance, with the sum of the primary weights equaling unity.

Mobility and operations MOEs are then broken down into secondary measures. Mobility is a function of maximum speed, endurance, range, and draft. Each of these secondary MOEs is also assigned a weight by the user and the sum of the mobility weights is also unity. Operations is a function of main deck area, in-hull area, manning and seakeeping. The operations weights are

<sup>4</sup> e-mail from Mr. Kevin Hampson, Marine Engine Business Manager, Caterpillar Inc., to LT Andrew Gillespy, dtd 15 January 2007

assigned in the same manner as the mobility weights. The weapons MOE is assigned by the user and is not broken down to a second level.

Each secondary MOE is given a value based on the user inputs and PCAT calculations. The user either specifies the threshold and goal values, or the threshold is set at the worst value of a particular parameter and goal is set at the best. The threshold value for a given parameter is given a MOE of zero. The goal is given a value of one. All values in between are linearly interpolated between 0 and 1 as shown in Figure 3-7.

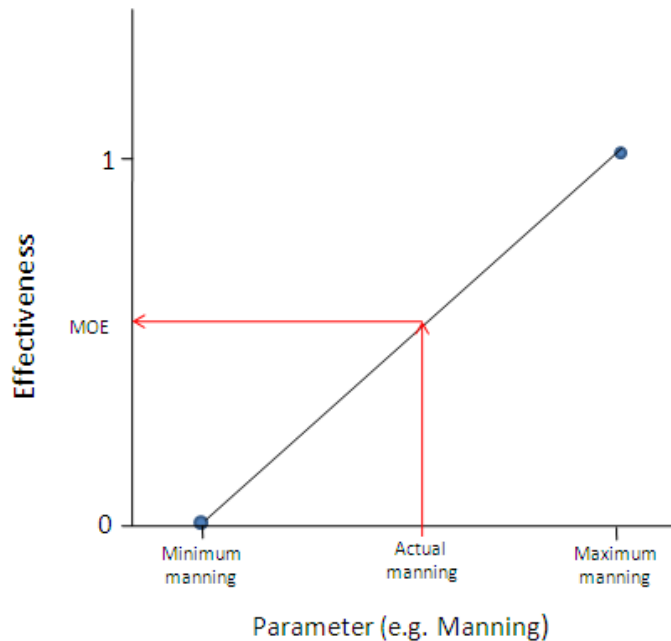

Figure 3-7 Example MOE

The total operation MOE is then:

$$MOE_{OPS} = W_{IHAREA}MOE_{IHAREA} + W_{MDAREA}MOE_{MDAREA} + W_{MAN}MOE_{MAN} + W_{SEA}MOE_{SEA}$$

Where W represents the user assigned weighting value. The mobility MOE is calculated in the same way. The overall MOE is then

$$OMOE = W_{OPS}MOE_{OPS} + W_{MOBILITY}MOE_{MOBILITY} + W_{WEPS}MOE_{WEPS}$$

### 3.14 Rejection Criteria

Ships can be rejected for many different reasons. In each case the rejection will generate an error code so the user will know why the rejection occurred. The list below is all of the reasons a ship may be rejected

- Froude number mismatch – One of the major limitations of PCAT is the range over which resistance can be calculated. If the Froude number of the maximum speed, the endurance speed (if not set to default) or any of the speeds in the speed profile are less

than 0.1 or greater than 0.6, the program will not converge on a final design for that variant, and an error code will be generated.

- Inadequate area – If the main deck area is less than the area required for the weapons, or the internal area is less than the area required for the weapons and the prime movers, the program will not converge on a final design for that variant, and an error code will be generated.
- Negative GM – If the GM for a particular variant is negative, the program will not converge on a final design for that variant, and an error code will be generated.
- Unable to converge – If there is a significant mismatch between the weight and the displacement of the ship and the freeboard at midships is reduced to less than 4% of the overall length, the program will not converge on a final design for that variant, and an error code will be generated.

## 4.0 Using PCAT

This chapter describes the process for one particular example of PCAT. The results were analyzed and refined to find a more optimal variant.

### 4.1 Inputs

User inputs for the first run are shown below.

#### Geometry

- Length can take values of 90, 100, or 110 ft.
- L/B can be 4.5 or 5.206.
- L/D can be 7.0, 7.5, or 8.148.
- Both the NPL High Speed Round Bilge and the PC-14 hulls are allowed.
- Deck height is set to be 9 ft.

#### Loading

- KG/D is set a 0.6.
- The LCG is set to default.
- The only material allowed is ordinary strength steel.
- The frame spacing is set to 5'.

#### Machinery

- Only 1 engine per shaft is allowed.
- Each ship will have 2 shafts.

#### Speed

- The maximum speed is set to 20 kts.
- The endurance speed is set to default.
- The range can either be 700 or 800 nm.
- The speed profile is [5 kts-20% 10 kts-35% 12.5 kts-25% 15 kts-15% 20kts-5%]

Weapons – The three weapons profiles are shown in Table 4-1.

ID	Weight (LT)	DH area (ft <sup>2</sup> )	IH area (ft <sup>2</sup> )	Power (kW)	KG/D	WMOE	Cost (k\$)
Low	5	100	300	100	1	0.4	1000
Med	8	150	300	120	1	0.6	2000
High	12	200	400	170	1	0.9	3000

Table 4-1 Input Parameters for Weapons

Manning – 15 men on board with 13.3% officer, 13.3% CPO, and 73.3% enlisted.

Cost – All the cost values were left at their default values.

OMOE – All the secondary MOEs goal and threshold values were left to default. The weights for all the MOEs are:

- Maximum speed - 0.25
- Endurance - 0.25
- range - 0.25
- Draft - 0.25
- Main deck area - 0.30
- In-hull area - 0.30
- Manning - 0.20
- Seakeeping - 0.20
- Operations - 0.40
- Mobility - 0.40
- Weapons - 0.20

## 4.2 First Run Outputs

After PCAT has designed all the variants, the main output screen arises as shown in Figure 4-1. The create Rhino function is not yet functional, but the capability can be added without much difficulty. The first place a user needs to click is on the sensitivity analysis. This will allow the user to see all of the converged designs in many different formats.

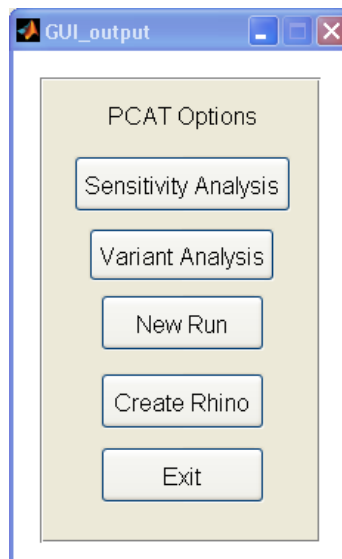
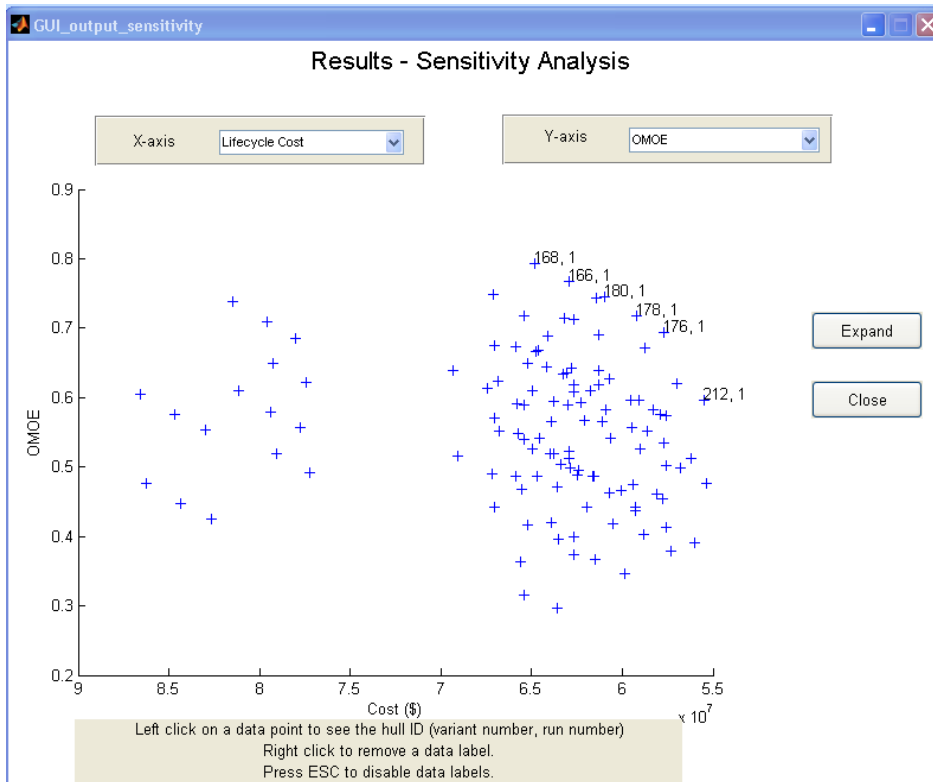
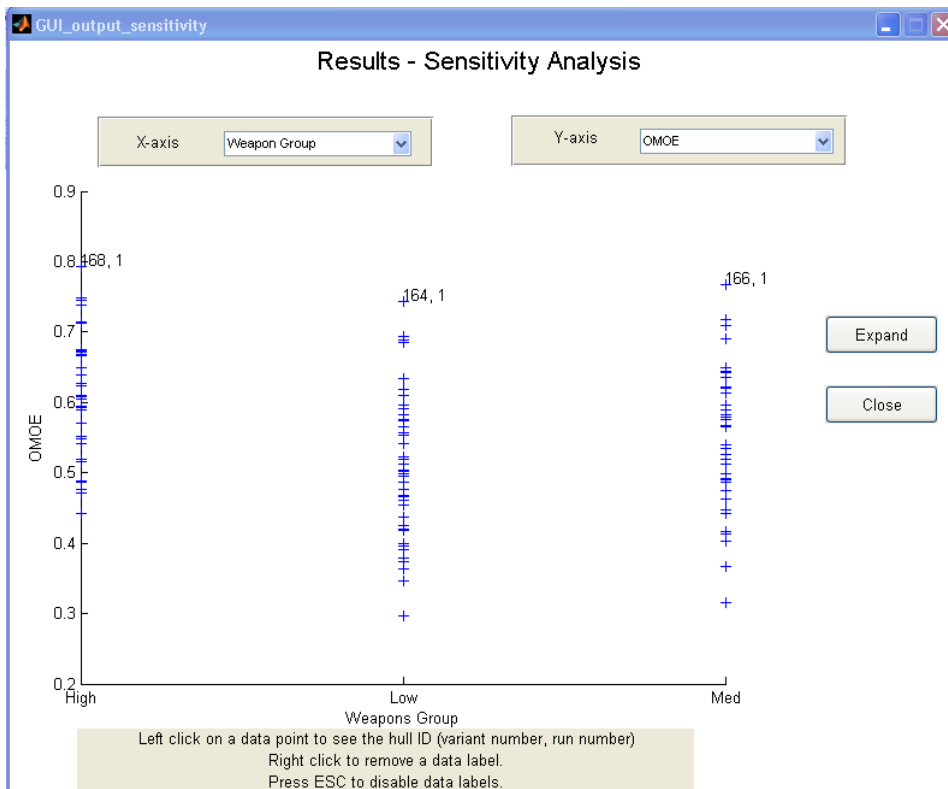

Figure 4-1 Main Output Screen

At the sensitivity analysis screen, the user can place lifecycle cost, acquisition cost, or any input parameter on the x axis. The y axis can be populated with any output parameter. **Error! Reference source not found.** through Figure 4-5 show a few sample sensitivity graphs.



**Figure 4-2 Lifecycle Cost vs. OMOE**



**Figure 4-3 Weapon Group vs. OMOE**

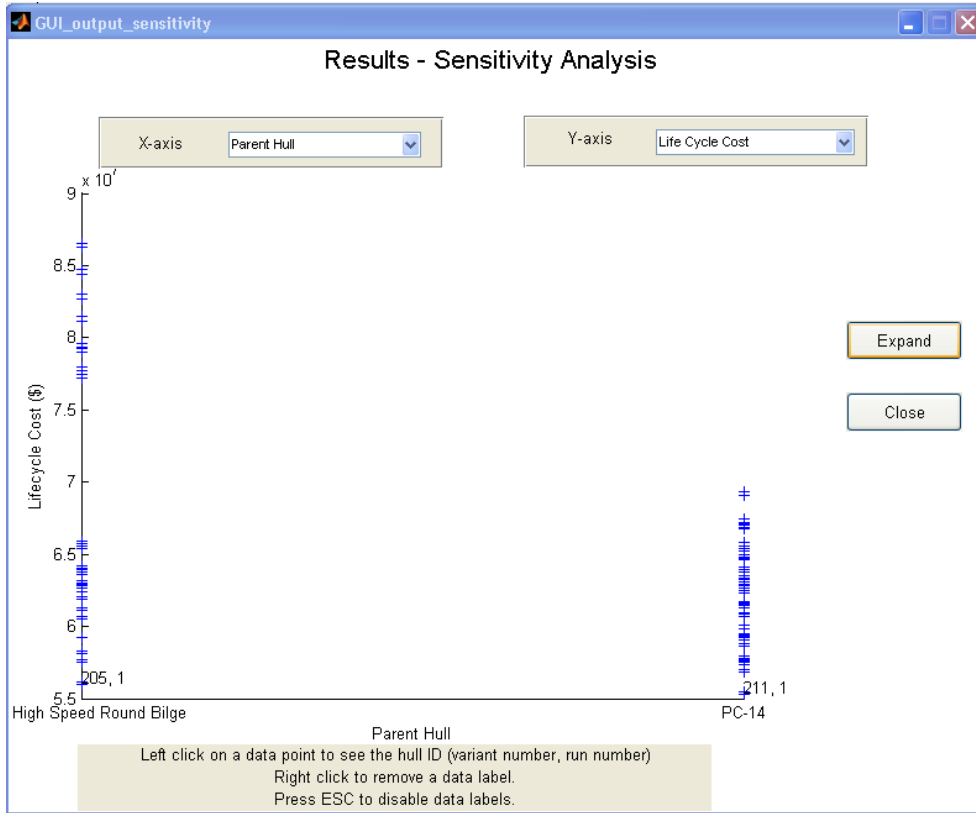

**Figure 4-4 Parent Hull vs. Lifecycle Cost**

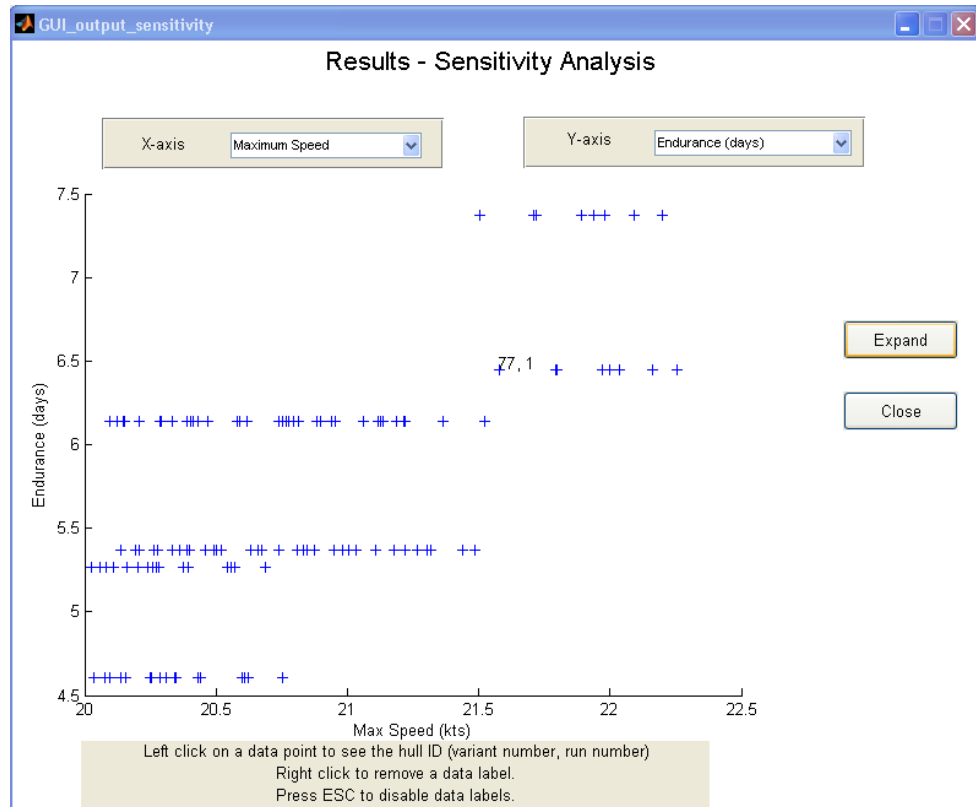

**Figure 4-5 Maximum Speed vs. Endurance**

On each sensitivity graph the user can click on a data point to get the identification of the particular variant. This information is then taken to the next output screen, variant analysis. On variant analysis, the user can get data on a particular variant. Reports include:

- Summary: Geometry
- Summary: Machinery
- Summary: Speed, Range, and Manning
- Summary: Loading, Weapons, and Cost
- Body Plan
- Weight Report
- Operating Profile
- Powering Curves
- Structures Graphical
- Structures Summary
- OMOE

```
**** GEOMETRY SUMMARY FOR VARIANT 164, RUN 1 ****  
  
Length overall - 117.2 ft  
Maximum beam - 24.4 ft  
Maximum depth - 14.7 ft  
Full load draft - 8.2 ft  
Length between perpendiculars (LBP)- 110.8 ft  
Displacement - 276.7 LT  
Parent hull - PC-14  
Block coefficient (Cb) - 0.440  
Prismatic coefficient (Cp) - 0.688  
Deck height - 9.0 ft  
Main deck area - 2511.9 ft^2  
In hull area - 1875.5 ft^2  
Wetted surface area - 2778.0 ft^2  
Metacentric height (GM) - 5.1 ft  
Height of the metacenter (KM) - 13.9 ft  
Bales number (Seakeeping) - -2.6
```

**Figure 4-6 Geometry Summary**

\*\*\*\*\* SPEED, RANGE, and MANNING SUMMARY FOR VARIANT 164, RUN 1 \*\*\*\*\*

Maximum speed 21.2 kts  
Endurance speed 6.0 kts  
Endurance time 6.1 days  
Range - 800.0 nm  
Fuel load required to meet range (with 50% margin) - 8.7 LT

Total manning 15  
Officer manning 2  
CPO manning 2  
Enlisted manning 11

**Figure 4-7 Speed, Range, and Manning Summary**

\*\*\*\*\* MACHINERY SUMMARY FOR VARIANT 164, RUN 1 \*\*\*\*\*

There are 2 Caterpillar 3516C-3386 engines on this hull  
Number of engines per shaft - 1  
Number of shafts - 2  
Maximum speed - 21.2 kts

\*\*\* ENGINE SPECIFICS \*\*\*

Length - 10.57 ft  
Width - 7.32 ft  
Height - 6.78 ft  
Weight - 8.15 LT  
BHP - 3386 hp  
Maximum RPM - 1800 RPM  
Full load fuel usage - 159.8 GPH  
Full load s.f.c. - 0.33 lbs/(hp-hr)  
Full load torque - 9880 ft-lbs

**Figure 4-8 Machinery Summary**

\*\*\*\*\* LOADING, WEAPONS, AND COST SUMMARY FOR VARIANT 164, RUN 1 \*\*\*\*\*

The material used for this hull was Ordinary Strength Steel  
Frame spacing = 5.0 ft  
Longitudinal center of gravity -0.06 (% of LBP fwd of midships)  
Height of center of gravity (KG) = 8.8 ft

The ID of the weapons group was Low

Cost of OSS = 1153.6 \$/LT  
Cost of AH32 = 1169.0 \$/LT  
Cost of AH36 = 1177.6 \$/LT  
Cost of engines = 190.0 \$/hp  
Cost of manning = 80000 \$/man-yr  
Cost of fuel = 1.730 \$/lb  
Percent of time operational = 33.0%  
Life of the ship = 22.0 years  
Total acquisition cost of the ship = \$ 2.5 M  
Total lifecycle cost of the ship = \$61.5 M

Figure 4-9 Loading Weapons, and Cost Summary

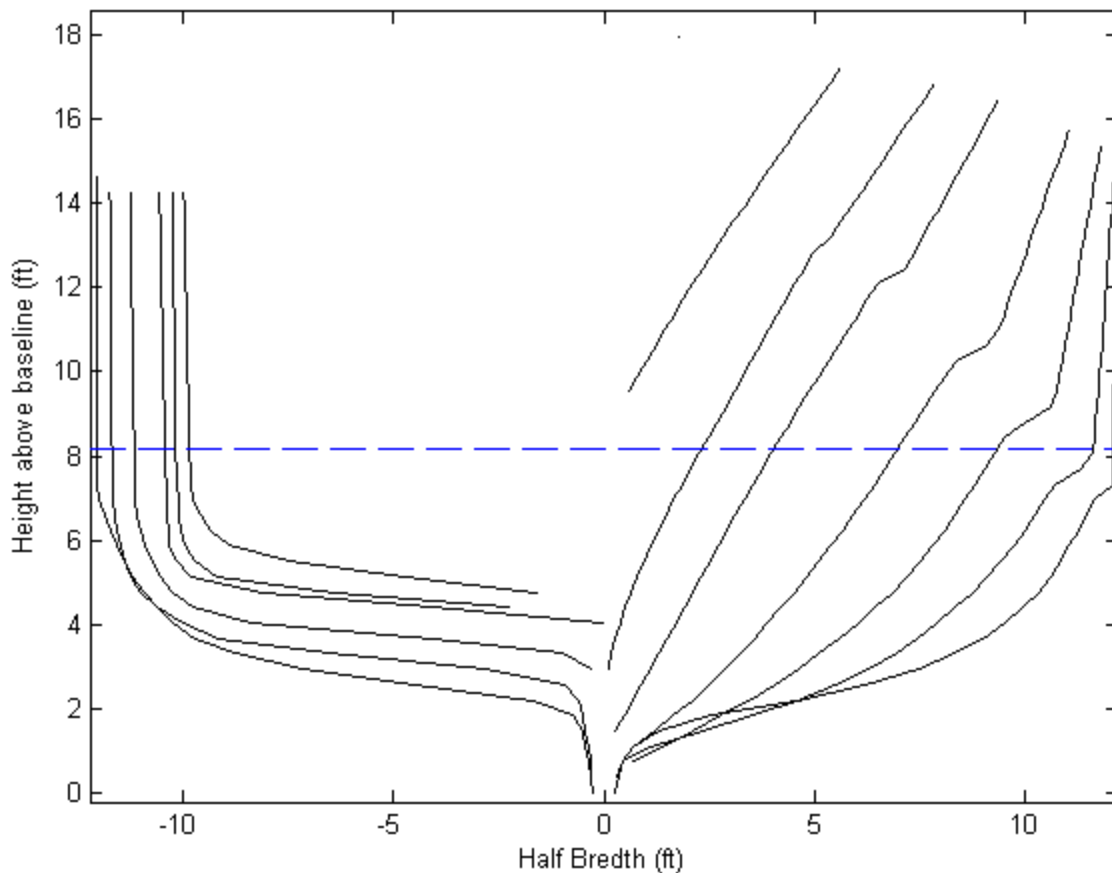

Figure 4-10 Body Plan

Weights are in LT

W100	146.8	HULL STRUCTURES
W200	30.7	PROPULSION PLANT
W300	26.9	ELECTRIC PLANT, GENERAL
W400	5.0	COMMAND+SURVEILLANCE
W500	29.8	AUXILIARY SYSTEMS, GENERAL
W600	18.1	OUTFIT+FURNISHING, GENERAL
WF41	22.2	DIESEL FUEL MARINE

TOTAL FULL LOAD WEIGHT 279.5 LT

Note that SWBS W400 is input by the user and incorporates W400 and W700 and other variable loads

Figure 4-11 Weight Report

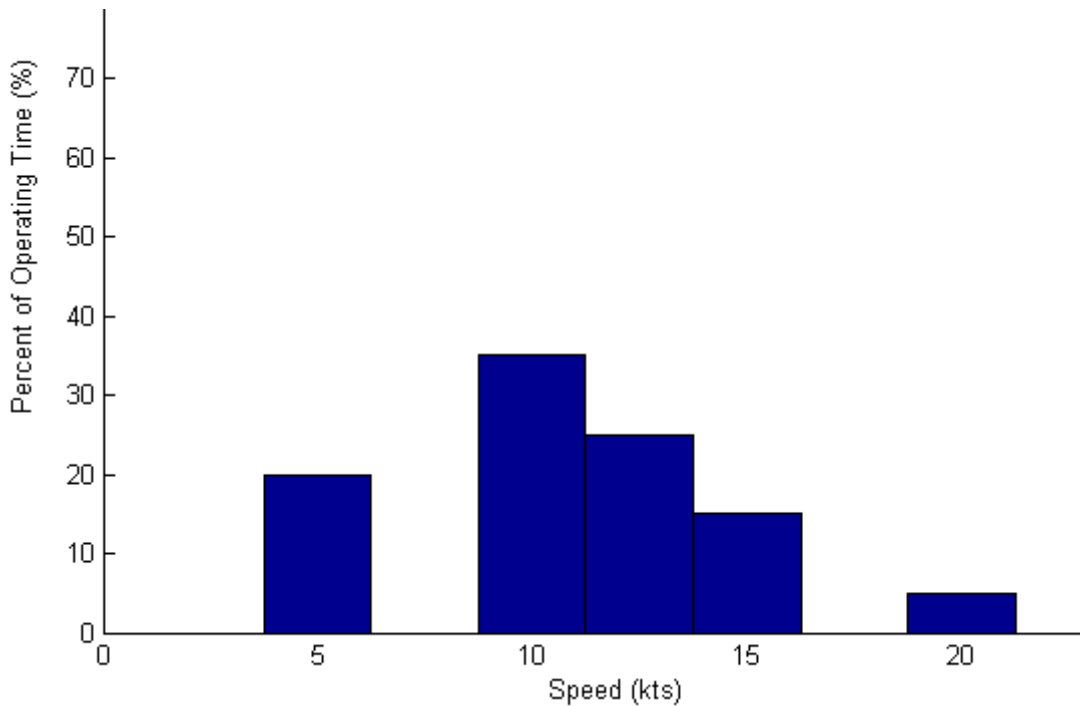

Figure 4-12 Speed Profile

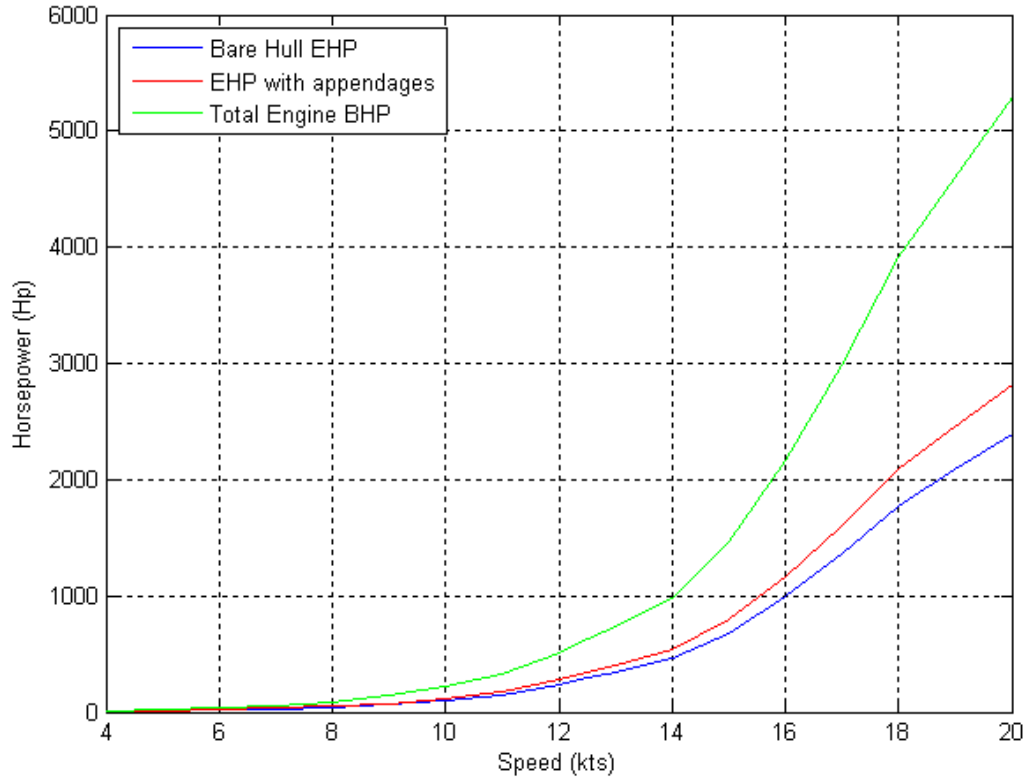

Figure 4-13 Powering Curves

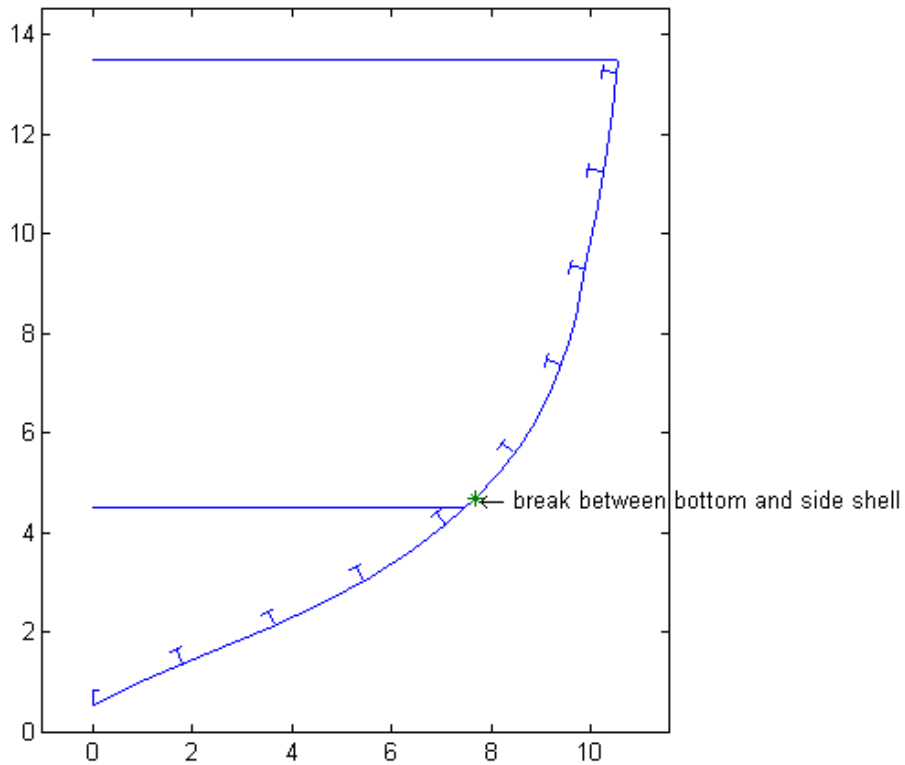

Figure 4-14 Structures Graphical

\*\*\*\* STRUCTURES SUMMARY FOR VARIANT 205, RUN 1 \*\*\*\*

Minimum section modulus - 1145 ft-in<sup>2</sup>

Bottom shell plating thickness - 0.579 in

Side shell plating thickness near midships - 0.693 in

Side shell plating thickness near ends - 0.601 in

Bottom girder critical thickness - 0.175 in

Bottom frame critical thickness - 0.340 in

Side stringer critical thickness - 0.180 in

Side frame critical thickness - 0.628 in

Main Deck thickness - 0.280 in

Internal deck thickness - 0.265 in

The midships neutral axis is located 7.1 ft above baseline

Figure 4-15 Structures Summary

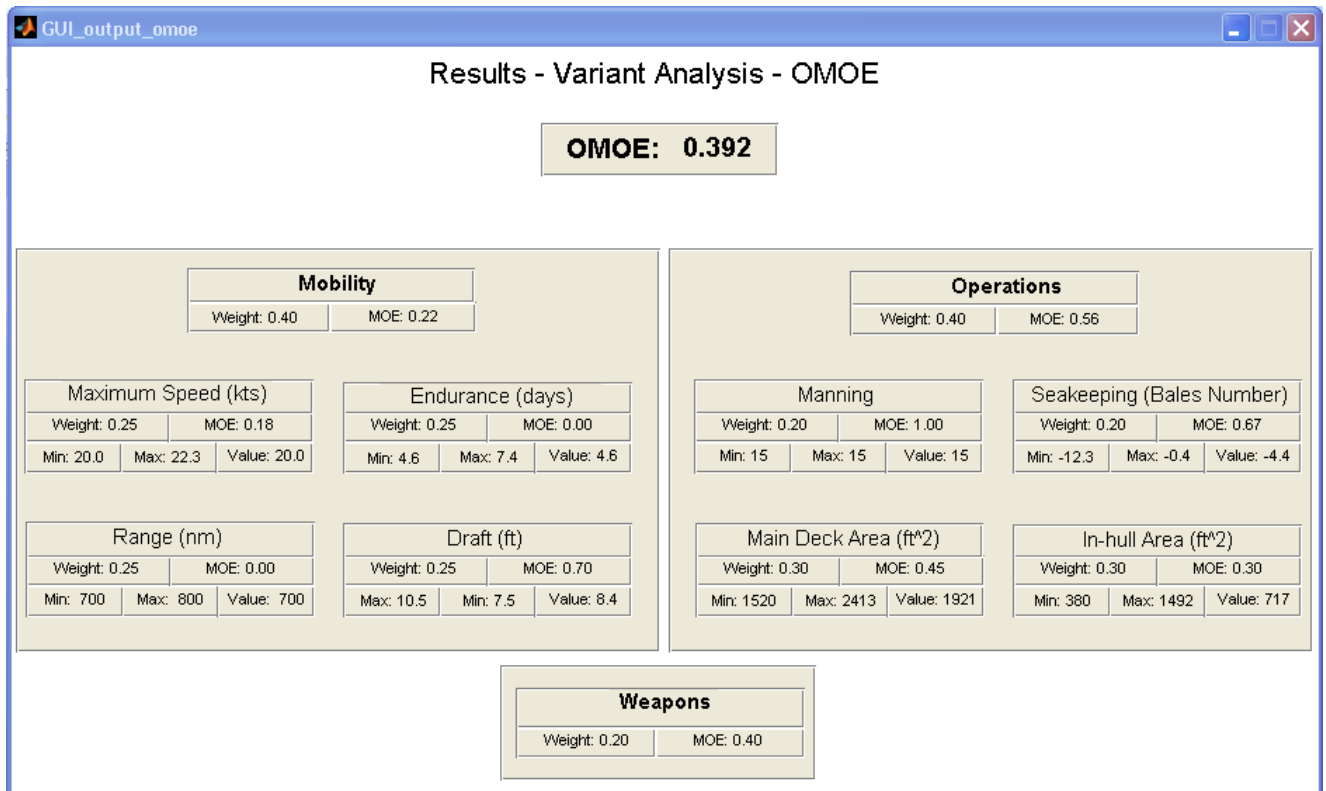

Figure 4-16 OMOE

In the variant analysis section, the user gathers data on the high performing variants, and looks for trends that might show the user how better to refine the inputs. Ten variants were analyzed from the first run (150, 164, 166, 168, 176, 178, 180, 205, 211, 212).

Several facts were noted.

- All had a high range of 800 nm
- 80% of the variants were the PC-14. The two non PC-14 variants were selected as the least expensive NPL and the highest performing NPL.
- 80% of the variants were 110' in length.
- No variant had the smallest L/D value.
- 70% of variants had an L/B of 4.5.
- All weapon groups were represented relatively equally.

### 4.3 Second Run Results

With the design space better understood, the input parameters were reassigned to try and optimize the design. It is clear that the longer ship performs better, so the length was increased. Additionally, for the particular OMOE and costs given, the PC-14 was a higher performing hull, therefore the NPL hull was eliminated as a potential hull form. The lowest value of L/D was eliminated as was the highest value of L/B. Additionally, the lower range value was eliminated. Table 4-2 shows the parameters that were changed

	Original Values	New Values
Length (ft)	90, 100, 110	110, 115, 120, 125, 130
L/B	4.5, 5.206	4.5
L/D	7.0, 7.5, 8.148	7.5, 8.148
Hull Type	NPL, PC-14	PC-14
Range (nm)	700, 800	800

**Table 4-2 Changes for Second Run Inputs**

These values were used to optimize the performance and cost of a variant. The second run results are shown in Figure 4-17 with the second run results in green and the first run results in blue. The second run results show moderate improvement in the design, but just as important, it shows that the design space can be constrained allowing more significant analysis to be performed in a narrow design space. The variants eliminated are dominated designs and should not be analyzed in future runs. The user can perform up to eight runs on one set of design parameters, each time refining the design in an attempt to optimize the ship.

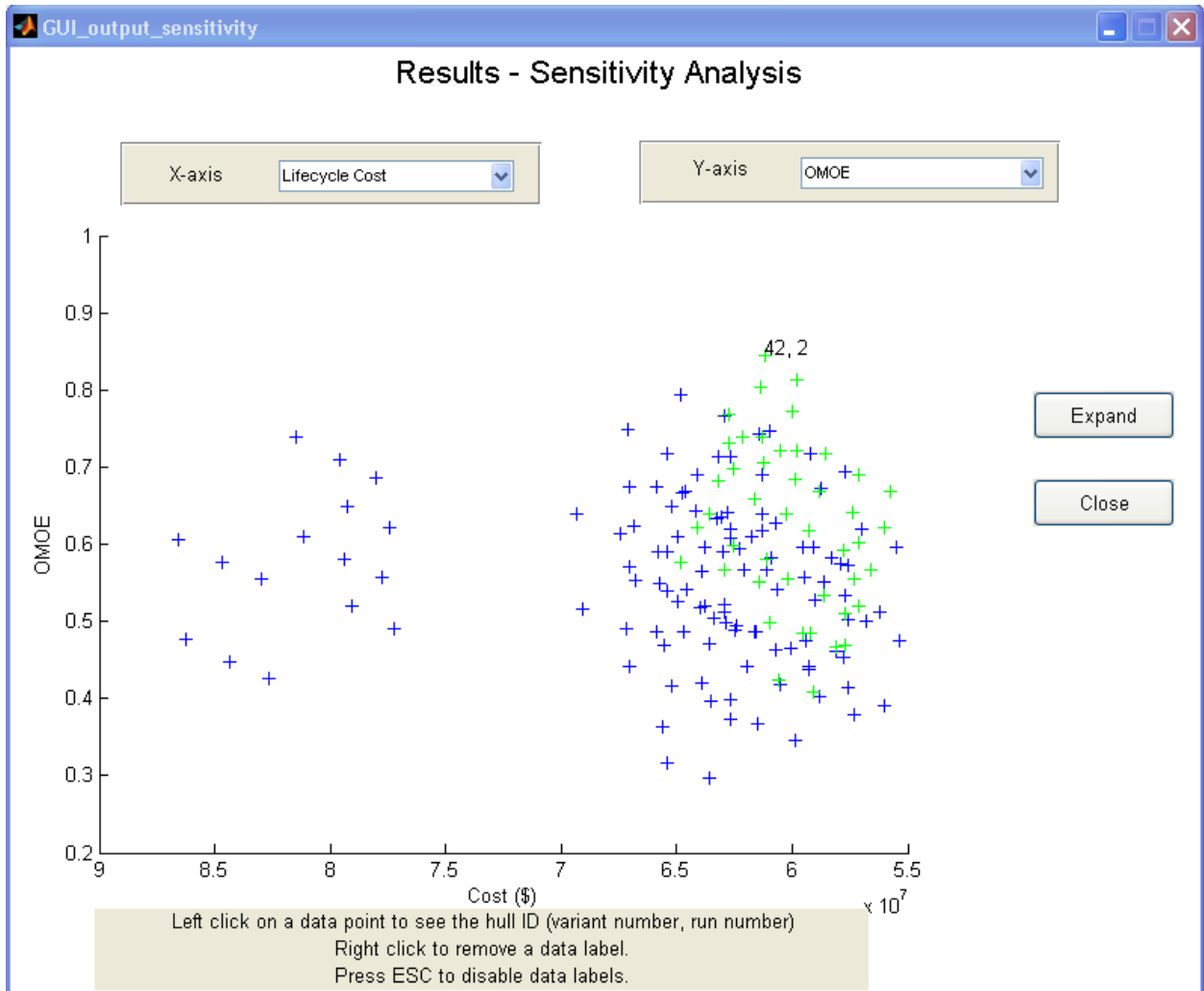

**Figure 4-17 Second Run Results**

## 5.0 Conclusion

The goal of PCAT was:

*To aide ship designers in the early stage design of patrol craft of < 200 feet that operate in the displacement or semi-displacement regions by incorporating all major hull systems and design variables into a program that requires no manipulation of data by the user and displays results that aide the designer in making design decisions and assessing potential engineering tradeoffs in a timely manner.*

For the most part this goal was met, though there are several areas in which PCAT could be improved.

### 5.1 Areas for Future Work

There are four areas in which PCAT is shows promise for more accuracy, and more robust results: resistance calculation, seakeeping performance, propeller design, and optimization. The Compton resistance method used in PCAT is adequate, but it is limited by the scope of the original hulls analyzed. Using a more robust program such as SWAN or allowing the user to pick from several different methods of calculating residual resistance could provide a more accurate resistance over a broader range of design variables.

Bales seakeeping estimator is also adequate, but rather rudimentary. It is difficult to assess motion of vessel in six degrees of freedom and then to incorporate those motions into a value that adequately describes a vessel's seakeeping performance. Bale's attempt to do so is thought provoking and does provide some value, but a more robust analysis could provide more information to the user and aide in making a ship that better meets the needs of the customer. SWAN or other linear strip theory programs such as Maxsurf provide excellent seakeeping analysis, however more information such as mass moments of inertia for the entire ship has to be calculated in order to perform seakeeping.

Additionally, there is an opportunity to refine the propeller design. The assumption of a 65% open water efficiency propeller is adequate, but with some work, a propeller design could be developed an optimized for each variant, providing a more realistic efficiency, size, and weight.

The final area where PCAT can be improved is optimization. This is the one area where the program falls short of reaching its stated goal. The user is required to determine the parameters that make the ship best and incorporate those parameters into a subsequent run of PCAT. Essentially, the user is looking for similar traits from high performing ships and attempting to combine them in such a way as to produce even better ships. Using genetic algorithms to analyze the results would aid the user in determining the optimum variant in a shorter period of time. At the very least, design of experiments could be used to better determine the design variables that have the most impact on the ship.

## **5.2 Final Thoughts**

It would be naive to say that PCAT could produce "the" optimum hull. PCAT is not robust enough to perform the detailed analysis necessary for truly optimizing an object as complex as a ship. However PCAT can aide a designer in quickly narrowing the design space, and determining which variables are meaningful and require more study. This is a significant advantage and tools such as PCAT could be developed for use in future naval vessel design.

## 6.0 Works Cited

1. **Formation Design Systems.** Formation Design Systems - Maxsurf. *Formation Design Systems*. [Online] [Cited: April 2, 2008.] <http://www.formsys.com/maxsurf/products>.
2. Program of Ship Salvage Engineering (POSSE). [Online] Naval Sea Systems Command. [Cited: April 2, 2008.] <http://www.dcfp.navy.mil/software/posse.htm>.
3. MonoSC. NAVSEA - Carderock Division - ASSET. [Online] NAVSEA, January 30, 2006. [Cited: April 2, 2008.] <http://www.dt.navy.mil/asset/shi-typ-pro/sc/index.html>.
4. **Ulrich, Karl T. and Eppinger, Steven D.** *Product Design and Development*. 3. New York : McGraw-Hill/Irwin, 2004.
5. **Maier, Mark M and Rehtin, Eberhardt.** *The Art of Systems Architecting*. New York : CRC Press, 2002. 0-8493-0440-7.
6. **American Bureau of Shipping.** *ABS Rules for Materials and Welding 2008, Part 2*. Houston : American Bureau of Shipping, 2007.
7. **Bailey, D.** *Maritime Technology Monograph No. 4: The NPL High Speed Round Bilge Displacement Hull Series*. s.l. : The Royal Institute of Naval Architects, 1976.
8. PC-1 Cyclone class Patrol Coastal Boats. *FAS Military Analysis Network*. [Online] May 09, 2000. [Cited: April 18, 2008.] <http://www.fas.org/man/dod-101/sys/ship/pc-1.htm>.
9. **Carderock Division, Naval Surface Warfare Center.** *PC-14 file*. [Advanced Surface Ship Evaluation Tool] Bethesda, VA : Carderock Division, Naval Surface Warfare Center, 2008.
10. **Lewis, Edward V., [ed.].** *Principles of Naval Architecture*. Jersey City : The Society of Naval Architects and Marine Engineers, 1988. Vol. 1.
11. **Gillme, Thomas C. and Johnson, Bruce.** *Introduction to Naval Architecture*. Annapolis : Naval Institute Press, 1982. 0-87021-318-0.
12. **Naval Surface Warfare Center, Carderock Division.** *Residual Resistance*. [ASSET help file] Bethesda Maryland : Naval Sea Systems Command , 2006.
13. **Formation Design Systems.** *Hull Speed Users Manual*. [PDF] s.l. : Formation Design Systems, 2004.
14. *Resistance of a Systematic Series of Semi-planing Transom-Stern Hulls.* **Compton, Roger H.** 4, s.l. : Society of Naval Architects and Marine Engineers, 1986, Marine Technology , Vol. 23.
15. **Watson, D.G.M.** *Practical Ship Design*. New York : Elsevier, 1998. 0 08 0429998.
16. **Woud, Hans and Stapersma, Douwe.** *Design of Propulsion and Electric Power Generation Systems*. London : The Institute of Marine Engineering, Science and Technology, 2003. 1-902536-47-9.
17. **Caterpillar.** Marine Wizard. [Online] 2001. [Cited: January 17, 2008.] <http://marinewizard.catmms.com/catwizards/marineWizard/jsp/main.jsp..>
18. **Naval Sea Systems Command.** Calculation of Surface Ship Endurance Fuel Requirements, DDS 200-1. *Data Design Sheet*. s.l. : Department of the Navy, 1982.
19. **Shames, Irving and Pitarresi, James.** *Introduction to Solid Mechanics*. New Delhi : Prentice Hall of India, 2003. 81-203-2218-5.
20. *Marine Vehicle Weight Engineering* . Los Angeles : Society of Allied Weight Engineers, Inc., 2007.
21. **Llyod, A.R.J.M.** *Seakeeping: Ship Behavior in Rough Weather*. Chichester : Ellis Horwood, 1981. 0 9532634 0 1.

22. *Optomizing the Seakeeping Performance of Destroyer Type Hulls*. **Bales, Nathan K.** [ed.] Takao Inui. Tokyo: The Shipbuilding Research Association of Japan, 1980. Thirteen Symposium on Naval Hydrodynmaics.
23. **MITTAL**. MITTAL Plate Extra List. [Online] January 09, 2006. [Cited: January 28, 2008.] [http://www.arcelormittal.com/fce/repository/Price%20lists/Mittal\\_Plate\\_list\\_DEF8.pdf](http://www.arcelormittal.com/fce/repository/Price%20lists/Mittal_Plate_list_DEF8.pdf).

## APPENDIX A – ABS Standards for vessels < 90m in length

# 3

## CHAPTER 1 General

### SECTION 1 Definitions

#### 1 Application

The following definitions apply throughout these Rules.

#### 3 Length

##### 3.1 Scantling Length ( $L$ )

$L$  is the distance in meters (feet) on the summer load line from the fore side of the stem to the centerline of the rudder stock. For use with the Rules,  $L$  is not to be less than 96% and need not be greater than 97% of the length on the summer load line. The forward end of  $L$  is to coincide with the fore side of the stem on the waterline on which  $L$  is measured.

##### 3.3 Freeboard Length ( $L_f$ )

$L_f$  is the distance in meters (feet) on a waterline at 85% of the least molded depth measured from the top of the keel from the fore side of the stem to the centerline of the rudder stock or 96% of the length on that waterline, whichever is greater. Where the stem is a fair concave curve above the waterline at

85% of the least molded depth and where the aftmost point of the stem is above the waterline, the forward end of the length,  $L_{fp}$  is to be taken at the aftmost point of the stem above that waterline.

See 3-1-1/Figure 1.

#### FIGURE 1

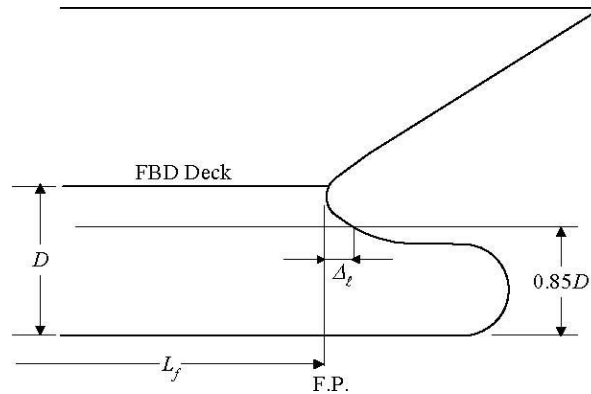

## 5 Breadth (B)

B is the greatest molded breadth in meters (feet).

## 7 Depth

### 7.1 Molded Depth (D)

D is the molded depth at side in meters (feet) measured at the middle of L from the molded base line to the top of the freeboard-deck beams. In vessels having rounded gunwales, D is to be measured to the point of intersection of the molded lines of the deck and side shell plating. In cases where watertight bulkheads extend to a deck above the freeboard deck and are to be recorded in the Record as effective to that deck, D is to be measured to the bulkhead deck.

### 7.3 Scantling Depth ( $D_s$ )

The depth,  $D_s$ , for use with scantling requirements is measured to the strength deck, as defined in 3-1-1/13.5.

## 9 Draft for Scantlings (d)

d is the draft in meters (feet) measured at the middle of the length, L, from the molded keel or the rabbet line at its lowest point to the estimated summer load waterline, the design load waterline or  $0.66D$ , whichever is greater.

## 11 Molded Displacement and Block Coefficient

### 11.1 Molded Displacement ( $\Delta$ )

$\Delta$  is the molded displacement of the vessel in metric tons (long tons), excluding appendages, taken at the summer load line.

### 11.3 Block Coefficient ( $C_b$ )

$C_b$  is the block coefficient obtained from the following equation:

$$C_b = \Delta / 1.025 L B_{wl} d \text{ (SI \& MKS units)}$$

$$C_b = 35 \Delta / L B_{wl} d \text{ (US units)}$$

where

$\Delta$  = molded displacement, as defined in 3-1-1/11.1

$L$  = scantling length, as defined in 3-1-1/3.1

$d$  = draft, as defined in 3-1-1/9

$B_{wl}$  = the greatest molded breadth at summer load line

## Part 3 Hull Construction and Equipment Chapter 1 General Section 1 Definitions 3-1-1

## 13 Decks

### 13.1 Freeboard Deck

The freeboard deck is normally the uppermost continuous deck having permanent means for closing all openings in its weather portions, and below which all openings in the vessel's side are equipped with permanent means for watertight closure. In cases where a vessel is designed for a special draft considerably less than that corresponding to the least freeboard obtainable under the International Load Line Regulations, the freeboard deck for the purpose of the Rules may be taken as the lowest actual deck from which the draft can be obtained under those regulations.

### 13.3 Bulkhead Deck

The bulkhead deck is the highest deck to which watertight bulkheads extend and are made effective.

### 13.5 Strength Deck

The strength deck is the deck which forms the top of the effective hull girder at any part of its length. See Section 3-2-1.

### 13.7 Superstructure Deck

A superstructure deck is a deck above the freeboard deck to which the side shell plating extends. Except where otherwise specified, the term superstructure deck, where used in the Rules, refers to the first such deck above the freeboard deck.

### 13.9 Deckhouses

A deckhouse is an enclosed structure above the freeboard deck having side plating set inboard of the hull's side-shell plating more than 4% of the breadth,  $B$ , of the vessel.

## **15 Deadweight and Lightship Weight**

For the purpose of these Rules, the deadweight, DWT, is the difference in metric tons (long tons) between the displacement of the vessel in water having a specific gravity of 1.025 at the summer load line and the lightship weight. For the purpose of these Rules, lightship weight is the displacement of a vessel in metric tons (long tons) without cargo, fuel, lubricating oil, ballast water, fresh water and feed water in tanks, consumable stores, and passengers and crews and their effects.

## **17 Gross Tonnage**

### **17.1 International Tonnage**

For the purpose of application of these Rules to vessels intended for unrestricted service (see 1-1-3/1), the referenced gross tonnage throughout the Rules is the measure of the internal volume of spaces within the vessel as determined in accordance with the provisions of the “International Convention on Tonnage Measurement of Ships, 1969”.

### **17.3 National Tonnage**

As an alternative to 3-1-1/17.1 above, requirements applicable on the basis of National Tonnage measurement and National Regulations will be considered for vessels whose operation is intended to be restricted exclusively to domestic service. (See 1-1-3/7).

# **3**

## **CHAPTER 2 Hull Structures and Arrangements**

### **SECTION 1 Longitudinal Strength**

#### **1 General**

Vessels are to have longitudinal hull girder section modulus in accordance with the requirements of this section. The equation in this section is, in general, valid for all vessels having breadths,  $B$ , which do not exceed two times their depths,  $D$ , as defined in Section 3-1-1. Vessels whose proportions exceed these

limits will be subject to special consideration.

### 3 Longitudinal Hull Girder Strength

#### 3.1 Minimum Section Modulus

The minimum required hull girder section modulus, SM, at amidships, is to be determined in accordance with the following equation:

$$SM = C_1 C_2 L^2 B (C_b + 0.7) \text{ m-cm}^2 \text{ (ft-in}^2\text{)}$$

where

$$\begin{aligned} C_1 &= 30.67 - 0.98L \quad 12 \leq L < 18 \text{ m} \\ &= 22.40 - 0.52L \quad 18 \leq L < 24 \text{ m} \\ &= 15.20 - 0.22L \quad 24 \leq L < 35 \text{ m} \\ &= 11.35 - 0.11L \quad 35 \leq L < 45 \text{ m} \\ &= 6.40 \quad 45 \leq L < 61 \text{ m} \\ &= 0.0451L + 3.65 \quad 61 \leq L < 90 \text{ m} \end{aligned}$$

$$\begin{aligned} C_1 &= 30.67 - 0.299L \quad 40 \leq L < 59 \text{ ft} \\ &= 22.40 - 0.158L \quad 59 \leq L < 79 \text{ ft} \\ &= 15.20 - 0.067L \quad 79 \leq L < 115 \text{ ft} \\ &= 11.35 - 0.033L \quad 115 \leq L < 150 \text{ ft} \\ &= 6.40 \quad 150 \leq L < 200 \text{ ft} \\ &= 0.0137L + 3.65 \quad 200 \leq L < 295 \text{ ft} \end{aligned}$$

$$C_2 = 0.01 \text{ (0.01, 0.000144)}$$

L = length of vessel, as defined in 3-1-1/3, in m (ft) B = breadth of vessel, as defined in 3-1-1/5, in m (ft)

$C_b$  = block coefficient at design draft, based on the length, L, measured on the design

load waterline.  $C_b$  is not to be taken as less than 0.60.

## **5 Decks**

### **5.1 Strength Decks**

The uppermost deck to which the side shell plating extends for any part of the length of the vessel is to be considered the strength deck for that portion of the length, except in way of comparatively short superstructures. In such a case, the deck on which the superstructures are located is to be considered the strength deck in way of the superstructure. In general, the effective sectional area of the deck for use in calculating the section modulus is to exclude hatchways and other large openings through the deck but may include seam overlaps.

The deck sectional areas used in the section modulus calculations are to be maintained throughout the midship  $0.4L$  in vessels. They may be reduced to one-half the normal requirement at  $0.15L$  from the ends. In way of a superstructure beyond the midship  $0.4L$ , the strength deck area may be reduced to approximately 70% of the normal requirement at that location.

### **5.3 Effective Lower Decks**

To be considered effective for use in calculating the hull girder section modulus, the thickness of the deck plating is to comply with the requirements of Section 3-2-3. The sectional areas of lower decks used in calculating the section modulus are to be obtained as described in 3-2-1/5.1. These areas are to be maintained throughout the midship  $0.4L$  and may be gradually reduced to one-half their midship value at  $0.15L$  from the ends.

## **7 Longitudinal Strength with Higher-Strength Materials**

### **7.1 General**

Vessels in which the effective longitudinal material of either the upper or lower flanges of the main hull girder, or both, are constructed of materials having mechanical properties greater than those of ordinary strength hull structural steel [see Section 2-1-2 of the ABS Rules for Materials and Welding (Part 2)], are to have longitudinal strength generally in accordance with the preceding paragraphs of this section, but the value of the hull girder section modulus may be modified as permitted by the following paragraphs. Applications of higher-strength material are to be continuous over the length of the vessel to locations where the stress levels will be suitable for the adjacent mild steel structure. Higher strength steel is to be extended to suitable locations below the strength deck and above the bottom, so that the stress levels will be satisfactory for the remaining ordinary strength steel structure. The strength deck and bottom structure are to be longitudinally framed. The longitudinal framing members are to be essentially of the same material as the plating they support and are to be continuous throughout the required extent of higher strength steel. Calculations showing that adequate strength has been provided against buckling are to be submitted for review and care is to be exercised against the adoption of reduced thicknesses of materials which may be subject to damage during normal operations.

### **7.3 Hull Girder Moment of Inertia**

The hull-girder moment of inertia is to be not less than required by 3-2-1/3.5.

## 7.5 Hull Girder Section Modulus

When either the top or the bottom flange of the hull girder, or both, is constructed of higher-strength material, the section modulus, as obtained from 3-2-1/3.1 or 3-2-1/3.3.4, may be reduced by the factor Q.

$$SM_{hts} = Q(SM)$$

where

$$Q = 0.78 \text{ for Grade H32}$$

$$Q = 0.72 \text{ for Grade H36}$$

H32, H36 are as specified in Section 2-1-3 of the ABS Rules for Materials and Welding (Part 2).

Q factor for steels having other yield point or yield strength will be specially considered.

## 9 Loading Guidance (1 July 1998)

### 9.1 Loading Manual and Loading Instrument

All vessels that are contracted for construction on or after July 1998 are to be provided with a loading manual and, where required, a loading instrument, in accordance with Appendix 3-2-A1.

### 9.3 Allowable Stresses

#### 9.3.1 At Sea

See 3-2-1/3.3.4 for bending stress and 3-2-1/3.3.5 for shear stress for vessels with ordinary strength steel material. For higher strength steel, the allowable stress may be increased by a factor of 1/Q where Q is as defined in 3-2-1/7.5.

#### 9.3.2 In Port

The allowable in-port stress is  $13.13 \text{ kN/cm}^2$  ( $1.34 \text{ tf/cm}^2$ ,  $8.5 \text{ Ltf/in}^2$ ) for bending and  $10 \text{ kN/cm}^2$  ( $1.025 \text{ tf/cm}^2$ ,  $6.5 \text{ Ltf/in}^2$ ) for shear. For higher strength steel, the allowable stress may be increased by a factor of 1/Q where Q is as defined in 3-2-1/7.5.

## 11 Section Modulus Calculation

### 11.1 Items Included in the Calculation

In general, the following items may be included in the calculation of the section modulus, provided they are continuous or effectively developed within midship, 0.4L, and gradually tapered beyond the midship, 0.4L. Where the scantlings are based on the still-water bending moment envelope curves, items included in the hull girder section modulus amidships are to be extended as necessary to meet the hull girder section modulus required at the location being considered.

Deck plating (strength deck and other effective decks)  
Shell and inner bottom plating  
Deck and bottom girders  
Plating and longitudinal stiffeners of longitudinal bulkheads  
All longitudinals of deck, sides, bottom and inner bottom  
Continuous longitudinal hatch coamings. See 3-2-1/13.

### 11.3 Effective Areas Included in the Calculation

In general, the net sectional areas of longitudinal strength members are to be used in the hull girder section modulus calculations, except that small isolated openings need not be deducted, provided the openings and the shadow area breadths of the other openings in any one transverse section do not reduce the section modulus by more than 3%. The breadth or depth of such openings is not to be greater than 1200 mm (47 in.) or 25% of the breadth or depth of the member in which it is located, whichever is less, with a maximum of 75 mm (3 in.) for scallops. The length of small isolated openings not required to be deducted is generally not to be greater than 2500 mm (100 in.) The shadow area of an opening is the area forward and aft of the opening enclosed by the lines tangential to the corners of the opening intersecting each other to form an included angle of 30 degrees.

### 11.5 Section Modulus to the Deck or Bottom

The section modulus to the deck or bottom is obtained by dividing the moment of inertia by the distance from the neutral axis to the molded deck at side amidships or baseline, respectively.

### 11.7 Section Modulus to the Top of Hatch Coamings

For continuous longitudinal hatch coamings, in accordance with 3-2-1/13, the section modulus to the top of the coaming is to be obtained by dividing the moment of inertia by the distance from the neutral axis to the deck at side plus the coaming height. This distance need not exceed  $y_t$  as given by the following equation, provided  $y_t$  is not less than the distance to the molded deck line at side.

$$y_t = y (0.9 + 0.2x/B) \text{ m (ft)}$$

where

$y$  = distance, in m (ft), from the neutral axis to the top of the continuous coaming

$x$  = distance, in m (ft), from the top of the continuous coaming to the centerline of the vessel

$B$  = breadth of the vessel, as defined in 3-1-1/5, in m (ft).  $x$  and  $y$  are to be measured to the point giving the largest value of  $y_t$ .

Section modulus to the top of longitudinal hatch coamings between multi-hatchways will be subject to special consideration.

## 13 Continuous Longitudinal Hatch Coamings and Above-Deck Girders

Where strength deck longitudinal coamings of length greater than  $0.14L$  are effectively supported by longitudinal bulkheads or deep girders, the coamings are to be longitudinally stiffened, in accordance with 3-2-12/7.7. The section modulus amidships to the top of the coaming is to be as required by 3-2-1/3.1, 3-2-1/3.3, and 3-2-1/11.7, but the section modulus to the deck at side, excluding the coaming, need not be determined in way of such coaming.

Continuous longitudinal girders on top of the strength deck are to be similarly considered. Their scantlings are also to be in accordance with Section 3-2-6.

# 3

## CHAPTER 2 Hull Structures and Arrangements

### SECTION 2 Shell Plating

#### 1 General

Shell plating is to be of not less thickness than is required by the equations for thickness of side and bottom plating as required by this section, nor less than required by Section 3-2-1 for longitudinal strength and Section 3-2-8 for deep tank plating with h not less than the vertical distance to the freeboard deck at side.

#### 3 Bottom Shell Plating

##### 3.1 Extent of Bottom Plating

The term “bottom plating” refers to the plating from the keel to the upper turn of the bilge or upper chine.

##### 3.3 Bottom Shell Plating

The thickness of the bottom shell plating throughout is not to be less than that obtained from the following equations:

###### 3.3.1

$$t = s\sqrt{h}/254 + 2.5 \text{ mm}$$

$$t = s\sqrt{h}/460 + 0.10 \text{ in.}$$

where

t = thickness of bottom shell plating, in mm (in.)

s = frame spacing, in mm (in.)

h = depth, D, in m (ft), as defined in 3-1-1/7.1, but not less than 0.1L or 1.18d, whichever is greater

d = draft for scantlings, as defined in 3-1-1/9, or 0.066L, whichever is greater

L = length of vessel, in m (ft), as defined in 3-1-1/3

### 3.3.2

$$t = \frac{s}{R} \sqrt{\frac{SM_R}{SM_A}} \cdot \frac{1}{\sqrt{Q}} \text{ mm (in.)}$$

where t and s are as defined above.

R = 45 with transverse framing = 55 with longitudinal framing

SM<sub>R</sub> = hull girder section modulus required by 3-2-1/3, in cm<sup>2</sup>-m (in<sup>2</sup>-ft)

SM<sub>A</sub> = bottom hull girder section modulus, in cm<sup>2</sup>-m (in<sup>2</sup>-ft)

Q = as defined in 3-2-1/7.5

## 3.5 Bottom Forward

For vessels of 61 m (200 ft) in length and above, where the heavy weather ballast draft or operating draft forward is less than 0.04L, the plating on the flat of bottom forward, forward of the location given in 3-2-4/Table 1 is to be not less than required by the following equation:

$$t = 0.0046s \sqrt{(0.005L^2 - 1.3d_f^2) / d_f} \text{ mm}$$

$$t = 0.0026s \sqrt{(0.005L^2 - 1.3d_f^2) / d_f} \text{ in.}$$

where

s = frame spacing, in mm (in.)

L = length of vessel, as defined in 3-1-1/3

d<sub>f</sub> = heavy weather ballast draft at the forward perpendicular, in m (ft)

## 5 Side Shell Plating

### 5.1 General (1998)

The side shell plating is not to be less in thickness than that obtained from the following equation:

$$t = \frac{s\sqrt{h}}{268} + 2.5 \text{ mm}$$

$$t = \frac{s\sqrt{h}}{485} + 0.10 \text{ in.}$$

485

where

t = thickness, in mm (in.)

s = spacing of transverse frames or longitudinals, in mm (in.)

h = depth, in m (ft), as defined in 3-1-1/7, but not less than 0.1L or 1.18d, whichever

is greater d = draft for scantlings, as defined in 3-1-1/9, or 0.066L, whichever is greater L = length of the vessel, as defined in 3-1-1/3

t is not to be taken less than 8.5 mm (0.33 in.) for offshore support vessels.

The side shell plating in way of hold frames of dry cargo vessels with typical bulk carrier configuration (sloping upper and lower wing tanks with a transversely framed side shell in way of the hold) is also not to be less than that obtained from the following equation:

$$t = \sqrt{L} \text{ mm}$$

$$t = 0.0218\sqrt{L} \text{ in.}$$

### 5.3 Recommendation for Vessels Subject to Impact

For vessels subject to impact loadings during routine operations, it is recommended that a side shell 25% greater in thickness than that obtained from the equation in 3-2-2/5.1 be provided.

### 5.5 Side Shell Plating at Ends

The minimum side shell plating thickness, t, at ends is to be obtained from the following equations and is not to extend for more than 0.1L from the ends. Between the midship 0.4L and the end 0.1L, the thickness of the plating may be gradually tapered.

$$t = 0.0455L + 0.009s \text{ mm} \quad t = 0.000545L + 0.009s \text{ in.}$$

where

s = frame spacing, in mm (in.)

L = length of vessel, as defined in 3-1-1/3, in m (ft)

Where the strength deck at the ends is above the freeboard deck, the thickness of the side plating above the freeboard deck may be reduced to the thickness given for forecastle and poop sides at the forward and after ends, respectively.

### 5.7 Forecastle and Poop Side Plating

#### 5.7.1 Forecastle Side Plating

The thickness, t, of the plating is to be not less than that obtained from the following equation:

$$t = 0.038(L + 30.8) + 0.006s \text{ mm}$$

$$t = 0.00045(L + 103.3) + 0.006s \text{ in.}$$

#### 5.7.2 Poop Side Plating

The thickness, t, of the plating is to be not less than that obtained from the following equation:

$$t = 0.0296(L + 39.5) + 0.006s \text{ mm}$$

$$t = 0.00035(L + 132.9) + 0.006s \text{ in.}$$

where

s = spacing of frames, in mm (in.)

L = length of vessel, as defined in 3-1-1/3, in m (ft)

## 17 Higher-strength Materials

### 17.1 General

In general, applications of higher-strength materials are to take into consideration the suitable extension of the higher-strength material above and below the bottom and deck, respectively, as required by 3-2-1/7.1. Care is to be taken against the adoption of reduced thickness of material that might be subject to damage during normal operation. The thickness of bottom and side-shell plating, where constructed of higher-strength materials, are to be not less than required for purposes of longitudinal hull girder strength; nor are they to be less than required by the foregoing paragraphs of this section when modified as indicated by the following paragraphs.

### 17.3 Bottom Plating of Higher-strength Material

Bottom shell plating, where constructed of higher-strength material and where longitudinally framed, is to be not less in thickness than that obtained from the following equation:

$$t_{hts} = (t_{ms} - C)\sqrt{Q} + C$$

where

$t_{hts}$  = thickness of higher-strength material, in mm (in.)

$t_{ms}$  = thickness, in mm (in.), of ordinary-strength steel, as required by preceding paragraphs of this section, or from the requirements of other sections of the Rules, appropriate to the vessel type.

C = 4.3 mm (0.17 in.)

Q = as defined in 3-2-1/7.5

### 17.5 Side Plating of Higher-strength Material

Side-shell plating, where constructed of higher-strength material, is to be not less in thickness than that obtained from the following equation:

$$t_{hts} = [t_{ms} - C][(Q + 2\sqrt{Q})/3] + C$$

where  $t_{hts}$ ,  $t_{ms}$ , C and Q are as defined in 3-2-2/17.3 for bottom plating.

### 17.7 End Plating

End-plating thickness, including plating on the flat of bottom forward, where constructed of higher-strength materials, will be subject to special consideration.

# 3

## CHAPTER 2 Hull Structures and Arrangements

### SECTION 3 Deck Plating

#### 1 General

The thickness of the deck plating is not to be less than that required to obtain the hull-girder section modulus given in Section 3-2-1, nor less than required by this section.

#### 3 Deck Plating

The thickness of plating on each deck is to be not less than the greater of those obtained from the following equations. The required thickness is not to be less than 5.0 mm (0.20 in.), except for platform decks in enclosed passenger spaces where the thickness is not to be less than 4.5 mm (0.18 in.). Thickness of strength deck inside line of openings may be reduced by 1.0 mm (0.04 in.) from  $t$  obtained by 3-2-3/3.3 below.

##### 3.1 All Decks

$$t = \frac{s\sqrt{h}}{254} + 2.5 \text{ mm}$$

$$t = \frac{s\sqrt{h}}{460} + 0.10 \text{ in.}$$

where

$t$  = thickness, in mm (in.)

$s$  = beam or longitudinal spacing, in mm (in.)

$h$  = height, in m (ft), as follows:

=for a deck or portion of deck forming a tank top, the greater of the following distances:

- two-thirds of the distance from the tank top to the top of the overflow, or
- two-thirds of the distance from the tank top to the bulkhead deck or freeboard deck.

=for a lower deck on which cargo or stores are carried, the tween-deck height at side; where the cargo weights are greater than normal [ $7010 \text{ N/m}^3$  ( $715 \text{ kgf/m}^3$ ,  $45 \text{ lbf/ft}^3$ )],  $h$  is to be suitably adjusted.

=for an exposed deck on which cargo is carried, 3.66 m (12 ft). Where it is intended to carry deck

cargoes in excess of  $25850 \text{ N/m}^2$  ( $2636 \text{ kgf/m}^2$ ,  $540 \text{ lbf/ft}^2$ ), this head is to be increased in proportion to the added loads which will be imposed on the structure

Elsewhere, the value of h is to be not less than that obtained from the appropriate equation below, where L is the length of vessel in m (ft), as defined in 3-1-1/3.

### 3.1.1 Exposed Freeboard Deck Having No Deck Below

$$h = 0.028L + 1.08 \text{ m}$$

$$h = 0.028L + 3.57 \text{ ft}$$

### 3.1.2 Exposed Freeboard Deck Having a Deck Below, Forecastle Deck, Superstructure Deck Forward of Amidships 0.5L

$$h = 0.028L + 0.66 \text{ m}$$

$$h = 0.028L + 2.14 \text{ ft}$$

### 3.1.3 Freeboard Deck within Superstructure, Any Deck Below Freeboard Deck, Superstructure Deck Between 0.25L Forward of and 0.20L Aft of Amidships

$$h = 0.014L + 0.87 \text{ m}$$

$$h = 0.014L + 2.86 \text{ ft}$$

### 3.1.4 All Other Locations

$$h = 0.014L + 0.43 \text{ m}$$

$$h = 0.014L + 1.43 \text{ ft}$$

## 3.3 Strength Decks within the Midship 0.8L (2002)

For vessels of length equal to or greater than 61 meters, the strength deck plating within the midship 0.8L shall meet the following requirement:  $t = 0.009s + 2.4 \text{ mm}$   $t = 0.009s + 0.095 \text{ in.}$  where s = beam or longitudinal spacing, in mm (in.)

## 3.5 All Strength Deck Plating Outside the Line of Openings and Other Effective Deck Plating (2002)

For vessels of length equal to or greater than 61 meters, the strength deck plating within the midship 0.8L shall meet the following requirement:

$$t = \frac{s}{R} \sqrt{\frac{SM_R}{SM_A}} \cdot \frac{1}{\sqrt{Q}} \text{ mm (in.)}$$

where

t = thickness, in mm (in.)

s = beam or longitudinal spacing, in mm (in.), not to be taken less than 610 mm (24 in.)

R = 60 for longitudinal framing, 45 for transverse framing

$SM_R$  = hull girder section modulus required in 3-2-1/3, in  $cm^2 \cdot m$  ( $in^2 \cdot ft$ )

$SM_A$  = hull girder section modulus, in  $cm^2 \cdot m$  ( $in^2 \cdot ft$ ), measured to the deck in question

Q = material factor for the material used in determining  $SM_R$ , as defined in 3-2-1/7.5

## 5 Compensation

Compensation is to be provided for openings in the strength deck and other effective decks to maintain the longitudinal and transverse strength. Openings in the strength deck are to have a minimum corner radius of 0.125 times the width of the opening, but need not exceed a radius of 600 mm (24 in.). In other decks, the radius is to be 0.09375 times the width of the opening, but need not exceed radius of 450 mm (18 in.). Openings are to be a suitable distance from the deck edge, from cargo hatch covers, from superstructure breaks and from other areas of structural discontinuity.

## 9 Higher-strength Material

### 9.1 Thickness

In general, applications of higher strength materials are to take into consideration the suitable extension of the higher strength material below the deck, forward and aft. Care is to be taken to avoid the adoption of reduced thickness of material such as might be subject to damage during normal operation. The thickness of deck plating for longitudinally framed decks, where constructed of higher-strength material, is to be not less than required for longitudinal strength, nor is it to be less than that obtained from the following equation:

$$t_{hts} = (t_{ms} - C) \sqrt{Q} + C$$

where

$t_{hts}$  = thickness of higher-strength material, in mm (in.)

$t_{ms}$  = thickness of ordinary-strength steel, in mm (in.), as required 3-2-3/3.1 and 3-2-3/3.3

C = 4.3 mm (0.17 in.)

Q = is as defined in 3-2-1/7.5

Where the deck plating is transversely framed, or where the Rules do not provide a specific thickness for the deck plating, the thickness of the higher-strength material will be specially considered, taking into consideration the size of the vessel, intended service and the foregoing Rule requirements.

**Part 3 Hull Construction and Equipment Chapter 2 Hull Structures and Arrangements Section 3 Deck Plating 3-2-3**

PART

# 3

## CHAPTER 2 Hull Structures and Arrangements

### SECTION 4 Bottom Structure

#### 1 Double Bottoms

##### 1.1 General

Inner bottoms are to be fitted fore and aft between the peaks or as near thereto as practicable in vessels of ordinary design of 500 GT or over. Where, for special reasons, it may be desired to omit the inner bottom, the arrangements are to be clearly indicated on the plans when first submitted for approval. A double bottom need not be fitted in way of deep tanks, provided the safety of the vessel in the event of bottom damage is not thereby impaired. It is recommended that the inner bottom be arranged to protect the bilges as much as possible and that it be extended to the sides of the vessel.

Shell longitudinals and frames in way of deep tanks are to have not less strength than is required for stiffeners on deep tank bulkheads.

##### 1.3 Center Girder

A center girder is to be fitted extending as far forward and aft as practicable. The plates are to be continuous within the midship three-quarters length; elsewhere, they may be intercostal between floors. Where double bottoms are to be used for fuel oil or fresh water, the girders are to be intact, but need not be tested under pressure. This requirement may be modified in narrow tanks at the ends of the vessel or where other intact longitudinal divisions are provided at about 0.25B from centerline. Where the girders are not required to be intact, manholes may be cut in every frame space outside the midships three-quarters length; they may be cut in alternate frames spaces within the midships three-quarters length. For vessels which have a length more than 61 m (200 ft) and the length of the cargo hold is greater than 1.2B, the thickness and depth of center girder plates are to be specially considered based on the results of a direct structural calculation.

##### 1.3.1 Thickness Amidships

The thickness of the center girder within the midship one-half length is not to be less than that obtained from the following equation.

$$t = 0.056L + 5.5 \text{ mm}$$

$$t = 0.00067L + 0.22 \text{ in.}$$

where

t = thickness, in mm (in.)

L = length of vessel, in m (ft), as defined 3-1-1/3

### 1.3.2 Thickness at Ends

The thickness of the center girder forward and aft of the midship one-half length may be reduced to 85% of the girder thickness amidships.

### 1.3.3 Depth

The depth of the center girder is not to be less than that obtained from the following equation:

$$h_g = 32B + 190\sqrt{d} \text{ mm}$$

$$h_g = 0.384B + 4.13\sqrt{d} \text{ in.}$$

where

$h_g$  = depth, in mm (in.)

B = breadth of vessel, in m (ft), as defined in 3-1-1/5

d = draft for scantlings, in m (ft), as defined in 3-1-1/9

## 1.5 Side Girders

Where the distance between the center girder and the side shell exceeds 4.57 m (15 ft), intercostal side girders are to be fitted approximately midway between the center girder and the side shell. The minimum thickness of the intercostal side girders is not to be less than obtained from the following equation.

$$t = 0.036L + c \text{ mm}$$

$$t = 0.00043L + c \text{ in.}$$

where

t = thickness, in mm (in.)

L = length of vessel, in m (ft), as defined in 3-1-1/3

c = 4.7 mm (0.18 in.)

## 1.7 Floors

Solid floors are to be fitted at every frame under the engine room, at every frame in the peaks and under transverse bulkheads. Elsewhere, the solid floors are to have a maximum spacing of 3.66 m (12 ft) in association with intermediate open floors or longitudinal framing. The thickness of solid floors is to be equal to the thickness of side girders obtained in 3-2-4/1.5, except that for widely spaced floors in association with longitudinal framing, c is to be taken as 6.2 mm (0.24 in.).

## 1.9 Frames

In transversely framed vessels, open floors consisting of frames and reverse frames are to be fitted at all frames where solid floors are not fitted. Center and side brackets are to overlap the frames and reverse frames for a distance equal to 0.05B. They are to be of the thickness required for side girders in the same location and are to be flanged on their outer edges. Alternatively, longitudinal framing is to be fitted in association with widely spaced floors. The section modulus, SM, of each frame, reverse frame or bottom, or inner bottom longitudinal in association with the plating to which it is attached is not to be less than that obtained from the following equation.

$$SM = 7.8chs\ell^2 \text{ cm}^3$$

$$SM = 0.0041chs\ell^2 \text{ in}^3$$

where

s = frame spacing, in m (ft)

$\ell$  = unsupported span between supporting members, in m (ft).

Where brackets are fitted in accordance with 3-1-2/5.5 and are supported by bulkheads, inner bottom, or side shell, the length,  $\ell$ , may be measured as permitted therein.

h = vertical distance, in m (ft), from the middle of  $\ell$  to the deck at side. In way of a deep tank, h is the greatest distance from the middle of  $\ell$  to a point located at two-thirds of the distance from the top of the tank to the top of the overflow; a point located above the top of the tank not less than 0.01L + 0.15 m or 0.46 m (0.01L + 0.5 ft or 1.5 ft), whichever is greatest. c for transverse frames and reverse frames: = 0.8 clear of tanks = 1.0 in way of tanks = 0.5 with struts c for longitudinal frames: = 1.0 without struts = 0.55 with struts c for inner bottom longitudinals: = 0.85 without struts = 0.45 with struts Frames and reverse frames in way of tanks are not to be less than that required clear of tanks if that be greater.

## 1.11 Struts

Struts are to be angle bar sections fitted midway between floors. In general, they are not to be used where cargo is discharged by grabs, where heavy cargoes are carried or in the bottom forward slamming area. The permissible load,  $W_a$ , for struts is to be determined in accordance with 3-2-6/3.5.3. The calculated load, W, is to be determined by:

$$W = nphs \text{ kN (tf, Ltf)}$$

where n = 10.5 (1.07, 0.03)

p = the sum of the half lengths, in m (ft), on each side of the strut, of the frames supported

h = as defined in 3-2-4/1.9

s = frame spacing, in m (ft)

Struts are to be positioned so as to divide the span into approximately equal intervals.

## 1.13 Inner-bottom Plating

The thickness of the inner-bottom plating throughout the length of the vessel is to be not less than that obtained from the following equation. Where applicable, the plating is to meet deep tank requirements.

$$t = 0.037L + 0.009s + c \text{ mm}$$

$$t = 0.000445L + 0.009s + c \text{ in.}$$

where

t = thickness, in mm (in.)

L = length of vessel, in m (ft), as defined in 3-1-1/3

s = frame spacing, in mm (in.)

c = 1.5 mm (0.06 in.) in engine space

= -0.5 mm (-0.02 in.) elsewhere

Where no ceiling is fitted under cargo hatchways, except for vessels intended for the exclusive carriage of containers on the inner bottom, the thickness of the inner-bottom plating is to be increased 2.0 mm (0.08 in.). For vessels with longitudinally-framed inner bottoms, the minimum thickness of inner-bottom plating may be reduced by 1 mm (0.04 in.).

For vessels regularly engaged in trades where the cargo is handled by grabs or similar mechanical appliances, it is recommended that flush inner-bottom plating be adopted throughout the cargo space, and that the plating be suitably increased, but the increase need not exceed 5 mm (0.20 in.). It is also recommended that the minimum thickness be not less than 12.5 mm with 610 mm (0.50 in. with 24 in.) frame spacing and 19 mm with 915 mm (0.74 in. with 36 in.) frame spacing. Intermediate thicknesses may be obtained by interpolation.

Where provision is to be made for the operation or stowage of vehicles having rubber tires, and after all other requirements are met, the thickness of the inner bottom plating is to be not less than that obtained from 3-2-3/7.

Margin plates which are approximately horizontal are to have thicknesses not less than the adjacent inner bottom plating. Where they are nearly vertical, they are to be not less than the required inner bottom plating in the engine space and are to extend the full depth of the inner bottom.

## **3 Single Bottoms with Floors and Keelsons**

### **3.1 General**

Where double bottom construction is not required by 3-2-4/1.1 or is not applied, single bottom construction is to be in accordance with 3-2-4/3 or 3-2-4/5, as may be applicable.

### **Part 3 Hull Construction and Equipment Chapter 2 Hull Structures and Arrangements Section 4 Bottom Structure 3-2-4**

### **3.3 Center Keelsons**

Single-bottom vessels are to have center keelsons formed of continuous or intercostal center girder plates with horizontal top plates. The thickness of the keelson and the area of the horizontal top plate are to be not less than that obtained from the following equations. Vessels less than 30.5 m (100 ft) in length will be subject to special consideration. Tapering of the horizontal top plate area at the ends is not normally considered for vessels less than 30.5 m (100 ft) in length. The keelsons are to extend as far forward and

aft as practicable.

### 3.3.1 Center-girder Plate Thickness Amidships

$$t = 0.063L + 5 \text{ mm}$$

$$t = 0.00075L + 0.2 \text{ in.}$$

### 3.3.2 Center-girder Plates Thickness at Ends

t = 85% of center keelson thickness amidships

### 3.3.3 Horizontal Top-plate Area Amidships

$$A = 0.168L^{3/2} - 8 \text{ cm}^2$$

$$A = 0.0044L^{3/2} - 1.25 \text{ in}^2$$

### 3.3.4 Horizontal Top-Plate Area at Ends [L ≥ 30.5 m (100 ft)]

$$A = 0.127L^{3/2} - 1 \text{ cm}^2$$

$$A = 0.0033L^{3/2} - 0.15 \text{ in}^2$$

where

t = thickness of center-girder plate, in mm (in.)

L = length of vessel, as defined in 3-1-1/3, in m (ft)

A = area of horizontal top plate, in cm<sup>2</sup> (in<sup>2</sup>)

## 3.5 Side Keelsons

Side keelsons are to be arranged so that there are not more than 2.13 m (7 ft) from the center keelson to the inner side keelson, from keelson to keelson and from the outer keelson to the lower turn of bilge.

Forward of the midship one-half length, the spacing of keelsons on the flat of floor is not to exceed 915 mm (36 in.). Side keelsons are to be formed of continuous rider plates on top of the floors. They are to be connected to the shell plating by intercostal plates. The intercostal plates are to be attached to the floor plates. In the engine space, the intercostal plates are to be of not less thickness than the center girder plates. The scantlings of the side keelsons are to be obtained from the following equations but need not exceed 3-2-4/3.3, if that be less.

### 3.5.1 Side Keelson and Intercostal Thickness Amidships

$$t = 0.063L + 4 \text{ mm}$$

$$t = 0.00075L + 0.16 \text{ in.}$$

### 3.5.2 Side Keelson and Intercostal Thickness at Ends

t = 85% of center thickness amidships

### 3.5.3 Side Keelson and Intercostal, Horizontal Top Plate Area Amidships

$$A = 0.038L^{3/2} + 17 \text{ cm}^2$$

$$A = 0.001L^{3/2} + 2.6 \text{ in}^2$$

### 3.5.4 Side Keelson and Intercostal, Horizontal Top Plate Area at Ends

$$A = 0.025L^{3/2} + 20 \text{ cm}^2$$

$$A = 0.00065L^{3/2} + 3.1 \text{ in}^2$$

t, L and A are as defined in 3-2-4/3.3.

## 3.7 Floors

### 3.7.1 Section Modulus

With transverse framing, a floor as shown in 3-2-4/Figure 1 is to be fitted on every frame and is to be of the scantlings necessary to obtain a section modulus, SM, not less than that obtained from the following equation:

$$SM = 7.8chs\ell^2 \text{ cm}^3$$

$$SM = 0.0041chs\ell^2 \text{ in}^3$$

where

$$c = 0.55$$

h = draft, d, in m (ft), as defined in section 3-1-1/9, but not to be less than 0.66D or 0.066L, whichever is greater.

s = floor spacing, in m (ft)

$\ell$  = span, in m (ft). Where brackets are fitted in accordance with 3-1-2/5.5 and are supported by bulkheads, inner bottom or side shell, the length,  $\ell$ , may be measured as permitted therein.

The section modulus may be calculated at the centerline of the vessel, provided the rise of floor is such that the depth at the toe of brackets is not less than one-half of the depth at the centerline. The above requirements are limited to cargo holds where cargoes of specific gravity 0.715 or less are uniformly loaded. In way of engine room and in the forward 0.2L, the floor face bar area is to be doubled.

### 3.7.2 Depth

The minimum depth of floors at centerline is not be less than that obtained from the following equation:

$$h_f = 62.5l \quad \text{mm}$$

$$h_f = 0.75l \quad \text{in.}$$

where

$$h_f = \text{floor depth, in mm (in.)}$$

$\ell$  = unsupported span of floors, in m (ft). Where brackets are fitted in accordance with 3-1-2/5.5, the length,  $\ell$ , may be measured as permitted therein.

### 3.7.3 Thickness

The minimum thickness of floors is not to be less than that obtained from the following equation:

$$t = 0.01h_f + 3 \text{ mm}$$

$$t = 0.01h_f + 0.12 \text{ in.}$$

where

$t$  = floor thickness, in mm (in.)

$h_f$  = floor depth, in mm (in.)

Floors under engine girders are to be not less in thickness than the thickness required for keelsons.

**FIGURE 1 Plate Floors**

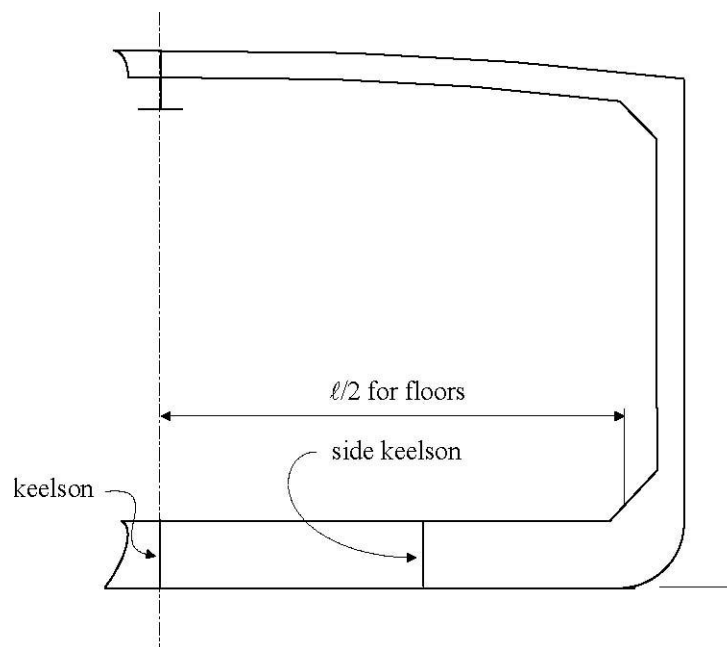

## 5 Single Bottoms with Longitudinal or Transverse Frames

### 5.1 General

Where longitudinal frames supported by bottom transverses or transverse frames supported by longitudinal girders and bottom transverses are proposed in lieu of keelsons referred to in 3-2-4/3, the construction is to be in accordance with this subsection. Frames are not to have less strength than is required for watertight bulkhead stiffeners or girders in the same location in association with head to the bulkhead deck. In way of deep tanks, frames are not to have less strength than is required for stiffeners or

girders on deep tank bulkheads. See 3-2-4/Figure 2, 3-2-4/Figure 3 and 3-2-4/Figure 4.

**FIGURE 2 Round Bottom Floors with Deadrise**

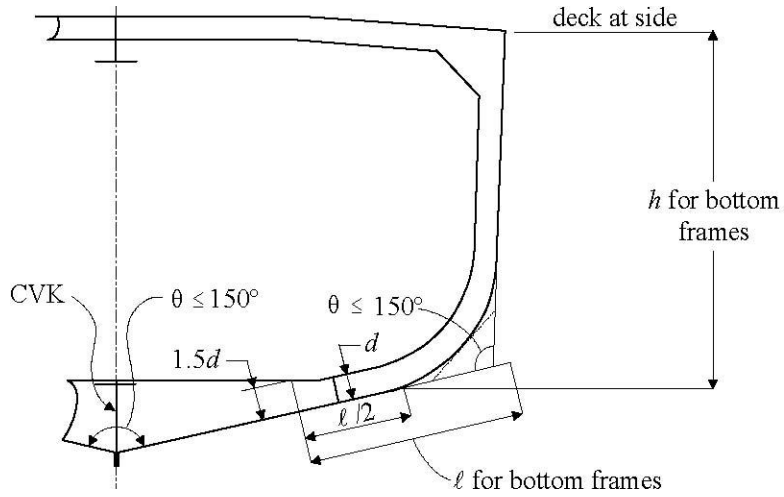

**FIGURE 3 Transverse Bottom Frames with Longitudinal Side Girders**

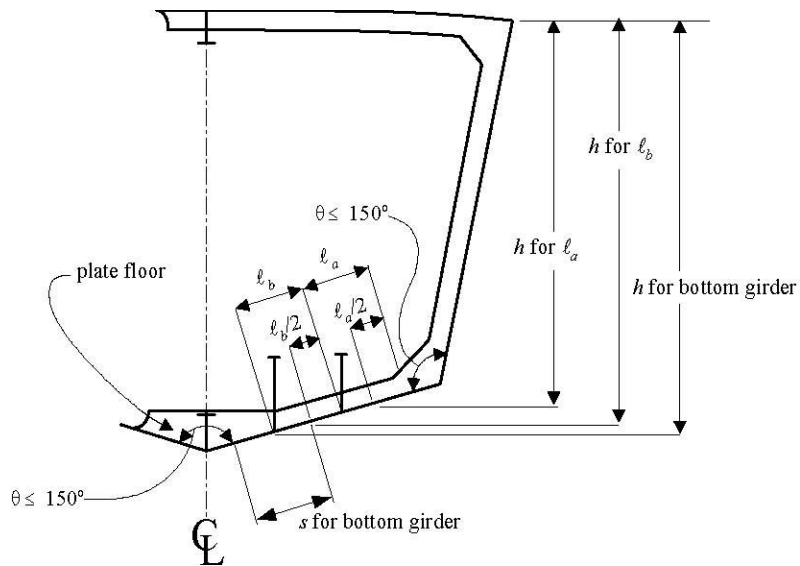

**FIGURE 4 Longitudinal Frames with Transverse Webs**

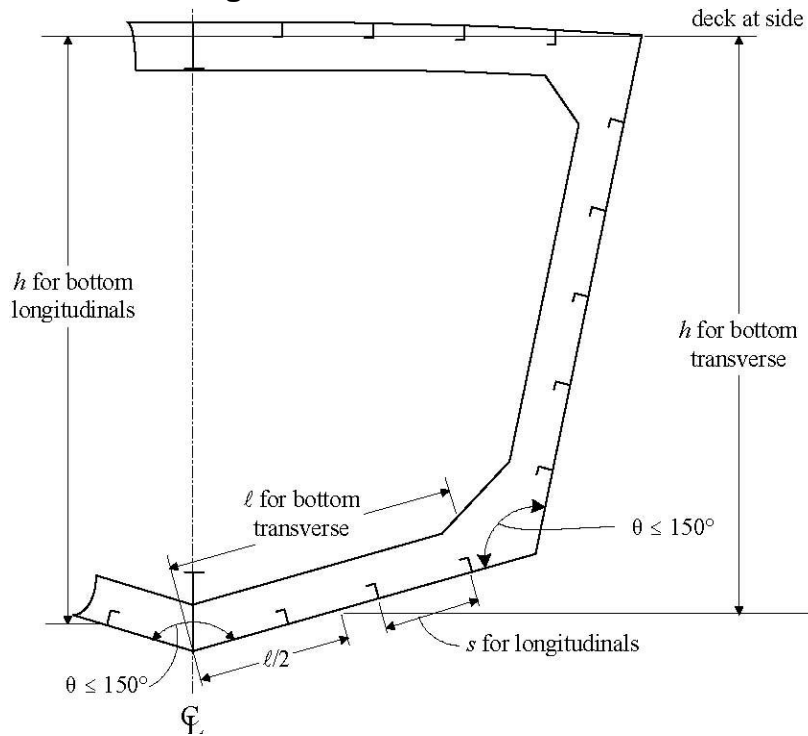

### 5.3 Bottom Girders and Transverses

#### 5.3.1 Section Modulus

The section modulus, SM, of each bottom girder and transverse, where intended as a primary supporting member, in association with the plating to which it is attached, is not to be less than that obtained from the following equation:

$$SM = 7.8chs\ell^2 \text{ cm}^3$$

$$SM = 0.0041chs\ell^2 \text{ in}^3$$

where

$$c = 0.915$$

h = vertical distance, in m (ft), from the center of area supported to the deck at side

s = spacing, in m (ft)

ℓ = unsupported span, in m (ft). Where brackets are fitted in accordance with 3-1-2/5.5 and are supported by bulkheads, inner bottom or side shell, the length, ℓ, may be measured as permitted therein.

Tripping brackets are to be fitted at intervals of about 3 m (10 ft) and stiffeners are to be fitted as may be required.

#### 5.3.2 Depth

The minimum depth of the girder or transverse is to be not less than 2.5 times the depth of the cutouts for bottom frames, unless effective compensation for cutouts is provided, nor less than that obtained from the following equation:

$$h_w = 145l \quad \text{mm}$$

$$h_w = 1.75l \quad \text{in.}$$

where

$h_w$  = girder or transverse depth, in mm (in.)

$l$  is defined in 3-2-4/5.3.1.

### 5.3.3 Thickness

The minimum thickness of the web is to be not less than that obtained from the following equation:

$$t = 0.01h_w + 3 \text{ mm}$$

$$t = 0.01h_w + 0.12 \text{ in.}$$

where

$t$  = floor thickness, in mm (in.)

$h_w$  is as given in 3-2-4/5.3.2.

### 5.3.4 Non-prismatic Members

Where the cross sectional properties of the member is not constant throughout the length of the girders or transverses, the above requirements will be specially considered with particular attention being paid to the shearing forces at the ends.

## 5.5 Center Girder

In general, a center girder is to be fitted, complying with 3-2-4/5.3; however, alternative arrangements that provide suitable support for docking will be considered.

## 5.7 Frames

The section modulus, SM, of each bottom frame to the chine or upper turn of bilge, in association with the plating to which it is attached, is not to be less than that obtained from the following equation:

$$SM = 7.8chs\ell^2 \text{ cm}^3$$

$$SM = 0.0041chs\ell^2 \text{ in}^3$$

where

- $c$  = 0.80 for transverse frames clear of tanks
- = 1.00 for longitudinal frames clear of tanks, and in way of tanks
- = 1.00 for transverse frames in way of tanks

s = frame spacing in, m (ft)

$\ell$  = unsupported span, in m (ft), Where brackets are fitted in accordance with 3-1-2/5.5 and are supported by bulkheads, inner bottom or side shell, the length,  $\ell$ , may be measured as permitted therein.

h = vertical distance, in m (ft), from the middle of  $\ell$  to the deck at side. In way of a deep tank, h is the greatest of the distances, in m (ft), from the middle of  $\ell$  to a point located at two-thirds of the distance from the top of the tank to the top of the overflow, a point located above the top of the tank not less than  $0.01L + 0.15$  m ( $0.01L + 0.5$  ft) or 0.46 m (1.5 ft), whichever is greatest.

L is as defined in 3-1-1/3.

## 9 Higher-strength Materials

### 9.1 General

In general, applications of higher-strength materials for bottom structures are to meet the requirements of this section, but may be modified as permitted by the following paragraphs. Care is to be exercised to avoid the adoption of reduced thickness of material such as might be subject to damage during normal operation, and calculations are to be submitted to show adequate provision against buckling. Longitudinal framing members are to be of essentially the same material as the plating they support.

### 9.3 Inner-bottom Plating

Inner-bottom plating, where constructed of higher-strength material and where longitudinally framed, is to be not less in thickness than required by 3-2-4/1.13 or for tank top plating as modified by the following equation:

$$t_{hts} = [t_{ms} - C][(Q + 2\sqrt{Q}Q)/3] + C$$

where

$t_{hts}$  = thickness of higher-strength material, in mm (in.)

$t_{ms}$  = thickness of mild steel, as required by 3-2-4/1.13, in mm (in.), increased where required for no ceiling

C = 3 mm (0.12 in.) or 5 mm (0.20 in.) where the plating is required by 3-2-4/1.13 to be increased for no ceiling

Q = as defined in 3-2-1/7.5

The thickness of inner-bottom plating, where transversely framed, will be specially considered.

Where cargo is handled by grabs, or similar mechanical appliances, the recommendations of 3-2-4/1.13 are applicable to  $t_{hts}$ .

### 9.5 Bottom and Inner-bottom Longitudinals

The section modulus of bottom and inner-bottom longitudinals, where constructed of higher-strength material and in association with the higher-strength plating to which they are attached, are to be

determined as indicated in 3-2-4/1.9, except that the value may be reduced by the factor Q, as defined in 3-2-1/7.5.

### **9.7 Center Girders, Side Girders and Floors**

Center girders, side girders and floors, where constructed of higher-strength materials, are generally to comply with the requirements of 3-2-4/1.3, 3-2-4/1.5 or 3-2-4/1.7, but may be modified as permitted by the following equation:

$$t_{hts} = [t_{ms} - C][(Q + 2\sqrt{Q})/3] + C$$

where

$t_{hts}$ ,  $t_{ms}$  and C are defined in 3-2-4/9.3.

Q is as defined in 3-2-1/7.5.

# 3

## CHAPTER 2 Hull Structures and Arrangements

### SECTION 5 Side Frames, Webs and Stringers

#### 1 General

##### 1.1 Basic Considerations

Frames or webs and stringers are not to have less strength than is required for watertight bulkhead stiffeners, or girders, in the same location in association with heads to the bulkhead deck. In way of deep tanks, frames or webs and stringers are not to have less strength than is required for stiffeners or girders on deep-tank bulkheads. The calculated section modulus is based upon the intact sections being used. Where a hole is cut in the flange of any member or a large opening is made in the web of the member, the net section is to be used in determining the section modulus of the member in association with the plating to which it is attached.

##### 1.3 End Connections

At the ends of unbracketed frames, both the web and the flange are to be welded to the supporting member. At bracketed end connections, continuity of strength is to be maintained at the connection to the bracket and at the connection of the bracket to the supporting member. Welding is to be in accordance with 3-2-16/Table 1. Where longitudinal frames are not continuous at bulkheads, end connections are to effectively develop their sectional area and resistance to bending. Where a structural member is terminated, structural continuity is to be maintained by suitable back-up structure, fitted in way of the end connection of frames, or the end connection is to be effectively extended by a bracket or flat bar to an adjacent beam, stiffener, etc.

#### 3 Longitudinal Side Frames

##### 3.1 Section Modulus

The section modulus, SM, of each longitudinal side frame above the chine or upper turn of bilge is to be not less than that obtained from the following equation:

$$SM = 7.8chs\ell^2 \text{ cm}^3$$

$$SM = 0.0041chs\ell^2 \text{ in}^3$$

where

$$c = 0.915$$

h = vertical distance, in m (ft), from the frame to the freeboard deck at side, but not less than  $0.02L + 0.46$  m ( $0.02L + 1.5$  ft)

s = frame spacing, in m (ft)

$\ell$  = straight-line unsupported span, in m (ft). Where brackets are fitted in accordance with 3-1-2/5.5 and are supported by bulkheads, the length,  $\ell$ , may be measured as permitted therein.

## 5 Transverse Side Frames

### 5.1 Section Modulus

The section modulus, SM, of each transverse side frame other than tween deck frames above the chine or upper turn of bilge, in association with the plating to which the frame is attached, is not to be less than that obtained from the following equation. See 3-2-5/Figure 1, 3-2-5/Figure 2 and 3-2-5/Figure 3.

$$SM = 7.8chs\ell^2 \text{ cm}^3$$

$$SM = 0.0041chs\ell^2 \text{ in}^3$$

where

c = 0.915 for frames having no tween decks above

=  $0.90 + 5.8/\ell^3 (0.90 + 205/\ell^3)$  for frames having tween decks above

s = frame spacing, in m (ft)

$\ell$  = straight-line unsupported span, in m (ft). Where brackets are fitted in accordance with 3-1-2/5.5 and are supported by decks or inner bottoms, the length  $\ell$  may be measured as permitted therein. Where tween decks are located above the frame,  $\ell$  is to be taken as the length between the toes of the brackets, except where beam knees are fitted on alternate frames,  $\ell$  is to be increased by one half the depth of the beam knees.  $\ell$  is not to be taken less than 2.1 m (7.0 ft).

h = on frames having no tween decks above, the vertical distance, in m (ft), from the mid length of the frame to the freeboard deck at side, but not less than  $0.02L + 0.46$  m ( $0.02L + 1.5$  ft).

= on frames having tween decks above, the vertical distance, in m (ft), from the middle of  $\ell$  to the load line or  $0.4\ell$ , whichever is greater, plus  $bh_1/33$  ( $bh_1/100$ ).

b = horizontal distance, in m (ft), from the outside of the frames to the first row of deck beam supports.

$h_1$  = vertical distance, in m (ft), from the deck at the top of the frame to the bulkhead or freeboard deck

plus the height of all cargo tween deck spaces above the bulkhead or freeboard deck plus one-half the height of all passenger spaces above the bulkhead or freeboard deck, or plus 2.44 m (8 ft), if that is greater. Where the cargo load differs from  $715 \text{ kgf/m}^3$  ( $45 \text{ lbf/ft}^3$ ),  $h_1$  is to be adjusted accordingly.

**FIGURE 1 Transverse Side Frame Transverse Side Frame**

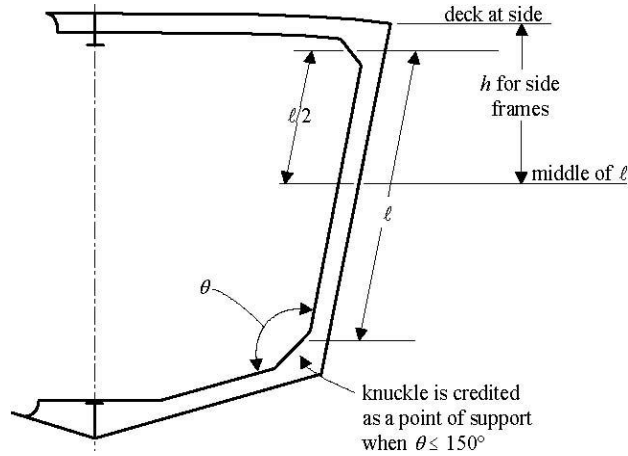

**FIGURE 2**

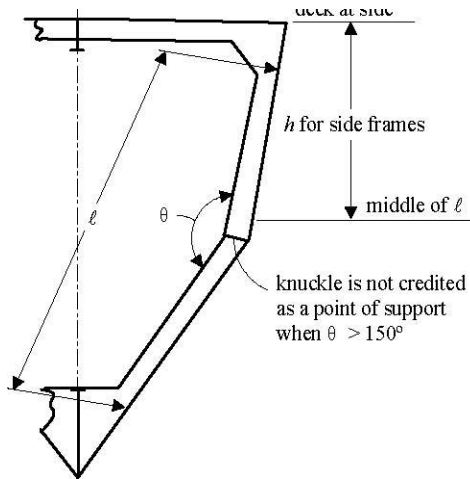

**FIGURE 3 Hold and Tween Deck Frames**

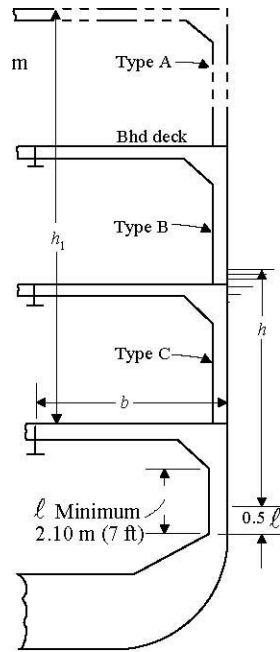

### 5.3 Tween-deck Frames

- The section modulus, SM, of each transverse side frame above the chine or upper turn of bilge, in association with the plating to which the frame is attached, is not to be less than obtained from the following equation:

$$SM = 7.8chs\ell^2 \text{ cm}^3$$

$$SM = 0.0041chs\ell^2 \text{ in}^3$$

where

$$c = 0.90$$

$$h = 0.032L - 0.68 \text{ m (0.032L - 2.23 ft) type A frame}$$

$$= 0.049L - 0.81 \text{ m (0.049L - 2.66 ft) type B frame}$$

$$= 0.052L - 0.13 \text{ m (0.052L - 0.43 ft) type C frame}$$

= in no case less than the vertical distance, in m (ft), from the mid-length of the frame to the freeboard deck, but not less than  $0.02L + 0.46 \text{ m (0.02L + 1.5 ft)}$

s = frame spacing, in m (ft)

$\ell$  = tween deck height or unsupported length along frame, whichever is greater, in m (ft), not to be taken less than 2.13 m (7.0 ft). For frame types, see 3-2-5/Figure 3. Forward of 0.125L, frames above the bulkhead or freeboard deck are to be type B frames.

Longitudinal tween deck frames are to meet the requirements of 3-2-5/3. The section modulus of each longitudinal tween deck frame forward of 0.125L from the stem is to be not less than required by 3-2-5/5.1 for transverse frames in the same location, taking  $\ell$  as the unsupported span along the frame length.

## 7 Side Web Frames

### 7.1 Section Modulus

The section modulus, SM, of each side web frame supporting longitudinal framing or shell stringers above the chine or upper turn of bilge, in association with the plating to which the web frame is attached, is not to be less than that obtained from the following equation:

$$SM = 7.8chs\ell^2 \text{ cm}^3$$

$$SM = 0.0041chs\ell^2 \text{ in}^3$$

where

c = 0.915 aft of the forepeak

= 1.13 in the forepeak of vessel 61 m (200 ft) or greater in length.

s = frame spacing, in m (ft)

$\ell$  = straight-line unsupported span, in m (ft). Where brackets are fitted in accordance with 3-1-2/5.5 and are supported by decks or inner bottoms, the length,  $\ell$ , may be measured as permitted therein

h = on frames having no tween decks above, the vertical distance, in m (ft), from the mid length of the frame to the freeboard deck at side, but not less than  $0.02L + 0.46 \text{ m}$  ( $0.02L + 1.5 \text{ ft}$ ).

= on frames having tween decks above, the vertical distance, in m (ft), from the middle of  $\ell$  to the load line or  $0.5\ell$ , whichever is greater, plus  $bh_1/45K$  ( $bh_1/150K$ ).

b = horizontal distance, in m (ft), from the outside of the frames to the first row of deck beams supports.

$h_1$  = vertical distance, in m (ft), from the deck at the top of the web frame to the bulkhead or freeboard deck plus the height of all cargo tween deck spaces above the bulkhead or freeboard deck plus one-half the height of all passenger spaces above the bulkhead or freeboard deck, or plus 2.44 m (8 ft), if that is greater. Where the cargo load differs from  $715 \text{ kgf/m}^3$  ( $45 \text{ lbf/ft}^3$ ),  $h_1$  is to be adjusted accordingly.

K = 1.0 where the deck is longitudinally framed and a deck transverse is fitted in way of each web frame.

= the number of transverse frame spaces between web frames where the deck is transversely framed.

### 7.3 Tween-deck Web Frames

Tween-deck web frames are to be fitted below the bulkhead deck over the hold web frames, as may be required to provide continuity of transverse strength above the main web frames in holds and machinery space.

## 7.5 Proportions

The depth of each web frame is to be not less than  $125\ell$  mm (1.5 $\ell$  in.) or, unless effective compensation is provided for cutouts, 2.5 times the cutout for frame or longitudinal if greater. The thickness of the web of web frame or stringer is to be not less than 0.01 times the depth plus 3 mm (0.12 in.),  $\ell$  is as defined in 3-2-5/7.1.

## 9 Recommendation for Vessels Subject to Impact

For vessels subject to impact loadings during routines, it is recommended that side frames with a section modulus 25% greater than that obtained above be provided.

## 11 Side Stringers

### 11.1 Section Modulus

The section modulus, SM, of each side stringer in association with the plating to which the side stringer is attached is not to be less than that obtained from the following equation:

$$SM = 7.8chs\ell^2 \text{ cm}^3$$

$$SM = 0.0041chs\ell^2 \text{ in}^3$$

where

$$c = 0.915$$

= 1.13 in the forepeak of vessel 61 m (200 ft) or greater in length.

$h$  = vertical distance, in m (ft), from the middle of  $s$  to the freeboard deck at side, but not less than  $0.02L + 0.46$  m ( $0.02L + 1.5$  ft).

= for stringers above the lowest deck or at a similar height in relation to the design draft, not less than given in 3-2-5/5.3 appropriate to the tween deck location.

= for stringers in the peaks of vessels 61 m (200 ft) or greater in length, not less than given in 3-2-5/5.5.

$s$  = sum of the half lengths, in m (ft), (on each side of the stringer) of the frames supported.

$\ell$  = span, in m (ft), between web frames, or between web frame and bulkhead. Where brackets are fitted in accordance with 3-1-2/5.5 and are supported by transverse bulkheads, the length,  $\ell$ , may be measured as permitted therein.

### 11.3 Proportions

Side stringers are to have a depth of not less than  $0.125\ell$  (1.5 in per ft of span  $\ell$ ) plus one-quarter of the depth of the slot for the frames, but need not exceed the depth of the web frames to which they are attached. In general, the depth is not to be less than 2.5 times the depth of the slots, or the slots are to be

fitted with filler plates. The thickness of each stringer is to be not less than  $0.014L + 7.2$  mm ( $0.00017L + 0.28$  in.) where L is as defined in 3-1-1/3.

## APPENDIX B – Global Variable Description

There are two global variables in PCAT: USER which holds the user inputs, and HULL which holds the details of each specific variant, both are structures. Because there is more than one variant HULL is set up as a matrix, where the first dimension is the variant number, and the second dimension is the run number. Each of the two variables are structures with multiple fields. They are described in detail below.

Matlab is a case sensitive code, and in PCAT, HULL and USER are capitalized to bring attention to these global variables. Virtually all of the rest of the variables and fields are in lowercase. To aide a person in editing the code, all variables discussed in this thesis are capitalized in the same manner as in PCAT.

Name: **USER.geometry**

Data type: structure

Purpose: Stores user information from the geometry screen.

Name: **USER.geometry.length**

Data type: array

Purpose: Stores an array of user specified lengths. Lengths are stored in feet.

Example: [90 100 110]

Name: **USER.geometry.ltoB**

Data type: array

Purpose: Stores an array of user specified ratios of length to beams. Ratios are non-dimensional.

Example: [4.5 5.2]

Name: **USER.geometry.ltoD**

Data type: array

Purpose: Stores an array of user specified ratios of length to depths at midships. Ratios are non-dimensional.

Example: [7 7.5 8.15]

Name: **USER.geometry.ph**

Data type: cell holding a string or strings

Purpose: Stores a name of the parent hull.

Example: {'NPL High Speed Round Bilge' 'PC-14'}

Name: **USER.geometry.dh**

Data type: array

Purpose: Stores an array of user specified deck heights. Deck height is stored in feet.

Example: [9]

Name: **USER.loading**

Data type: structure  
Purpose: Stores user information from the loading screen.

Name: **USER.loading.kgtod**

Data type: array

Purpose: Stores an array of user specified ratios of the center of gravity to depth at midships.  
Ratios are non-dimensional.

Example: [0.6]

Name: **USER.loading.lcg**

Data type: array or string

Purpose: Stores an array of user specified ratios of the longitudinal center of gravity to the length between perpendiculars. Ratios are non-dimensional. When set to 'd', PCAT will set the LCG to the default value of the longitudinal center of buoyancy (LCB) if the LCG falls between the values of -0.02 and -0.13. If it does not, LCG is set to the nearest valid value (either -0.02 or -0.13). Note that HULL.loading.lcg will never be reset from 'd', the LCG is set in the variable HULL for the particular variant.

Example: 'd'

Name: **USER.loading.materials**

Data type: cell holding a string or strings

Purpose: Stores the name of the material types to be used.

Example: {'Ordinary Strength Steel' 'AH-32'}

Name: **USER.loading.fs**

Data type: array

Purpose: Stores an array of user specified frame spacing values. Frame spacing is stored in feet.

Example: [5 5.5 6]

Name: **USER.machinery**

Data type: structure

Purpose: Stores user information from the machinery and manning screen relevant to machinery.

Name: **USER.machinery.eps**

Data type: array

Purpose: Stores an array of user specified number of engines per shaft. All engines on board will be the same type (there are no secondary engines). Only possible values are [1] and [1 2] corresponding to only 1 engine per shaft or either 1 or 2 engines per shaft.

Example: [1]

Name: **USER.machinery.shafts**

Data type: array

Purpose: Stores an array of user specified number of shafts.

Example: [2 4]

Name: **USER.manning**

Data type: structure

Purpose: Stores user information from the machinery and manning screen relevant to manning.

Name: **USER.manning.officer**

Data type: scalar

Purpose: Stores the percentage of total manning that is officers.

Example: [.15]

Name: **USER.manning.cpo**

Data type: scalar

Purpose: Stores the percentage of total manning that is chief petty officers.

Example: [.15]

Name: **USER.manning.enlisted**

Data type: scalar

Purpose: Stores the percentage of total manning that is junior enlisted.

Example: [.70]

Name: **USER.manning.total**

Data type: array

Purpose: Stores an array of user specified manning levels.

Example: [15 20 25]

Name: **USER.speed**

Data type: structure

Purpose: Stores user information from the speed screen relevant to machinery.

Name: **USER.speed.profile\_speed**

Data type: array

Purpose: Stores an array the array of containing the speeds entered in the speed profile. The length of this array is the same as the length of the profile\_percent array.

Example: [5 10 12.5 15 20]

Name: **USER.speed.profile\_percent**

Data type: array

Purpose: Stores an array the array of containing the percentages entered in the speed profile.

Element (n) corresponds to the nth element of the profile speed array. This array is the same as the length of the profile\_percent array, and the sum of all the elements is 100.

Example: [20 35 25 15 5]

Name: **USER.speed.max**

Data type: scalar

Purpose: Stores the user specified maximum speed in knots.

Example: [20]

Name: **USER.speed.endurance**

Data type: scalar or string

Purpose: Stores the user specified endurance speed in knots. If the user desires the endurance speed to be set to the most fuel efficient speed, this variable is set to 'd'.

Example: 'd' or [9]

Name: **USER.speed.range**

Data type: array

Purpose: Stores an array of user specified ranges.

Example: [700 800]

Name: **USER.weapons**

Data type: structure

Purpose: Stores user information from the weapons screen relevant to C4I, weapons, and navigation equipment. The information in this variable should account for all of the equipment in SWBS 400, SWBS 700, and the variable ammunition loads.

Name: **USER.weapons.id**

Data type: cell holding strings

Purpose: Hold identifiers for each weapon set. The length of this variable is equal to the number of weapon sets.

Example: {'Low' 'Med' 'High'}

Name: **USER.weapons.weight**

Data type: array

Purpose: Stores the weights for each weapons set in LT. The nth element of this array corresponds to the nth weapon set.

Example: [5 8 12]

Name: **USER.weapons.dharea**

Data type: array

Purpose: Stores the required main deck area for each weapons set in ft<sup>2</sup>. The nth element of this array corresponds to the nth weapon set.

Example: [100 150 200]

Name: **USER.weapons.iharea**

Data type: array

Purpose: Stores the required in-hull area for each weapons set in ft<sup>2</sup>. The nth element of this array corresponds to the nth weapon set.

Example: [300 300 400]

Name: **USER.weapons.power**

Data type: array

Purpose: Stores the required electrical power for each weapons set in kW. The nth element of this array corresponds to the nth weapon set. This value is not used in this version of the program.

Example: [100 120 170]

Name: **USER.weapons.kgtod**

Data type: array

Purpose: Stores the ratio of the height of the center of gravity of each weapons set above the keel over the midship's depth (KG/D). This number is non dimensional. The nth element of this array corresponds to the nth weapon set. This value is not used in this version of the program.

Example: [1 1.1 0.9]

Name: **USER.weapons.wmoe**

Data type: array

Purpose: Stores the measure of effectiveness of a given weapons system relative to the users own standard. Prior to using PCAT, the user must have developed measure of effectiveness for the weapons systems (wmoe). This can incorporate range of radars or weapons, warhead size, maintainability, ability to penetrate certain armor, interoperability, or any other way of comparing systems. The number stored in this variable should be between 0 and 1.

Example: [0.40 0.60 0.90]

Name: **USER.weapons.cost**

Data type: array

Purpose: Stores the cost of the weapons systems in thousands of dollars. The nth element of this array corresponds to the nth weapon set.

Example: [1100 2500 3000]

Name: **USER.omoe**

Data type: structure

Purpose: Level one fields (ops, mob, and weps) store the relative importance of the level one measures of effectiveness. The remaining fields are classified are level two.

The level one fields are: ops (operations), weps (weapons), and mob (mobility). They all hold a scalar representing the relative importance if the field. Level 1 fields should sum to 1.

The level two fields are:

USER.omoe.speed - maximum speed in kts

USER.omoe.endurance - days at sea

USER.omoe.range - maximum range in nm

USER.omoe.draft – design draft in ft

USER.omoe.md - available main deck space less the main deck space used by the weapons in ft<sup>2</sup>.

USER.omoe.ih - available in-hull deck space less the main deck space used by the weapons and the prime movers (ft<sup>2</sup>).

USER.omoe.man - manning of the ship created

USER.omoe.sea – Bales number of the ship.

The level two fields either have a length of 3, in which case the elements are [threshold goal moe] or a length of one in which case the element is [moe]. If the level two fields have a length of one the threshold value is set to the worst possible output and the goal value is set to the best

possible output in the course of the program. The first four fields (speed, endurance, range, and draft) are the mobility parameters. The sum of their moe's should be 1. The last four fields (md, ih, man, and sea) are the operation parameters. The sum of their moe's should also be 1. It is important to note that this variable **is** reassigned during the execution of PCAT so at the completion of the program, every level two field has a length of three.

Name: **USER.cost**

Data type: structure

Purpose: Holds relevant cost information. Each field holds a scalar value of the price of some aspect of the ship or other relevant cost parameters. The fields are:

OSS – price of ordinary strength steel in \$/LT

AH32 – price of high strength steel - AH32 in \$/LT

AH36 – price of high strength steel - AH36 in \$/LT

engine – price of the engine in \$/hp

manning – price of a man-year in \$/man-year

life – estimated life of the hull in years

ops – percent of time the variant is operational in percent

fuel – price of fuel in \$/lb

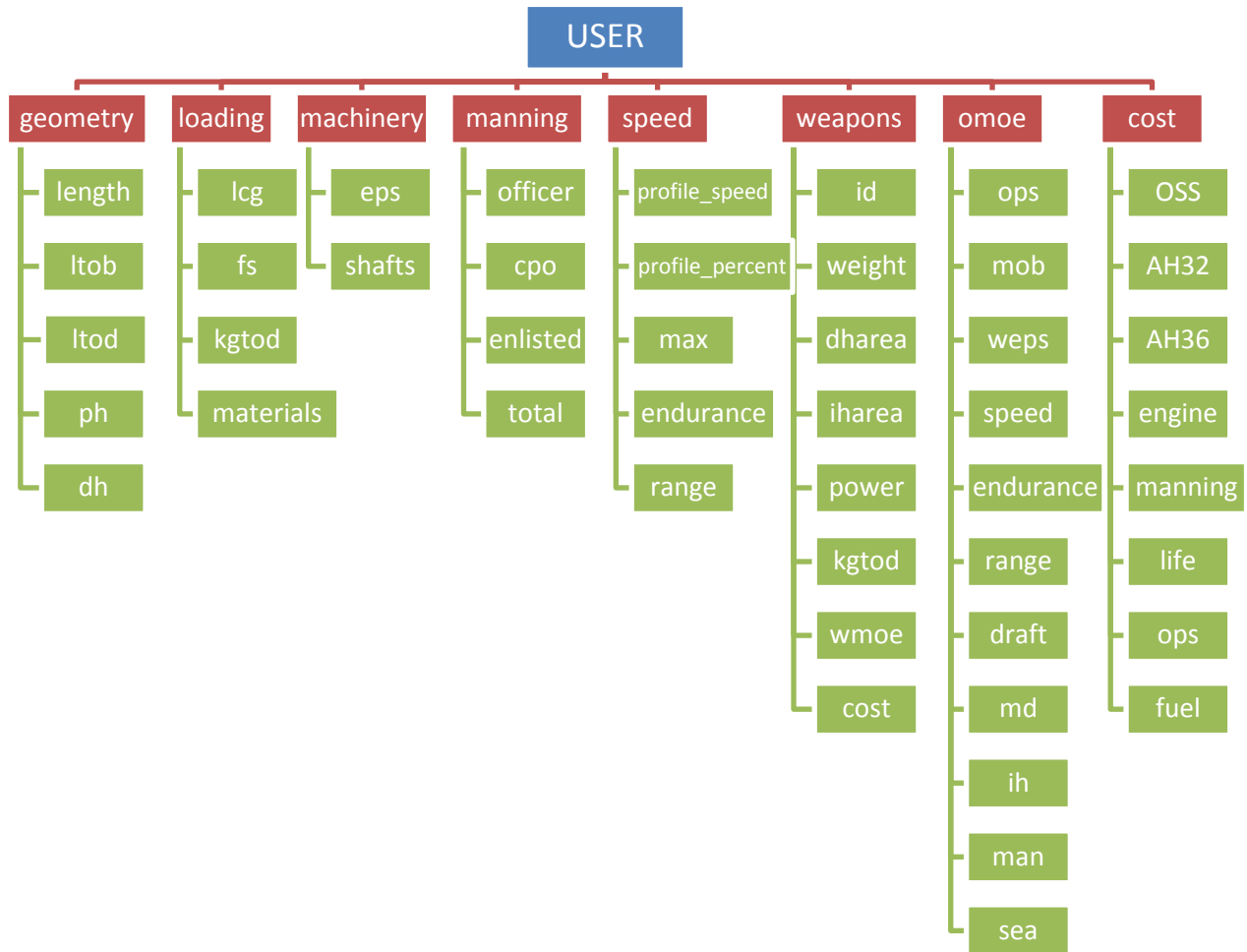

Figure B-1 USER variable breakdown

Name: **HULL**

Data type: structure

Purpose: Stores user information for a particular variant. HULL is sized by NxM, where N is the variant number and M is the run number. For the remainder of this appendix, HULL(N,M) will be represented as HULL.

Name: **HULL.geometry**

Data type: structure

Purpose: Holds relevant geometrical parameters for a particular variant. Fields are all scalars unless otherwise noted. Fields are:

- lbp – length between perpendiculars (ft), initially set by the user, but changes as the design draft of the ship is adjusted.
- loa – length overall (ft), unlike lbp, this variable is constant for a given hull throughout the design process.
- beam\_max – maximum ship beam (ft)
- depth – midships depth (ft)
- dh – deck height, or separation of internal decks (ft)

ph – cell containing a string that names the parent hull  
 wsa – wetted surface area (ft<sup>2</sup>), surface area of the wetted portion of the hull at design draft.  
 main\_deckarea – area of the main deck (ft<sup>2</sup>)  
 iharea – area of internal decks (ft<sup>2</sup>)  
 displacement – displacement of the ship at design draft (LT)  
 beam\_wl – beam of the ship at the waterline (ft)  
 Cb – block coefficient, defined as  $\frac{\text{Displaced Volume}}{\text{Design Draft} * \text{LBP} * \text{Beam at waterline}}$   
 Cp – prismatic coefficient, defined as  $\frac{\text{Displaced Volume}}{\text{Maximum submerged section area} * \text{LBP}}$   
 gm – metacentric height (ft)  
 km – height of the metacenter above the keel (ft)  
 draft – design draft (ft), initially set by the parent hull selection, but changes as ship is balanced.  
 offsets – structure holding offsets of the ship. This is described in more detail below.

Name: **HULL.geometry.offsets**

Data type: structure

Purpose: Holds the offsets for a ship. The offsets for this program are stored in an unconventional way to allow for easier processing of the data. This requires the user to ensure the data is properly formatted before entering a new hull. The offsets are broken into three coordinates X (longitudinal), Y (transverse), and Z (vertical) with the origin being at the forward perpendicular, centerline, and baseline respectively. Positive X is aft, positive Y is to port, and positive Z is upwards. To represent the offsets a grid is placed on the hull in the X-Z plane. Then at each point on the grid, the half breadth (Y) is calculated. So X is a 1xn sized array, Z is a 1xm sized array, and Y is a nxm sized matrix. If there is no offset at a particular point x,z. Then Y(n,m) is set to NaN, or not a number. NaN is a special Matlab value that is used in PCAT to alert the program that there is no hull at a particular point. Figure B-2 shows a generic hull form and the associated grid.

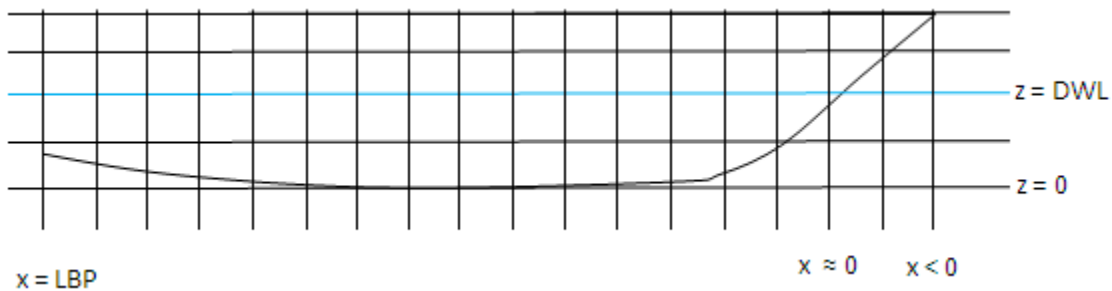

Figure B-2 Generic offset grid

The fields of HULL.geometry.offsets are X, Y, Z and t (initial draft). All are in ft.

Name: **HULL.loading**

Data type: structure

Purpose: Holds loading information for a specific variant. The fields HULL.loading are all scalar unless otherwise noted. The fields are

kg – estimate of the center of gravity of a hull (ft)  
lcg – distance from midships to longitudinal center of gravity (lcg) over length where a value > 0 is forward of midships. This variable is non dimensional.  
materials – cell holding a string that names the material  
fs – frame spacing (ft)

Name: **HULL.speed**

Data type: structure

Purpose: Holds speed and range information. All fields are scalar unless otherwise stated. The fields are:

profile\_speed – an array of speeds at which a variant is analyzed for resistance and fuel efficiencies. This array begins as the speeds in knots input by the user in the speed profile but then is "beefed up" to include at speeds in 1 knot increments from a Froude number of 0.1 to the maximum speed (if Froude number of the maximum speed is < 0.6).  
profile\_percent – an array representing the percent of the time a craft spends at a given speed when operational. This array is initially put in by the user. Zeroes are added for every speed that is added in the "beef up" process so the length of this array is the same as the length of profile\_speed.  
max – maximum speed (knots) input by the user  
endurance – endurance speed (knots) or 'd' for default. Either input by the user or calculated as the most fuel efficient speed.  
range – range of the variant in nm. See chapter 3 for more information on range.  
new\_max – final maximum speed of the hull accounting for the actual engines placed on board. This number will be greater than the value input by the user.  
endurance\_days – number of days the ship can stay at sea without refueling at endurance speed using 2/3 of the available fuel.

Name: **HULL.machinery**

Data type: structure

Purpose: Holds machinery information relevant to all engineroom machinery. All fields are scalar unless otherwise stated. The fields are:

eps – engines per shaft, can either be 1 or 2  
shafts – number of shafts on this variant  
endurance\_nm\_LT – fuel efficiency at endurance speed in nm per LT  
nm\_LT – an array the same length as the "beefed up" speed profile. Element (n) of this field is the fuel efficiency of the ship in nm per LT at a speed equal to HULL.speed.profile\_speed(n).  
sfc\_profile - an array the same length as the "beefed up" speed profile. Element (n) of this field is the specific fuel consumption of the ship in  $\frac{lbs}{hp * hr}$  at a speed equal to HULL.speed.profile\_speed(n).

Name: **HULL.weapons**

Data type: structure

Purpose: Holds the information on the weapons systems input by the user for a particular variant. The fields are the same as USER.weapons with the exception that each field of HULL.weapons only holds one value.

Name: **HULL.manning**

Data type: structure

Purpose: Holds the information on the manning of the variant. The fields are all scalar and in units of people. The fields are:

- officer – number of officers
- cpo – number of chief petty officers
- enlisted – number of junior enlisted
- total – total number of people

Name: **HULL.resistance**

Data type: structure

Purpose: Holds information on resistance and powering for a particular variant. The fields are all structures also.

- bhehp – bare hull effective horsepower (hp), stores the bare hull EHP of the hull as calculated using Compton's method.
- ehp – EHP with appendages (hp)
- bhp – Brake horsepower, or the horsepower required by the engine to move the ship at a given speed.

Each of these fields is a structure and has multiple parts. So for example HULL.resistance.bhp has three fields max, endurance, and profile corresponding to the required horsepower at maximum speed, endurance speed, and along the speed profile.

- max – horsepower at user specified maximum speed. This variable is a scalar.
- endurance – horsepower at endurance speed. Note this field will not exist for bhehp and ehp if the user set endurance to default. This variable is a scalar.
- profile – horsepower along the speed profile. This variable is an array of horsepowers the same length as the profile\_speed.

Name: **HULL.good**

Data type: scalar

Purpose: This scalar is initially set to 0 and then is change to 1 if the ship converges.

Name: **HULL.error**

Data type: string

Purpose: This string is the reason for a particular ship not converging.

Name: **HULL.engine**

Data type: structure

Purpose: Holds information on the propulsion engine selected. HULL.engine has the following fields:

- Model – a string holding the model name
- Specs – an array describing the model. The elements of Specs are:

[ID, length(ft), width(ft), height(ft), weight(LT), maximum BHP(hp), RPM(max)]  
SFC – an matrix describing the engine at different rpms. Each row of SFC corresponds to a different RPM. The first five elements are for the engine used in a non-marine environment. The second five elements are for the engine attached to a propeller. There for only the last five elements of each row of SFC were used in PCAT. Each row has the following elements.

[RPM, BHP, Torque(ft-lbs), SFC (lbs/hp-hr), GPH (gall/hr), RPM, BHP, Torque, SFC, GPH]  
SHP – the final shaft horsepower of the ship.

Name: **HULL.temp\_weight**

Data type: structure

Purpose: This structure has fields that hold weights generated outside of the weight module. The fields are:

F41 – Full load fuel loading (LT)

structures – weight of structures generated in the structures section (LT)

Name: **HULL.structures**

Data type: structure

Purpose: Holds information relevant to structures of a variant. All fields hold scalars unless otherwise stated. The fields are:

SM - limiting (minimum) section modulus of the midships section in ft-in<sup>2</sup>

bsp – bottom shell plating thickness (in)

ssp\_m – side shell plating thickness near midships (in)

ssp\_e – side shell plating thickness near the ends (in)

dp – array of deck plating thicknesses (in), element 1 is the main deck, element 2 is the first deck below the main deck, etc.

x\_bg – critical thickness of the bottom girder (in). See chapter 3 for more information on critical thicknesses.

x\_bf – critical thickness of the bottom frame (in)

x\_sf – critical thickness of the side frame (in)

x\_ss – critical thickness of the side stringers frame (in)

NA – location of the neutral axis above baseline (in)

Name: **HULL.weight**

Data type: array of structures

Purpose: HULL.weight is an array with length 10 where each element is a structure.

<b>Element of HULL.weight</b>	<b>Information stored</b>
HULL.weight(1)	Information on SWBS 100
HULL.weight(2)	Information on SWBS 200
HULL.weight(3)	Information on SWBS 300
HULL.weight(4)	Information on SWBS 400 and 700 and various variable loads
HULL.weight(5)	Information on SWBS 500
HULL.weight(6)	Information on SWBS 600
HULL.weight(7)	Only holds naming information
HULL.weight(8)	Empty
HULL.weight(9)	Information variable loads
HULL.weight(10)	Information on the total weight

**Table B-1 HULL.weight description**

HULL.weight(4) holds information on the weights for SWBS groups 400, SWBS 700 and the variable ammunition because the user inputs the weights for SWBS 400, SWBS 700 and the variable ammunition as a group and there is no reason to separate them. HULL.weight(9) holds the information on the remainder of the variable loads. The fields of each structure are:

- groups – scalar that holds the groups weight in LT
- SWBS – string that holds the SWBS number
- name – string that holds the name of the SWBS group.

Name: **HULL.seakeeping.bales**

Data type: scalar

Purpose: Holds the Bales number for the ship. This is nondimensional.

Name: **HULL.cost**

Data type: structure

Purpose: Stores the acquisition and lifecycle cost of a variant. It is important to realize that these are not actual costs, but rather they are costs of known materials. This is strictly used for comparison. The fields are all scalars.

- acquisition – acquisition cost in \$
- lifecycle – lifecycle cost in \$

Name: **HULL.output**

Data type: structure

Purpose: This variable holds information used in calculating the OMOE that are not explicitly stored elsewhere. Fields are all scalars.

- md\_area – main deck area less area used by weapons on the main deck (ft<sup>2</sup>)
- ih\_area – in-hull deck area less area used by weapons and prime movers in-hull (ft<sup>2</sup>)

Name: **HULL.omoe**

Data type: structure

Purpose: Holds all omoe data. Values in omoe are final measures of effectiveness, not relative importance. Fields are:

- omoe – scalar value for final omoe

moe\_1 – array of second tier moe results. First elements are related to mobility. The last four elements are related to operations. The elements are: [speed, endurance, range, draft, md\_area, ih\_area, manning, seakeeping]  
mob – scalar value for mobility moe  
ops – scalar value for operations moe  
weps – scalar value for weapons moe

Figure B-3 and Figure B-4 show the breakdown of HULL to the second level. HULL.geometry.offsets and all of the HULL.resistance fields are broken down to the third level as described above.

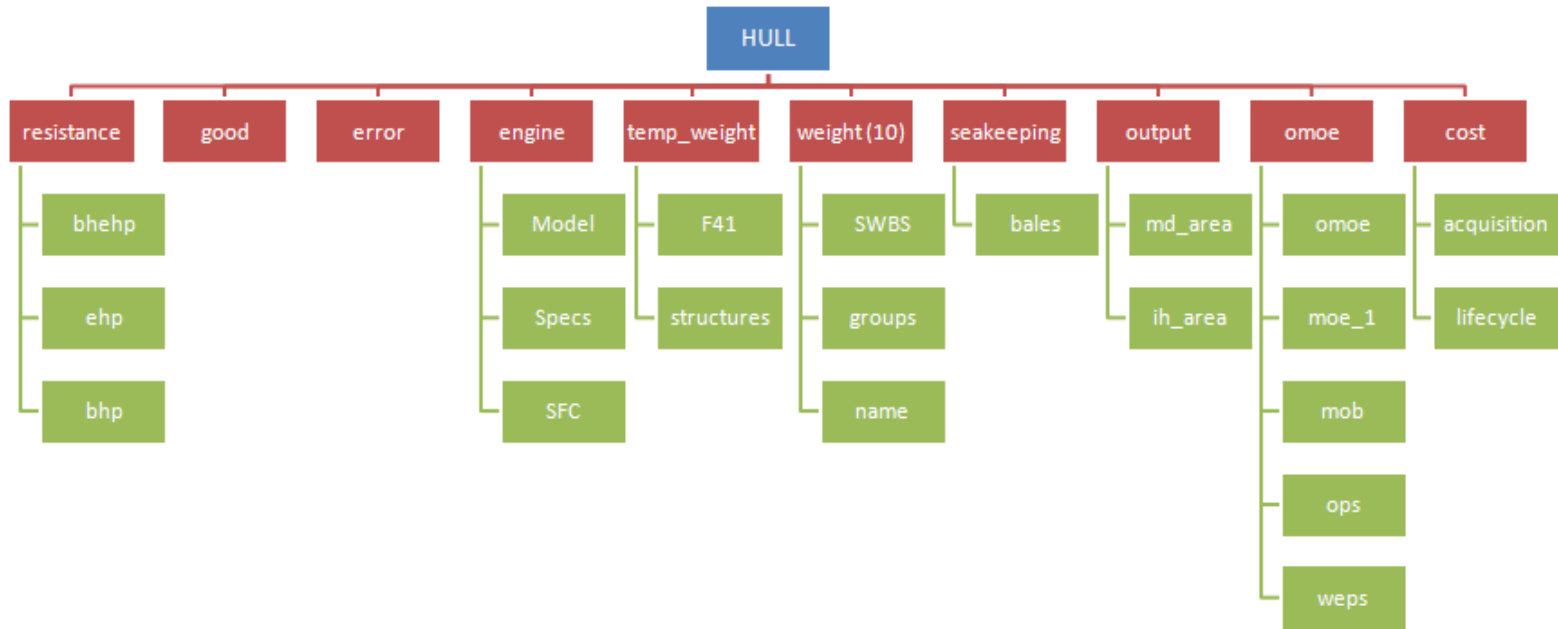

**Figure B-3 HULL Variable**

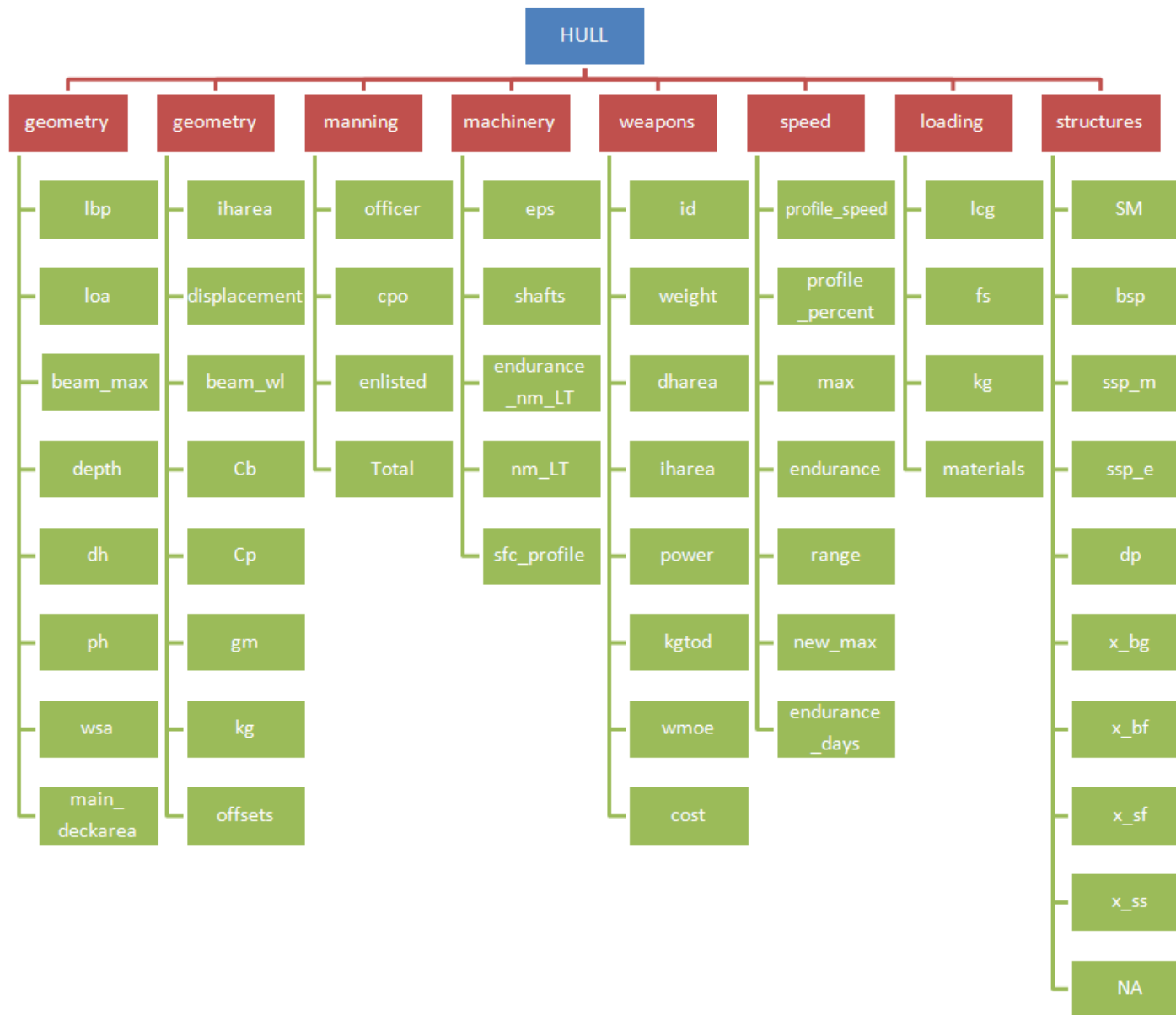

Figure B-4 HULL Variable

## APPENDIX C – Engine Library

The data for the engines was taken directly from the Caterpillar Inc. web site, <http://marinewizard.catmms.com/catwizards/marineWizard/jsp/main.jsp>.

The specs array 'catEN(n).Specs' is set up in the following way:

[ID Length(ft) Width(ft) Height(ft) Weight(LT) Maximum BHP(hp) RPM(max)]

The SFC matrix 'catEN(n).SFC' is used to calculate the specific fuel consumption of an engine is setup so each row corresponds to a particular engine power. The columns are set up as follows:

[RPM BHP (hp) Torque (ft-lbf) SFC (lbf/hp-hr) GPH RPM BHP Torque SFC GPH]

The first 5 elements of a row are for an engine not in marine use, the second 5 elements of a row are for the engine in marine use. Therefore only the last 5 elements of each row are used in PCAT. The final three engines did not have complete data available through Caterpillar so some parameters were estimated using(16) Additionally, the lower engines were modeled at very low RPM to allow for interpolation of SFC at low power. This was also done using Woud and Stapersma.

The model array 'catEN(n).Model' holds a string with the name of the model.

```
catEN(1).Model='Caterpillar C7-315';
catEN(1).Specs=[7315 4.01 2.87 3.06 0.79 315 2400];
catEN(1).SFC=[2400 315 689 0.378 17.0 2400 315 690 0.378 17.0
2200 315 752 0.365 16.4 2200 243 580 0.361 12.5
2000 315 827 0.357 16.1 2000 182 479 0.359 9.4
1800 315 919 0.356 16.0 1800 133 388 0.367 7.0
1600 274 900 0.362 14.2 1600 93 307 0.380 5.1
1400 226 848 0.376 12.1 1400 62 235 0.397 3.5
1200 176 770 0.399 10.0 1200 39 173 0.420 2.4
1000 127 668 0.432 7.8 1000 23 119 0.449 1.5
1 1 1 0.648 0 1 1 1 0.648 0];

catEN(2).Model='Caterpillar C9-503';
catEN(2).Specs=[9503 3.93 3.15 3.22 0.93 503 2500];
catEN(2).SFC=[2500 503 1056 0.362 26.0 2500 503 1056 0.362 26.0
2400 503 1100 0.357 25.6 2400 445 974 0.362 23.0
2300 503 1148 0.349 25.1 2300 392 894 0.358 20.0
2200 509 1216 0.342 24.9 2200 343 818 0.352 17.2
2100 509 1275 0.338 24.6 2100 298 746 0.347 14.8
1900 508 1404 0.336 24.4 1900 221 610 0.350 11.0
1800 495 1443 0.335 23.7 1800 188 548 0.356 9.5
1700 469 1450 0.335 22.4 1700 158 488 0.361 8.2
1600 436 1430 0.337 21.0 1600 132 433 0.367 6.9
1500 378 1324 0.353 19.0 1500 109 381 0.373 5.8
1300 235 948 0.408 13.7 1300 71 285 0.390 3.9
1100 162 774 0.461 10.7 1100 43 204 0.412 2.5
1000 137 718 0.471 9.2 1000 32 169 0.425 2.0
```

```

900      113      657      0.469      7.5      900      23      137      0.442      1.5
800      91       599      0.466      6.1      800      16      108      0.473      1.1
600      58       504      0.478      3.9      600      7       61       0.582      0.6
1        1         1        0.655      0        1        1       1        0.655      0];

catEN(3).Model='Caterpillar C12-660';
catEN(3).Specs=[12660  5.16  3.47  3.30  1.16  660  2300];
catEN(3).SFC=[2300  660 1507  0.362  34.1  2300  660 1507 0.362  34.1
2200  664  1584  0.352  33.4  2200  577  1378  0.347  28.6
2000  661  1735  0.342  32.3  2000  434  1140  0.340  21.1
1800  662  1932  0.343  32.5  1800  316  923   0.344  15.5
1600  661  2170  0.350  33.0  1600  222  729   0.346  11.0
1400  545  2044  0.355  27.7  1400  149  558   0.345  7.3
1200  282  1235  0.356  14.3  1200  94   410   0.363  4.9
1000  172  904   0.353  8.7   1000  54   285   0.419  3.2
600   68   597   0.340  3.3   600   12   103   0.770  1.3
1     1     1     0.862  0     1     1     1     0.862  0];

catEN(4).Model='Caterpillar C15-800';
catEN(4).Specs=[15800  5.01  3.09  3.84  1.44  800  2300];
catEN(4).SFC=[2300  800 1827  0.355  40.6  2300  800 1828 0.355  40.6
2200  800  1910  0.354  40.4  2200  700  1672  0.340  34.0
2100  800  2000  0.353  40.4  2100  609  1524  0.332  28.9
2000  800  2101  0.353  40.3  2000  526  1382  0.330  24.8
1900  800  2211  0.353  40.3  1900  451  1247  0.332  21.4
1800  800  2334  0.354  40.4  1800  384  1120  0.335  18.4
1700  800  2472  0.356  40.6  1700  323  999   0.341  15.7
1600  800  2624  0.357  40.8  1600  269  884   0.347  13.4
1500  751  2630  0.355  38.1  1500  222  777   0.353  11.2
1400  606  2275  0.351  30.4  1400  181  677   0.358  9.2
1300  470  1897  0.352  23.6  1300  145  584   0.362  7.5
1200  329  1439  0.363  17.0  1200  114  498   0.366  5.9
1100  293  1397  0.380  15.9  1100  88   418   0.374  4.7
1000  255  1340  0.401  14.6  1000  66   345   0.386  3.6
1     1     1     0.599  0     1     1     1     0.599  0];

catEN(5).Model='Caterpillar C18-873';
catEN(5).Specs=[18873  5.11  3.47  3.85  1.56  873  2200];
catEN(5).SFC=[2200  873 2084  0.355  44.2  2200  873 2084 0.355  44.2
2100  873  2183  0.351  43.7  2100  759  1899  0.345  37.4
2000  873  2292  0.347  43.3  2000  656  1722  0.337  31.6
1900  873  2413  0.344  42.9  1900  562  1555  0.332  26.7
1800  873  2548  0.341  42.5  1800  478  1395  0.331  22.6
1700  833  2574  0.335  39.9  1700  403  1244  0.332  19.1
1600  784  2573  0.330  36.9  1600  336  1103  0.335  16.1
1500  662  2319  0.326  30.8  1500  277  969   0.338  13.4
1400  578  2167  0.327  26.9  1400  225  844   0.342  11.0
1300  495  2000  0.331  23.4  1300  180  728   0.345  8.9
1200  431  1888  0.336  20.7  1200  142  620   0.350  7.1
1000  356  1868  0.348  17.6  1000  82   431   0.367  4.3
800   211  1382  0.361  10.9  800   42   276   0.395  2.4
600   138  1212  0.381  7.5   600   18   155   0.437  1.1
1     1     1     0.526  0     1     1     1     0.526  0];

catEN(6).Model='Caterpillar C18-1001';
catEN(6).Specs=[181001  5.11  3.47  3.85  1.56  1001  2300];
catEN(6).SFC=[2300  1001  2286  0.362  51.7  2300  1001 2286 0.362  51.7

```

```

2200    1001    2390    0.356    50.9    2200    876    2092    0.346    43.3
2100    1001    2504    0.352    50.4    2100    762    1906    0.336    36.6
2000    1001    2629    0.350    50.1    2000    658    1729    0.330    31.0
1900    1001    2767    0.349    50.0    1900    564    1560    0.326    26.3
1800    985     2874    0.348    49.0    1800    480    1400    0.324    22.2
1700    964     2978    0.345    47.4    1700    404    1249    0.323    18.7
1600    925     3035    0.337    44.5    1600    337    1106    0.325    15.6
1500    846     2964    0.330    39.9    1500    278    972     0.329    13.1
1400    755     2834    0.331    35.7    1400    226    847     0.336    10.8
1300    620     2507    0.335    29.7    1300    181    730     0.343    8.8
1200    529     2314    0.336    25.4    1200    142    623     0.360    7.3
1000    342     1797    0.339    16.6    1000    82     432     0.451    5.3
800     229     1502    0.350    11.4    800     42     277     0.515    3.1
600     136     1194    0.371    7.2     600     18     156     0.592    1.1
1       1       1       0.701    0       1       1       1       0.701    0];

```

```

catEN(7).Model='Caterpillar 3412E-1200';
catEN(7).Specs=[341200 6.20 4.44 4.50 2.49 1200 2300];
catEN(7).SFC=[2300 1200 2741 0.354 60.6 2300 1200 2741 0.354 60.6
2200 1200 2865 0.353 60.5 2200 1050 2508 0.346 51.9
2100 1200 3001 0.353 60.5 2100 914 2285 0.343 44.7
2000 1200 3151 0.352 60.3 2000 789 2073 0.344 38.8
1900 1200 3316 0.350 60.0 1900 677 1870 0.350 33.8
1800 1200 3500 0.349 59.8 1800 575 1679 0.355 29.2
1700 1199 3705 0.348 59.7 1700 485 1497 0.359 24.9
1600 1199 3935 0.348 59.6 1600 404 1326 0.363 20.9
1500 1102 3857 0.348 54.7 1500 333 1166 0.370 17.6
1400 975 3660 0.350 48.8 1400 271 1016 0.378 14.6
1300 806 3258 0.362 41.7 1300 217 875 0.385 11.9
1200 639 2795 0.382 34.9 1200 170 746 0.391 9.5
1 1 1 0.671 0 1 1 1 0.671 0];

```

```

catEN(8).Model='Caterpillar 3412E-1350';
catEN(8).Specs=[341350 6.20 4.50 4.50 2.49 1350 2300];
catEN(8).SFC=[2300 1350 3084 0.359 69.3 2300 1350 3084 0.359 69.3
2200 1350 3223 0.363 70.0 2200 1182 2821 0.350 59.1
2100 1350 3377 0.364 70.2 2100 1028 2571 0.344 50.5
2000 1350 3545 0.364 70.1 2000 888 2332 0.343 43.5
1900 1350 3731 0.362 69.9 1900 761 2104 0.347 37.7
1800 1349 3935 0.360 69.3 1800 647 1889 0.351 32.4
1700 1298 4009 0.355 65.9 1700 545 1685 0.354 27.6
1600 1226 4026 0.351 61.4 1600 455 1492 0.358 23.2
1500 1102 3857 0.347 54.6 1500 375 1311 0.365 19.5
1400 975 3660 0.350 48.7 1400 305 1142 0.373 16.2
1300 806 3258 0.362 41.7 1300 244 985 0.380 13.2
1200 639 2795 0.382 34.9 1200 192 839 0.385 10.5
1 1 1 0.660 0 1 1 1 0.660 0];

```

```

catEN(9).Model='Caterpillar C30-1500';
catEN(9).Specs=[301500 5.94 4.64 4.52 2.51 1500 2300];
catEN(9).SFC=[2300 1500 3425 0.376 80.5 2300 1500 3525 0.376 80.5
2200 1500 3581 0.368 78.8 2200 1313 3134 0.356 66.7
2100 1500 3751 0.363 77.7 2100 1142 2855 0.345 56.3
2000 1500 3939 0.360 77.2 2000 986 2590 0.342 48.2
1900 1500 4147 0.360 77.1 1900 846 2337 0.344 41.5
1800 1475 4303 0.359 75.7 1800 719 2098 0.346 35.5
1700 1428 4413 0.355 72.4 1700 606 1871 0.349 30.2

```

1600	1345	4414	0.350	67.2	1600	505	1657	0.351	25.4
1500	1230	4308	0.345	60.6	1500	416	1457	0.354	21.1
1400	1030	3865	0.348	51.2	1400	338	1269	0.357	17.2
1200	745	3261	0.369	39.3	1200	213	932	0.366	11.1
1000	486	2555	0.388	26.9	1000	123	648	0.393	6.9
600	216	1886	0.388	11.9	600	27	233	0.519	2.0
1	1	1	0.621	0	1	1	1	0.621	0];

```
catEN(10).Model='Caterpillar C32-1652';
catEN(10).Specs=[321652 6.05 4.64 4.52 2.51 1652 2300];
catEN(10).SFC=[2300 1652 3773 0.366 86.4 2300 1652 3773 0.366 86.4
2200 1652 3944 0.361 85.1 2200 1446 3452 0.347 71.6
2100 1652 4132 0.357 84.3 2100 1257 3145 0.337 60.5
2000 1652 4338 0.357 84.3 2000 1086 2853 0.334 51.9
1900 1652 4567 0.359 84.8 1900 931 2575 0.334 44.5
1800 1634 4768 0.361 84.3 1800 792 2311 0.336 38.0
1700 1554 4802 0.356 79.1 1700 667 2061 0.338 32.2
1600 1499 4921 0.346 74.0 1600 556 1825 0.340 27.0
1500 1417 4961 0.334 67.6 1500 458 1605 0.343 22.4
1400 1294 4856 0.327 60.5 1400 373 1398 0.345 18.4
1300 1127 4552 0.330 53.2 1300 298 1205 0.348 14.8
1200 905 3963 0.340 44.0 1200 235 1027 0.353 11.8
1100 704 3363 0.350 35.2 1100 181 863 0.362 9.3
1000 617 3241 0.358 31.6 1000 136 713 0.375 7.3
700 318 2385 0.370 16.8 700 47 350 0.445 3.0
1 1 1 0.554 0 1 1 1 0.554 0];
```

```
catEN(11).Model='Caterpillar C32-1800';
catEN(11).Specs=[321800 6.48 4.62 4.53 2.90 1800 2300];
catEN(11).SFC=[2300 1800 4110 0.366 94.2 2300 1800 4110 0.366 94.2
2200 1800 4296 0.359 92.2 2200 1575 3760 0.360 81.0
2100 1800 4501 0.358 92.0 2100 1370 3426 0.350 68.6
2000 1800 4726 0.361 92.9 2000 1183 3107 0.340 57.4
1900 1800 4975 0.365 93.8 1900 1014 2804 0.331 47.9
1800 1767 5157 0.362 91.3 1800 863 2517 0.330 40.7
1700 1702 5257 0.353 85.7 1700 727 2245 0.333 34.6
1600 1637 5375 0.343 80.3 1600 606 1988 0.337 29.1
1500 1499 5249 0.338 72.3 1500 499 1748 0.341 24.3
1400 1340 5026 0.340 65.0 1400 406 1522 0.346 20.1
1300 1082 4372 0.349 53.9 1300 325 1313 0.351 16.3
1200 837 3663 0.358 42.8 1200 256 1119 0.357 13.0
1100 671 3202 0.366 35.1 1100 197 940 0.362 10.2
1000 586 3078 0.370 31.0 1000 148 777 0.369 7.8
700 287 2153 0.363 14.9 700 51 381 0.433 3.1
600 205 1796 0.355 10.4 600 32 280 0.471 2.1
1 1 1 0.626 0 1 1 1 0.626 0];
```

```
catEN(12).Model='Caterpillar 3512B-2250';
catEN(12).Specs=[352250 8.825 6.50 5.96 6.43 2250 1925];
catEN(12).SFC=[1925 2250 6139 0.341 109.6 1925 2250 6139 0.341 109.6
1600 2127 6982 0.327 99.5 1600 1292 4242 0.330 60.9
1400 1486 5574 0.332 70.5 1400 866 3247 0.339 42.0
1100 715 3413 0.359 36.7 1100 420 2005 0.350 21.0
900 496 2896 0.370 26.2 900 230 1342 0.372 12.2
650 300 2427 0.383 16.3 650 87 700 0.469 5.8
1 1 1 0.644 0 1 1 1 0.644 0];
```

```

catEN(13).Model='Caterpillar 3512C-2541';
catEN(13).Specs=[352541 8.76 7.32 6.35 6.76 2541 1800];
catEN(13).SFC=[1800 2541 7415 0.354 128.4 1800 2541 7415 0.354 128.4
1500 2384 8346 0.336 114.3 1500 1471 5149 0.323 67.8
1300 1986 8024 0.325 92.2 1300 957 3868 0.330 45.1
1100 1008 4815 0.338 48.7 1100 580 2769 0.334 27.7
900 686 4003 0.345 33.8 900 318 1853 0.382 17.3
700 432 3245 0.478 21.4 700 150 1121 0.478 6.9
1 1 1 0.733 0 1 1 1 0.733 0];

```

```

catEN(14).Model='Caterpillar 3516B-2800';
catEN(14).Specs=[352800 12.22 7.03 6.30 7.69 2800 1880];
catEN(14).SFC=[1880 2800 78323 0.332 132.7 1880 2800 78323 0.332 132.7
1600 2800 9191 0.321 128.5 1600 1726 5666 0.332 81.8
1400 2654 9956 0.325 123.2 1400 1156 4338 0.337 55.7
1100 825 3938 0.356 41.9 1100 561 2678 0.353 28.3
900 542 3162 0.361 27.9 900 307 1793 0.371 16.3
650 343 2774 0.371 18.2 650 116 935 0.444 7.3
1 1 1 0.576 0 1 1 1 0.576 0];

```

```

catEN(15).Model='Caterpillar 3516C-3386';
catEN(15).Specs=[353386 10.57 7.32 6.78 8.15 3386 1800];
catEN(15).SFC=[1800 3386 9880 0.330 159.8 1800 3386 9880 0.330 159.8
1500 2856 10001 0.315 126.6 1500 1959 6861 0.314 88.0
1300 2206 8913 0.312 98.2 1300 1276 5153 0.323 58.9
1100 1325 6326 0.333 63.0 1100 773 3690 0.337 37.2
900 712 4155 0.342 34.8 900 423 2470 0.396 24.0
700 497 3728 0.514 24.5 700 199 1294 0.514 10.2
1 1 1 0.827 0 1 1 1 0.827 0];

```

%profile data is estimated from Woud and Stampersma and caterpillar data

```

catEN(16).Model='Caterpillar 3608-3634';
catEN(16).Specs=[363634 18.25 5.67 8.67 18.66 3634 1000];
catEN(16).SFC=[1000 5444 0 0.322 0 0 5444 0 0.329 0
0 0 0 0 0 0 2000 0 0.334 0
0 0 0 0 0 0 1200 0 0.349 0
0 0 0 0 0 0 700 0 0.383 0
0 0 0 0 0 0 400 0 0.443 0
0 0 0 0 0 0 200 0 0.612 0
0 0 0 0 0 0 1 0 0.863 0];

```

```

catEN(17).Model='Caterpillar 3612-5444';
catEN(17).Specs=[365444 15.92 5.75 11.67 25.57 5444 1000];
catEN(17).SFC=[1000 5444 0 0.322 0 0 5444 0 0.329 0
0 0 0 0 0 0 3158 0 0.333 0
0 0 0 0 0 0 1797 0 0.349 0
0 0 0 0 0 0 980 0 0.389 0
0 0 0 0 0 0 653 0 0.434 0
0 0 0 0 0 0 436 0 0.524 0
0 0 0 0 0 0 1 0 0.883 0];

```

```

catEN(18).Model='Caterpillar 3616-7268';
catEN(18).Specs=[367268 18 5.58 10.4 28.05 7268 1000];
catEN(18).SFC=[1000 7268 0 0.322 0 0 7268 0 0.329 0
0 0 0 0 0 0 4215 0 0.333 0
0 0 0 0 0 0 2398 0 0.349 0

```

```
0 0 0 0 0 0 1308 0 0.389 0
0 0 0 0 0 0 872 0 0.434 0
0 0 0 0 0 0 581 0 0.524 0
0 0 0 0 0 0 1 0 0.883 0];
```