

NPS-AM-07-037



EXCERPT FROM THE PROCEEDINGS

OF THE
FOURTH ANNUAL ACQUISITION
RESEARCH SYMPOSIUM
THURSDAY SESSIONS

**Managing the Service Supply Chain in Department of Defense:
Implications for the Program Management Infrastructure**

Published: 30 April 2007

by

Rene G. Rendon, Lecturer, and

Uday Apte, Professor, Naval Postgraduate School

**4th Annual Acquisition Research Symposium
of the Naval Postgraduate School:**

**Acquisition Research:
Creating Synergy for Informed Change**

May 16-17, 2007

Approved for public release, distribution unlimited.

Prepared for: Naval Postgraduate School, Monterey, California 93943



ACQUISITION RESEARCH PROGRAM
GRADUATE SCHOOL OF BUSINESS & PUBLIC POLICY
NAVAL POSTGRADUATE SCHOOL

Report Documentation Page

*Form Approved
OMB No. 0704-0188*

Public reporting burden for the collection of information is estimated to average 1 hour per response, including the time for reviewing instructions, searching existing data sources, gathering and maintaining the data needed, and completing and reviewing the collection of information. Send comments regarding this burden estimate or any other aspect of this collection of information, including suggestions for reducing this burden, to Washington Headquarters Services, Directorate for Information Operations and Reports, 1215 Jefferson Davis Highway, Suite 1204, Arlington VA 22202-4302. Respondents should be aware that notwithstanding any other provision of law, no person shall be subject to a penalty for failing to comply with a collection of information if it does not display a currently valid OMB control number.

| | | | | | |
|--|------------------------------------|---|--|-------------------------------------|------------------------------------|
| 1. REPORT DATE 30 APR 2007 | 2. REPORT TYPE | 3. DATES COVERED 00-00-2007 to 00-00-2007 | | | |
| 4. TITLE AND SUBTITLE Managing the Service Supply Chain in Department of Defense: Implications for the Program Management Infrastructure | | 5a. CONTRACT NUMBER | | | |
| | | 5b. GRANT NUMBER | | | |
| | | 5c. PROGRAM ELEMENT NUMBER | | | |
| 6. AUTHOR(S) | | 5d. PROJECT NUMBER | | | |
| | | 5e. TASK NUMBER | | | |
| | | 5f. WORK UNIT NUMBER | | | |
| 7. PERFORMING ORGANIZATION NAME(S) AND ADDRESS(ES) Naval Postgraduate School, Monterey, CA, 93943 | | 8. PERFORMING ORGANIZATION REPORT NUMBER | | | |
| 9. SPONSORING/MONITORING AGENCY NAME(S) AND ADDRESS(ES) | | 10. SPONSOR/MONITOR'S ACRONYM(S) | | | |
| | | 11. SPONSOR/MONITOR'S REPORT NUMBER(S) | | | |
| 12. DISTRIBUTION/AVAILABILITY STATEMENT Approved for public release; distribution unlimited | | | | | |
| 13. SUPPLEMENTARY NOTES 4th Annual Acquisition Research Symposium: Creating Synergy for Informed Change, May 16-17, 2007 in Monterey, CA | | | | | |
| 14. ABSTRACT | | | | | |
| 15. SUBJECT TERMS | | | | | |
| 16. SECURITY CLASSIFICATION OF: | | | 17. LIMITATION OF ABSTRACT Same as Report (SAR) | 18. NUMBER OF PAGES 58 | 19a. NAME OF RESPONSIBLE PERSON |
| a. REPORT unclassified | b. ABSTRACT unclassified | c. THIS PAGE unclassified | | | |

The research presented at the symposium was supported by the Acquisition Chair of the Graduate School of Business & Public Policy at the Naval Postgraduate School.

To request Defense Acquisition Research or to become a research sponsor, please contact:

NPS Acquisition Research Program
Attn: James B. Greene, RADM, USN, (Ret)
Acquisition Chair
Graduate School of Business and Public Policy
Naval Postgraduate School
555 Dyer Road, Room 332
Monterey, CA 93943-5103
Tel: (831) 656-2092
Fax: (831) 656-2253
E-mail: jbgreene@nps.edu

Copies of the Acquisition Sponsored Research Reports may be printed from our website www.acquisitionresearch.org

Conference Website:
www.researchsymposium.org



ACQUISITION RESEARCH PROGRAM
GRADUATE SCHOOL OF BUSINESS & PUBLIC POLICY
NAVAL POSTGRADUATE SCHOOL

Proceedings of the Annual Acquisition Research Program

The following article is taken as an excerpt from the proceedings of the annual Acquisition Research Program. This annual event showcases the research projects funded through the Acquisition Research Program at the Graduate School of Business and Public Policy at the Naval Postgraduate School. Featuring keynote speakers, plenary panels, multiple panel sessions, a student research poster show and social events, the Annual Acquisition Research Symposium offers a candid environment where high-ranking Department of Defense (DoD) officials, industry officials, accomplished faculty and military students are encouraged to collaborate on finding applicable solutions to the challenges facing acquisition policies and processes within the DoD today. By jointly and publicly questioning the norms of industry and academia, the resulting research benefits from myriad perspectives and collaborations which can identify better solutions and practices in acquisition, contract, financial, logistics and program management.

For further information regarding the Acquisition Research Program, electronic copies of additional research, or to learn more about becoming a sponsor, please visit our program website at:

www.acquisitionresearch.org

For further information on or to register for the next Acquisition Research Symposium during the third week of May, please visit our conference website at:

www.researchsymposium.org



THIS PAGE INTENTIONALLY LEFT BLANK



Managing the Service Supply Chain in Department of Defense: Implications for the Program Management Infrastructure

Presenter: Rene G. Rendon is on the faculty of the Naval Postgraduate School where he teaches graduate acquisition and contract management courses. Prior to his appointment at the Naval Postgraduate School, he served for more than 22 years as an acquisition and contracting officer in the United States Air Force. His Air Force career included assignments as a contracting officer for major space launch systems and satellite programs, as well as the F-22 Advanced Tactical Fighter and the Peacekeeper ICBM. Rendon also served as a contracting squadron commander, and as a contracts manager for the NCR Corporation. He has earned Bachelor, Master's, and Doctorate degrees in business administration and has taught for the UCLA Government Contracts program and was also a senior faculty member for the Keller Graduate School of Management.

Author: Uday Apte, is Professor of Operations Management, Graduate School of Business and Public Policy, Naval Postgraduate School, Monterey, CA, and Associate Professor, Cox School of Business, Southern Methodist University, Dallas, TX. He teaches operations management courses in the Executive and Full-time MBA programs. His areas of expertise and research interests are in service operations, supply chain management and globalization of information-intensive services.

Prior to joining the Cox School, he worked for over ten years in managing information technology and operations functions in the financial services and utility industries. Since then he has consulted with several major US corporations and international organizations including IBM, Texas Instruments, Nokia, Kinko's, Nationwide Insurance, Nations Bank and The World Bank.

He holds a PhD in Decision Sciences from the Wharton School, University of Pennsylvania, where he taught in the MBA and undergraduate business programs for over ten years. His earlier academic background includes a MBA from the Asian Institute of Management, Manila, Philippines, and Bachelor of Technology from the Indian Institute of Technology, Bombay, India.

Dr. Apte has published over 30 articles, five of which have won awards from professional societies. His research articles have been published in prestigious journals including, Management Science, Journal of Operations Management, Decision Sciences, IIE Transactions, Interfaces, and MIS Quarterly. He has co-authored one book, Manufacturing Automation and has completed work on another co-authored book, Managing in the Information Economy.

Rene G. Rendon
Lecturer
Graduate School of Business and Public Policy
Naval Postgraduate School
Monterey, CA 93945-5197
Tel: (831) 656-3464
E-mail: rgrendon@nps.edu

Uday Apte, Professor
Graduate School of Business and Public Policy
Naval Postgraduate School
555 Dyer Street
Monterey, CA 93943
Phone: 831.656.3598
E-mail: umapte@nps.edu



Introduction

The services acquisition volume in the US Department of Defense (DoD) has continued to increase in scope and dollars in the past decade. In fact, in recent years, the DoD has spent more on services than on supplies, equipment and goods, even considering the high value of weapon systems and large military items (Camm, Blickstein & Venzor, 2004). Between FY 1999 to FY 2003, the DoD's spending on services increased by 66%; and in FY 2003, the DoD spent over \$118 billion (or approximately 57% of total DoD procurement dollars) on services (GAO, 2005a). The acquired services presently cover a very broad set of service activities, including: professional, administrative, and management support; construction, repair, and maintenance of facilities and equipment; information technology; research and development, and medical care.

As the DoD's services acquisition volume continues to increase in scope and dollars, the agency must give greater attention to proper acquisition planning, adequate requirements definition, sufficient price evaluation, and proper contractor oversight (GAO, 2002).

In our previous exploratory research on the challenges and opportunities in service supply chains in the DoD (Apte, Ferrer, Lewis & Rendon, 2006), we reached the following preliminary, yet significant conclusions:

- A continued growth in the volume and scope of service acquisition in the DoD in the future
- As observed at the Presidio of Monterey, innovative supply-chain arrangement involving synergistic contractual relations with cities adjacent to bases for the management of routine municipal services can result in significant cost savings.
- As observed at Travis AFB, settings conducive to successful service contracts include: (1) proactive and frequent communications among cross-functional teams composed of contracting personnel and personnel from the functional organizations involved as customers in the services contracts, and (2) co-location of contracting professional with the customers of services.
- Acquisition of services is more challenging in comparison with product/system acquisition since it is generally more difficult to establish service specifications and measure and monitor service output and quality. Hence, having onboard the right number of skilled acquisition personnel is highly critical. However, the observed downsizing of contracting workforce does not appear to be in line with this need.
- Although the DoD spends more on acquiring services than goods, the program management infrastructure for the acquisition of services is less developed than that for the acquisition of products and systems. In many service acquisition programs, a trained and dedicated program manager and programs management team does not exist, and the services contracting officer becomes the de-facto program manager.

The lack of a developed program management infrastructure for the acquisition of services is a critical research finding that warrants further study. Review of the current literature shows that the use of a well-defined, disciplined approach and infrastructure for the management of projects is critical for a project's success in meeting cost, schedule, and performance objectives (Kerzner, 2006). In the absence of a well-defined management infrastructure, project teams are left to create an ad hoc approach to managing the project. Based on our exploratory research, we believe that this is the current situation in many DoD services acquisition programs. The lack of a well-defined program management infrastructure and the lack of a lifecycle approach to the management of services acquisition projects is



putting the success of these critical services at risk. The risks for not meeting cost, schedule, and performance objectives are consequently higher in the DoD services acquisition sector. As the DoD increases its acquisition of services, particularly in light of anticipated budget cuts and dwindling resources, the DoD must ensure that its service acquisition projects are effectively and efficiently managed.

The purpose of this research is to continue our exploration in the area of services contracts while focusing on the implications of applying a program management structure to services acquisition. We will first discuss some continuing issues in services acquisition based on our initial research and recent GAO reports. We will also discuss the uniqueness of services and how they affect the services acquisition process. Next, we will discuss some basic concepts of program management and then discuss how these concepts are currently being used in the acquisition of systems and products, specifically defense weapon systems. We will then discuss the application of program management and project management concepts to services acquisition; and finally, we will illustrate how program management concepts can be effectively applied at the various levels of the DoD to successfully manage service acquisition programs.

Continuing Issues in Services Acquisition

a. Conclusions from the Prior Research

As mentioned before, last year we conducted an exploratory research in Service Supply Chain in the Department of Defense. The conclusions of that research are stated below. We want to clarify that given the exploratory nature of that research, the observations and conclusions listed below are somewhat preliminary in nature, and should be viewed as such.

1. The Department of Defense's services acquisition volume has continued to increase in scope and dollars in the past decade. The GAO (2005) found that since FY 1999, the DoD's spending on services has increased by 66%; and in FY 2003, the DoD spent over \$118 billion (or approximately 57% of total DoD's procurement dollars) on services. DoD procures a variety of services, including both the traditional commercial service and services unique to defense. In terms of amount spent, four service categories represent over 50% of total spending on services: (a) professional, administrative, and management support services, (b) construction, repair and maintenance of structure and facilities, (c) equipment maintenance, and (d) information technology services.
2. Presidio of Monterey (POM) has contracted maintenance of about 155 buildings and structures to Presidio Municipal Services Agency (PMSA), a consortium of the cities of Monterey and Seaside. The PMSA agreement has allowed the two cities to apply their expertise to routine municipal services and the Army to focus on its military mission. Through this partnership and contract with PMSA, the POM has realized a 41% reduction in expenses when compared with previous base operation costs and private contracts. We recommend the DoD explore and evaluate the possibility of establishing such synergistic contractual relations with cities adjacent to other bases for support of their respective operations.
3. Proactive and frequent communications are essential for a successful services contract. We found a successful example of this at Travis AFB, where 60th CONS uses BRAGs as the mechanism for conducting such communications. Business Requirement Advisory Groups (BRAGs) are teams made up of cross-functional personnel that represent the functional organizations involved as customers in the services contracts. These cross-functional teams plan and manage the service contracts throughout the service's



lifecycle. As the DoD increases the use of centralized contracting organizations and regional contracts, the use of proactive and frequent communications will be even more essential for the successful management and performance of these contracts.

4. Our visits and interviews at Travis AFB, Presidio of Monterey (POM), Naval Air Station Whidbey Island (NAS WI), and the Naval Support Detachment Monterey (NSDM) confirmed the GAO's finding that, "while the Army's and Navy's creation of centralized installation management agencies can potentially create efficiencies and improve the management of the facilities through streamlining and consolidation, implementation of these plans has so far met with mixed results in quality and level of support provided to activities and installations" (GAO, 2005b).
5. The centralization of contracting offices and use of regional contracts will result in additional dynamics to the DoD's acquisition of services. The use of centralized contracting organizations and regional contracts will require even more proactive and frequent communications between the contracting organization and the customer. Although it is still too early to assess the effectiveness and efficiency of centralized contracting organizations and regional contracts, this research has indicated that centralization and regionalization of services contracts are growing trends in the DoD and will significantly change how services contracts are managed.
6. Given the unique characteristics of services (such as intangibility, co-production, diversity and complexity), establishing service specifications and measuring and monitoring the quality of delivered service is inherently more complex than when dealing with manufactured goods. Hence, it is critical to have onboard a "knowledgeable client" and the necessary number of skilled contracting personnel to define the requirements and to supervise outsourced services. The DoD has been aggressively complying with OMB's Circular A-76, which directs all federal government agencies "to rely on the private sector for needed commercial activities." This has resulted in dramatic growth in the DoD's spending and in the downsizing of the DoD civilian and military acquisition workforce. Although this exploratory study is not yet completed, we believe that the above two trends contradict the critical need to have onboard a necessary number of skilled contracting personnel. This could mean that in the DoD's outsourced services, either the needs are not being fully satisfied, or the value for the money spent is not being realized.
7. Although the DoD acquires more services than goods, and the acquisition of services and the use of service contractors are becoming an increasingly critical aspect of the DoD mission, the management infrastructure for the acquisition of services is less developed than for the acquisition of products and systems. There is a less formal program management approach and lifecycle methodology for the acquisition of services, which is confirmed by the lack of standardization in the business practices associated with the services acquisition process. This results from the fact that the functional personnel currently managing the services programs are not considered members of the DoD acquisition workforce, and are typically not provided acquisition training under Defense Acquisition Workforce Improvement Act (DAWIA) requirements.

b. Service Characteristics and Their Implications to Contracting

Intangibility of service outcomes makes it difficult to clearly describe and quantify services, and, therefore, to contract for services. Consider, for example, the difficulty in writing a contract for an educational service involving academic lectures. How does one define a "pound of education," and how can one be sure when the contract is fulfilled satisfactorily. As Karmarkar and Pitbladdo



(1993) explain, this is the reason why in such cases we do not contract around quantities at all; rather, we contract around process delivery. In general, the more information intensive the service is, the more difficult it is to develop clear and meaningful contracts. This difficulty is somewhat reduced in services in which physical objects play a dominant role.

Intangibility of outputs also makes it *difficult to define and measure quality*. For example, even for a simple custodial service such as cleaning, it is not easy to define the desired level of cleanliness. The levels of cleaning needed for an office is certainly different than for a hospital operating room. The desired time duration for maintaining a clean status can also be an important matter in writing a contract for cleaning service. As research in service quality has found, customers typically evaluate the quality of service based on the outcome of a service as well as the customer's experience with the process of service delivery. For example, in a dining facility, not only must the food be tasty, but the manner in which the food is served must also be courteous, prompt and friendly. This means that the contracts for many services should not be based solely on outcomes but should include specifications on both the outcome and the customer's experience with the process.

Co-production requiring presence and participation of customers in the creation of many services is an important characteristic of services. For example, in an IT services such as software development, a customer's input in terms of desired specifications of a software system is critically important. For example, however competent the software developer may be, the developed software will not be satisfactory if the specifications do not accurately reflect the true needs of the customer. Hence, the contracts for services should ideally specify not only what the service provider should do but also what the customer should do. Otherwise, a satisfactory service outcome may not be realized.

Diversity of Services also makes it difficult and undesirable to use the same contract vehicles or procedures for different services. For example, given the differences in medical services versus custodial services, it is important that the contracts for these services are customized to suit the lifecycle needs of individual services.

Finally, services are complex and may involve multi-stage processes. This makes it important, yet challenging, to write contracts that are flexible enough to cover all relevant scenarios and eventualities. Moreover, if such contracts cannot be satisfactorily defined, it may be more desirable to deliver certain services using internal resources than to outsource them.

c. Service Markets and Contracts

The above-discussed special features of services lead to significant differences in the process of production, sale and consumption of services. These, in turn, have implications for market structure, pricing, and contracting for services. While the operational implications of service characteristics have received some attention, there have been very few attempts to capture the implications for markets. The large majority of papers dealing with service competition have addressed issues like queues and congestion, and their consequences for customer waiting time.

While queuing is certainly an issue central to services—customers must access service systems because of the *lack of portability* of services—the difference relative to manufacturing is primarily one of degree. There are, on the other hand, several important characteristics of services which remain untreated in terms of market models. For example, there is little to be found on the subject of models with joint production. Similarly, the inability to measure and meter service output renders standard price-quantity mechanisms untenable. The result is that prices must be set on a case basis, by specific bilateral contracting based on inputs rather than outputs, or by repeated renegotiation and contracting. While these are not individually all new issues, there does not seem to be an integrated treatment of service markets from this viewpoint.



Karmarkar and Pitbladdo (1993) present some key features regarding service contracting that are relevant to the development of a service quality model. First and foremost, service operations are always post-contractual (with the possible exception of New York City automotive window washing). Fixed-price contracts centered on output specifications can fail on two accounts. First is the difficulty of conceiving or verifying meaningful output specifications, and second is the variability of customer inputs and joint production which makes fixed-price contracts risky for the firm even when the output specifications can be well defined. Alternatively, contracts based on process specifications, such as time and materials, can turn out to be unsuitable since these can be risky for customers. These dual risks for firms and for customers can be addressed via stage-wise or contingent contracting, in which the process is broken into stages, and the price for a given stage is made dependent on the outputs of previous stages. For example, there may be a fixed fee for a diagnosis, and a fixed fee for treatment which, however, depends on the outcome of the diagnosis. The uncertainty in customer inputs is resolved by the diagnosis before it materializes in terms of treatment cost.

d. Stage-wise Decomposition of Services

The presence of a tangible, portable output which can be quantified by both vendor and buyer allows, perhaps forces, considerable simplification in the market-forming process of manufactured goods. Contracts for manufactured goods are centered around a clearly defined junction between production and use, at which point responsibility is transferred from producer to customer. While the value of a product to a customer may actually depend on the customer-specific uses to which the product is put, such information is not needed at the market interface, where customers can reveal their preferences through price-quantity negotiations. Similarly, specifications of the production process have no relevance at the market interface apart from their impact on the specifications of the product.

For services, the transaction between customer and provider must be represented in greater detail. Figure 1 shows the sequence of steps involved in a service transaction as seen by a customer. At the end of each step is the state that is reached, observed by either the buyer or the vendor of the service. Karmarkar and Pitbladdo discuss why, 1) contract terms for the next stage are typically contingent on the states reached in the previous stages, and 2) switching to competing providers is an option at the end of each stage. We hasten to note that not all services necessarily involve all these steps.



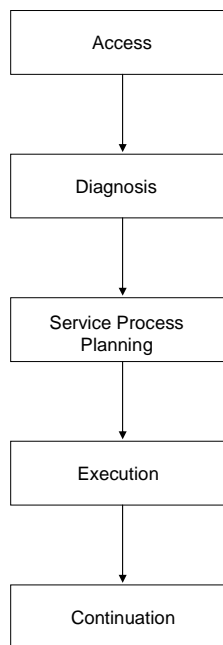

Figure 1. A Conceptual Model of a Service Lifecycle

The first step is *access* to the service; this may involve bringing a customer to the service system, or the reverse. The second stage is *diagnosis*. For our purposes, diagnosis is defined as the mapping of customer requirements of a service into a technical or process specification. For example, a customer at a car repair facility may describe certain problems that he or she has experienced based on which repair needs can be assessed. The process of diagnosis identifies the underlying technical problem, perhaps as a syndrome (collection of symptoms) or perhaps in terms of the underlying mechanism. The medical analogy is obvious. Similarly, a client of a financial planning service may describe problems in terms of college payments and retirement. The planner may convert the statement to needed cash flows, risk attitudes and state preferences. Diagnosis is likely to be an interactive or joint process. In some cases, the diagnosis step is performed by the customer alone.

The third stage, *process planning*, is the generation of alternative service processes or treatments to meet the output requirements defined by the diagnosis. This may be a joint production process. In some cases, the alternatives available are already stated and fixed. A menu at a restaurant is an example. In others, processes or alternatives can be highly specialized to the customer's needs. It is conceptually useful to note that diagnosis, coupled with process planning, is the dynamic equivalent of Quality Function Deployment (QFD) (Hauser & Clausing, 1988). In manufacturing, QFD consists of mapping generic customer needs into clearly defined product specifications. Diagnosis and process-plan generation consist of mapping specific customer needs and desires into clearly defined process specifications, particular to the customer.

The fourth stage is the *execution* of the service process itself. Once again, this may or may not involve joint production. Finally we add a fifth stage, *continuation*, which represents the continuing consumption or consequences of service outputs (the provider's role in this stage can be characterized as long-term service support). The reason for this is that the outputs or consequences of many services (e.g., health care, financial planning, consulting) cannot be completely evaluated immediately. It is instructive to note here that, in the manufacturing case, the

counterpart of this fifth stage constitutes the entirety of the customer involvement with the product. The service provider may continue to have a role in this stage in the form of direct interaction and consultation or a set of instructions along the lines of a "user's manual." Surgery provides a clear example, involving a schedule of required and proscribed activities, along with follow-up checkups and telephone consultations.

In the next section, we build on some concepts discussed above to propose a program management approach for services acquisition.

Towards a Program Management Approach to Services Acquisition

This research on the acquisition of services will focus on the application of a program-management approach and project-management concepts to services acquisition. This section will first discuss some basic concepts of program management and then discuss how these concepts are currently being used in the acquisition of systems and products, specifically defense weapon systems. The next section will discuss the application of a program-management approach and project-management concepts to services acquisition.

a. An Overview of the Program Management Approach

Review of the current literature shows that the use of a well-defined, disciplined methodology and infrastructure for the management of complex projects is critical for a project's success in meeting cost, schedule, and performance objectives (PMI, 2004, Kerzner, 2006). We use the term "program management" to describe the approach and methodology needed for the management of complex projects. A program management approach includes the infrastructure that facilitates the successful attainment of cost, schedule, and performance objectives. A program management approach refers to the centralized, coordinated management of a group of projects to achieve the program's strategic objectives and benefits (PMI, 2004). In addition, programs themselves consist of related projects managed in a coordinated way to obtain benefits and control (PMI, 2004). Thus, a disciplined program management approach includes the following project management concepts: project lifecycle, integrated project processes, an assigned and dedicated project manager, empowered cross-functional project teams, and an appropriate project organizational structure. These project management concepts will be briefly discussed.

1. Project Lifecycle

An effective way of managing projects is to divide the project into phases to provide better management and control. These phases make up the project lifecycle. The phases of the project lifecycle can be used to manage and control the activities that are conducted within each project phase. By using the phases of the project lifecycle and establishing control gates or milestones between project phases, the project manager can control the progression of the project. Although project lifecycles are different for each specific type of project, many organizations will establish a standardized lifecycle for their projects. Typically, the project lifecycle of a system consist of the following phases: conceptual, planning, testing, implementation, and closure (Kerzner, 2006). Later in this report, we will discuss how the project lifecycle is used in defense weapon system projects. We will also discuss the development of a project lifecycle for service acquisition projects.



2. Integrated Processes

A disciplined program management approach includes the integration of various project management processes used throughout the project. These various project processes typically include such processes as requirements development, scheduling, cost management, quality management, risk management, and contracts management (PMI, 2004). Although each of these specific project processes reflects different functional areas, a disciplined program management methodology would integrate these various processes to ensure that each of these areas are coordinated and integrated within the total project effort. In addition to integrated processes, the PMI project management body of knowledge establishes five project management process groups. These project management process groups include initiating processes, planning processes, monitoring and controlling processes, and closing processes (PMI, 2004). Each of these project management process groups includes various functional processes that are part of that specific process group. For example, the planning-process group would include such processes as scope planning, quality planning, risk-management planning, procurement planning and solicitation planning. In order to effectively and successfully manage projects, these various functional processes need to be coordinated and integrated throughout the total project effort. Having integrated project processes are key to successful project management.

3. Project Teams

Just as integrated processes are an essential for effective project management, integrated project teams are also essential. A disciplined program management methodology includes the establishment of integrated project teams consisting of project team members representing each of the different functional areas that are part of the project effort. For example, a project team may include functional experts representing the various processes that are used in the project such as risk management, requirements management, and contracts management. These functional experts on the project team are responsible for providing their expertise in support of the project objective. Although the project team consists of these various functional experts, the activities of these project team members must be coordinated and integrated to ensure accomplishment of the project object. The coordination and integration responsibility belongs to the project manager.

4. Project Manager

A critical aspect of a disciplined project management methodology includes the assignment of a dedicated project manager to oversee the activities of the project. We have already stated that the project effort includes various functional processes conducted by functional experts on the project team. We also stated that there are project management process groups that are used to help integrate these various functional processes. The role of the project manager, therefore, is to coordinate and integrate the various project activities to ensure successful completion of the project (Kerzner, 2006). The project manager is responsible for ensuring that all members of the project team support the projects objectives. Thus, having a dedicated project manager, who is responsible for managing the project activities and ensuring the achievement of the project objectives, is an essential part of a disciplined project management methodology.



5. Organizational Structure

An appropriate organizational structure is also an essential element of a disciplined project management methodology. An organizational structure that supports the integrated project management processes, integrated project teams, and the roles and responsibilities of the project manager will significantly contribute to the success of the project. One of the three main types of organizational structures—functional, matrix, and pure project—is typically used in organizations that perform projects (PMI, 2004). The degree of project manager authority, resource availability and budget control will be affected by the type of organizational structure (PMI, 2004). Some of the factors to consider in selecting the appropriate type of organizational structure include: the number of functional areas involved in the project, the level of integration needed within the functional areas and between the organization and the customer, the nature of the technology used in the project work, and the organization's previous experience in performing the work required by the project.

b. Application of Program Management Concepts to Weapon Systems Acquisition

The previous section discussed the basic project management concepts such as the project lifecycle, integrated processes, project teams, project manager, and organizational structure. These program management concepts are well established in the Department of Defense weapon systems acquisition environment. In fact, many of today's modern project management tools and techniques were developed during the Cold War. Weapon system programs such as the land-based ICBM and sea-based ballistic missile programs became the proving grounds for some of today's modern program management processes (Kerzner, 2006). In today's DoD weapon systems acquisition environment, program management concepts continue to be integral to the successful management of these critical and high-technology projects.

The *Department of Defense Directive 5000.1* establishes the defense acquisition system as the management process by which the DoD provides effective, affordable, and timely systems to the users (DoD, 2003). This directive establishes the role of the program manager as the designated individual authorized and responsible for accomplishing the program objectives. The program manager is the designated individual that is accountable for costs schedule and performance reporting to the milestone decision authority (MDA) (DoD, 2003).

The *Department of Defense Instruction 5000.2* establishes the defense acquisition management framework as the project lifecycle for major defense acquisition programs (USD(AT&L), 2003, May 12). This lifecycle consists of the various phases, decision points, and project review points that are part of the project lifecycle. See Figure 2 for an illustration of the DoD Acquisition Management Framework.



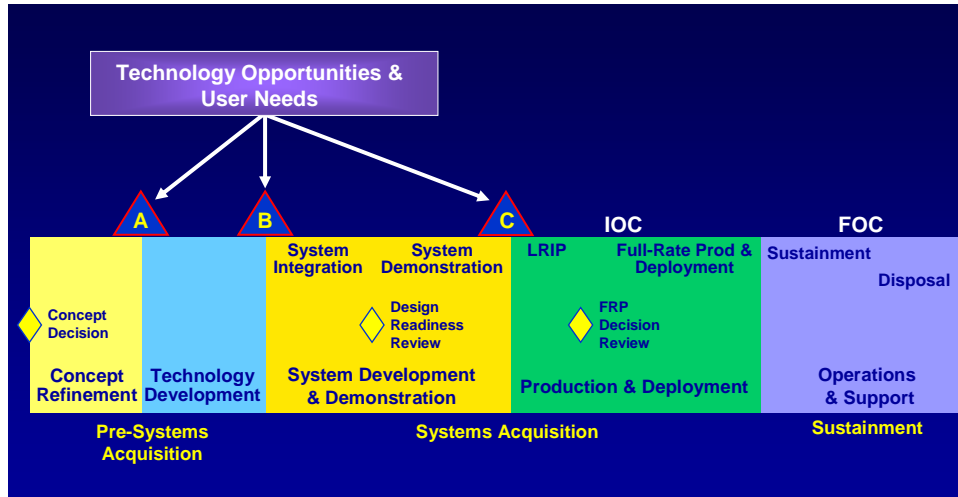

Figure 2. The Defense Acquisition Management Framework

In addition, the *DoD 5000* regulations also established the use of integrated product teams (IPTs) and integrated processes throughout the weapon systems acquisition management lifecycle. Through the use of effective collaboration, program managers are responsible for making project decisions and leading project execution by maintaining continuous and effective communication through use of integrated project processes.

Finally, for weapon systems acquisition management, the DoD relies heavily on unique organizational structures such as the matrix organizational structure and, in some instances, project-type structures for the management of defense acquisition programs. Figure 3 is an example of an organizational structure for a weapon system acquisition program.

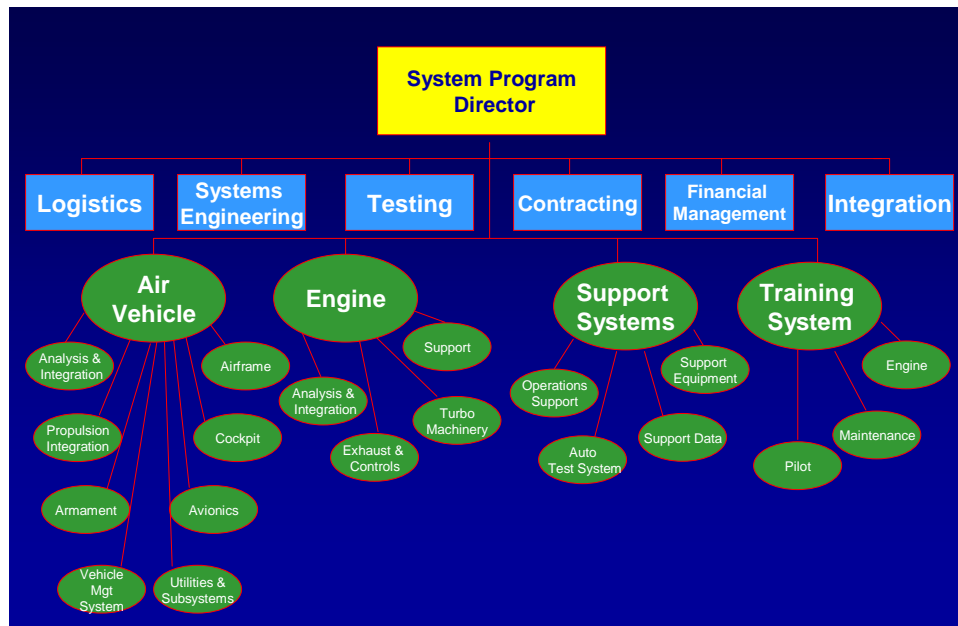

Figure 3. Organization Structure of a Weapon System Acquisition Program

Thus, the basic concepts reflective of a program management approach are well established in DoD weapon systems acquisition management. The use of project lifecycles and control gates, integrated processes, established project manager and project teams, and an effective organizational structure have been successfully used in this specific sector of the Department of Defense. The next section of this research will discuss how this program management approach (consisting of these basic project management concepts) can be used by the DoD in the acquisition of services.

Applications of Program Management Concepts to Services Acquisition

Our previous discussion focused on the use of a program management approach and its related project management concepts found in the current literature. These project management concepts included the use of a project lifecycle and control gates, integrated processes, a dedicated program manager and integrated project teams, and an organizational structure conducive to the integration of project activities. We also discussed how this program management approach and these project management concepts have been well established in the weapon systems acquisition management environment. We identified Department of Defense directives and instructions that support, even mandate the use of some of these project management concepts. This section will now focus on the acquisition of services within the Department of Defense. We will look at the acquisition of services at the installation level, command level, and service level. The purpose here is to illustrate how a program management approach and project management concepts can be effectively applied at each of these levels to successfully manage service acquisition programs.

In exploring DoD services acquisition, our research included basic installation-level types of services that are commonly acquired in support of the installation mission. The installations researched included Travis Air Force Base California, Randolph Air Force Base Texas, Presidio of Monterey California, and the Naval Postgraduate School, California. At the installations visited, personnel were interviewed for this research; we determined that although some project management concepts were applied, they were not applied in a consistent manner, or were not institutionalized throughout the organization. In addition, at many of these locations, although project management tools and concepts were being applied, this utilization did not necessarily result in a program management approach to acquiring services.

Typically, at the installation level, the acquisition of services is managed using more of an ad hoc approach as opposed to a program management approach.

1. Project Lifecycle

In terms of using a project lifecycle, our research indicated that the contracting process was typically used as the project lifecycle. Although the contracting process is an integral part of the acquisition lifecycle for DoD weapon systems acquisition, the project lifecycle is separate from the contracting process lifecycle.

2. Integrated Processes

In addition, our research indicated that although various project management processes were used at the installation level, these processes were not necessarily integrated in the management of the services contracts. Although we did find the various project management



processes (such as contracting process, risk-management process, quality-assurance process, and contract-funding process), we did not see the integration of these processes.

3. Project Teams

Furthermore, the use of informal project teams was in existence at these installation-level organizations. Although these project teams were in existence, the structures of these project teams were created more on an ad hoc basis than established as formal project teams.

4. Project Manager

Closely related to the above was the ad hoc approach to the establishment of a project manager for services acquisition. In many cases, the project manager, or program manager, as sometimes called, existed at the major command headquarters level as opposed to the installation level. As we will discuss in the next section on Major Command level management of services acquisition, we found that many service acquisitions were centrally planned at the headquarters and then de-centrally executed at the installation level. If there is an assigned program manager, that individual is typically assigned at the Major Command level, with oversight responsibility for the installation-level activity. In these instances, although the program manager was located at the headquarters level, there was no program manager at the installation level. In this case, although the quality assurance evaluators (QAE) represented the program manager, the QAE does not perform program management responsibilities. In addition, the contracting officer at the installation typically functioned as the de-facto program manager due to the lack of any program manager at the site. It should be noted that the procuring contracting officer (PCO) at the Major Command headquarters where the services acquisition was centrally planned and executed delegated the contract to the administrative contracting officer at the installation where the contract was administered. Thus, the PCO, responsible for providing contracting support for the centrally planned and executed services acquisition, would delegate the administration tasks to the ACO for the decentralized administration of the services contract. However, the program manager retained the program management functions of the services acquisition.

5. Organizational Structure

Finally, in terms of organizational structures, at the installation level our research did not identify any specific or unique organizational structures specifically established for the acquisition of services. The installations we researched reflected the traditional organizational structures and organizational mission of the Defense Department. We did not see any projectized or matrix organizational structures used in the management of services contracts at the installation level.

Preliminary Conclusions

Our preliminary conclusion in this ongoing exploratory research has identified some unique aspects of services and how they affect the services acquisition process. We developed a conceptual model of a service lifecycle that can be used in analyzing the DoD's services acquisition process. We also discussed the program management approach and identified basic project management concepts and discussed how these concepts are being used in the acquisition of defense weapon systems. Our current research has observed that the program management approach is applicable to the acquisition of services within the DoD. We have also initially concluded that the basic project management concepts (such as project lifecycle,



integrated processes, project team, project manager, and organizational structure) can be applied to the acquisition of services. Our current research leads us to believe that the application of a program management approach and the adoption of basic project management concepts to the acquisition of services will improve the management and oversight of these services contracts. Our further research will explore in more detail how this program management approach and project management concepts can be used to improve the DoD's services acquisition management.

References

- Apte, U., Ferrer G., Lewis, I., & Rendon, R. (2006). Managing the service supply chain in the US Department of Defense: Opportunities and challenges. In *Proceeding of the third defense acquisition research symposium*. Monterey, CA: Naval Postgraduate School.
- Camm, F., Blickstein, I., & Venzor, J. (2004). *Recent large service acquisitions in the Department of Defense*. Santa Monica, CA: RAND National Defense Research Institute.
- DoD. (2003). *Department of Defense Directive 5000.1*. Washington, DC: author.
- GAO. (2002, January). *Best practices: Taking a strategic approach could improve DOD's acquisition of services* (GAO-02-230). Washington, DC: US Government Accountability Office.
- GAO. (2005a, March). *Contract management: Opportunities to improve surveillance on Department of Defense contracts* (GAO-05-274). Washington, DC: US Government Accountability Office.
- GAO (2005b, June) *Defense Infrastructure: Issues need to be addressed in managing and funding base operations and facilities support* (GAO-05-556). Washington, DC: US Government Accountability Office.
- Hauser, J. R., & D. Clausing. (1988, May-June). The house of quality. *Harvard Business Review*, 63-73.
- Karmarkar, & Pitbladdo. (1995). Service markets and competition. *Journal of Operations Management*, 12(3-4), 397-411.
- Kerzner, H. (2006). *Project management: A systems approach to planning, scheduling and controlling*. New York: John Wiley & Sons.
- PMI. (2004). *A guide to the Project Management Body of Knowledge (PMBOK Guide)*. Newtown Square, PA: Project Management Institute.
- Under Secretary of Defense (AT&L). (2003, May 12). *Operation of the defense acquisition system (DoD Instruction 5000.2)*. Washington, DC: author.



2003 - 2006 Sponsored Acquisition Research Topics

Acquisition Management

- Software Requirements for OA
- Managing Services Supply Chain
- Acquiring Combat Capability via Public-Private Partnerships (PPPs)
- Knowledge Value Added (KVA) + Real Options (RO) Applied to Shipyard Planning Processes
- Portfolio Optimization via KVA + RO
- MOSA Contracting Implications
- Strategy for Defense Acquisition Research
- Spiral Development
- BCA: Contractor vs. Organic Growth

Contract Management

- USAF IT Commodity Council
- Contractors in 21st Century Combat Zone
- Joint Contingency Contracting
- Navy Contract Writing Guide
- Commodity Sourcing Strategies
- Past Performance in Source Selection
- USMC Contingency Contracting
- Transforming DoD Contract Closeout
- Model for Optimizing Contingency Contracting Planning and Execution

Financial Management

- PPPs and Government Financing
- Energy Saving Contracts/DoD Mobile Assets
- Capital Budgeting for DoD
- Financing DoD Budget via PPPs
- ROI of Information Warfare Systems
- Acquisitions via leasing: MPS case
- Special Termination Liability in MDAPs

Logistics Management

- R-TOC Aegis Microwave Power Tubes
- Privatization-NOSL/NAWCI
- Army LOG MOD



- PBL (4)
- Contractors Supporting Military Operations
- RFID (4)
- Strategic Sourcing
- ASDS Product Support Analysis
- Analysis of LAV Depot Maintenance
- Diffusion/Variability on Vendor Performance Evaluation
- Optimizing CIWS Lifecycle Support (LCS)

Program Management

- Building Collaborative Capacity
- Knowledge, Responsibilities and Decision Rights in MDAPs
- KVA Applied to Aegis and SSDS
- Business Process Reengineering (BPR) for LCS Mission Module Acquisition
- Terminating Your Own Program
- Collaborative IT Tools Leveraging Competence

A complete listing and electronic copies of published research within the Acquisition Research Program are available on our website: www.acquisitionresearch.org





ACQUISITION RESEARCH PROGRAM
GRADUATE SCHOOL OF BUSINESS & PUBLIC POLICY
NAVAL POSTGRADUATE SCHOOL
555 DYER ROAD, INGERSOLL HALL
MONTEREY, CALIFORNIA 93943

www.acquisitionresearch.org



Acquisition Research Program:
Creating Synergy for Informed Change

Managing the Service Supply Chain: Implications for a Program Management Approach

Uday M. Apte

Rene G. Rendon

Overview

- Previous Research Findings
- Purpose of Research
- Innovative Approaches to Services Acquisition Management
- Current Research Findings



Services Acquisition

- Consistent problems in managing service contracts
 - Fragmented and uncoordinated approach
 - Not employing sound business practices
 - Inadequate contractor oversight

United States Government Accountability Office

GAO

Testimony
Before the Subcommittee on Defense,
Committee on Appropriations, House of
Representatives

For Release on Delivery
Expected at 10:00 a.m. EDT
Thursday, May 10, 2007

DEFENSE ACQUISITIONS

Improved Management and
Oversight Needed to Better
Control DOD's Acquisition
of Services

Statement of John P. Hutton, Director
Acquisition and Sourcing Management

Accountability * Integrity * Reliability

GAO-07-832T

Previous Research Findings

- Infrastructure for acquisition of services is less developed and less established compared to that of weapon systems acquisition
- Less formal approach to the acquisition and management of services
- Lack of standardization of business practices in services acquisition



Purpose of Research

- Explore the application of a program management approach and project management concepts to services acquisition in the Department of Defense



Program Management Approach

- Well-defined, disciplined methodology and infrastructure (PMI, 2004; Kerzner, 2006)
- Centralized, coordinated management to achieve the program's strategic benefits and project objectives (PMI, 2004)
- Program management approach incorporates project management concepts (PMI, 2004)



Project Management Concepts

- Project lifecycle
- Integrated processes
- Designated manager with project authority
- Integrated cross-functional teams
- Enabling organizational structure



The Defense Acquisition Management Framework

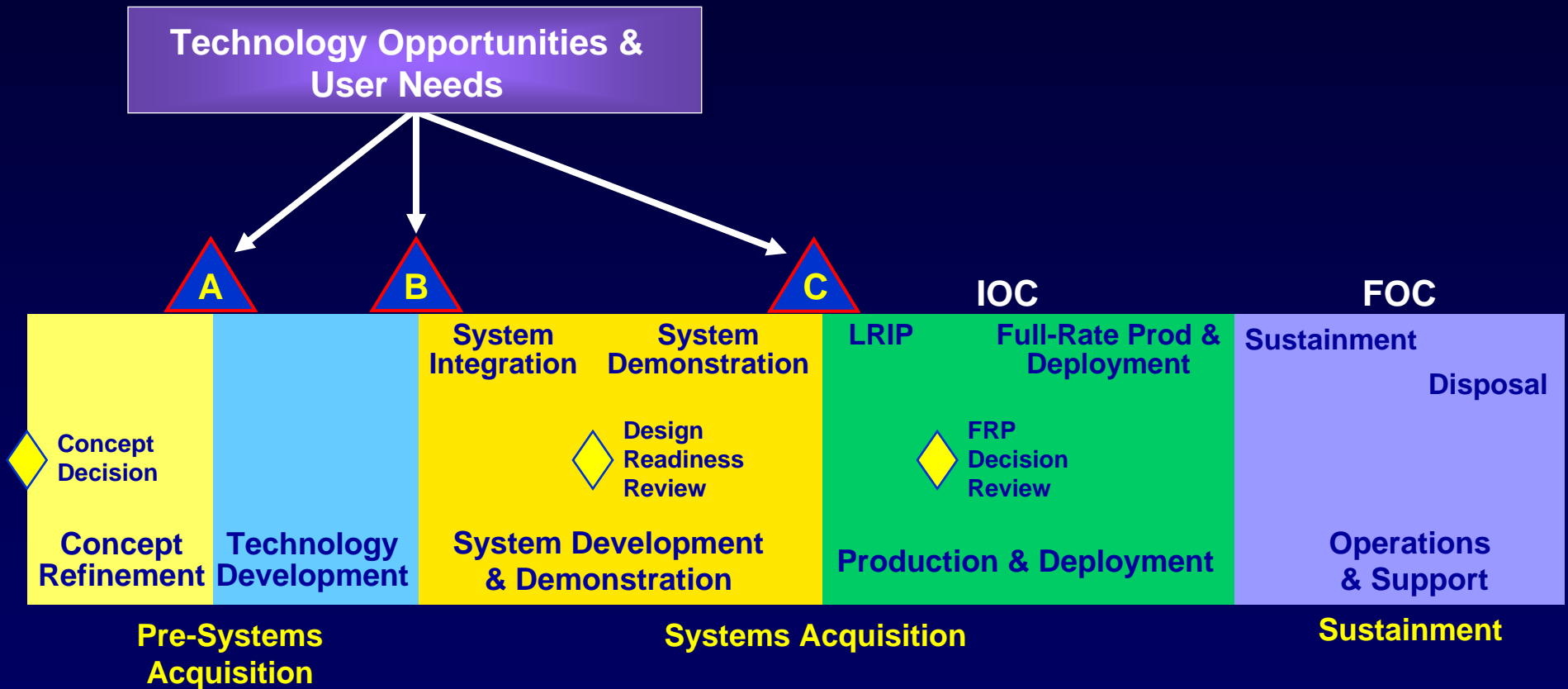

System Program Director

Logistics

Systems Engineering

Testing

Contracting

Financial Management

Integration

Air Vehicle

Analysis & Integration

Propulsion Integration

Armament

Vehicle Mgt System

Airframe

Cockpit

Avionics

Utilities & Subsystems

Engine

Analysis & Integration

Exhaust & Controls

Support

Turbo Machinery

Support Systems

Operations Support

Auto Test System

Support Equipment

Support Data

Training System

Engine

Maintenance

Pilot

Traditional Systems PM Structure

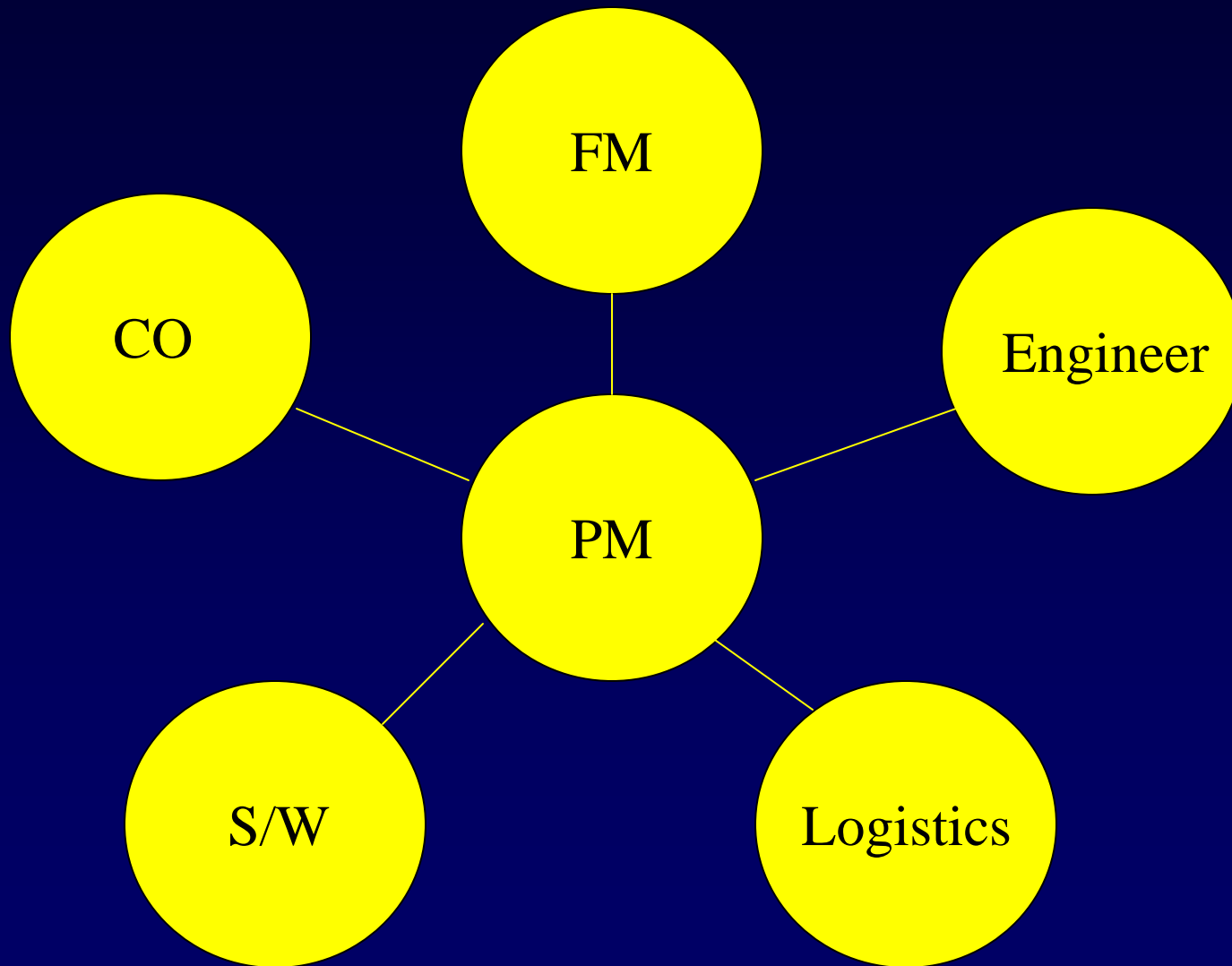

Services Characteristics

- Intangibility of service outcomes
- Difficult to define and measure quality
- Co-production requirement for some services
- Diversity of services



Services Life Cycle

(Conceptual)

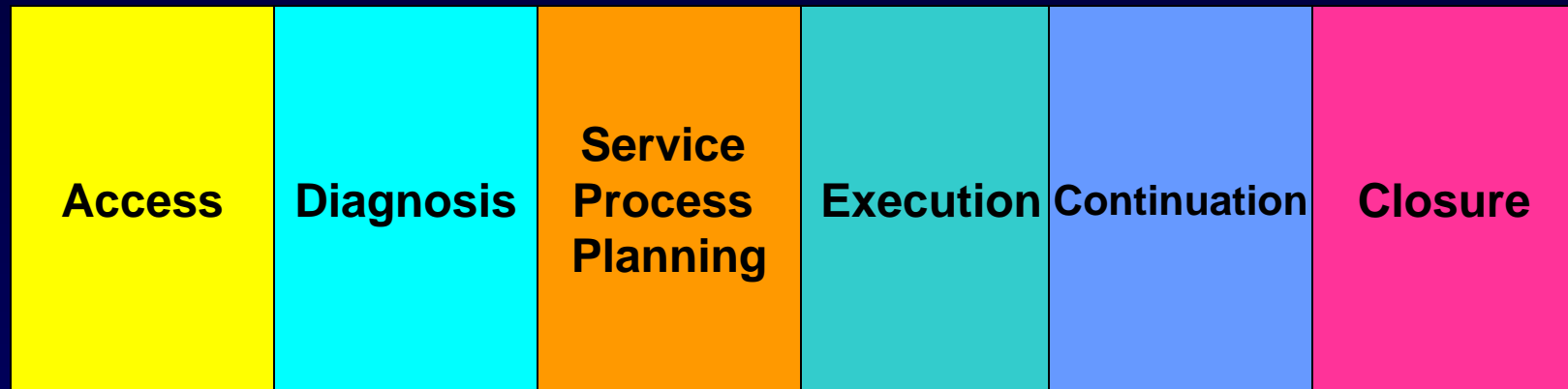

Traditional Services Management Structure (Post Award)

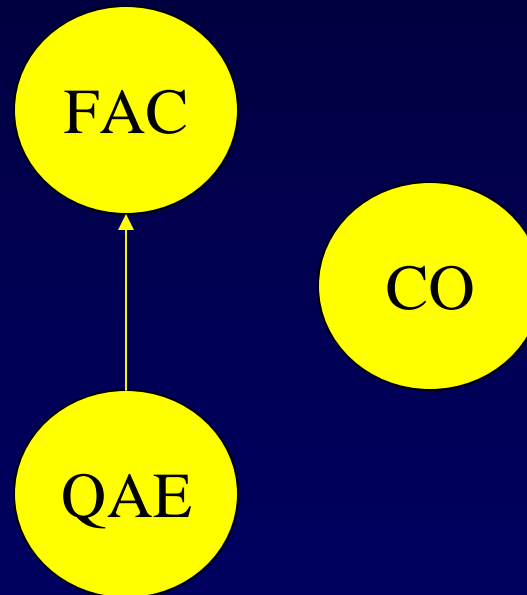

Innovative Approaches to Services Acquisition Management

- Air Education and Training Command (AETC)
 - AETC Program Management Flight
 - AETC Contracting Squadron
- Air Combat Command (ACC)
 - Acquisition Management and Integration Center
 - Centralized Planning, Control, and Execution
 - “Services SPO”
 - Combined program management and contracting organization





A4PM
Program Management
Flight



A4PM Mission Statement



Develop America's Airmen Today ... for Tomorrow

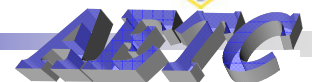

Plan, program, manage, and execute AETC's contracted and civil service **maintenance (aircraft, trainer, and transient alert) and base operating support (civil engineering, supply and fuels, transportation, communications, and services) acquisitions. Assists with the development of Performance Requirement Documents/Statements of Work, Request for Proposals, and lead the source selection evaluation team process for all A-76 cost studies and service contract re-competitions.**



Program Management Supported Locations



Develop America's Airmen Today ... for Tomorrow

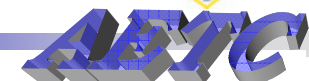

VANCE

T-1, T-37, T-38 Aircraft, TA, CE, Supply, Trans, Services, Comm./IT, Airfield Mgt, TRIM, Life Support (Contract)

ALTUS

C-5, C-17, C-135, C-141 Aircraft, TA (MEO)

SHEPPARD

80TH T-37, T-38, AT-38 (Contract)
A-76 – Trainer Maintenance Supply, Trans, CE, COMM./IT, MSS, Services

COLUMBUS

T-1, T-37, T-38 Aircraft, TA (Contract)
Supply, Trans., CEO, Lodging, MFH (MEO)

FAIRCHILD

UH-1 Aircraft (Contract)

MAXWELL

TA, Supply, Trans, CE, IT/Comm, Airfield Support, Services

KIRTLAND

UH-1, HH-60 Aircraft (Contract)

FT. RUCKER

UH-1 Aircraft (Contract)

LUKE

F-16 Aircraft FMS (Contract)

MOODY

T-6, T-38 Aircraft (Contract)

GOODFELLOW

Supply, Trans., CE (MEO)

TYNDALL

F-15 Aircraft off equip Maint, TA, Supply, Trans, CE (Contract)

LAUGHLIN

T-1, T-37, T-38 Aircraft (MEO)
ERRC, TA, Supply, Trans, CE (Contract)

KEESLER

TA, Trainer Maintenance (Contract)
A-76 -- Supply, CE, COMM./IT, MSS, Airfield Services, Services

LACKLAND

A-76 – Trainer Maintenance, Supply, CE, COMM./IT, MSS, Airfield Support, Trans. Combat Readiness, Shuttle bus, Services

RANDOLPH

T-1, T-6, T-37, T-38, T-43 Aircraft (Civil Service), TA (Contract) A-76 – Aircraft Maint, Supply, CE, COMM./IT, MSS, OSS, Life Support, Airfield Management, Weather

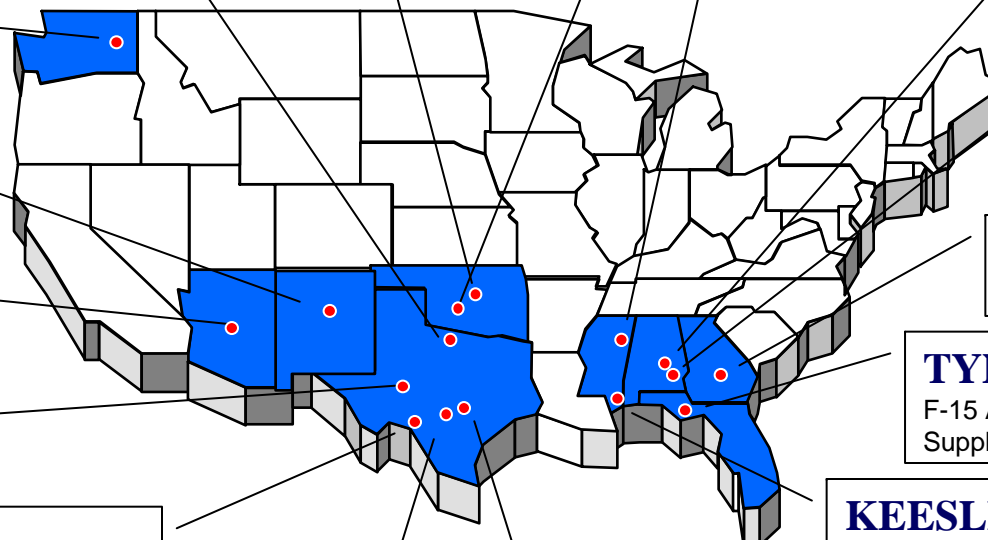



A4PM Organizational Chart



Develop America's Airmen Today ... for Tomorrow

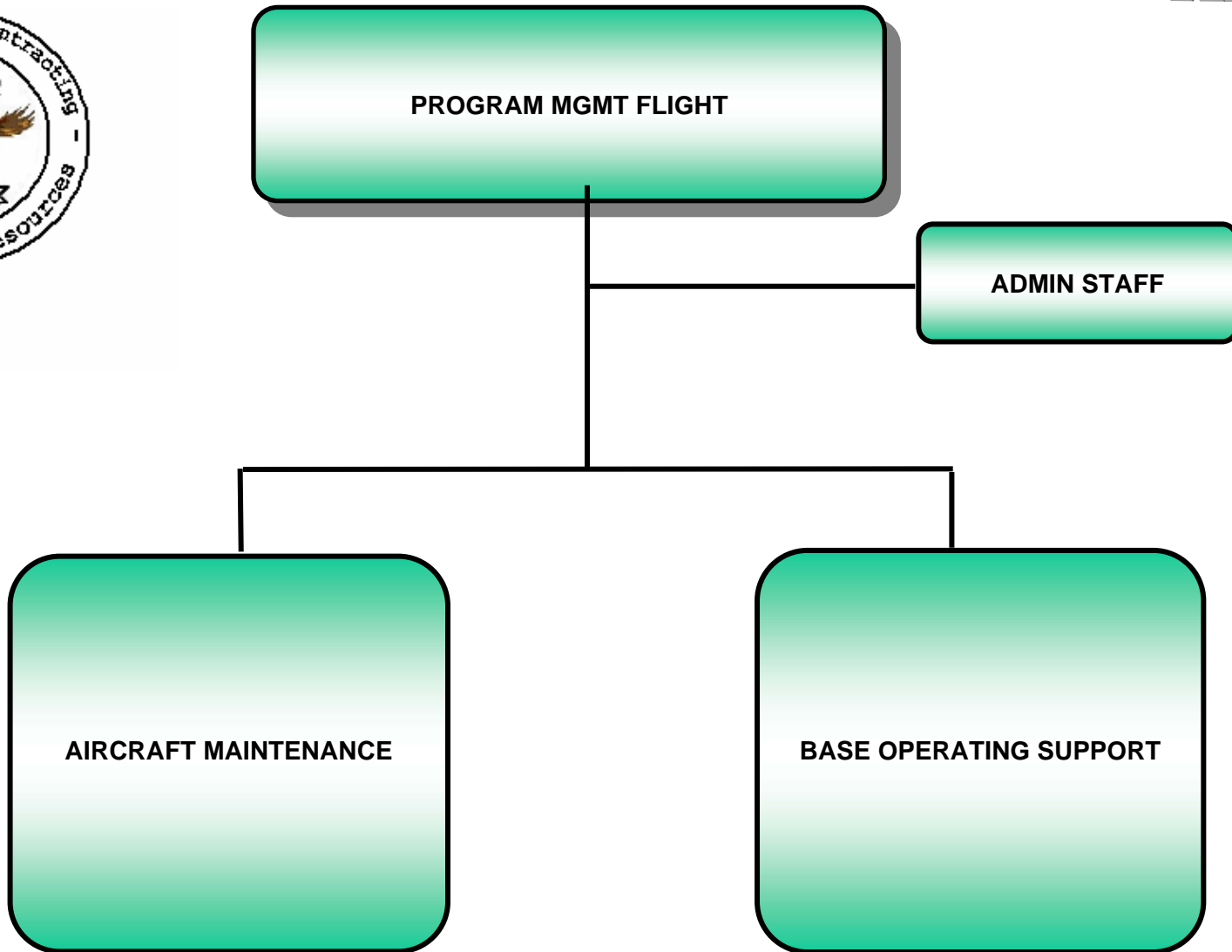

AETC CONTRACTING SQUADRON



Integrity - Service - Excellence



ORGANIZATIONAL CHART

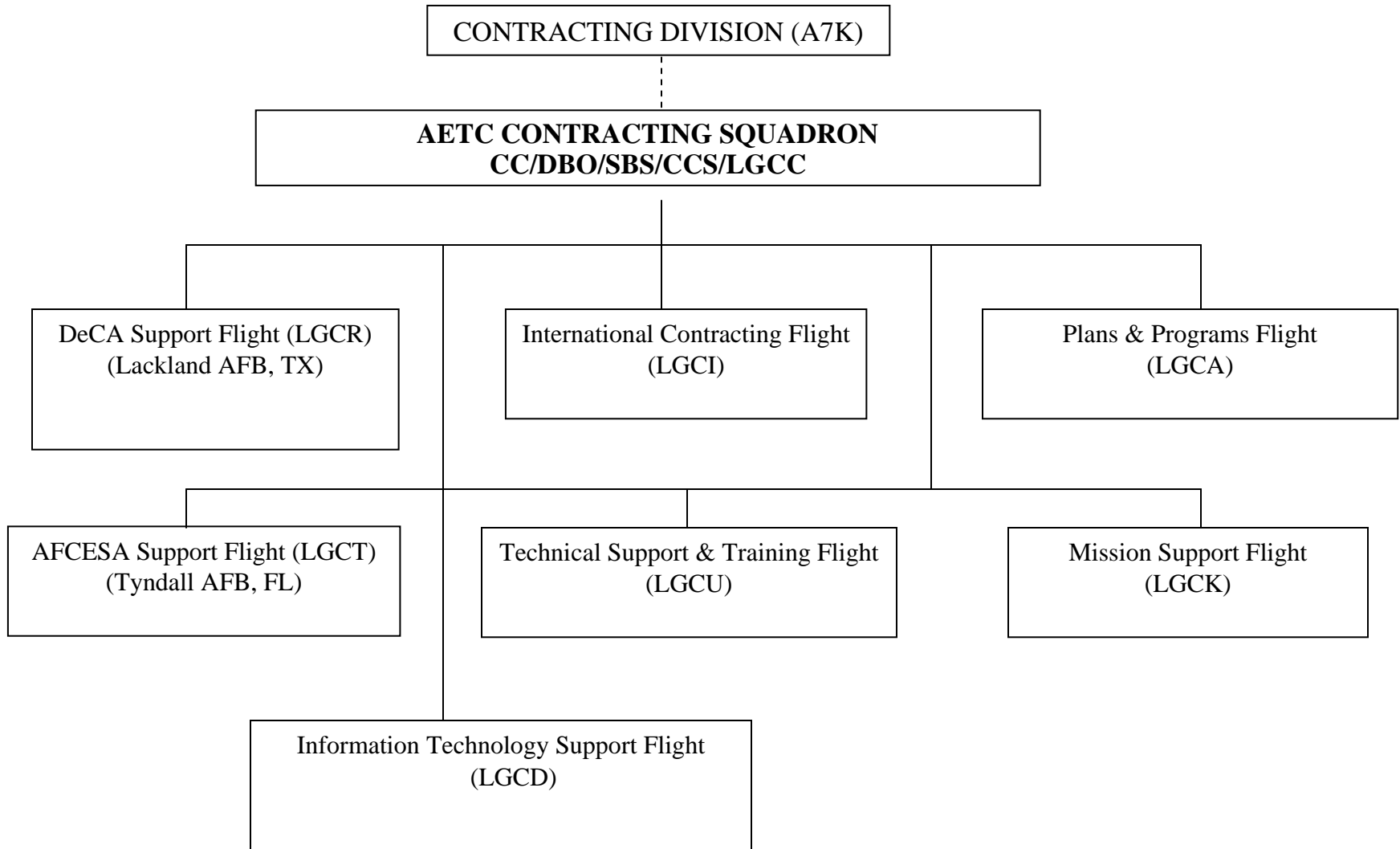

Services Life Cycle



Centralized Services Acquisition Management

Pre-Award

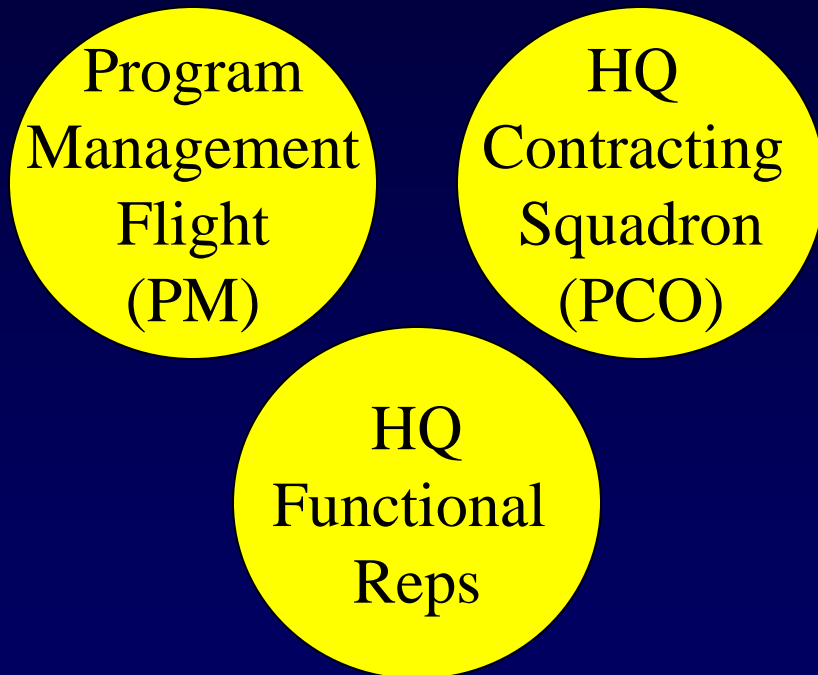

Post-Award

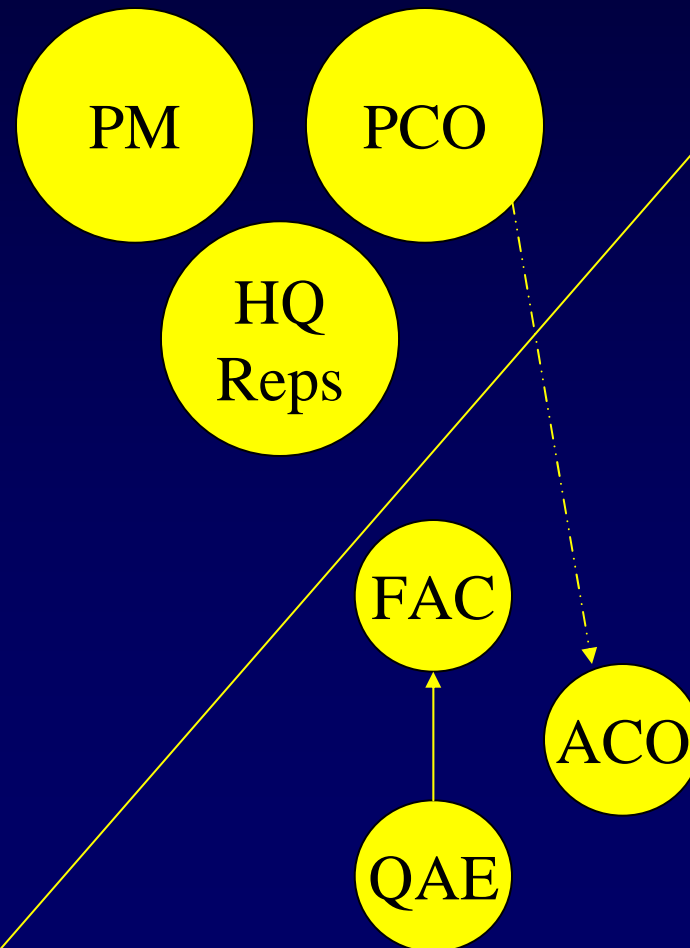

Innovative Approaches to Services Acquisition Management

- AETC Model
 - Centralized Planning (Pre-Award)
 - Roles and responsibilities shared by HQ PMF and HQ CONS
 - Decentralized Execution (Post-Award)
 - HQ retains PM authority (No on-site PM)
 - HQ delegates contracting officer authority (On-site ACO)





Acquisition Management and Integration Center (AMIC)



Mission

*Provide strategic acquisition facilitation, integration, and management for Air Combat Command, U.S. government agencies, and allies through **integrated program management and contracting support** that produce mission-focused solutions while meeting contingency challenges*

Vision

Be the preeminent provider of integrated acquisition management solutions



Organizational Structure

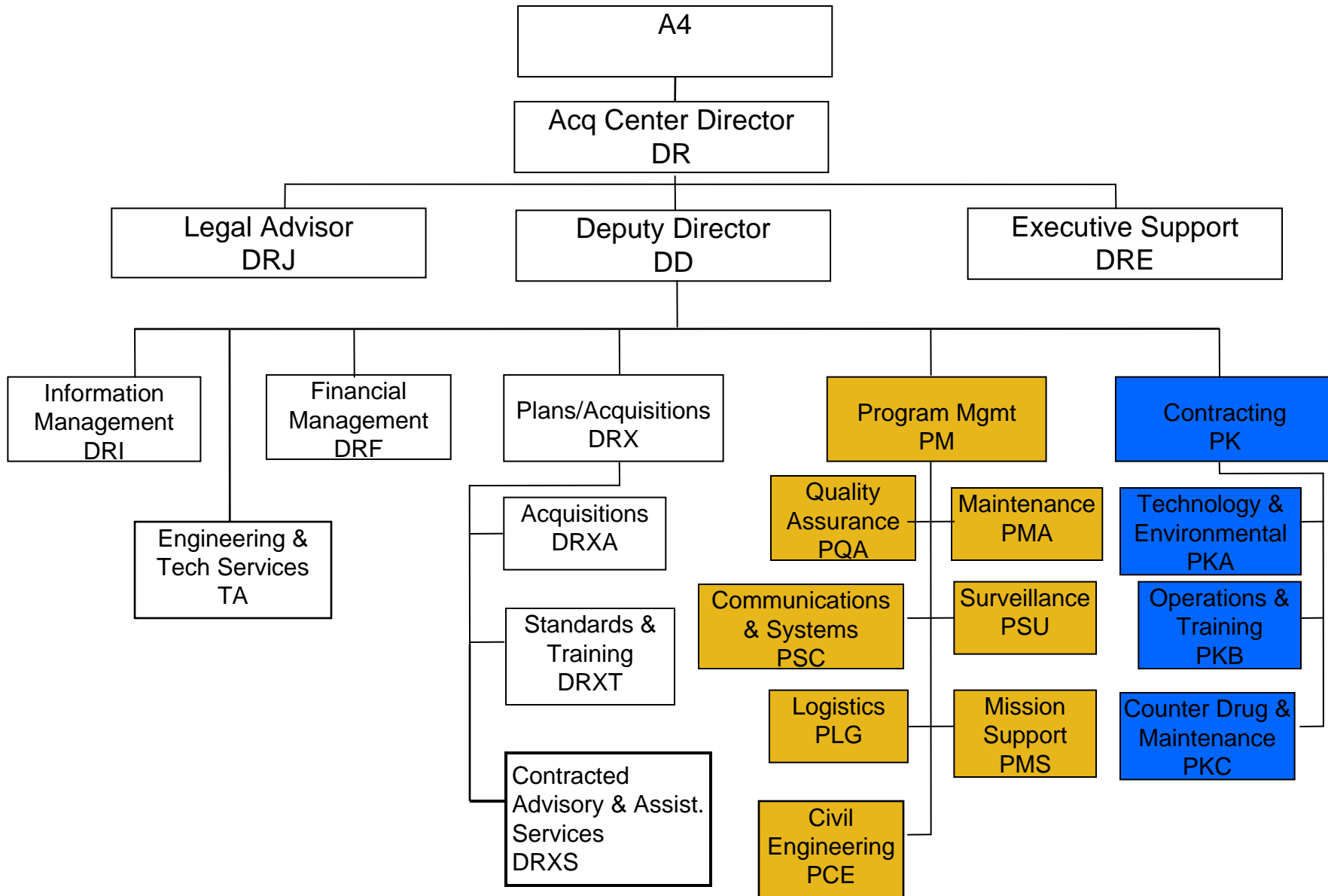



Multi-functional Team

- **Integrated Culture**
 - **Program Managers and Contracting Officers work side-by-side and speak the same language while understanding each others' constraints**
 - CO – Contract regulation responsibilities
 - PM – Mission and Technical responsibilities
 - **Functional expertise located within the Center; i.e. Logistics, Quality Assurance, Civil Engineer, Communications**
 - **Partnership that includes the contractor creating business-like environment conducive to meeting mission needs**

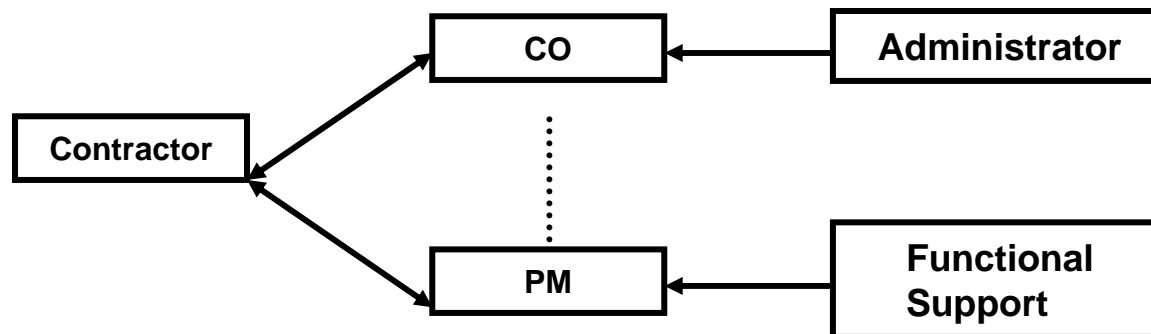

MISSION-FOCUSED ACQUISITIONS

Innovative Approaches to Services Acquisition Management

- ACC Model
 - Centralized Planning and Execution
 - Single point control, integrated management, and a unique cradle-to-grave sustainment capability
 - Integrated services “SPO-like” program management organization



Research Findings

- Traditional approach to managing services acquisition does not incorporate program management approach
 - Well-defined, disciplined methodology and infrastructure
 - Centralized, coordinated management
 - Project lifecycle
 - Integrated processes
 - Designated manager with project authority
 - Integrated cross-functional teams
 - Enabling organizational structure



Research Findings

- AETC model incorporates
 - Well-defined, disciplined methodology and infrastructure
 - Centralized, coordinated pre-award management
 - Project lifecycle
 - Integrated cross-functional teams
 - Enabling organizational structure
 - Integrated processes
 - No on-site Program Manager
 - On-site ACO



Research Findings

- ACC model incorporates
 - Well-defined, disciplined methodology and infrastructure
 - Centralized, coordinated program management
 - Project lifecycle
 - Integrated processes
 - Designated manager with project authority
 - Integrated cross-functional teams
 - Enabling organizational structure



Conclusion

- Program management approach needed to manage DoD's critical services acquisition
 - Well-defined, disciplined methodology and infrastructure
 - Centralized, coordinated approach incorporating project management concepts
- AETC and ACC models provide innovative and successful approaches to services acquisition



Back-Up Slides





Pre-Award Key Processes



Develop America's Airmen Today ... for Tomorrow

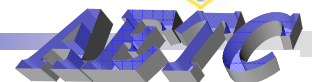

- A-76 Cost Studies/Contract Recompetition
 - Market research assistance
 - Risk assessment assistance
 - PWS development
 - Assist with RFP development
 - Award fee planning
 - Financial analysis
 - Assist wing with government cost estimates
- Acquisition Strategy Panel
- Source selection
 - Plan
 - Team training
 - Past performance assessments
 - Technical evaluation
 - SSA brief
 - PAR
- Pre-performance conference



Post Award Key Processes



Develop America's Airmen Today ... for Tomorrow

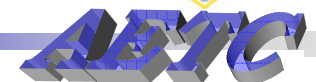

- Performance Plan development
- Act as HQ AETC technical experts on issues affecting service contracts and MEO's
- Monitor MEO/contract performance
 - PWS modification process
 - QAE coordination/monitor contractor performance Summaries
 - Financial programming/analysis
 - Understanding/educating contractor payment



Integrated Approach

- **Integrated Program Management (IPM)**
 - **Process oriented rather than functional task oriented**
 - Acquisition, program management, quality assurance
 - Mission goals supersede functional goals
 - **Maximizes resource availability**
 - Reduces functional competition for resources
 - Allows cost and spend-rate control across functions
 - **Increases responsiveness**
 - Reduces coordination cycle-time
 - Reduces decision cycle-time
 - **Maximizes training effectiveness**
 - Common skill set and language across functions
 - Builds team pride yet respects functional expertise
 - **Improves communication**
 - Interaction with Wing/NAF functionals on requirements
 - Coordination of requirements/policy with HQ staffs

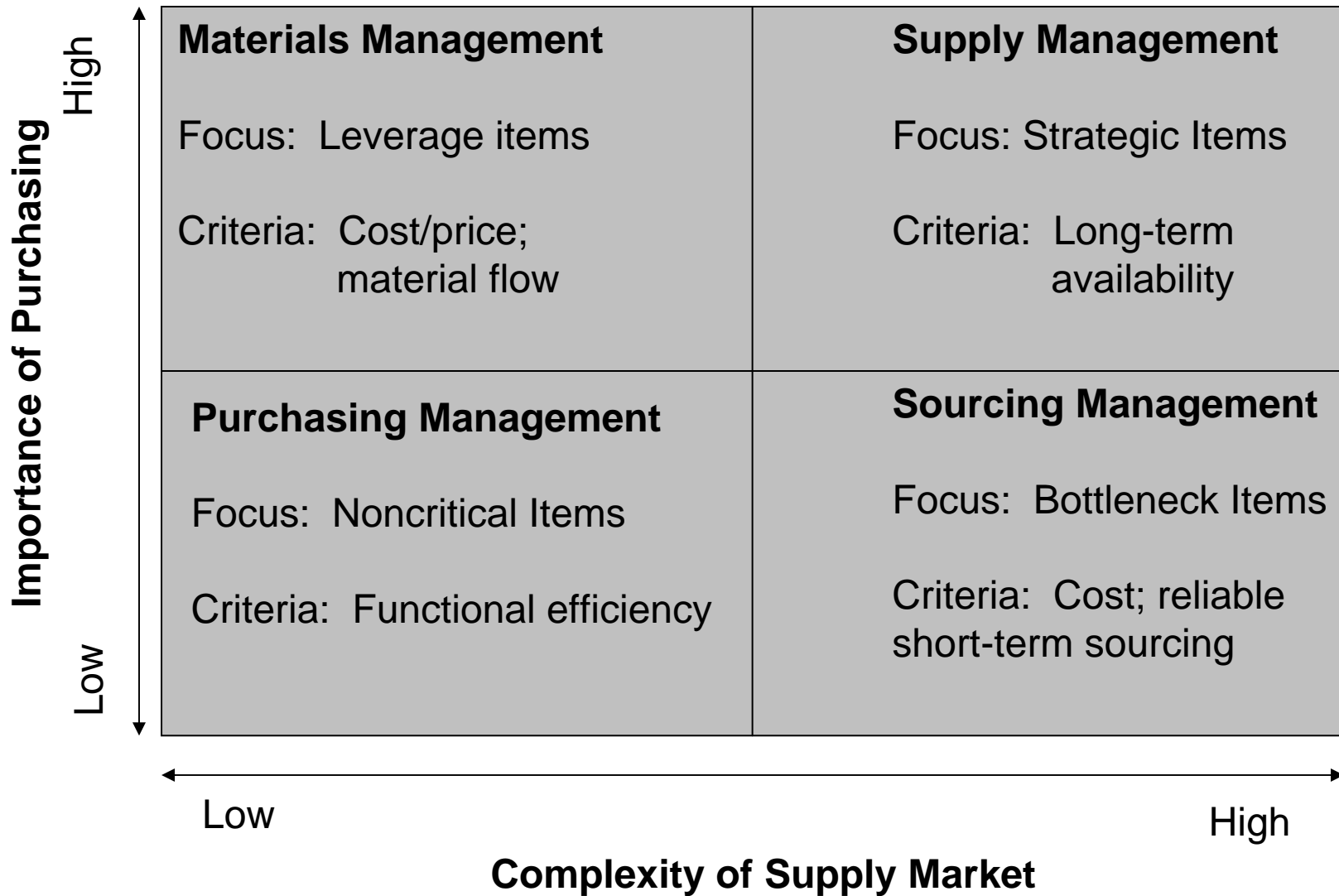

(Adapted from Kraljic, *Purchasing Must Become Supply Management*,
 Harvard Business Review, Sep/Oct 1983)