

Precision Time and Frequency Source and Systems Research and Development at
The Johns Hopkins University Applied Physics Laboratory

A. G. Bates, M. T. Boies, M. C. Chiu,
R. Kanski, and J. J. Suter

The Johns Hopkins University Applied Physics Laboratory
Laurel, MD 20707

ABSTRACT

The Applied Physics Laboratory (APL) has a Time and Frequency Laboratory equipped with several hydrogen masers, cesium beam standards, and two Global Positioning Satellite receivers that are tied into the Bureau of the International Hour network of time standards. This laboratory gives APL the capability to perform much of our advanced research in time and frequency standards and provides reference signals with excellent short- and long-term stabilities.

APL developed the NR Hydrogen Maser for NASA's Crustal Dynamics Project in the late 1970s and early 1980s. Since then, APL has continued research and development in advanced hydrogen maser technology under NASA's Research and Technology, Objectives and Plans Program. Two major areas of research activity are the source and state selector assembly for increased efficiency and the cavity design for a better temperature coefficient. Initial results of these activities will be presented in this paper.

In addition to hydrogen maser research, APL has expanded research activities to supercooled quartz crystal oscillators and the integration of solid-state laser systems into quantum frequency standards. With respect to the laser systems, we will discuss our activities in optically pumped cesium standards and Fabry-Perot interferometers.

APL has been active in the research and development of space-flight-qualified oscillators and time and frequency standards for satellite applications for the last 25 years.¹ In recent years, our activities have included developing SC cut resonators and designing oscillators with both excellent phase noise and long-term drift. Our developments have expanded from just oscillators to complete satellite clock systems, including power conditioning, command/telemetry, and frequency multiplication and distribution amplifiers; a summary of these developments will be given. Significant research efforts are also under way on the radiation susceptibility of quartz crystals; that topic will also be discussed in this paper.

INTRODUCTION

Brief History

APL has been involved in time and frequency research and development since the late 1950s. APL's entry into this field was precipitated by our involvement in the Transit navigation satellite program in 1959. A high-quality spaceborne quartz crystal oscillator was developed and fabricated at APL as the Transit system's frequency reference. APL's Time and Frequency Laboratory (T&F lab) was

Report Documentation Page

Form Approved
OMB No. 0704-0188

Public reporting burden for the collection of information is estimated to average 1 hour per response, including the time for reviewing instructions, searching existing data sources, gathering and maintaining the data needed, and completing and reviewing the collection of information. Send comments regarding this burden estimate or any other aspect of this collection of information, including suggestions for reducing this burden, to Washington Headquarters Services, Directorate for Information Operations and Reports, 1215 Jefferson Davis Highway, Suite 1204, Arlington VA 22202-4302. Respondents should be aware that notwithstanding any other provision of law, no person shall be subject to a penalty for failing to comply with a collection of information if it does not display a currently valid OMB control number.

1. REPORT DATE 1986	2. REPORT TYPE	3. DATES COVERED 00-00-1986 to 00-00-1986			
4. TITLE AND SUBTITLE Precision Time and Frequency Source and Systems Research and Development at The Johns Hopkins University Applied Physics Laboratory		5a. CONTRACT NUMBER			
		5b. GRANT NUMBER			
		5c. PROGRAM ELEMENT NUMBER			
6. AUTHOR(S)		5d. PROJECT NUMBER			
		5e. TASK NUMBER			
		5f. WORK UNIT NUMBER			
7. PERFORMING ORGANIZATION NAME(S) AND ADDRESS(ES) The Johns Hopkins University, Applied Physics Laboratory, Laurel, MD, 20707		8. PERFORMING ORGANIZATION REPORT NUMBER			
9. SPONSORING/MONITORING AGENCY NAME(S) AND ADDRESS(ES)		10. SPONSOR/MONITOR'S ACRONYM(S)			
		11. SPONSOR/MONITOR'S REPORT NUMBER(S)			
12. DISTRIBUTION/AVAILABILITY STATEMENT Approved for public release; distribution unlimited					
13. SUPPLEMENTARY NOTES Proceedings of the Eighteenth Annual Precise Time and Time Interval (PTTI) Applications and Planning Meeting, Washington, DC, 2-4 Dec 1986					
14. ABSTRACT see report					
15. SUBJECT TERMS					
16. SECURITY CLASSIFICATION OF:			17. LIMITATION OF ABSTRACT	18. NUMBER OF PAGES	19a. NAME OF RESPONSIBLE PERSON
a. REPORT unclassified	b. ABSTRACT unclassified	c. THIS PAGE unclassified			

established during the initial operational stages of the Transit System to synchronize the ground stations.

During the 1960s and 1970s, APL continued in the research and development of space-qualified quartz crystal oscillators, improving stability performance and temperature control. The T&F lab also kept pace with developments, incorporating new frequency standards and time and frequency measurement systems. Then in 1975, NASA contracted with APL to redesign its experimental hydrogen maser into a more rugged model for their Crustal Dynamics Program's VLBI network. The NASA Research (NR) hydrogen maser was developed. It operates in remote locations under less than ideal conditions and still performs as well as a laboratory instrument. Sixteen hydrogen masers were fabricated at APL, eleven for the Crustal Dynamics Project and five for research and development.

The development of the NR maser was APL's lead into the research and development of both atomic and innovative frequency devices and their auxiliary systems. APL played a role in NASA/Goddard Space Flight Center's Research and Technology, Objectives and Plans (RTOP) Program and NASA/Jet Propulsion Laboratory's RTOP on precision time and frequency sources. APL also used internal research funds for time and frequency research. In the 1980s, APL has continued to branch out into other areas of time and frequency systems research. Those programs will be discussed later.

Staff and Facilities

The Time and Frequency Systems Section at APL has a staff of fifteen, nine professionals (engineers and physicists) and six support staff (primarily RF and digital technicians). The section has built up a large repertoire of specialized equipment for its R&D efforts, located in an 8000 ft² area. The equipment includes thermal vacuum chambers for testing devices under simulated space environment, vacuum equipment for fabricating frequency devices such as hydrogen masers, and low-temperature equipment for operating at temperatures under 5 K.

In addition, a wide spectrum of technological expertise is available at APL in general. Support facilities include large data-processing facilities, an extensive technical library, and mechanical, electronic, microelectronic, chemical, and physics laboratories.

RESEARCH AND DEVELOPMENT PROGRAMS

Time and Frequency Laboratory

The T&F lab is actually our key facility in the Time and Frequency Systems Section, but out of necessity, it is also constantly being improved. It has three Hewlett Packard high-option cesium-beam frequency standards and five hydrogen masers as its operating time and frequency base (Fig. 1). The lab is tied into the Bureau International de l'Heure international time and frequency network, via time transfers with both the U.S. Naval Observatory (USNO) and the National Bureau of Standards (NBS). The time transfers are made via our recent acquisition of two Global Positioning Satellite (GPS) receivers, which were built at APL but are of the NBS design. The data collected with these receivers has permitted APL to make much higher resolution comparisons with other time and

frequency facilities than were possible before, particularly for long-term stabilities of one week and longer. In-house measurements at APL have shown that our masers have long-term stabilities of low parts in 10^{15} over days and weeks. However, this level of stability is difficult to transfer over any distance. We have acquired the NBS GPS time transfer service, and via this APL-NBS link we have been able to measure stabilities of low parts in 10^{15} over several days — up to 16 days at present. The Allan variance of APL NR6 compared to NBS is given in Fig 2.

APL is also developing a system to use a small hydrogen maser, developed by Sigma Tau, Inc., as a high-precision portable clock. A truck has been outfitted as a traveling laboratory, with its own power supply and environment controls for performing experiments elsewhere than at APL. A portable time and frequency measurement system has also been developed for use with this van. Two time transfers have been performed between APL and USNO (about a 2-hr round trip) using this system. Initial results show closures of less than 1 nsec. The system is still being developed.

Spaceflight Quartz Oscillator Systems

APL is still involved in the research and development of spaceflight oscillator systems. Over the last 25 years, APL has delivered over 200 spaceflight oscillator systems. In recent programs, we have designed low-phase-noise timing systems with noise floors of less than -150 dB, stabilities of parts in 10^{13} over 1 to 100 s, and aging rates of less than one part in 10^{10} per day. As our oscillators have been evolving into timing systems, we have developed a state-of-the-art DC-to-DC power converter with an isolated ground, using MOSFETs. This prevents load variations that affect the oscillator's stability.

HYDROGEN MASER

The hydrogen maser research and development work involves the evaluation of current hydrogen maser standards and the study of new maser designs. The intent of the Hydrogen Maser Improvement Program is to improve the hydrogen maser frequency standard. The goals of the project include increased stability, decreased size and weight, lower cost, improved state selector and source performance, and the attainment of information on the transport phenomenon of the hydrogen maser. The program has been divided into several areas, including improved source assembly performance, magnetic state selection optimization, maser evaluation and test station, and increased maser cavity temperature stability. Figure 3 illustrates the three major physics package subsystems for the NR hydrogen maser.

Source Subsystem

The primary function of the source assembly subsystem is to provide the remainder of the maser assembly with a continuous, collimated beam of atomic hydrogen (see Fig. 3). The source oscillator couples a substantial amount of power into the source bulb when dissociating the molecular hydrogen, and many operational difficulties experienced by the masers can be traced to the source subsystem. Heat stress and contamination of the source bulb are among the most

frequent causes of problems. A program has been initiated to redesign the source subsystem to improve both performance and reliability.

The primary objectives of the redesign are to eliminate all major heat sources and to minimize the sources of contamination. The new subsystem will be designed for subsystem independence. In the original NR maser design, a source assembly consisted of both atom supply and transport (i.e., state selector). Now the term "source assembly subsystem" represents only the portion of the maser that supplies a continuous, collimated beam of atomic hydrogen. This modularity will allow many different state selector designs to be tested using the same source subsystem. The independence of the source assembly subsystem also will allow it to be studied and evaluated separately from the other maser subsystems. The new source assembly subsystem is shown in Fig. 4.

State Selector Subsystem

The state selector in the hydrogen maser creates a population difference among the four energy substates of ground-state hydrogen. A major goal in the hydrogen maser improvement program is to develop a new state selector that will more efficiently create the desired population difference. From an operational standpoint, the state selector should also be capable of focusing as large a percentage of the beam into the maser cavity as possible. Current state selector designs are able to focus only a fraction of a percent of the total atoms into the maser storage bulb.

The new state selector design uses permanent hexapole magnets instead of the electromagnetic quadrupole magnets used in the NR design. It has tapered pole pieces, and the exit pupil diameter is wider than the entrance pupil and has an 11-kG field strength versus the 4-kG field in the NR design. Figures 5 and 6b and 6d illustrate these variances. Finally, a trade-off exists between the volume of the beam focused and the population difference of the atoms in the maser cavity. The beam-volume-to-beam difference relationship has been resolved at present by maintaining a difference ratio similar to that of the current NR version and maximizing the beam volume in the storage bulb. This is expected to greatly increase the vacuum pump's lifetime.

A comprehensive software simulation program has been written to model the hydrogen transport process of the maser. It has been used to evaluate various state selector designs, particularly those involving tapered magnet pole pieces. It was also used to design the new state selector described above and will be used again in its evaluation.

Maser Subsystem Evaluation

A substantial amount of test and evaluation will be performed on the new design source and state selector subsystems in order to obtain optimum performance. Shown in Fig. 7 is the vacuum system that will be used to evaluate those subsystems. Of particular interest, this project is investigating and developing a new type of atomic hydrogen detector. Various thermistor materials have a reported sensitivity to atomic hydrogen while having no sensitivity to hydrogen in molecular form. The thermistors will be mounted in an array on a movable paddle in the vacuum chamber. The array will be able to measure the beam profile, divergence,

state selector magnetic field uniformity, etc. The rotating disks are slotted to provide a chopped signal from which difference measurements can be made on the thermistors. This will provide a quantitative measurement of atomic hydrogen. The data acquisition process (Fig. 8) is accomplished under computer control.

Maser Cavity Modification

Original APL hydrogen masers consisted of an aluminum maser cavity. Aluminum has a relatively high thermal coefficient and, consequently, those masers have temperature coefficients of two parts in 10^{14} per degree Celsius. Two more iterations to improve the temperature coefficient met with some success,² but both had drawbacks. A final modification using a quartz liner is now being fabricated and should reduce the temperature coefficient to low parts in 10^{15} per degree Celsius.

APPLIED LASER RESEARCH

The frequency stabilization of semiconductor lasers is important for a number of applications, including optical communication, high resolution spectroscopy, and precise metrology. The Time and Frequency System Section is involved in research on the frequency stability of semiconductor lasers and their application. The main aim of our program is the application of semiconductor lasers to atomic frequency standards and to instrumentation for solar helioseismology. In both cases, space application is a goal. Two devices are being developed, the Atomic Wavelength Standard for a Solar Magnetograph and an optically pumped cesium beam device as a model of the Optically Pumped Cesium Beam Frequency Standard.³ In both cases the laser's short- and long-term stability as well as its spectral purity are the limiting factors of the instrument's performance. As a part of this program, a heterodyne receiver was developed to evaluate laser performance. This infrared heterodyne system has potential application in the ultrahigh resolution of solar and stellar spectroscopy.

Atomic Wavelength Standard

The Atomic Wavelength Standard was developed as a reference for stabilization of the Fabry-Perot etalon in the Solar Magnetograph. The requirements for short- and long-term stability of the Fabry-Perot etalon are about 1×10^{-9} for 100 s and about 1×10^{-8} for 5 years of operation. To provide the required long-term stability, we must know the reference wavelength against which the etalon may be tuned. For this purpose, a semiconductor laser stabilized against the cesium 133, D2 absorption line was developed. A simplified schematic of the instrument is shown in Fig. 9. The semiconductor laser is installed in a double temperature-controlled housing, which provides temperature stability to better than 1 millidegree. Laser radiation at a wavelength of about 852.2 nm is focused by a lens and is split into two beams by a beam splitter. Only about 10% of the laser radiation is used to illuminate the absorption cell. The temperature of the absorption cell (about 35°C) and the light intensity that interacts with the cesium vapor are adjusted to provide a nondisturbed linear absorption line. The laser is frequency modulated, and a phase detector in the laser

frequency servo loop provides proper correction of the laser's wavelength. An example of laser frequency stabilization is shown in Fig. 10. The "physics package" of the Atomic Wavelength Standard is shown in Fig. 11. The frequency stability of the Atomic Wavelength Standard is being evaluated, and the servo loop is being optimized.³

The device has been in operation for 1 year in the APL Solar Research Program.

Optically Pumped Cesium Beam

Research is being conducted on optical pumping in cesium beams and its application to a frequency standard. The principle of the device is depicted in Fig. 12. The cesium beam is optically pumped in the "pumping" region, and the influence of the microwave signal is detected in the "detection" region. It is expected that the application of optical pumping in the cesium beam frequency standard will improve its stability by one order of magnitude. For this purpose, two lasers should be used in the pumping region and a third in the detection region.

The APL cesium beam device was built on the basis of a Hewlett-Packard cesium tube. The experimental cesium tube is shown in Fig. 13. The end caps of the cesium tube were modified to allow different configurations of optical pumping and optical detection. The set of windows will allow for optical interrogation of the cesium beam by lasers located outside the vacuum chamber. The fluorescent light from the cesium beam is detected by detectors inside the tube. The cesium tube was designed to provide maximum flexibility for research and was not considered as a model for a commercial device.

Preliminary experiments have been conducted. Strong fluorescence was obtained from the cesium beam when illuminated by the laser. Investigations of the absorption-fluorescence lines for different atomic transitions are under way.

Laser Heterodyne Receiver

The laser heterodyne receiver (Fig. 14) was developed for the evaluation of the semiconductor lasers. It includes an optical mixer with the optics required for proper collimation of the incoming radiation and a microwave receiver with a frequency synthesizer. The photodiode mixer is a GaAlAs/GaAs p-i-n photodiode mounted in a high-speed package. The diode has 19-GHz bandwidth. The microwave receiver is a heterodyne type and allows for conversion of the microwave signal obtained from the photodiode to the frequency desired by the spectrum analyzer or the frequency counter. In this way, the laser signal can be analyzed in either the time or the frequency domain.

QUARTZ CRYSTAL RESEARCH

Over the last decade, the Time and Frequency Systems Section has been involved in research on the various physical properties of alpha-quartz. Those properties include the radiation sensitivity and low-temperature properties of quartz. This section will briefly outline these efforts.

Radiation Susceptibility of Quartz Crystal Resonators

Crystal oscillators on board spacecraft are, in general, subjected to radiation. Specifically, quartz crystal resonators show a frequency shift when exposed to electron, proton, and gamma radiation. APL has been involved in the testing of quartz crystal oscillators in simulated radiation environments. Comprehensive tests were conducted to study the proton radiation susceptibility of these oscillators at Harvard University.⁴⁻⁶ We have been particularly successful in the simulation of low-earth-orbit radiation with a simulated proton energy spectrum produced with a Lucite® range modulator. The increased capability of our laboratory in the field of space radiation also encompasses the performance of semiconductor devices under a harsh radiation environment. For this reason, APL initiated a study of the proton radiation susceptibility of MOSFET power conditioners, which are used in our spacecraft clock systems. A typical experimental setup of our radiation test configuration at Harvard University is shown in Fig. 15. The figure shows that (160-MeV) protons are incident on a Lucite® beam modulator. The thickness of the wheel is not uniform but varies in small steps, the edge of each step following a radius of the wheel. Protons following a particular ray of the beam encounter varying amounts of degrader as the wheel turns, so that the geometry of the wheel defines the time averaged proton energy spectrum (refer to Fig. 16). This experimental setup allows us to simulate the proton energy spectrum of low-earth-orbit radiation as encountered by APL oscillators on board spacecraft.

APL is also conducting tests of the susceptibility of quartz crystal resonators exposed to flash X-ray radiation (Fig. 17), which consists of high-energy X rays deposited in very small time intervals on the crystal blanks. This particular kind of radiation presents a unique set of problems. APL is planning to develop composite radiation shields that will be lightweight but will cause a significant energy loss for the flash X rays.

Supercooled Quartz Crystal Resonators

During the 1950s, researchers discovered that when cooling a quartz crystal resonator to near liquid helium temperatures (4.2 K), the resonator's quality factor (Q) increased from 1×10^6 to 1×10^9 (Refs. 7 and 8). This increase in Q resulted in a higher frequency stability of the quartz crystal oscillator. Successive experiments showed that resonator Qs of 10^{10} to 10^{12} could be achieved and that frequency stabilities of 1×10^{-10} per month were possible.⁹ The increase in Q is due to the reduction of the number of defects and thermal vibrations in the quartz crystal lattice. The APL effort on a supercooled crystal oscillator has initiated the development of a new generation of frequency and time standards for local oscillators for receivers and radar systems. This work will also lead to a basic understanding of alpha-quartz at low temperature and of its anisotropic crystal properties. At APL, we have facilities for measuring oscillator Q and for evaluating quartz crystals. Figure 18 shows the cryogenic apparatus for this experiment. Crystal quality can be assessed at APL by the Laue backscattering method (using a standard X-ray diffraction setup), and impurity concentration levels can be determined either by atomic absorption or X-ray

fluorescence (using an electron or X-ray beam source) spectroscopy. Moreover, the anisotropic thermal expansion coefficient of quartz will be measured down to about 15 K by single-crystal methods (using a low-temperature X-ray diffractometer) to determine the variation in cut-plane orientation at operational temperatures.

REFERENCES

- ¹L. J. Rueger and M. C. Chiu, "Development of Precision Time and Frequency Systems and Devices at APL," Johns Hopkins APL Tech. Dig., Vol. 6 (Nov 1985).
- ²R. Kunski, "Integral Cavity Hydrogen Maser" (this volume).
- ³D. M. Rust, R. Kunski, and R. F. Cohn, "Development of Ultrastable Filters and Lasers for Solar Seismology," Johns Hopkins APL Tech. Dig. Vol. 7, 209-216 (1986).
- ⁴J. J. Suter and R. H. Maurer, "Low and Medium Dose Radiation Sensitivity of Quartz Crystal Resonators with Different Al-Impurity Content," in Proc. 40th Annual Frequency Control Symp., USAERADCOM (1986).
- ⁵J. J. Suter and R. H. Maurer, "Low and High Dose Photon Irradiation of Quartz Crystal Resonators," in Proc. 17th Annual Precise Time and Time Interval (PTTI) Applications and Planning Meeting, JHU/APL (1985).
- ⁶J. R. Norton, J. M. Cloeren, and J. J. Suter, "Results from Gamma Ray and Proton Beam Radiation Testing of Quartz Resonators," IEEE Trans. Nucl. Sci., Vol. NS-31, 1230 (1984).
- ⁷A. W. Warner, "Ultra-Precise Quartz Frequency Standards," IRE Trans. Instrum. Vol. 17, 1985 (1958).
- ⁸G. Smagin, "A Quartz Resonator for a Frequency of 1 MHz with a Q-Value of 4.2×10^9 at a Temperature of 2K," Cryogenics, 483 (1975).
- ⁹G. Mossuz and J. J. Gagnepain, "Quartz Crystal Oscillator at Very Low Temperature," Cryogenics, 652 (1976).



Figure 1. Time and Frequency Laboratory.

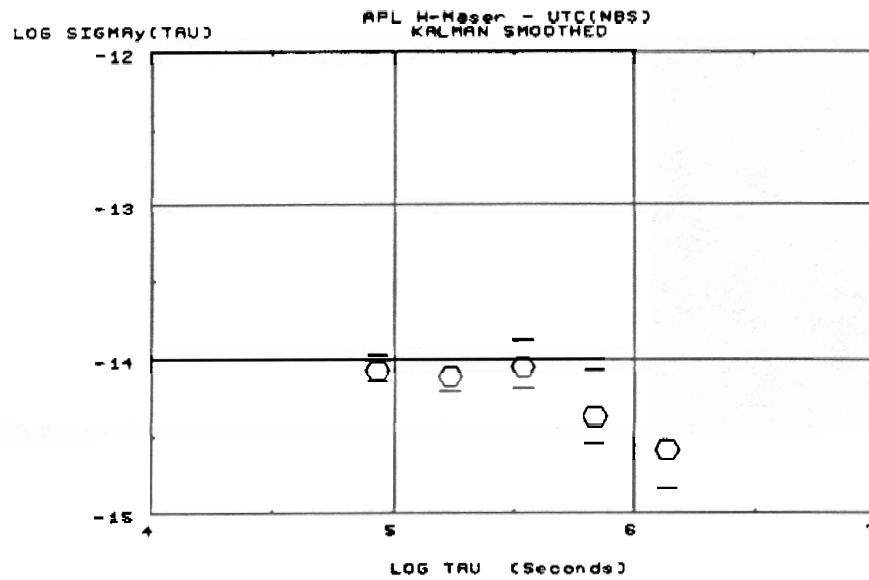

Reference: NBS Dissemination Report
#86-10.11 for JHU/APL

Figure 2. Allan variance of APL NR6 and NBS via GPS.

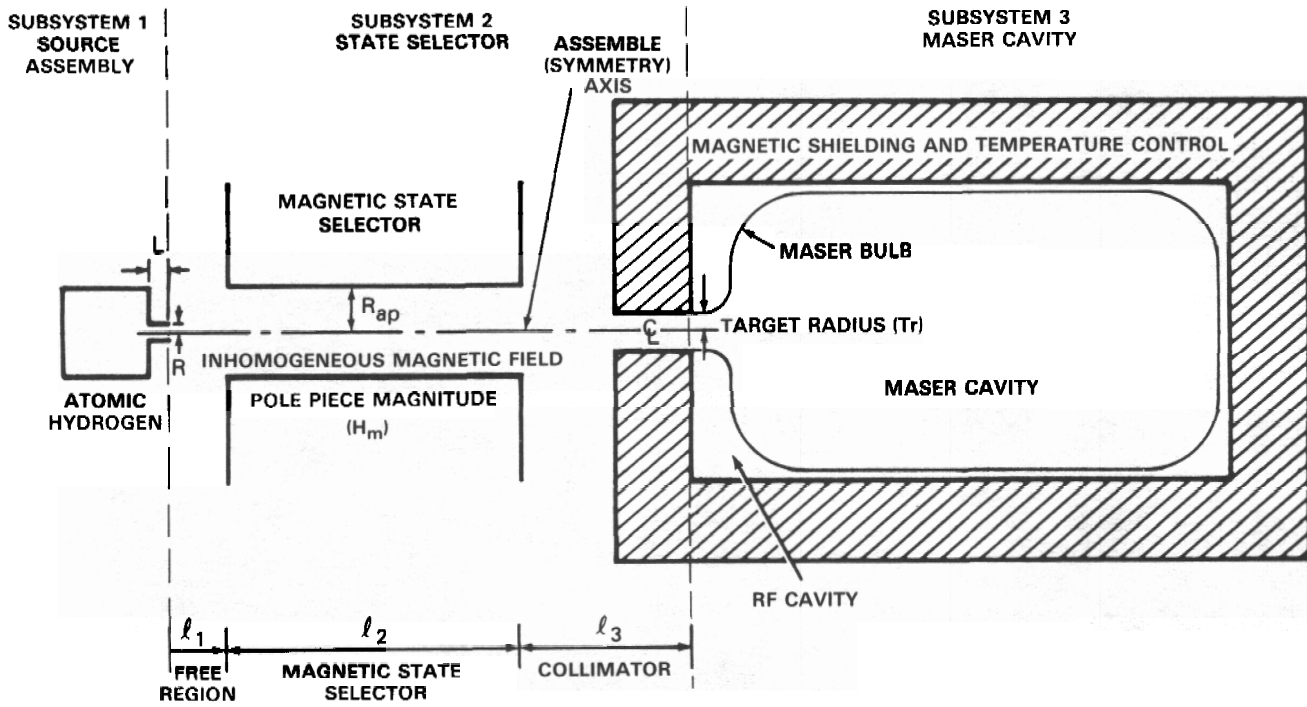

Figure 3. Hydrogen maser physics package subsystems.

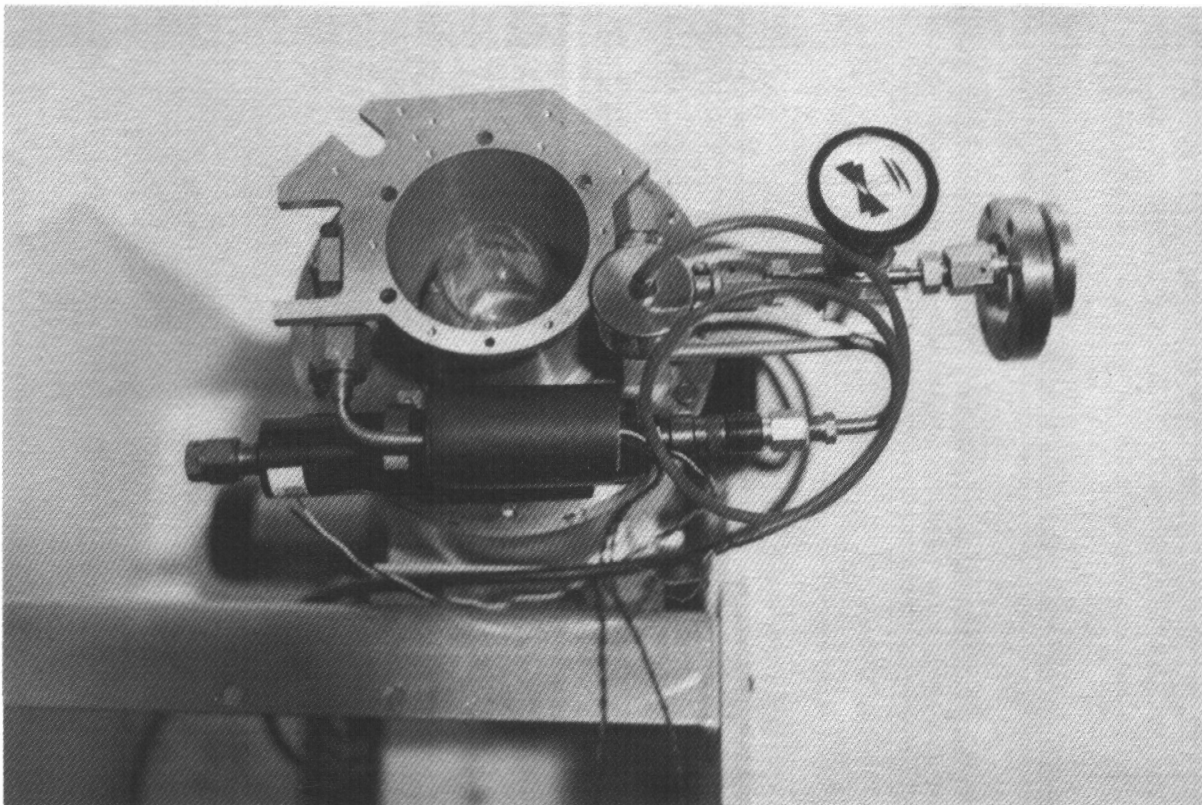
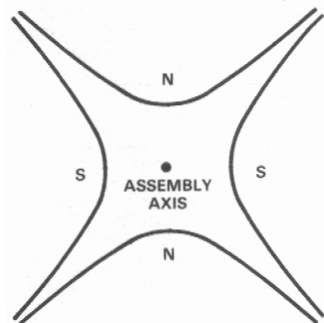

Figure 4. Hydrogen maser source assembly subsystem.

QUADRUPOLE MAGNET ASSEMBLY



HEXAPOLE MAGNET ASSEMBLY

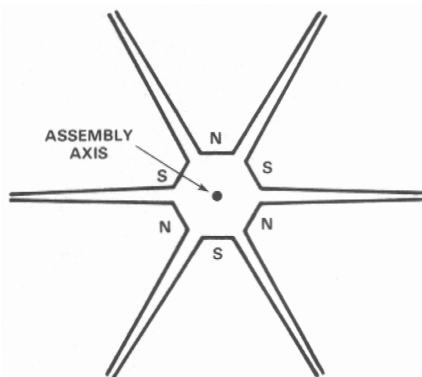
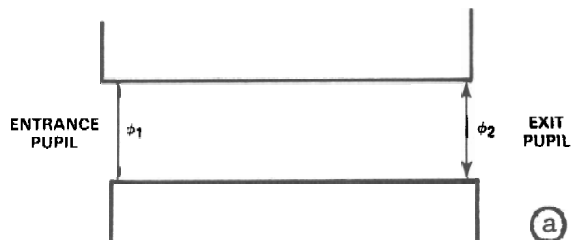

Figure 5. Configuration of hydrogen maser state selector magnet assembly.

NONTAPERED STATE SELECTOR – CUTAWAY



TAPERED STATE SELECTOR – CUTAWAY

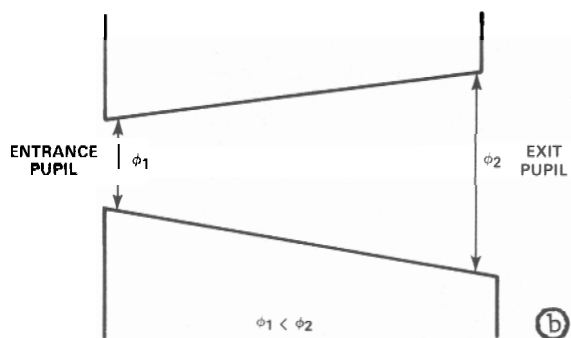

Figure 6. Pole pieces for the hydrogen maser state selector permanent magnet.

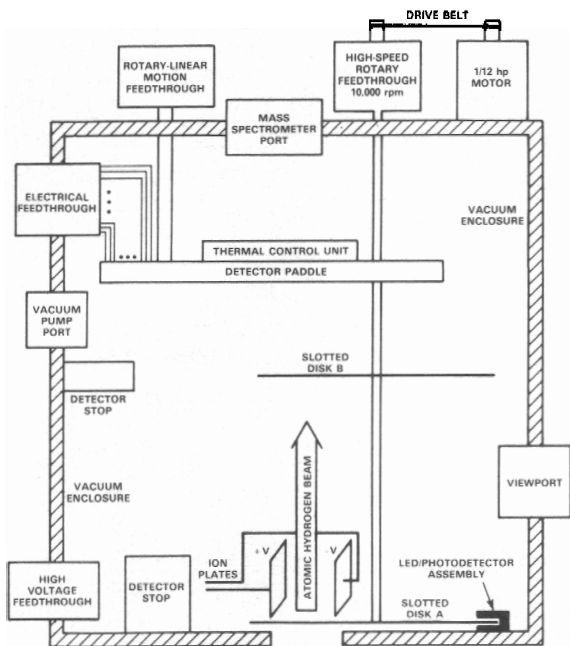

Figure 7. Vacuum system assembly for maser evaluation.

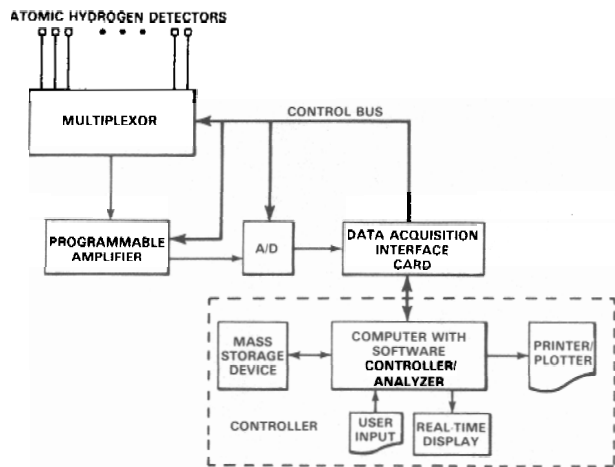

Figure 8. Data acquisition system for the atomic hydrogen detector.

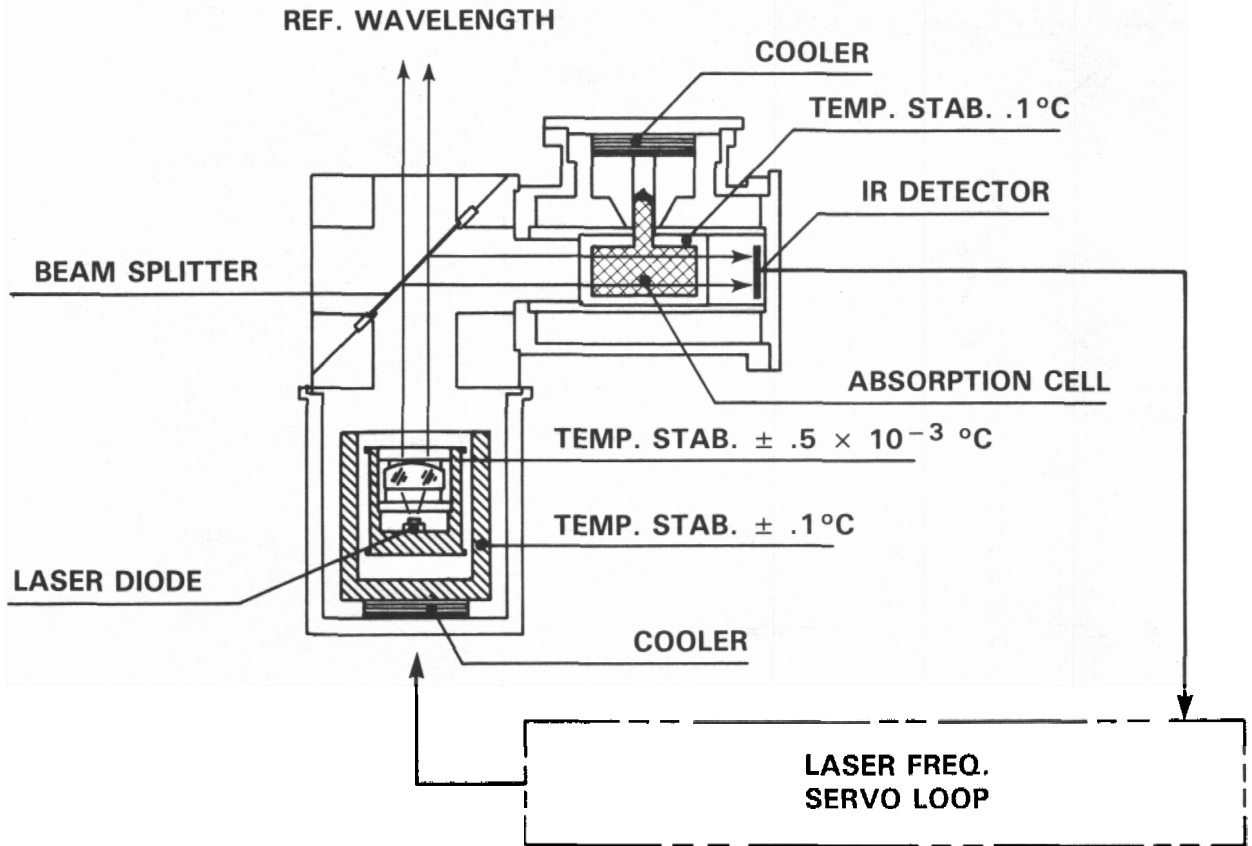

Figure 9. Laser stabilized against cesium 133, D2 line.

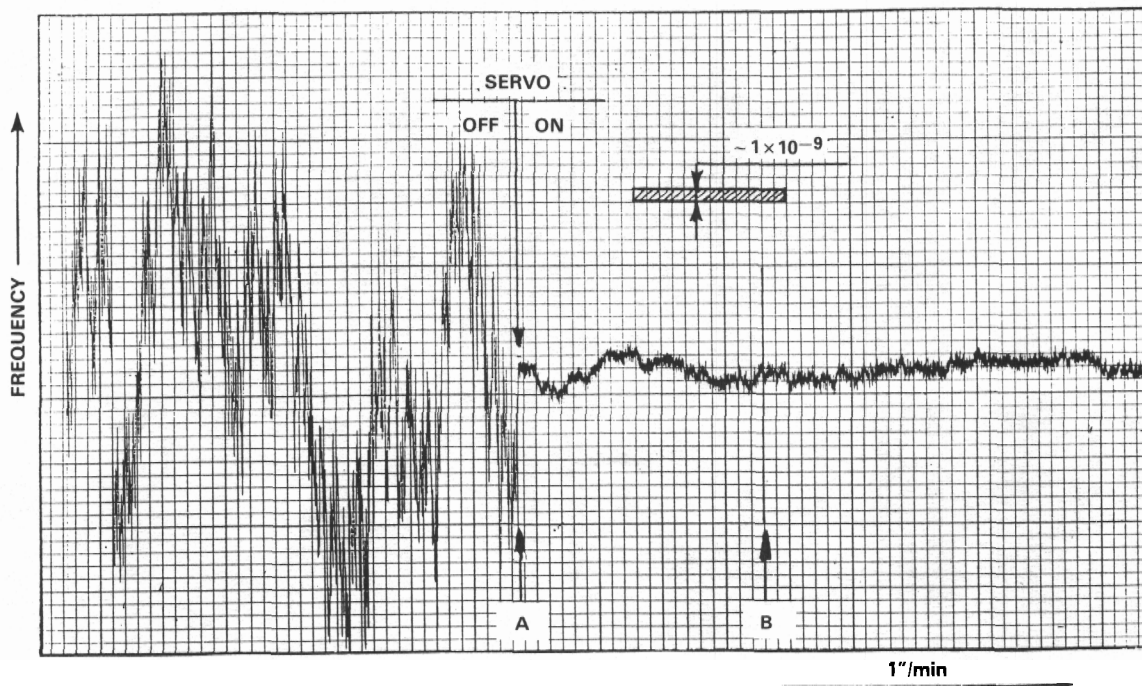

Figure 10. Laser frequency stabilization.

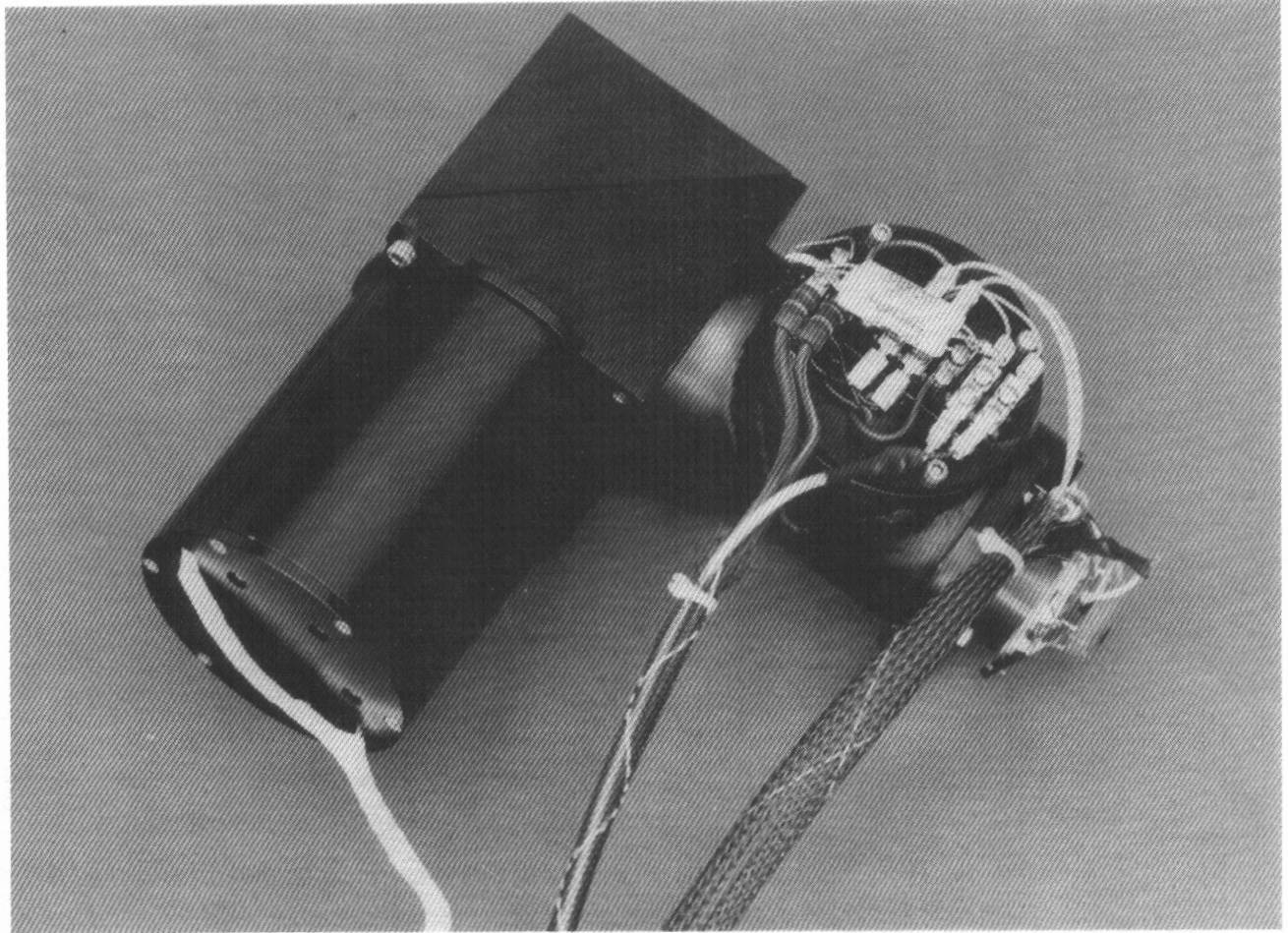

Figure 11. Atomic wavelength standard.

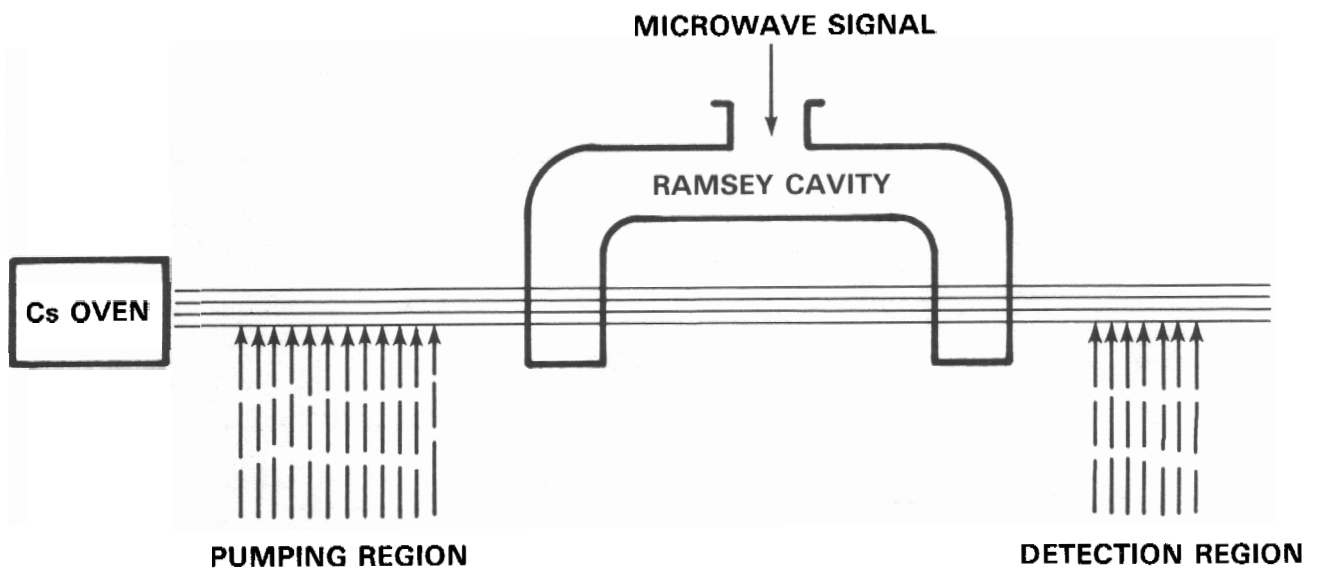

Figure 12. Principle of optically pumped cesium beams.

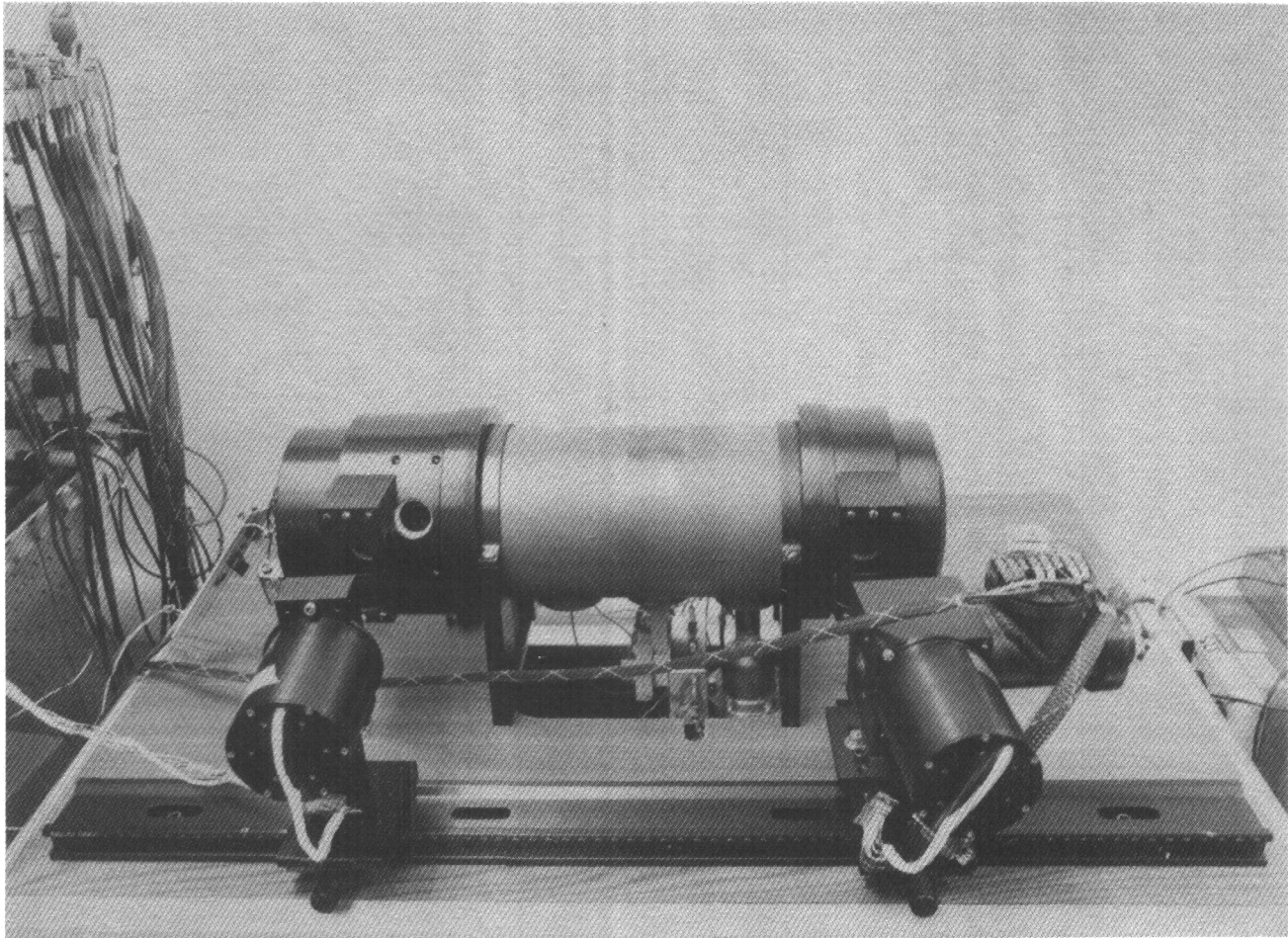
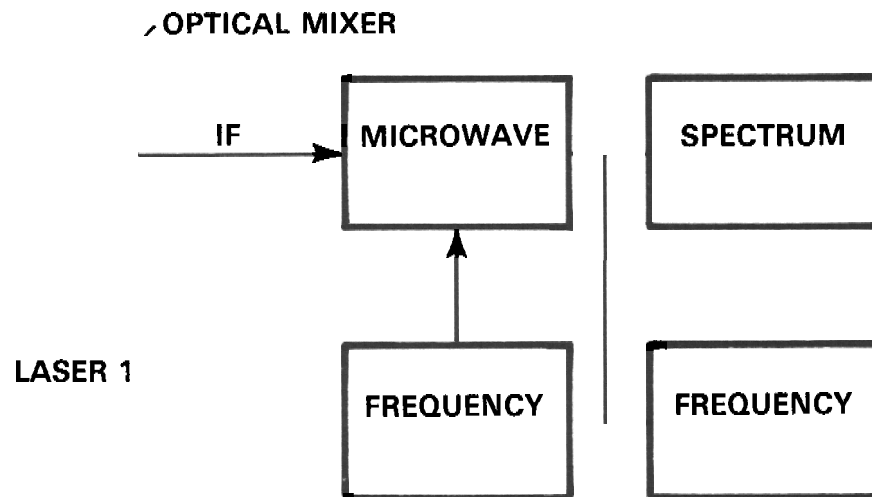

Figure 13. Experimental optically pumped cesium apparatus.



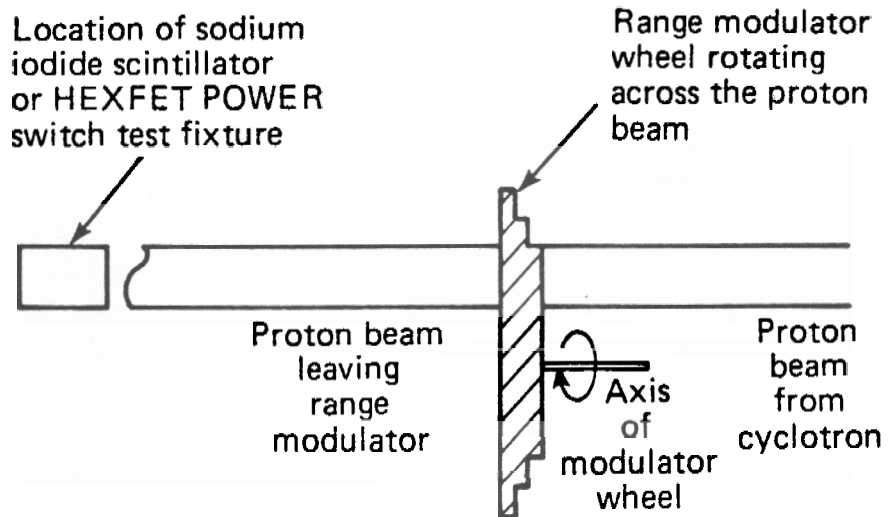

Figure 15. Proton modulator wheel configuration.

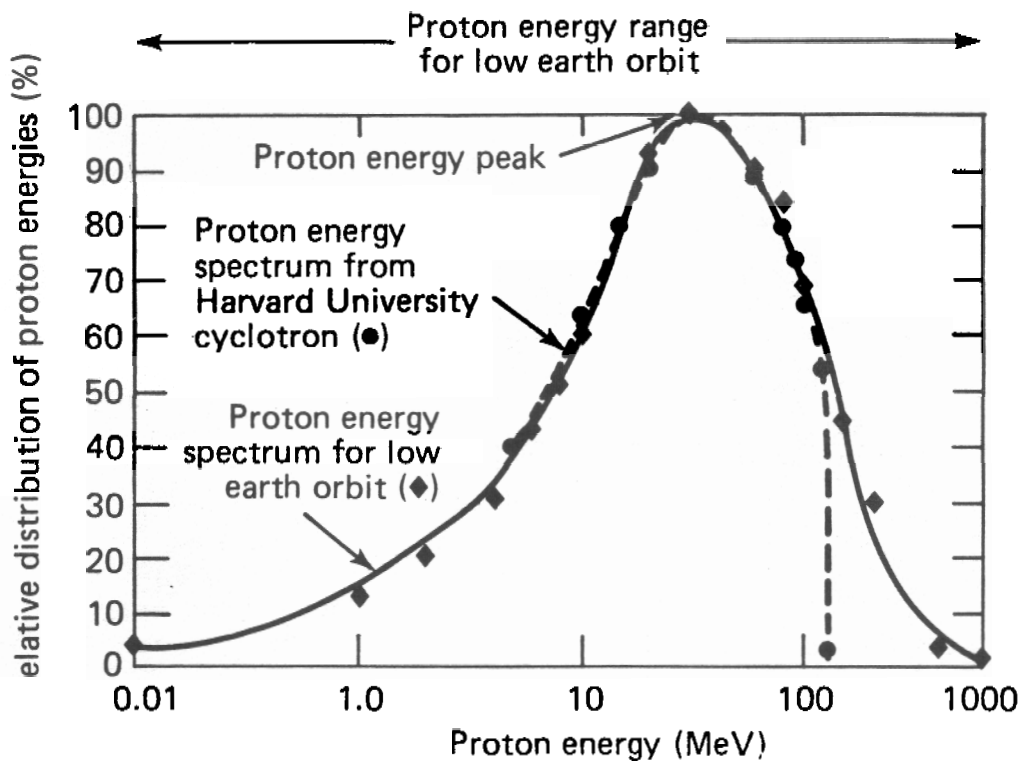

Figure 16. Low earth orbit and cyclotron proton spectra.

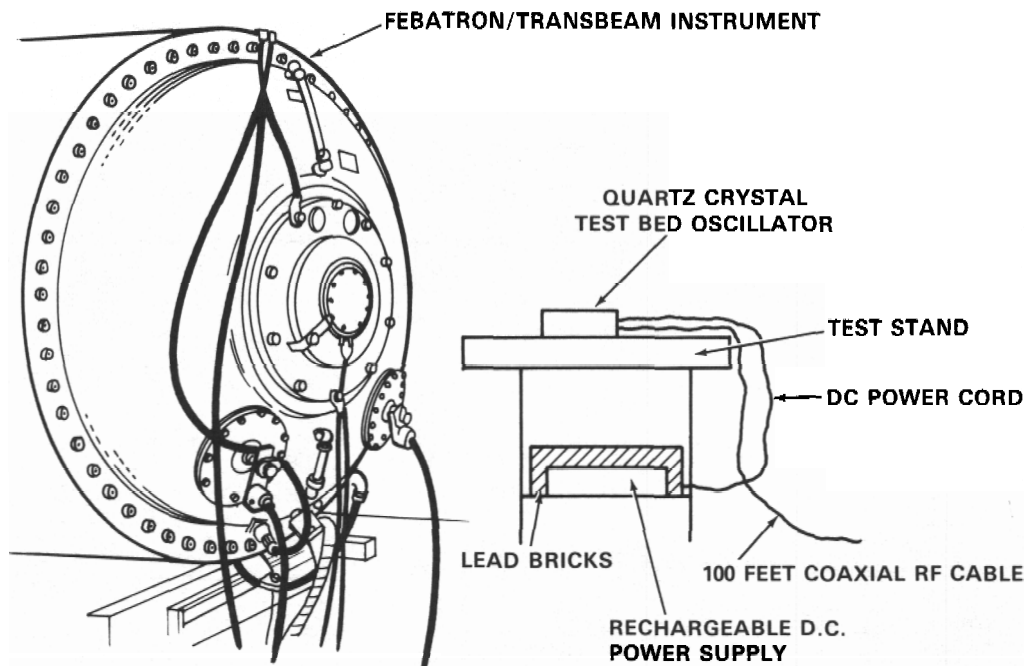

Figure 17. Flash X-ray test configuration.

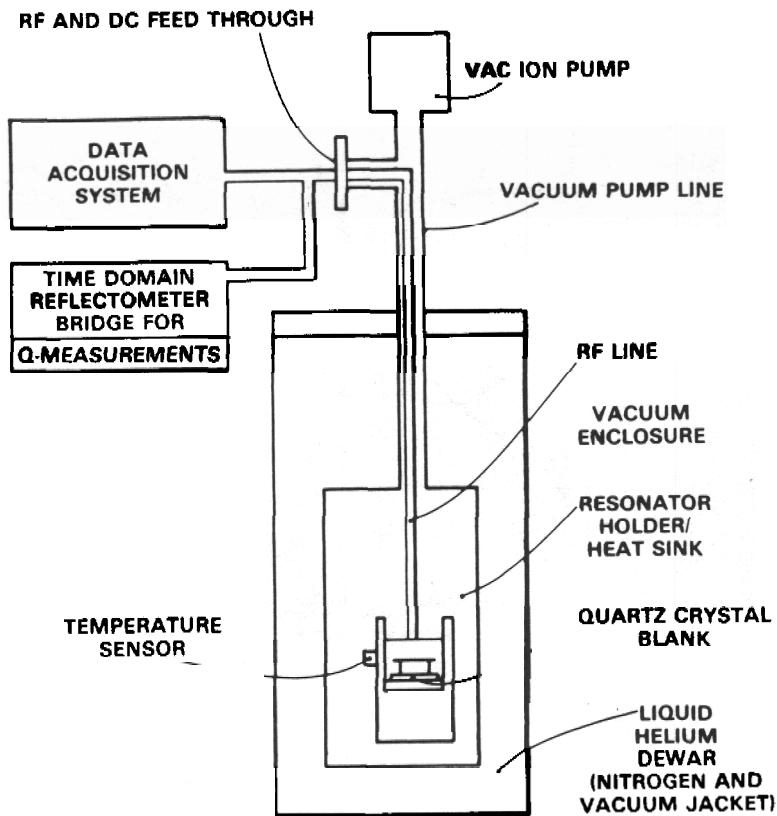

Figure 18. Supercooled quartz crystal cryogenic apparatus.