

**COMPARISON OF TIME SCALES GENERATED
WITH THE
NBS ENSEMBLING ALGORITHM***

Fran B. Varnum
Defense Mapping Agency, Technical Liason at
the GPS Master Control Station,
Falcon Air Force Station,
Colorado Springs, Colorado 80914

Donald R. Brown
Captain, USAF, Ch/Navigation Analysis
Section at the GPS Master Control Station,
Falcon Air Force Station,
Colorado Springs, Colorado 80914

David W. Allan
National Bureau of Standards, Time and
Frequency Division, 325 Broadway
Boulder, Colorado 80303

Trudi K. Pepler
National Bureau of Standards, Time and
Frequency Division, 325 Broadway
Boulder, Colorado 80303

ABSTRACT

The National Bureau of Standards (NBS), Boulder, Colorado, uses an algorithm which generates UTC(NBS) from its ensemble of clocks and automatically, optimally, and dynamically weights each clock in the ensemble. The same algorithm was used at the Master Control Station (MCS) of the Global Positioning System (GPS) to generate a time scale from a small ensemble of cesium clocks. Time transfer employing the GPS common view technique between NBS (Boulder) and MCS (Colorado Springs) was used to evaluate the stability of the MCS ensemble relative to UTC(NBS). The results demonstrate the power of the NBS algorithm in providing a stable time scale from a small ensemble of clocks. The resulting scale is, in principle, more stable than the best clock and a poor clock need not degrade the ensemble.

I. GENERAL

We decided to experimentally incorporate the National Bureau of Standards' (NBS) algorithm to generate ensemble time from a small ensemble of commercial cesium beam clocks at the GPS Master Control Station (MCS) in Colorado Springs. We therefore considered using GPS common-view time transfer between the MCS and NBS, Boulder Colorado, to evaluate the result. With this technique, independently generated time scales can be compared over long distances on a routine daily basis. In our experiment, the distance was only 90 miles, so differential ephemeris and propagation path errors were practically zero in the common-view mode of time transfer. Therefore, daily comparisons of MCS ensemble time with UTC(NBS) were

* Contribution of the US Government not subject to copyright

Report Documentation Page

Form Approved
OMB No. 0704-0188

Public reporting burden for the collection of information is estimated to average 1 hour per response, including the time for reviewing instructions, searching existing data sources, gathering and maintaining the data needed, and completing and reviewing the collection of information. Send comments regarding this burden estimate or any other aspect of this collection of information, including suggestions for reducing this burden, to Washington Headquarters Services, Directorate for Information Operations and Reports, 1215 Jefferson Davis Highway, Suite 1204, Arlington VA 22202-4302. Respondents should be aware that notwithstanding any other provision of law, no person shall be subject to a penalty for failing to comply with a collection of information if it does not display a currently valid OMB control number.

1. REPORT DATE DEC 1987	2. REPORT TYPE	3. DATES COVERED 00-00-1987 to 00-00-1987			
4. TITLE AND SUBTITLE Comparison of Time Scales Generated with the NBS Ensembling Algorithm		5a. CONTRACT NUMBER			
		5b. GRANT NUMBER			
		5c. PROGRAM ELEMENT NUMBER			
6. AUTHOR(S)		5d. PROJECT NUMBER			
		5e. TASK NUMBER			
		5f. WORK UNIT NUMBER			
7. PERFORMING ORGANIZATION NAME(S) AND ADDRESS(ES) Defense Mapping Agency, Falcon Air Force Station, Colorado Springs, CO, 80914		8. PERFORMING ORGANIZATION REPORT NUMBER			
9. SPONSORING/MONITORING AGENCY NAME(S) AND ADDRESS(ES)		10. SPONSOR/MONITOR'S ACRONYM(S)			
		11. SPONSOR/MONITOR'S REPORT NUMBER(S)			
12. DISTRIBUTION/AVAILABILITY STATEMENT Approved for public release; distribution unlimited					
13. SUPPLEMENTARY NOTES Proceedings of the Nineteenth Annual Precise Time and Time Interval (PTTI) Applications and Planning Meeting, Redondo Beach, CA, 1-3 Dec 1987					
14. ABSTRACT see report					
15. SUBJECT TERMS					
16. SECURITY CLASSIFICATION OF:			17. LIMITATION OF ABSTRACT Same as Report (SAR)	18. NUMBER OF PAGES 11	19a. NAME OF RESPONSIBLE PERSON
a. REPORT unclassified	b. ABSTRACT unclassified	c. THIS PAGE unclassified			

accomplished with a precision of 1.4 nanoseconds, providing a high resolution measure of the MCS ensemble performance.

The NBS algorithm generates ensemble time from a collection of cesium clocks; in place in the Boulder laboratory since 1968, the algorithm produces a time scale that is the weighted mean of all clocks in the ensemble. Weight assignment is semi-automatic and dynamic. The squared error of the scale (defined with respect to a perfect time scale) is minimized.

For this experiment, the NBS time scale was considered to be perfect. The ensemble at the MCS, on the other hand, had lower quality, consisting of only four commercial Hewlett-Packard cesium beam clocks (model 5061A), one of which was not a high-performance unit (004 option). Additionally, no special environmental controls were in place other than the normal building air conditioning. Nevertheless, the time scale produced by the MCS ensemble operating with the NBS algorithm was remarkably stable over the eighty day period of the experiment. This can be attributed to the relatively good performance of two clocks in the ensemble and the fact that the algorithm automatically and appropriately assigned the higher weights to these two clocks.

II. NBS TIMING ENSEMBLE ALGORITHM

The following is an outline of the NBS algorithm. A detailed discussion of this algorithm can be found in reference 2.

As input, the algorithm requires periodic time-difference measurements between all pairs of clocks in the ensemble, initial values of time and frequency for each clock, and two parameters derived from the observed Allan Variance of each clock (calculated from the $\tau^{-1/2}$ behavior and from the " τ " of the Allan Variance at the minimum variance point).

As output, the algorithm produces an estimate of the time and frequency offset of each clock with respect to the weighted mean of all clocks (ensemble time) at each measurement time. Physical realization of ensemble time can be had by physically steering any clock in the ensemble to produce an average zero-time estimate for the steered clock. In this experiment, no steering was done, but one of the ensemble clocks provided timing for the GPS time transfer receiver. Through this clock the MCS ensemble was compared to UTC(NBS).

The equations and definitions are as follows:

Definitions:

$X_i(t)$, $Y_i(t)$ = estimates of time and frequency offsets respectively of clock i at time t with respect to some reference time scale,

$X_i(t)$ = predicted time offset of clock i at time t ,

$Y_i(t)$ = estimate of frequency of clock i at t over the interval t to $t+\tau$,

$X_{ij}(t)$ = measured time difference between clocks i and j at time t ,

$\epsilon_i(g)$ = accumulated error in time estimate of clock i over the interval τ ,

$\langle \epsilon_E^2(\tau) \rangle$ = mean squared error in ensemble time over the interval τ at time t ,

$\langle \rangle$ = indicates time average,

τ = time interval between measurements,

N_τ = time constant of exponential filter to estimate the current mean squared error,

n = number of clocks in the ensemble,

τ_{MINi} = value of τ at minimum $\sigma_y(\tau)$ on Allan Variance curve for clock i .

Equations:

$$(1) \quad X_i(t + \tau) = X_i(t) + Y_i(t)\tau$$

$$(2) \quad X_j(t + \tau) = \sum_{i=1}^n w_i(\tau)[X_i(t + \tau) - X_{i,j}(t + \tau)]$$

$$(3) \quad Y_i(t + \tau) = \frac{[X_i(t + \tau) - X_i(t)]}{\tau}$$

$$(4) \quad Y_i(t + \tau) = \frac{1}{m_i + 1}[Y_i(t + \tau) + m_i Y_i(t)]$$

$$(5) \quad |\epsilon_i(g)| = |X_i(t + \tau) - X_i(t)| + K_i$$

$$(6) \quad \langle \epsilon_i(g) \rangle_{t+\tau} = \frac{1}{n_\tau + 1}[\epsilon_i^2(\tau) + N - \tau \langle \epsilon_i^2(\tau) \rangle_t]$$

$$(7) \quad \langle \epsilon_E^2(\tau) \rangle = \left[\sum_{i=1}^n \frac{1}{\epsilon_i^2(\tau)} \right]^{-1}$$

$$(8) \quad w_i = \frac{\langle \epsilon_E(\tau) \rangle}{\langle \epsilon_i^2(\tau) \rangle}$$

$$(9) \quad K_i = \frac{.8 \langle \epsilon_E^2 \rangle}{\langle \epsilon_i^2 \rangle^{1/2}}$$

$$(10) \quad m_i = \frac{1}{2} \left[-1 + \left[\frac{1}{3} + \frac{4\tau^2 M I N_i}{3\tau^2} \right]^{1/2} \right]$$

Explanation of equations:

Equation 1: forms a prediction of the time offset for each clock for the next measurement time ($t + \tau$) based on the current estimates of time and filtered frequency.

Equation 2: estimates the time offset of each clock j at time $t + \tau$ given the measurements $X_{i,j}(t + \tau)$.

Equation 3: is an estimate of the average frequency of each clock over the interval τ based on the latest two estimates of X_i .

Equation 4: incorporates past measurements into an exponential filtered estimate of the current average frequency of clock i . The time constant for the filter was chosen to be $N_\tau = 20$ days. The exponential frequency-weighting time constant (m_i) is determined from the relative levels of white noise and random walk (or flicker) FM for clock i (equation 10).

Equation 5: is the accumulated error in the estimate of X_i over the interval τ . The additive term K_i accounts for the fact that the term in brackets on the right-hand side of Equation 5 is biased because clock i is part of the ensemble. See equation 9 to calculate K_i .

Equation 6: is an exponential time filter for the determination of the mean square time error of each clock. Recognizing that the noise characteristics of a cesium clock may not be stationary, past measurements are de-weighted in the averaging process. The initial value of $\langle \epsilon^2(\tau) \rangle$ can be estimated as $\tau^2 \sigma^2(\tau)$.

Equation 7: forms an estimate of ensemble time error. Any clock can only improve this number—a poorly performing clock cannot harm the stability of the ensemble.

Equation 8: calculates the weight to be used in Equation 2 for each clock. When calculated this way, the resulting error in ensemble time with respect to a perfect clock can be shown to be minimized in a least squares sense.

Equation 9: The error estimate from the first term on the right of Equation 5 is, on the average, biased small, because each clock is a member of the ensemble, and sees itself through its weighting factor. The larger a clock's weight, the larger is the bias. Under the assumption of a normal distribution of errors the size of the bias can be estimated as given by Equation 9, which is added to Equation 5 in order to remove the bias, on the average.

Equation 10: Computes m_i used in Equation 4 to form the filtered estimate of the frequency of clock i . This value of M can be shown to minimize the error in predicting time (Equation 1) given two kinds of noise in the clock (white and random walk FM). If white FM and flicker FM are more suitable models, then m_i can be approximated as τ_I/τ , where τ_I is the intercept value of τ on a $\sigma_y(\tau)$ plot for the white and flicker FM.

III. DESCRIPTION OF EXPERIMENT

Figure 1 is a combined hardware/software flow chart of the experiment. Four clocks, located at the MCS, are linked by a measurement system to provide the time difference between each clock and a reference clock. Measurements are taken hourly, but, for this experiment, daily measurements were used to eliminate the effects of measurement noise. Differences between measurements provide the data required for the NBS algorithm. The algorithm, implemented at the MCS on a PC, produced the ensemble time of each clock (ENS-1, ENS-2, etc.).

The reference clock also provided receiver timing for common-view time transfer between MCS and NBS. The common view time transfer data were processed at the NBS Time and Frequency laboratory to provide daily measures of the time offset between UTC(NBS) and the reference clock in the MCS ensemble (NBS-REF). These data were differenced with the measurements (REF-1, REF-2, etc.) so the time behavior of each clock in the MCS ensemble could be evaluated with respect to UTC(NBS). Finally, the ensemble behavior (i.e. ENS-UTC(NBS)) was obtained from each clock's behavior with respect to both the MCS ensemble and UTC(NBS). This served as an independent measure of ensemble behavior over the test period.

IV. RESULTS

Figure 2 is a plot of the accumulated time difference between MCS ensemble time and UTC (NBS) as obtained in the manner just described. A constant frequency difference of 1.2 parts in 10^{13} has been removed. A frequency difference will exist between two independent time scales; the fact that it was so small in this case is coincidental. The nondeterministic behavior of the ensemble is quantified in the Allan Variance curve (figure 3). The stability of the four-clock ensemble is remarkable in view of the poor performance of clocks 1 and 2 (figure 5). This stability is attributed to the good performance of the other two clocks, and the NBS algorithm which weighted the better clocks higher (figure 4).

Figure 4 shows the history of the individual weights assigned by the algorithm to each clock over the eighty-day period. Clock 2 received a very low weight. It is the poorest performing clock as indicated by independent comparison with UTC(NBS) (figure 5) and is the clock without the high performance tube. Because of the limited time span of the test, the initial weights were based upon an experimental run with the first two weeks' data. For the experimental run, the clocks were initially weighted equally (25%) and the resulting

weights, after two weeks, were used to initialize the eighty-day run. This procedure eliminated a two-week transient period which would have biased the result.

Note that, in Figure 4, the weight of clock 1 dropped to zero on MJD 46971. This was the result of an automatic de-weighting of this clock due to a failure of the algorithm to predict this clock's behavior between measurements to within three sigma of the estimated clock error. Apparently the frequency change exhibited by clock 1 (figure 5) on MJD 46971 was detected and the algorithm de-weighted clock 1, preventing perturbation of the ensemble. In figure 2, removal of a heavily weighted clock did not perturb ensemble time or frequency. It is a very important feature of the NBS algorithm that clocks can be removed (and added) with minimal perturbation.

The weights of the clocks shown in figure 4 are sometimes called the short-term stability weights since these are the optimum weights for the interval between measurements. The ratio of the long-term stability performance to the short-term often varies significantly between clocks. The m_i parameters reflect the long-term stability performance. The values used for this parameter for clocks 1, 2, 3, and 4, were 0.15, 1, 18, and 2 respectively. Figure 6 shows the corresponding frequency stability, $\sigma_y(\tau)$, of each of the clocks in the MCS ensemble.

In order to make an estimate of the measurement uncertainty between the MCS and UTC(USNO MC) (direct common view time transfer between the MCS and USNO is carried out routinely) NBS measured UTC(USNO MC) minus UTC(NBS) (Figure 7), then differenced that with the data in figure 2. This gave a different path estimate of UTC(USNO MC) minus MCS ensemble than the direct one. The difference between the direct path measurement and this latter path is plotted in figure 8, and the corresponding MOD $\sigma_y(\tau)$ plot is shown in figure 9. The -1 slope characterizing the stability values plotted in figure 9 would indicate a model of flicker noise time (phase) modulation (PM) with $\tau\sigma_y(\tau) = 4$ nanoseconds.

V. CONCLUSION

The theory upon which the NBS timekeeping algorithm is based predicts an ensemble stability better than the best clock and, in principle, the ensemble stability is not harmed by a poor clock. Also, the ensemble stability is not adversely perturbed by adding or dropping a clock. This experiment supports these theoretical inferences; the experiment is based on real data and independent measures of ensemble behavior.

This improved clock performance from a weighted clock set, when employed in GPS operationally, will provide three significant advantages: (1) the improved stability will provide the opportunity to have better synchronization to UTC; (2) the system will be much more immune to the failure or mal-performance of an individual clock; and (3) the improved long-term performance gained from the ensemble will improve autonomous GPS performance (i.e. 180 day navigation messages).

ACKNOWLEDGMENTS

The authors are indebted to Mr. Mihran Miranian for his excellent support in providing data from the USNO files. Dr. Judah Levine also provided excellent assistance, and we are indebted to him.

REFERENCES

1. Weiss, M.A. and Allan, D. W., "An NBS Calibration Procedure for Providing Time and Frequency at a Remote Site by Weighting and Smoothing of GPS Common View Data," Proceedings of the CPEM Conference, Gaithersburg, MD, June 1986.
2. Allan, D. W., Gray, J. E., and Machlan, H. E., "The National Bureau of Standards Atomic Time Scale: Generation, Stability, Accuracy, and Accessibility," Chap. 9, Time and Frequency: Theory and Fundamentals, B. E. Blair, Ed., Nat. Bur. Stand. (U.S.) Monograph 140.

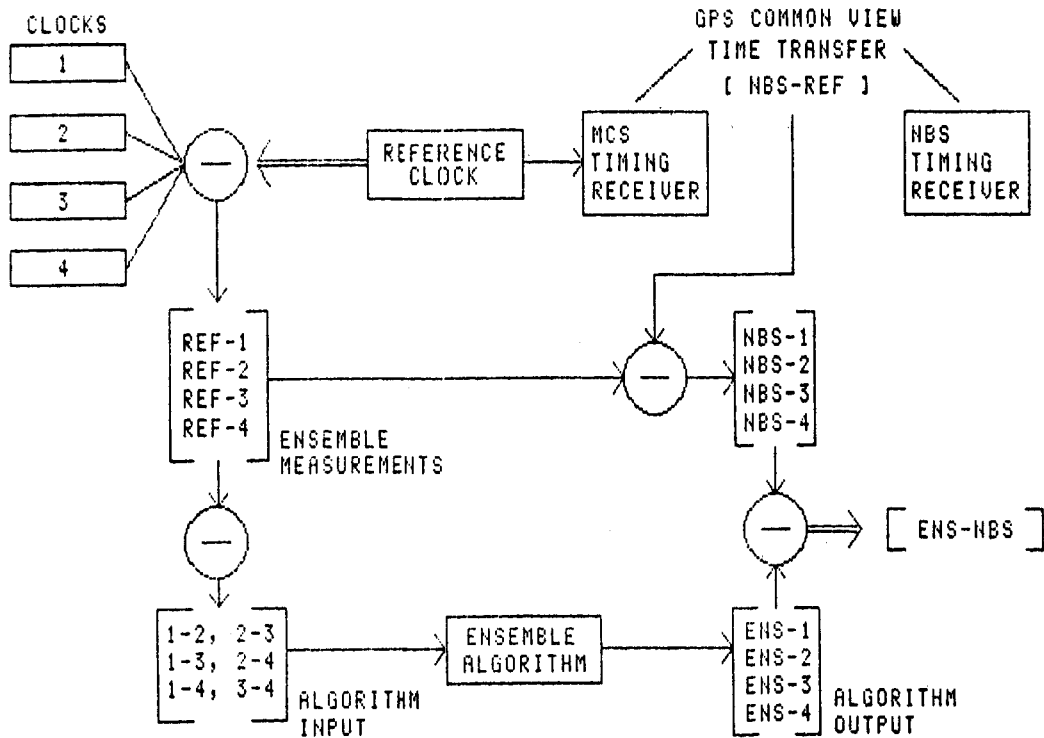

Figure 1. A combined flow chart and block diagram of the hardware/software system employed in the experiment.

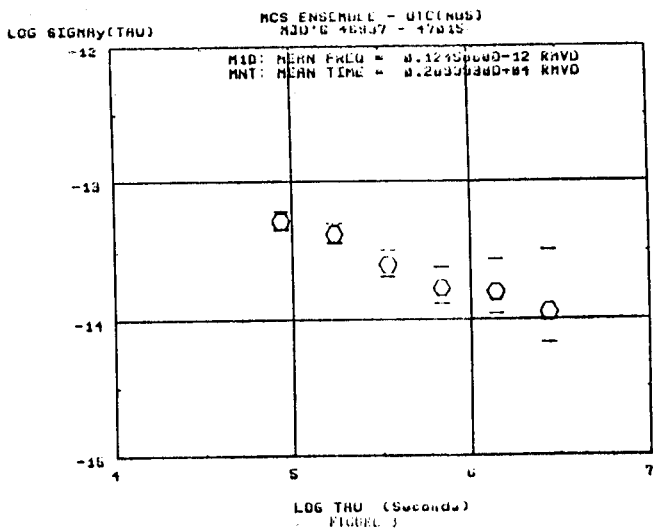
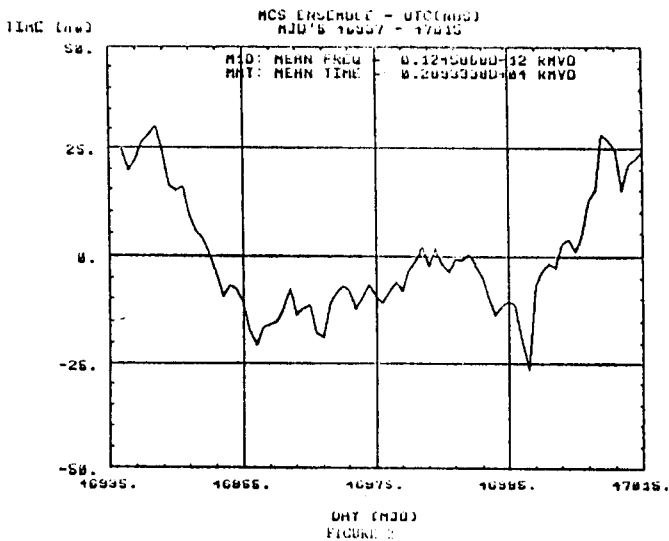

Figure 2. A plot of the residual time differences between the MCS ensemble time and UTC(NBS) after subtracting the mean frequency and the mean time from the data. The plotted values cover the period from 21 May through 9 August 1987.

Figure 3. A plot of the fraction frequency stability, $\sigma_y(\tau)$, of the data shown in Figure 2. The outstanding long term stability at integration time of a few weeks is evident. The stability at one and two days is probably limited by measurement noise.

DYNAMIC WEIGHTS ASSIGNED

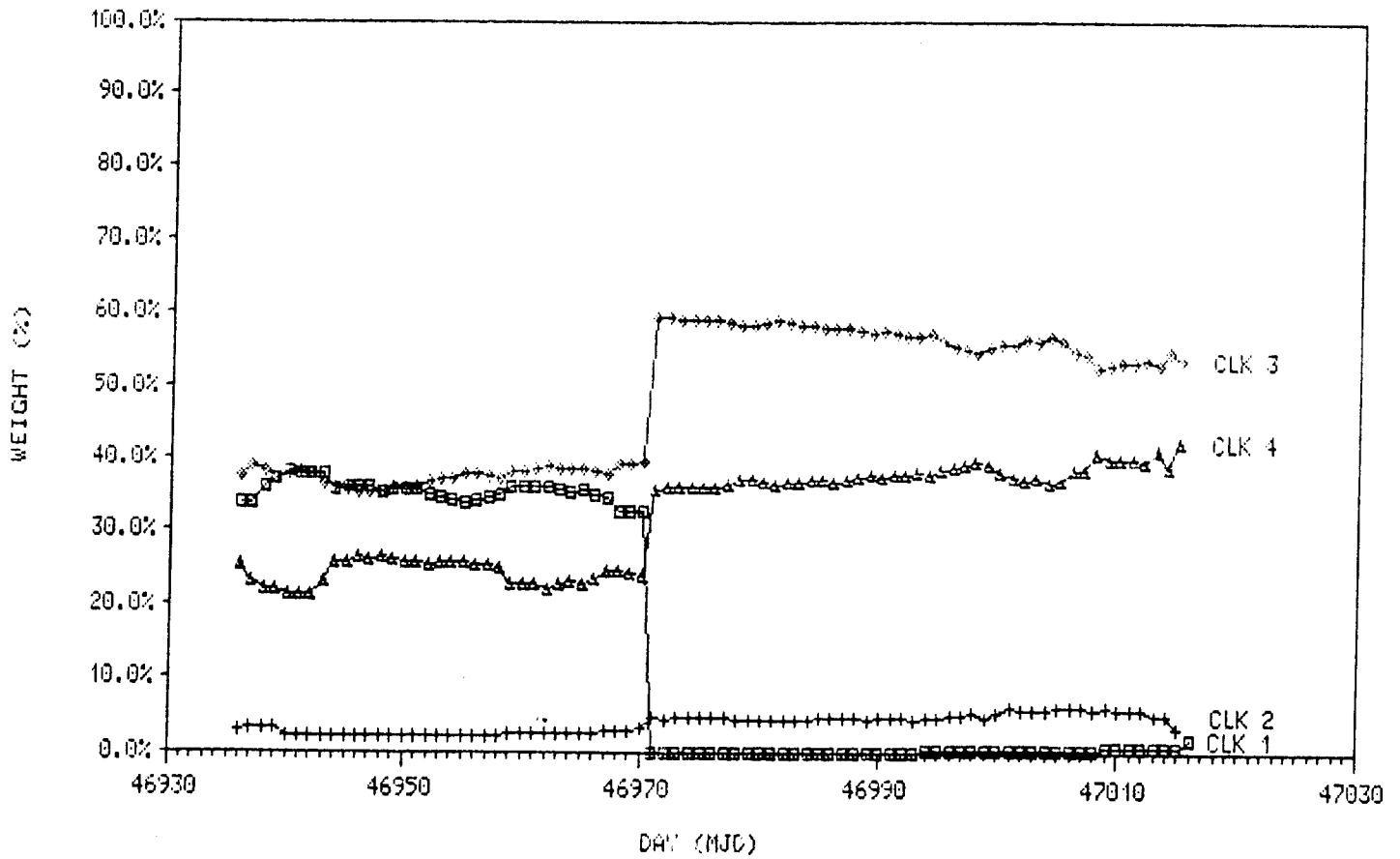

Figure 4. A plot of the percentage weights assigned to each of the four clocks over the course of the experiment. Notice that the weight of clock 1 is set to zero at the point where a frequency step was detected (MJD 46970).

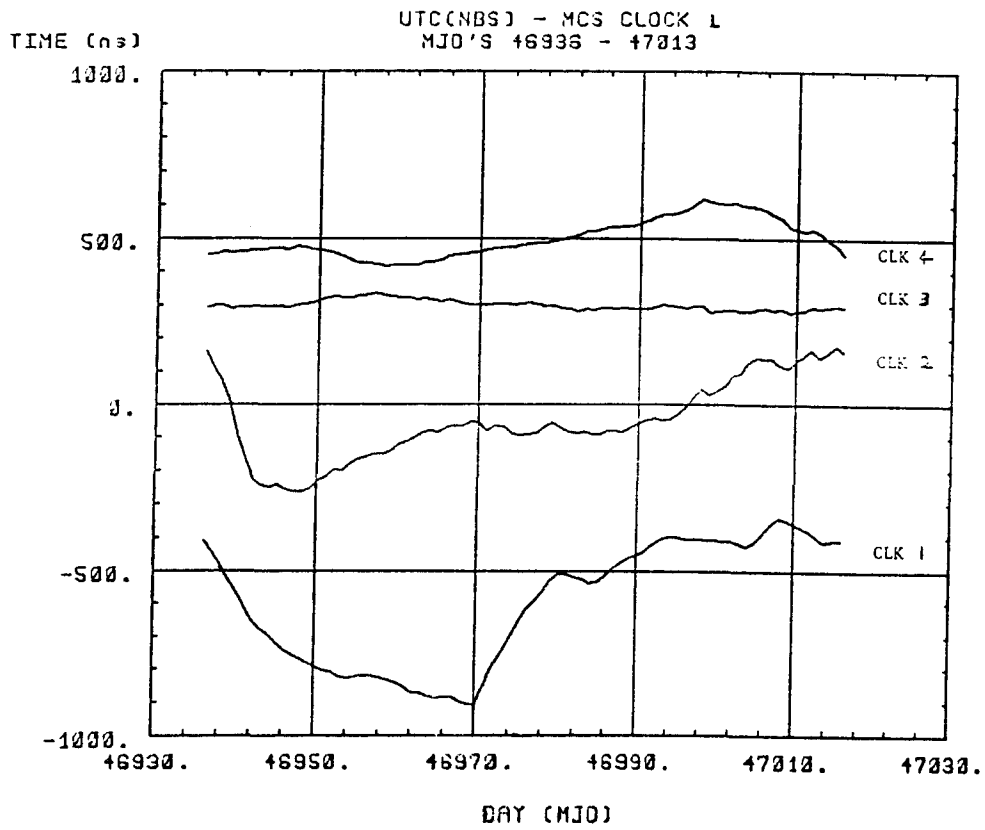

Figure 5. A plot of the time residuals of each of the clocks versus the MCS ensemble after removing a mean frequency and also after setting an arbitrary scaling factor for the initial ordinate for each clock. This was done for the convenience of plotting and display of these residuals.

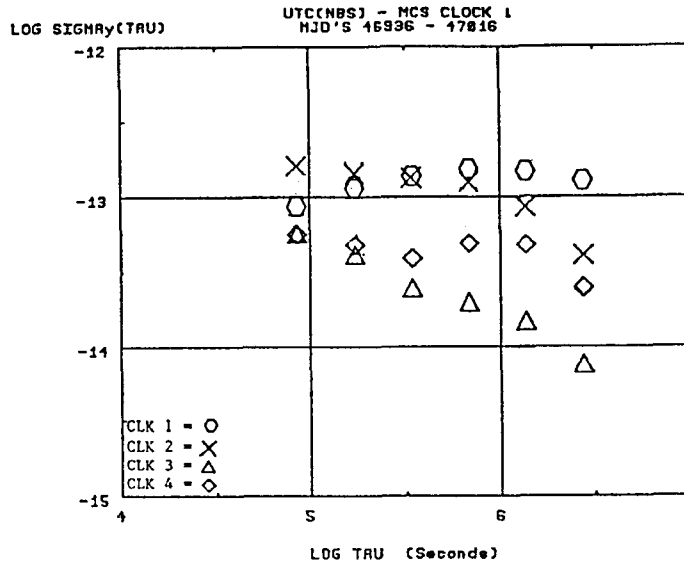

Figure 6

Figure 6. A plot of the fractional frequency stability, $\sigma_y(\tau)$, for each of the MCS clocks against an independent reference, UTC(NBS). The advantage of an algorithm using statistical weighting is obvious from the very different performance of these four clocks.

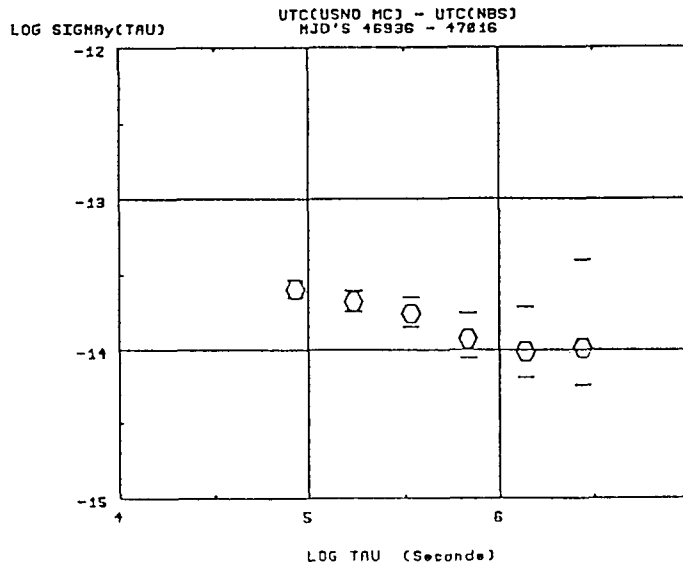

Figure 7

Figure 7. A plot of UTC(USNO MC) versus UTC(NBS) is shown for reference for the period of the experiment. Since these are independent time scales, we can conclude that the stability shown is the square root of the sum of the variances of each, and that the reference scale used in this experiment, UTC(NBS), is everywhere better than the values plotted here.

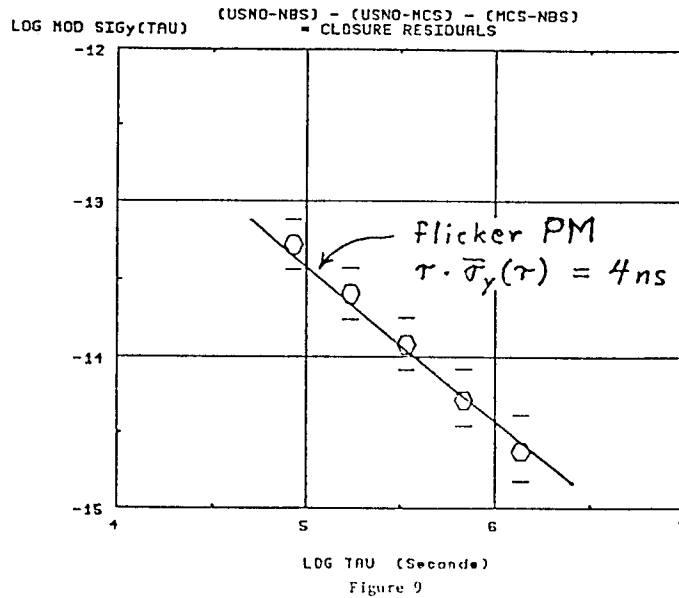
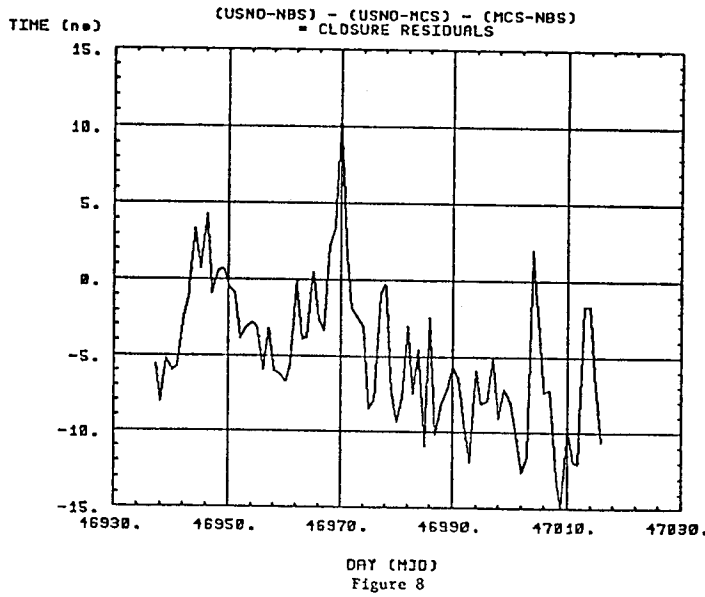

Figure 8 & 9. A test was made on the GPS common-view measurement residuals by completing the measurement triangle: MCS at Colorado Springs, CO to NBS at Boulder, CO to USNO at Washington D. C. and thence back to the MCS. Figure 8 shows the time residuals for the sum of the three legs, which should be zero if the system were perfect, and Figure 9 is a modified $\sigma_y(\tau)$ plot showing that the residuals can be modeled by a flicker noise phase modulation (PM) at a level of $\tau\sigma_y(\tau) = 4$ nanoseconds with the data being taken once per sidereal day for the GPS common-view measurements. If each leg were equal in its contribution and independent of the others, its contribution would be 2.3 nanoseconds. We measured the common-view noise of the MCS, NBS path at 1.4 nanoseconds, which is reasonable since that leg is much shorter than the other two. Notice that there is an apparent bias of about -5 nanoseconds indicated in Figure 8.

QUESTIONS AND ANSWERS

Gernot Winkler, USNO (not into the microphone): Indecipherable question

Mr. Varnum: None of them. That clock was not included in the ensemble.

Dr. Winkler had a further question

Mr. Varnum: Two of them were the observatory, two of them were GPS clocks.

Don Percival, University of Washington: The one clock which experienced the abnormality in frequency and seemed to recover afterwards, but the weight did not start to increase after a while. Do you have an explanation for that?

Mr. Varnum: It did increase but it was not visible with the resolution on the plot. Perhaps it did not increase as fast as it should have, and that is probably a limitation within the algorithm as we implemented it. It did perform well enough to have been more heavily weighted than it was.

Mr. Percival: Did you give any thought to looking at the Jones-Trion(sp?) algorithm which was developed at NBS to see how it would compare with the one you have now?

Mr. Varnum: No, I haven't, I am not familiar with it.

David Allan, NBS: The Jones-Trion(sp?) that Don is referring to is based on Kalman optimization. In theory it is supposed to be as good or better than the NBS algorithm. We have found, in our implementation of it, that we have seen frequency steps occur when clocks are added or deleted from the ensemble. We are not sure why, there may be some theoretical problems. The NBS algorithm seems to be immune from that effect as this paper demonstrates.

Jim Wright, Pan American: How long did it take you to establish your initial parameters, initial weighting?

Mr. Varnum: I used a two week period for that. In fact, to give you the details, I processed the data that you saw for two weeks to generate a set of weights, then went back to the beginning and used those weights as the input to the algorithm.

Mr. Wright: Another question—when you dropped down to three clocks, it seems that one of the clocks was carrying about sixty per cent of the entire weight. Do you have any concerns about that?

Mr. Varnum: Yes, that is a concern in a practical case. If any one clock assumes too much weight and something happens to that clock, then you would expect that the ensemble time would deteriorate. In practice, there is usually a limitation applied. I did not do that in this experiment, but you would normally try to prevent that from happening.