

# THE COAST ARTILLERY JOURNAL

Member Affiliated Military Magazines

Published as the Journal U. S. Artillery from 1892 to 1922

MAJ. STEWART S. GIFFIN, C. A. C., Editor

EDWIN H. CROUCH, Business Manager

Volume 74

MAY-JUNE, 1931

Number 4

## Contents

Frontispiece .....	246	Superstitions of Samar .....	286
Coast Artillery Gunnery and Training with Special Reference to Methods and Materiel .....	247	Lt. T. Q. Ashburn, Jr., C. A.-Res.	
Brig. Gen. R. E. Callan, U. S. A.		Events Overseas .....	288
Coast Artillery Training at West Point .....	250	Lt. Col. Herman Beukema, Professor, U. S. Military Academy.	
Capt. E. W. Timberlake, C. A. C.		National Guard Notes .....	294
The Mechanized Force—Its Organization and Present Equipment .....	255	Field Inspections—The Ration Allowance—Economy—Efficiency—Classification.	
Capt. Arthur Wilson, F. A.		Coast Artillery Board Notes .....	297
Individual Tracer Control for Antiaircraft Machine Gun Fire .....	260	Professional Notes .....	300
Capt. D. M. Griggs, C. A. C.		What Happens When a Vickers Director is Used Against a Diving Target: by Major G. B. Welch, O. D.	
Possibilities of the Tank .....	263	Coast Artillery Activities .....	303
Col. Fred H. Wagner, O. R. C.		Chief of Coast Artillery's Inspection—The Coast Artillery School—Relief of Executive—National Guard Shooting—Harbor Defenses of Manila and Subic Bays—The 69th Coast Artillery (AA)—13th Coast Artillery (HD)—Harbor Defenses of Honolulu—The 61st Coast Artillery (AA)—The 64th Coast Artillery (AA)—Maine Chapter of Coast Artillery Association Organized at Portland—The 213th C. A. (AA) (Pa. N. G.)—Coast Artillery Reserve—243d Coast Artillery (HD) (R. I. N. G.)—The 249th Coast Artillery—Contact Camp at Erie Ordnance Depot—Reserve Officers Association of New York—New Reserve Regulations Published—Summer Training Camps—Reserve Units.	
The Gold Star Pilgrimage .....	268	Notes of the Coast Artillery Association .....	313
Capt. Lawrence C. Mitchell, C. A. C.		Coast Artillery Orders .....	315
The United States Looking Outward .....	271	Book Reviews .....	318
Col. S. C. Vestal, C. A. C.		My Experiences in the World War—The Rise of U. S. Grant—Marines and Others—Mount Vernon—Best Short Stories of the War.	
Military Instruction Films .....	274		
Capt. Alonzo P. Fox, S. C.			
Industry and National Defense .....	277		
Maj. Gen. George Van Horn Moseley, U. S. A.			
The Officers' Reserve Corps .....	280		
Major L. L. Stuart, C. A. C.			
Saving Prospective Reserve Officers .....	284		
Lt. Col. G. W. Fisher, C. A.-Res.			

The COAST ARTILLERY JOURNAL pays for original articles upon publication.

Published bi-monthly under the supervision of the United States Coast Artillery Association for the information of the Coast Artillery personnel of the Regular Army, National Guard and Organized Reserve.

Publication Offices, Telegraph Press Building, Cameron and Kelker Sts., Harrisburg, Pa.; Editorial Offices, 1115 17th Street, N. W., Washington, D. C.

Terms: \$4.00 per year. (Coast Artillery Association members, \$3.00 per year). Single copies, 75 cents.

Entered as second class matter at Harrisburg, Pa., Feb. 12, 1931, under the Act of March 3, 1879, for mailing at special rate of postage provided for in Section 412, Act of October 3, 1917.

Copyright, 1931, by the United States Coast Artillery Association.

# Report Documentation Page

*Form Approved  
OMB No. 0704-0188*

Public reporting burden for the collection of information is estimated to average 1 hour per response, including the time for reviewing instructions, searching existing data sources, gathering and maintaining the data needed, and completing and reviewing the collection of information. Send comments regarding this burden estimate or any other aspect of this collection of information, including suggestions for reducing this burden, to Washington Headquarters Services, Directorate for Information Operations and Reports, 1215 Jefferson Davis Highway, Suite 1204, Arlington VA 22202-4302. Respondents should be aware that notwithstanding any other provision of law, no person shall be subject to a penalty for failing to comply with a collection of information if it does not display a currently valid OMB control number.

1. REPORT DATE <b>JUN 1931</b>	2. REPORT TYPE	3. DATES COVERED <b>00-05-1931 to 00-06-1931</b>			
4. TITLE AND SUBTITLE <b>The Coast Artillery Journal. Volume 74, Number 4, May-June 1931</b>		5a. CONTRACT NUMBER			
		5b. GRANT NUMBER			
		5c. PROGRAM ELEMENT NUMBER			
6. AUTHOR(S)		5d. PROJECT NUMBER			
		5e. TASK NUMBER			
		5f. WORK UNIT NUMBER			
7. PERFORMING ORGANIZATION NAME(S) AND ADDRESS(ES) <b>Coast Artillery Training Center, Coast Artillery Journal, Fort Monroe, VA, 23651</b>		8. PERFORMING ORGANIZATION REPORT NUMBER			
9. SPONSORING/MONITORING AGENCY NAME(S) AND ADDRESS(ES)		10. SPONSOR/MONITOR'S ACRONYM(S)			
		11. SPONSOR/MONITOR'S REPORT NUMBER(S)			
12. DISTRIBUTION/AVAILABILITY STATEMENT <b>Approved for public release; distribution unlimited</b>					
13. SUPPLEMENTARY NOTES					
14. ABSTRACT					
15. SUBJECT TERMS					
16. SECURITY CLASSIFICATION OF:			17. LIMITATION OF ABSTRACT	18. NUMBER OF PAGES	19a. NAME OF RESPONSIBLE PERSON
a. REPORT <b>unclassified</b>	b. ABSTRACT <b>unclassified</b>	c. THIS PAGE <b>unclassified</b>	<b>Same as Report (SAR)</b>	<b>78</b>	

# THE OLD SERGEANT'S CONFERENCES

By Colonel William H. Waldron, U. S. A.

**T**HE Old Sergeant and his Wards—the Oracle and the worshipers at his shrine—assemble on the barrack steps after supper. The Evening Conference is on. Here the young soldiers bring their problems for solution. The Old Sergeant discusses them freely and frankly. Out of the wealth of his personal experience he supplies the answers where he can.

## Here Are Some of the Things He Discusses

**H**OW to get along in the Army and make a success of the soldier game.

What the Soldiers' Home at Washington, D. C., means to the Regular Army Soldier.

How the soldier's job in the army compares with the one he can get on the outside.

What military courtesy and military discipline mean to the soldier and why they are so necessary in the Army.

How the soldier gets back to his outfit when he goes A. W. O. L.

**S**OME of the reasons why soldiers desert and how they may be avoided.

What an honorable discharge means to the soldier when he goes back to civil life.

Why the soldier gets permission from the First Sergeant to see the Company Commander.

What it costs the soldier to change station without authority.

How K. P. details may be worked out to the advantage of the soldier.

**M**ANY company commanders have found that the text of the Old Sergeant's Conferences includes the very material they require for their Noncommissioned Officer Schools, and are using it there.

**E**VERY soldier in the army should have a copy of this book for his very own. Company commanders have found that those soldiers who have read the book take on a new interest in the soldier game and get along better in their outfit.

ORDER YOUR COPY TODAY

PRICE \$1.50, POSTPAID

The Coast Artillery Journal

1115 17th Street, N. W.

Washington, D. C.

**New • Up-to-Date • Complete • Authoritative • Pocket Size • Official**

*With Complete Topical Index*

# Infantry Drill Regulations

**BASIC FIELD MANUAL—VOLUME II**

*The Official Text of the War Department*

This new, handy volume takes the place of 20 Training Regulations you now need to cover the same ground. It contains 270 pages and 98 illustrations made for this text

## PRICES

{ In Blue Cloth Binding \$1.60 Postpaid }  
{ In flexible, waterproof leatherette binding, \$1.80 Postpaid }

*In quantities of 10 or more of either or both bindings we allow a discount of 25% f. o. b. Washington, D. C.*

*Your name stamped in gold on leatherette binding, 35 cents a copy (1 line) or 50 cents (2 lines)*

# THE COAST ARTILLERY JOURNAL

1115 17th Street, N. W.

Washington, D. C.

# THE UNITED STATES COAST ARTILLERY ASSOCIATION



*“The purpose of the Association shall be to promote the efficiency of the Coast Artillery Corps by maintaining its standards and traditions, by disseminating professional knowledge, by inspiring greater effort towards the improvement of materiel and methods of training, and by fostering mutual understanding, respect and cooperation among all arms, branches and components of the Regular Army, National Guard, Organized Reserve and Reserve Officers’ Training Corps.”*



## OFFICERS

### *President*

MAJOR GENERAL JOHN W. GULICK

### *Vice-President*

BRIGADIER GENERAL JOSEPH P. TRACY

### *Secretary-Treasurer*

MAJOR STEWART S. GIFFIN,

### *Additional Members of the Executive Council*

BRIGADIER GENERAL HOWARD S. BORDEN,  
COLONEL CHARLES C. DAWES,  
COLONEL BOWMAN ELDER,

LIEUTENANT COLONEL J. A. GREEN,  
LIEUTENANT COLONEL JAMES S. ERVIN,  
CAPTAIN JOHN H. WILSON



## MEMBERSHIP

“The Association shall consist of Active, Associate, and Honorary Members.

“The following shall be eligible for Active membership:

- a. Commissioned officers, active or retired, of the Coast Artillery of the Army of the United States.
- b. Commissioned officers, active or retired, of the Staff Corps and Departments of the Army of the United States who at any time have served in the Coast Artillery.
- c. Commissioned officers, active and retired, of the Philippine Scouts who have served in the Coast Artillery.
- d. Former commissioned officers of Coast Artillery of honorable records in the Army of the United States.
- e. General officers, active or retired, of the Army of the United States.

The following shall be eligible for Associate membership:

- a. Commissioned officers and former commissioned officers in good standing of the United States Army, Navy, Marine Corps, Coast Guard and Public Health Service.
- b. Warrant officers and non-commissioned officers of the Coast Artillery of the Army of the United States.
- c. Members of the Coast Artillery Units of the Reserve Officers’ Training Corps and Citizens’ Military Training Camps.

The following shall be eligible for Honorary membership:

- a. Civilians who have demonstrated their interest in national military preparedness.
- b. Persons who have rendered distinguished services to the Association or to the United States.”



LT. W. J. Oylward-  
A.E.F. '18

Memorial Day  
1918 - 1931



# Coast Artillery Gunnery and Training with Special Reference to Methods and Materiel

Brigadier General R. E. Callan, U. S. A.

IT IS an old artillery saying that no matter how much it is worked over and drilled at, the gun never learns anything. The only hope for delivering efficient fire lies in the training of the personnel, and there are limits placed by the materiel beyond which no training can increase the efficiency of fire. What methods then, will enable the Coast Artilleryman to obtain the maximum results possible with his materiel?

The question set needs explanation. It does not mean: What methods will enable a highly trained regular battery under the most favorable conditions of a peace time target practice, with every possible aid in the way of good visibility, simple course of target, and all possible assistance in the matter of observation of fire, to obtain a fine gunnery record? The question has in mind methods that will best produce good results in war, under all manner of unfavorable conditions, including particularly the fact that the vast majority of both officers and men drawn from their civil pursuits will have had only a short and intensive training before being called into action.

The foregoing should point clearly to the necessity of having simple but sound methods of gunnery that can be imparted by the regular force, acting as instructors, in the minimum time. Such methods should not be hasty improvisations; simplicity of method generally is the result of thorough study and careful experiment. Therefore, instead of considering gunnery training from the standpoint of further refinement of our methods, I shall confine myself in this paper to some observations on methods which I consider have direct application to the preparation of the citizen Coast Artilleryman for war service.

Before taking up the question of training methods, there is another responsibility which must be met by the regular—the readiness of the materiel for service. The present strength of the Coast Artillery is too small to accomplish this for all batteries in existence, without becoming merely a glorified caretaking outfit; to do the latter would let the art of seacoast gunnery disappear in our army. Therefore a careful survey of the batteries vitally needed should be made, and the others should be doped up and put in class B. All Class A batteries, whether manned by regulars or not, should be kept ready for service. This should include the following:—

- (a) They should be calibrated.
- (b) Their ammunition should be complete in rounds and under constant surveillance, receiving at regular periods ballistic firings for pressure and velocity.
- (c) The fire control communications should be kept in order.

(d) The fire control apparatus should be complete and open for inspection. Only batteries fulfilling the above conditions can be promptly served in action. Experienced artillerymen will say that this is a large order; it is, but it is a preparedness measure that should not be overlooked.

The next thing of importance is the preparation of a clearly and simply written set of instructions which should be kept in each Class A battery and which would cover its proper upkeep. This is no small task in itself, but in unmanned batteries it is necessary to insure against damage of the armament through ignorance or carelessness, as well as against some frightful accident. Such an *aide memoire* should be prepared; the present emplacement book should be combed for pertinent data. Those who serve for years with a certain battery know the worries that a particular gun may cause at target practice. Should not a new outfit about to serve a battery in action have their attention specifically called to any peculiarities of the armament together with simple remedial action to be taken?

At this stage we approach the broad question of gunnery training, and I will divide it into 3 classes from the standpoint of what may be expected in the way of observation of fire:

(a) Those batteries which can expect very little in this respect and whose rate of fire and quick changes of target may prevent any more than the roughest methods of fire adjustment. Naturally I put the 6-inch and 155 mm. guns in this class.

(b) Our medium range guns and mortars, the great majority of our seacoast armament, which can and do get from fair to excellent spotting from their terrestrial observing stations, and which may get some aerial spotting.

(c) The long range batteries from the barbette 12-inch guns on up. These have to depend primarily on the air service for their long range firing data as well as for spotting.

Taking up the first class, (a) I feel that their method of fire adjustment should be based primarily on sensing of salvos. Magnitude of deviations are too much to expect in war for guns of this type; therefore their peace time practices had better approximate service conditions. It is natural to seek all possible data on the result of fire as well as to obtain maximum accuracy of practice but it does not lead to the preparation of a sound method of war firing. Radical as it may seem, I would cast out many of the spotting gadgets used with guns of this type in the fire for effect. Having given the target, I think

a prompt and careful salvo adjustment should take place; then let this be followed by a burst of fire that would receive only such adjustment as sensing of the salvos would demand. The subdivisions of mixed shorts and overs and brackets could all be considered as brackets. I believe such procedure would be more efficient in the long run for it is doubtful if the present refinement in spotting data would be possible in action. Just as years ago we introduced into our mortar practices the practical problem of extending the fire into at least two zones, so do I now believe that one of the annual battery practices of 6-inch, 155 mm. or smaller caliber guns should have at least one shift of target in it. This will bring home a number of matters that bear on war firing efficiency, not the least of which will be a call for self-contained position finders. Our fixed gun methods have led us into too great a dependence on horizontal bases with their wire complications in the case of our mobile 155 mm. guns. Some years ago I had experiments conducted along these lines in a 155 mm. gun outfit, but their hearts were in their long base lines and only the shortcomings of the self-contained base instruments were accentuated.

The second class, (b), is naturally sub-divided into

- (1) Mortars.
- (2) Guns.

Considering first the mortars, it is evident to those of long Coast Artillery experience that preparation for war firing requires two pits to be manned. One has only to see the difficulties that a battery, used to firing but one pit, experiences when additional personnel is furnished for firing two pits. Wherever it can possibly be done our mortar batteries should fire simultaneous salvos of four from two pits. This is war firing; it has distinct advantages. The center of impact of an individual salvo is practically free from accidental errors. After a few salvos everything is compensated for except changes in the correction of the moment which are in turn discovered by the displacement of the center of impact from the target. Complete data on the correction of the moment will rarely be known; the variations in air conditions for different maximum ordinates will often keep this a variable. Therefore reasonably slow mortar salvos that are kept in adjustment by careful observation of centers of impact will in the long run be most effective; and with the small probable error that the mortars have and the deck as their target, one well placed salvo may have a most destructive effect. It is futile to look for some method of zone to zone correction; the analysis of the problem should show this—therefore let it be frankly acknowledged that there is or at least may be, a new problem of adjustment whenever the zone is changed. This means inviting a slow fire of at least the first two salvos on entering a new zone. Our method of data computation for mortars is sound and I am sorry to say I see no hope of further simplifying it.

Now for our mid-range guns; they can expect good spotting from the terrestrial stations and at times they, as well as the mortars, can expect help from the air service; in other words, they will rarely be

dependent entirely on their ballistic methods. The basic method of these guns should be Case III. Any Case II method used should be a particular case of Case III. It is strange how often this is not true; I have seen gun batteries prepared for Case II firing in such a way that they could not have fired Case III, except as an entirely different method. Years ago the War Department tried to correct this, but it did not wholly succeed. In the matter of determining gun data some foreign artilleries naturally lean to tables and calculations; we naturally lean to graphical methods. Articles in American magazines, and even advertisements show a knowledge of this national characteristic. I favor it as far as possible in our gunnery methods and we do use it a great deal. Were I in a position to write the order, I would insist that in every medium range gun plotting room there be kept separately a time-range graph and a time-azimuth graph; each in two parts, one showing the rather smoothly flowing curves of these relations as determined, and the other parallel to it showing the introduced adjustment corrections. From the latter would be sent the data to the guns. Such graphs record the story of the fire control section's work; when marked with the intervals of time there is no confusion possible as to what was sent at any time. If the adjustment corrections get confused, a glance enables the range officer to see his origin of coordinates; he can start over again, if necessary, at any moment. Furthermore, these graphs enable the flow of data to carry on even if disturbances take place at either base end stations or at the plotting board, and at any rate, they constitute two excellent fly wheels that are almost fool-proof.

There is much that can be said of the adjustment of fire; in the articles, "Adjustment of Fire" published in the COAST ARTILLERY JOURNAL of May, 1924, and "Methods of Fire Adjustment" published in the September, 1924, number, I have rather fully stated my views on this subject. In the practical application of the principles of fire adjustment the whole question becomes much simplified when salvo firing is used; this after all is the war method, and therefore need be the only one taught to our citizen soldiers in both peace and war. With salvo firing, even of but two cannon, there would have to be taught and practiced only one method of adjustment of fire—the salvo center of impact method.

In the training of our citizen soldiers the preparation of target practice records should be greatly simplified. This task now faces them at the end of their target practices and therefore of their camps. The work thrown on their officers and instructors in preparing these reports is very trying. It is an excellent thing for the regular to differentiate his target practice errors in peace time practice. It is of no use to him in war time, and practically so for the citizen soldier who is, or should be, preparing only for war time firing. The latter is very much concerned with the result of his practice; this should be carefully determined. He wants full information as to his hits, but rarely has much concern for the several probable errors so meticulously arrived at by analysis

of the records when so much is to be done after the practice in the way of breaking camp and taking up the civil duties neglected during the preceding two weeks. The labor involved is not only distasteful, but to my mind of little value.

The long range gun problem, perhaps the most interesting of all, is, I understand, to be treated in a separate article. More thought and practice than has been devoted to it in the past twelve years is justified by its importance. Such practices using airplane data only can be fired whenever air service is available; excellent training can be had with 6-inch and 155 mm. guns. I hope much experience with this kind of firing will be obtained in the next few years, for after all there should always be enough regular troops to man the long range batteries.

I would make some observations on the annual cycle of training of the regular Coast Artillery. First and foremost, there is nothing more pernicious in a training cycle than having some outside exercises injected into it that disrupt the logical series of artillery training events. If combined or joint exercises are to take place the period for them should be foreseen. The availability of troops of other arms and Naval forces may fix that period. That is all right, but that period should be the origin from which a set-back time can be arranged for beginning the Coast Artillery training year, regardless of that deemed necessary for other troops. Then individual instruction, gunners' training, battery training, target practices, artillery tactical training and inspections, and where held, battle practices, can all be finished up before the combined or joint exercises take place. Any other method introduces opportunism into a training year with unsatisfactory results.

The fire control sections should be kept prepared throughout the year; this I consider fundamental. How often have we seen the culmination of the artillery training year mean the culmination of the training of fire control sections. They drop their team work as a football team does in college, and going to other activities the whole thing must be built again at a later period. No other activity should stop the maintenance of the team work of the fire control sections. Even in winter the plotting board and other instruments can be brought to the barracks and canned data used to keep the team operating at a high efficiency; understudies can be trained to take the place of those going out or who are going to other duty. The very heart of Coast Artillery efficiency is the efficiency at all times of the fire control sections.

The greatest step forward we ever made in training the fire control sections was the introduction of checking the work in the plotting room. Whether targets are available or canned observations are used, the firing data can be worked out for a half dozen salvos; then a most careful scrutiny should be undertaken in searching for errors made by any individual of the team. This is the way to find out that the B' arm setter is unreliable; don't wait to explain it after target practice. Replace him if you cannot train him out of his inaccuracy. A battery commander whose confidence in his fire control section is justified by

daily tests and check-ups starts any shoot with some of his load lightened.

We certainly can improve our so-called gunners' instruction. Too much reliance is placed on the catechism method of instruction. Answers are learned parrot fashion; the garbled words used often show the meaning of either question or answer is not understood. So many of our officers can and do make excellent instructors in schools and colleges. Why can they not be stimulated to make more of gunners' instruction than they do? We preach the applicatory method; everybody can roll the words in his mouth, but how few can make that fundamental part of artillery training keenly interesting to those in their first year of service. As a side line in proper gunner training, there is an excellent opportunity for sizing up the intelligence of the new men. The normal set question and answer method is boring to everybody. Personally I do not think it worth one tenth the time that is spent on it.

It may sound strange from the one who started in target practice analysis the separation of the resultant probable error of a shoot into its component probable errors of personnel and materiel to complain now of an excess of analysis in our present target practice reports, but I must confess that the reaction in my recent commands is that too much time has to be spent on this work. Is not some simplification of this work now in order? I really think it is coming; for the great value of salvo firing and an appreciation of it as the basic war method will concentrate our attention more and more on the center of impact of the salvo rather than on an attempt to get all the data on the individual shots. There is some application in this of the old adage of missing the forest by gazing at the trees.

Our battle practices are very much crippled by the attempt to get so many records on the individual shots. Doing away with this would allow much finer demonstration to be made of the tactical mobility of the fire we are able to deliver. As a demonstration our battle practices are rather slow affairs in the eyes of our superiors and officers from other branches who witness them; and, possibly in our own eyes too. I favor a several years' trial of these battle practices being all they can be. Let time to change targets and records of centers of impact be the criteria of their effectiveness. No slowing down in the fire other than that required by safety of shipping in the harbor should then result; rather would there be shown to all the magnificent bursts of fire and the shifting from target to target of which our defenses are capable.

The foregoing are some of the things which come to my mind as being worthy of thought in our Coast Artillery training. The subject is too broad for more than a sketchy treatment in an article of this nature. I should be glad if it would provoke some contentious articles, particularly on the part of our younger field officers; for after all, inside of ten years, the Corps will be in their hands for guidance. They have had more opportunities in the way of experience and schooling than any similar body of our officers have ever had. What do they think of these things?

# Coast Artillery Training at West Point

By Captain E. W. Timberlake, C. A. C.

**I**N all problems involving the use of Coast Artillery in conjunction with other arms, it is quite proper to estimate the situation, taking into consideration the mission to be accomplished, the obstacles to be overcome, and the facilities available for overcoming said obstacles before arriving at a decision. Consequently, in the problem at hand, wherein Coast Artillery training is coordinate with training in each of the other branches of the service at West Point under the Department of Tactics, the above procedure will be employed, hence:—

*I. Mission:* To quote the Annual Report of Major General William R. Smith, Superintendent, United States Military Academy, "The mission of the Military

States Military Academy has always been tacitly accepted as the policy of the powers that be at West Point, particularly as a literal interpretation of the War Department's statement of the Military Academy's mission, *i. e.*, "To bring its graduates into the corps of officers properly equipped to enter upon the duties of the lowest grade of the arm in which they may be assigned," implying as it does the necessity of each graduate being technically equipped at West Point to enter upon the duties of a second lieutenant of each of the several branches of the military service, which is impossible of accomplishment under conditions existent at West Point.

From the beginning, the Military Academy has by

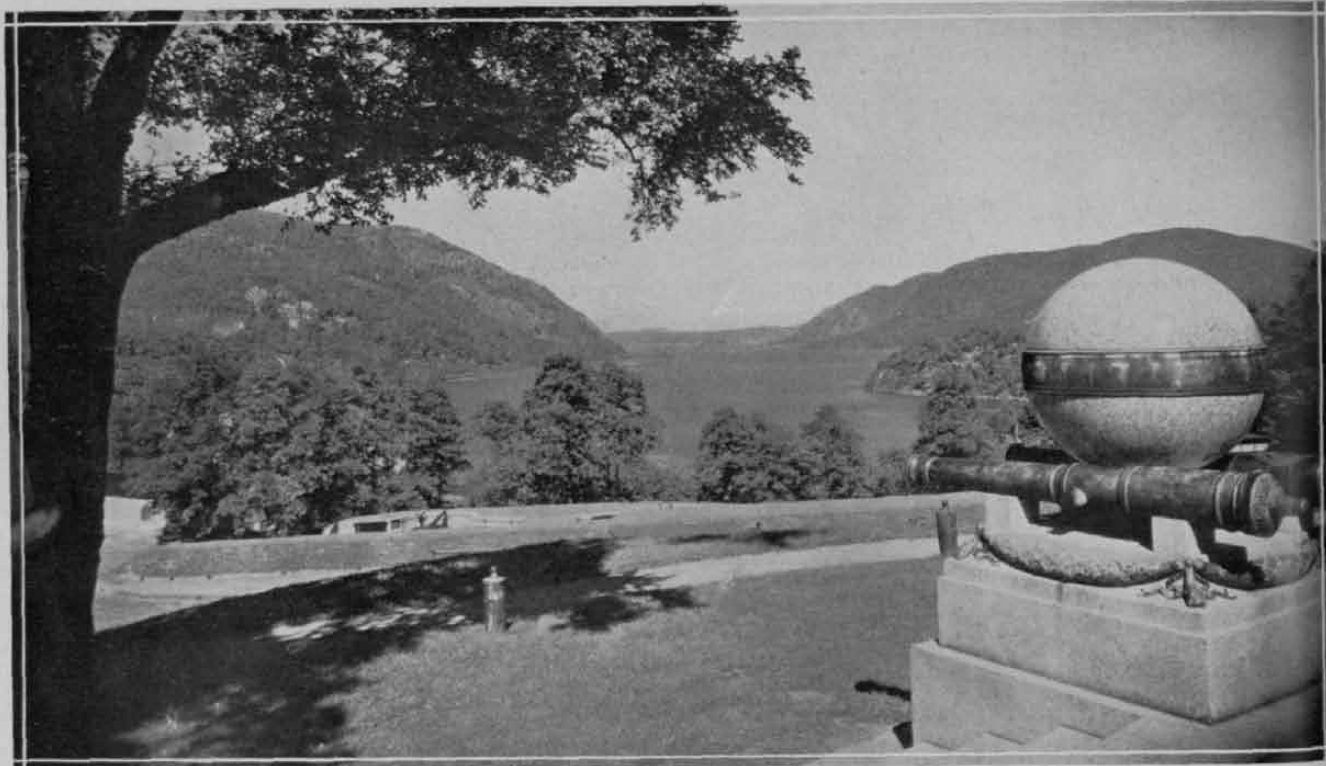

VIEW UP THE HUDSON FROM TROPHY POINT.

Just Down the Slope is the Principal Area of Coast Artillery Activities at West Point.

Academy is to train a cadet to think clearly and logically and to do so habitually; to teach him discipline and the basic principles applicable to the various arms in the military service; to develop his physique and, above all, his character; and to teach him to approach all of his problems with an attitude of intellectual honesty, to be sensible of the rights of others, to be inspired by a high sense of duty and honor, and unhesitatingly to lay down his life in the service of his country should the occasion arise.<sup>77</sup>

The above statement of the mission of the United

no means offered a purely military education; on the contrary, it is an institution at which a measurably complete academic education along broad scientific and cultural lines is very properly given by far the greater time and weight, and one at which character building is emphasized, and a foundation for discipline laid, fitting the cadets not merely to be second lieutenants but to become representative army officers, carrying the ideals of West Point into the Army and ultimately occupying positions of importance and high rank. Hence, the academic education and character building

processes cannot be too complete and thorough, and so much of the military education that is calculated to produce letter perfect platoon commanders is of secondary importance. Therefore, it may be properly said that the mission of the Coast Artillery at West Point is to present to the embryo officer the true picture of the Coast Artillery service, its mission, its use, and the conditions under which it lives and has its being; teaching him thoroughly the basic principles of Coast Artillery technique, and the employment powers and limitations of heavy artillery, either as a background of its use with the combined arms later in his career, or as a foundation upon which to build in case of assignment to the Coast Artillery. This foundation, in the latter case, to enable him with proper instruction and experience after graduation quickly to perfect himself as a second lieutenant of Coast Artillery.

## II. Enemy: (Obstacles).

### a. Situation:

Although the cadet lives a military life, almost semi-monastic in its simplicity, and is at all times subject to the most rigid discipline, he constantly realizes that the Damoclean sword of deficiency in academics is forever hovering over his devoted head; that his success or failure at West Point depends primarily upon his academic rating. Even in his "make", or rank as a cadet officer or non-commissioned officer, 20% of his rating is dependent upon class standing; and, upon graduation, his priority of choice of branch is according to his final academic standing. Thus, his major objective is academic, rather than military, the latter being of secondary importance and taken in stride. It is true that from June to September he is free of academic worries, and his life is completely military and social; nevertheless the time available for instruction by the seven disciples of Mars is limited, for during the months of June, July and August, military instruction is given only in the morning hours, the afternoons being free; whereas, from September until June, the day from reveille until 3:00 p. m. is purely academic, with but few exceptions. Hence it can be readily seen that unless all military instruction is carefully planned, thoroughly predigested, and appetizingly offered, the point of saturation is quickly reached in the thoroughness with which cadets can absorb the very considerable amount of highly diversified military information put before them. Consequently, the question of time is of preeminent importance and is jealously guarded by the Commandant of Cadets, inasmuch as training of the Infantry, Cavalry, Field Artillery, Coast Artillery, Engineer Corps, Signal Corps and Air Corps is coordinate under his command, and the natural tendency of each of the various branches is to increase its place in the sun at the expense of the already heavily academically burdened cadet.

### b. Time.

The total of approximately 460 hours now specifically allotted to basic training in all arms, as compared to approximately 2500 hours devoted to purely academic subjects, shows at a glance the relative importance of military and academic instruction at West Point. The

comparison becomes even more marked when we consider the weight of 186 given to theoretical and applied training of the combined arms to that of 2634 given to purely academic instruction for the final graduation standing.

It may be interesting to note in this connection that the academic course at West Point is equivalent both in double semester hours and in subject matter to that required for a B. A. or B. S. degree at Yale, Harvard, Princeton, M. I. T., Dartmouth and Wisconsin, and credit is so given by the above institutions to graduates of the Military Academy, individual graduates having obtained M. E. or M. S. degrees upon attending one year courses at the schools mentioned.

### c. Terrain:

The area devoted to Coast Artillery training at West Point is confined to the immediate vicinity of Trophy Point, fronting on the Hudson River looking toward Newburgh. Due to the great amount of shipping, and the comparatively minor water area, no firing of any kind is done on the Hudson River, and because

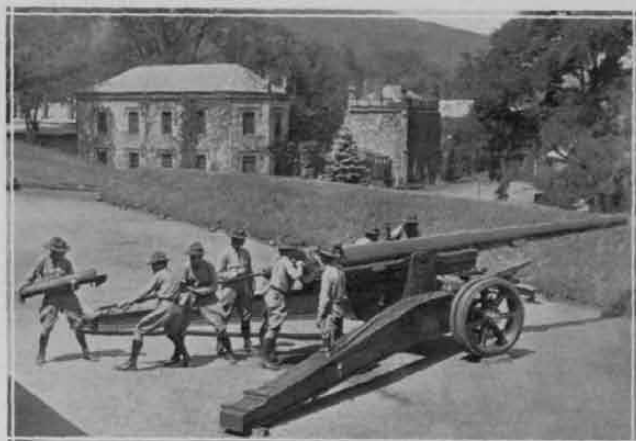

"Home Ram" at West Point.

of the thickly settled nature of the country in the environs of West Point and the opening of the Storm King Highway through the reservation, no land firing can be conducted. Consequently all Coast Artillery instruction at West Point is confined to instruction in nomenclature and functioning of material, theoretical gunnery, and tactics.

### d. Mental attitude:

There is another factor peculiar to the cadet in respect to his "show me" attitude toward all things pertaining to Coast Artillery.

This attitude of quasi-derision has been instilled in the Corps of Cadets by custom dating back to the separation of the Coast and Field Artillery in 1906. The consequent advancement of those officers who went into the Coast Artillery over classmates and others, at that time, with its attendant remarks of a disparaging nature toward the Coast Artillery, was immediately reflected in the attitude of the Corps, with the result that the average cadet knowing absolutely nothing at all about the various branches, grasped this apparently

sophisticated viewpoint as his stock in trade, and with a few re-furnishings, he comes subconsciously to believe that the Coast is a purely technical branch, not a virile part of the mobile army, addicted to stay at home, highly prolific domestic duties, to the exclusion of all military virtues. This ghost of the past, constantly met by the instructor, while easily dissipated by a clean-cut statement of facts, nevertheless lingers



The Coast Artillery Detachment of Enlisted Men is a Wide-awake Outfit.

on in the minds of the Corps of Cadets, and of necessity must be frequently re-laid.

### III. Own Troop: (Facilities).

#### a. Personnel:

The U. S. M. A. Detachment of Coast Artillery was formed at West Point July 1, 1920, under authority of an Act of Congress and its authorized strength at present includes one Major, commanding the detachment, one Master Sergeant, 1 First Sergeant, 1 Staff Sergeant, 5 Sergeants, 2 Corporals, 15 Privates, 1st Class, and 5 Privates. Previous to 1920 all training in heavy artillery was conducted by artillery officers designated by the Commandant of Cadets, and enlisted men detailed from the light artillery battery stationed at West Point.

In addition to the above, the company tactical officers of the Coast Artillery assigned to the Commandant of Cadets are available as permanent instructors. From six to eight Coast Artillery officers on duty with the various academic departments are available after 3:00 p. m. when so directed.

#### b. Materiel:

The seacoast equipment available for instruction consists of Battery Byrne, a two-gun pit of 12" mortars, model of 1890; Battery Schofield, a two-gun battery of 6" disappearing guns, model of 1905; one 60" seacoast searchlight with 25 k. w. power unit, and base and stations containing necessary fire control equipment.

The tractor drawn equipment consists of two 155 mm. G.P.F. guns, tractors, and necessary fire control equipment.

The antiaircraft equipment on hand (one model 1918 3" A.A. gun on 1917 trailer mount; 2 altimeters, model 1917; one antiaircraft data computer, model 1917, (R.A. correction); one wind and parallax com-

puter, model 1917); is a relic of the infancy of anti-aircraft development, and sorely handicaps the instruction in this arm at the present time. Pictures, both still and moving of the modern armament must be resorted to. However, it is certain that the following equipment will be available by 1931: Two 3" A.A. M3 guns on mobile mounts M3; two, prime movers for antiaircraft guns; one instrument trailer mounting a director M.I.A.I. together with transmission system therefor; one sound locator MVI; one antiaircraft mobile searchlight unit MVI with comparator MVI; one caliber 50 A.A.M.G. and A.A. tripod MI; and one truck for towing instrument trailer. This equipment is adequate to demonstrate modern antiaircraft materiel and to familiarize cadets with its technical operation as well as tactical use. With these facilities available, antiaircraft training at West Point should come into its own and if possible, during the summer encampment of 1931 instruction in short road marches, and the selection and occupation of positions will be given. This instruction will be primarily for First Classmen. It is contemplated devoting a period of three days and two nights in camp at some point other than at West Point, proper.

#### c. Morale factors:

(1) The inherent interest that each cadet has in big guns is augmented by the fact that the Coast Artillery embodies the most recent developments of all the sciences tending to mechanize the army. This interest is further augmented by the diversified character of the Coast Artillery service, forming, as it does, a most important part of the National Defense and operating against enemies on the land, in the heavens above, on the surface of the oceans and even in their depths.

(2) The growing importance of antiaircraft gunnery, nourished and developed by the Coast Artil-



THE 6-INCH, D. C., TRAINING BATTERY.  
This Battery is Never Fired But is Fully Equipped for Drill Purposes.

lery, is not lost on the cadet; and the basic necessity of all officers in all arms having an adequate knowledge of the principles of antiaircraft gunnery in order that they may take the weapons of the arm to which assigned upon graduation and obtain the best results with them, as indicated in the War Department's training directive for the current year, gives

the Coast Artillery instruction an unique attraction for every type of cadet.

(3) Finally, the fact that the Coast Artillery has fully 30 percent of its officers continually on foreign service, the ideal quarters and geographical location of Coast Artillery posts, and the fact that a cadet's initial glimpse of the army is during his senior year on a visit to Fort Monroe, attract the interest of the



Cadets Receiving Instruction on Coast Artillery Materiel.

average man to such an extent that the branch has of late drawn its quota from the first third of the graduating class. This means that men of general all around ability, endowed with adequate horse sense, are entering the Coast Artillery every year.

#### IV. Decision:

In view of the foregoing and bearing in mind the expansion of military technique of the various services in recent years, and at the same time taking due consideration of the requirements of others upon the already limited time of the cadet, the commandment of cadets through the senior instructor of Coast Artillery tactics has directed Coast Artillery training along the following channels:

a. Creating a background for a sympathetic understanding of the Coast Artillery in the cadet mind.

b. Presenting to the cadet a simple fundamental conception of the powers and limitations of fixed artillery, heavy tractor artillery, railway artillery, anti-aircraft artillery, and the basic principles concerning the gunnery of each.

c. Stimulating interest in the recent developments of artillery materiel by procuring up to date equipment and fixing the theoretical instruction in gunnery in the mind of the cadet by actual operation and firing of the materiel.

d. Presenting the intangible elements of Coast Artillery by lectures, and breaking the monotony of classroom instruction with moving pictures of various applications of the principles taught.

The actual plan of instruction, based upon the above, in operation at the present time, does not become effective until the cadet has completed his first year, and has fitted himself as comfortably as his physical and mental characteristics permit, into the iron mold that is West Point. There is no Coast Artillery instruction given the plebe, or first year man, as he is fully occupied with maintaining a military bearing, adjusting himself to his new mode of living, and in weather-

ing the academic storm. During the summer of his yearling (second) year, however, he is introduced to the anti-aircraft, seacoast and tractor drawn artillery, together with their respective fire control systems. This summer course of five days is devoted to creating a background in Coast Artillery lore and presenting the cadet with a tangible foundation for the highly theoretical classroom course in gunnery (T.R. 435-280) which is to follow.

This yearling summer course gives the cadet the look and feel and name of the materiel of which he has, almost without exception, only the remotest knowledge and is conceded to be of inestimable value, preceding as it does the theoretical course in gunnery.

At the beginning of the academic year, about September 1, the yearling dives into the subtleties of T. R. 435-280 and covers the essential parts of the text in ten classroom periods of one hour and twenty minutes each. Unfortunately, the above text is not particularly clear to the beginner in gunnery, and alternating as it does with yearling mathematics, it has been deemed advisable to supersede this text in 1931 by a digest of its most important items in easily assimilated form—it being held that the mathematics of yearling year is sufficient unto itself, without added gunnery complications.

Upon the conclusion of this classroom course in theoretical gunnery, about October 1, there follows another outdoor course in the operation and functioning of materiel. The cadets personally operate the various guns and instruments with special emphasis on aiming and laying, and the operation of the various position finding devices. In each case an endeavor is made to present the entire picture, from the procurement of firing data at its source, through its development in the plotting room to its ultimate setting on the various guns. The enlisted personnel of the Coast Artillery detachment are of inestimable value



The Cadets Get a "Kick" in Firing the AA Machine Guns at Monroe.

in the presentation of the above picture, for they are trained to quadruplicate in brass, performing in detail all the duties of fire control and gun sections for the varied materiel. These men first perform "slow motion," explaining as they go, following with some actions at normal speed, and finally turning over their posts to cadets for emulation. Particular interest is

evidenced by cadets in the various labor, time and brain saving devices for solving graphically the various problems of triangulation involving logarithms, trigonometric formulae, etc., that they have labored over so long in the Department of Mathematics, and now find solved in a matter of a few seconds. This course in October concludes the instruction of the Third Class in Coast Artillery and the cadet receives no more instruction in this branch until the late spring of his second (junior) class year when an eight-hour course of illustrated lectures, alternating with classroom recitations, is conducted in antiaircraft gunnery, followed by a ten-hour outdoor refresher course in sea-coast gunnery which is utilized in preparation for the service practices at Fort Monroe the following June.

About June 15, the First (senior) Class is taken to Fort Monroe and then assigned to three posts on the Virginia peninsula, one third of the class being assigned to each of the posts Fort Monroe, Langley Field, and Fort Eustis, for tactical training and target practice in Coast Artillery, Air Corps and Field Artillery, respectively. Five working days are spent by each third of the class at each post before returning to West Point.

Upon arrival at Fort Monroe the cadet gets his first view of the army, and it is here that he first sees the Coast Artillery as it really is. The actual operation of the big guns furnishes a thrill not to be found on Flirtation Walk, or at any place else in the whole wide work. "Home Ram" is on every pair of lips and the sons of the long gray line learn that there is a certain virility, snap and follow through in the

work of the Coast Artilleryman that is not such an obvious requirement in some of the other arms, and which is the direct antithesis of his conception of the "Coast with" and its attendant baby carriage motifs, accumulated at West Point from his predecessors.

At Fort Monroe the two years' training at West Point in theoretical gunnery is put into practice. Each third undergoing instruction is divided in half, one part being assigned to 8" Railway guns, the others to A.A. guns, machine guns and searchlights. The first four mornings are devoted to drill and sub-caliber practice with cadets filling practically every position in the battery from battery commander to powder monkey. On the afternoon of the fourth day, target practice is fired with invariably excellent results.

For the 1930 season, June 15 to July 2, at Fort Monroe, the following results were obtained in cadet practice:

*8" Railway Battery*

1st Battalion—8 record shots at 11,000 yards—4 hits.  
2nd Battalion—8 record shots at 11,000 yards—3 hits.  
3rd Battalion—8 record shots at 11,000 yards—6 hits.

*3" Antiaircraft Battery*

1st Battalion—40 shots—6—7000 foot altitude—8 hits.  
2nd Battalion—45 shots—6—7000 foot altitude—13 hits.  
3rd Battalion—44 shots—6—7000 foot altitude—15 hits.

The proof of the pudding is in the consumption thereof. The above results speak for themselves. The cadet comes to the Coast Artillery classes at West Point prepared to scoff—and remains to learn how to shoot, if not to pray.

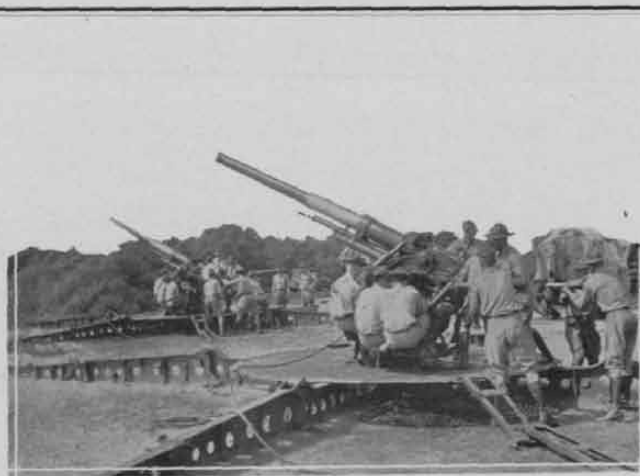

Cadets of the First Class in Training at Fort Monroe.

# The Mechanized Force

## Its Organization and Present Equipment

*Captain Arthur Wilson, Field Artillery*

THE Mechanized Force, officered and manned by personnel from all arms of the service, assembled at Fort Eustis, Virginia, is in the midst of an intensive training program. At a time of the year when many organizations are not taking part in extended maneuvers, this force is participating each week in tactical exercises that take it over most of the Virginia Peninsula. A single problem extends as far as 75 miles for the entire force, with the reconnaissance vehicles covering well over 200 miles a day. Night marches and maneuvers, with all vehicles moving without lights, have also been part of the schedule.

The concentration of the force was completed in November, 1930, with the exception of the signal platoon which arrived the first week in March and the quartermaster repair unit which arrives in June. While the Mechanized Force is a new unit, it is by no means composed of new organizations. It has, therefore, been possible to launch immediately into a training program which not only carries on individual and company training, but also includes the work of coordination between units and the development of the tactical missions of the force as a whole.

Before we go into the internal organization and equipment of the Force let us define the word "mechanization." In order to avoid confusion of thought the War Department has seen fit to define and to differentiate between mechanization and motorization.

*Mechanization* is "the application of mechanics directly to the combat soldier on the battlefield."

*Motorization* is "the substitution of the motor-propelled vehicle for animal-drawn in the supply echelons of all branches of the Army, and in providing increased strategical mobility for units of all types through the carrying of men, animals and equipment in motor vehicles over roads."

To reflect in the organization of the Army the mechanical age in which we live, to take advantage of the outstanding leadership of this country among the nations of the world in the automotive industry, and to exploit to the fullest extent possible the mechanical and scientific field of the nation in the interests of national defense, the Mechanized Force was constituted. It is not only a self-sustaining unit designed to fulfill a particular and necessary role in the organization of the Army, but is a field laboratory to develop tactics for such a force and to test mechanical vehicles and weapons suitable to its use. The War Department has

determined that the United States, the leader in motor vehicle manufacture, will not continue to be the last in the application of this great asset to the national defense.

"A new element foreseen as a development in the armies of the future is the mechanized force," wrote General Summerall in his final report to the Secretary of War; and as one of his last official acts as Chief of Staff he ordered the organization of such a force.

To carry out its mission and its tactical rôle<sup>2</sup> the force is organized with means for administration and command, for ground reconnaissance, and for defense against air attack; and is provided with an attack unit, a holding unit, and supporting units. It consists of a force headquarters and staff, and ten organizations, which are a headquarters company, an armored car troop, an antiaircraft detachment, a tank company, a machine gun company, a chemical detachment, a field artillery battery, an engineer company, an ordnance company, and a quartermaster motor repair section.

*Force Headquarters.* It is at once apparent that there must be developed for the force a technique of command and communications different from anything that has heretofore been accomplished. There must be evolved the internal tactics of the force itself, as well as the tactics of the force acting as a unit and in cooperation with other organizations. There are also many questions of equipment, supply, and maintenance that must be worked out in this experimental field laboratory for mechanization.

The headquarters consists of the commanding officer and a staff of an executive, an adjutant, an assistant adjutant (personnel), a plans and training officer, an assistant plans and training and liaison officer, a supply officer, an assistant supply officer, an intelligence officer, an ordnance officer, and a commanding officer of special troops. This last named officer is a major and has administrative command of the headquarters company, antiaircraft detachment, chemical detachment, ordnance company, and quartermaster repair section. He also commands the field trains. The commanding officers of the chemical and signal detachments also act as chemical and signal staff officers.

*Headquarters Company.* The headquarters company is organized into an administrative section, a supply platoon, and a communications platoon.

*Armored Car Troop.* The ground reconnaissance element is provided for in the armored car troop from the 2d Cavalry Division. With this unit ground reconnaissance can be pushed far beyond anything that has ever been accomplished on foot or on horse.

<sup>1</sup>This article was written in March and revised in April. Consequently some minor changes might have occurred by the time it appears in the JOURNAL.

<sup>2</sup>The mission and tactical role will be discussed in a later article.

The cars are built for rapid movement; and because of the large number of automatic weapons and their armor, they have a high degree of fighting power. The troop is organized into a headquarters, consisting of an armored Franklin radio car, a five-passenger Ford touring car for cross-country, a solo motorcycle, and four platoons. The first platoon consists of two light cars, a Chevrolet and a Plymouth; the second has three light cars, all Whippets; the third, two medium LaSalle cars; and the fourth three medium, so-called, Franklin cars. All cars except the Franklins are built on commercial chassis and have the engine corresponding to their make.

The light cars are entirely protected with 1/16-inch armor, except the turret which is 1/4-inch armor. In each turret is mounted one caliber .30 Browning tank machine gun, air-cooled.

The medium cars all carry a crew of four men, and are completely armored with 1/4-inch armor. The La Salles each carry one caliber .30 Browning tank machine gun. The Franklins carry one caliber .50 machine gun which can fire at a rate of 400 rounds per minute, and two caliber .30 Browning machine guns, capable of firing from 500 to 600 rounds per minute. The light cars are capable of a speed of 50 and the medium cars of 70 miles per hour.

In addition to the machine guns each car carries a Thompson sub-machine gun, and all members of the troop are armed with the automatic pistol.

*Antiaircraft Detachment.* The force is a vulnerable target from the air when on the march, at a halt, or in

bivouac; to protect its fighting as well as its non-fighting vehicles for front line transportation, an antiaircraft detachment is provided. It is organized to give a close, powerful, emergency defense against aircraft. It is equipped with two single-gun antiaircraft mounts with caliber .30 Browning water-cooled machine guns, carried in two-ton F. W. D. trucks, and with one multiple machine gun mount (carrying two caliber .50 Browning machine guns) on a commercial White chassis. The mount has all-around traverse and can be elevated to 87 degrees. It is equipped with a stereoscopic sight. Though the guns can fire 7500 yards, the effective tracer range is considered as 1200 yards.

The crew consists of a driver, an assistant driver, a gunner, two assistant gunners, and two observers. The gunner elevates and traverses with his hands, and fires the guns with his feet. One assistant gunner on either side watches a gun, sees that it works correctly, and attends to the ammunition supply. The two observers are used to watch for targets. When on the march the two assistant gunners are also used as observers, and the four are seated so as to give all around observation. To protect the gunner from the gas and smoke a special shield is provided above the guns.

The detachment consists of one officer and nineteen men from the 69th Coast Artillery at Aberdeen Proving Ground.

*Tank Company.* The tanks are offensively the backbone of the force, the unit around which it is built.

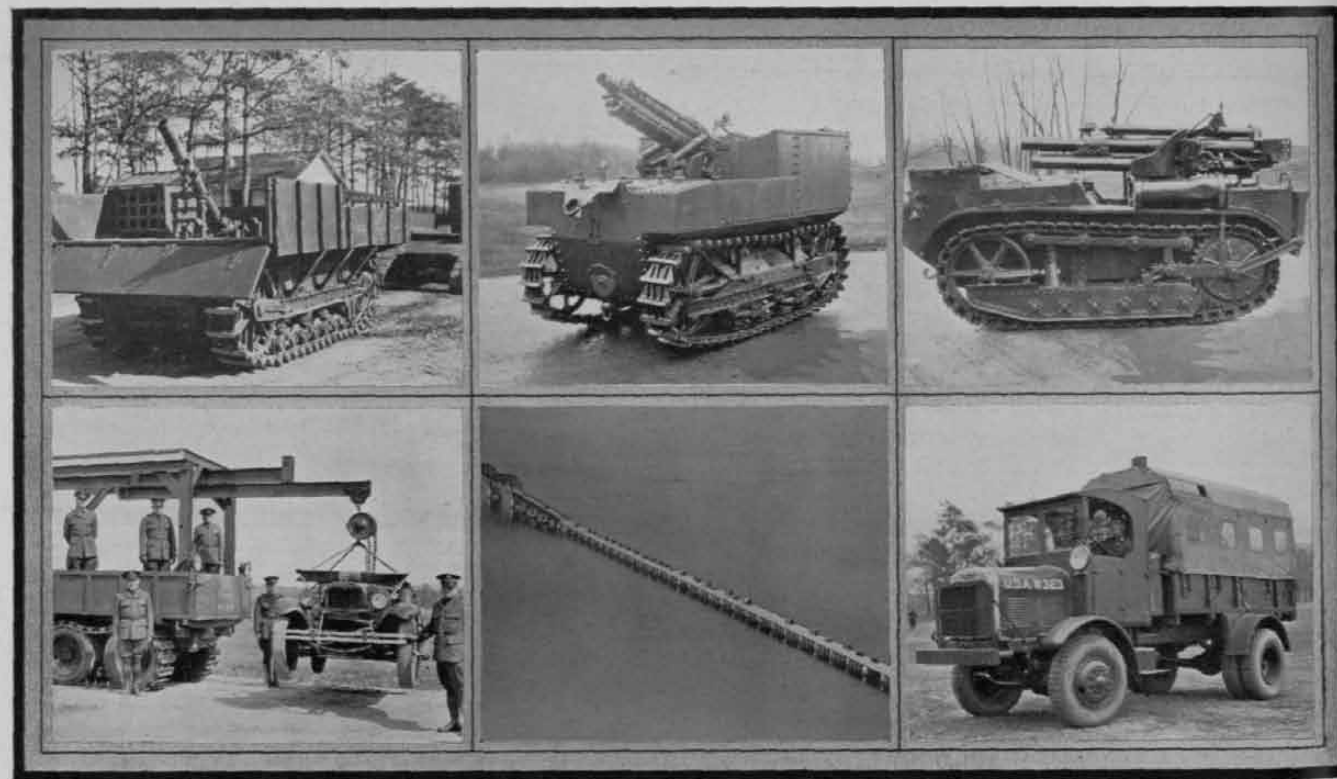

Top Row Left to Right—The 4.2-inch Chemical Mortar on a T1E1 Chassis; 75-mm. Pack Howitzer Motor Carriage, T1; American 75-mm. Gun on Mark VII Self-propelled Mount.

Bottom Row Left to Right—Diamond-T Wrecking Truck Lifting a Cross-Country Wire Cart; The Mechanized Force Crossing the James River Bridge; Two-Ton FWD Truck with Liberty Kitchen.

This company comes from the 1st Tank Regiment at Camp Meade, and consists of five officers and 88 men.

It is equipped with 22 tanks, two of which are radio and command tanks (one a TIE2 and one a Model 1917 with Franklin motor), three are light tanks Model TIE1, six are 6-ton tanks Model 1917 which have been remodeled and equipped with Franklin motors, and eleven are 6-ton tanks Model 1917.

The light tank TIE1 has three speeds forward and one reverse; it can travel 3.18 miles per hour in first, 14.5 in second, and 21.9 miles per hour in third. It is engined with a Cunningham V-8 motor.

The Model 1917 tanks, redesigned and modified to take a Franklin engine, have a maximum speed of nine miles per hour. They each carry one caliber .30 Browning tank machine gun, air-cooled, or one 37-mm. gun. The TIE1 tanks are each equipped with one caliber .30 Browning machine gun and one 37-mm. gun. For each caliber .30 machine gun 4200 rounds of ammunition are carried, and for each 37-mm. gun 238 rounds. One of the TIE1 tanks is equipped with a semi-automatic 37-mm. gun.

To get the necessary amount of speed on the march and before going into battle area the tanks are transported on tank carriers, six-wheeled trucks developed in the Service and built at Camp Holabird. The company is equipped with ten carriers with solid tires and two carriers of a later model equipped with pneumatic tires for the command tanks. At present not all the tanks are carried when on tactical exercises, due to lack of carriers.

The tank carriers are engined with six-cylinder Continental motors and are capable of a speed of 33 miles per hour.

The tank company is organized into three platoons of three tanks each. The additional tanks may be used later to organize another platoon, and for mobile battle command posts for unit commanders of the force. They will always be used for training.

*Machine Gun Company.* The machine gun company of three officers and 70 men was sent from the 34th Infantry (motorized) at Fort Eustis. It is organized into three platoons of three guns each, or a total of nine caliber .30 Browning machine guns, with three more in reserve. All of the guns are carried on six-wheeled cross-country  $\frac{3}{4}$ -ton Chevrolet trucks, one gun and a crew of six men, a driver, an assistant driver, and a squad leader on each truck. The crew for the gun is four men, the other two being riflemen for protection of the guns. All individuals carry caliber .45 automatic pistols. Five trucks, not used to carry guns, are for baggage, ammunition, and the three reserve machine guns. In addition to the trucks the company has three cross-country Chevrolet passenger cars, and will soon have for test two-wheeled machine gun carriers and two wheel-and-truck machine gun carriers. The guns are mounted on the trucks facing to the rear for fire from the vehicles, and when detrucked run on rubber tired carriages pulled by hand.

*Chemical Detachment.* Smoke is one of the most valuable agents in the assistance of tank attacks and in

the screening of the enemy's antitank weapons during the withdrawal of tanks from action. The chemical detachment is provided with a 4.2-inch rifled chemical mortar which can fire high explosive shell as well as smoke or chemical shell. It has a range of 2500 yards. The mortar is mounted on a self-propelled TIE1 cargo chassis, the same chassis as the TIE1 tank. A tank carrier is provided to give it road mobility consistent with that of the force. The detachment of one officer and fifteen men was sent from Chemical School at Edgewood Arsenal.

*Field Artillery Battery.* In addition to units which will provide ground reconnaissance, striking power, and holding power, the force has its own supporting fire units. To get the comparative value of self-propelled and portée artillery for the missions that artillery will have to have with the force, the battery is equipped with a variety of guns and experimental materiel. It has a complete portée battery of French 75-mm. guns with caissons, battery reel, and Caterpillar "20" tractors, self-propelled American 75-mm. guns mounted on Mark VII chassis, one self-propelled 75-mm. pack howitzer mounted on an ordnance track development chassis, an experimental motor reel mounted on a TIE1 chassis, one ammunition carrier on TIE1 chassis, and a Fort Sill trailer for 75-mm. gun.

The howitzer is the new pack 75-mm. howitzer mounted on a motor carriage TI, which is the track development chassis designed by the Ordnance Department in 1929. It has maximum speed of 21.3 miles per hour.

The battery has a strength of five officers and 127 enlisted men, and is Battery A of the 6th Field Artillery from Fort Hoyle.

*Engineer Company.* For the inevitable field engineering duties that come up in every organization, the force has Company C of the 13th Engineers from Fort Humphreys, with a strength of three officers and 90 men. It is organized into a headquarters and three platoons. Basic engineer platoon equipment is furnished for each platoon, and in addition the company carries special bridging and other material. Its motor equipment consists of seven 2-ton FWD trucks, a Mackmobile crane and power truck, a kitchen truck, a Ford cross-country car, a motorcycle, and a  $\frac{3}{4}$ -ton GMC truck.

*Ordnance Company.* Aside from the purely supply work of the force, which is taken care of by the supply platoon of the headquarters company, the maintenance, repair and salvage of broken down and damaged motor vehicles and materiel of all kinds is a complicated one and involves many technical and mechanical problems. The vehicle of the fighting force must be kept moving or its efficiency is seriously affected.

*Quartermaster Repair Unit.* The quartermaster mobile repair shop, one officer and 15 men, comes from the Quartermaster Intermediate Depot at Camp Holabird. Like the ordnance unit, it will be specially trained and equipped to take care of wrecked and damaged vehicles, and to provide for upkeep and maintenance of motor vehicles.

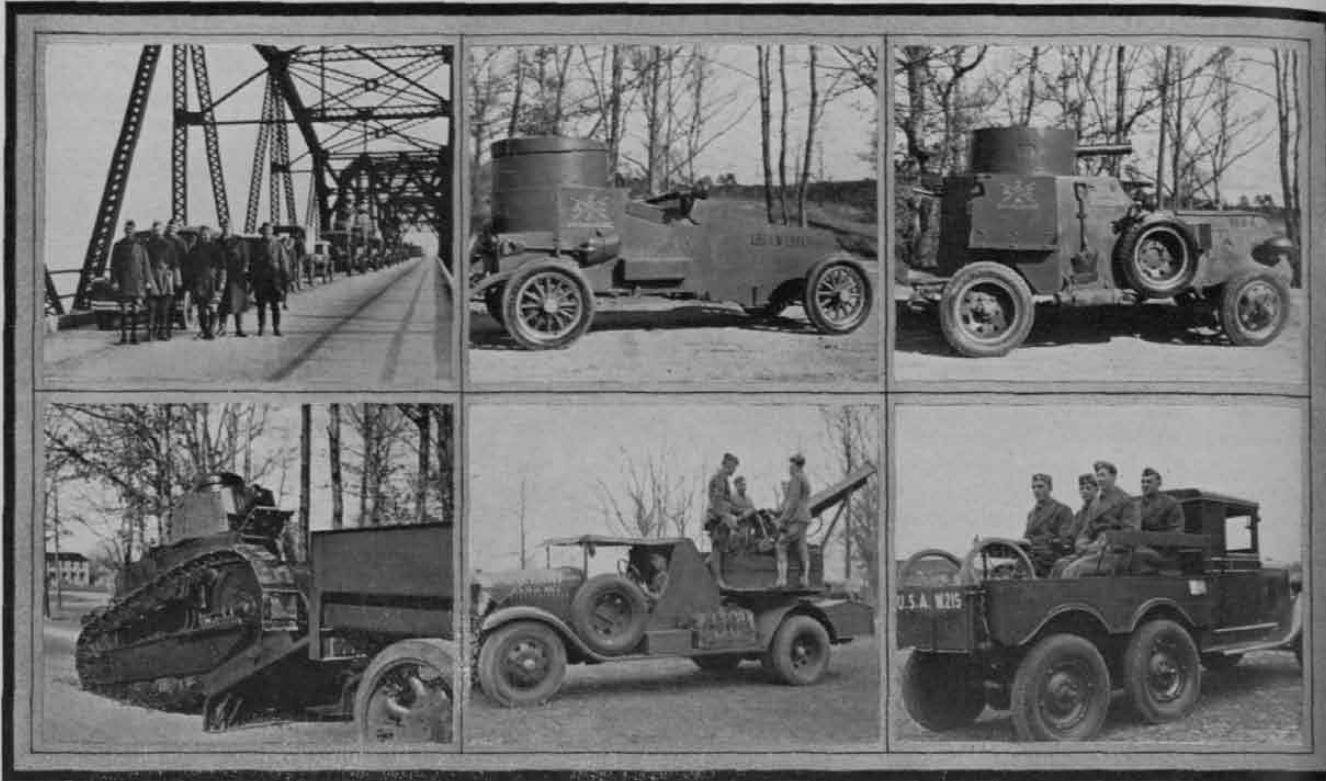

Top Row Left to Right—Mechanized Force Crossing James River Bridge, January 27, 1931; Light Armored Car Equipped with one Caliber-.30 Air-cooled Browning M. G. Weight 4142 Pounds; Franklin Medium Armored Car, Equipped with one Caliber-.50 and two Caliber-.30 Browning Air-cooled M. G.'s. Weight, 7138 Pounds.

Bottom Row Left to Right—Tank, 6-ton, Model 1917, Being Loaded on Carrier; White Multiple-mount Equipped with two Caliber-.50 AA Browning M. G.'s; Browning M. G. and Crew in Chevrolet Cross-country Truck.

*Equipment in General.* Because the force has to operate as an experimental field laboratory for the testing and developing of vehicles and weapons suitable to its use and will be progressively supplied with motor and mechanized equipment, it has, of necessity, a great variety of types of vehicles. This makes the problem of maintenance and of spare parts a difficult one, but much valuable information for the guidance of future design and manufacture will be obtained from the field tests and close scrutiny of the records. Much of the motor equipment has come direct to the force from factory or proving ground. All of the passenger cars, motorcycles, 2-ton and 5-ton FWD trucks, pneumatic-tired tank carriers, field artillery carriers, TIE1 tanks, motor reel, ammunition carrier, Fort Sill carrier, TIE2 radio tanks, kitchen trucks,

generator trucks, Franklin 1½-ton trucks, radio trucks, wrecking trucks, chemical motor mortar, and pack howitzer are new. Much of the equipment has been used only slightly, and some of it is old. The old equipment will be replaced as soon as possible with new designs.

The Franklin 1½-ton trucks are on the same chassis and have the same engine as the medium armored car and the radio armored car. The 2-ton FWD trucks have class A bodies and dual tires on the rear. The kitchens are mounted on these trucks by taking the body from a Liberty kitchen and installing a burner for gasoline. It will also burn wood or coal and is equipped with two 20-gallon water tanks and compartments to carry kitchen utensils and rations.

On May 18, 1931, the Chief of Staff of the Army released a statement of which the following extracts are pertinent to Captain Wilson's article.—Editor.

• • •

The missions of the cavalry arm now, as in the past, include the following:

- Long distance strategic reconnaissance.
- Fighting for the control of the theater of reconnaissance.
- Seizing points of strategic and tactical importance.
- Tactical reconnaissance.
- Pursuit of the enemy, or delay of his advance.
- As an exploitation force to take advantage of any break or weakened point in a hostile battle line. In

this type of operation, the cavalry may act alone or in conjunction with other arms.

As part of a reserve to be used tactically or strategically. It is not difficult to visualize a reserve of the future, moving out in column from head to rear—Cavalry (mechanized), units of the Tank Corps, Infantry temporarily embussed, all elements being able to move at a uniform speed without noise. Field artillery must be prepared to support such a force with units especially organized and equipped to accompany it.

To enable the cavalry to develop its organization and equipment so as to maintain its ability under modern conditions to perform the missions enumerated, the following program is announced:

The Mechanized Force will be reorganized as a reinforced cavalry regiment, in which appropriate equipment of the present Mechanized Force will be absorbed. To provide for future development of the proper supporting arms for use with mechanized cavalry units perhaps larger than a regiment, the artillery and maintenance units will remain attached for the present.

As far as necessary, officers and enlisted men of any arm or corps may be attached to the regiment in order that the best thought upon this subject may be brought to the Cavalry. Changes in enlisted personnel will be made gradually so as to accomplish both the retention of the experience gained in the Mechanized Force and the reconstitution of detached units in their parent organizations.

The cavalry will undergo such general reorganization and re-equipment as will enable it best to perform the missions enumerated above. This may require at least two types of cavalry regiments. One (horsed) in which the horse and mule may remain only where they cannot be replaced by the motor for the performance of difficult tactical missions, or for operations in difficult terrain where the horse and mule still give us the best mobility. A second type of cavalry (mechanized) in which the horse and mule shall have disappeared entirely.

The infantry mission is to close with the enemy, and its ability and power to accomplish this makes infantry the decisive arm. Its success is a prerequisite to army success; consequently, its efforts must not be dispersed in the performance of auxiliary and supporting missions that can be carried out by other arms.

In time of peace the infantry will be trained in close proximity with other arms, in order to develop the team work and mutual understanding so necessary to insure the accomplishment of the infantry mission.

As one of the principal duties of the tank will be to support infantry, it should be trained with it to develop the most efficient type of machines and most applicable methods of tank support for infantry units. But the tank itself may never become a piece of equipment assigned to an infantry regiment. In war, tank organizations may be assigned to corps and army troops to be employed where opportunity offers, including opportunities of terrain.

In the development of tanks, and tank organizations, it must be remembered that certain important considerations apply to the employment of tank units in war. Among these are:

Tanks will be difficult to procure in large numbers, particularly in the early stages of any war.

Opportunities for their best employment on the battle front must be carefully selected, both as to time and as to place. They are assault weapons only, to be used for relatively short periods of time, under favorable opportunities.

Maintenance will offer many difficulties, particularly in the areas of front line divisions.

All these considerations indicate the desirability for visualizing tank units in war as Corps, Army, and G. H. Q. troops. In the development of the tank, due regard must be paid to the necessity for strategic mobility, even though its fundamental qualification must be tactical mobility.

The "tank" is properly the term that will be used when this vehicle is employed with infantry. When it is employed as a part of the equipment of cavalry, it may be developed to possess characteristics particularly requisite for such service, and it might then be given the name 'combat car.'



Battery E, 69th C. A. (AA) at Fort McClellan.

# Individual Tracer Control for Antiaircraft Machine Gun Fire

Capt. D. M. Griggs, C. A. C.

QUITE a bit has been said and done in recent years in the field of antiaircraft machine gunnery. We hear, on one side, the advocates of the use of sights to the exclusion of everything else. On another side there are those who would discard sights entirely and place sole reliance in tracer control by the individual gunner. There are still others who would use a combination of both sights and tracer control.

Without entering into an extensive argument with the proponents of other systems of fire control for machine gun fire, this article will cover the method of tracer control by the individual gunner. An effort will be made to set forth its comparative advantages and disadvantages, the system of training in this method as actually used by Battery "E," 69th C. A. (AA), the results obtained by use of this method in two annual target practices, and the results of this method as compared with other methods during the antiaircraft exercises at Aberdeen Proving Ground.

The normal target for machine guns during hostilities will be a fast low-flying, hedge-hopping, highly maneuvering plane. The objective of peace time training should be an effective defense against the attack of such hostile aircraft. Any training or target practice which has for its aim the procurement of hits on a fixed course with prepared data falls far short of this objective.

Practically all machine gun sights are dependent on certain basic data, such as speed of plane, angle of approach, altitude. These data change so rapidly that their accurate determination by the usual means for use on the sight is impossible. The only alternative is estimation by the individual gunner, unless there are available some means of electrical or mechanical transmission of data with director control, and this will be most unlikely. There is no time for computation and transmission of data or corrections by voice or signal, as the chances are that the plane will present itself as a target for only 15 or 20 seconds. Even though it were under fire for a longer period, data would be obsolete by the time they could be transmitted to the gunner and applied by him to the sight, due to the rapidly changing conditions and maneuvers of the plane. Tracers are practically valueless for adjustment purposes where a gunner is using sights, unless a director or some means of central tracer control with an electrical or mechanical data transmission system to the sights is used. It is not probable that such a set-up for use with sights in time of hostilities would be available, nor would such a set-up be practicable except in a more or less stabilized defense, and even then the tac-

tical disposition and employment of the guns would most likely preclude its use. It is an impossible task for a gunner to keep a gun sight of any description aligned on a maneuvering, fast-moving target and at the same time observe the path of the tracers. If he is watching the tracers he is not sighting on the target, and if he is sighting on the target he cannot see the tracers, unless they happen to pass through his line of sight. Besides keeping his sights aligned on the target, the gunner must continually estimate data and make corresponding changes in his method of sighting for changes in angle of approach, altitude, speed of plane, etc., all of which still further precludes the possibility of observing tracers and making adjustments. The .50 caliber gun is the normal weapon for antiaircraft machine gun units and with this gun it is much more difficult to keep a sight of any description aligned on a target than it is with the .30 caliber gun. At times it is impossible altogether. This gun has a terrific vibration, which together with the blast and smoke, make it an extremely hard matter to follow a target with sights.

Many of these difficulties and disadvantages of sights are overcome in the employment of tracer control by the individual gunner. On opening fire with this method of control the gunner concentrates on the stream of tracers at the target and continuously adjusts the fire of his gun so as to keep this stream of tracers on the target. He can quickly detect any maneuvers of the target and adjust his fire accordingly. The vibration, smoke, and blast of the gun are not so serious as when sights are used. During the 1930 antiaircraft exercises at Aberdeen Proving Ground comparative tests were held as to the time it required a gunner, using different methods of fire control, to pick up and open fire on a target after the command "Commence Firing" had been given. In each case the gunner, when using individual tracer control was able to open fire sooner than when using sights. The errors in the use of sights, that must result from the application of estimated and rapidly changing data, disappear to a large extent, when using tracer control, for in this system no fire control data are needed, once fire is opened. Errors that are disclosed to the gunner by deviations in the stream of tracers are immediately adjusted. Once a gunner is on the target, the problem of fire control for machine guns is exceedingly simple, for regardless of the course or maneuvers of the target the gunner, if properly trained, can follow it with his piece in both direction and elevation. As can be deduced from the foregoing, training for individual tracer control is highly important, as it is only through the most pains-

taking and intensive methods, coupled with a natural aptitude on the part of the individual, that a man can be made a successful gunner. It is not contended that training of gunners in the use of the sight should be eliminated altogether. This training gives him a further understanding of the fundamental principles of gunnery in antiaircraft machine gun fire and of how these principles are applied in the use of sights. With inexperienced gunners sights may be used to get initial leads on the target for opening fire. As soon as

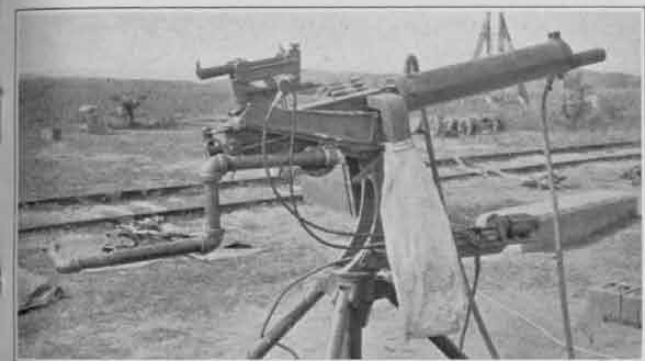

Cal. .50 Antiaircraft M. G. with Back Rest Installed

the first tracers reach the range of the target the use of the sight should be discontinued and adjustment made by tracer control. An experienced gunner can estimate his initial deflections so closely that the use of a sight for opening fire is unnecessary.

Battery E, was a new battery, composed of men from various harbor defenses and of recruits. As soon as organization of the battery was completed, theoretical instruction preparatory to gunners' examination was conducted. Gunners' examinations were held in March and 94 per cent of the organization qualified. Individual qualification of all men under the provisions of T. R. 435-211 was completed about the middle of June, 97 per cent of the battery qualifying. Special emphasis was laid on tracer control by the individual gunner in aerial firing at balloons. About twenty men who made the highest scores in the individual qualification course and in gunners' examination were selected for further training as gunners. On days when there were strong and favorable winds these men were trained in firing at fast-moving balloons at varying ranges. A careful record was kept for each man of the number of balloons shot down and the expenditure of ammunition in so doing. From the twenty men who took part in these firings, twelve who made the highest scores were selected for further training as gunners. A 1000-inch aerial overhead range was constructed which permitted of firing at both coming and crossing targets at varying angular speeds. Each of the twelve remaining men was carefully instructed in the principles and use of the forward area antiaircraft sight and was permitted to fire with this sight on courses at both coming and crossing targets on the aerial range. A total of about 600 rounds of ammunition for each man was expended for the purpose. The individual training of these twelve men was continued further by firing at

towed aerial targets, using tracer control by the individual gunner. Each man was allowed one standard sleeve target and was permitted to fire at this target on three crossing courses under target practice conditions. Upon completion of the three courses the target was dropped, the number of holes counted, and the percentage of hits determined. For the purpose of comparing scores, the conditions of flight in each of these individual practices were made as nearly identical as possible. From the scores made on the 1000-inch aerial range and those made on the towed sleeve target, all twelve men were classified in order of merit, the four men having the highest score were chosen as gunners of the first platoon and the next four in order of merit were chosen as gunners of the second platoon. Preliminary practices by platoons at towed aerial targets were begun about July 1 and each of these practices simulated record practice. Five preliminary practices were held by each platoon, three of them being day practices and two being night practices. The direction of flight for each practice was varied so as to give training under all conditions of approach. Each preliminary practice for a platoon was analyzed before the next practice by that platoon was fired, and the greatest attention was given to the elimination of any defects which affected improvement in the score. Every effort was made to place the materiel and ammunition in the best possible shape for target practice. As the ammunition furnished for the practices was an old lot and contained many corroded and split cases, each round was inspected by at least five different people. Driving springs from .50 caliber guns were cut down and used in the .30 caliber guns in order to speed up the rate of fire. An adjustable back rest was used to replace the shoulder stock normally provided with the mount.

Record target practices for the fiscal year 1930 were begun on July 24 and finished on July 25. Record

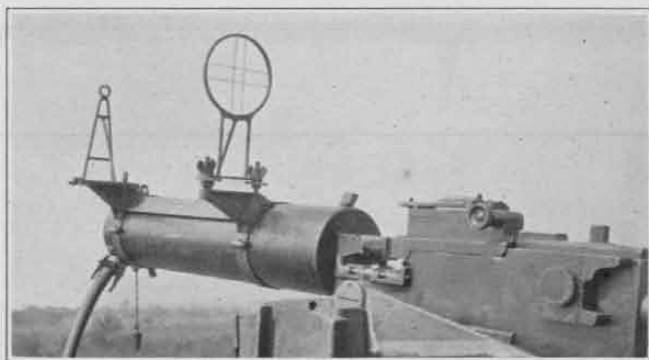

The Boyd-Greene Antiaircraft M. G. Sight

practices for the fiscal year 1931 were begun August 7 and completed on August 11. Record practices for both seasons were conducted under the provisions of T. R. 435-55, dated June 20, 1930. In order that a standard of excellence for record practices might be determined according to the scoring formula in the new T. R. 435-55, a fictitious set of ideal data was selected and a score computed from these data prior to the target practice season. The data chosen represented

that which might be expected under ideal conditions for .30 caliber guns and the ammunition provided. The resulting score represented a standard of excellence which was not expected to be attained but toward which the organization should strive. The data chosen were as follows for each course:

H—1200 ft., D—800 yards, R—700 yards.  
S—2000 rounds or 400 rounds per course.  
H—140 or 28 per course—7 percent.  
R—500, N—5, Sp.—100 m.p.h.

As the burn-out point of the tracer ammunition supplied was about 900 yards, an average range of greater than 800 yards was not expected. With the poor grade of ammunition supplied and no time out allowed for stoppages, a rate of fire of 500 rounds per gun per minute was considered excellent. From the records of other organizations a percentage of hits greater than 7 percent was rarely attained. The score as computed from the foregoing data is 22.06 per course, or 110.30 for the practice. The results obtained from each of the ten practices for the fiscal years 1930 and 1931 were as follows:

## F. Y. 1930

No. of Practice	Platoon Firing	No. of Rds.	Hits (Percent)	Rate of Fire	Slant Range	Speed of Plane	Score
1 - D	2nd	2184	5.70	476	888	113	109.81
2 - D	1st	2597	4.27	509	991	109	103.63
3 - D	1st	2431	1.97	525	969	113	68.81
4 - N	2nd	2513	3.36	540	1009	118	101.46
Average 1930	...	2532	3.70	519	975	114	95.67

## F. Y. 1931

No. of Practice	Platoon Firing	No. of Rds.	Hits (Percent)	Rate of Fire	Slant Range	Speed of Plane	Score
1 - D	2nd	2877	2.55	530	1014	92	79.34
2 - D	1st	3015	2.51	538	995	107	79.37
3 - N	2nd	2318	4.01	497	1085	125	124.94
4 - N	1st	2804	4.69	521	1072	132	129.58
5 - D	2nd	2812	2.18	535	970	95	67.09
5 - N	1st	2936	3.22	545	1019	118	94.64
Average 1931	...	2765	3.19	524	1027	110	96.06

Average score for the two years practices—95.86. The scores attained, as a whole, exceeded expectations. This was due primarily to the slant range, the average of which was greater than that expected, and was also greater in most cases than the burn-out point of the tracers. The fact that a good percentage of hits was obtained at average ranges greater than the burn-out point of the tracers reflects great credit on the gunners and shows that the state of training in tracer control was highly satisfactory, for tracer control by the individual gunner was used exclusively throughout the practice. There were no unusual methods used during the conduct of the practice. Altitudes were determined from altimeters, using the scale in feet instead of yards, and azimuths and angular heights were obtained from the usual angle measuring instruments. The plane executed such maneuvers as were consistent with safety throughout the series of practices.

With gunners who have been properly trained in tracer control there is no question that hits can be obtained on every course of the target which is within

range of the tracers. During the series of preliminary and record practices by Battery "E," 69th C. A. (AA), a total of about one hundred courses of varying ranges, altitudes, and approaches were flown and the target after being fired upon was dropped at the end of each course. Out of this number of trials, there was only one instance in which hits were not obtained on the sleeve, and the failure in this instance was due to the fact that the target was about 500 yards beyond tracer range and was fired upon for a very short time, about seven seconds.

During the Aberdeen anti-aircraft exercises of 1930, a test was held with .30 caliber guns to determine the relative effectiveness of fire control when using sights and when using tracers alone. Every effort was made



The Negrotto Anti-aircraft M. G. Sight

to have conditions the same throughout the test. The same gunners were used, they were well trained in the use of each system of fire control that was tested, and the courses, i. e., range, altitude, angle of approach, speed of plane, etc., were as nearly alike as possible. The entire test was conducted in the forenoon so that visibility and ballistic conditions would be the same throughout the test. The sights tested were the Boyd-Green anti-aircraft sight and the Negrotto anti-aircraft sight. When compared with tracer control the results were as follows:

Boyd-Green anti-aircraft sight . . . 2.51 percent.  
Negrotto anti-aircraft sight . . . 3.92 percent.  
Individual tracer control . . . . . 4.29 percent.

The Negrotto sight is intended to be used only for initial data, tracer control being resorted to after the opening burst, and it was so used during the test. In the case of the Boyd-Green sight, fire control was by the use of sights throughout the test. If the present interest in anti-aircraft machine gunnery continues and if the development of fire control apparatus and materiel continues to grow as it has in the past few years, it is probable that in the near future a machine gun sight will be perfected that is satisfactory under all conditions of fire and airplane flight for both .30 caliber and .50 caliber guns. However, it is not believed that such a state of perfection exists at the present time and from the facts brought out in this article, it is further believed that, for the moment, the most dependable system of fire control for machine guns is tracer control by the well trained individual gunner.

# Possibilities of the Tank

Colonel Fred H. Wagner, O. R. C., Technical Staff, Ordnance Department

*A tank enthusiast, Colonel Wagner returned from Europe with a number of convictions about tanks shattered.—EDITOR.*

IN THE autumn of 1928 I went abroad a perfect tank enthusiast, but came home with my enthusiasm considerably dampened. In the summer of 1928 I had spent two weeks with the Mechanized Force at Fort Meade, and from the conversation surrounding me there I was led to believe that the tank was the answer to a multitude of questions. With this fond belief I encountered my friends in Europe only, alas, to have my convictions considerably shattered.

I am not speaking of motorization, but of tanks and tanks only, which may be analyzed as the backbone of any mechanized force. But since I am unacquainted with the War Department's ideas on the intended use of this weapon I would request you to pardon what may be deemed presumptuousness in bringing to you the thoughts implanted within me during my almost five months stay abroad.

As I understand the subject, a mechanized force would be employed about as follows. Distant reconnaissance of the enemy would first be made with airplanes, after which ground reconnaissance would follow by means of fast-moving armored cars. The enemy being thus located, or his intentions ascertained, a possible attack by the mechanized force would follow. This attack would be launched by a first wave of light tanks, rapidly moving forward under possibly a smoke screen and closely supported by self-propelled artillery. This would be followed by the advance of heavy tanks in waves, followed by vehicles manned by machine gunners whose duty would be to mop up and consolidate the ground gained. This would mean running over of the enemy's position, after which advantage would be taken of the "break-through" by the arrival of infantry which, besides the rifle, would be equipped with preponderant machine gun and automatic rifle power, and whose duty would be to hold the ground until the arrival of the regular divisional infantry.

This picture is a pretty one, if it works to the same advantage during war or when the enemy has something to say about it as it does in maneuvers. But as a final analysis the entire action is based on the results obtained by the tanks.

It is not my intention to describe the tanks built, building, or being designed in Europe, but to confine my remarks to the questionable utility of the weapon, or questionable in so far that I do not deem it possible for the tank to give the results so confidently predicted by many enthusiasts.

In doing this I would call to your attention the following statistical information, which to me it is vital.

On November 20, 1917, at Cambrai, 476 British tanks, without any preliminary bombardment, in a

surprise attack rolled over the German Armies almost at will. This was the first actual meeting in the field of war; consequently it was something which had not been prepared for and, due to surprise, led to a very successful issue. Hence the tank was immediately hailed the panacea for the misfortunes of battle.

On November 21, however, or just 24 hours later, 23 British tanks entered Fontaine-Notre Dame and encountered severe resistance. The demoralized Germans of the day before no longer took to their heels nor stood petrified only to be shot down; they concentrated in the upper floors of the houses and rained grenades on the tanks. The mission of the tanks was a failure, and they were compelled to withdraw under cover of darkness.

On November 30, 1917, or ten days after the tanks had met with such phenomenal success in a surprise attack, the Germans in turn, and without any tanks at their disposal, surprise-attacked the British at Cambrai and drove them out of the positions which they had gained principally through the surprise occasioned by the tanks—a further proof that the heralded demoralization had evaporated. For countering this attack, the British, now on the defensive, had only 73 of their original 476 tanks to oppose the German tankless advance; and as soon as these 73 were confronted by direct gun fire they were compelled to withdraw from the fight.

On March 21, 1918, at Amiens, the British were in a strong position and had received warning of an impending attack. They were supported by 320 Mark IV and 50 Medium A (Whippet) tanks. In spite of the lack of German tanks, the British were driven back almost to the gates of Amiens. This does not lead to the belief that the Germans still feared the tanks, or that demoralization had been induced in them by the knowledge that the British had some 370 tanks in support.

The Second Battle of the Somme started six days late, on March 27, 1918. There all but three of the 5th Battalion tanks had to be destroyed by the British themselves on account of lack of fuel, and the three remaining ones were lost on the next day.

On July 18, 1918, Foch's Tenth and Eleventh Armies struck the Germans at Château Thierry and in the vicinity of Rheims. The French Tenth Army was covered by 324 light and heavy tanks, 225 of which succeeded in getting into the action, and they sustained 122, or almost 50 per cent, casualties. The German artillery alone accounted for 62 of these.

On the next day, July 19, the 3d Heavy Tank Battalion lost all but two tanks, one of the latter reaching its objective. Of a total of 105 tanks, 50 were hit

by direct shell fire. During the next few days 32 tanks were engaged in local attacks: 17 of them were hit, with a personnel loss of 52 per cent.

On July 21 we find 120 tanks engaged, of which 36 were hit. On July 23, 82 tanks were engaged, of which 48 were lost.

All of this happened during one of the greatest surprise attacks of the war, where conditions might be considered ideal for tank work. Here the new Renault tank, which possessed greater speed and was less conspicuous, thus presenting a lesser target than the older ones, obtained its first major service, but the tanks were all but totally put out of action. Ludendorff informs us that fire from the tanks was insignificant, while Hindenburg advises that the feeling of helplessness in the face of tanks had been greatly overcome. But artillery did the job.

On August 8, 1918, the Allies launched a surprise attack at Amiens. The British corps had 420 tanks, of which 415 got into action and 100 were destroyed. That evening the remaining tank crews were so completely exhausted that it became necessary to organize composite companies for the next day's battle. All of this occurred under ideal tank conditions. The total tank loss amounted to 25 per cent.

On August 9, in the main attack, 39 out of 145 tanks were hit by artillery, and on the same day in a minor engagement at Chipilly five out of 16 were destroyed. On August 10, 30 out of 67 tanks received direct hits, and at Roye-Hattencourt-Hallu 23 out of 43 were lost.

Summarizing this battle, we have 415 tanks going into action on the first day; on the second day this armada was reduced to 145, a loss of 65 per cent; and on the third day this number was again reduced to 67, or a further loss of 54 per cent. Colonel Fuller, who is an enthusiastic tank exponent, says, "A total of 688 tanks had been in action on August 8, 9, 10 and 11; 480 machines had been handed over to salvage; very few of the remaining machines were actually fit for a lengthy action, and all required a thorough overhaul."

Unfortunately for the Germans, but fortunately for the Allies, the former failed to equip their infantry groups with a number of large-caliber automatic rifles directly after the tank appeared. Had they done so the tank losses would have been far greater than those cited above.

From Livesay I quote, "Without question the tanks played a great and formidable part in this battle \* \* \* but that they were not vital to success was proved by the Canadian Corps later on, when its supply of tanks, at first scanty, rapidly was reduced to the vanishing point. \* \* \* Early tanks failed or achieved but a moiety of success because they were too slow and too vulnerable. \* \* \* In the Amiens show the tanks were massed and the wastage was so great that replacements on the same scale were difficult, especially as the widening of the battle line made an effective tank concentration more and more out of the question. In the Arras offensive very few tanks were in our (Canadian) line, and in the battle of Cambrai, because of the impassable nature of canals and rivers

encountered, they were almost entirely absent. Very few, in fact, were left at all in the closing stages of the great offensive, and a localized concentration to overcome machine gun resistance became impossible. Had it been otherwise our casualties would have been lighter."

Livesay is confident that tanks are ideal for destroying machine gun nests, but even here they must act in close concert with the other arms. He continues, "Above all they must have wider range of vision and be in direct communication not only with their own units but with other arms, especially infantry." He finally says, "In the last analysis it was the man with the machine gun, the man with the rifle, and the man with the bomb and bayonet that won our battles."

General Monash is another who feels that the tank can be looked upon only as a mechanical aid to an infantry advance, and that the tank can never replace the latter. Marshal Haig came to the same conclusion.

I shall not waste your time at present on tank design, but a few remarks are in order. Who can imagine a tank constructed to withstand the fire of guns? Unless the tank can make a surprise attack it would be impossible to even think of success.

The British tank enthusiasts all refer to the first Battle of Cambrai as convincing evidence of tank superiority and call attention to the great tactical value of the present day high-speed tank. You may increase the speed of the tank to the uttermost limit, but the shell from a gun is still swifter. Increase the tank's armor and she will be pitted against heavier guns; but it must be remembered that the tank is limited as far as weight is concerned, and increased weight does not mean only an addition to the motive power with its concomitants of fuel, oil, etc., in order to maintain the desired speed, but it will also cause the tank to be subject to tactical limitations, especially on marshy ground, or where the bearing power of the soil will not permit of its passage.

In other words, high speed means loss in armor or increase in engine power. The former may be well deemed fatal; if the armor is applied in such weight as to resist the caliber of guns which it might ordinarily meet in attacking strong points, then the tank becomes larger and more conspicuous and is thus made a better target for artillery fire. In Europe the desire for speed since the war has, with the exception of the French 130-ton tank, unfortunately led to a sacrifice in armor. Speed, however, will naturally be a matter of terrain, and it is unfortunate that we cannot always select for tank action terrain on which the limitations of the tank will permit it to operate as we may desire or intend.

During the war the tank was far too conspicuous for trench warfare, and because of this feature it often fell prey to artillery fire. For open warfare it was too slow, hence the present desire for speed. Consequently the only tank success must be credited to surprise. But, on the other hand, even this element of surprise would have been of little value had it not been supplemented and supported by excellent teamwork, or by the constant pressure of the other arms.

In my humble opinion, as well as in that of others probably more capable of forming such opinion, with the exception of Cambrai, where the initial success was reversed in a few days, the tank may be considered to have been somewhat of a failure. These are probably harsh words, and they may not meet with the approval of tank advocates, but from the losses cited above, or losses which would have required extraordinary efforts above what had been previously accomplished, this opinion is gaining strength in many quarters in Europe.

Surprise attacks by tanks, in my opinion, are greatly a matter of the past if the object lessons taught by the recent war are not pigeon-holed and forgotten, and it does not require much imagination to perceive that every future army commander will be on the alert for such surprises.

For example, in an advancing army, it is reasonable to believe that both land and air scouts will be well to the front, and the commander will certainly be subject to a lack of reasoning power if he fails to have sufficient mobile antitank guns in positions from which he can concentrate a resisting fire.

On the other hand, on the defensive the commander will certainly take pains to locate strong-points or antitank forts along his front. Common sense will teach him to take advantage of all natural obstacles, and his strong-points will be guarded by land mines of the mushroom variety which can be touched off from the strong-point as well as by contact.

Tanks may employ a smoke screen to conceal their advance; but smoke is at the same time a detriment to the tank, it is blinding, and the defending artillery will certainly search such a smoke screen.

A tank advancing against a strong-point will be the target for more than one gun, and these guns will be so located as to cover a much wider field of fire than is possible from the tank. You may attempt to answer this by sending out the tanks in waves or fleets which will cover a considerable sector of the front, thus dividing the fire from the defenders among several targets, but the reply to this is the actual casualties which occurred in tank fleets during the war and after the Germans had overcome their original fear of them. Had the Germans adopted their later tactics, at an earlier date, the results so far as the tanks are concerned would have been even more fatal. These efforts consisted in assigning several guns to the outpost line of each divisional sector for tank defense only, and they were so disposed that they could quickly take such position as would permit of engaging the advancing tanks by direct fire, and this at a range of 750 to 100 yards. What tank can resist a seventy-five gun at this range?

Let us imagine a defensive sector arranged about as follows: The outposts consist of strong-points. The main battle zone is considerably in rear of these outposts and consists of a zone of strong-points, inconspicuous because probably dug deeply into the ground, and armed with guns of comparatively large caliber in such fashion that the points can support each other by means of flanking fire. With the out-

posts intact, is there opportunity for a surprise attack on the main battle zone? Certainly not. What else is then left to the attacker but to search for and locate each strong-point in the zone and attempt to smother it with artillery fire? Even then, unless the barrel of a gun received a direct hit or the whole crew were killed, the survivors would quickly return to their guns after the artillery fire had lifted, and would then have the tank at a distinct disadvantage through point blank fire.

The establishment of such a defensive battle zone is not a chimera, as witness the last proposed phase of German tank defense measures. This was to consist of a number of antitank forts each armed with four field guns, two *minenwerfer* having a flat trajectory, and four antitank guns and two machine guns. These forts were to be about 3000 yards behind the guns at the outposts and close to the main defensive line. This idea came rather late, and was applied only once or twice, but never found action. Such forts with their equipment can be built much more quickly than can a tank, and one such fort could create sufficient havoc in a fleet of tanks as to make their replacement rather difficult.

You may say, why not rush the main battle zone, but I cannot imagine anything more suicidal than such an attempt. The attacking tanks would find themselves in a very inferno of shells, a deadening cross-fire at a range where missing the target would be exceptional, while the tank would be seeking a target for its fire.

The only other alternative would be an attempt to obliterate the battle zone strong-points by an overwhelming artillery fire. But here again the defending artillery will have something to say, and unless the attackers possess a preponderance of artillery the result will not be the expected one. If, however, the bombardment is a success then why the tank at all?

It must also be remembered here that the defense can provide supplies in greater abundance than the attack, and these additional supplies and ammunition might be the measure of success or failure. Were not the Allies in just such a predicament at the time of the Armistice?

Had the Germans contracted their front and established such a battle zone as described above, with the determination to fight on, would the Allies have been able to continue their advance? I quote from Maurice. "Everywhere I was told that the Allied armies, which were on or were marching towards the Meuse, had on November 11 reached or very nearly reached the farthest limit at which for the time being they could be kept regularly supplied, the plain fact being that on or very soon after November 11 it would, had hostilities been continued, have been necessary to call a halt between the Dutch frontier and the Meuse until the roads and railways behind them had been repaired. That is to say, it would have been necessary to give the enemy a breathing space, which would have allowed him to restore some sort of order in his ranks and make good his retreat to the Meuse, where he would have been able to establish himself in very

strong positions. This, of course, refers to the movement of vast supplies, but tanks operating as described above also are limited in their movements by the necessity of supplies, and it is questionable if these could be provided under the circumstances.

In a defense of this kind there are several prime considerations with which one must reckon. The gun is mounted in an entrenched position and is protected by the surrounding earthworks, while the tank must provide its own protection and at the same time maintain its mobility. The gun depends upon auxiliary services for its supply of ammunition, while the tank must carry its supply of ammunition, as well as fuel, oil, etc. The gun is practically immune to shell fire in its protected position when compared with the tank exposed in front and flanks to direct fire. The tank is mobile and may attempt to go forward with a rush and engage the fort at close range, but before she can accomplish this the tank must necessarily run the gauntlet of a heavy fire if the fort is armed as explained above, consequently a direct close range attack is problematical. If the fort is built of a shape which will not permit the tank to enfilade it, the tank will certainly be subjected to worse fire than she can offer in return. It also requires no long stretch of the imagination to see the fort built of such strength that the tank cannot crush it, and this will lead to a duel in which the tank will be the loser.

It has often been said that the next war will be one in which high speed will be paramount, and that it will be of short duration, but there is a very large school which deems this doubtful. The chances seem favorable that opposing armies will approach each other in a very cautious manner, guarding against surprise attacks, and the one will try to out-manuever the other in order to gain an initial advantage. Consequently a decisive victory will be obtained only through a superiority which is both overwhelming and decisive. This overwhelming superiority will not result from tanks alone, since the enemy will also have these at his disposal; and while the tanks may assist in obtaining the victory, it will probably be a consequence of some flank attack by tanks and for which the enemy has opened the way by leaving this flank exposed to a surprise attack.

There is quite a large school in Europe which insists that a tank attack on machine gun nests can be made effective if the tanks are accompanied and supported by a large number of machine gunners. The machine gunners might go forward while the tanks are directing their fire on the tanks; however, it is conceivable that the machine gun nests will be supported by infantry, in which case the advancing machine gunners can be picked off by rifle fire while the tanks are taking care of the tanks.

This condition has brought about another school of thought, or one which considers guns on one side and armor on the other. This school says that the victory will lie with the guns if they are three-pounders or heavier. As stated previously, it is difficult to provide the tank with heavier armor and maintain its speed and mobility, but a three-pounder on a self-propelled

unarmored mount will be far more mobile than the heavily armored tank.

Quoting Captain R. Hilton, of the British forces, "A force of mechanized antitank guns, working in conjunction with aircraft, could forestall advancing tanks, even more effectively than machine guns in lorries were able, in the Great War, to forestall advancing infantry." This means that it will be impossible for tanks to advance without the support of mechanized artillery. Hence the question is asked: Why, under these conditions, armor the tanks at all? The total abandonment of armor is not, however, contemplated, but it should be used only as an aid to fire-power. In other words, the three-pounders would be protected with shields which, as regards frontal fire, would be proof against bullets, splinters, and even long-range fire from three-pounders. It is advanced by this school that such a mobile weapon, in relation to the tank, would build up a much harder-striking army, because it would possess a far better range of vision, would possess greater hitting power, would be faster, more mobile, and more economical. One serious drawback is, however, recognized—exposure to rear and flank fire—but this is answered by accompanying mopping-up parties of infantry which would be transported in armored cross-country cars.

Such a proposal suggests an entirely different infantry for the future, or one in which fire-power is derived from three-pounder guns with ability to consolidate the ground.

Quoting further, "In defense \* \* \* the three-pounder guns would be unshipped and mounted in concealed positions \* \* \* the \* \* \* close-quarter parties would be sited in covered positions near at hand so as to protect the three-pounders from being run over. A proportion of this new model infantry would be kept in reserve on the hulls, ready to launch a counter-attack. The change from infantry fighting of the present day is only one of degree \* \* \* movements will take place at 10 or 20 miles per hour. The fire-swept zone will be broader and will be swept by projectiles of 1.5 inch caliber instead of .303 inch. Otherwise everything will be the same. Powerful artillery fire will be necessary to neutralize the defense and allow the new infantry to go forward. Intensive air fighting and counterbattery work will still be required to smash down the fire-power of the enemy artillery.

"The all-armor idea is founded upon a natural desire to avoid heavy casualties, to win battles without bloodshed. Unfortunately this cannot be done \* \* \*. In the warfare of the future, casualties in all arms will probably be very heavy \* \* \* the real difference from wars of the past will be that mechanization will allow all this fighting power to be intensified."

I only mention this to show that everything is not all right, even in the birthplace of tanks. It must also be remembered that enthusiasm as regards the effectiveness of the tank was not very high at its birthplace after the war, or after such statistics as I have cited were studied. The tank was conceived as

far back as 1907-8, but very little development followed because money was not available. Then came the War, and tank thoughts were revived, the experiments made at Aldershot in 1907-8 being recalled. The tank was built in 1915 and found its first use in the following year, but 1917 saw it fighting for its very existence; in 1918 it met with some success, but here we find thoughts as to its effectiveness being again on the decline. The enthusiasts were determined, however, not to permit it to die, hence it became necessary to gain the interest of the public and thus of the politicians; this was done through propaganda.

I quote Colonel Fuller, "The lethargy and opposition \* \* \* were hotly attacked by a small band of tank enthusiasts who saw quite clearly that, as the present age was a mechanical one, it followed of necessity that the army would have to be mechanized. There was no question that this end was assured; in fact the whole problem was to speed its advent, so that money might be saved, and what was more important still, casualties reduced during wartime. The difficulties which faced this small band of believers in mechanized warfare were great. First, they were confronted by a solid phalanx of hostile military tradition, and secondly, public opinion did not interest itself in the tank. To accomplish anything, public opinion had to be created, and it was considered that it could only be created by press propaganda. To attract the attention of editors, a spectacular machine had to be produced, and the result was that tank engineers set out to quadruple the speed of the old war tanks. This was the wisest step taken, for once a tank was built which moved at 20 miles the hour, its performances were mentioned in Parliament, and the press became interested. Further still, it was essential to show that even the old war tanks did effect enormous economies \* \* \*."

There we see the entire matter in Britain based on propaganda with a "spectacular tank" as its foundation. But will the spectacular tank with its high speed overcome the difficulties I have cited? I shall leave

this for others to decide. What design of tank shall we adopt with confidence that it is what we will require in time of war? From 1915 to 1918 Britain, with plenty of money and opportunity to try out in actual warfare, not in peace-time exercises, produced a tank which in our present light falls far short of what is required. You may answer that the experience gained during that period points to what is required today. But the war of the future is not today, and in the meantime other minds are engaged in solving the problem of defense against what we may consider the object sought by tank enthusiasts. At least I should not place much hope in a "spectacular machine."

In conclusion I shall assume a tank constructed so as to be proof against gun fire so far as its internal organism is concerned; but, unfortunately the tracks of the tank, without which she is immobile, are exposed to a stream of rifle fire, tracer bullets, or thermite shells, and the latter will no doubt be developed. It is not necessary to fire at a range which will occasion a miss; it is possible to wait until the tank is closer, and trained marksmen can then surely place the destructive shell where it will do the most harm, on the tank's tracks. And if this should be a thermite shell the mechanism at the point of impact would instantly become fused, and the tank, as far as mobility is concerned, would be helpless, since it would be converted into a very conspicuous fort which would soon draw hostile fire.

In all of this I do not wish to create the impression that the tank is valueless, but rather to point out that it possesses severe limitations which tank enthusiasts are prone to pass over. Let us design the proper tank and build what may be necessary, but at the same time solve the problem of what our opponent will do under the circumstances involved in a tank attack, remembering that in all cases final victory will remain on the side that has the greater mobility, the greater striking or fighting power, and the greater staying power, and that in the last analysis it takes the gun to beat the gun.



# The Gold Star Pilgrimage

Captain Lawrence C. Mitchell, Coast Artillery Corps

AS Memorial Day approaches and the second expedition of the Gold Star Mothers and Widows is under way, it seems appropriate to pause and give a few moments' thought to the great Pilgrimage to the cemeteries of Europe. This Pilgrimage was provided for by an Act of Congress approved March 2, 1929. To the Army of the United States was accorded the honor of administering the details of this magnificent mission.

Of our men who died overseas, 30,824 still lie in American cemeteries in Europe. They rest in eight plots of American soil near the fields where they gave up their lives—one near London, England; one at Flanders Field, Belgium; one overlooking Paris and the Bois de Boulogne; and the other five on American battlefields of France—Somme, Château Thierry, Marne Salient, Meuse-Argonne, and St. Mihiel. The Gold Star Pilgrimage came into being so that the mothers and widows of those loyal sons of America might see the resting places of their dead.

The problem of Gold Star Pilgrimage was unique. Thousands of women of all ages, all walks of life, and all degrees of education, were to be taken from their homes to the cemeteries of Europe to visit the graves of their soldier men. Mothers were largely in the majority; their average age was 61, and one was 91 years old. They came from all parts of the United States, the rural districts as well as the urban. Most of them were extremely poor and had never travelled; many were infirm; numerous races were represented; many could not speak English; others could not write. The personal comfort of each pilgrim was a paramount duty that was charged to the Army.

In the administration and execution of this exceptional movement every detail had to be considered. Anticipated considerations included health, transportation, lodging, meals, and baggage; but the list became

limitless and grew by leaps and bounds under the demands of necessity. The pilgrimage seemed so replete with difficulties that at first it appeared hazardous to anticipate the outcome, but as each party came and went and the success of the entire venture became increasingly evident, hope gave way to confidence.

Invitations were extended to all women eligible to take advantage of the Act of Congress. Of the 13,831 who qualified, 3,653 accepted and made the trip in 1930. Others accepted for later years, the entire movement being of a four years' duration.

As each party was established and the date of sailing determined, a first class ticket to New York and an itinerary were delivered to each woman in person. A liberal allowance was afforded to provide for meals, tips, and miscellaneous requirements en route. The pilgrim then found that her entire trip had been planned for her and that she was to be constantly under escort. The proper train officials had been notified in advance and all were prepared to be of service. On her arrival in New York she was met at the station by army officers. Her baggage was always handled for her. She was taken to one of the large first-class hotels and given a room with bath. She was allowed two days to rest before sailing. During this period she was given an opportunity to see New York and was received by the mayor of the city.

When it was time to leave the United States, the pilgrims were escorted aboard one of the cabin boats of the United States Lines. In all ways the trip was made as comfortable as possible. One or more army officers were assigned to each boat. Specially detailed hostesses and nurses were provided. Steamer chairs and rugs, entertainment, and refreshments were available. The captain of the ship avoided stormy areas and generally arrived in port at the most convenient hour.



"In Flanders Fields," Waereghem, Belgium, July, 1930.

All of the pilgrims who were to visit continental cemeteries landed at Cherbourg, France. The day before the arrival of a party, a group of officers and nurses stationed in France made their way to Cherbourg. Usually the boat arrived in the early morning, more through design than by accident, since the early arrival permitted the pilgrims to disembark and make the trip to Paris during the hours of daylight.

When the tender drew alongside the ships in the outer harbor, the women were ready for the transfer. The long line of pilgrims filed down the gang plank, each wearing a government medal inscribed with her name and State, and perhaps another presented by the United States Lines. Some proudly waved American flags presented by the City of New York. In addition each woman wore a paper tag showing her name, car, and compartment assignment on the train. The baggage was unloaded at the same time as the passengers, and was also marked with the name, car, and compartment assignment.

Upon arrival at the dock, the pilgrims were conducted to their well marked cars and compartments in a special first-class train for Paris. The baggage was carried from the lighter and placed in the racks in the proper compartments. An army officer and a nurse were assigned to each car.

The regular passenger boat trains arrive in Paris at the Gare St. Lazare, but because of the crowded conditions at that station the French government permitted the use of the quiet Invalides station for these special trains. Upon arrival, the women formed in groups according to the hotels to which they had been assigned, and were guided to the proper buses by an army officer and an interpreter assigned to each group. From the

station they were taken to first-class hotels. Rooms were assigned and baggage was delivered. Later, identity cards and mimeographed instructions and group itineraries were issued, money was changed, questions were answered, and countless wants were fulfilled.

In the afternoon of the second day an impressive ceremony was held at the Arc de Triomphe, where wreaths were placed on the grave of the Unknown French Soldier. Though France may be remembered among our soldiers for its rain, not once did inclement weather interfere with this ceremony. From the Arc de Triomphe, the party went to a reception and tea at one of the fashionable restaurants of the Champs Elysées. Here the American War Mothers and Widows were welcomed by the leading representatives of both the French and the United States Governments.

In two or three days the groups started in motor buses for the cemeteries. The trips were by easy stages and the most interesting of the direct routes. Before reaching a cemetery, the pilgrims were housed at suitable hotels in the nearest large city.

The cooperation of the French authorities was especially commendable and the hospitality of the cities was most cordial. At St. Quentin each group that passed through was visited by a city delegation, an impressive ceremony was conducted in the ancient *mairie*, and each pilgrim was presented with a welcome card and a bouquet of flowers. The people of St. Quentin will never forget the generosity of the American people in helping to feed them while they were within the German lines before our entry into the war.

From the over-night stopping place the start was made for the cemetery on the following morning. At



At the Grave of the Unknown Soldier.

the cemetery each pilgrim was given a location card and a beautiful wreath to place on the grave, presented to her by our Government. A guide then conducted her to her hallowed spot and left her.

Four or five days in the vicinity of the cemetery were found to be ample. This period afforded each pilgrim an opportunity to make several visits to the grave. During that time the pilgrims became acquainted with the devastated areas and the positions of the troops in battle. Most of all, however, they saw the work that our government is doing in perpetual memory of the heroes of the World War. They could see the beautiful, well-kept cemeteries; they could visit the impressive chapels and memorials being erected by the American Battle Monuments Commission, under the guidance of General Pershing. At each cemetery there is a chapel and on each sector occupied by American troops there has been or is being erected a war memorial for all of our units that were engaged in that region. These memorials are placed at such important sites as Mont Sec in the St. Mihiel sector, Montfaucon in the Meuse-Argonne sector, Château Thierry in the Aisne-Marne sector, Audenarde and Ypres in Belgium, and so on through the glorious list.

On the return to Paris by a different route, many points of purely sight-seeing and personal nature had yet to be visited. Organized and especially guided visits to the cathedral of Notre Dame, Napoleon's Tomb, and the Louvre museum were offered. Buses were provided for seeing Paris by day and by night, for half-day trip to Versailles, and for a full day trip to Fontainebleau. Besides, organized shopping was conducted, as well as church attendance. Individuals had plenty of time to visit other points of interest.

At the end of two weeks in France the party started back to Cherbourg for the return trip, the conducting officers seeing the pilgrims aboard the steamer. After the usual eight days at sea there was a day in New York before the trip home, which could be made with stopovers.

The health of the pilgrims was exceptionally good. The excellent record is a remarkable tribute to the army doctors in charge and to the able corps of assigned nurses. One of the two mothers who died was quite aware of her weakness before she left home, but was determined to make the trip; her one remaining mission in life was to visit the grave of her son.

In spite of the fifteen or more times that the baggage was handled, not a single parcel was lost. Many exceptional services were rendered. One widow lost her husband's Croix de Guerre and Medal of Honor; they were recovered through the Prefect of Police in Paris. Relatives accompanying the pilgrims were advised and assisted in their travels. Some of the pilgrims were interested in some particular feature of Parisian activity, such as the opera, and arrangements were made for each special case. The work was unusual, hard, even trying at times, but in all cases it was cheerfully, courteously, and conscientiously performed.

Throughout the Pilgrimage there was a certain amount of pathos. These women had come a long way on a serious mission. Nearly all brought with them remembrances and keepsakes of the days of long ago. Many of the women had to relieve pent-up emotion by telling of their sons. In many cases at the time of the soldier's death some one, usually his company commander, had written to the boy's home offering a few words of consolation and encouragement, and trying to explain how the boy had died fighting for his country in battle. In all cases these letters were among the most cherished possessions. More officers would have written them if they could have known how much they would mean.

The French courses at meals were often a problem. To many the hors d'oeuvre was particularly trouble-



After the Ceremonies at the Mairie, St. Quentin, May 28, 1930.

some at first, for they would make a real meal of it and then complain that the meal was "all cold and too much salad." When later courses would appear, the diners acknowledged complete defeat.

And what were the results of this great experiment? Brilliantly conceived, efficiently administered, and conscientiously executed, the Pilgrimage will enter history as a living example of well-performed, exceptional service rendered by the Army. The pilgrims were eminently pleased. By word of mouth and by letter they have acquainted and no doubt will continue to acquaint the country of their pleasure; they wrote it to the personnel with whom they had been associated, they wrote it to the administrative heads of the Pilgrimage, they talked it freely to newspaper reporters, they wrote it to their senators and congressmen, they told it before American Legion meetings and patriotic and social gatherings.

The Army of which their menfolks had been a part had helped to give these mothers of heroes a brief space of poignant but very real happiness. From being a living reminder of their loss, the Army has become to thousands of Gold Star Mothers and Widows the living symbol of the Nation's gratitude to and care of their soldier sons and husbands who fought a good fight and gave up their lives for their country.

# The United States Looking Outward

*Colonel S. C. Vestal, Coast Artillery Corps*

THE present discussion attempts to show how, from time to time, we have departed from peace; what are the present dangers to peace; and what are the signs of an approaching storm. I shall confine my attention to international war, mainly, as distinguished from civil war.

The United States is bound to the nations of the earth by the most intimate and important ties. Prior to the World War she was a debtor nation. Today her investments abroad exceed \$15,000,000,000. They are increasing at the rate of more than a billion a year. The fundamental reason for these investments in that her exports, visible and invisible, exceed her visible and invisible imports. The balance is struck by investments abroad.

The United States has 52 per cent of the world's coal reserves within her borders, and she has the economic control of 50 per cent of the world's iron reserves. Command of half the world's coal and iron gives assurance that she will be the great manufacturing nation for many ages. In most other important raw materials she is similarly blest. She has an incomparable geographical position on the southern half of the North American continent, facing the world's two great oceans. No other region of the earth is so rich and so consistently watered and sunned throughout the year as the vast expanse of the United States. These manifold natural blessings give assurance that the United States will be the great producer of wealth of the future, the great lender of capital to other nations, the financial and commercial center of the world as no other nation has ever been.

Such wealth must inevitably arouse that international envy which is a great foe to this great and ever growing invisible empire beyond her borders. Our government is the servant of the people; and when the people are vitally interested in all parts of the earth, the government will have to look outward more and more, whether it wishes to do so or not. What means has it to protect our great interests that lie beyond our national boundaries?

The framers of the Constitution went to great pains to make assurance doubly sure that Congress should express the will of the people on vital matters intrusted to the National Government. They succeeded in their purpose. In no other country, in ancient or modern times, has the legislative body more fully reflected the will of the people.

In obedience to the will of the people, Congress has five times recognized that peace has ceased with a foreign nation, and has declared a state of war to exist; with Great Britain in 1812, with Mexico in 1846, with Spain in 1898, and with Germany and Austria in 1917. In no case did the declaration of war initiate a

war. It merely recognized the existence of a state of war brought on by the hostile acts of other nations.

For several years prior to our declaration of war against Great Britain in 1812, both France and Great Britain, which were at war with each other, had been committing hostile acts against our merchant ships on the high seas, in foreign ports, and even in our own ports and coastal waters. We were at peace towards them, but they were at war towards us. They were exercising all the rights to capture and confiscate our merchant ships that would have been possible had we been at war towards them. Our people did not want war. They were prepared to go any length to keep out of it.

The belligerency of Great Britain came home to them much more closely than that of France. Many of our people sympathized deeply with Britain and her allies in their mighty struggle with the overweening ambition of France under Napoleon; but the British navy was taking sailors from our ships and impressing them for service in the British fleet under the pretext that they were Englishmen; and a British ship actually attacked an American war vessel and took from it several sailors of American birth. England's estimate of us in those days is reflected by the remark of an English peer, who, as plain Mr. Addington, had been prime minister of Great Britain. "America is a bugbear," said he, "there is no terror in her threats."

The United States has never needed persuading to peace. She has sat pacifically disposed whilst other nations were committing acts of war towards her. The genesis of the War of 1812 has repeated itself at the beginning of all our later wars, including our war with Mexico.

It is a notable fact that we have enjoyed international and domestic peace under fire-eating, virile, presidents of the type of Monroe, Jackson, Cleveland, and Roosevelt; while our wars have come during or immediately after the administrations of eminently pacific presidents such as Madison, Buchanan, and Woodrow Wilson. It is one of the paradoxes of our national history that our wars have come from our own instinctive dread of war. This dread of war has been a source and cause of war. Domestic and foreign foes misinterpret its real significance; they go too far and finally goad us into action. Our danger of war comes, not from our aggressiveness, but from the contempt of our enemies for our mental, moral and physical preparedness for war.

The feeling that America is a bugbear and that there is no terror in her threats has not been confined to European statesmen of the period of the War of 1812. Contempt for the prowess of America on the

part of the German leaders drew America into the World War. The same feeling in the breasts of the Allied leaders long kept them from giving their approval to our entry into the war on their side, and long delayed the formation of an American army after we had entered. It may astonish some to know that in December, 1915, sixteen months before our declaration of war against Germany, President Wilson had made up his mind that we must inevitably fight; that he sent Colonel House to Europe to arrange for our entry into the war on the side of the Allies; and that Colonel House failed in his mission only because the Allies did not desire us as an ally. The second volume of "Colonel House's Intimate Papers" brings out these facts very clearly. The Allies doubted the mental and moral factor of America even more than the physical. Neither friend nor foe would have believed it possible that an American army on the battlefields of France would be the decisive factor in bringing about the German collapse on the Western Front in 1918. But this was the case.

For twenty-three months, from the sinking of the Lusitania with its American victims, May 7, 1915, until our declaration of war, April 6, 1917, we were at peace towards Germany, whilst Germany was at war towards us. At almost any time during this period, we would have gone to war if the President had given his consent. Mr. Wilson hesitated long because of the unwillingness of the Allies to receive us as one of their number. These seemingly contradictory facts bring us squarely up to the question of our geographical situation and our foreign policies.

As a nation we profess defense as our military policy in time of peace; but when we talk of defense do we ever ask ourselves the question: Whence may danger come? Do we fear attack from Canada, Mexico, South America, or Africa? Certainly we do not. Danger may come to us from two possible sources, two great centers of population, Europe and eastern Asia. One lies across the Atlantic and the other across the Pacific. If Germany threatens to unite the teeming and warlike millions of Europe under an efficient warlike government, we sit up and take notice. Presently we go to war and we astonish the world by our earnestness, by the magnitude of our preparations, and by our aptitude for making war when it comes to the pinch. While we profess indifference to European affairs as a settled policy, we have, in fact, an implicit national policy toward Europe, which has never been acknowledged by our government and has never received a name, but which cost us \$32,000,000,000 in 1917-18-19. On the other hand we frankly admit that we are not indifferent to political combinations in Asia that may be dangerous to us. We have a settled policy toward eastern Asia. We call it the Open Door Policy. It is political in nature, though couched in the language of commerce. Why do we profess indifference towards Europe, and assert the Open Door Policy towards Asia? I think I can give you an answer.

Between the western shores of continental Europe and the eastern shores of Asia are two Anglo-Saxon

naval powers, England and the United States. England lies close to continental Europe, and she has always shown a peculiar sensitiveness to the efforts of conquering nations to unite Europe under their control. Until quite recently, England has counted European battleships alone in fixing her naval strength. We, on the other hand, have kept a watchful eye upon the number of battleships built and building in eastern Asia. England and the United States accept parity of naval strength between themselves, but they will not accord it to any other nation. The fact is that we unconsciously trust England to watch out for us in Europe; and England, perhaps a little more consciously, trusts us to watch out for her in eastern Asia. But when England was on the verge of disaster in the last great war, we suddenly realized that the success of Germany meant the loss of all that we held dear in life; and we entered the war rather unceremoniously. It requires no wide stretch of the imagination to see that if England did not exist, or if she fell into a premature decay, we would be sensitive about Europe, and our implicit European policy would be enunciated and given a name by some James Monroe or John Hay. By the same token, England would be sensitive about eastern Asia if we did not exist to shield her and her weak Asiatic, Oceanic, and American dependencies. It is geographical situation, as well as blood or language, that makes England and the United States the natural allies of each other and of the weaker nations of the earth. We acknowledge this obligation in regard to the American nations by our Monroe Doctrine, and in regard to Eastern Asia by our Open Door Policy.

The great wars of history, the world wars, have not been accidental. They have been caused in each case by an ambitious nation that has sought to make itself master of the civilized world. I need only mention the wars of Philip II, of Louis XIV, of the French Republic of 1793, of Napoleon, and of Kaiser Wilhelm II. The history of any one of these wars is the history of all of them.

But when, we may ask, is the world threatened by such a war? Is there no international barometer to foretell the coming storm? Yes, there is; and each of us may construct one for himself. Success in such a war absolutely requires that the ambitious nation shall dominate both land and sea. You will recall that when Rome, the great land fighter of antiquity, defeated Carthage, the great sea power, in the naval battle of Aegusa, Rome soon became the master of the ancient world. The lesson should not be lost on us who desire neither to conquer nor to be conquered.

The first note of warning is sounded when a powerful nation makes war the business of life and concentrates the national effort upon its army. This corresponds to the high-flying cirrus clouds that foretell the hurricane. The near neighbors on land are in danger. There is no immediate danger for nations across the sea or separated from the storm center by intervening nations. When Prussia prepared to invade Denmark in 1865, her neighbors on land scented

the approaching storm. The rest of the world was indifferent.

The second note of warning comes when the ambitious nation begins a great naval program, in addition to its great army program, and talks of crowded population. These things and an outburst of pacifism in the threatened nations correspond to the storm tide that precedes and announces the hurricane. When Germany passed her naval law in 1898 the storm flag should have been raised in every capital of the civilized world; because a powerful, overwhelming German navy would have enabled the Kaiser's army to strike anywhere on the face of the earth.

Whenever any nation attempts to become the strongest military power and begins a formidable naval program, it becomes a menace to all other nations. Re-read your Roman history, if you have any doubt as to what such a combination of armed forces under the control of a single nation may do. Read Tacitus, the first volume of Gibbon, or *Quo Vadis*, if you wish to visualize what life on earth may become when one nation dominates all other nations. To prevent such a domination is the great problem of freedom and peace. The fear of it is the beginning of international wisdom.

As long as a country confines its armaments mainly to one element, either land or water, it is not an immediate world menace, although its preparations on land may be dangerous to its near neighbors. An army without a navy cannot strike far; a navy without an army can not strike hard. Danger enters when the two are combined in the hands of a single nation. No nation except those whose land frontiers touched Germany, feared Germany so long as she had a great army but only a comparatively weak navy. England was Germany's friend. When Germany began to

build a great navy in addition to her great army, England's attitude changed overnight; and the American republics across the ocean began to take an interest in what Germany was doing.

One may easily construct an international barometer by making separate lists of the great military powers and the great naval powers. If the name of a country appears on both lists it may rightfully be regarded as a developing menace to world peace. Let us construct such lists, beginning with Russia. Russia has no navy; and the events of the Russo-Japanese and World wars showed that the probability of her ever having an efficient navy is remote. Her name will not therefore appear on the navy list. The Soviet army entitles her to a place on the Army list. Russia may cause annoyance to her immediate neighbors; but, as a military and naval power, she is not a serious world menace. Germany's military preparations and her great military capacity entitle her to a place on the army list. Her present navy does not entitle her to a place on the navy list. France's army puts her on the army list; her present navy does not put her on the navy list. Italy is entitled to a place on the army list. England's navy puts her on the navy list; but lack of a great army, prepared to take the field at the beginning of a war, keeps her off the army list. The same remarks apply to the United States. We are entitled to a place on the navy list.

This barometer will give timely warning when one nation threatens to become dominant upon both land and sea. But the barometer at the door is no safeguard against the storm. Fortunately, the founders of our government created agencies for our self-preservation and intrusted them to our keeping. We have only to use them wisely and resolutely to insure our complete protection.

# Military Instruction Films

*Captain Alonzo P. Fox, (Infantry) Signal Corps<sup>1</sup>*

MAN, since the days when he used a club to accentuate his more captious statements, has found the spoken word somewhat inadequate as a medium of expression. Thus we find him from time to time devising adjuncts and embellishments in the form of hieroglyphs, symbols, and song. When pictures of word forms were devised, communication of ideas became an art, and the keystone of civilization was set. But inasmuch as these forms convey only words, and as these words often inadequately depict the subject, the instinct to see calls for a truer likeness. Of this need the picture is born. We like to see what we are to believe, and our minds are peculiarly receptive to what we see. Today, we are decidedly picture-minded.

Now a new field is about to be intensely cultivated—academic and industrial education by means of motion pictures. The practicability of this is undoubted. Retarding factors, for the moment, are lack of proper facilities for showing the new type of pictures, and an inadequately supply of well arranged and authoritative films. Both of these deficiencies will certainly be overcome. When it is realized that instruction films will soon be available depicting, for example, a noted surgeon performing operations bordering on the miraculous, and explaining in detail his demonstration as he proceeds, the real application of such films must be apparent.

The United States Army was the first institution in this country (and probably in any) to attempt mass instruction by means of motion pictures. In the latter part of 1918 and the early part of 1919 some 60 subjects were produced, portraying various phases of military training. These films were intended to assist in the training of our National army. Unfortunately, the project did not reach full fruition until after the Armistice and its real value could not then be determined. This very failure, however, should serve to impress the fact that the time involved in the production of satisfactory films renders it imperative that this work be carried on progressively before the emergency arises, if they are to be used effectively.

These films were used more or less in the years immediately after the war for instruction purposes. Some of the subjects were well conceived and portrayed. Some of the so-called "animated" pictures were especially well done and had a wide appeal. Other films were intended to teach by motion pictures what had better have been left to subordinate instructors on the ground. The real field for demonstrations of minor tactical problems remained an aching void.

As uniforms, materiel, and training methods changed,

the task of revising the existing films and producing new ones devolved upon the Army Pictorial Service, a section of the Chief Signal Officer's Office. All but 22 of the films originally made were declared obsolete and were withdrawn from circulation. A tentative schedule, as present requiring the production of not fewer than four subjects annually, will be increased to eight films annually in 1933. This project was begun in December, 1927, since which time 20 new subjects have been produced and distributed. To broaden the scope of application and to simplify their use, 15 of these later films have been distributed also in the 16-millimeter or "home movie" size. This has been a popular innovation, especially among the reserve and national guard units, as these films can be exhibited in a squad room or a recreation room by the rankest of amateur projectionists.

A system of decentralized distribution has been set up, utilizing the corps area signal offices in the capacity of local film exchanges for their corps areas. An ideal distribution within a corps area appears to be the rotation of films on schedule to the various units for short periods. In some corps areas this ideal has been so nearly approached that excellent programs are carried on throughout the year, embracing also the C. M. T. and R. O. T. C. encampments. Unfortunately this is not universally true and considerable pioneer work is still necessary to make for a better understanding and more effective use of this valuable adjunct to the usual training methods.

In the production of training films the Signal Corps works solely as the operating agency. It has the facilities for processing and distributing training films. It also has the cameramen, camera equipment, and officer-directors. The selection of the subjects to be produced, the writing of the scenarios, and the form of their presentation, the arrangement for the necessary troops and local facilities, are the responsibilities of the interested arms with, of course, the concurrence of the War Department. The Signal Corps, obviously, cannot assume these functions. In connection with the more recent pictures produced, it has been found desirable and profitable to have the officers who were detailed to draw up the scenarios do this work in collaboration with officers of the Signal Corps familiar with the possibilities and limitations of the camera.

The subjects filmed since 1927 are diversified. This is so by reason of the fact that the demands for films covered a wide range of subjects, and the endeavor has been to meet these demands, at least in part, within existing means. A partial list of these newer films is indicative:

1. School of the Soldier, Steps and Marchings,

<sup>1</sup>Officer in charge of the Signal Corps Photographic Laboratory, Army War College.

Manual of Arms, The Medical Service with Infantry in Combat.

2. Care of Animals, The Trooper Mounted, The Cavalry Platoon in Mounted Action.

3. The Gasoline Engine, Lubrication, The Spark Plug, The Storage Battery.

4. The Tactical Handling of the Antiaircraft Coast Artillery Regiment, Defense Against Chemical Warfare.

5. Supply of a Division, Development and Deployment of the Division for Attack (Leavenworth).

6. A film to be used in antiaircraft sub-calibre rifle practice, in which the moving image of an airplane constitutes the target.

The question of what subjects may advantageously be "picturized" is a much mooted one. Granting that unlimited production facilities were available and that a very comprehensive library of subjects was already in existence, practically any subject which can be satisfactorily demonstrated would be a proper selection. However, only limited facilities exist, and the film library is in a more or less embryonic state, so that the choice in each instance should be one to meet the most insistent need, and one which lends itself to motion pictures—the essence of which is action. Generally speaking, the wider field of application of these films is in the R. O. T. C., the National Guard, and the Reserves, where so much of the instruction, particularly in the realm of minor tactics, is abstract and theoretical. Qualified instructors are scarce and trained troops to stage demonstrations simply do not exist there. Any means to make the instruction live and appealing is welcome. The map problem and sand tables are reliable stand-bys. The motion picture is an innovation, but if intelligently used it serves to amplify and impress the subject.

Almost invariably in a discussion of this subject, the unfortunate who has been button-holed will concede that this form of visual instruction is practical and that "it would be a fine thing" if instruction films could be had on military courtesy, care of the uniform, and the like—which is exactly what we did not want him to say. A capable corporal is well qualified to teach these subjects, along with the manual of arms and the care of the rifle. To demonstrate properly the combat principles of the squad, the section and the platoon is another problem. These and similar subjects as distinguished from purely mechanical instruction are more readily adapted to motion pictures and can be made both interesting and instructive.

It should be obvious that motion pictures are not intended to displace any of the usual forms of instruction. They are intended rather as adjuncts—the animated cousins of the lantern slide. They should serve to accentuate the high-lights of a subject. To attempt more than this in a picture is to convert it into a memory test which leaves the audience confused and befuddled. Too numerous and too lengthy titles are not easily assimilated; they retard the action and induce boredom. Likewise, experience indicates that an instruction film should rarely exceed two reels

in length. If an audience retains rather vividly five or six salient points the film justifies itself.

The introduction of "talking" or sound films revolutionized the film industry. Whatever the opinion may be as to merits of the commercial type, the advantages of this new element for instruction are obvious. True, the recording of voice and incidental sounds has complicated film production immeasurably. Too, the exhibition of such pictures is not the simple task as was formerly the case with silent pictures. The equipment necessary for production and exhibi-



The Heart of the Sound Studio: the Monitor, or Mixing Booth. The Operator Controls the Volume of Sound as it is Photographed on the Film.

tion is expensive and cumbersome, but the silent picture has practically disappeared from the entertainment screen and its days are numbered in other fields as well.

The Signal Corps may "point with pardonable pride" to the fact that it is the first federal government agency to equip itself for the production of sound films. The United States Army, it is believed, is the first in the world to take this progressive step. The first films produced on a limited scale will issue during the summer of 1931. At present the only available facilities for exhibition are in the larger post theatres. The production of the silent variety will continue until portable sound projection equipment, readily transported and set up, can be procured in quantity. The present prohibitive cost of such equipment is a real obstacle.

The talking films contemplated for the immediate future will be scored in the studio; that is to say, the films will be shot in the field as ordinary silent films and the lectures will be recorded later. This eliminates the many difficulties encountered in attempting to record speech in the open—where practically all training films must necessarily be filmed. It has the advantage also of permitting the lecturer to see exactly the finished scene as it will appear to his audience and to permit the absolute synchronization of the speech with the demonstration.

As has been indicated, the Army is not wholly "sold"

on the use of films in conjunction with training, but on the contrary, a considerable amount of inertia, which in time will be overcome, militates against their general use. Just where they are to fit into the scheme of training must be determined if they are to be effective. In the Regular Army, where instructors and facilities are amply available, the need for these films in the regular training season is not urgent. During the closed season of the year, however, when garrison schools prevail excellent use may be made of them to diversify the instruction. The regimental, or other unit, operations officers should acquaint themselves with the subjects pertinent to the training of their

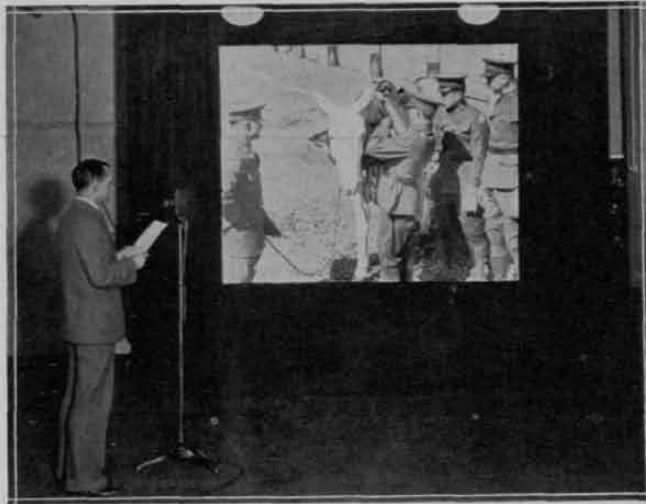

Scoring the Training Film: The Prepared Lecture is Delivered into the Microphone in Synchrony with the Scenes as they are Projected on the Screen.

organizations and in their training schedules make proper allotment of hours for their exhibition.

At this point it is probably not amiss to remark on the best procedure in the use of any instruction film. A very common tendency is merely to stage a show, often of several unallied subjects, and let the pictures teach what they can in one hurried showing without comment or discussion. The better practice, and one fruitful of results, is to select, first of all, a film that deals with current training. A preliminary explanation of what the film is intended to depict is certainly in order. After the exhibition a discussion elaborating upon the presentation will serve to confirm its impression. Oftentimes a second showing is desirable if the "saturation point" has not been reached.

The hours of armory training for the National Guard, it is realized, are limited and each hour must be packed with 60 minutes of instruction. On the other hand, because of the limited drill area, even simple tactical problems are difficult to demonstrate or illustrate. A judicious selection of applicable films would probably serve to take the mystery out of this phase of training. As a matter of fact, certain units of the National Guard of the District of Columbia are making quite extensive use of films during the winter months. They have served to heighten the interest and

also to build up attendance. Guard company commanders, naturally, are loathe to part with their units, which often need as much training in the fundamentals as time will permit. They cannot well object, however, to a break in the routine of instruction which is primarily designed to assist them in their task.

Except for short periods of active duty training, the Reserves are restricted almost entirely to theoretical instruction, lectures, conferences, and map problems. It is the task of the regular officers on duty with these units to make this instruction as interesting and agreeable as possible. In some of the units, more fortunately situated than others, having the means to hire an operator and projection machine, excellent results have been achieved by means of motion pictures. They realize that the reserve officer is often a "tired business man" in fact, and that he is not at all averse to assimilating instruction in a sugar-coated form. Here again the attendance curve is constantly rising.

It will be objected that the hiring of an operator and machine is not always possible, or that the means are not available. It was to meet this contingency in part that the sub-standard "home movie" type was placed in distribution. The machines are so widely used that almost any representative group will have access to one for this purpose. It not, one can usually be hired for a small sum and, as every individual is a potential operator, no high powered technician is required.

In the R. O. T. C. units, the training films have received their most extensive use. It is from the instructors of these units that the most insistent demands and the most thoughtful criticisms have come. It is not astonishing that this is so. These instructors are associated with teachers who must constantly strive to keep youthful minds pointed in a very definite direction. They are constantly casting about for new ways and means to accomplish this. In the course of events the military instructor does likewise and very often resorts to the film as his gesture of modernity. If his first selections are happy ones he may become a confirmed user; if not, the aforementioned criticisms are sometimes forthcoming.

The courses at our special service schools are well planned and generally excellent. I would not purpose that the training films supplant in any way any part of these courses. However, in view of the great portion of time each officer must necessarily serve with the Reserves and similar units, I feel that some part of these courses might well be devoted to acquainting him with the art of visual instruction and what facilities the Army has available for this purpose.

I should like to leave you with the thought that the Army is committed to a real program of training film production. Much serious thought is expended in their conception and great care in their production and presentation. They are designed primarily to amplify and diversify military instruction. A real effort is made to render their use simple and practicable. They are not the brain-children of faddists but represent the Army's effort to apply an art which is recognized generally as an excellent medium for instruction.

# Industry and National Defense

## IV

*Major General George Van Horn Moseley, U. S. A.*

WAR has ever been accompanied by rising prices and depreciating currency. The trouble begins in those items for which there is unusual demand, such as copper, iron, steel, wool and cotton. Increased cost in these items occasions an increase in the prices of articles made from them, and the cost of living begins to mount. Wage earners face hardships and rightly demand increased compensation. This in turn increases costs of all production from basic raw materials to finished products, and the whole process begins anew. Rising prices require the government to procure more money on credit than would otherwise be necessary, and when its credit begins to be strained, the effect on the whole is most startling. In the World War, Russia had extreme experience along this line. Our own experience was not so unfortunate, but it was sufficiently disturbing to cause us to reflect on what might have happened if we had begun to approach exhaustion without having adopted positive stabilizing measures. It also points to the necessity of developing some method to prevent the beginning of the vicious circle of rising prices and money inflation.

No one has as yet discovered a complete or perfect method of controlling prices in war. Contradictory theories affecting it have been advanced. Often it is said that an attempt by the government to control prices would be an attempt to "repeal the law of supply and demand," and at this bald statement we are supposed to blanch with terror and hastily thrust such thoughts from our minds.

It is true that when prices are fixed they are placed at different levels from those that would result from free bargaining during the stress of war. But it is also true that in fixing prices consideration must be given to the necessity of equalizing supply and demand. In other words, we know that we must not fix prices at a level that would stifle production, and at the same time must find some method for stimulating supply without the necessity of offering absurdly high prices. Reduction in consumption should be accomplished by some means other than charging such prices. Appeals to the patriotism of citizens had a marked influence in this regard in the past war, particularly in curtailing consumption. Who does not remember the wheatless, meatless and gasless days, as well as the zeal we displayed in saving worn out electric light bulbs to turn in to the authorities? In response to government requests we planted "war gardens" and abandoned the practice of hoarding supplies. Measures along this line tend to enhance supply and dimin-

ish demand, but they are not in themselves sufficient to effect stabilization of prices in war.

Fundamentally the purpose of price control is to effect the equitable distribution of the war burden without interfering with production. This equalization should apply among ourselves, and also between the present and the future. We wish to prevent excessive profits in one quarter, and a lowering of a living standard in another; we do not want to incur great debts on an inflated money basis, and pay for them later in a period of deflation.

It is frequently said that to accomplish these purposes in war the United States should "draft everything and everybody into the government service." People who make such a sweeping statement probably do not employ the word "draft" as we usually understand it. The government must put everything and everybody to work in the common cause; but it would be difficult to conceive an organization such as would result from a complete "drafting" of the American nation. It seems unnecessary to enumerate the manifold administrative and technical difficulties that would inevitably arise in attempting to form such an organization. Questions as to the constitutionality of the plan are left to the lawyers; what we are concerned in is its practicability. It seems to me that here is proposed a scheme that at best would require more time for its accomplishment than could possibly be permitted if we were faced with a major emergency. Moreover, 120,000,000 people would be trying to adjust themselves to a complete change in our economic processes at the very time that their full attention should be given to the tasks laid out for them in repelling the enemy from our gates. These are my personal views. I appreciate the justice in the idea that lies behind the proposal, but I for one should not like to see the safety of the country made dependent upon an organizational scheme which could not be put in operation promptly, if at all. At least, such a solution cannot be considered as a practicable one until some person comes forward with a detailed and workable program for its consummation.

On the other hand, I do not for a moment agree with those who say that we should keep hands off and let prices go where they will, and take back into the treasury all excess profits by means of graduated income taxes. While excess profits taxes would have their place under any scheme, to accept such a method as a complete solution is akin to a deliberate courting of disease in the belief that the doctor's pills will surely cure us.

One thing is certain: we cannot supinely say there is no solution. When we enter a war the mass of our

<sup>1</sup>The last article of a series of four.

citizens are willing and anxious to make unusual efforts and sacrifices for the good of the country. The weight of public opinion thus engendered is the most powerful and compelling force in our list of assets. All we need is the intelligent and practical direction of this force to accomplish any desired result. With the aid of this force any practicable plan will work; without it, none will solve the difficulty. Based on this line of reasoning, certain eminent men have evolved a plan for price control which they believe will be effective.

The essence of this plan is: Upon the outbreak of war, and subsequent to any necessary authorization from Congress, the President would issue, under the authority of a specific law, a proclamation fixing or "freezing" prices at the levels existing on some prior date, chosen to represent as nearly as possible the prices of "normal" times. This scale of prices would apply to all things and all services. Coincidentally with the promulgation of this proclamation there would be established a price-control committee composed of able administrators representing every kind of human endeavor. This committee would consider the "fixed" price list as a basis on which to make adjustments from time to time to meet the needs of the country and to insure justice to all classes. In addition to specific law and public opinion, another means of making effective the decisions of this committee would be through governmental control over raw materials and other essential elements of production. No manufacturer, railway executive, or mine operator could long ignore a reasonable price regulation if he were confronted with the certainty that non-conformance would result in the withholding from his concern of steel, fuel, power, transportation, or other essential items.

In time of peace, countless arguments can of course be propounded against introducing such a system in war. There are unquestionably many difficulties to be overcome, and probably no one can foresee the eventual results. Proponents of the plan urge that in the United States it was being gradually evolved during the war, and that sufficient experience was gained to prove its practicability. We should not forget, though, that in 1917 price reductions were effected by agreement rather than by governmental fiat.

In England price fixing was apparently much more extensively practiced. Commentators state that, though their system was not perfect, it was in general effective.

No one can deny the great importance of preventing rapid price fluctuation in war. Careful pre-arrangement for procuring governmental supplies, and aggressive and intelligent leadership, backed up by supporting public opinion, can accomplish much. Whether or not we should attempt the application of a rigid and all-inclusive system at the beginning of a great emergency is a question that requires more discussion and thought before it can be definitely answered.

Transportation, like finance, is a vital factor in plans for national industrial mobilization. The transporta-

tion facilities of this country are varied in nature and are becoming more so. However, the railway systems remain the backbone of internal transportation, and the studies are grouped around their capabilities and limitations.

During the war we took over the railways, but the experience was not entirely a fortunate one, and a better plan for satisfying governmental needs should be devised. We need control rather than possession. Over and over it should be emphasized that the government should take advantage of the experience, training, and ability gained in time of peace by commercial organizations and by individuals. The government's directives to all should be: "Meet our requirements efficiently and fairly, and full justice will be done to you." Railway executives are experienced in meeting transportation emergencies. To relieve them of the responsibility for meeting the transportation emergency incident to war would be to rob ourselves of an important national asset. Recognizing their responsibility in this matter, the railways, through the American Railway Association, have developed, in cooperation with the War Department, a comprehensive plan that would unquestionably work efficiently.

The government would necessarily perform functions in war with respect to industry other than those mentioned. Enough has been said, however, to illustrate the underlying principles of the plans now being developed. To indicate what should be done is manifestly insufficient; the plans must provide for the necessary administrative organization. Here again we must fall back upon experience to point out the path to practicability. No doubt such an organization could assume any of several forms and still meet the requirements of the situation. I believe the following would be satisfactory.

A vital part of the organization, *but not a part of the government*, would be a group of committees, known in the late war as "War Service Committees." Each was in effect an executive committee for the particular branch of industry it represented, and was maintained in Washington by that industry. It served as the connecting link between its particular association and the government. Recent years have witnessed a growth in the business world of the tendency of related activities to group themselves into associations, so that, in general, these executive committees exist in time of peace. In the late war there were about 175 service committees; in any future emergency, there would probably not be fewer.

The governmental part of the industrial organization would of course be purely a war-time emergency unit. It would be an organization authorized by Congress. Through it would be exercised those parts of the war powers of our President dealing with industrial matters. This organization, heading up into one man directly responsible to the President, would be made up of the ablest representatives available from all branches of industry. In the name of the President it would direct and control the industrial forces of the whole country in accordance with the necessities of the particular situation.

In the process of developing the organization outlined above, the cooperation of many agencies is essential. For instance, we need the cooperation of the National Chamber of Commerce and the various trade associations. Data, studies, initial operating plans, and nuclei of personnel should be ready for grouping under the men the President would select to fill the key positions in the organization. The Department of Commerce could provide information and experts on domestic and foreign trade; the Department of Agriculture on food, cotton, wool, and other products; the Treasury Department on financial matters; the Interstate Commerce Commission on transportation; the Army and Navy on requirements of those forces; and so on. All appropriate parts of the government should be familiar with the essentials of the plan. When mutual understanding and agreements had been established among all these, progress on this part of the program, could keep abreast of that applying strictly to the procurement plan of the military service.

Moreover, in time of peace these questions should be discussed openly and fearlessly in the forum of the whole people. The measures adopted to meet them would have a direct and profound effect upon the lives and welfare of us all in the event of an emergency. Every citizen has a right to know what may happen

to him under these circumstances, and an equal right to be heard by those who would have the responsibility for making the ultimate decisions.

While the whole process described in this article is called preparation for industrial mobilization, it is not preparation for war in the generally understood sense of that term. It seeks only to make the best use of all resources in the event we are suddenly plunged into conflict, to insure equal distribution of the sacrifices and hardships entailed by war.

Under a well prepared and widely understood scheme of this description, American industry would not be violently disturbed in the event of a national emergency. Since there would be no competition among governmental agencies, one great cause for the skyrocketing of prices would not exist, and a proper balance between cost of living and income would be easier to maintain. The government would be in position to make the best use of all resources. Public opinion would encourage maximum effort by all. Profiteering, if it still existed, would be reduced to the minimum, and, the guilty discovered and punished. War debts, to be paid by ourselves and by our children, would be no larger than necessary and would not include enormous sums to pay for our own folly, waste, ignorance, and inefficiency.



View from Non-commissioned Staff Circle Showing Administration Building and Bachelor Quarters at Fort Amador, C. Z.

# The Officers' Reserve Corps

Major L. L. Stuart, C. A. C.

*EDITOR'S NOTE—The information contained in the following article is probably well known to reserve officers. Due to the many changes which have been made in the regulations pertaining to the Organized Reserve it has been very difficult for regular officers not on reserve duty to keep up to date on the requirements for appointment, promotion, and reappointment of reserve officers. Major Stuart was asked to write an article, supplying the general information which every regular and national guard officer should have.*

**I**N 1917, when we found ourselves involved in a war of the first magnitude, our most serious deficiency was our lack of trained officers; in fact a lack of sufficient officers of any kind. We found that men could be obtained and trained in a relatively short time, provided we had the officers to train them. The problem of developing officers was much more difficult.

In case we should become involved in a war at present we would find that we had in the Army approximately the following officers:—

12,000 Regulars  
13,000 National Guard  
100,000 Reserves

What is the status of the reserve officers, who will comprise three-fourths of the Army on the day of mobilization? If we consult the National Defense Act we will find that the appointment of a reserve officer shall be for a period of five years, except that an appointment in force at the outbreak of war shall continue six months after its termination. We will also find that these reserve officers will include every grade from second lieutenant to general. Approximately 8,000 are assigned to units of the Regular Army.

Thus we see that the reserve officers will, by force of numbers constitute the bulk of the Army which will begin to mobilize on M-day. We, who will serve shoulder to shoulder with these officers, should know them; know what military training and knowledge they possess—their capabilities as well as their limitations.

Possibly the clearest realization of the strength and importance of the Reserve Corps, as well as its weaknesses, can be obtained by a presentation of the policies and regulations under which it operates. These are presented in the following discussion.

## Purpose and Composition

The Officers' Reserve Corps is organized for the purpose of providing a reserve of officers available for military service when needed. This includes the furnishing of a certain number of noncombatant officers and units for the supply and administrative service necessary to the maintenance of the Regular Army and the National Guard in the first phases of the war; the completion of the commissioned strength of regular army units by the assignment of junior

officers; and the formation of the framework of the units supplementary to the Regular Army and National Guard which must be raised in a general mobilization of the nation.

Of the 100,000 reserve officers, 72 per cent are lieutenants, 16 percent are captains and 12 percent are of field grade. Of these 77,000 can be relied upon for immediate use, most of the remainder being inactive. Approximately 51,000 of the available officers are combatant and 26,000 noncombatant.

In its peace time functioning the Army of the United States is comparable to a large university, wherein the regular officers are the professors or instructors and the national guard and reserve components correspond to the student body, ranging from freshmen to those taking post-graduate work.

To assist in administration and training, the Reserve Corps is divided into some twenty sections. These correspond to the different arms and services of the Army. In addition it includes other sections, such as the Sanitary Corps Reserve, the Military Intelligence Reserve, and the Specialist Reserve. To the latter are assigned those officers required for certain phases of industrial mobilization.

## Appointment

All persons appointed reserve officers are commissioned in the Army of the United States. Appointment is primarily based on the applicant's military qualifications, although he must also have at least a high school education or its equivalent, a good moral character, and be physically fit. Appointments may be made from the following classes of persons:—

1. World War officers and former regular army and reserve officers, excepting these who were separated from the Army as a result of their own misconduct. This class is appointed upon the approved recommendation of an examining board, in any section and to any grade not above the highest held by them when in the Army. Last year appointees of this class numbered only 700 out of 10,000, and in a few years the World War officers will have ceased to be a source of supply.

2. Approved graduates of the Reserve Officers' Training Corps, who are commissioned in the lowest grade without examination on the recommendation of the PMS&T at the college. About 6,000 officers are appointed in this manner every year, which is over half of the yearly increment. This class rep-

resents in general those who are best qualified, by education and natural endowments, to supply officer material.

3. Approved graduate flying cadets. Last year this included 200.

4. Graduates of the Citizens' Military Training Camps who have completed a certain specified amount of extension course work may be appointed in the lowest grade. During the past five years the number of appointments from this source varied from 36 to 140 in 10,000. The extension course work normally requires a year or two for completion.

5. Warrant officers and enlisted men of the Regular Army and Enlisted Reserve Corps, and persons not included in the preceding classes who served in the United States Army during the War, may be appointed to the lowest grade on the approved recommendation of an examining board. Last year this class supplied 2700 of the 10,000 appointees.

6. Specially qualified persons may be appointed in the Specialist Section on the approved recommendation of an examining board without limitation as to grade. These officers are industrial specialists required for industrial mobilization, and are generally appointed with the concurrence of the Assistant Secretary of War charged with industrial procurement.

7. A federally recognized officer of the active National Guard may, on his own application, be appointed in the Officers' Reserve Corps in the same grade and branch in which he holds appointment in the National Guard, and for the period that his National Guard appointment is effective. Also any warrant officer or enlisted man of the National Guard may be appointed in the lowest grade of the appropriate section of the Officers' Reserve Corps for a period of five years, provided such action has the approval of the National Guard authorities. These reserve officers who are also members of the National Guard cannot be assigned under their reserve commissions, but must be assigned under their national guard appointments. Therefore they are not included in this discussion, which deals primarily with reserve activities. There are approximately 12,000 of these officers, or about 93 percent of all national guard officers.

Summarizing, the total number of officers now on the rolls, excluding those who are also national guard officers, may be classified as to source as follows:— Reserve Officers' Training Corps graduates, 35 percent; World War officers, 31 percent; World War enlisted men, 17 percent, miscellaneous sources, 13 percent; Citizens' Military Training Camp graduates, 1.6 percent; regular army enlisted, 1.2 percent; former regular army officers, 0.8 percent; flying cadets, 0.3 percent. This is the first year the R. O. T. C. graduates have outnumbered, the ex-World War officers, who are passing out of the Reserve Corps in increasing numbers.

#### Reappointment

Except for the "dual status" officers just mentioned, appointment in the Reserve Corps is for five

years, at the expiration of which time the officer must be reappointed. Formerly a reappointment in grade was generally tendered irrespective of the activity of the officer concerned. This resulted in a corps which was large on paper, but contained many officers who did nothing to increase their military knowledge or advance themselves in grade. In 1927 the regulations were changed so as to require that officers, in order to be reappointed with full privileges of assignment and promotion, must have during the preceding five year period obtained a Certificate of Capacity, (in which it is certified that the officer has demonstrated the necessary professional qualifications, usually by written examination, for the grade and section specified in the certificate) or has demonstrated his interest in military instruction by having a written record of at least 200 hours of extension course work, attendance at classes, or active duty training. The result of this policy has been that, while it has reduced the Reserve Corps in number, it has greatly increased its efficiency by retaining therein only those officers who took an active part in increasing their military knowledge.

#### "Inactive" Officers

Those reserve officers who have not demonstrated their interest in military affairs by having earned 200 credit hours during their five year appointment period are tendered reappointment without eligibility for assignment, promotion, or active duty training. Their records are kept in corps area headquarters. While they have failed to keep up with their military training, they have been classified and commissioned in an arm or service and have had some training in the past. They thus form a valuable initial replacement pool. Of the 100,000 reserve officers, approximately 20,000 belonged to this class last July. Until a five year period has elapsed since 1927 this class of officers will rapidly increase; thereafter it should stabilize, more or less.

#### Assignment

The basis for all assignments are the qualifications of the officer for the duty to be performed. There are three assignment groups of reserve officers— The General Assignment Group, which includes those assigned to War Department activities; the Branch assigned to a regular army unit, and this officer must an activity under the control of a chief of branch; and the Territorial Assignment Group, which includes all those assigned to corps areas. Ninety percent are assigned to this last group.

Regulations prescribe that in general the priority in assignment of the Territorial Assignment Group shall be:—

1. To active units of the Regular Army so as to bring them to war strength.
2. To inactive units of the Regular Army.
3. To units of the Organized Reserves.

Not more than one officer of field grade may be assigned to a Regular Army unit, and this officer must have had commissioned service during the World

War. Assignment to reserve units is in general on a territorial basis, the officer being assigned to the appropriate unit nearest his home.

#### Promotion

The promotion system in the Reserve is based on the principle that no person should be promoted to a higher grade until he has demonstrated that he is qualified to perform the duties thereof. But the manner of demonstrating these qualifications has been unsatisfactory in the past, and has undergone numerous revisions. Present regulations prescribe three requisites for promotion:—A minimum time in grade varying from three years for a second lieutenant to seven years for a lieutenant colonel; a vacancy must exist; and the officer must hold a Certificate of Capacity for the next higher grade.

#### Certificate of Capacity

A Certificate of Capacity is an instrument in writing executed under the direction of the Corps Area Commander, which certifies that the officer named therein is deemed to have the necessary professional qualifications to perform the duties and to assume the responsibilities of the grade and section specified in the certificate. To obtain a Certificate the officer must: (1) Demonstrate his knowledge qualifications by successfully passing the required examinations in from 5 to 8 subjects, depending on the grade, except that the completion of extension school subcourses will be accepted in lieu of the examination in the corresponding subjects; (2) demonstrate his ability to perform the duties of his grade before a board of officers; and (3), as an experience qualification, he must have completed at least one 14-day active duty training period with an efficiency rating of at least satisfactory.

#### Training

Training is either on an active duty status or an inactive duty status. In active duty training the officer receives the same pay and is subject to the same regulations as a regular officer. Inactive duty training is given on a non-pay basis and is normally performed while the officer is engaged in his civilian occupation. Active and inactive duty training together should provide mobilization, unit, and individual training.

Active duty training is either for a period of 14 days or, in special cases, for a longer period. The 14-day trainees attend a unit camp under the supervision of the Regular Army, conduct the C. M. T. Camps, or are attached to a unit or activity of the Regular Army. Specially selected officers may be placed on active duty for more than 14 days as additional members of the War Department General Staff, to attend the various special courses at the service schools, or for duty with tactical units of the Air Corps.

Appropriations provide for the active duty training of approximately 20,000 officers a year, which, if all individuals attended, would be an average of one in every three or four years. Actually some officers apply

every year, while others never do and consequently eventually gravitate to an inactive status upon reappointment. Credit hours for reappointment are granted at the rate of seven hours for each day of active duty.

The amount of active duty training is limited by the lack of funds appropriated for this purpose and the shortage of regular army units and personnel to conduct training. As now given, active duty training is considered to be both essential and practical. The number of officers who may benefit by it are being slightly increased by three expedients. One of these is by reducing the proportion of field officers, since the active duty pay of a field officer will be sufficient for the pay of two junior officers. Another expedient is the attachment of reserve officers to units of the National Guard while in camp. This is done with the concurrence of the national guard authorities, and promises to provide for the field training of over 2000 reserve officers each year. The third expedient is by having the reserve officers conduct the C. M. T. Camps, which is the nearest approach to training in the duties they would be required to perform in mobilization. As regards the effect of this latter policy on the C. M. T. C., Major R. E. Lee, General Staff Corps, has testified as follows before the House Sub-committee on Appropriations.

“When this idea was first promulgated we in the training section of the General Staff were very critical of it, because we thought it might injure the C. M. T. C. and that they would be used more or less as a chopping block for the reserves. A very careful estimate, based on a great many inspections that made the first year the plan was in effect, led to the belief that the efficiency of the C.M.T.C. boys was about 20 per cent below the efficiency of the training under straight regular army instructors. The Citizens' Military Training Camps Association was also rather afraid of it. We agreed, however, to try it out for another summer. At the end of this last summer not only had it apparently worked out very well, but the Military Training Camps Association were reconciled to experimenting further and instead of the training camps enrollment falling off, the number of applicants increased. We are not entirely committed to it yet but if at the end of three years it seems to work, I think it will be adopted permanently.”

The test, as Major Lee further states, is whether the improved training of the reserve officers more than offsets the reduction in the perfection of the C. M. T. C. training, considering the entire national defense project as a whole.

Inactive duty training consists of extension courses, conferences, group schools, and other forms of instruction in military subjects. Of these the extension courses are by far the most important. During the school year 1929-30 more than 38,000 students were enrolled in the various army extension courses, of which 25,000 were Reserves. During that year 22,000 students completed 35,000 subcourses, representing a total of nearly 800,000 hours of work.

If this training were equally distributed among all

“active” reserve officers, it would average two weeks active duty training and something over thirty hours of inactive duty training every three years, which is just about sufficient to qualify the officer for reappointment on an active status. Actually the interest displayed by different officers varies considerably, some doing nothing while some officers have received the equivalent of a full month’s active duty training each year (half without pay) and others have completed as much as 15 extension subscribers in less than a year totaling well over 200 hours of work.

Of the 80,000 “active” reserve officers, approximately 42,000 took some form of training during the last fiscal year, including 11,000 who had only active duty training, 11,000 who had active duty training as well as some form of inactive duty training, and 20,000 who completed extension courses or attended conferences but were not ordered to active duty. In addition, during the last ten years a total of 1,773 reserve officers have taken the special two to three months courses at the various service schools.

#### Conclusion

Some officers are inclined to be skeptical as to the value of the Reserve Corps. It is estimated that the military instruction received in the R. O. T. C. is equivalent to but approximately four month’s continu-

ous training, as compared to the average period of one year’s continuous military training required of candidates for reserve commissions in most foreign armies. Also the training received by the average reserve officer after his appointment is much less than the several months with the colors required of the reserves of other great nations. These facts must be recognized and provided for in our training schedules effective on mobilization. But on the credit side of the ledger we have a Reserve Corps of 100,000 partially trained officers, already commissioned, and the majority assigned to units, ready to step into their assigned places. Compare this with the conditions that existed in 1917. As to the duty of the Regular Army to the Reserve Corps, the Secretary of War, in his last Annual Report, states:—

“The Reserves form a very important part of our system of National Defense. Only our best regular officers should be detailed for duty with this component. The standards to be met by our reserve officers must be high, so that the system built up shall be thoroughly dependable, while the reserve officer himself must enjoy the complete confidence and respect of his brother officers is all components of the Army, and especially of the people of the community in which he lives.”

### What Can We Do About It?

“THE American Army is entirely inadequate, just as it was in 1917 when an emergency demanded quick action. At that time, it will be remembered by those whose memories are at least 13 years long, the United States was the laughing stock of the world with respect to its military establishment. We highly resolved after the waste of billions of dollars never to let it happen again.

But it is happening again. We have no Army beyond a skeleton. Our Navy is undermanned and in every conference for disarmament we sit at the foot of the table and are out-niggered when the cards are exposed for inspection.

At his retirement a few weeks ago, General Summerall called the country’s attention to the status of the Army. He made a comprehensive report to his superior officer, the President. A few newspapers pointed a warning, but most of the editorial comment was of the shoulder-shrugging variety; indeed, a lot of it was inimical to the Army and to the best traditions of a country whose military exploits have been worth reading about until recent years.

What do you intend to do about it? Listen to written and radio arguments for pacifism? Let designing agents of a sinister foreign power dictate to half-baked preachers and “parlor pinks” the speeches and essays which lead us to believe the millenium has been reached? Or will you stand up on your hind legs like a man and demand some sort of a military structure which will be available for the next emergency which is a lot closer to us than some of you folks realize, and don’t you forget it?”

*From an editorial appearing in The Nebraska City Daily News-Press.*

# Saving Prospective Reserve Officers

*Lieutenant Colonel George W. Fisher, C.A.-Res.*

ONE of the problems that must be solved if the Junior R. O. T. C. and the C. M. T. C. are to fulfill their mission of developing junior officers for the Officers Reserve Corps, is how to keep the graduates of those organizations interested in military training and national defense from the time of their graduation until they are eligible for commissions.

Those who graduate and continue their academic work in universities with Senior R. O. T. C. units are provided for. Their admission into the O. R. C. usually comes in due time, with the completion of their university work.

But what of the thousands of enthusiastic boys of about eighteen years of age who go from high school into the business world?

The United States government annually spends thousands of dollars on these Junior R. O. T. C. and C. M. T. C. members without getting adequate return for the expenditure. This is not entirely the fault of the young men. Many of them have been student officers, and a great many have attended one or more C. M. T. C. They have been greatly interested in their work, and are the best possible officer material. The same applies to the graduates of the C. M. T. C. However, under present conditions, if at the age of eighteen they have completed high school and shown enthusiasm and aptitude for military training, they are discouraged from carrying on their training because the laws of eligibility bar them from the O. R. C. until the age of twenty-one.

Because there is no place for them in the present scheme their interest is soon lost, and once lost it is almost impossible to regain. This loss of interest in things military cannot be taken as an indictment of patriotism. The transition from high school into the commercial world absorbs the young men's attention. At the present time practically nothing is done to retain the military interest of these thousands of potential officers until they reach the age that makes them eligible for O. R. C. commissions.

It is the practice in one Corps Area to send the names of graduates of the C. M. T. C. to reserve organization commanders, so that they contact them and endeavor to interest them in the Reserve Corps. But what have we to offer them? The only opening is in the E. R. C., from which, after reaching the age of twenty-one and completing certain correspondence courses, they may become commissioned.

The E. R. C. is practically non-existent and, so far as a candidate for commission is concerned, offers no advantages in obtaining further training. Other than the fact that its members are carried on the rolls, it means nothing. Members of the E. R. C. do not get to training camps. The only training that is available to them is through correspondence courses, and

they could have that without belonging to the E. R. C., since civilians are also permitted to take these courses.

So it is not remarkable that graduates of the Junior R. O. T. C. and C. M. T. C. do not care to enlist in the E. R. C. They have just completed four years of varied training and are rewarded with the grade of private, and not even a chance of actively serving in that grade. If their interest is to be kept high they must be given due recognition for the work that they already have accomplished and, at the same time, offered an opportunity for constant active participation, on a basis that is considered a promotion, until they are eligible for commissions.

This condition has resulted in the loss to the Reserve Corps of thousands of prospective good officers who could have been obtained with little inducement and small effort.

We must recognize the fact that they will not enlist in the E. R. C.; that as graduates of the Junior R. O. T. C. and C. M. T. C. they feel, and rightly so, that they are entitled to promotion; that as candidates for commissions they should have standing as such. While a reserve commission is a mark of distinction, it entails considerable sacrifices on the part of the holder, and the path to a commission should be made as attractive as possible.

It is believed that the following plan will overcome the principal objections to the present scheme, and will retain the interest of graduates of the Junior R. O. T. C. and C. M. T. C. during the period when they are most likely to lose that interest:

1. A separate corps to be organized, to be called the Aspirants' Corps, or some similar name. This to be composed of graduates of the Junior R. O. T. C. and the C. M. T. C. who are under the age of twenty-one years, and who desire further training that they may qualify for commissions in the Reserve Corps.

2. The aspirants to wear a distinctive badge, chevron, or hat cord, so that they may be readily distinguished from officers and enlisted men. This separate corps and distinctive badge will aid in satisfying the desire and personal pride of the candidate. He will belong to an organization that is a separate but integral part of the Army of the United States, and known to be composed only of potential officers.

3. There should be two classes of aspirants: junior and senior. Junior aspirants should be below, and senior aspirants above the age of twenty years. Graduates from the Junior R. O. T. C. or from the Blue Course of the C. M. T. C. should be offered aspirants' commissions in the class suitable to their ages. As soon as a junior aspirant reaches the age of twenty years, he should be transferred to the senior grade upon request.

4. Classification of aspirants by grade not only

will differentiate ability because of age, but will provide an easy manner of dropping members who are inactive and who have lost interest. Junior aspirants, upon reaching twenty years of age and eligibility for the senior grade, may automatically be dropped from the rolls if their records reveal inattentiveness to obligations of the Service.

5. Senior aspirants should be eligible for attendance at reserve officers' camps, where they may have the status of warrant officers. Junior aspirants should be eligible for use as noncommissioned officers in the C. M. T. C.

6. These opportunities for actual training at either reserve officers' camps or C. M. T. C. will correct what is at present the most serious obstacle for continued interest. The aspirants not only will be kept interested, but their training will be advanced with their increasing age. By the time that they become eligible for commissions they will be qualified.

7. When a senior aspirant reaches the age of twenty-one years, he should be eligible for a reserve commission. But before being commissioned he should prove his qualifications either by passing an examination such as now required for a Reserve Commission, by having completed a prescribed number of correspondence courses or by having a sufficient number of hours accredited by attendance at camps, either as junior or senior aspirant.

8. Aspirants of either junior or senior grade, while on active duty, should receive the pay of a flying cadet.

It is realized that the plan outlined above would require legislation to carry it into effect, but as the present plan has proved a failure, some other must be tried or the Junior R. O. T. C. and C. M. T. C. left out of consideration in the scheme of National Defense as far as being a source of supply of officers for the Reserve Corps is concerned.



The Firing Point of the 212th at Fort Ontario, N. Y.

# Superstitions of Samar

Lieutenant T. Q. Ashburn, Jr., Coast Artillery Reserve

THE last eclipse of the moon in the Philippine Islands caused a great deal of excitement in the town of Basey. I had just arrived in Samar, visiting unusual and out of the way places, with my Illoeano boy, Agrapino Dumlao, from the Province of Zambales.

Hearing a terrific hullabaloo outside, we dashed into the narrow, dirty, main street, and found the majority of the population parading up and down, beating tin pans, dragging old cans in the dirt, ringing bells, clapping boards together, muttering incantations moaning, and shouting at the top of their lungs. It sounded like Dante's inferno with its never-ceasing din and clatter which kept up until the moon shone clear again. The streets were crowded with pregnant women, walking back and forth, back and forth, never stopping, never resting.

"Agrapino, what is the matter with these people? Have they all gone crazy? What is it all about?"

"Oh, sir," he replied, his large eyes shining with excitement, "The moon is in mortal combat with a great monster which is trying to eat her!" "But why all this noise?"

"Sir, they are giving the moon encouragement and frightening away the monster. If the people give the moon assistance, she will send them bounteous harvests and much good luck."

While Agrapino was talking I noticed the look of stark terror that hovered in all the women's eyes. The boy seemed to read what was going on in my mind.

"They keep moving because a pregnant woman is an object of revenge for the moon-eating monster. If he does not destroy her unborn babe, he will at least cause her great pains at childbirth. If they keep moving, he has great difficulty in placing his curse upon her."

Agrapino seemed to know everything so I asked, "Why do some of the women sit by tins of water?"

"Oh, sir, they are from the South of Samar where they believe the monster is a fish. After his fight with the moon, he will be so exhausted that his desire for water will overcome his desire for revenge and he will plunge into the tin of water instead of into the pregnant woman."

Just as the little Illoeano finished, the moon suddenly shone clear again. There was a final triumphant shout from the population and the noise ceased abruptly, as if a pin had been stuck in the balloon of abandon.

This incident so aroused my interest that I determined to go into the mountains, cross the island on foot and by banca, and investigate thoroughly these curious superstitions.

The next morning, I hired two guides, both old men, well versed in the country and its folk-lore, and

the four of us set out in quest of we knew not exactly what.

At the foot hills of the mountains we were overtaken by a tropical storm and forced to seek shelter in a nipa shack mounted on bamboo poles, while the wind outside howled and stormed and the heavens seemed to have been engulfed by a great tidal wave, overflowing onto the earth. The nipa shack rocked and swayed before the force of the gale while the creaking of the bamboo sounded like the wail of a soul in agony.

Suddenly, from the woods came a low, weird whistle. My companions shivered in fear. Trembling, they huddled together. In a flash of lightning, I saw them cross themselves.

"What's the matter?" I asked.

"Ooo, it's the Agata!" they moaned in terror. "He is seen only at night, when he sometimes whistles. Did you not hear him? Oh, sir, we had better not go into the mountain fastness, for that is where he lives!"

"But what kind of creature is this Agata?"

"Why he is the ruler of all the animals. He is black and hairy, like a man, but his hair is long like a woman's. He can change his size at will, making himself a giant when he wishes to cross a river at one step, or small as a man's thumb when he desires to hide. Oh, sir, do not risk the Agata's wrath by traveling in his sacred country!"

"Nonsense!" I replied. "What would the Agata be doing out on a night like this?"

"He is hungry and seeks chickens to pierce through and through with his long finger nails. When he



Moro Warriors, Jolo.

finishes, he leaves many bloodstains about. Maybe if there is no chicken's blood to drink, he will seek ours!" Frantically, they crossed themselves again.

From below the house came the cackle of an excited fowl, rising shrilly above the storm. Then silence except for the steady torrent of rain which dripped from the eaves of the roof.

"Has the lieutenant a match?"

I tossed them a box of matches, and, shaking as if from the ague, they started a small fire in an urn which stood in the center of the room. The flame flickered and went out in a gust of wind. There was no



Caniau Busul, Bontoc.

sound except the chatter of their teeth. Nervously they glanced about as if they suspected the Agata of having blown out the fire. When I remembered this monster could change his size at will, an unaccountable chill stole over me. With trembling fingers, I myself, lighted another match. This time the spark sputtered and burst into flames. The natives grouped about me sighed in relief as the interior of the hut was again illuminated.

"That Agata is afraid of fire and is in mortal terror of a priest," they explained. "Even a tiny cross will keep him away if he is not too hungry."

The next morning, after the storm had died away, we found many bloodstains under the house but no signs of the chicken. When we finally crossed the mountains and arrived in Catubig Valley, we found every house was covered with small crosses made of cocoonut and nipa leaves. In the town of Catubig, every house had a cross, sketched in white or yellow chalk, over the doors and windows. Evidently, the Agata had traveled far during the night.

On our trip up the mountain, we came to a clearing in the woods where a mango tree was in bloom. The fruit was ripe and looked luscious. I started to reach for a mango, when Agrapino, hastily, pulled me by the sleeve. I turned on him and demanded what he meant. He pointed to a bottle, stuffed with over-ripe meat and leaves, hanging from a branch of the tree.

"What's that got to do with it?"

"Oh, sir, it is amog that the owner practices! He has been robbed of fruit from that tree before and has now put up amog. If the lieutenant eats any mango from that tree, after the amog is hung up, the lieutenant's belly will swell up and burst!"

I gathered that the only charm against the amog was not to touch the fruit. This seemed to me a very effective way of locking the stable door after the horse has been stolen.

When we arrived in Catubig, we found a crowd gathered around a dead man. Upon investigation,

I learned that he had been struck by Se Mangray Hangin, a breath of bad wind which turns a person black and kills him. From a layman's point of view, the man had died from heartfailure, but I couldn't make these people believe in any other cause of death but from Se Mangray Hangin. In the crowd gathered about, charms against this dread bad wind were very much in evidence. The greatest charm against this evil is the back tooth of a crocodile worn about the neck as a pendant although I noticed many tortoise shells worn also. The guides explained that the older generation swear by the crocodile teeth while the younger generation endorses the tortoise shells.

While in Catubig, we heard rumors that a man named Pascual, who lived in Cananid, was under the influence of Impacto. Further inquiries disclosed the fact that an Impacto seems to be a combination of our Pied Piper of Hamelin and the enchanting sirens who lured Ulysses to destruction. Eager volunteers informed us that it was a spirit or fairy of the woods, with dazzling white skin and incomparable jewelry, whose appearance induced men to walk in their sleep



Dancing Igorote, Bontoc.

and to follow her into the forest. Should any man displease the Impacto by not succumbing to her beauty he would be driven insane.

Acting upon this information we went to Cananid and arrived there at the psychological time. We found a large crowd gathered about a tree on a branch of which sat Pascual. Everyone seemed to be urging him to come down, but all to no avail. Agrapino found, by quick questioning, that Pascual had walked out of his house the evening before, and without saying a word to anyone, had climbed the tree, where he had remained ever since. Nothing would induce him to descend until an old hag, resembling an old scarecrow more than a human being, approached on her knees, spitting between crossed fingers at every step and reciting mysterious orations.

When Pascual saw the old woman, he docilely came down from his tree and returned to his home, followed by the joyous population. Later, we learned that this old woman, who possesses an anting-anting against the Impacto, is under obligation to go to the woods every Good Friday for prayer and contemplation in order to retain it.

# Events Overseas

Lieut. Col. Herman Beukema, Professor, U. S. Military Academy

EUROPE'S frayed nerves were subjected in March and April to a succession of heavy shocks. Coming with little or no warning when eighteen months of the most severe depression in history had lowered morale everywhere, they have plunged the Continent into a cold of black pessimism. The specter of a new general war, which has stalked Europe since 1918, gains substance as armament programs are stepped up and the recent hopes of progress toward real disarmament recede. In several dispatches appears the thought expressed by one correspondent that "the peace of Europe hangs by a hair."

However, in all the welter of doubt and fear no one has seen fit to declare just who is going to fight and why, where the money is to come from, what is to be gained. Moreover, the consensus of opinion discloses a Europe collapsing into chaos if such a war does materialize, with the greater specter of Bolshevism in its train. And finally, Russia, the single great power which at first glance would stand to gain most from such an outcome, actually foresees catastrophe for her experiment unless she can have some years of peace, and trade, to complete her economic reorganization.

The first of the shocks to European equilibrium may be labeled *Zollverein—Anschluss—Mittel Europa*. Without previous warning the German Foreign Office announced late in March the consummation of a Customs Pact with Austria which, in effect, would make an economic unit of those two countries. Anticipating the storm provoked by the announcement, the partners to the pact disclaimed any intent to create the political union—*Anschluss*—forbidden not only by the Treaties of Versailles and St. Germain, but more precisely barred by the protocols of an international convention signed by Austria, October 4, 1922, in return for an international loan of rehabilitation guaranteed jointly by Great Britain and France, Italy, and Czechoslovakia. Over that signature Austria agreed to maintain at all times her economic independence. Germany's bland declaration that the pact is but a step toward full consummation of Briand's proposed economic union, and the later indications that Hungary will join the *Zollverein* shortly, have only served to stiffen the resistance of the powers hostile to the arrangement. Unwillingly, Germany has finally consented to examination of the "legal aspects" of the pact by the League Council at its May meeting. Meanwhile, hard-pressed Rumania and Yugoslavia discover that their inclusion in the union would provide the sorely needed market for their surplus grain.

France has placed herself squarely athwart the road marked out by the former Central Powers. Almost in a day she sees the revival of that chimera of 1916—*Mittel Europa*. She dismisses the German avowals of an effort purely economic as mere subterfuge. This

to France, is *Anschluss*, and beyond it tomorrow, Germany would weld a solid block of powers from the Baltic to the Adriatic and the Aegean under her hegemony. Gone, then, status quo under the war treaties, gone France's preponderance in European affairs. Germany's declaration that she will insist on her right to rearm, unless the 1932 Disarmament Conference produces a wholesale scaling down of Europe's armed forces, adds color to French fears. Forced into a defensive role by the turn of events, France has retaliated by proposing anew her European Customs Union, with Germany and Austria barred. But at best she can count with certainty on but two allies in such a venture, Czechoslovakia and Poland. The situation promises a warm session for the League Council in May. Doubts appear as to the advisability of smoking out Germany's true aims and objectives in the matter. With the *Journal de Genève* making the interesting discovery that the pact is merely a German bogey thrust forward as a bargaining device to advance her intent to rearm, with France apprehensive of the collapse of the safeguards to her security, and with all Europe demanding some arrangement which will strike at the roots of economic depression, the Council faces a major problem.

A second bombshell exploded in the European camp when it was discovered that someone was guilty of a grievous blunder—or trick—in connection with the Franco-Italian naval agreement. Unknown to Italy, France had reserved the right to make substantial replacements of obsolescent vessels—too substantial for Italy's peace of mind. With that disclosure Italy's approach to parity by virtue of France's inclusion of many older vessels in her total tonnage, whose aggregate was materially larger than Italy's, disappeared. Great Britain's secretary of state for foreign affairs, who had acted as principal intermediary in securing adhesion of the two powers to the London Naval Agreement, appears as a scapegoat, in that he is charged with failure to inform Italy of France's intentions as to replacements. Today the entire question has reverted to the deadlock which dates back to the London parley.

The sudden collapse of monarchy in Spain, April 14, following the overwhelming victory of the Republicans in the elections of April 12, proved unexpected—in that it has been expected so long. The ejection of the House of Bourbon and the accession of a "Provisional Republican Government" is the least of this sum of troubles. What worries the neighbors of Spain, both near and far, is the ultimate outcome of that country's fourth effort within a century to find a political and social formula short of absolute monarchy or dictatorship which will unite the widely divergent elements of the nation in a common effort toward stability, both political and economic.

## The British Empire

**United Kingdom.** The traditional dogged steadiness of the Briton in the face of adversity has rarely been illustrated so well as in the past two months. Moreover, the events of that period dispose of the fiction that that saving virtue is a monopoly of the "ruling classes." With Labor at the helm, the Government survived its long-standing, now acute, financial difficulties, made progress toward a sound solution of the Indian problem, and appeared as an effective, though somewhat bungling, stabilizer in a hectic Europe.

March was marked principally by efforts toward party solidification in the preparation for serious tests in April. In the fashionable St. George district of Westminster, ex-Premier Baldwin fought it out in a by-election with Lords Beaverbrook and Rothermere, Captain A. Duff Cooper, the Baldwin candidate, winning by a handsome majority. Baldwin had staked his leadership of the Conservatives on the issue, and winning, found it easy to effect a reconciliation with Beaverbrook. A questionable and unsuccessful effort of Lord Rothermere and Winston Churchill to discredit Baldwin on his Indian policy left that pair as leaders of the dwindling group of Conservatives in revolt. In the Labor group, the ousted Sir Oswald Mosley carried with him a following of six members. On the whole, the parties went to the test on April 16 with their ranks stiffened. Labor then defeated the vote of censure by a margin of 54 votes, the Liberals again furnishing the needed support. Obviously, the Conservatives prefer to synchronize their definite bid for power with an upturn in business—and that still lies in the future.

Recognition of disturbed conditions in Europe is seen in the clear-cut announcement of the Secretary of State for War, Mr. Thomas Shaw, that Great Britain will no longer take the lead in disarmament by cutting down her own defenses. Present strength of the army, he declared, must be maintained at all costs. The pronouncement is a far cry from the Labor platform of 1929, a fair measure of Right Wing Labor's development under the spur of responsibility. Budget estimates for the next year show a small reduction in both military and naval expenditures, and a moderate increase for the Royal Air Force, chiefly for the army contingent. Reductions are largely accounted for by the lowered cost of supplies.

The Snowden budget, presented to Parliament April 27, was at least effective in dispelling the pessimism with which it had been awaited. Just so, the balance sheet which accompanied the budget. The expected deficit was there, but its amount, \$111,780,000, is more than balanced by the funds devoted to debt reduction during the year, \$206,550,000. Mr. Snowden could argue rightly that no other country could show a better result for the year's operations. Moreover, a balanced budget is indicated for the new fiscal year by resort to three expedients: advance collection of income tax; withdrawal of part of the dollar purchase fund maintained for the exchange operations in America; increased gasoline tax from 8 to 12 cents per gallon, boosting the retail price to 32 cents.

Successive weekly decreases in unemployment figures since the peak of March 9 inspired moderate hopes. Of equal importance is the abrupt termination of the outflow of gold in March, and reversal of the current in April. The change occurred only when British reserves had reached a point dangerously low.

**The Dominions.** Deliberate default by New South Wales on April 1, when interest payments on its bonds aggregating \$3,500,000 fell due in London, provoked a financial crisis which for a few days threatened Australia's credit abroad. Prompt action by the Commonwealth government in providing the needed funds, as well as other millions due some days later, removed the threat, at the same time bringing to head a political crisis. Briefly, Premier Lang, an embittered (though moderately wealthy) Socialist, is leader in a movement for wholesale repudiation of all Australian obligations. His program entails "nationalization" of all property. Ample funds were available to the credit of his State in both Australia and London when the interest fell due. No question of bankruptcy existed. He was simply acting true to the tenets of all practical Socialists in meeting debts with the device of repudiation.

Faced with legal action by the Commonwealth to collect from New South Wales the funds advanced in London, bitterly condemned by the premiers of the other States, and threatened with a separatist movement in his own, Lang continued to trumpet about the Continent in his campaign to discredit the Scullin government. His mad course finally brought about a run on the State Savings Bank, a \$100,000,000 institution, closing its doors.

Meanwhile the Commonwealth senate blocked the Scullin program of financial inflation when it voted to reject the government bill authorizing the issue of \$90,000,000 for agrarian and unemployed relief. As a result, a general election is probable, but not before July 1. The electorate will then apparently have three choices open. The Nationalist Party, led by T. A. Lyons, stands for strict honesty in finance. Premier Scullin heads the inflationists, with Lang the leader of the radical repudiation element.

Application of the divisions of the Imperial Conference are in progress. Ireland has adopted its own seal to replace, on state documents, the Great Seal of the Empire. Its relations with England are direct with the King, personal conference with His Majesty replacing approach through the Ministry for the Dominions. In Canada legislation to set aside the validity provisions of the Canadian Organic Law (British North America Act) has been introduced in Parliament and approved by provincial governments.

**Foreign Relations.** Recent weeks have produced a distinct sense of strain in Franco-British relations. The impossibility of reconciling their separate aims in international matters has resulted in the wrecking of three important British projects—Franco-Italian adhesion to the London Naval Treaty, a European tariff truce, and a four-power conference of foreign ministers in London. France's part in blocking Mr. Henderson's efforts is clear. Her grievance arises not only from Britain's refusal to parallel her strong line in condemning the Austro-German Customs Pact, but to

a greater extent the British invitation to Dr. Bruening and Dr. Curtius for private conference in London on these matters. Whether France fears or senses a divergence of the French and British orbits in European affairs, and is taking steps in reprisal, will appear at Geneva in the coming weeks.

**India.** Communal riots at Cawnpore, the bloodiest incident since the Sepoy rebellion, furnish increasing proof that Hindu and Moslem cannot live peaceably together except under the control of foreign machine guns. In this instance, the Hindus were the aggressors. The affair has failed to check the preparations for the third Round Table Conference, scheduled for this Fall. Mahatma Gandhi succeeded beyond his hopes in securing approval of the All India National Congress, March 30, to his truce with Lord Irwin, principally because of his declaration that whatever form of government eventuates from the Round Table, it will be but a step toward complete independence. Indianization of the army proceeds at all too slow a pace to suit the radical theorists. A new obstacle appears in the native soldier's preference for the British officer.—R. B. RANSOM, *Captain, Infantry*.

## Western Europe

**League of Nations.** The Austro-German Customs Pact has precipitated the most severe test of the vitality and usefulness of the League of Nations since the birth of that body. Moderately successful so far in settling and preventing the quarrels of petty states, the League now faces a major problem, affecting every power in Europe. Prompt decision is not looked for; in fact, the Council is expected to call on the World Court for an advisory opinion before taking definite action.

Meanwhile, economic pressure, that major irritant which is primarily responsible for the unrest and revolutionary outbreaks of the past year, is behind the plan drafted by the finance committee of the League for an international agricultural credit bank. The further proposal to provide loans at six per cent, in contrast with the rates of twelve to twenty per cent prevailing in Eastern Europe, is designed to lift the price of bread grains to a level where production will again be profitable. Unfortunately, the scheme falls down unless the cooperation of the leading wheat export countries—the United States, Canada, Russia, and Argentina—can be enlisted in the restriction of output.

The agenda for the May meeting include further preparation for the 1932 Disarmament Conference, now thrown into the background by the Customs Pact snarl. Of immediate interest to the United States are indications that steps will be taken in that field shortly to limit the tonnage of battleships to 23,000 tons, or thereabout. France, Italy, and Japan find their foreign possessions comfortably within the steaming radius of such a vessel. Britain, with her chains of naval bases, is in a similar position. The situation leaves the United States as the sole defender of the 35,000 ton battleship.

The Bank for International Settlements, closing its fiscal year March 31 in a period of unprecedented world depression, was able to set aside 5 per cent of profits as a legal reserve, and to declare a dividend of 6 per cent. The earnings are insufficient as yet to furnish help to Germany in meeting reparations payments.

**France.** The rôle of scapegoat falls once more to Foreign Minister Aristide Briand. Assailed in the nationalist press for his German policy of rapprochement which, it is charged, has led directly to the Austro-German Pact, he refuses to give comfort to his enemies at home by resigning. The government continues to make moderate loans to the members of the Little Entente, hoping to strengthen the bonds which hold them to France. But the real difficulty finds expression in the Yugoslav press: "We cannot be helped much by small loans, while being bound to arbitrary borders. What is more important is the chance to sell our products."

Further bolstering of her allies appears in France's undertaking to complete the rail lines from the coal area of Upper Silesia to Poland's artificial seaport, Gdynia. France is advancing the money and in return gets joint control with Poland over the road. That action raises a new bulwark against the treaty revision desired by Germany to restore to her the Polish Corridor.

Expenditure of 29,000,000 francs on the improvement and extension of the port of Arzeu, Algeria, represents one more step in the French effort to assimilate and digest her African empire. In addition, the project to stretch a rail line across the Sahara to French equatorial Africa has been advanced considerably in the past two months, in spite of the fact that the prospects of inviting participation of foreign capital is shoved into the background for the time being as a result of the international irritations in April.

The French gold hoard is at last being reduced. In part, foreign loans account for the outflow, but normal exchange operations must explain the shipment of \$19,000,000 to the United States the last week in April. It is the largest sum received here from that source in a single week since the stabilization of the franc in 1926.

**Spain.** "A republic in Spain would become such a hodge-podge of confusion that a king sooner or later would be welcomed as a savior." It is possible that the ex-king Alphonso XIII had in mind those words of Unamuno when he prepared his statement of April 13 to the Republican leaders, declaring "I do not renounce any of my rights. They are the accumulated store of history \*\*\*." Those are not the words of abdication. Yielding to the force of events when the elections of April 12 produced an overwhelming republican majority (in the cities), he stepped aside to let a "Provisional Republican Government" take charge. He recalls the three preceding abortive attempts within a century to establish a republic in Spain. He bears in mind the make-up of the Spanish nation—small aristocratic top, broad bottom marked

by a poverty-stricken and land-hungry peasantry, an equally impoverished proletariat in the cities, a small and voiceless bourgeoisie, a turbulent and dangerous admixture of students and intellectuals. He does not believe that this is the stuff of which republics are built, but instead that it calls for a dictator's rule. Finally, he realizes that the anti-monarchical vote is merely an expression of the cities' sentiments. The villages are still bound to church and king. And he can foresee for the Republic just such a failure as once placed his father on the Spanish throne. Why should not history repeat itself in this instance?

Meanwhile, the new government under President Niceto Alcalá Zamora is about as satisfactory to the radical elements of the Spanish cities as was Kerensky's to the Bolsheviks. Their May Day efforts toward a radical stampede in Barcelona and other cities were put down after considerable bloodshed.

Elections to a constituent assembly are ordered for June 21. Separatism, which manifested itself as soon as the election results had been announced, appeared in Catalonia's demand for practical autonomy within a federal system. In spite of censorship, similar rumblings are heard from no less than four other states. The peseta, barometer of national and foreign faith in the new order, dropped almost to its record low shortly after the elections. Recently, it has staged a moderate advance, apparently as a result of government intervention in the exchange market.

**Portugal.** Revolt against President Carmona's undisguised dictatorship, breaking out late in March, is still flourishing, more than a month later. At Funchal, port of the Madeira Islands, rebel troops await the advance of a mixed government force. At Lisbon, the police dispersed a May Day mob with machine gun fire, whereupon the entire cabinet, apprehensive of more serious trouble, sought asylum in the barracks of the 3d Artillery.—DONALD A. FAX, *First Lieutenant, Infantry.*

## Central Europe

**Germany.** Has Hitlerism shot its bolt? Public opinion in Germany and elsewhere examines the results of the last session of the Reichstag and scans the local election returns as they appear, for an answer to the question. Obviously, the internal dissension within the ranks of the National Socialists, as brought to a head by Hitler's expulsion from the party of Walter Stennes, head of the "storm troops" of northern Germany, has proved a setback to Fascist plans. Hitler, trying to carry water on both shoulders to hold in line his revolutionary extremists while he bids for support of adventurous elements allied to the moderate parties, meets varying success. In some sections, municipal and state elections show a steady swing away from Fascism's high tide of last July; in others, the party records heavy advances. On the whole, it is not clear whether the Fascist tactics in bolting the Reichstag in February, and in subsequent attacks against religion throughout the country, have permanently crippled their cause. The vigorous reprisals

of the Church against both that party and the Communists have damaged the Hitler program, especially in Bavaria, the birthplace of Fascism.

Having succeeded beyond his hopes in getting Germany through a trying winter, President von Hindenburg signalized the end of the Reichstag session by invoking Article 48 of the Weimar Constitution to establish temporary dictatorship again. Under his decree the "fundamental rights" of civil liberty are suspended for an indefinite period. In short, freedom of the press, speech, and assembly are left in each instance to the discretion of the police. The measure was aimed at both the Nazis (Fascists) and the Communists, whose constant fighting was marked by a total of 300 killed and many more hundreds wounded within a year—gang warfare which had begun to interfere seriously with business. From Hitler, who had promised with gusto a dictatorship in which "hundreds of heads will fall," comes an outburst which savors of a whine, demanding the resignation of "so ruthless a dictator as Hindenburg." The strongest reliance of the President in the past hectic year has been Heinrich Brüning. A year ago an unknown, today the "Iron Chancellor," he has handled Reichstag and state with the skill and courage of a finished statesman. Staking everything on securing a working agreement between the Social Democrats and the Center, he prevailed on the Reichstag to pass the measures most vital to Germany's immediate interests. The nation's finances have been placed on a sound basis, agricultural relief is established, and national defense is secured. In the latter category is found the initial appropriation for the construction of the Ersatz Lothringen, Germany's second "pocket battleship."

A moderate upturn in business, reducing peak unemployment figures at a rate almost double the seasonal figures, gives ground for hope. Of greater importance is a trade agreement with Russia calling for delivery to the Soviets of machinery and other producers' goods valued at \$75,000,000. Credits varying from 14 to 29 months, guaranteed in part by the Reich, cover the transaction. Germany's gain here is distinctively America's loss.

**Italy.** The apparent break-up in the Franco-Italian negotiations over naval restriction, referred to above, finds Italy and Great Britain in substantial accord, and France in the uncomfortable, if adamant, stand of safeguarding her needs regardless of the effect on her rivals. In spite of appearances, the issue remains alive, with deadlock no final bar to later compromise.

Like Germany, Italy is rapidly developing her trade with Russia. Goods exchanged under the January agreement have exceeded the totals contemplated so far that a superseding arrangement has been effected, providing for a 75 per cent increase in trade with the Soviet government. A minimum of \$18,000,000 worth of goods is to be exchanged, the Italian government advancing to its industrialists 75 per cent of the export value of merchandise shipped. In turn, the Soviet government receives long-term credits. Of

military interest in an item of 75 hydroplanes of the type used by the Italian fliers under General Balbo in their flight to Brazil, to be delivered to Moscow on rush order. Another item calls for 2,000 Italian motor trucks. The financing of the scheme, with Rome carrying the burden, is ample evidence of the straits in which Italian business finds itself. With small and wholly inadequate reserves of wealth to fall back on, Italy is hit far harder than her neighbors by the prolongation.—OTTO L. NELSON, *First Lieutenant, Infantry*.

### Eastern Europe

**Russia.** Is *pyatiletka* succeeding? Adept in persuading their half-starved millions and their sympathizers abroad as to present and future success of the Five Year Plan, Stalin and his followers find it impossible to conceal the dangerous rifts in their scheme from the eyes of the impartial observer. Transportation, according to the state-controlled *Pravda*, falls 25 per cent behind the expected program; coal, 43 per cent, with a precipitous drop in output since January 1. The difficulty lies in the refusal of the workers to accept the intolerable working conditions in the mines. Worse news still in steel. The most signal failure, perhaps, occurred at the Stalingrad tractor plant, scheduled to produce eventually 150,000 tractors per year. Output fell to a few hundred, with 80 per cent of all castings going to the scrap heap. From Germany comes the news that Moscow, having dumped everything saleable on a depressed world market, was unable to meet her payments abroad without shipping a considerable part of an already inadequate gold reserve. The German Reichsbank was the immediate beneficiary of those shipments. At that juncture Moscow is relieved to find Berlin and Rome willing to advance longer credits than those hitherto granted. And now Russia reverses herself in the matter of dumping wheat. Her exports of 110,000,000 bushels in the 1930-31 crop year has disposed of her surplus, but at a price which must spell heavy loss to that country. Stalin, with the figures before him, becomes interested in crop control to restore production to a profitable basis.

General adoption of a piece-work wage system in agriculture as well as industry marks one more acknowledgment by Moscow that capitalism's tools are indispensable in the working out of communistic theories. With it is installed *khozraschiot* (economic accounting), under which each factory, farm, and economic unit becomes an "individual." And each is ordered to pay its own way in the future. \*

Recalling the 40-year preparation of Germany for "The Day," is an order requiring the "militarization of literature." Everything in print, from primary reader to lyric poetry, must sing the praises of the Red army and preach the campaign against the capitalistic countries. Other developments of note include a new drive against the Kulaks; increased collectivization of farms, now reported to have passed a mark of 50 per cent of all arable land; extension of foreign boycotts against Russian goods, and Russia's reprisals

as shown above by doing her marketing elsewhere (Germany and Italy); and the recall to influence of Rykov, the leader of the Right Opposition who was ousted last fall. It is a chastened Rykov, however, who rejoins the Central Executive Committee.

Of chief importance is the fact that Moscow has weathered its heaviest test to date during the past winter, and the greater fact that peasant and proletariat, far from seeing improvement in their condition as the millenium year (1932) approaches, sense the growing poverty of individual and state. An even greater test still lies ahead of Moscow.—GEORGE M. BADGER, *First Lieutenant, C. A. C.*

### The Balkans and the Near East

**Rumania.** Early in April a demonstration in the Russian Chamber of Deputies against Minister of Industry Manculescu, a favorite of King Carol, led to the fall of the Peasant party cabinet of Premier Mironescu. From England, Carol summoned Minister Titulescu to form a new cabinet. Observers felt that opposing parties would prevent the formation of a cabinet, that the ruler has knowingly given an impossible task to Titulescu, upon whose failure, he, Carol, could proclaim a dictatorship.

Titulescu, however, managed to reconcile the warring parliamentary factions and offered a strong cabinet for the King's approval. But the monarch, reported to have been urged on by his paramour, Magda Lupescu, demanded the inclusion of several favorites in the ministry. Titulescu resigned.

Carol's dictatorship dream, fostered by Alexander's apparent success in Yugoslavia, was disturbed by Alphonso's departure from one of the last absolute strongholds. At any rate, he called upon his ex-tutor Jorga to form a cabinet and the new premier dissolved the extraordinary session of parliament within a few hours after it had first met on April 30. Wild disorder and passionate protests greeted this coup, the deputies of the Peasant party shouting "Down with the Dictator." What the future holds depends to a great extent upon the new elections to be held early in June.

**Turkey.** Kemal has taken steps to strengthen the government's hold upon the younger generation by the commandeering and reorganization of the Turkish Hearths Society. The Turkish president, using Mussolini's junior Fascists as a model, will gather into the centers of the organization the nation's youth for patriotic education.

It may be of interest to note that, in line with the recent treaties of the Western European powers, Turkey and Russia have signed a naval accord limiting naval armaments in the Black Sea.—D. H. GALLOWAY, *First Lieutenant, Cavalry*.

### The Far East

**China.** Long-standing preparations for the National Peoples' Convention, scheduled to be held at Nanking May 5, encountered a snag a few days earlier

in the form of a new revolt against Chiang Kai-Shek. With Canton as headquarters, a disaffected group of Nationalists has declared against Chiang's "despotism." The Canton forces are mobilizing rapidly. General Ho Ying-chin, Nationalist minister of war, reported the desertion of two divisions, the 60th and 61st, with an additional brigade of the 12th Division, now moving south to join the Cantonese. Not only does the action precipitate a new armed test for the Nanking government, but it puts a temporary stop to Ho's operations in Kwangsi province against the ever troublesome Communists. In the past two months he has defeated the Reds in several engagements but is no farther advanced toward the elimination of his enemy than at the outset of his campaign. The peasant's lightning change of character from peaceful tillers of the soil to armed Communists, and back again, by the simple act of taking up a rifle and dropping it, had faced Ho with the necessity of exterminating the population of the five Red provinces—Kwangsi, Hupeh, Honan, Kweichow, and Kiangsi—or of admitting the absence of a solution. Even the reintroduction of the Pao-chia system, under which local communities are held responsible for banditry and communism within their borders, has proved of little value.

In spite of the turmoil besetting him, Chiang proceeded according to schedule with the abolition of the long-mooted extraterritoriality privileges of the Foreign Powers in China. A mandate to that effect was issued by C. T. Wang, Nanking foreign minister, on May 4 (a day in advance of the official opening of the National Peoples' Convention). Obviously, the date was chosen with an eye toward consolidation of Chinese sentiment in favor of Chiang Kai-Shek's political and military machine at a moment when unity is vitally needed to meet the double menace of the Communists and the Canton rebels. However, the provisions of the mandate do not take effect until January 1, 1932, at which time special divisions of the district courts are to be established at nineteen ports for the trial of all cases, civil and criminal, in which foreign nationals are involved. Holland and Norway surrendered their "extrallity" rights during April, but their action involves at most a scant hundred of their citizens. How far Great Britain, France, Japan, and the United States will move toward accepting for their nationals a jurisdiction in which bribery, torture, lettres de cachet, and other survivals of the Middle Ages are still extant, remains to be seen.

The second most important problem<sup>4</sup> facing the National Convention, from China's point of view, is the adoption of a constitution. The instrument has been in preparation under Chiang's direction for some months. Attached to it is a bill of rights, Chiang's special bid for the nation's support. Unfortunately

for Chiang, the purpose of such an instrument is beyond the understanding of all except the handful of foreign-educated Chinese. To make matters worse, both Canton and the Communists charge that the convention personnel is unrepresentative in that it has been hand-picked by Chiang and his lieutenants.

The difficulties under which the foreigner lives in China are illustrated by the report of our Yangtze Patrol for the eight months beginning last July. American gunboats during that period met 37 attacks. It is a record. And the Communists have learned that funds can be obtained by seizure for ransom of foreign missionaries, the American missionary being valued as a very high-priced commodity.

As Moscow's agents add to their successes, so the Soviet government grows increasingly provocative. Regardless of Chinese law, Russian goods, both raw commodity and finished product, are dumped into Chinese markets. Russian troops mass once more on the Mongolian border, waiting only for the necessary "incident" to furnish the pretext for aggression. Outer Mongolia is already as good as in the Russian bag; Chinese Turkestan and Inner Mongolia are apparently doomed to follow.

**Japan.** Close of session for the Diet leaves a record almost devoid of accomplishment. The Minseito party, enjoying a heavy majority, was yet unable to make headway against the violent obstructionist methods of the opposition. And after the shooting of Premier Hamaguchi, all progress stopped. The appointment of Reijiro Wakatsuki to the premiership augurs better results for the future. Most of the members of the old cabinet were retained.

Arguments in the Diet relative to the London Naval Treaty developed one fact of interest—that Japanese naval plans contemplate a strategical defense. Moreover, it is clear that the powerful "big navy" element has never renounced its intention to secure ultimately a 10-10-7 ratio in 10,000-gun cruisers. Under the terms of the present agreement Japanese strength in that category will be 62.2 per cent of the American totals in 1938 if our program is completed. However, until 1935, Japan's relative strength will slightly exceed 70 per cent.

The Russo-Japanese squabble of many months over the right of Japanese to fish in Siberian waters has finally been settled. A compromise, evaluating the ruble at 32.5 sen (16 cents), places the Russian currency at many times its true value, but affords the Japanese an opportunity to bid for the various fishing concessions. The Russians in this case backed down from their demand for 40 sen, but only when it was clear that the Japanese were going to fish in any event—under armed protection if need be. Today, Russia has not answer in the water to that argument.—ROBERT E. BLAIR, *First Lieutenant, Infantry.*

# NATIONAL GUARD NOTES

## Field Inspections

**F**IELD inspections of the National Guard have a two-fold purpose—to ascertain the state of training of units and organizations with a view to determining their degree of readiness for active service, and to serve as the basis of future training requirements to be included in the directives of the Militia Bureau and corps area commanders.

It has been concluded that the information desired can best be obtained by observing the performance of all ranks in tactical and combat exercises and in the conduct of camp routine, by considering the strength of a unit present at camp, the sufficiency and condition of arms, matériel and equipment; and by noting the general efficiency of the command, discipline and morale, and fire control and fire discipline.

The inspections are to be conducted, and the rating of units is to be made by boards of officers rather than by individual officers. These boards are to be constituted by corps area commanders and composed of three officers of the Regular Army on duty in the corps area, preferably, but not necessarily, on duty with the National Guard. In large camps it is conceivable that more than one such board will be in operation, so that there may be enough of them to conduct the inspection with dispatch and thoroughness.

In detail the scope of the inspections will include the following subjects and operations:

### *a. Combat Efficiency.*

(1) Training programs will provide for suitable tactical exercises in keeping with the training directive prescribed for the organization, and not less than one full day for each battalion or similar organization to be tested will be provided therein.

(2) The problems used in these tactical exercises will be prepared by the appropriate national guard commanders and their staffs with the assistance of the regular army instructors, in connection with the preparation of their field training programs. Problems will be so designed as to fit the terrain available at the camp, and applicable to the arm or branch of unit under inspection. Problems should be commensurate with the state of training of the unit.\* In this connection, commanders should keep in mind the Militia Bureau policy of sound basic training, and should draft their problems so as to bring out such principles.

(3) All troops in camp will participate in such tactical exercises as may be prescribed in training programs, and such participation will be observed by the inspection board and ratings assigned based on performance.

(4) In order that all personnel may participate in these tactical exercises, and to avoid breaking up exist-

ing organizations, the company, troop, or battery, at existing strength, is designated as the unit to carry out the exercises. This action is taken in furtherance of the Militia Bureau policy of basic training.

(5) The headquarters and staffs of battalions and higher organizations will be inspected and rated by the board through observation of their methods, capacity and efficiency throughout the entire camp period, of their work as a staff team in the conduct of the tactical exercises prescribed herein, and of their performance in command post exercises. Whenever applicable, consideration will be given, in determining the combat efficiency of commanders and staffs, to the suitability and tactical soundness of the problems prepared by them.

(6) In the preparation of problems the Militia Bureau policy of thorough basic training must be constantly kept in mind. No problems, exercises or maneuvers, should be set up, the execution of which is beyond the capabilities of the troops to be tested. This same limitation applies to the tests for commanders and staffs. In this connection, there is a marked tendency in many States to advance in training beyond a status appropriate to the annual turn-over in enlisted personnel within the organization. Thus, the great necessity of training officers and key men in fundamentals is being overlooked, and it is upon such training that the rating of availability for mobilization greatly depends.

### *b. Conduct of Camp Routine.*

The rating to be assigned to this factor will naturally be governed largely by the general efficiency of commanders in the supervision and conduct of camp routine, consideration being given to ability to formulate orders and secure their proper execution throughout the chain of command, the training and performance of interior guards, the conduct and operation of messes, the observance of proper police and sanitary measures throughout the camp, and the operation of supply within the organization.

### *c. Strength Present in Camp.*

A high percentage of attendance at the camp is one of the best indications of the efficiency of an organization. Only with an approach to 100 per cent attendance can any real estimate of the efficiency and training of an organization be made. In making this estimate the inspection board must consider the entire personnel present. The presence of an excessive number of recruits is naturally reflected in the training and should result in a lower rating being given under this factor.

#### *d. Sufficiency and Condition of Arms, Materiel, and Equipment.*

In order that an accurate estimate may be obtained of the condition and completeness of such uniforms, arms and equipment as are with the troops in camp, and a rating assigned this factor, the following procedure will be carried out:

(1) National guard field training programs for all organizations will provide for an inspection to be held in full field equipment, including the pitching of shelter tents and display of equipment, during the latter days of camp. These inspections will be conducted under the entire supervision and control of national guard commanders.

(2) Inspection boards will accompany national guard commanders during their inspections of the troops, and will themselves make such inspections as are necessary to arrive at a conclusion as to the exact condition of the United States property in camp in the hands of the troops.

(3) When an organization is using guns, motors, or other equipment which is issued them for training purposes upon arrival at camp, and which is not part of its organizational equipment, inspection boards will be furnished, when practicable, with a statement as to the amount and servicableity of like equipment in possession of the organization at its home station.

#### *e. General Efficiency of the Command.*

The general efficiency of the command will be rated by the board after observation of the initiative and qualities of command and leadership displayed by the various commanders during the progress of the tactical exercises, or as evidenced by all commanders at other formations. In the case of battalion and higher commanders and their staffs, this factor will be determined by the board by observation of the ability displayed by such officers during command post or other combined command and staff exercises or at other troop assemblies.

#### *f. Discipline and Morale.*

During the progress of the camp, members of the inspection board will observe such conditions as will determine the rating to be assigned the factor of discipline and morale. Such things as military courtesy, promptness and orderliness of formations, quietness in camp after taps, spirit in which assigned tasks are performed, and other similar evidence should be carefully observed.

#### *g. Fire Control and Fire Discipline.*

All field training programs of national guard units whose principal arm is the rifle should make provision for the firing of simple musketry exercises at field training camps where facilities for such firing exist. The firing of these exercises will be observed by inspection boards, and a rating based on such observations assigned this factor.

The company, troop, or battery has been designated as the "unit of inspection." For a regiment, separate battalion, or squadron to be rated as "satisfactory" all headquarters and at least 70 per cent of the units

of which it is composed must be rated as "satisfactory."

Units and organizations will be rated either "satisfactory" or "unsatisfactory." Where a rating of "unsatisfactory" is given, the deficiencies which necessitated such a rating are to be stated in detail in the space provided for "remarks" on the blank forms.

The blank forms on which board reports are to be made are to be supplied to corps area commanders by the Chief of the Militia Bureau, and such administrative instructions as may be necessary will be issued with the forms.

This system of field inspection is a great step forward in the National Guard and one that will work to the advantage of every one concerned.

## The Ration Allowance

FOR the past several years there has been an insistent demand for an increase in the ration allowance of the National Guard while attending the summer field training camps. The matter culminated in 1929 when a resolution was adopted at the National Guard Association at its convention in Los Angeles, which called for an allowance of 55 cents per man per day. When a study was instituted it was found that there were not sufficient data available in the office of the Chief of the Militia Bureau on which to base a decision in the matter.

The ration allowance is not governed by law; it is fixed by the Chief of the Militia Bureau. In general it is based upon the cost of the ration of the Regular Army, which is fixed each year by executive order of the President, the amount being based upon the prevailing prices of food stuffs. For the past several years the allowance has been 50 cents. The components are procured by the U. S. property and disbursing officers in accordance with the laws and regulations which govern purchases for the Army.

Prior to the opening of the field training camps last summer General Everson communicated with the corps area commanders and solicited their cooperation in securing information on which to base sound conclusions. In the process of camp inspection the messing and ration situation was especially inquired into. Officers of the Militia Bureau who visited camps delved into messing arrangements and the sufficiency of the ration. The Chief of the Militia Bureau concerned himself with the matter when he visited practically every camp in the United States. The information obtained through all of these sources has been given very careful consideration in the office of the Chief of the Militia Bureau, and it shows, in general, that the National Guard is subsisting satisfactorily on the 50-cent ration. It was found that while in a number of instances the ration allowance is augmented from state funds, the additional money was used for the purchase of components not considered available in the soldier's ration.

The number of units which were unsatisfactorily rationed was very small compared to those which found

the allowance to be adequate, and the unsatisfactory messes, it was sensed, were as a rule poorly managed. It was found that where uniform bills of fare were prepared the messes were superior to those where the bills of fare were left to unit commanders to prepare. Where entire camps were operated under a master bill of fare the property and disbursing officers were able to purchase the components in large quantities and thus take advantages of lower prices submitted in the bids of various dealers.

A survey of food prices made by the Bureau of Labor Statistics shows that they have decreased from 15 to 20 per cent in the past two years. In view of this fact, together with those obtained by means of the survey, it has been decided that there will be no increase in the national guard ration for the coming summer camps.

In those isolated cases where the food prices in particular localities are above the average, the Chief of the Militia Bureau has approved increases to cover such conditions. These instances are few and are well known in the Militia Bureau.

When officers recommend an increase in the national guard ration they must take into consideration the fact that an increase of one cent involves an additional expenditure of more than \$20,000 per year, and that an increase of five cents per ration would boost the cost of the field training camps by more than \$100,000. Such an increase cannot possibly be met out of current Militia Bureau appropriations.

### Economy

THE watchword of the military establishment today is "economy," and this applies with special emphasis to the National Guard. If the Guard is to continue its progress, it must be done with the same amount of money that it is now receiving from the Federal Government. Under existing circumstances, an increase in the appropriations cannot be hoped for.

One of the major items in the expenses of field training camps is that of freight transportation of unit equipment, supplies, and matériel from home stations to camp and return. The Government pays practically full passenger fare for each officer and enlisted man. *This carries with it a 150-pound baggage allowance per person*; the company that goes to camp with 50 men has an allowance of 7,500 pounds. If the company property and equipment are packed properly, as checkable baggage, the allowance should be sufficient to cover everything, and the allotment of additional funds should not be necessary for the transportation of freight.

The Militia Bureau is working out a plan for the construction of storehouses at field training camps, where much of the heavy property may be stored during the period between camps. The transportations funds saved are to be devoted to this project, and in the course of time the camps will be provided with adequate facilities for the purpose.

The provision of storehouses will work out to the advantage of all concerned. They will save freight

transportation costs; unit commanders will be relieved of the care and responsibility for the property during the armory drill season, the individual men of the company will be relieved of the manual labor of handling all of this property from armory to train and from train to camp. It will be at the camp when they arrive there, ready to be issued and placed in service.

This is one of the important items in the progress of the National Guard, in which every officer and enlisted man can do his part. Every one should cooperate in it to the end that it may be realized in the near future.

### Efficiency Classification

EACH year the Coast Artillery organizations of the National Guard which engage in record target practice are classified by the War Department upon the recommendation of the Chief of the Militia Bureau and the Chief of Coast Artillery.

The classification is based upon the record firing primarily, but an outfit must also produce at least a satisfactory rating at the regular armory inspection in order to receive the highest classification and be included in the orders published to that effect. Three batteries who obtained an excellent rating on their target practice failed to make the list due to unsatisfactory armory inspections.

In accordance with the system, the following batteries have been given a classification of "Excellent" by the War Department for the calendar year 1930:

#### Harbor Defense

Btry B, 240th C. A. (Me. N. G.)—Capt. P. S. Emery, Comdg.

Btry F, 240th C. A. (Me. N. G.)—Capt. W. O. Feyler, Comdg.

Btry H, 240th C. A. (Me. N. G.)—Capt. J. H. McClure, Comdg.

Btry F, 243d C. A. (R. I. N. G.)—Capt. J. A. Murphy, Comdg.

Btry D, 265th C. A. (F'a. N. G.)—Capt. R. Carter, Comdg.

Btry K, 248th C. A. (Wash. N. G.)—Capt. E. R. Hawley, Comdg.

Btry B, 249th C. A. (Ore. N. G.)—Capt. C. G. Young, Comdg.

Btry C, 249th C. A. (Ore. N. G.)—Capt. C. J. Larson, Comdg.

#### Antiaircraft

Btry D, 197th C. A. (N. H. N. G.)—Capt. O. J. Comeau, Comdg.

Btry D, 213th C. A. (Pa. N. G.)—Capt. R. Hahn, Comdg.

Btry E, 213th C. A. (Pa. N. G.)—two practices—Capt. D. J. Evans, Comdg.

Btry C, 206th C. A. (Ark. N. G.)—Capt. H. E. Eldridge, Comdg.

The officers and enlisted men who are members of these batteries are entitled to wear the insignia (the letter "E") indicating the rating on the outside cuff of the right sleeve of the service coat. They are to be congratulated upon their achievement.

# COAST ARTILLERY BOARD NOTES

*Communications relating to the development or improvement in methods or materiel for the Coast Artillery will be welcome from any member of the Corps or of the Service at large. These communications, with models or drawings of devices proposed, may be sent direct to the Coast Artillery Board, Fort Monroe, Virginia, and will receive careful consideration. J. C. Ohnstad, Lieutenant Colonel, C. A. C., President.*

## Projects Completed During March and April

*No. 566. Experimental Gas Proofing, Battery De-Russy.*—Recommended that a target practice be conducted using the present installation to determine the effectiveness of the completed installation.

*No. 603. Auxiliary Firing Magneto for 12" Barbette Carriage, M1917.*—An auxiliary firing magneto has been installed on one carriage of this type so as to permit firing the gun from the lower platform. The Coast Artillery Board has recommended that this installation be not standardized.

*No. 669. Comparative Test of Field Glasses.*—The report on this project was submitted February 19, 1929. In that report the Board stated that field glasses for general use in the Coast Artillery have the following characteristics:

1. Power: 8
2. Exit pupil: Not less than .20 inch.
3. Horizontal and vertical mil scales.
4. Provision for interocular adjustment.
5. Provision for individual eyepiece adjustment.
6. Range of stereoscopic vision: Not less than 7000 yards.
7. Field of view: Not less than 7 degrees.

These requirements are satisfied by the Zeiss "Delactis" field glasses.

Early in February, 1931, a pair of Goerz 8 x 56 binoculars were sent to the Coast Artillery Board for test. These glasses were excellent glasses but they were very heavy and awkward to handle. The Coast Artillery Board then requested that a pair of Zeiss "Delactis" glasses be sent to the Board in order that a comparative test might be made between the Goerz glasses and the Zeiss glasses. Recommended that the Zeiss "Delactis" Field Glass or the equivalent, be adopted as standard for issue to all Coast Artillery units.

*No. 679. Test of Rear Band Assembly for Dummy Projectiles.*—Tests on the rear band assembly for the 6, 8, and 10-inch dummy projectiles were completed. In this rear band assembly specially heat treated steel has been used in the construction of the sliding sleeve. The band is made of manganese bronze. This construction gives greater rigidity to the sleeve and thereby reduces the possibility of distortion under the crushing strain imposed during ramming. The modification also has the advantage that it can be applied at relatively small cost to the dummy projectiles now in service. Each rear band assembly was subjected to 200 rammings to determine whether it was possible for

the projectile to become stuck in the bore. In no case did this happen, although in some cases it required as many as twelve blows to unseat the projectile. This was a decided improvement over the old type rear band assembly, which required from 10 to 14 blows to unseat and frequently stuck in the bore. By removing from one-half to three-quarters inch of metal from the body of the projectile, thereby increasing the length of stroke during extraction, the number of blows required to extract the projectile was reduced to a maximum of five and an average of three. The Coast Artillery Board recommends that this rear band assembly be applied to all dummy projectiles of the sliding sleeve type now in use.

*No. 796. Test of Elevating Mechanism (T4) for 12-inch Railway Mortar Carriage.*—In order to permit more rapid loading of the 12-inch railway mortar, the elevating mechanism was modified by adding an antifriction device. In this device a crutch is supported on a flexible beam and the crutch bears a 1-inch roller bearing which in turn carries the tipping parts. When the gun is fired, the flexible beam bends, permitting the carriage trunnions to rest directly on the original trunnion bearings thereby relieving the antifriction bearings of the firing stresses. This device permits a 3 to 1 ratio in the elevating mechanism as compared with a 1 to 1 ratio in the original mount. The device is much superior to the modification which had been applied locally. The time required to elevate and depress the gun is less and the labor associated with these operations has been greatly reduced. The Coast Artillery Board recommends that this device be adopted as standard.

*No. 819. Device for Training Spotting Observers ("Impact Theatre").*—Recommended that no further work be done on the "Impact Theatre" inasmuch as there are several Coast Artillery Board Projects contemplated in which the Jackson Camera will be used to analyze spotters' errors when both slow and fast moving targets are used.

*No. 822. Target Practice Reports—Changes in TR 435-55.*—Certain changes in TR 435-55 have been recommended by the Coast Artillery Board. One is a change in the values of the probable error in range for mortars, Table I. Another change would permit anti-aircraft gun batteries to fire with two guns instead of four. The principal change, however, has been the introduction of a new searchlight score and consequent rewriting of the entire section dealing with searchlights.

*No. 830. Modification of Loading Equipment, 8-*

*inch Railway Gun.*—In this project the Coast Artillery Board recommended that Field Service Modification Work Order E17-W1 be rescinded. This work order provides for reinstallation of the loading stand on the 8-inch railway carriage. The recommendation was based on opinions expressed by battery commanders manning this materiel. The present method of handling ammunition on the 8-inch railway carriage is substantially as follows: The projectile is placed on the car platform from the overhead trolley in the ammunition car. The projectile is then lifted to the top carriage by one or the other of the two davits now on the top carriage. In the case of the 200-lb. projectile a common procedure is to simply carry the projectile from the ammunition car and place it on the top carriage. As many as twenty 200-lb. projectiles may be stacked within reach of the lefthand davit. When these projectiles have been fired, fire is suspended until the ammunition detail gets out another twenty rounds and places them on the top carriage. This arrangement is held to be much more convenient and permits a higher rate of fire than is possible with the loading stand and tray which requires the gun to be traversed from the firing position to the loading position after every round. The only time the right-hand davit is really needed is in unloading and placing the floats. This davit can be removed or placed in five minutes time. In view of the foregoing considerations, it would appear that in the case of 200-lb. projectiles the loading stand is an encumbrance rather than a help. In the case of the 323-lb. projectile, there is a delay between each round since the gun must be traversed from the firing position to the loading position when the loading stand is used. When there is no loading stand there is a longer delay after every 10 or 12 rounds, in order to reload the top carriage with a supply of projectiles. The Coast Artillery Board is informed that the additional weight on the top carriage has no appreciable effect upon the ease of traversing the piece.

*No. 831. Analysis of Antiaircraft Service Target Practice (Jackson).*—Recommended that the method of antiaircraft target practice analysis as proposed in Captain Jackson's letter be not adopted for use in the service.

*No. 832. Drafting Chest for Antiaircraft Gun Batteries, Specifications for.*—The C. A. Board submitted a proposed design of drafting chest for antiaircraft gun batteries.

*No. 834. Proposed 12" Mil Protractor for Coast Artillery.*—A proposed protractor for Coast Artillery was referred to the Chief of Coast Artillery by the Chief of Engineers for concurrence and comments. This protractor is a 12-inch, xylonite, semi-circular, protractor, graduated in mils, and has a scale of yards on its base to the scale of 1/20,000. This protractor was referred to the Coast Artillery Board by the Chief of Coast Artillery for comment and recommendations. The Coast Artillery Board, after a study of the design of the proposed protractor, recommended as follows: that the proposed protractor (1) be standardized; and (2) be substituted as an article of issue for the

following: (a) Protractor, xylonite, semi-circular, 10-inch, graduated in mils, and (b) protractor, xylonite, semi-circular, 12-inch, graduated in mils.

*No. 836. Development of 14-inch and 16-inch Railway Carriages.*—Recommended that the development and test of the 14-inch and 16-inch railway gun materiel and 16-inch howitzer materiel be held in abeyance for the present and that development work be concentrated on the 8-inch railway gun.

*No. 837. Modification of Breech Face, Antiaircraft Guns.*—Recommended that the breech face of the antiaircraft gun be not modified as proposed.

*No. 838. Vertical Sight for 3" Antiaircraft Model 1918 Materiel (Applegate).*—Captain L. M. Applegate, CA-Res., submitted a design for a dual sighting system for the 1918 antiaircraft gun trailer mount. The system submitted is similar to the Richards dual sight and used an elbow sight Model 1917 in place of the panoramic sight. The elbow sight, which is free to turn laterally in the inclined plane, is mounted on a vertical segment controlled by the elevation pointer. The elevation setter sets the gun in elevation by matching the vertical deflection which includes superelevation and adjustment corrections to a zero pointer on the segment. The Coast Artillery Board did not recommend adoption as the sight relates to an emergency system of fire control without marked advantages over the Richards sight.

*No. 839. Standardization of Ammunition for Caliber .50 A. A. Machine Guns.*—Recommended that .50 caliber tracer ammunition T2E3 and ball ammunition T4E1 be adopted as standard but that development of .50 caliber ammunition, particularly tracer, continue.

*No. 840. Comparator Controller with Night Glass for Searchlights.*—Recommended that a Goerz binocular night glass be mounted on a controller for MVI antiaircraft searchlight and be sent to Fort Monroe, Virginia, for test by the Coast Artillery Board.

*No. 842. Reference Numbers for Range Corrections.*—The Coast Artillery Board has recommended that the use of reference numbers be adopted as the standard procedure when applying range corrections. This had been proposed, off and on, for many years but the difficulties, real or imagined, outweighed the advantages of such a system. The principal objection was based on the necessity for converting a deviation in yards to a correction expressed as a reference number. While this conversion was possible the operation was so subject to error that the advantage of reference numbers was lost. This objection has been overcome by the Spotting Board, M-2. In this device deviations are indicated in per cent. In the proposed system the Spotting Board, M-2, would be graduated in reference numbers so that no conversion is necessary. The scale on the blade of the T-square on the Fire Adjustment Board, and the scales on the Range Correction Board and the Range Percentage Corrector would all be graduated in reference numbers. In the entire sequence of operations, from the observation of deviations to the resulting correction as applied to the range percentage corrector, the use of such terms as "over," "short," "up," "down" would be avoided. Where

deviations are given in yards, as in the case of aerial spotting. conversion to reference numbers is accomplished by means of a slide rule. The Coast Artillery Board has suggested design for such a slide rule. In the system proposed by the Coast Artillery Board zero correction will be represented by 300. Each unit will represent 0.1 percent so that the reference number 315 will indicate "up" 1.5 per cent, and the reference number 282 will represent "down" 1.8 per cent.

*No. 845. Proposed Instruction and Prescribed Ammunition Allowances for Coast Artillery Target Practices, Fiscal Year 1932.*—The Board submitted proposed draft of instructions and prescribed ammunition allowances for Coast Artillery Target Practices, Fiscal Year 1932.

*No. 846. Specifications for Power Unit for Instrument Trailer M1.*—Recommended that certain minor changes be made in these specifications.

*No. 847. Larger Panels for Coast Artillery Organizations, Necessity for.*—Recommended that (1) small size standard panels be no longer issued to Coast Artillery organizations; (2) a panel with 30-foot sides and square shaped, white on one side and black on the reverse, be issued as the basic panel, and the strips be 30 feet by 6 feet; (3) Table of Basic Allowances for Coast Artillery be revised accordingly.

*No. 848. Air Mines for Protection Against Aircraft (Muirhead).*—Recommended that no further action be taken on this project.

*No. 849. Prediction of the Future Position of an Antiaircraft Target (Baude).*—Recommended that no further action be taken toward development and adoption of the proposed system of predicting the future position of an antiaircraft target submitted by Mr. W. A. Baude.

#### Projects Under Consideration

*No. 681. Test of Fast Towing Target.*—Further tests postponed until tests at Fort Story of T-1 mount and Director M-2. This target will receive its final test either next Spring or next Fall. The target is now at Fort Monroe and will be left in the water indefinitely to determine whether or not it will become sufficiently waterlogged to become unseaworthy.

*No. 694. Test of Erosion Charts—Tests completed.*—Awaiting result of Jekaduma Chronograph.

*No. 707. Test of Artillery Lantern M-1 and Lantern Mask T-1.*—Report in preparation.

*No. 727. Standard Single Conductor Mine System.*—A continuing project.

*No. 764. Reminder List for Antiaircraft Artillery Target Practice.*—Under study.

*No. 800. Test of Radio Direction Finders.*—Under study.

*No. 814. Illuminating Device for 12-inch Barbette Carriage Model 1917.*—This device consists of two electric lights installed on the racer on either side of the shot truck guides. Lights are shielded so as to restrict illumination to the face of the breech and to the shot truck guides. Its purpose is to facilitate night firing with a minimum display of light. Tests under service conditions with various types of light bulbs are to be held during the latter part of 1931 at Fort Hancock.

*No. 815. Comments on Target Practice Reports, Fiscal Year 1931.*—Comments submitted as reports are received.

*No. 817. Time Interval Apparatus for Mobile Artillery (Wallace & Tiernon).*—Awaiting return of apparatus from Signal Corps Laboratories where it is being repaired.

*No. 820. Confidential.*

*No. 824. Trichel Fuze Setter for 3" Antiaircraft Guns.*—Under study.

*No. 827. Temperature Tests of Height Finders.*—Under study.

*No. 829. Instruments for Training of Stereoscopic Observers.*—Report in preparation.

*No. 833. Program for Development Work in Long Range Firing Against Naval Targets, Hawaii, Fiscal Year 1932.*—Report in preparation.

*No. 835. Modification of Director T-7 for 3-inch Antiaircraft Guns.*—Under study.

*No. 841. Stereoscopic Fire Director for use with Antiaircraft Machine Guns.*—Report in preparation.

*No. 843. Test of Panama Type Fire Control Switchboard.*—Under test.

*No. 844. Painted Bullets for Identification of Hits on Two Targets.*—Under study.

*No. 850. Military Characteristics of an Intermediate Caliber Automatic Antiaircraft Cannon.*—Under study.

*No. 851. Proposed Modification of Mount, Antiaircraft Machine Gun, Tripod M-1.*—Under study.

*No. 852. Modification of the Antiaircraft Telescope M-1917.*—Report in preparation.

*No. 853. Tangential Observation of Antiaircraft Machine Gun Tracers (Pape).*—Under study.

# PROFESSIONAL NOTES

## What Happens When a Vickers Director is Used Against a Diving Target

Major G. B. Welch, O. D.

SOMETIME ago the writer, in an article published in the Coast Artillery Journal, discussed and derived the standard formulae solved by various antiaircraft data computers used in our service. The instruments referred to specifically were the Computer, A. A. Data, Model 1917, commonly known as the R. A. Corrector and the Director M-1 (Vickers). The latter of these is at present the standard director for our land antiaircraft artillery while the R. A. Corrector is listed as a substitute standard.

The advent of the Vickers directors in this country in 1926 aroused a great deal of interest among artillerymen because of their readily apparent sturdy construction, the ease with which competent operators could be trained, and finally because of the marked improvement noted in the results of the firing. The influence of this interest, amounting frequently to enthusiasm, has been to stimulate study and design looking toward the further application of automatic instruments to antiaircraft artillery and their extension as well to other forms of artillery. In the meantime, although the art of automatic fire control for antiaircraft artillery is progressing rapidly, a number of Vickers directors are still in use and more will be placed in service as soon as they can be procured.

While these advances were being made the antiaircraft target, the bombing airplane principally, was also making progress and it became increasingly necessary to conduct fire against diving targets as well as those performing other maneuvers. The use of Vickers directors in such cases has occasioned a good deal of discussion and some argument as to just what happens when a diving target is engaged by one of these instruments. When the question first arose, instructions were issued to set in the estimated altitude which the diving target would attain at the end of the time of flight and proceed otherwise as usual. Of course this implied continually shifting the future altitude downward. No one was quite sure just what happened inside the instrument under these circumstances and to this date there has not been available to the student a clear exposition of the theory underlying this procedure. It is for the purpose of presenting such an exposition that this paper is undertaken. Incidentally it will be shown that the method just described cannot, without some "fudging," produce hits.

Figure I represents the general case of a target diving from  $To$  to  $Tp$  in time  $t$ . Time  $t$  of course also

represents the time it takes a projectile to travel from  $G$  to  $Tp$ .

By inspection of the figure the two angular velocities measured by the director in tracking the diving target can be written as follows:

$$(1) \quad \Sigma_a = \frac{V \cos \theta \sin \alpha_0}{R_0} \quad \text{and}$$

$$(2) \quad \Sigma_e = \frac{V}{D_0} (\sin \theta \cos \epsilon_0 + \cos \theta \cos \alpha_0 \sin \epsilon_0)$$

It will be seen that, in the case of the first equation, it was only necessary to perform a simple resolution of the actual linear velocity into components along and at right angles to the present horizontal range. As the latter alone affects the lateral angular velocity we take it and divide by  $R_0$ . The result is lateral

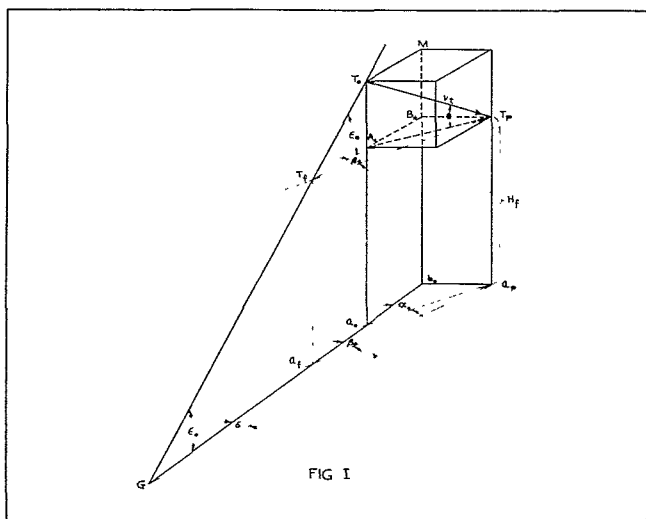

FIG I

angular velocity in radians per second, the customary unit. To get the vertical angular velocity we resolve the actual linear velocity into three components, two in the present plane of position and one at right angles thereto. The two former alone affect the vertical angular velocity so each is resolved into two components, one along the line of present position and the other perpendicular thereto but both lying in the same plane. The two perpendicular to the line of position are added and the sum divided by  $D_0$ , giving the vertical angular velocity in radians per second.

It will be recalled that, in *The Mathematics of Anti-aircraft Deflections*, the two angular velocities for targets flying in a straight line at constant altitude and speed were derived in the following forms:

$$\Sigma_a = \frac{V \sin a_o}{R_o} \text{ and}$$

$$\Sigma_e = \frac{V \cos a_o \sin \epsilon_o}{D_o}$$

Solving the first for  $\sin a_o$  and the second for  $\cos a_o$  we have

$$\sin a_o = \frac{\Sigma_a R_o}{V} \text{ and}$$

$$\cos a_o = \frac{\Sigma_e D_o}{V \sin \epsilon_o}$$

Dividing  $\sin a_o$  by  $\cos a_o$  we have:

$$(3) \quad \tan a_o = \frac{\Sigma_a}{\Sigma_e} \sin \epsilon_o \cos \epsilon_o \quad \text{since}$$

$$\frac{R_o}{D_o} = \cos \epsilon_o$$

Substituting (1) and (2) in (3) we will find the angle of approach defined by the diving target. Call this angle of approach  $x$ .

$$\tan x = \frac{V D_o \cos \theta \sin a_o \sin \epsilon_o \cos \epsilon_o}{V R_o \sin \theta \cos \epsilon_o + \cos \theta \cos a_o \sin \epsilon_o}$$

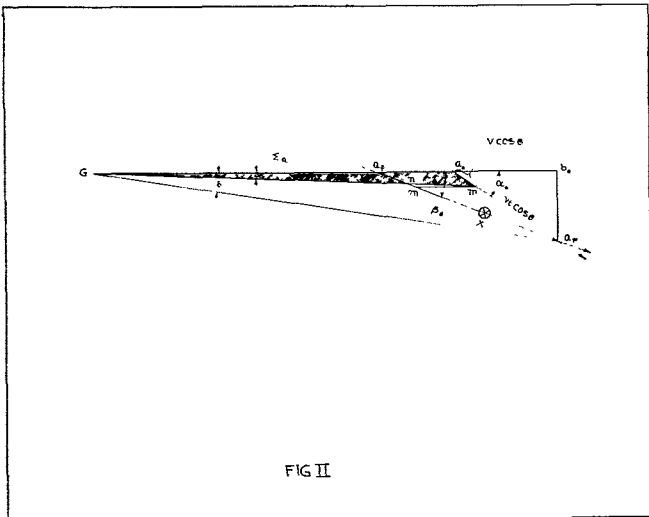

FIG II

But since  $\frac{D_o}{R_o} = \frac{1}{\cos \epsilon_o}$  we can write it as follows:

$$(4) \quad \tan x = \frac{\cos \theta \sin a_o \sin \epsilon_o \cos \epsilon_o}{\cos \epsilon_o (\sin \theta \cos \epsilon_o + \cos \theta \cos a_o \sin \epsilon_o)}$$

This is the angle of approach defined by the diving target measured in the horizontal plane. If, in tracking the target, we set into the instrument the altitude ( $a_p T_p$  in the figure) the target will have at the instant it and the projectile meet, we will define a horizontal plane with a fictitious target present position

at  $T_f$ . This fictitious target will have, if it is to reach  $T_p$ , an angle of approach  $\beta_o$ . What is the tangent of  $\beta_o$ ?

Inspecting the figure again it can be seen that

$$\tan \beta_o = \frac{a_p b_o}{b_o a_o + a_o a_f}$$

But:  $a_p b_o = Vt \cos \theta \sin a_o$   
 $b_o a_o = Vt \cos \theta \cos a_o$   
 $a_o a_f = Vt \sin \theta \cot \epsilon_o$

We can now write  $\tan \beta_o$  as follows:

$$\tan \beta_o = \frac{Vt \cos \theta \sin a_o}{Vt (\cos \theta \cos a_o + \sin \theta \cot \epsilon_o)}$$

But since  $\cot \epsilon_o$  equals  $\cos \epsilon_o / \sin \epsilon_o$ , the foregoing expression becomes:

$$(5) \quad \tan \beta_o = \frac{\cos \theta \sin a_o \sin \epsilon_o}{\sin \theta \cos \epsilon_o + \cos \theta \cos a_o \sin \epsilon_o}$$

By inspection it can be seen that (5) is identical with (4) and that therefore the fictitious target defined by tracking the diving target with a lower altitude set into the instrument will at least start out on the right track to reach the true future position  $T_p$ . It remains now to determine whether or not it will reach this future position in the time available,  $t$ .

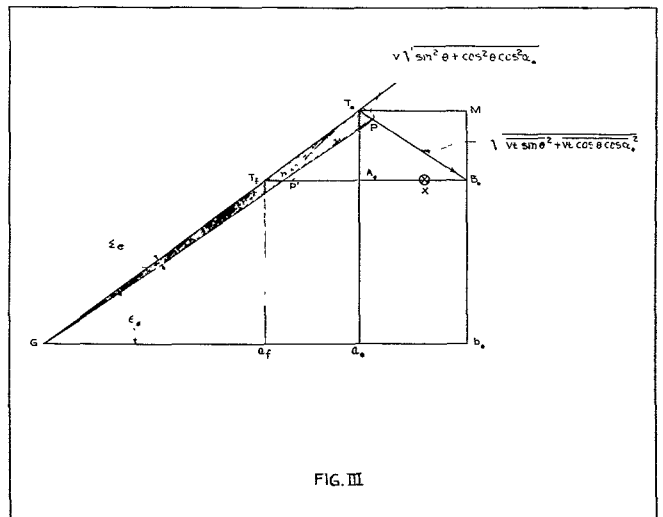

FIG. III

Refer now to figure II which is a horizontal projection of the geometrical figure shown in figure I. In other words it is a picture of the plane  $g b_o a_p$ . Note that the real target is flying along  $a_o a_p$  at a constant speed  $V \cos \theta$  while the fictitious target is flying along  $a_f a_p$  at some speed which we do not yet know. We do know, however, that its angular velocity is the same as that of the real target because it is defined by the real target's motion. This angular velocity,  $\Sigma_a$ , is shown shaded in the figure. Since it intersects the line  $a_f a_p$  at  $n$  the linear velocity of a fictitious target flying along this line must be  $a_f n$  to produce an angular velocity  $\Sigma_a$ .

What linear velocity must this fictitious target have to reach  $T_p$  in time  $t$ . If  $A_o m$  represents the constant distance travelled along  $a_o a_p$  by the real target then

if we draw a line  $mm'$  parallel to  $G a_o$ ,  $a_t m'$  will be contained in  $a_t a_p$  just as many times as  $a_o m$  is contained in  $a_o a_p$  and will therefore represent the constant linear velocity along  $a_t a_p$  necessary for the fictitious target to arrive at  $a_p$  in time  $t$ .

It can easily be seen that  $a_t n$  is and must necessarily be always less than  $a_t m'$  and that therefore the constant linear speed of the fictitious target, defined by the instantaneous angular velocities of the real target can never be great enough to reach the proper future position in time  $t$ . The director will select some point  $x$  on the line  $a_t a_p$  where the instantaneous velocity  $a_t n$  multiplied by the time of flight to the point  $x$  will equal the distance  $a_t x$  and will place the burst there.

The same analysis can be made and the same results secured by an examination of the components of the real target's motion in the vertical plane and the reader is invited to examine Figure III for this purpose. No discussion seems necessary here as the method to be followed is identical with that just described and the results are self-evident from an examination of the figure.

The question naturally arises, How much too small is the defined linear velocity of the fictitious target? That is fairly easy to evaluate. If  $R_o$  is the horizontal range to the real present position of the target and  $R_t$  the horizontal range to the fictitious target's present position, and  $dA/dt$  the lateral angular velocity of the targets, then  $R_o dA/dt$  must equal  $R_t dA/dt$  at this particular instant for the two targets to reach  $a_p$  at the same time. It will be noted that both targets have the same distance to travel *perpendicular* to  $G a_o$ . In each case a radius multiplied by the angular velocity of that radius equals the linear velocity component perpendicular to it, and it is these components which must be equal if the same distance is to be traversed by each.

Let  $H_o$  be the altitude of the true target at the instant the gun is fired and let  $H_t$  be its altitude when the projectile arrives. That is,  $H_t$  is the altitude set into the director. Then:

$$R_t = H_t \cot \epsilon_o \quad \text{and} \quad R_o = H_o \cot \epsilon_o$$

To make  $R_t dA/dt$  equal to  $R_o dA/dt$  we must multiply it by  $R_o/R_t$  or, substituting the foregoing values, by  $H_o/H_t$ . Therefore, the instantaneous angular velocity, defined by the diving target is too small by the ratio of the present to the future altitudes of the target. It may be asked how the instantaneous angular velocities can be too small when the angle of approach, which is defined by these angular velocities speeds along this course will produce angular velocities whose ratio will define this angle of approach.

What can be done, then, in the light of the foregoing discussion, to place the bursts on the target during a long dive? It is understood, of course, that the dive must continue for a time equal to or greater than the time of flight or it will be futile to try to predict down the line of flight. The first step indicated in the discussion is to reduce the altitude setting on the two cylinders by an amount which it is estimated the target will come down during the time of flight. This setting must also be constantly reduced at the rate of change of altitude during the dive. We have now set up a fictitious target which is flying toward the future position but will not reach it. The next proper step would be arbitrarily to increase the indicated angular velocities but since this cannot be done, the next best procedure, and one which approximates the proper action, is to arbitrarily increase the two deflections each in the ratio of  $H_o/H_t$ . This results in un-matching the rates and the rate pointers will continue to turn whereas they are usually stationary. We have thus actually introduced greater angular velocities and a prediction will be made upon them. By increasing these angular velocities, we have, in effect, made the instrument believe that it is tracking a target whose linear speed is great enough to reach the future position in the time  $t$ . A slight error exists in the method outlined due to the fact that in increasing the deflections we are increasing the complementary term in the same ratio as the angular velocity. This should really be left to increase by itself based upon the increased vertical and lateral angular velocity but of course such a separation of functions is impracticable.

The question may be properly asked here as to why we increase the deflections instead of applying spotting corrections. If spotting corrections alone were applied, the time and superelevation cylinders would not be affected and these must both rotate to the angular height of the target position  $T_p$  in order that the deflections, the fuze range and the superelevation pertaining to that point may be properly computed.

It is not believed that the method outlined herein has ever been tried out in practice. It is not very simple of application. In the first place it is not easy to estimate the amount of the dive during the time of flight nor to follow the altitude down as the dive progresses. In the second place, to make the deflection increase in the ratio of  $H_o$  to  $H_t$  is difficult. If, however, a satisfactorily simple method of doing these things can be worked out, the results should be very good, and it is certainly better than taking no cognizance whatever of the known properties of the director under these difficult circumstances.

# COAST ARTILLERY ACTIVITIES

## Office of Chief of Coast Artillery

*Chief of Coast Artillery*  
MAJ. GEN. JOHN W. GULICK

*Executive*  
COL. H. L. STEELE

*Plans, Organization and Training Section*  
MAJ. J. B. CRAWFORD  
MAJ. R. V. CRAMER  
MAJ. S. S. GIFFIN  
CAPT. J. H. WILSON  
CAPT. H. N. HERRICK

*Materiel and Finance Section*  
COL. W. F. HASE  
MAJ. J. H. COCHRAN  
MAJ. C. H. TENNEY  
CAPT. F. J. McSHERRY

*Personnel Section*  
MAJ. G. F. MOORE

### Chief of Coast Artillery's Inspection

GENERAL Gulick's long inspection tour came to an end on May 7 when he returned to Washington upon completion of an extended tour of the harbor defenses along the West Coast and in the Pacific. He has now visited practically every Coast Artillery station under his jurisdiction, including many National Guard and Reserve units.

General Gulick was enthusiastic over his visit to the Philippines and Corregidor. He remarked par-



Searchlights of the 64th in Action on Parade Ground at Fort Shafter.

ticularly upon the excellent state of morale which exists in the Harbor Defenses of Manila and Subic Bay under the command of Brig. Gen. Charles E. Kilbourne. Wherever high morale exists it is axiomatic that a high state of efficiency will exist also. General Gulick found the harbor defenses in a condition of "high combat efficiency and state of readiness." He

mentioned, in particular, the spirit of cooperation in General Kilbourne's command. This is true not only among the Coast Artillery personnel but is characteristic of the Engineers, Air Corps, Signal Corps, Ordnance and other services. There are various activities now being conducted at Corregidor in addition to the ordinary military duties. General Kilbourne has initiated many improvement projects which were under way at the time of General Gulick's visit and which will add greatly to the appearance of the post and the comfort of the garrison. These include the Corregidor Club swimming pool, roads, retaining walls, rehabilitation of quarters, grading, and the removal of unsightly surroundings. These require good honest work but the personnel has become infected with General Kilbourne's spirit of improvement and take pride in their accomplishments.

General Gulick mentioned the scout regiments in particular. The condition of their armament and quarters, their personal appearance, their efficiency, in general, was superb.

The Chief was unable to visit Hawaii on the return trip from the Philippines due to the arrangement of the transport schedule but sailed from San Francisco for Honolulu about ten days after his return. He, with General Cole, commanding the Hawaiian Separate C. A. Brigade, reviewed the troops of the Harbor Defenses of Honolulu on April 16. He expressed to Colonel Cloke, the Harbor Defense Commander, his pleasure in observing the "smart military appearance and discipline" of his command and the "evidences of high artillery training and condition of the armament." He mentioned in particular the outstanding services of Master Sergeant Fowee, Technical Sergeant Mandel, First Sergeant Hatton, First Sergeant Corn, Sergeant Hatfield, Staff Sergeant Edington, Staff Sergeant Golembieski and many others.

Fort Kamehameha was inspected on April 18. Colonel Homer B. Grant was complimented very highly on the appearance of the personnel of the Harbor Defenses of Pearl Harbor and particularly upon the manner in which the command has performed a great amount of labor in connection with the parade ground and fill. Staff Sergeant Stallings, Staff Sergeant Mulvaney, Staff Sergeant Stacey were mentioned, among others, for their outstanding services.

At Fort Shafter General Gulick inspected Colonel R. H. Williams and his command, the 64th Coast Artillery (AA). This regiment is unique among anti-aircraft regiments. It includes three active battalions of three batteries each. Each battalion has one searchlight battery and two combination gun and machine gun batteries. It is *not* stated that this is the best regiment which General Gulick has inspected but it is certain that it stands very high in his estimation. The regiment provided the escort of honor for the Chief on April 15. The artillery inspection on April 17 was very pleasing and the entire regiment was commended for its "high efficiency in organization, administration and training as noted during the inspection." First Sergeant Rucker, Technical Sergeant Karston, Sergeant Schermerhorn, and Sergeant Simpson were a few of the outstanding soldiers mentioned.

On April 20 General and Mrs. Gulick were honored by Colonel Williams with a Searchlight Illumination. Thirty 60-inch searchlights took part in the demonstration. In addition, 60 machine guns, all guidons, and the colors were used. The lights were arranged in the form of an ellipse on the Shafter parade ground immediately in front of the Corps Area Commander's quarters and also the reviewing stand. The machine guns were placed within the ellipse on the circumference of a smaller circle. Within the machine gun circle were the guidons and colors. The light details were carefully drilled and provided with tables which prescribed the various positions for the lights to assume. The first position is as shown on the cover page of the JOURNAL. Believe it or not, but all lights are *vertical*. Color screens were used at times. The colors were illuminated as the band played "Hail to the Chief." The ceremony was quite impressive. General and Mrs. Gulick expressed their appreciation to Colonel Williams for this unusual display.

As General Gulick returned to Washington he visited the R.O.T.C. units at Utah State Agricultural College (Logan), Kansas State Agricultural College (Manhattan) and University of Kansas (Lawrence). He spoke highly of the good work being done in these units, especially at Utah State where Lieut. Col. Carl W. Waller is P. M. S. and T. and at Kansas University under Major W. C. Koenig. He also visited the Command and General Staff School at Fort Leavenworth and Major Glen P. Anderson, in command of Fort Crockett, Texas.

## The Coast Artillery School

### The Coast Artillery Laboratory

THE Coast Artillery School introduced a novelty this year in the establishment of Fort Story as its work shop. The month of May was devoted to practical artillery work, both technical and tactical, as a culmination to the year's teachings. This innovation is considered an important improvement in the curriculum. It provided experience in field work, selection of artillery positions, movement of armament, establishment of communications and the conduct of battle practice together with joint exercises with the Navy. These features of training are becoming increasingly more frequent and important in our once very fixed arm.

The entire school personnel moved to Fort Story during the week of May 10. Railway guns were moved from Fort Eustis for use by the Battery Officer's class in target practice. The Field officer's class collected the usual U's on several terrain exercises on the sand dunes and swamps of Cape Henry. On May 22 both Field and Battery Officers engaged in a battle practice. Two batteries of 155 mm. GPFs and two batteries of 8 inch railway guns were used against a naval reconnaissance force represented by the 10,000 lb. cruisers, *Pence*, *Reno* and *Schofield*. Airplane spotting was tried out in a big way. Efforts were made to identify splashes of the two types of armaments and, by staggering the fire of the two batteries in each group, to segregate one battery's salvos from the other.

The Story experiment terminated in a Minor Joint Exercise with the Scouting Fleet of the Navy. A complete sub-sector defense was organized for the first time. The main objective of the joint exercise was to analyze the entire system of intelligence and communications.

### Annual Spring Polo Tournament

The Polo squad concluded its most successful year in its spring tournament. Four teams competed in hotly contested matches which resulted in Captain Eugene C. Conway's team winning the trophies. Captain Conway's team line-up was as follows:

- No. 1. Lieut. Merkle
- No. 2. Lieut. Burnett
- No. 3. Lieut. Nelson
- No. 4. Capt. Conway.

Polo was organized at Fort Monroe in 1925. Since that time the standard of play has steadily improved under the coaching of Major Howell M. Estes, Cavalry instructor at the school. This year's training has developed an unusually large number of hard hitting and aggressive players. The training of ponies has kept pace with the players and many high class polo horses have been developed.

The outstanding stars among the squad are Lt. J. R. Burnett, Lt. W. I. Brady and Howell Estes, Jr.

### Opening of Beach Club

No social function at Fort Monroe, has approached the opening of the New Beach Club which took place

on May 1. This monument to the energy of General Embick in developing post spirit is a work of real art. Built of pine logs transported from Fort Eustis, both interior and exterior are a credit to any architect. Admirably located, facing the swimming beach and at the first tee of the new golf course, this addition to the recreational facilities will help to make Fort Monroe the most desirable post in the army. Considering the ill repute and distaste with which most young officers regard the "cradle of the Coast Artillery" as a result of War service here, great credit is reflected on recent commanding officers for its present high morale.

### Relief of Executive

COLONEL W. F. Hase arrived in the Chief's Office about May 10 and will relieve Colonel H. L. Steele as executive for the Chief of Coast Artillery upon the expiration of his detail. Just prior to reporting for duty and immediately following his tour of foreign service, Colonel Hase was on leave of absence in Europe. He has been taking advantage of Colonel Steele's presence to thoroughly inform himself of the details of each section of the office. Colonel Steele will relinquish his desk to Colonel Hase about August 1 when he will leave for his new station in Hawaii. Assignments to be made in the Hawaiian Department can be only conjecture but it seems reasonable to assume that Colonel Steele will command the Harbor Defenses of Honolulu as Colonel Cloke's successor. Colonel Steele's tour of duty as executive has been notable for the cooperation which has existed among the personnel of all ranks on duty in the Chief's office. He has been an able assistant to the Chief of Coast Artillery in maintaining the *esprit* of the Coast Artillery Corps as well as in performing the official duties devolving upon him.

### National Guard Shooting

SOME months ago the War Department published a list of National Guard batteries which were rated "Excellent" during the year 1930. This list appears in another section of the JOURNAL. The arrangement is not in order of merit but according to the numerical designation of the Corps Area in which the batteries are located.

It is dangerous to attempt any comparison of the relative merits of the units which are entitled to wear the "E" so without stating it as an undisputed fact we will say that Battery F of the 243d C.A. (R. I. N.G.) fired one of the finest practices last summer which has ever come across the gunnery desk in the Chief's office. Captain J. A. Murphy commanded this battery. Lieut. A. G. Legace was range officer. The practice was fired at Fort H. G. Wright, N. Y., from Battery Butterfield (12-inch disappearing guns) at an average range of about 10,000 yards. Five hits (broadside) and seven (bow on) were made. The

score was 136.93. Major A. E. Rowland, C.A.C., the regular army instructor, states that this excellent result was obtained through "excellent taining, an armament error less than the range table value, and good luck." This doesn't go far enough. Major Rowland didn't mean to detract from the battery's credit by mentioning luck. We all know that some luck is necessary but it requires some other things too. Perhaps the low armament error was due to the uniformity of loading which was mentioned in the report. There is no way of determining how much uniformity of loading affects armament error. Many officers believe that lack of uniformity is the biggest part of the error charged to the gun. Captain Murphy was handicapped by having only five gun drills before firing the practice. There is no dummy gun in his armory and he considered the drill obtained at Butterfield totally inadequate. The work of the range section was excellent—almost perfect, we would say, because the maximum personnel error was only 20 yards. The range section had had much practice in its armory and analyzed its drill to discover errors. The result was just as it should be. Of the eight record shots fired in this practice the worst fell only 99 yards from the target. Four of them were within 36 yards of the target. When we consider that a battleship is about 200 yards long and 30 yards wide it requires no argument to convince any one that this was a good practice. It would be dangerous to even hint otherwise to Colonel C. L. D. Wells, the regimental commander of the 243d.

So much for Captain Murphy but what about Captain D. J. Evans of the antiaircraft gunners? He commands Battery "E" (machine guns) of the 213th C.A. (Pa. N.G.) and certainly should be mentioned because his battery fired two practices and was rated "Excellent" on both of them. These lads hauled out their riveting machines and filled the sleeve target so full of holes it looked like an open work stocking. There were other batteries, too, which probably should be mentioned but we'll get along to the regimental standings.

We find Col. G. E. Fogg's 240th (Me. N.G.) well out in front for first place. Col. C. J. Smith's 213th (Pa. N.G.) and Col. C. M. Irwin's 249th (Ore. N.G.) are fighting it out for second place with two batteries each rated "Excellent." Col. Smith has an ace in the hole in Battery E which was twice rated "Excellent" in target practice. On the other hand Col. Irwin may bring up the point that he has only six firing batteries including the searchlight battery and therefore his percentage is higher. When one-third of the batteries of a regiment are rated excellent it is no bad record. That northwest climate is bracing.

In connection with the regimental standing we have made a discovery which may not have anything to do with it but it is this: Lieutenant Colonel James S. Dusenbury, C.A.C., now instructor with Colonel Fogg and the 240th used to be the instructor out in Oregon with the 249th. Do you suppose—do you think he could have had any thing to do with the standing of these regiments? It must be some kind of a game.

## Harbor Defenses of Manila and Subic Bays

GENERAL Charles E. Kilbourne, commanding the harbor defenses, has sent us an excellent article on the improvements which are taking place at Corregidor. From this description "you wouldn't know the old place now." It is regretted that lack of space prevents our including the entire article in this number but more of it will appear later. General Kilbourne reports the morale at Corregidor excellent and everybody hard at work. General Guliek found everything in a highly satisfactory condition and the Chief's talk to the officers has attracted many favorable comments.

### Corregidor Pool

There is much construction work going on all over the Rock these days but of course the apple of General Kilbourne's eye is the new Corregidor Club swim-



Excavating for the Corregidor Club Swimming Pool.

ming pool. Work on it has started and is considerably more advanced than the photograph shows. The pool is located about 100 feet in front of the right end of the club porch. It will be 90 by 50 feet having at one end a section 15 feet wide with a depth of only 2 feet (for small children). The depth in the remainder varies from 4 to 9 feet. Lieutenant Bonner Fellers is superintendent of construction.

Salt water will be used in the pool. The supply will be drawn by gravity from one of the salt water tanks on topside. The water will be changed frequently by means of a motor driven pump which will lift the pool water to another storage tank for use in the post sanitary system.

Due to the fact that funds are not sufficient to complete the entire pool project only the tank has been constructed so far. Tiling, dressing rooms, drying room, attendants' room, benches, etc. will be added later.

Many suggestions have been made as to the financing of the Pool. Some suggest that Quartermaster funds be used, others that the Y. M. C. A. might be induced to furnish the funds. The difficulty lies in the fact that the pool is to be used by club members only. With this restriction, general funds can not be used.

Contributions have been received from officers in the States as well as those at Corregidor. Each officer of the post is being assessed one peso monthly on his Club bill for a period of six months. Those who



Topside Club, Showing Recently Completed Parking Space.

expect to join the garrison shortly are credited the amount contributed. More money is needed and since all officers at some time may expect a tour in the Philippines a contribution to this project will be money well spent and returned in the additional recreational facilities afforded when the Philippine tour arrives.

### Good Shooting

General Kilbourne also calls our attention to some good shooting by Battery A, 92d C.A. (PS) during

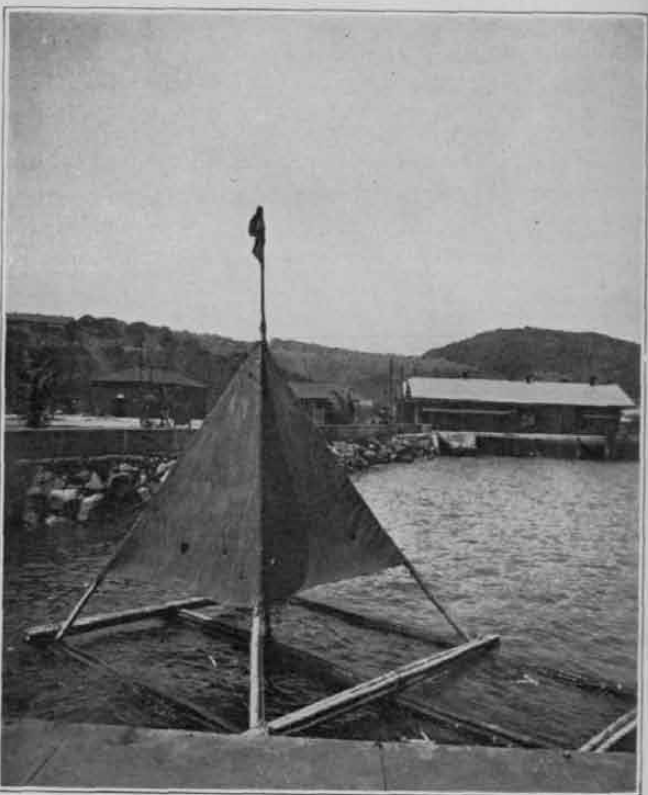

Direct Hits Made by Battery Keyes, 3-inch Ped. Mount, on Pyramidal Target.

a night practice fired on March 3. The practice was fired at Battery Keyes, mounting two 3-inch guns on pedestal mounts. There were 5 holes in the pyramidal target; one near the top, three near the bottom and

one (not visible in the photograph) in the center of the cloth. Although the range was short (3620 yards) the shooting was excellent even for this short range. During night practice the gun pointer has much difficulty in keeping the gun trained on the target due to the blinding effect of the flashes. The center of impact was plus 3 yards, all shots being practically line. Counting double for hits both bow-on and broadside 21.7 hits per gun per minute were scored. Actually a destroyer would have been struck 12 times in 36 seconds. The battery was commanded by 1st Lieut. John S. Henn during the practice. To show this was no fluke, the score made by the battery during day practice was 157.4.

### The 69th Coast Artillery (AA) Fort McClellan, Ala.

THE most recent word received direct from the 69th was through Lt. Col. J. B. Taylor who recently relinquished command of the regiment to Lt. Col. F. H. Smith. Colonel Taylor stopped in Washington his way to catch the transport sailing for the Philippines, May 5. He hesitated long enough to read us the reports of some very fine searchlight practices held by Battery A on its visit to Maxwell Field during April. It looks like Lieut. Goff had knocked out a record but we'll see. (Score, 272).

In May the regiment was at Benning taking part in tactical exercises under Colonel Smith. Here a tactical inspection was made by General McNair, the District Commander, accompanied by his executive, Major Gage. Colonel Smith stated that Battery B would fire two gun practices while at Benning and not wait until it arrives at Barrancas. A letter from Colonel Smith at which we stole a surreptitious glance should be called a "wennawegonnaget" letter. Wennawegonnaget—

- The Camera for target recording
- The Instrument Trailer
- The New Mack Primer Movers
- Back, the Mechanized Platoon
- The Humphreys Searchlight Test

To which the boys in the back room reply that they expect to see the camera and Mack trucks produced in July, the instrument trailer in September. The mechanized platoon, under Lieut. Ostenberg, is on indefinite duty with the Mechanized Force at Eustis. This force may be permanent; at least its concentration is indefinite. Battery A will go with the regiment to Barrancas thence to Fort Humphries, Virginia, to the searchlight tests, arriving about August 15.

The entire regiment will move to Fort Barrancas before July 1 for duty with summer training camps at that post and for target practice of all units not completing them previously. From Barrancas, a hermaphrodite platoon (one officer and twenty-five enlisted men) will proceed to Fort Crockett, Texas, to train reserve antiaircraft regiment. This platoon

will move by rail and will carry with it a gun, two machine guns, a sound locator, a searchlight, a director, and the necessary auxiliary equipment.

Did we hear some Cavalryman mention "mobility?"

### 13th Coast Artillery (HD) Fort Barrancas

TARGET practice was held by Batteries A and B, 13th Coast Artillery, during the month of April. There was much competition between these two batteries. Battery B men wear the "E" which they won last year. Battery A was anxious to equal this record. Battery A fired first and had a little hard luck when a Scandinavian tanker crossed the field of fire just as the battery commander was ready to give the command "Commence Firing." A little later when the field was safe the first salvo was fired resulting in a direct hit. The second salvo destroyed the target. Fire was shifted to the second target. Battery A collected a number of hits but its time was not so good. The following day Battery B fired with the results just the opposite—good time but hits not so numerous. Only the score sheet will tell the story.

Following target practice tactical inspections were held in May. After these were out of the way preparations for summer camp began. Barrancas will have plenty of them this summer. It will conduct both an R.O.T.C. and C.M.T.C. camp, running simultaneously for the most part. In addition seven reserve units will train there during the greater part of August. The 13th will have assistance on this because the 69th from Fort McClellan will be there from July 1 to the latter part of August. Nor is this all. Two regiments of National Guard will be at Barrancas during July and August. The 264th C. A. Bn. (Ga. N.G.) is a small outfit but the 206th C.A. (A.A.) (Ark. N.G.) is a full sized unit. Colonel Robertson and his braves will arrive (overland under their own power) from Camp Pike about August 23 and will spend a week as guests of the 13th. There will be plenty to do at Barrancas this summer but the 13th is used to it.

### Harbor Defenses of Honolulu

THE Chief of Coast Artillery, Major General John W. Gulick, arrived in Honolulu April 15 for an inspection of the Coast Artillery in Hawaii. General Gulick spent six days in the Hawaiian Department. Full details of his inspection are not available but will be included in a future number of the JOURNAL. On April 16 he inspected the Harbor Defenses of Honolulu. In the evening a dinner dance and reception was held in his honor at the Service Club.

In these Harbor Defenses it is customary to honor departing officers and their families with a review followed by a dinner dance on the night before the transport sails, for the departing and newly arrived officers. Captain Philip F. Biehl, Lieutenants John E. Mortimer and Virgil M. Kimm were the departing officers so honored on April 20 while Lieutenants Fred

B. Waters and Willis A. Perry were the new arrivals who were welcomed.

Former residents of Fort Ruger will be interested to learn that Colonel Cloke, during his period of command, has succeeded in dressing up Monsarrat Avenue to such an extent as to be almost unrecognizable. Through the cooperation of the City and County, paving has been completed recently. The plan calls for rows of royal palms on either side from the entrance to the QM buildings. Curbing and side walks will follow with an additional planting project in connection therewith.

Colonel Cloke will be leaving Ruger soon for his new station, Fort Monroe.

### The 61st Coast Artillery (AA) Fort Sheridan

SINCE the beginning of the outdoor season on April 1 all batteries have been busy with drill, tactical instruction, and preparation for service practices to be held during the period June 6-20. A plane for tracking was obtained through the courtesy of Great Lakes Naval station prior to the arrival of army planes on May 1.

Battery E is engaged in building a new 1000-inch range. Work is going forward on the road leading to the firing point. (One officer said you might get in but you'd never get out.) Creating an anti-aircraft firing point at Fort Sheridan involves many un-



When It's Winter at Fort Sheridan.

pected difficulties. There is a safety tower and other installations to be constructed at the firing point (used jointly by the Cavalry as a pistol and saber course). A flank station and a meteorological station are to be established—not an easy matter on a densely populated shore line bordered by estates. Getting by the fishermen at Buckroe is easy compared to getting by the caretakers. Then there is the safety boat to be arranged and other details taken for granted at Monroe.

During May the 61st was able to devote little time to training due to the fact that it carried half the post overhead of guard and fatigue ordinarily performed

by the entire garrison. The regiment also participated in the Corps Area Command post exercises and was absent from the post for a considerable time.

The 61st participated in the Chicago Jubilee week

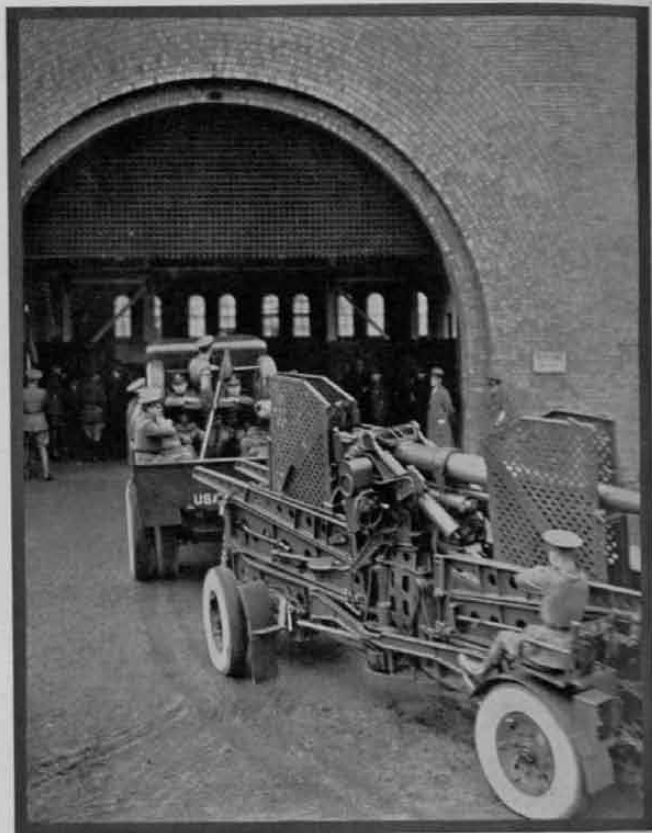

61st Gun Entering the Riding Hall, Fort Sheridan.

celebration. The regiment looked very well. During the parade, managed by the Corps Area Commander, the Searchlight Battery placed its lights in action while on the march by towing the lights on their own trucks behind the power trucks.

Busy as times were during May the regiment expects to be even busier during June with target practice, R.O.T.C., National Guard and Reserve training. The last scheduled reserve unit will leave August 28. The annual tactical march will follow in September. Some opportunity was offered for convoy work in April but the intensive schedule will prevent little road work before the march begins.

### The 64th Coast Artillery (AA) Fort Shafter

THE 64th, among other activities, is strong on basket ball. It is unusually proud of the team of the past season which won the championship from all the regiments in the Hawaiian Department. As a result it won the right to meet the champions of the Ninth Corps Area—the 30th Infantry. The series was played in San Francisco, the first game resulting in a victory for the anti-aircraft soldiers. They lost the next. The last game was a hard fought contest and it was not

until the last few seconds of play that the Doughboys succeeded in nosing out the victory with a score of 23-26. Lieutenant Vichules and Zitta starred for Fort Shafter.

The 64th passed in review before the Chief of Coast Artillery, Major General John W. Gulick, on April 15, after acting as his guard of honor upon arrival in the Department. On the 17th General Gulick conducted an armament inspection. On April 20 Colonel R. H. Williams and the regiment honored the Chief of Coast Artillery and Mrs. Gulick with an unusual searchlight illumination attended by many visitors from Honolulu. Mention is made of this in another section of the Journal.

On May 1 the 1st Battalion went into camp at Fort Weaver for target practice. The 2nd Battalion will follow in June and the 3rd will have the month of July for its practices.

### Maine Chapter of Coast Artillery Association Organized at Portland

AT THE second annual reunion of the 240th Coast Artillery (Maine N.G.) held in the Falmouth Hotel, Portland, Maine, March 14, the Maine Chapter of the Coast Artillery Association was formally organized. One hundred and sixty officers of all com-

urers, Colonel Beryl Randall, 542d C. A. Meetings will be held on the second Tuesday of October, December, February, and April or at such other times as the president may designate. The meetings will be social as well as professional in character.

Among the distinguished guests were Brigadier General Alston Hamilton, commanding the First Coast Artillery District; Colonel R. W. Collins, from the office of the Chief of the Militia Bureau, Washington; Lt. Col. Walter Singles, commanding 8th, C.A.; Lt. Gen. Alfred F. Foote; Colonel Cyril D. Wells, of Providence, R. I., commanding the 243d C.A. (R. I. N.G.); and Captain Lionel G. H. Palmer, former commander of the Ancient and Honorable Artillery Company of Boston.

Colonel George E. Fogg, in a stirring address, compared the present apathy towards National Defense to that existing during the Revolution. Colonel Fogg stated that only five per cent of the colonists took an active part in supporting the leaders of the Revolution which made this country a free and independent nation. He stated further that today only about five per cent of the citizens of the country are actively interested in National Defense and the means to maintain this freedom and independence. He lauded the Coast Artillery Association as an agency for increasing interest in National Defense and in fostering constructive patriotism.



DISTINGUISHED GUESTS OF THE 240TH C. A. AT ITS SECOND ANNUAL REUNION

L. to R.: Col. R. W. Collins, C. A. C., Militia Bureau; Brig. Gen. Alston Hamilton, U. S. A., Comd'g 1st C. A. Dist.; Col. Geo. E. Fogg, Comd'g 240th C. A. (Me. N. G.); Lieut. Gen. Alfred F. Foote, formerly Comd'g 26th Div.; Col. C. D. Wells, Comd'g 243d C. A. (R. I. N. G.); Col. S. G. Shartle, C. A. C.; Capt. L. G. H. Palmer, formerly Comd'g Ancient and Honorable Artillery Company of Boston.

ponents were present as guests of Colonel George E. Fogg, commanding the 240th. Colonel Samuel G. Shartle, regular army instructor of Maine Coast Artillery reserve units presided during the organization meeting. A constitution was adopted for the local chapter and a nominating committee consisting of Colonel Beryl Randall, 542d C.A.; Capt. P. B. McCord, 240th C.A.; and Capt. Harry Pierce, 8th C.A., was appointed and presented as a slate of officers later elected at the April meeting of the Maine chapter—President, Colonel George E. Fogg; Secretary-Treas-

Emphasis and realism were added to Colonel Fogg's remarks when Sergeant Irving E. Hammond appeared dressed in the uniform which has been approved as the official uniform of the 240th. This uniform is a replica of that worn by the old First Maine Regiment in 1803. The 240th was formerly the First Maine. Fifty uniforms of this type have been ordered and will be worn by the regiment on special occasions.

One hundred per cent of the commissioned personnel of the 240th and the 8th Coast Artillery are members of the United States Coast Artillery Association.

## The 213th C. A. (AA) (Pa. N. G.)

HEADQUARTERS THIRD CORPS AREA

UNITED STATES ARMY  
Baltimore, Maryland

333.45-Pa.-213th C.A. March 9, 1931  
77

Subject: Annual Armory Inspection Commendation,  
1931.

To: The Adjutant General of Pennsylvania,  
Harrisburg, Pa.

1. The following percentages were attained by units of the 213th Coast Artillery (AA) at the Annual Armory Inspection, January 26 to February 10, 1931, inclusive:—

Unit:	Percentage:
Headquarters .....	.941
Headquarters Battery .....	.944
Serv. Battery (less Band) .....	.949
Band Sec. Serv. Btry. ....	.872
Hdqrs. 1st Bn. ....	.975
Hdqrs. D&CT 1st Bn. ....	.799
Battery A .....	.924
Battery B .....	.848
Battery C .....	.967
Battery D .....	.96
Hdqrs. 2nd Bn. ....	.98
Hdqrs. D&CT 2nd Bn. ....	.922
Battery E .....	.89
Battery F .....	.837
Battery G .....	.858
Battery H .....	.925
Med. Dept. Det. ....	.91

Inspector's Report: "This is an excellent National Guard (AA) regiment."

2. In the opinion of the Corps Area Commander, the regiment as a whole, is deserving of great credit for the uniformly high rating of all units.

3. The highest three batteries, viz:—

Battery C .....	96.7%
Battery D .....	96.0%
Headquarters Battery .....	94.4%

are deserving of special commendation and reflect great credit on the personnel thereof.

4. It is requested that you transmit this letter to the regimental commander, and that it be published to the regiment.

For the Commanding General:

J. T. CONRAD,  
Colonel, A. G. D.,  
Adjutant General.

Editor's Note: The 213th also earned the highest percentage in drill attendance in competition with all units of the Pennsylvania National Guard during the first quarter of the present year. Col. C. J. Smith of Allentown commands the regiment.

## Coast Artillery Reserve Atlanta, Georgia

Lt. Col. R. K. Greene, C. A. C. Unit Instructor  
Staff Sgt. S. F. Falcon, Jr., D.E.M.L. Assistant

ATTENTION is called to the record in Extension Course work held by 2nd Lieut. Rudolph E. Kunkel, 922d Coast Artillery (AA). Lieut. Kunkel

accepted his commission last July but he is an old timer in the Coast Artillery. His first service was during the war when he enlisted as a private and reached the grade of Master Gunner during his first enlistment. He completed the Enlisted Specialists' Course at the Coast Artillery School and served overseas following his service at Fort Monroe.

During the first eight months of the present Extension Course year he has completed 13 subcourses—an average of 1.6 per month—earning a total credit of 415 hours. He "maxed" four subcourses with a mark of 100 per cent and obtained an average mark of 96 per cent on the remaining ones. Is this a record?

The 67th Coast Artillery (AA) is an inactive regular unit under command of Major Olin H. Longino, C.A.C., P.M.S. and T. at Georgia Tech. Major A. V. Rinearson, C.A.C., on duty with the Coast Artillery R.O.T.C. unit at the Citadel (Charleston, S. C.) is also assigned to the regiment. It is associated with the R. O. T. C. at these two schools and draws its reserve officer personnel from the graduates. The headquarters organizations and the 1st Battalion (Gun) is located at Georgia Tech; the 2d Battalion (Machine Gun) is at the Citadel.

Recently the regimental coat of arms was approved by the War Department. The design is closely linked to the early colonial history of Georgia and South Carolina. The chevron is from the arms of General James Edward Oglethorpe, the founder of the colony of Georgia. The crescent is from the flag flown by General William Moultrie, the builder and defender of Fort Moultrie against the British attack in June, 1776. (Yes, General Moultrie was a Coast Artilleryman. He repulsed a combined land and sea attack so decisively that the British did not resume operations against Charleston until two years later). The regimental motto is *Memor et Fidelis* (which, we are told, means: Mindful and Faithful).

## 243d Coast Artillery (HD) (R.I.N.G.)

WHEN the 243d decides to put on a party it does it in no uncertain fashion. On May 4 Colonel C. D. L. Wells held the Annual Review in honor of His Excellency, the Honorable Norman S. Case, Governor of Rhode Island, in the Cranston Street Armory, Providence. The review was witnessed by five thousand persons who jammed the Armory in an effort to see the show. For their entertainment Colonel Wells staged a pageant which depicted realistically an attack against a harbor defense fort. Every piece of armament in the regiment came into action. As the attack progressed "night" approached. The immense armory was plunged into darkness while the searchlights flashed into action and illuminated the scene in a weird and realistic manner. Following this spectacle a formal guard mount was held. Then the visitors were permitted to witness a battalion parade just prior to the main ceremony of the evening—the review by the Governor. In connection with the review the Governor presented trophies to the various batteries who had won them during the past year. Heading

the list of trophy winners were Captain J. A. Murphy and Battery F who fired the best target practice for the year (mentioned elsewhere in the Journal). Captain F. B. Rhodes and Battery I were honored by receiving a trophy for the greatest number of gunners. The Governor's trophy for rifle practice went to Captain R. E. Thornton and the Headquarters Battery. Captain Thornton's Headquarters Battery also won the National Trophy for attaining the highest figure of merit with the rifle as well as the Remington trophy for the greatest increase in figure of merit over the previous year. The First National Defense Trophy went to Captain E. W. Moore and Battery G who had the greatest number qualified with the rifle. 1st. Sgt. Manuel Morris, Jr., of Battery C won the Adjutant General's Trophy for individual marksmanship.

The history of the 243d dates back to 1755 when Battery E (Capt. E. J. Andrews) was organized in West-erly. Battery F and Battery H were organized before the Revolution. These batteries were in service during the War of 1812 at Fort Adams, Rhode Island. The entire regiment served during the Civil War, the Spanish-American War and the World War but not always as artillery. Until the World War nearly all batteries were infantry. The regiment served in the Harbor Defenses of Narragansett Bay during the World War although many of its present members served over seas.

### The 249th Coast Artillery (Ore.N.G.)

THE Coast Artillery idea is picking up in Oregon. As noted elsewhere in the Journal, the 249th, Lt. Col. C. M. Irwin, commanding, holds second place among all Coast Artillery National Guard units in number of batteries rated "Excellent." (Confidentially, another battery barely missed a rating of "Excellent" due to a little hard luck on its armory inspection. It was rated "Excellent" on its target practice). Captain C. G. Young of Battery B and Captain C. J. Larson of Battery C put the regiment at the top with their "Excellent" ratings.

Other batteries of the regiment have distinguished themselves also. Recently, D Battery, Captain Walter W. Abbey, commanding, won the National Trophy in the State for excellence in rifle practice. This battery is at Klamath Falls. It was organized as late as 1927 and has the distinction of being officered during its entire existence by the same officers. 1st Lieut. Dayton E. Van Vactor and 2nd Lieut. Ted D. Case are Captain Abbey's assistants (Adv't: All three subscribe to the Coast Artillery Journal). Battery D not only won the National Trophy last year but also the year before. Nor is the National Trophy all. For three consecutive years Battery D has won the silver cup presented annually to the Oregon National Guard unit maintaining the highest average drill attendance. It has held this silver cup ever since its organization. Recently the city of Klamath Falls and the county of Klamath voted \$90,000 for the building of an armory for the battery. This is sufficient evidence of approval by those who know the battery best.

Battery E, commanded by Captain LaSalls D. Stewart, has recently moved into its new armory at Cottage Grove. This new armory is of concrete and brick and was built at a cost of \$60,000. The dedication ceremonies took place on April 11 when three thousand people packed the building to its capacity. Major General George A. White, the Adjutant General of the State, presented the keys to Captain Stewart. 1st Lieut. Herbert W. Lombard and 2nd Lieut. Vern Hazen are the other officers of the battery.

### Contact Camp at Erie Ordnance Depot Lacarne, Ohio

IT IS noted that a contract camp for reserve officers was conducted at the Erie Ordnance Depot (near Toledo, Ohio) under the command of Lt. Col. Jason M. Walling, Infantry, in charge of the Toledo Reserve District. The camp was held during the period May 2-3 and was attended by officers of all arms and branches. Major Erle H. Forster, 933d C.A. (A.A.), was Camp Executive while 1st Lieut. Geo. W. Hibbert served as S-2. 1st Lieut. Rossiter H. Hobbs, 933d, was designated Coast Artillery Instructor. 1st Lieut. Leelin A. Bemis, 933d, was assistant to the Range officer.

The instruction consisted of Pistol Marksmanship, lectures by the Camp Commander, an antiaircraft firing problem, a map problem suitable for officers of all arms. Conferences on staff duties and questions concerning the Reserve Officers Association were also held.

### Reserve Officers Association of New York

THIS organization is one of the liveliest in the country. Captain T. B. Hilton, President of the Manhattan Chapter, has set a high standard in the speakers who have been obtained for the monthly meetings. In the March meeting 1st Lieut. Donald H. Galloway, Cavalry, (West Point) spoke on the Balkan situation. Major General William G. Everson, Chief of the Militia Bureau, spoke on the relation of the Reserve, National Guard, and the Regular Army. At a more recent meeting the Honorable Jacob Gould Schurman, former Ambassador to Germany addressed the Chapter on conditions in Germany and her ability to pay. There is intense interest in these meetings which is evidenced by the increased attendance.

### New Reserve Regulations Published

A NEW AR 140-5, Officer's Reserve Corps, dated April 16, 1931, has been published and will become effective July 1, 1931. This Army Regulation has not been republished, complete, since 1928. The several changes which have been made in the past three years may have caused some confusion to exist in the minds of Reserve officers, especially, as to just what's what. The new regulation should clear this up.

## Summer Training Camps—Reserve Units

Unit	Commanding	Instructor	Place of Training	Period
<b>First Corps Area</b>				
616th C. A.	Lt. Col. J. P. Littlefield	Maj. E. O. Halbert	Ft. H. G. Wright, N. Y.	July 5-18
901st C. A.	Major H. T. Lowe	Maj. E. O. Halbert	Ft. H. G. Wright, N. Y.	July 5-18
904th C. A.	Lt. Col. H. A. Dyer	Lt. Col. J. L. Holecombe	Ft. H. G. Wright, N. Y.	July 5-18
907th C. A.	Lt. Col. G. B. Sawyer	Col. S. G. Shartle	Ft. H. G. Wright, N. Y.	July 5-18
<b>Second Corps Area</b>				
621st C. A.	Col. A. E. Tanner	Maj. Meade Wildrick	Ft. Hancock, N. J.	July 5-18
521st C. A.	Col. J. E. Nestor	Lt. Col. P. J. Horton	Ft. Hancock, N. J.	July 31-Aug. 13
908th C. A.	Maj. A. C. N. Azoy	Lt. Col. P. J. Horton	Ft. Hancock, N. J.	Aug. 9-22
909th C. A.	Lt. Col. H. V. Van Auken	Lt. Col. P. J. Horton	Ft. Tilden, N. Y.	July 5-18
619th C. A.	Maj. E. L. Meyer	Lt. Col. Earl Biseon	Ft. Hancock, N. J.	Aug. 19-Sept. 1
502d C. A.	Lt. Col. C. H. E. Scheer	Lt. Col. W. S. Bowen	Ft. Tilden, N. Y.	July 5-18
910th C. A.	Maj. G. W. Farnham	Lt. Col. W. S. Bowen	Ft. Tilden, N. Y.	July 5-18
513th C. A.	Colonel J. P. Young	Major J. C. Haw	Ft. Tilden, N. Y.	July 19-Aug. 2
<b>Third Corps Area</b>				
503d C. A.	Lt. Col. E. A. Zeigler	Maj. H. L. Muller	Ft. Monroe, Va.	July 5-18
508th C. A.	Lt. Col. J. S. Ervin	Maj. H. L. Muller	Ft. Monroe, Va.	July 19-Aug. 1
504th C. A.	Maj. S. T. Phillips	Maj. F. A. Hause	Ft. Monroe, Va.	Aug. 2-15
913th C. A.	Maj. R. R. Hendon	Maj. E. B. Gray	Ft. Monroe, Va.	July 19-Aug. 1
622d C. A.	Maj. J. E. Kessler	Maj. P. H. Herman	Ft. Monroe, Va.	Aug. 2-15
<b>Fourth Corps Area</b>				
524th C. A.	Lt. Col. J. K. Jordan	Lt. Col. R. K. Greene	Ft. Barrancas, Fla.	July 25-Aug. 8
922d C. A.	Lt. Col. B. H. Tolbert	Lt. Col. R. K. Greene	Ft. Barrancas, Fla.	July 25-Aug. 8
623d C. A.		Lt. Col. R. K. Greene	Ft. Barrancas, Fla.	July 25-Aug. 8
504th C. A.	Col. R. W. Clark	Maj. Gooding Packard	Ft. Barrancas, Fla.	July 25-Aug. 8
545th C. A.	Maj. J. W. Reily	Maj. Gooding Packard	Ft. Barrancas, Fla.	Aug. 9-22
534th C. A.	Lt. Col. W. F. Robertson	Maj. E. H. Freeland	Ft. Barrancas, Fla.	Aug. 9-22
924th C. A.	Col. J. L. Newbern	Maj. E. H. Freeland	Ft. Barrancas, Fla.	Aug. 9-22
<b>Sixth Corps Area</b>				
505th C. A.	Major F. R. Miller	Lt. Col. W. W. Merrill	Ft. Sheridan, Ill.	Aug. 2-15
938th C. A.	Captain E. H. Boeckh	Lt. Col. W. W. Merrill	Ft. Sheridan, Ill.	Aug. 2-15
511th C. A.	Maj. F. G. Brightville	Capt. J. R. Clarke	Ft. Sheridan, Ill.	Aug. 2-15
535th C. A.	Col. Bowman Elder	Maj. W. G. Patterson	Ft. Sheridan, Ill.	Aug. 2-15
506th C. A.	Lt. Col. J. C. Davis	Maj. R. B. Coeroff	Ft. Sheridan, Ill.	July 5-18
526th C. A.	Lt. Col. C. C. Tracy		Ft. Sheridan, Ill.	July 5-18
531st C. A.	Lt. Col. H. H. Hodgkins	Maj. C. J. Herzer	Ft. Sheridan, Ill.	July 5-18
532d C. A.	Lt. Col. I. A. Elliott		Ft. Sheridan, Ill.	July 5-18
536th C. A.	Col. M. Deakin	Maj. S. F. Hawkins	Ft. Sheridan, Ill.	July 5-18
945th C. A.	Lt. Col. E. M. Howell	Maj. S. F. Hawkins	Ft. Sheridan, Ill.	July 5-18
946th C. A.	Lt. Col. W. P. Adams	Maj. S. F. Hawkins	Ft. Sheridan, Ill.	July 5-18
950th C. A.	Lt. Col. F. L. Perego	Maj. C. J. Herzer	Ft. Sheridan, Ill.	July 5-18
948th C. A.	Maj. C. N. Winston	Maj. G. F. Humbert	Ft. Sheridan, Ill.	July 5-18
515th C. A.	Lt. Col. D. Alter	Maj. H. L. King	Ft. Sheridan, Ill.	Aug. 16-29
538th C. A.	Lt. Col. D. Alter	Maj. H. L. King	Ft. Sheridan, Ill.	Aug. 16-29
527th C. A.	Maj. A. Hoblitzell	Col. T. B. Edwards	Ft. Sheridan, Ill.	Aug. 16-29
537th C. A.	Lt. Col. A. A. Conary	Capt. T. R. Phillips	Ft. Sheridan, Ill.	Aug. 16-29
<b>Eighth Corps Area</b>				
628th C. A.	Maj. W. J. Brady	Maj. R. H. Fenner	Ft. Crockett, Texas	July 5-18
970th C. A.	Maj. J. B. Thomas	Maj. W. S. Fulton	Ft. Crockett, Texas	July 5-18
971st C. A.	Col. J. Parkin	Maj. W. S. Fulton	Ft. Crockett, Texas	July 5-18
972d C. A.	Maj. W. G. Cox	Maj. W. S. Fulton	Ft. Crockett, Texas	July 5-18
973d C. A.	Maj. O. MeW. Drake	Maj. W. S. Fulton	Ft. Crockett, Texas	July 5-18
974th C. A.	Maj. E. Guy	Maj. W. S. Fulton	Ft. Crockett, Texas	July 5-18
<b>Ninth Corps Area</b>				
629th C. A.	Col. B. K. Lawson	Col. W. H. Monroe	Ft. Worden, Wash.	Aug. 2-15
630th C. A.	Lt. Col. W. C. Bickford	Col. P. M. Kessler	Ft. Worden, Wash.	Aug. 16-29
57th C. A.	Maj. F. E. Emery	Major F. E. Emery	Ft. Winfield Scott, Cal.	Aug. 16-29
604th C. A.	Col. H. G. Mathewson	Major R. H. Fenner	Ft. Winfield Scott, Cal.	Aug. 16-29
625th C. A.	Capt. J. Kammer	Lt. Col. W. G. Peace	Ft. Winfield Scott, Cal.	Aug. 16-29
976th C. A.	Lt. Col. G. W. Fisher	Maj. E. P. Noyes	Ft. MacArthur, Cal.	July 16-29
519th C. A.	Lt. Col. D. K. Smyth	Maj. E. P. Noyes	Ft. MacArthur, Cal.	July 16-29

# Notes of the Coast Artillery Association

THE United States Coast Artillery Association, in spite of its youth, is forging ahead towards its goal. The membership, when this was written, numbered 3269, with applications being received daily. Some confusion exists with relation to membership in local chapters and membership in the U. S. C. A. A. It should be stated that unless one holds a membership card from the headquarters in Washington his membership is not recorded with the U. S. C. A. A. and he cannot be recognized as a member. Many applicants have joined the local chapters and have failed to submit applications to the Secretary of the U. S. C. A. A. This oversight has been corrected wherever it has come to attention. Secretaries of local chapters are requested to call the attention of local members to the fact that local membership does not confer membership in the National Association, automatically.

The COAST ARTILLERY JOURNAL subscription campaign has also prospered. It may interest our readers to learn that at the present time the JOURNAL has more subscribers than at any time in its entire history. This number will not be mentioned because it is not at all impressive. The COAST ARTILLERY JOURNAL is the professional journal of approximately 8000 officers. These should be subscribers. We regret to say that scarcely one-fourth are subscribers. The support which has been given the JOURNAL and its Editor recently has been considerable and is appreciated but many more subscriptions must be obtained before the JOURNAL will be able to resume monthly publication.

One of the healthiest signs of the growth of the Association has been the number of local chapters which have been formed. These are mentioned briefly.

*Metropolitan Branch (New York)*—This chapter was formed at a meeting in the 244th C. A. (N. Y. N. G.) armory on April 29 at which Brig. Gen. Henry J. Hatch, U. S. A., presided. The following officers were elected at this meeting:

President: Brig. Gen. J. J. Byrne, N.Y.N.G.  
1st V. Pres: Col. R. S. Allyn, CA-Res.  
2nd V. Pres: Col. Wm. Ottman, N.Y.N.G.  
3rd V. Pres: Col. F. W. Stopford, C. A. C.  
Sec-Treas: Lt. Col. W. M. Colvin, C. A. C.  
Additional Members of the Executive Council:  
Brig. Gen. H. J. Hatch, U.S.A.  
Col. B. H. Pendry, N.Y.N.G.  
Col. L. M. Thiery, N.Y.N.G.  
Col. A. Ames, CA-Res.  
Col. F. R. Stoddard, CA-Res.  
Col. H. D. Cushing, CA-Res.  
Maj. Gilbert Marshall, C.A.C.

After General Byrne assumed the chair Colonel Stopford spoke upon the Association, its purpose and mission. Brig. Gen. W. I. Taylor praised the COAST ARTILLERY JOURNAL and urged the members of the Metropolitan Branch to support its professional periodical. A dinner has been scheduled by the Metro-

politan Branch for the evening of May 25. It is expected that 600 will be present.

*Schenectady Chapter.* This chapter is primarily a reserve chapter and was formed on April 21 with 79 members. The following officers were elected:

President: Maj. N. E. Devereux, CA-Res.  
V. Pres.: 1st Lt. H. V. Rector, CA-Res.  
Secretary: 1st Lt. F. A. Droms, CA-Res.  
Executive Council:  
Maj. J. C. Haw, C.A.C.  
1st Lt. H. S. Van Voast, CA-Res.  
2nd Lt. T. H. Leary, CA-Res.  
1st Lt. W. V. Owen, CA-Res.

General Gulick, General Hatch, and Colonel F. W. Stopford were elected honorary members.

*Maine Chapter (Portland)*—The formation of this chapter on April 14 is mentioned in another section of the JOURNAL. The chapter is off to a good start under the able leadership of Col. Geo. E. Fogg, (Me. N.G.), its president, and Colonel Beryl Randall, CA-Res., its Secretary-Treasurer.

*Aurora (Mo.) Chapter*—Through the interest of Colonel T. H. Loy, 203d C.A. (Mo. N. G.), this chapter came into existence on April 10 with a membership of 100 per cent of the 203d. The officers are:

President: Col. T. H. Loy, 203d C.A. (Mo. N.G.).  
V. Pres.: Lt. Col. P. A. Fry, 203d C.A. (Mo. N.G.).  
Secretary: Capt. Warren S. Perry, 203d C.A. (Mo. N.G.).

*Duluth Chapter*—Although not one of the largest chapters this organization makes up in pep what it lacks in numbers. Lt. Col. F. C. Tenney, 955th C.A. (AA) and Capt. William H. Sweet, C.A.C., are the moving spirits behind the activities of the Duluth chapter. The chapter is made up almost entirely of members of the 955th, resident in Duluth. The record of this regiment is really remarkable. Ninety-four per cent of its officers are enrolled in the Extension Courses; practically 100 per cent are members of the Coast Artillery Association; approximately 50 per cent of the Duluth Chapter are subscribers to the COAST ARTILLERY JOURNAL; attendance of the conference meetings held twice each month has been as high as 94 per cent. In addition the regiment, through its own efforts, has recruited its commissioned personnel almost to its authorized strength. The chapter consists of 29 members. The officers are:

President: Lt. Col. F. C. Tenney, CA-Res.  
V. Pres.: 2nd Lt. Francis C. Sullivan, CA-Res.  
Sec.-Treas.: 2nd Lt. H. S. Peyton, CA-Res.

*Houston (Texas) Chapter*—Through the promotion efforts of Major W. S. Fulton, C.A.C., a chapter was formed at Houston at a meeting held on May 4. Great interest in the Coast Artillery is prevalent throughout Texas. The Corps Area Commander and the Chief of Staff of the 90th Division, Colonel David H. Biddle, Cav., are interested in promoting the in-

terest in the Coast Artillery in the Eighth Corps Area. Recently a new Coast Artillery ROTC Unit was established at Texas A. & M. College and will begin to operate next fall. The Reserve will train at Fort Crockett, Texas, instead of at Barrancas, as heretofore—a detachment of the 69th C. A. (AA) being sent there for that purpose. Major Fulton is the only officer present with the Coast Artillery Reserve in Texas. It is a tribute to his organizing ability that in a territory of such wide open spaces he could succeed in forming a chapter of the Association in Houston. Thirteen members were enrolled at a meeting held on May 4. The following officers were elected:

President: Lt. Jeff Barnette, CA-Res.  
 V. Pres.: Capt. R. L. Knox, CA-Res.  
 Sec.-Treas.: Lt. A. A. Lesiker, CA-Res.  
 Council: Major W. S. Fulton, C.A.C.  
 Lt. J. B. Wilkinson, CA-Res.

Some chapters of the Association have been in existence for a considerable time, several for years. Among these are the following:

*Western Pennsylvania (Pittsburgh)*—This chapter held a dinner at the Hotel Schenley in Pittsburgh during March when the following officials were elected:

President: Capt. Paul O. Langguth, CA-Res.  
 V. Pres.: Capt. T. O. Ryan, C.A. (A.E.F.).  
 Secretary: 1st Lt. Frank R. Sack, CA-Res.  
 Treasurer: 2nd Lt. Kenneth A. Wing, CA-Res.  
 Board of Governors:  
 Lt. Co. J. S. Ervin, CA-Res.  
 Major H. LeR. Muller, C.A.C.  
 Capt. Charles H. Fleming, CA-Res.  
 1st Lt. Armand F. Hoehle, CA-Res.  
 1st Lt. Jason E. Stone, Jr., CA-Res.  
 1st Lt. Lloyd J. Conkel, CA-Res.  
 1st Lt. Carman D. Miller, CA-Res.

The Chapter held its Third Annual Ball at the Pittsburgh Athletic Association on May 8. About one hundred persons were present. Colonel and Mrs. Ervin, Major and Mrs. Muller, Captain and Mrs. T. F. Ryan, and Captain Paul F. Seibold received.

*West Point Chapter*—The newly formed Chapter at West Point met on April 14 with the President, Major Sanderford Jarman, in the chair. The meeting was addressed by Maj. H. R. Harmon, A. C., on "The Royal Air Force." Major Harmon was assistant attache for Air for two years in London and knew his subject. Major Jarman discussed recent Coast Artillery developments based upon information obtained during a recent visit to the Chief's office. Captain H. C. Barnes spoke of the anticipated First Class visit to Fort Monroe. The present officers of the Chapter were reelected due to the short time they had been in office.

This Chapter has answered the question of "What activities should the local chapter conduct?" Officers of the regular army on duty at such places as West Point, Leavenworth, Washington, where the duty is

not with Coast Artillery, can obtain, painlessly, the information necessary to keep them abreast of the developments of their arm.

*Antiaircraft sub-chapter of the Cook County Chapter, Reserve Officers Association (Chicago)*—Although not formally affiliated this organization is considered a chapter of the Coast Artillery Association and will be so recognized upon application. The following officers were recently elected for 1931:

President: Major Rolland E. Hubert, 949th C.A.  
 V. Pres.: Major H. H. Maynard, 950th C.A.  
 Sec.-Treas.: 1st Lt. Richard B. Scharff, 531st C.A.

Several chapters are now in process of formation.

*Cincinnati*—Cincinnati will have two chapters—One will be (or has been) organized at the University of Cincinnati where Major Clifford R. Jones is senior officer on duty with the Coast Artillery ROTC. Over 100 ROTC students have applied for membership and have been made Associate Members of the Association. This is the first ROTC chapter to be formed and is a field for the activity of the Association which gives great promise. Should each ROTC unit establish a chapter of the Association it will not only increase the *esprit* of the students but will serve as a link between the ROTC students and the Reserve which is now sadly lacking. Lt. Col. W. W. Merrill, unit instructor with the Coast Artillery Reserve in Cincinnati, is busy organizing a local chapter among the officers of his units.

*Indianapolis*—Colonel Bowman Elder, 535th, and Major W. G. Patterson, C.A.C., are organizing a chapter in Indianapolis.

*Los Angeles*—Lt. Col. W. G. Peace informs us that a Los Angeles chapter is under way.

*San Francisco*—Major R. H. Fenner, C.A.C. and Major W. R. Miller, 250th C.A. (Cal. N.G.) are consulting with interested officers concerning the formation of a chapter in San Francisco.

## Philadelphia Coast Artillery Reserve Ball

THE Coast Artillery Club of Philadelphia has established an annual social function which bids fair to become traditional. On May 8 the Fourth Annual Military Ball was held in the Rittenhouse Hotel in Philadelphia with an attendance greater than in any previous year. Lt. Col. Samuel T. Phillips, 510th C. A. (AA), President of the Coast Artillery Club, ably assisted by 1st Lieut. H. F. Crawford, Jr., 510th C. A. (AA), Secretary, and 1st Lieut. Martin D. Meyers, 510th C. A. (AA) were the moving spirits behind this affair. Lieut. Meyers is an expert master of ceremonies.

Colonel Clarence R. Day, Chief of Staff, 79th Division, and Major F. A. Hause, C.A.C., unit instructor of the Coast Artillery Reserve in Philadelphia were guests as were many officers of the 315th Infantry.

# COAST ARTILLERY ORDERS

Col. Edward Kimmel, from Army & Navy General Hospital, Hot Springs National Park, to command 62d, Fort Totten.

Col. James L. Long, retired, April 30, on account of disability, in line of duty.

Col. Edward D. Powers, transferred to Finance Dept., Feb. 26.

Lt. Col. Robert C. Eddy, R. O. T. C., M. I. T., Cambridge, Mass., will proceed to his home and await retirement, June 7.

Lt. Col. Howard S. Miller, instructor, C. and G. S. School, Ft. Leavenworth, to 3d C. A., Ft. MacArthur, June 19.

Lt. Col. John C. Ohnstad promoted to Colonel, Feb. 28.

Major Herbert H. Acheson, from student, Army War College, Wash., D. C., to Coast Artillery School, Ft. Monroe, as instructor.

Major Karl F. Baldwin, from student to instructor, C. and G. S. School, Ft. Leavenworth.

Major Henry R. Behrens, student, C. and G. S. School, Ft. Leavenworth, to the Philippines, sailing New York, August 19.

Major Robert M. Carswell, 12th Ft. Monroe, to Coast Artillery School, Ft. Monroe, as student, Sept. 13.

Major W. M. Cravens, student, C. and G. S. School, Ft. Leavenworth, to Org. Res. Wilmington, Del.

Major Carl S. Doney, to Hawaii, sailing San Francisco, Oct. 14, instead of sailing New York, June 23.

Major Richard Donovan, from student, Army War College, Wash., D. C., to Panama, sailing New York, Aug. 7.

Major Henry W. T. Eglin, student, Army Industrial College, Wash., D. C., to Hawaii, sailing New York, Aug. 28.

Major A. F. Englehart, 6th, Ft. Winfield Scott to C. and G. S. School, Ft. Leavenworth, August 20.

Major C. R. Finley, student, C. and G. S. School, Ft. Leavenworth, to Panama, sailing New York, July 9.

Major B. L. Flanigen, student, A. C. T. S., Langley Field, to Panama, sailing New York, July 9.

Major C. A. French, student, A. C. T. S., Langley Field to 62d, Ft. Totten.

Major A. G. Frick, from R. O. T. C., Univ of Alabama, to Hawaii, sailing New York, July 17.

Major W. M. Goodman, student, C. and G. S. School, Ft. Leavenworth, to Hawaii, sailing New York, August 12.

Major R. E. Haines, G. S., 8th Corps Area, Ft. Sam Houston to office Chief of Coast Artillery, Wash., D. C., August 1.

Major I. B. Hill, student, C. and G. S. School, Ft. Leavenworth, to Hawaii, sailing New York, August 2.

Major T. H. Jones, student, Army War College, Wash., D. C., to the Philippines, sailing New York, August 19.

Major C. B. Lindner, student, C. and G. S. School, Ft. Leavenworth, upon completion of present course of instruction.

Major C. T. Marsh, student, C. and G. S. School, Ft. Leavenworth to 62d, Ft. Totten.

Major F. A. Mountford, student, Army War College, Wash., D. C., to Hawaii, sailing New York, August 28.

Major M. J. O'Brien, to Hawaii, sailing New York, Sept. 23, instead of July 17.

Major Hugo E. Pitz, from R. O. T. C., Univ. of New Hampshire, Durham, to Quartermaster Corps, Ft. Benjamin Harrison, Ind., August 15.

Major W. K. Richards, instructor, Coast Artillery School, Ft. Monroe, to Panama, sailing New York, July 9.

Major Otto H. Schrader, from Panama to Univ. of Pittsburgh, Pittsburgh.

Major Edward A. Stockton, Jr., student, Army War College, Wash., D. C., to 2nd, Ft. Totten.

Major Robert E. Turley, student, C. and G. S. School, Ft. Leavenworth to Panama, sailing New York, August 7.

Major E. H. Underwood, student, Coast Artillery School, Ft. Monroe, to R. O. T. C., Univ. of Alabama.

Major W. C. Washington, student, C. and G. S. School, Ft. Leavenworth, to instructor, Oregon Natl. Guard, Salem.

Major Meade Wildrick, from Org. Res., Wilmington, Del., to Org. Res., New York, Aug. 1.

Major E. N. Woodbury, student, Army War College, Wash., D. C., to C. and G. S. School, Ft. Leavenworth.

Capt. Carl R. Adams, student, Coast Artillery School, Ft. Monroe, to Panama, sailing New York, July 9.

Capt. Nyal L. Adams, from Hawaii, to Coast Artillery School, Ft. Monroe.

Capt. Sam W. Anderson, 12th, Ft. Monroe, to Coast Artillery School, Ft. Monroe, as student, Sept. 13.

Capt. Harold G. Archibald, from student, Coast Artillery School, Ft. Monroe, to Hawaii, sailing New York, July 17.

Capt. Reamer W. Argo, from Philippines to Coast Artillery School, Ft. Monroe, as student.

Capt. E. R. Barrows, student, Coast Artillery School, Ft. Monroe, to 12th, Ft. Monroe.

Capt. T. R. Bartlett, student, Coast Artillery School, Ft. Monroe, to 63d, Ft. MacArthur, Calif., sailing New York, Aug. 19.

Capt. Philip F. Biehl, 12th, Ft. Monroe to Coast Artillery School, Ft. Monroe, as student, Sept. 13.

Capt. H. H. Blackwell, from student, Coast Artillery School, Ft. Monroe, to the Philippines, sailing New York, Aug. 19.

Capt. George Blaney, student, Coast Artillery School, Ft. Monroe, to Panama, sailing New York, Aug. 7.

Capt. Benjamin Bowering, from Panama, to C. and G. S. School, Ft. Leavenworth, August 29.

Capt. Louis J. Bowler, student, Coast Artillery School, to 52d, Ft. Monroe.

Capt. W. G. Brey, 6th, Ft. Winfield

Scott, to Ft. Monroe, sailing San Francisco, August 5.

Capt. Oliver B. Bucher, from R. O. T. C., V. P. I., Blacksburg, to Coast Artillery School, Ft. Monroe, as student, Sept. 13.

Capt. Edwin C. Callicutt, retired, March 31, on account of disability in line of duty.

Capt. Homer Case, from Coast Artillery School, Ft. Monroe to C. and G. S. School, Ft. Leavenworth, Aug. 20.

Capt. Robert T. Chaplin, 61st, Ft. Sheridan, to R. O. T. C., V. P. I., Blacksburg, Sept. 1.

Capt. Albert C. Chesledon, student, Coast Artillery School, Ft. Monroe, to 62d, Ft. Totten.

Capt. F. L. Christian, 52d, Ft. Monroe, to Coast Artillery School, Ft. Monroe, as student, Sept. 13.

Capt. H. W. Cochran, 51st, Ft. Monroe, to Coast Artillery School, Ft. Monroe, as student, Sept. 13.

Capt. B. C. Dailey, 51st, Ft. Monroe, to Coast Artillery School, Ft. Monroe, as student, Sept. 13.

Capt. J. T. deCamp, student, Coast Artillery School, Ft. Monroe, to student, Advanced Engineering Course, Sept. 7.

Capt. James G. Devine, Pacific Branch U. S. Disciplinary Barracks, Alcatraz, to Ft. Monroe, sailing San Francisco, August 5.

Capt. Franklin E. Edgecomb, from Coast Artillery School, Ft. Monroe, to C. and G. S. School, Ft. Leavenworth, Aug. 20.

Capt. F. G. Epling, from 13th, Ft. Barrancas, to C. and G. S. School, Ft. Leavenworth, Aug. 20.

Capt. R. T. George, student, Coast Artillery School, Ft. Monroe, to 11th, Ft. H. G. Wright.

Capt. Walter R. Goodrich, from Hawaii, to R. O. T. C., Utah State Agricultural College, Logan.

Capt. A. W. Gower, 52nd, Ft. Monroe, to Coast Artillery School, Ft. Monroe, as student, Sept. 13.

Capt. D. B. Greenwood, from Panama to Coast Artillery School, Ft. Monroe, as student.

Capt. F. H. Hastings, 12th, Ft. Monroe, to Coast Artillery School, Ft. Monroe, as student, Sept. 13.

Capt. Hugh N. Herrick, from office Chief of Coast Artillery, Wash., D. C., to C. and G. S. School, Ft. Leavenworth.

Capt. B. T. Ipock, from student, Coast Artillery School, Ft. Monroe, to duty U. S. Disc. Bks., Governors Island, New York.

Capt. Leslie W. Jefferson, from recruiting, Ft. Logan, to 12th, Ft. Monroe.

Capt. A. W. Jones, from Panama, to 3d, Ft. Stevens, Oregon.

Capt. R. C. Jones, from Washington University, St. Louis, Mo., to Hawaii, sailing New York, August 12.

Capt. Edgar W. King, from Atlantic Branch, U. S. Disciplinary Barracks, Governors Island, to Panama, sailing New York, Aug. 7.

Capt. F. H. Koerbel, Submarine Mine Depot, Ft. Monroe, to Coast Artillery School, Ft. Monroe, as a student, Sept. 13.

Capt. Rolla V. Ladd, from N. G., Little Rock, Arkansas, to C. and G. S. School, Ft. Leavenworth, Aug. 29.

Capt. Frederiek Lofquist, student, Coast Artillery School, Ft. Monroe, to 62d, Ft. Totten.

Capt. LeRoy H. Lohmann, from 7th, Ft. Hancock, to C. and G. S. School, Ft. Leavenworth, August 20.

Capt. William F. Marquat, from 61st, Ft. Sheridan, to C. and G. S. School, Ft. Leavenworth, August 20.

Capt. Lawrence C. Mitchell, 51st, Ft. Monroe, to Coast Artillery School, Ft. Monroe, as student, Sept. 13.

Capt. James B. Muir, Jr., 6th, Ft. Baker, to student, Coast Artillery School, Ft. Monroe, sailing San Francisco, August 5.

Capt. George R. Owens, from 3d, Ft. Stevens, to Panama, sailing San Francisco, June 20.

Capt. T. R. Parker, from Hawaii, to C. and G. S. School, Ft. Leavenworth, August 29.

Capt. Ernest R. Percy, Walter Reed Hospital, Wash., D. C., to recruiting, New York.

Capt. Harry R. Pierce, 8th, Ft. Preble, to Ft. Monroe, as student, Sept. 13.

Capt. J. D. Powers, from Panama, to Coast Artillery School, Ft. Monroe, as student.

Capt. J. F. Stiley, 12th, Ft. Monroe, to Coast Artillery School, Ft. Monroe, as student, Sept. 13.

Capt. Edmund H. Stillman, to Hawaii, sailing San Francisco, Oct. 14.

Capt. Louis H. Thompson, from Hawaii, to N. G., Statesboro, Ala., as instructor.

Capt. Edward W. Timberlake, U. S. M. A., West Point, to Coast Artillery School, as student, Ft. Monroe, Sept. 13.

Capt. Frederick L. Topping, student, Coast Artillery School, Ft. Monroe, to 14th, Ft. Worden, sailing New York, Aug. 19.

Capt. R. J. Van Buskirk, 12th, Ft. Monroe, to Coast Artillery School, Ft. Monroe, as student, Sept. 13.

Capt. A. V. Winton, student, Coast Artillery School, Ft. Monroe, to Hawaii, sailing New York, Aug. 28.

1st Lt. W. I. Allen, student, M. I. T., Cambridge, to the Philippines sailing New York, Aug. 19.

1st Lt. Granger Anderson, from U. S. M. A., West Point, to Panama, sailing New York, August 19.

1st Lt. Wayne L. Barber, 62d, Ft. Totten, to Coast Artillery School, Ft. Monroe, as student, Sept. 13.

1st Lt. W. I. Brady, from student, Coast Artillery School, Ft. Monroe, to Hawaii, sailing New York, Aug. 28.

1st Lt. George R. Burgess, student, Army Industrial College, Wash., D. C., to Panama, sailing New York, July 9.

1st Lt. Nathaniel A. Burnell, 52d, Ft. Monroe, to Coast Artillery School, Ft. Monroe, as student, Sept. 13.

1st Lt. James B. Carroll, student, Coast Artillery School, Ft. Monroe, to 7th, Ft. Hancock.

1st Lt. Martin C. Casey, from Hawaii, to 6th, Ft. Winfield Scott, Calif.

1st Lt. Ben E. Cordell, 12th, Ft. Monroe, to Coast Artillery School, Ft. Monroe, as student, Sept. 13.

1st Lt. Robert W. Crichlow, Jr., student, Coast Artillery School, Ft. Monroe, to student, Advanced Gunnery Course, Dec. 1.

1st Lt. John W. Davis, 13th, Ft. Moultrie, to Coast Artillery School, Ft. Monroe, as student, Sept. 13.

1st Lt. Lee A. Denson, Jr., from Panama, to Coast Artillery School, Ft. Monroe, as student.

1st Lt. Frederiek B. Dodge, Jr., student, Coast Artillery School, Ft. Monroe, to student, Advanced Engineering Course, Sept. 7.

1st Lt. Edward A. Dolph, 62d, Ft. Totten, to Coast Artillery School, Ft. Monroe, as student, Sept. 13.

1st Lt. William H. J. Dunham, from recruiting, Denver, Colo., to 51st, Ft. Monroe.

1st Lt. John W. Dwyer, 52nd, Ft. Monroe, to Hawaii, sailing New York, May 26.

1st Lt. E. E. Elliott, 12th, Ft. Monroe, to Coast Artillery School, Ft. Monroe, as student, Sept. 13.

1st Lt. Hamilton P. Ellis, 12th, Ft. Monroe, to Coast Artillery School, Ft. Monroe, as student, Sept. 13.

1st Lt. E. Carl Engelhart, 12th, Ft. Monroe, to Coast Artillery School, Ft. Monroe, as student, Sept. 13.

1st Lt. John M. England, 11th, Ft. H. G. Wright, to Coast Artillery School, Ft. Monroe, as student, Sept. 13.

1st Lt. George A. Ford, 52d, Ft. Monroe, to Coast Artillery School, Ft. Monroe, as student, Sept. 13.

1st Lt. Ovid T. Forman, 62d, Ft. Totten, to Coast Artillery School, Ft. Monroe, as student, Sept. 13.

1st Lt. Charles W. Gettys, 12th, Ft. Monroe, to Coast Artillery School, Ft. Monroe, as student, Sept. 13.

1st Lt. G. G. Gibbs, 52nd, Ft. Hancock, to Coast Artillery School, Ft. Monroe, as student, Sept. 13.

1st Lt. Ralph I. Glasgow, 11th, Ft. H. G. Wright, to Coast Artillery School, Ft. Monroe, as student, Sept. 13.

1st Lt. Sanford J. Goodman, Ft. Hancock, to Coast Artillery School, Ft. Monroe, as student, Sept. 13.

1st Lt. Franklin K. Gurley, 52d, Ft. Monroe, to Coast Artillery School, Ft. Monroe, as student, Sept. 13.

1st Lt. John L. Hanley, R. O. T. C., from Utah State Agricultural College, Logan, to Coast Artillery School, Ft. Monroe, as student, Sept. 13.

1st Lt. James L. Harbaugh, Jr., student, Coast Artillery School, Ft. Monroe, to R. O. T. C., Fordham University, Fordham, N. Y.

1st Lt. Joseph E. Harriman, from Hawaii, to Coast Artillery School, Ft. Monroe, as student.

1st Lt. John Harry, 14th, Ft. Worden, to Coast Artillery School, Ft. Monroe, as student, Sept. 13.

1st Lt. Paul L. Harter, 64th, Hawaii, to 6th, Ft. Winfield Scott.

1st Lt. M. A. Hatch, student, Coast Artillery School, Ft. Monroe, to student, Advanced Gunnery Course, Dec. 1.

1st Lt. James L. Hogan, from student, Coast Artillery School, Ft. Monroe, to Panama, sailing New York, July 9.

1st Lt. William G. Holder, student, Coast Artillery School, Ft. Monroe, to

14th, Ft. Worden, sailing New York, Aug. 19.

1st Lt. David Hottenstein, from student, Coast Artillery School, Ft. Monroe, to the Philippines, sailing New York, August 19.

1st Lt. James F. Howell, Jr., student, Coast Artillery School, Ft. Monroe, to 3rd, Ft. Stevens.

1st Lt. W. L. Johnson, 11th, Ft. H. G. Wright, to Coast Artillery School, Ft. Monroe, as student, Sept. 13.

1st Lt. F. B. Kane, from U. S. M. A., West Point, to Panama, sailing New York, August 19.

1st Lt. G. J. Kelley, from student, Coast Artillery School, Ft. Monroe, to the Philippines, sailing New York, August 19.

1st Lt. Lewis S. Kirkpatrick, 63d, Ft. MacArthur, to Coast Artillery School, Ft. Monroe, as student, Sept. 13.

1st Lt. R. H. Krueger, 51st, Ft. Monroe, to Coast Artillery School, Ft. Monroe, as student, Sept. 13.

1st Lt. L. L. Lemnitzer, student, Coast Artillery School, Ft. Monroe, to the Philippines, sailing New York, August 19.

1st Lt. J. E. McGraw, student, Coast Artillery School, Ft. Monroe, to M. I. T., Cambridge, Oct. 1, as student.

1st Lt. W. B. Merritt, 12th, Ft. Monroe, to Panama, sailing New York, July 9.

1st Lt. F. A. Mitchell, 12th, Ft. Monroe, to Coast Artillery School Ft. Monroe, as student, Sept. 13.

1st Lt. Lew M. Morton, 12th, Ft. Monroe, to 62d, Ft. Totten.

1st Lt. O. A. Nelson, student, Coast Artillery School, Ft. Monroe, to Hawaii, sailing New York, June 23.

1st Lt. Glenn Newman, 52d, Ft. Hancock, to Coast Artillery School, Ft. Monroe, as student, Sept. 13.

1st Lt. W. L. Richardson, student, Coast Artillery School, Ft. Monroe, to student, Advanced Gunnery Course, Dec. 1.

1st Lt. Grayson Schmidt, 51st, Ft. Monroe, to Coast Artillery School, Ft. Monroe, as student, Sept. 13.

1st Lt. Cortlandt Van R. Schuyler, from U. S. M. A., West Point, to Panama, sailing New York, Oct. 22.

1st Lt. Pacifico C. Sevilla, 92d, Ft. Mills, P. I., to Coast Artillery School, Ft. Monroe, as student, Sept. 13.

1st Lt. C. E. Shepherd, 52d, Ft. Hancock, to Coast Artillery School, Ft. Monroe, as student, Sept. 13.

1st Lt. Logan O. Shutt, student, Coast Artillery School, Ft. Monroe, to Hawaii, sailing New York, Sept. 23.

1st Lt. Will K. Stennis, 52d, Ft. Monroe, to Coast Artillery School, Ft. Monroe, as student, Sept. 13.

1st Lt. Harold P. Tasker, student, Coast Artillery School, Ft. Monroe, to the Philippines, sailing New York, August 19.

1st Lt. E. B. Thompson, 12th, Ft. Monroe, to Coast Artillery School, Ft. Monroe, as student, Sept. 13.

1st Lt. D. C. Tredemnick, 51st, Ft. Monroe, to R. O. T. C., Univ. of Pittsburgh, July 23.

1st Lt. G. A. Tucker, 62d, Ft. Totten, to Coast Artillery School, Ft. Monroe, as student, Sept. 13.

1st Lt. H. J. Vandersluis, 13th, Ft. Barrancas, to Coast Artillery School, Ft. Monroe, as student, Sept. 13.

1st Lt. L. D. Viehules, 12th, Ft. Monroe, to Coast Artillery School, Ft. Monroe, as student, Sept. 13.

1st Lt. Vern Walbridge, 52d, Ft. Hancock, to Coast Artillery School, Ft. Monroe, as student, Sept. 13.

1st Lt. T. L. Waters, from recruiting, Philadelphia, to Coast Artillery School, Ft. Monroe, as student, Sept. 13.

1st Lt. W. H. Webb, student, Coast Artillery School, Ft. Monroe, to Hawaii, sailing New York, Sept. 23.

1st Lt. Charles M. Wolff, student, Coast Artillery School, Ft. Monroe, to Hawaii, sailing New York, July 17.

2nd Lt. B. M. Alba, student, Quarter master Corps Motor Transport School, Baltimore, to the Philippines, sailing New York, Aug. 19.

2nd Lt. C. C. Carter, 62d, Ft. Totten, to Coast Artillery School, Ft. Monroe, as student, Sept. 13.

2nd Lt. George A. Chester, 6th, Ft. Winfield Scott, to Hawaii, sailing San Francisco, July 15.

2nd Lt. John W. Davis, promoted to 1st Lt., March 1.

2nd Lt. M. H. Harwell, 51st, Ft. Monroe, to Coast Artillery School, Ft. Monroe, as student, Sept. 13.

2nd Lt. Henry Joseph Hoeffler, transferred to Corps of Engineers, April 4, Fort Lewis, Wash. Orders to Ft. Barrancas revoked.

2nd Lt. Robert L. Miller, from the Philippines to 52nd, Ft. Hancock.

2nd Lt. Leif Neprud, 12th, Ft. Monroe, to Coast Artillery School, Ft. Monroe, as student, Sept. 13.

2nd Lt. Arthur Roth, 51st, Ft. Monroe, to Coast Artillery School, Ft. Monroe, as student, Sept. 13.

2nd Lt. Samuel V. Stephenson, transferred to Air Corps, March 14.

2nd Lt. Legare K. Tarrant, from Panama, to 52nd, Ft. Monroe, Va.

2nd Lt. Louis T. Vickers, from Hawaii, to 51st, Ft. Monroe.

2nd Lt. Daniel McC. Wilson, from the Philippines to 62nd, Ft. Totten.

Warrant Officer George H. Buchholz, from 12th C. A. Ft. Monroe, to 6th Inf., Jefferson Barracks, Mo.

Master Sgt. Joseph Stirni, retired, Ft. Monroe, March 31.

1st Sgt. James F. Dougherty, 59th, retired, Ft. Mills, April 30.

1st Sgt. Fred Meissner, 62nd, retired, April 30, Ft. Monroe.

1st Sgt. John F. White, 4th, retired, Ft. Amador, April 30.

Sgt. Charles P. Titus, 2nd, retired, Ft. Sherman, March 31.

Private Roy Riha, 6th, Ft. Winfield Scott, Calif., appointed warrant officer, March 12.



General Summerall and Col. Ottmann During a Visit by the Chief of Staff to the 212th C.A. (AA) (NYNG) at Fort Ontario, N. Y.

## BOOK REVIEWS

**MY EXPERIENCES IN THE WORLD WAR**, by General John J. Pershing. Frederick A. Stokes Company, New York, 1931. Two Volumes. Illustrated. Cloth. 836 pages, indexed. \$10.00.

No student of the history of the World War can neglect an account of it written by one of the Allied Commanders. As Commander in Chief of the American Expeditionary Forces, General Pershing has written an historical document which members of the military profession everywhere should read and absorb. In chronological form and in very interesting manner he describes the American participation in the World War from the view-point of the Commander in Chief, with emphasis on the questions of policy which his responsible position thrust upon him.

In the early chapters of his book General Pershing dwells strongly on the lamentable unpreparedness with which America entered the greatest conflict which the world has ever seen. While his criticism of this condition may be resented by some who were in responsible positions, the reader is impressed with the fact that the General's purpose is not to place blame, but to prevent recurrence.

The book is filled with quotations from the Commander in Chief's diary which convince the student that the facts are as stated, and not afterthoughts. General Pershing's account of the war is almost unique in that very little acrimoniousness appears in it. He mentions differences of opinion, but with an absence of vituperation which emphasizes the dignity of the author and his calm appreciation of values. The book indicates that General Pershing had a confidence in himself and in the capabilities of the American Army which never deserted him. This is one of the highest attributes of leadership.

The student of history (and particularly of American history) will be impressed with the lack of "politics" which existed during the World War. There were no "political" generals, as there were in the Civil War. The subordinate commanders stood entirely upon their merits. It is obvious that this system might cause hard feelings and perhaps a sense of injustice in some individuals affected, but it is the only system which will win wars in the shortest possible time and with the least loss in lives and treasure.

The absence of "politics" came from the support and backing which General Pershing received from the President and the Secretary of War. This support is nowhere more apparent than in the discussion of the use of the American Army in France. It is well known that the British and the French brought extreme pressure to bear in order to induce General Pershing to agree to the replacement policy which they advocated. A weaker man would have been gradually worn down. Nor were their efforts confined to the almost continuous argument with the Commander in Chief: they included

an appeal to his government over his head and behind his back. It required a leader of exceptionally strong character to stick to his soundly reached opinion when there must have been doubts that he might not be jeopardizing the allied success.

Much of General Pershing's book is concerned with his experience with the other allied leaders who insisted that the American Army be used only for replacements, that it be not organized as a separate command. General Pershing's decision displays that type of extra-military knowledge which every great military leader should possess. He knew that the temperament and national characteristics of the American people are such that they never would have consented to arrangements such as our Allies proposed, that it is not in our nature to play second fiddle or to be placed in a position in which American initiative and ingenuity cannot be utilized. General Pershing states that American morale would have suffered through contact with our Allies, who were then almost in a defeatist state of mind, and that differences in temperament, in language, in habits, even in language, would have added to the difficulties.

If General Pershing seems to overemphasize the problem of the status of the American Army it is because it was a troublesome and ever present one to him. Perhaps his stand had more to do with the position of the United States in the peace negotiations than will appear to the casual reader. Without the prestige acquired by American troops acting as a separate army, it is entirely possible that a peace might have been consummated which would soon again have involved the World in a conflict even more disastrous than the last one.

== == ==

**THE RISE OF U. S. GRANT** by Colonel A. L. Conger. U. S. A., Retired. The Century Company, New York, 1931. 377 pages. \$5.00.

Here is a book on military affairs that occupies the same relationship to other military books that the slow motion picture does to the regular pictures. Reading it is like being instructed by the slow motion camera. The step by step process of the making of a general officer is slowly and clearly unfolded before the eyes of the reader in a fashion that is not only unusual, but unusually interesting. Colonel Conger makes no attempt to write a complete biography of General Grant, but confines himself to the Civil War period of Grant's life, and more especially to the early part of the War, when Grant was an unknown and obscure officer in the west.

The bibliography used is most complete, but the author relies very little on General Grant's own Memoirs, written years after the event narrated, nor does he lean very strongly on the various contemporary writers, most of whom had a strong bias for or

against Grant. He does, however, make use of the official records, and compels Grant to tell of his thoughts, actions, and mistakes, and the lessons that he learned from them, in his own written words.

The training of General Grant for his final command and responsibility was almost perfect. First we find him as the commander of a regiment of Illinois volunteer infantry, and concerned with his own immediate job of training and equipping. His experience in the Mexican War as a regimental quartermaster is of great help to him here. Then his promotion to brigadier general and larger responsibilities in Missouri. His aggressive spirit keeps him more or less continuously in trouble with his superiors, but they recognize his growing ability, and keep promoting him to larger commands and responsibilities. As a district commander with headquarters at Cairo, Illinois, he learns more of the art of being a commander, and also acquires more tact in dealing with both seniors and subordinates. He commands the expedition against Forts Henry and Donelson, and any tendency to get an exaggerated opinion of his own powers and ability is quickly squashed by the treatment afforded him by General Halleck. For a period here he learns to take abuse and injustice without quitting. During this time of enforced inactivity he gives considerable thought to the larger strategical problems of the war, and more especially the importance of the western theatre of the war as it applied to the economic situation of both the North and the South. We see the results of this period of thinking later on in his grand plan for the consummation of the war.

To the reader who seeks new light on the larger campaigns of the Civil War, "The Rise of General Grant" will not offer anything extraordinarily new. The author sticks to his main idea very closely, that is, the Rise of General Grant. Except for emphasis given to General Grant's strategical plans for the ending of the war, the Vicksburg Campaign, the Wilderness Campaign, and finally the operations around Petersburg, are given scant notice. It is the small battles early in the war in the West, and the gradual enlargement of commands and responsibilities that made Grant, upon which the author dwells.

The book is intensely interesting to a soldier because the teachings of loyalty, duty, devotion to ones command rather than self-advancement, are here brought out vividly and in a manner that all who are not blind can read—and benefit by. It was this part of Grant's character, in addition to his aggressiveness and common-sense, that enabled him to profit by the daily lessons taught by war, and rise above all the others to the supreme command of all the Armies of the United States. Your reviewer recommends this book to all officers.

≡ ≡ ≡ ≡

MARINES AND OTHERS, by Captain John W. Thomason, Jr. Scribner's, New York, 1929. 290 pages. \$3.00. illustrated by the author.

This collection of ten short stories by Captain

## Was Grant an Accident? Or Was he a Self-Made Success?

Col. A. L. Conger, U. S. A., points  
the answer in his new book

### The Rise of U. S. Grant

In answering the question of whether his honors were really earned or were due to chance, General Grant has been made to tell his story in his own words, as he recorded it in reports and battlefield messages. And in the process Col. Conger brilliantly analyzes much of the strategy of the Civil War.

A NEW PICTURE OF THE  
SOLDIER GRANT

Well Mapped and Illustrated

Price \$5.00, Postpaid

**The Coast Artillery Journal**

1115 17th Street, N. W. Washington, D. C.

## Warfare

**A Study of Military Methods From  
the Earliest Times**

by

Col. O. L. Spaulding, Capt. H. Nickerson  
and Col. J. W. Wright

A comprehensive and scholarly study of wars and battles from earliest times through Frederick the Great.

From early oriental wars to the campaigns of the eighteenth century the decisive battles of history are interestingly described and analyzed for their military significance and results.

Fascinating reading and helpful knowledge.

600 pages, with maps, bound in cloth.

**This is a Limited Edition**

Price \$4.00, Postpaid

**The Coast Artillery Journal**

1115 17th Street, N. W. Washington, D. C.

Thomason of the Marines is in his usual style. The illustrations are virile. The stories, mostly about Marines afloat and ashore, are written with the sympathetic touch of a man who knows the Devil Dogs, as they like to be called.

The titles of the stories, *The Letter Home*, *Love Story of a Marine*, *Before the Rain*, *War Dog*, *Hate*, *Distinguished Service Cross*, *Tell It to the Marines*, *Air Patrol*, *The Marines See the Revolution*, and *Crossing the Line with Pershing*, indicate their subject matter.

If you are looking for action, description, adventure and life—read “Marines and Others.”

== == ==

**MOUNT VERNON**, by Minnie Kendall Lowther. The John C. Winston Company, Philadelphia, 1930. 282 pages. \$2.00.

This little volume will serve not only as an excellent guide for a visit to present day Mount Vernon, but also contains much interesting information concerning its early history and that of the Washington family. It traces George Washington's ancestors and descendants, together with the several allied families, and tells the story of the Popes, the Warners, the Reades, the Martineaus, and the Balls, with the anecdotes and pictures of the old manors in which they lived. The story of Nelly Custis is feelingly told. In fact, the whole work is a work of love on the part of the author, who has apparently devoted years to careful research. As a result, it offers a compact compendium of information upon the genealogy of four of the most noted families of colonial times, the Washingtons, the Custises, the Lewises, and the Lees. The last part of the volume deals with the mansions of Abingdon, Woodlawn, Audley, Arlington, and the White House on the Pamunky.

In view of the approaching celebration in commemoration of the two hundredth anniversary of the birth of Washington, “Mount Vernon” should prove of value and interest to many readers.

== == ==

**BEST SHORT STORIES OF THE WAR**, edited by H. C. Mincin, André Maurois, Arnald Zweig, and Coningsby Dawson. Harper's, New York, 1931. 826 pages. \$3.50.

This anthology is made up of sixty short stories selected from American, British, French, and German writers. Some few are extracts of novels.

“Fine writing” and ability to move one to pity seem to be the main tests applied by the editors in making their selection. The collection would be infinitely more entertaining—and that, in the final analysis, is why one reads short stories—if it contained more stories written in the lighter vein.

Craftsmanship and short story technique they all possess, and are therefore good models for study for those who try their hand at writing.

## THE REMINISCENCES OF A MARINE

by

Maj.-Gen. John A. Lejeune

Formerly Commandant,  
U. S. Marine Corps

*Profusely Illustrated*



The military student will find of incalculable value, the chapters dealing with the battles of ST. MIHIEL, BLANC MONT RIDGE and the MEUSE-ARGONNE, the march into Germany and the occupation of the Rhineland.

A Stirring Autobiography of a  
Fighting Man, Interestingly Told

Price \$4.15, Postpaid

**The Coast Artillery Journal**  
1115 17th Street, N. W. Washington, D. C.

## The Old Army Memories

by

Maj.-Gen. James Parker  
U. S. A.

Medal of Honor, D. S. M.

*Profusely Illustrated*



The “NEW ARMY” has in THE OLD ARMY an interesting, authentic story of those thrilling days of which they have heard so often—days of *hardship, privation and danger*.

You OLDSTERS who lived in the days of the Dougherty Wagon and the Buckboard will find THE OLD ARMY a vivid picture of the days you love to think and talk about.

Price \$4.15 Postpaid

**The Coast Artillery Journal**  
1115 17th Street, N. W. Washington, D. C.