

LONG-TERM MICROWAVE POWER DRIFT OF A CESIUM FREQUENCY STANDARD AND ITS EFFECT ON OUTPUT FREQUENCY

W. A. Johnson,
S. K. Karuza, and F. J. Voit
Electronics Research Laboratory
The Aerospace Corporation
P. O. Box 92957
Los Angeles, CA 90009

Abstract

It has been shown previously that the long-term frequency stability of a cesium (Cs) frequency standard is affected by variations in the standard's internal microwave power source [1,2]. Studies were performed on a commercial Cs frequency standard for a period of 20 days, to determine the stability of its microwave power source. The results were then analyzed statistically, and the effects of microwave power drift on the standard's frequency stability were calculated.

INTRODUCTION

Studies were performed in our laboratory on cesium (Cs) frequency standards (clocks) made by different manufacturers, to determine the effect of microwave power variations on the output frequency of the standard at different settings of the C-field current. Figure 1 is a block diagram of the test set-up. The results were reported in [3,4]. In one particular Cs frequency standard, we wanted to determine the stability of its own internal microwave power source and the effect of this stability on the frequency stability of the standard.

During the last 20 days of the experiment the zero offset of the microwave power meter was recorded manually. These data were then used to correct the actual measured microwave power values by enabling power meter drift to be eliminated. These results are reported herein. We note that because we have many components in series with the clock electronics, we cannot say that the power variations we measured are completely attributable to the clock itself. It is likely that the resulting power variations are somewhat worse than would be the case for a normal clock configuration.

Report Documentation Page

Form Approved
OMB No. 0704-0188

Public reporting burden for the collection of information is estimated to average 1 hour per response, including the time for reviewing instructions, searching existing data sources, gathering and maintaining the data needed, and completing and reviewing the collection of information. Send comments regarding this burden estimate or any other aspect of this collection of information, including suggestions for reducing this burden, to Washington Headquarters Services, Directorate for Information Operations and Reports, 1215 Jefferson Davis Highway, Suite 1204, Arlington VA 22202-4302. Respondents should be aware that notwithstanding any other provision of law, no person shall be subject to a penalty for failing to comply with a collection of information if it does not display a currently valid OMB control number.

1. REPORT DATE DEC 1990		2. REPORT TYPE		3. DATES COVERED 00-00-1990 to 00-00-1990	
4. TITLE AND SUBTITLE Long-Term Microwave Power Drift of a Cesium Frequency Standard and Its Effect on Output Frequency				5a. CONTRACT NUMBER	
				5b. GRANT NUMBER	
				5c. PROGRAM ELEMENT NUMBER	
6. AUTHOR(S)				5d. PROJECT NUMBER	
				5e. TASK NUMBER	
				5f. WORK UNIT NUMBER	
7. PERFORMING ORGANIZATION NAME(S) AND ADDRESS(ES) The Aerospace Corporation, Electronics Research Laboratory, P.O. Box 92957, Los Angeles, CA, 90009				8. PERFORMING ORGANIZATION REPORT NUMBER	
9. SPONSORING/MONITORING AGENCY NAME(S) AND ADDRESS(ES)				10. SPONSOR/MONITOR'S ACRONYM(S)	
				11. SPONSOR/MONITOR'S REPORT NUMBER(S)	
12. DISTRIBUTION/AVAILABILITY STATEMENT Approved for public release; distribution unlimited					
13. SUPPLEMENTARY NOTES See also ADA239372. 22nd Annual Precise Time and Time Interval (PTTI) Applications and Planning Meeting, Vienna, VA, 4-6 Dec 1990					
14. ABSTRACT see report					
15. SUBJECT TERMS					
16. SECURITY CLASSIFICATION OF:			17. LIMITATION OF ABSTRACT Same as Report (SAR)	18. NUMBER OF PAGES 11	19a. NAME OF RESPONSIBLE PERSON
a. REPORT unclassified	b. ABSTRACT unclassified	c. THIS PAGE unclassified			

MEASUREMENTS

During the 20-day measurement period there were three separated data runs lasting approximately 3, 6, and 10 days. At the beginning of each run the power meter was zeroed. Because we could not zero the meter during a run without stopping the program, we periodically increased the microwave attenuator setting by 60 dB and read the meter's output in microwatts. During the data taking, the power level into the meter was on the order of $50 \mu\text{W}$. Sixty dB below this is thus $50 \times 50^{-6} \mu\text{W}$, which is very much less than the smallest nonzero power ($0.01 \mu\text{W}$) that the system can read. Thus, increasing the attenuation by 60 dB was equivalent to terminating the meter with a load; indeed, it was probably better, because no microwave connections were changed. The measured power offsets are plotted in Figure 2.

Each of the three data runs consisted of the following steps:

1. Set the C-field at a low value (6 to 8 mA) and the power at the optimum value (i.e., for maximum beam current) of -12.5 dBm .
2. Measure the beat frequency over some long averaging time T .
3. Increase the power level by 1 dB to -11.5 dBm .
4. Measure the beat frequency over T again.
5. Increase the C-field current by some prescribed amount (typically 1 mA in our data sequence).
6. Measure the beat frequency over T again.
7. Change the power back to -12.5 dBm .
8. Measure the beat frequency over T again.
9. Increase the current again.
10. And so on.

The last C-field current is typically 22 mA.

Each time either the C-field current or the microwave power is changed, there is a waiting period of approximately 5 minutes before data taking begins. This wait ensures that if the clock loop goes out of lock, it will have more than adequate time to relock. For the particular clock measured, the maximum time to acquire relock is about 2 minutes. It is during these 5-minute waits that the power meter's zero offset is read. Figure 2 is a plot of these zero offsets as a function of time. Note that the offsets are all either zero or negative. A negative value for the offset means that all powers measured are actually larger by the amount of the offset.

Figure 3 is a plot versus time of the two measured power levels. The corrected power data were fit with a second-order function, i.e., $a_0 + a_1t + a_2t^2$. Figure 4 is a plot versus time of the high and low power-level fits, and Figure 5 is a plot, versus time, of the difference between the two fits. Figures 6 and 7 are plots of the residuals that are left after the fit curve is subtracted from the corrected power data.

To determine the contribution of the power measurement equipment, the stability of the actual power meter used to obtain the data was measured. Figure 8 is a block diagram of the measurement system. Figures 9 and 10 show the results of two long data runs, one for about 10 days and the other for about 16 days. Each data point is for an averaging time of about 2.8 hr. Note that the standard deviation of each data set is much less than the standard deviations in Figures 6 and 7. The data-point separation in time for Figures 6 and 7 varies, but it is close as 0.14 days (3.36 hr) and this is comparable to that in Figures 9 and 10. The conclusion is that drifts in the power meter, in its calibrator, and in the power measurement head contribute negligibly to the measurements plotted in Figures 6 and 7.

DATA STATISTICS

Because of the very regular manner in which the data were taken, there occurred systematic time separations in the data of 0.14 and 0.41 days. The data could also be averaged to give results for 0.82 and 2.5 days. These data were then analyzed statistically. The results are summarized in Table I. Column 1 is the time τ between measurements. Column 3 is the Allan standard deviation of the power as a function of τ . Column 2 is the number of data points used to calculate the results in Column 3. Figure 11 is a plot of the change in clock output frequency for a 1-dB change in microwave power as a function of the C-field setting. The factor 8×10^{-13} comes from Figure 11 and represents about the worst C-field-setting coefficient of frequency change per dB of power change over the Zeeman frequency range 25 to 51.5 kHz. Column 4 is approximately the maximum Allan standard deviation that would be caused by the power changes in column 3. Column 5 has calculated values of $3.55 \times 10^{-11}/\sqrt{\tau}$; this equation is derived from Figure 12, which is a plot of the Allan standard deviation of the Cs clock as measured against our HP-50613-004 standard.

CONCLUSIONS

One can conclude from the data in Table I, as plotted in Figure 13, that even if the C-field is set far away from an optimum setting, the effect of changes in microwave power on the Allan standard frequency deviation will be small for periods of less than 2.5 days. Even at 2.5 days, the Allan standard frequency deviation that results from beam tube noise is still about twice what would result from microwave power changes in this particular standard. Thus, if the Allan standard deviation of the power remained about constant, the Allan standard frequency deviation due to beam tube noise and that due to microwave power variations would be about equal at 10 days.

ACKNOWLEDGMENT

The authors thank Mr. Michael Meyer of The Aerospace Corporation for editing and preparing this paper.

REFERENCES

1. A. De Marchi, "Rabi Pulling and Long-Term Stability in Cesium Beam Frequency Standards," *IEEE Trans. Ultrasonics, Ferroelectrics, and Frequency Control* UFFC-34 (6), 598-601 (November 1987).
2. A. De Marchi, "New Insights into Causes and Cures of Frequency Instabilities (Drift and Long-Term Noise) in Cesium Beam Frequency Standards," *Proc. 41st Frequency Control Symposium, 1987*, pp. 54-58.
3. S. K. Karuza, W. A. Johnson, and F. J. Voit, "Determining the Effects of Microwave Power and C-field Setting on the Frequency of a Cesium Atomic Frequency Standard," *Proc. 3rd European Time and Frequency Forum (Besancon, France, 21-23 March 1989)*, pp. 69-72.

4. S. K. Karuza, W. A. Johnson, J. P. Hurrell, and F. J. Voit, "Determining Optimum C-field Settings that Minimize Output Frequency Variations in Cesium Atomic Frequency Standards," presented at the 21st Annual Precise Time and Time Interval (PTTI) Applications and Planning Meeting, Redondo Beach, Calif., 30 November 1989.

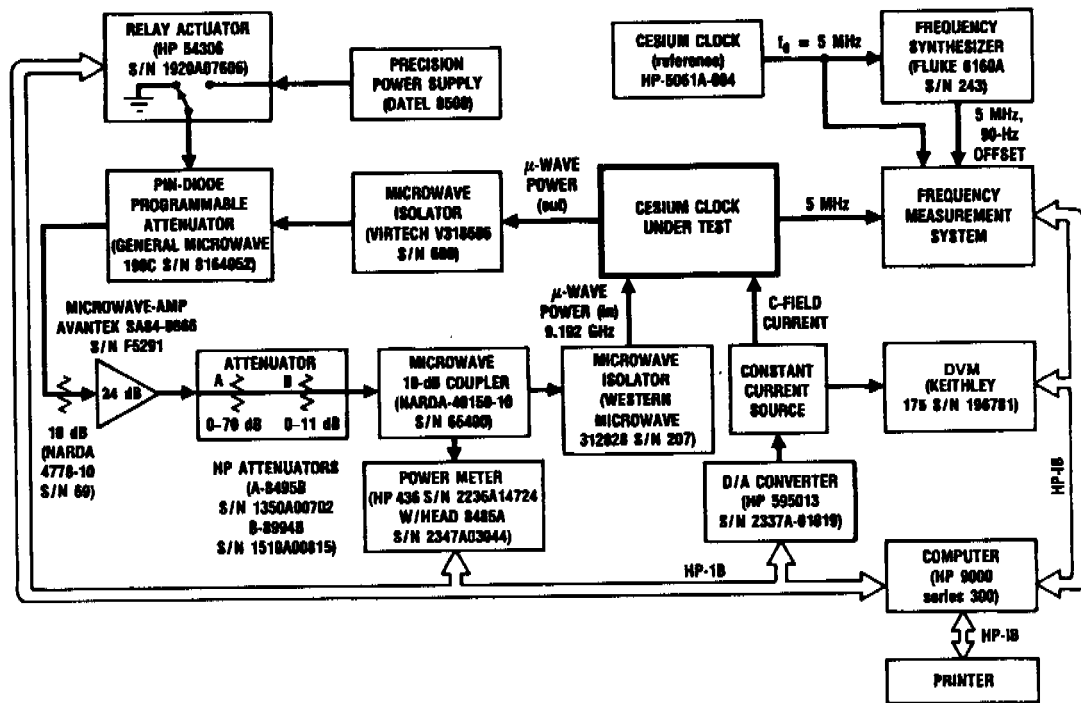

Figure 1. Block Diagram of the C-field Measurement System for a Cs Frequency Standard

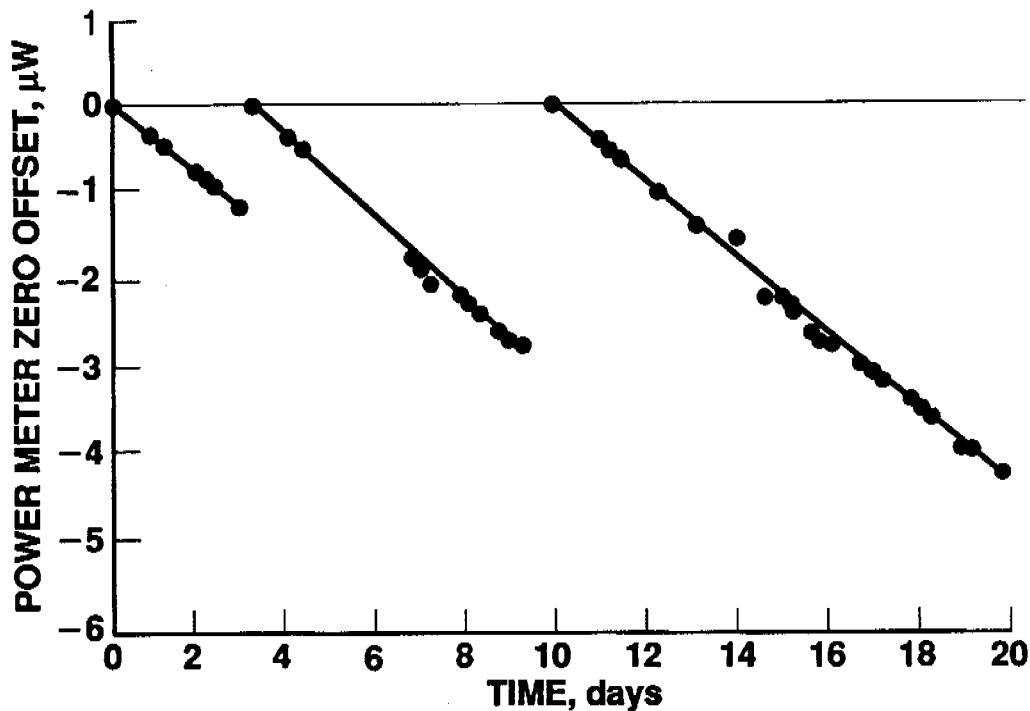

Figure 2. Plot of the Power Meter Zero Offset as a Function of Time

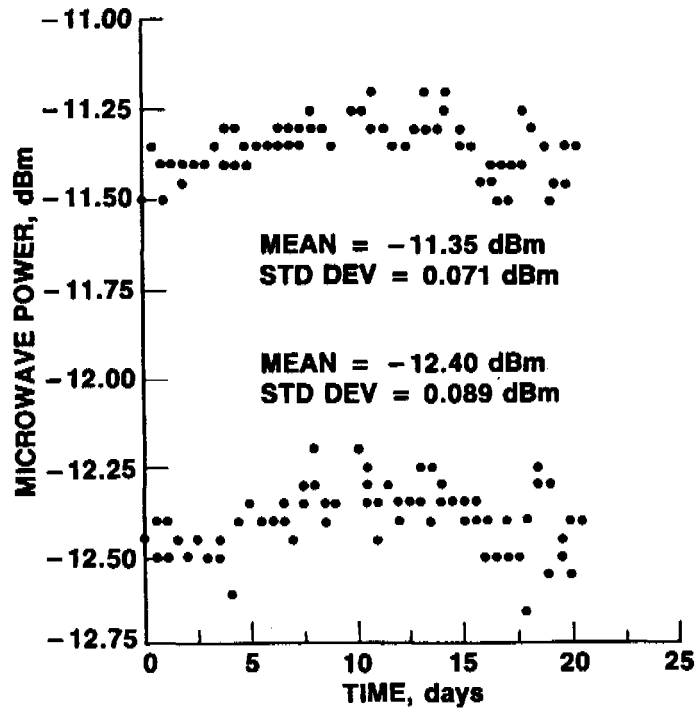

Figure 3. Plot of the Two Measured Power Levels as a Function of Time

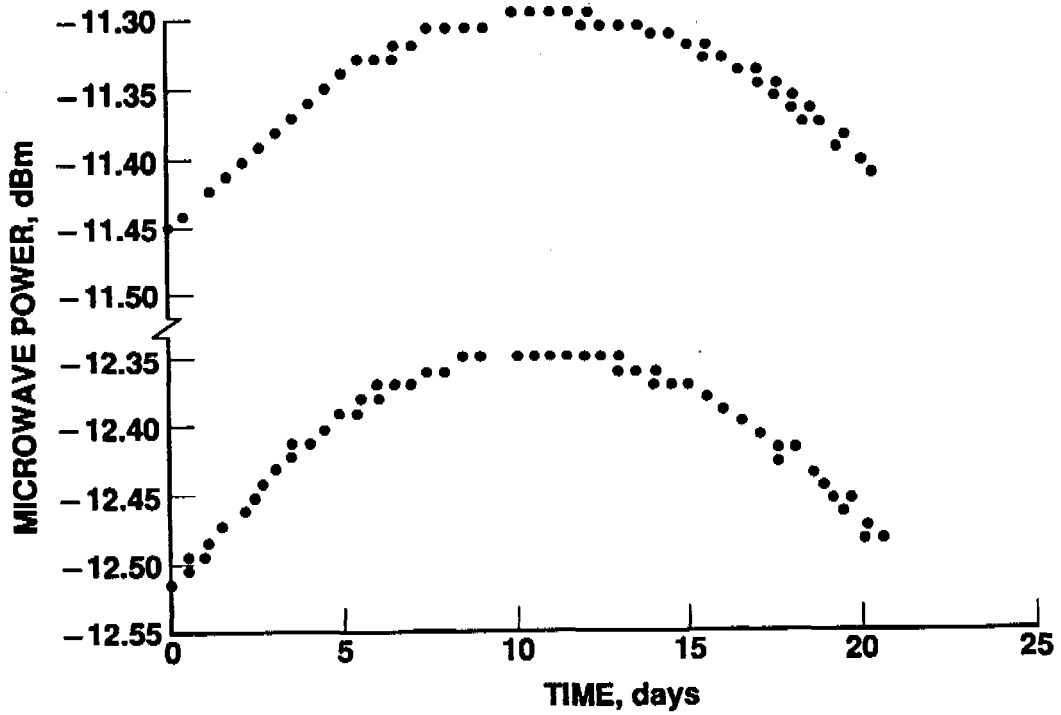

Figure 4. Plot of the Curve Fits of the Two Measured Power Levels as a Function of Time

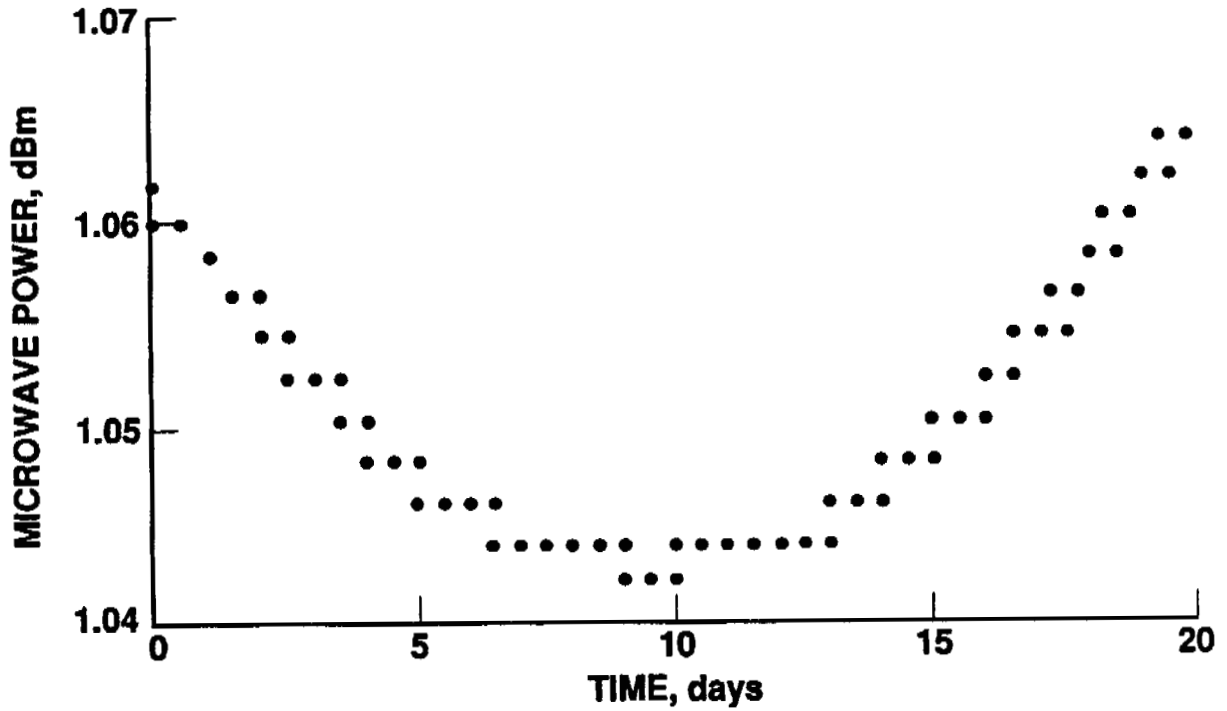

Figure 5. Plot, as Function of Time, of the Difference of the Two Fits to the Power Data

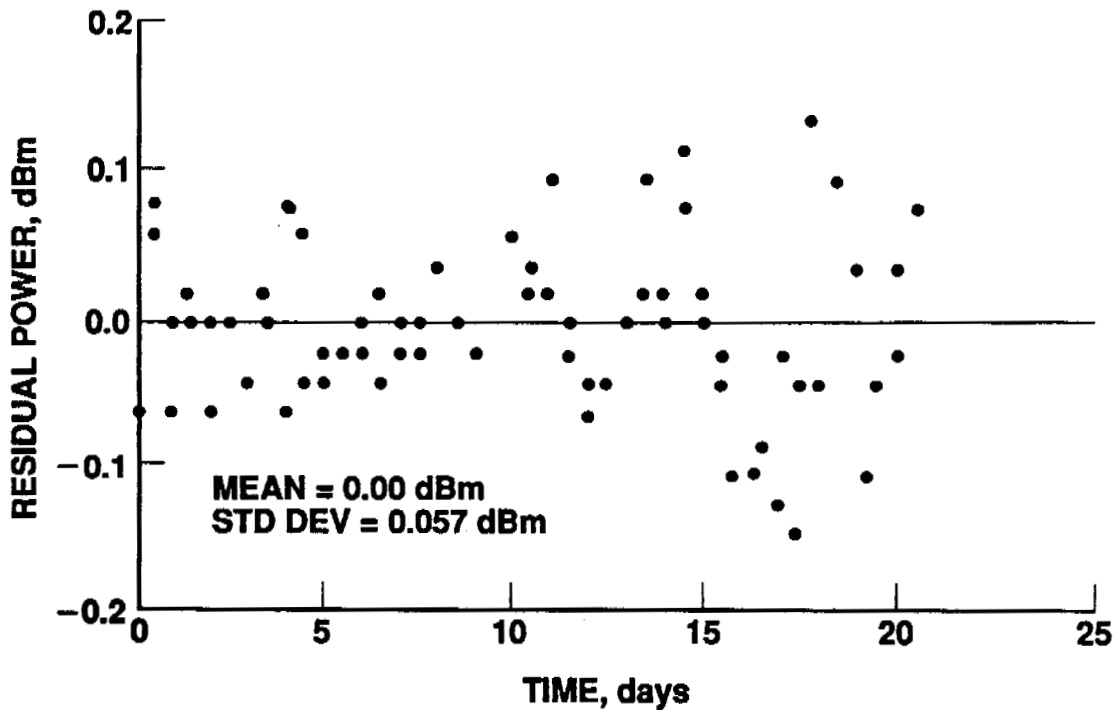

Figure 6. Plot, as a Function of Time, of the High-Power Residuals that Remain after the Fit Curve is Subtracted

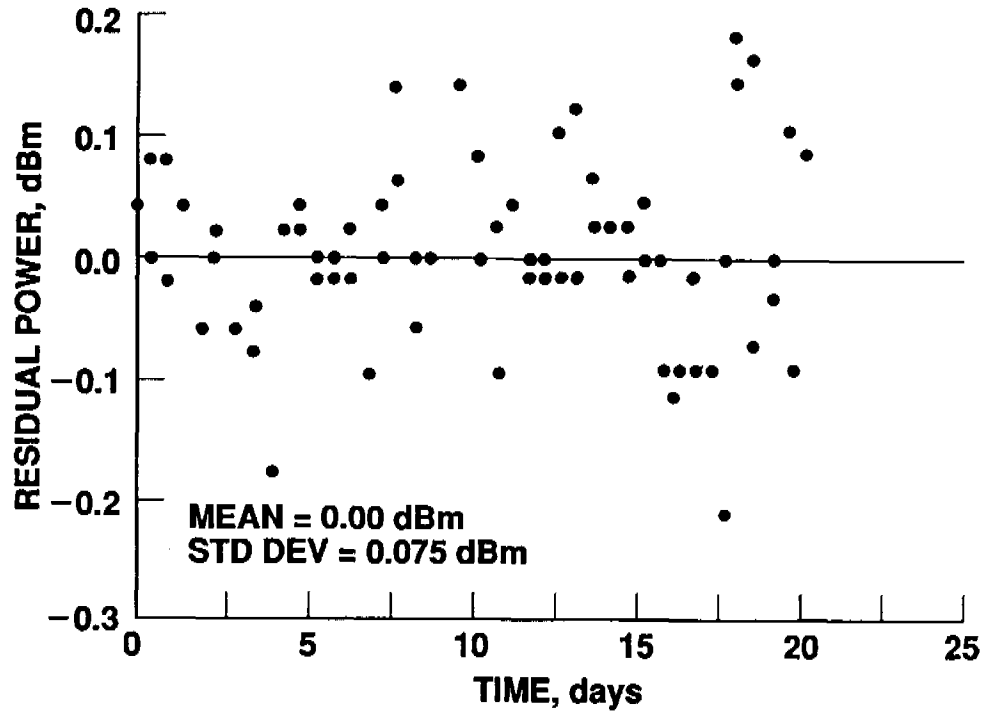

Figure 7. Plot, as a Function of Time, of the Low-Power Residuals that Remain after the Fit Curve is Subtracted

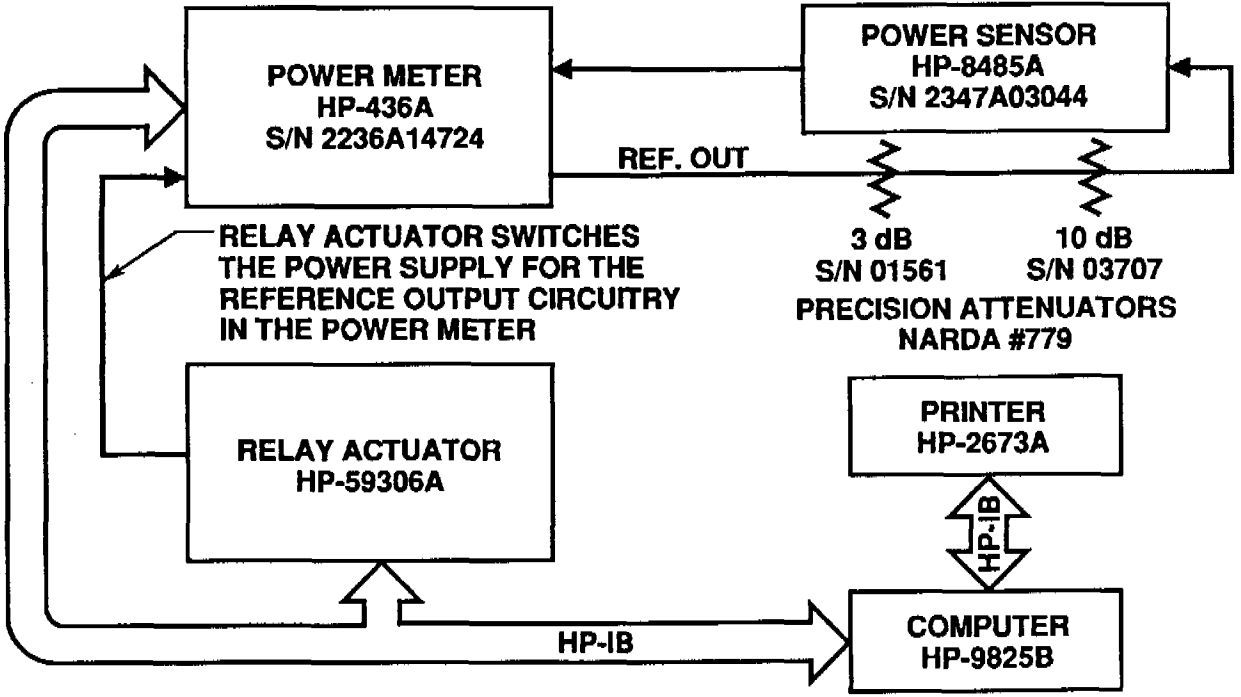

Figure 8. Block Diagram of the Power Meter Measurement System

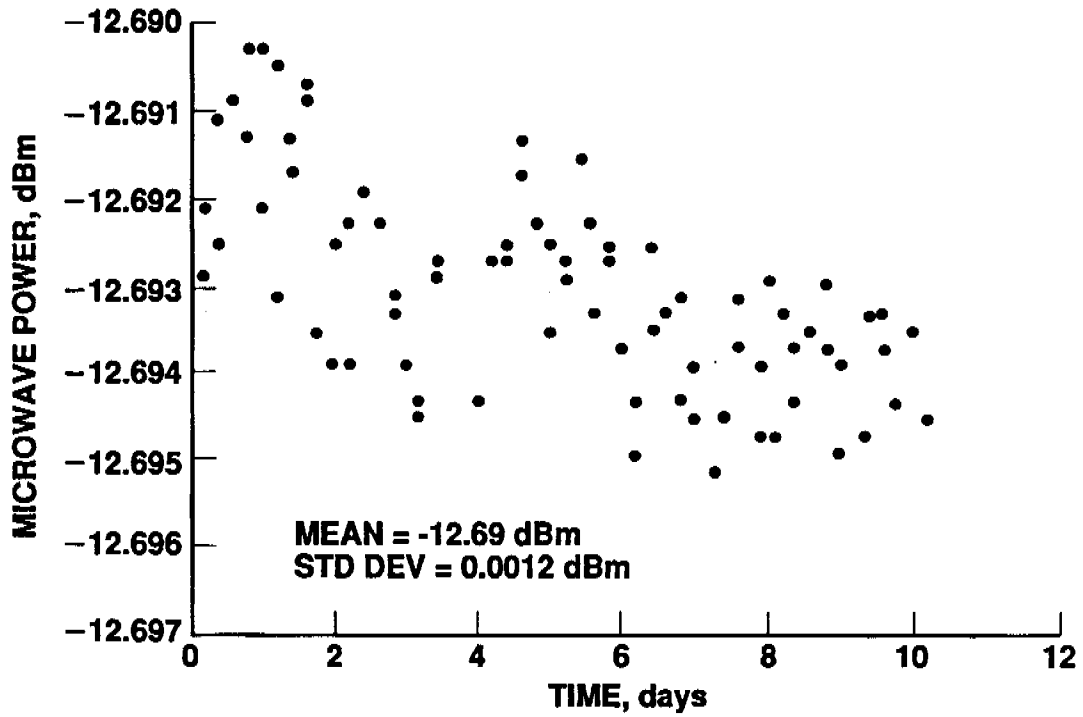

Figure 9. Plot of the Stability of the Power Meter for a 10-Day Run

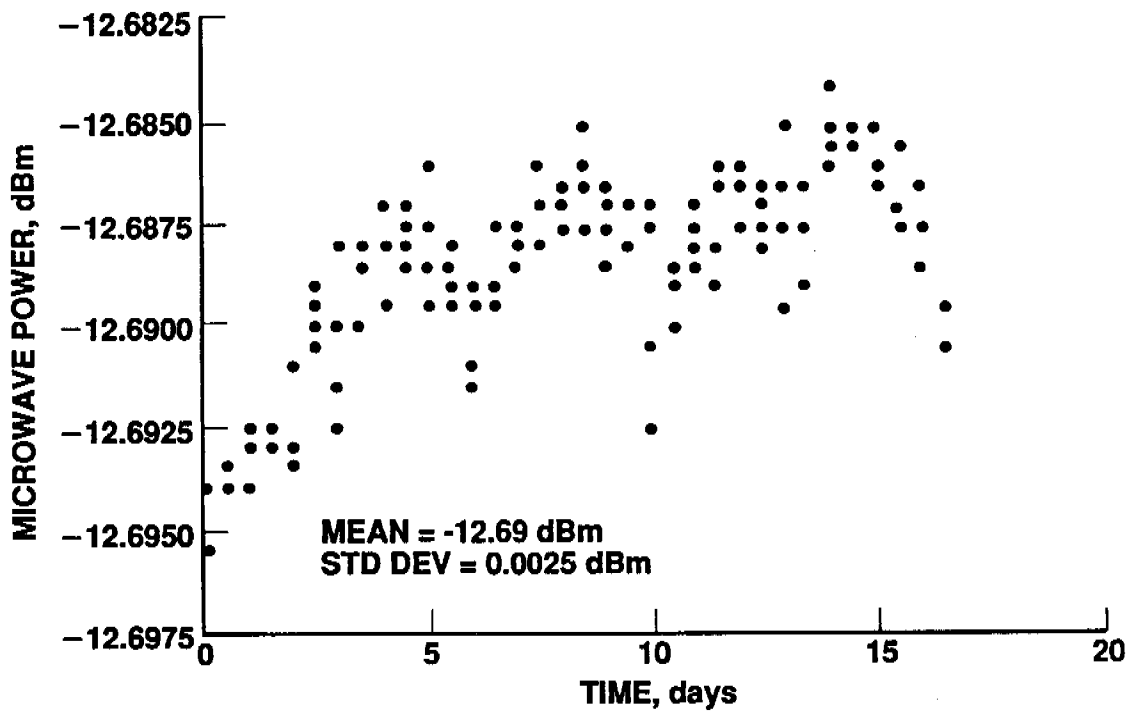

Figure 10. Plot of the Stability of the Power Meter for a 16-Day Run

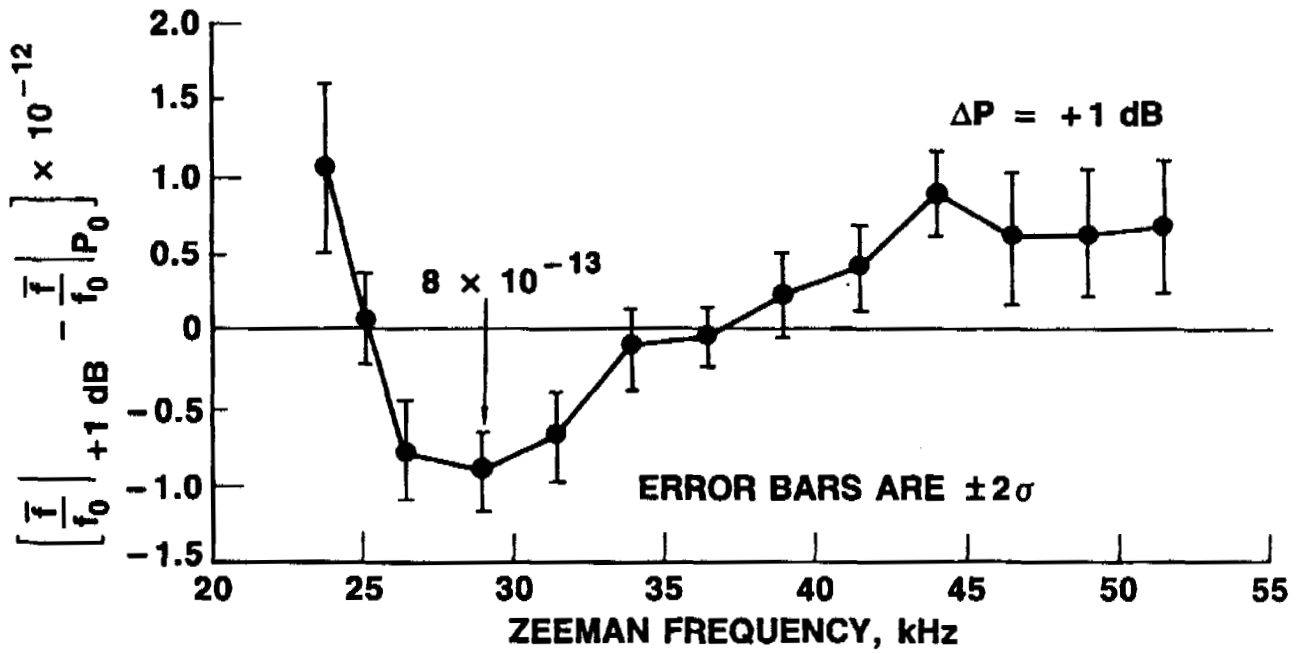

Figure 11. Difference of the Average Frequencies of the Cs Frequency Standard as a Function of C-field for a Microwave Power Change of +1 dB above the Optimum Power Level P_0

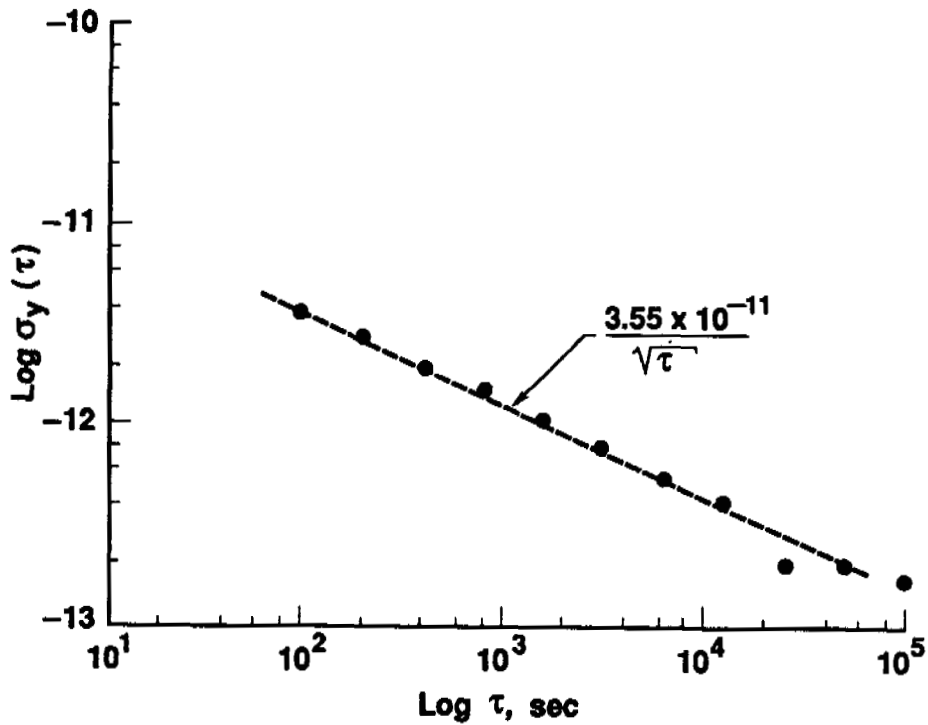

Figure 12. Plot, as a Function of Sampling Time, of the Allan Standard Frequency Deviation of the Cs Frequency Standard

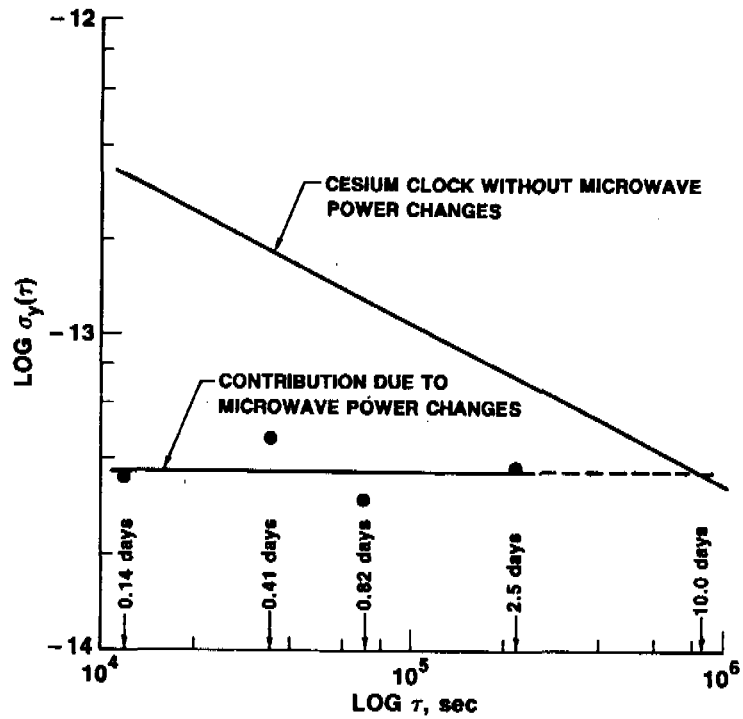

Figure 13. Plot of the Calculated Contribution of Microwave Power Changes to the Allan Standard Frequency Deviation of the Cs Frequency Standard

Table 1. Measurement Data

POWER DATA			FREQUENCY DATA	
TIME (τ), days	No. OF POINTS	ALLAN STD DEV [$\sigma_p(\tau)$], dBm	ALLAN STD DEV [$\sigma_y(\tau) \approx \sigma_p(\tau) \times 8 \times 10^{-13}$]	$\frac{3.55 \times 10^{-11}}{\sqrt{\tau}}$
0.14	128	0.04390	0.3512×10^{-13}	3.228×10^{-13}
0.41	64	0.05794	0.4635×10^{-13}	1.886×10^{-13}
0.82	26	0.03719	0.2975×10^{-13}	1.334×10^{-13}
2.50	12	0.04807	0.3846×10^{-13}	0.7638×10^{-13}