

**TIME AND FREQUENCY COMPARISONS IN EUROPE BY MEANS OF ECS 5
GEOSTATIONARY SATELLITE**

F. Cordara, V. Pettiti
Istituto Elettrotecnico Nazionale Galileo Ferraris
Corso Massimo d'Azeglio, 42 - 10125 Torino, Italy
Tel. 011/3488933

A. Cenci, M. Fermi, C. Sciarretta
Telespazio S.p.A.
Via Tiburtina, 965 - 00156 Roma, Italy
Tel. 06/406931

Abstract

A time synchronization experiment between some European laboratories using the passive television method applied to the signals broadcasted by Eutelsat I-F5 telecommunication satellite was completed in 1990.

The results obtained in the last period, when also range measurements from a Telespazio ground station were performed, are analyzed to evaluate the accuracy level of the time comparisons corrected for the effect of the satellite movement with position data obtained either from the European Space Agency (ESA) or from orbit determination with range data entered into GEODYN program of NASA/GSFC.

1 - Introduction

A time synchronization experiment between the time scales of eight European laboratories using the passive television method [1] applied to the RAI Uno signals transmitted at 11.01 GHz by Eutelsat I-F5 (ECS-5 in the sequel) telecommunication satellite placed in a geostationary orbit at 10° East longitude, was completed in February 1990.

The aim of this experiment, developed in the frame of Euromet Project P88/169, was to investigate in the capabilities of these techniques in order to establish a synchronization system covering several countries in Europe, yielding good precision in time and frequency calibration with relatively low cost equipment [2,3].

The laboratories involved in the last period of the experiment are reported below together with their receiving stations coordinates:

Report Documentation Page

*Form Approved
OMB No. 0704-0188*

Public reporting burden for the collection of information is estimated to average 1 hour per response, including the time for reviewing instructions, searching existing data sources, gathering and maintaining the data needed, and completing and reviewing the collection of information. Send comments regarding this burden estimate or any other aspect of this collection of information, including suggestions for reducing this burden, to Washington Headquarters Services, Directorate for Information Operations and Reports, 1215 Jefferson Davis Highway, Suite 1204, Arlington VA 22202-4302. Respondents should be aware that notwithstanding any other provision of law, no person shall be subject to a penalty for failing to comply with a collection of information if it does not display a currently valid OMB control number.

1. REPORT DATE DEC 1990	2. REPORT TYPE	3. DATES COVERED 00-00-1990 to 00-00-1990	
4. TITLE AND SUBTITLE Time and Frequency Comparisons in Europe by Means of ECS 5 Geostationary Satellite		5a. CONTRACT NUMBER	
		5b. GRANT NUMBER	
		5c. PROGRAM ELEMENT NUMBER	
6. AUTHOR(S)		5d. PROJECT NUMBER	
		5e. TASK NUMBER	
		5f. WORK UNIT NUMBER	
7. PERFORMING ORGANIZATION NAME(S) AND ADDRESS(ES) Istituto Elettrotecnico Nazionale Calileo Ferraris, Corso Massimo d'Azeglio, 42 - 10125 Torino, Italy,		8. PERFORMING ORGANIZATION REPORT NUMBER	
9. SPONSORING/MONITORING AGENCY NAME(S) AND ADDRESS(ES)		10. SPONSOR/MONITOR'S ACRONYM(S)	
		11. SPONSOR/MONITOR'S REPORT NUMBER(S)	
12. DISTRIBUTION/AVAILABILITY STATEMENT Approved for public release; distribution unlimited			
13. SUPPLEMENTARY NOTES See also ADA239372. 22nd Annual Precise Time and Time Interval (PTTI) Applications and Planning Meeting, Vienna, VA, 4-6 Dec 1990			
14. ABSTRACT see report			
15. SUBJECT TERMS			
16. SECURITY CLASSIFICATION OF:			17. LIMITATION OF ABSTRACT Same as Report (SAR)
a. REPORT unclassified	b. ABSTRACT unclassified	c. THIS PAGE unclassified	
			18. NUMBER OF PAGES 14
			19a. NAME OF RESPONSIBLE PERSON

Laboratory	Latitude	Longitude	Height (m)
AOS - Astronomical Latitude Observatory BOROWIEC, POLAND	52°16'37.0"N	17°04'23.7"E	129
ASMW - Amt für Standardisierung, Meßwesen und Warenprüfung - BERLIN, GERMANY	52°27'14"N	13°37'01"E	50
FUC - Telespazio S.p.A. FUCINO, ITALY	41°58'41.3"N	13°35'57.1"E	671
IEN - Istituto Elettrotecnico Nazionale TORINO, ITALY	45°00'53.6"N	07°38'20.1"E	297
STA - Swedish Telecommunication Administration - STOCKHOLM, SWEDEN	59°09'54.2"N	18°08'13.5"E	109
TP - Ustav Radiotechniky a Elektroniky PRAHA, CZECHOSLOVAKIA	50°07'53"N	14°27'09"E	300
TUG - Technische Universität GRAZ, AUSTRIA	47°04'01.5"N	15°29'35.5"E	534
VSL - Van Swinden Laboratorium DELFT, THE NETHERLANDS	51°59'58.9"N	04°22'50.7"E	60

The receiving stations used, with the exception of the Telespazio - Fucino ground station, were made of commercial TV satellite receivers and antennas with diameters varying from 0.9 to 3 m.

The daily measurement schedule followed in each laboratory consisted, up to January 1990, in two sets of 25 time interval measurements, twelve hours apart, between the local UTC and the trailing edge of the first field synchronizing pulse of the video signal. Since January 1990, when the range measurements from the Telespazio ground station were also performed, the measurement schedule was updated to have more synchronization results.

In Fig. 1 are reported the comparison results between UTC(IEN) and the time scales of TUG, STA and TP obtained via ECS 5 for the period November 1989 - February 1990 corrected for the satellite position data supplied by the European Space Agency (ESA). In the figure are also reported the differences every ten days computed from BIPM Circulars T, in the case of TP, or the daily differences computed via GPS common-view in the case of STA and VSL.

As reported in previous works on this subject [2,3], it can be seen that a precision of some hundreds of nanoseconds can be achieved by correcting for the satellite position parameters supplied by the control station with an uncertainty of some kilometers.

The peak-to-peak fluctuations of the synchronization results are also strictly dependent on the baselines between the laboratories involved that varied from some hundreds of kilometers up to 1700 kilometers in the IEN/STA

link. The differences between the synchronization results, obtained with ECS 5 and the synchronization systems already established, are mainly due to an insufficient evaluation of the differential delay of each pair of receiving equipment. This is more evident in the case of UTC(IEN) - UTC(TP) where the uncertainty reaches 1.5 us, due also to the synchronization link used to relate TP to UTC (long distance terrestrial television link).

Since November 1989, the daily measurement schedule was changed to verify if the diurnal effects due to the satellite movement, still present in the synchronization results, could be reduced computing the time differences at half-sidereal day intervals, but no appreciable improvement was obtained with this procedure.

2 - Range measurements

From January 30 to February 20, 1990, range measurements were performed every hour at the Telespazio-Fucino groundstation where the RAI Uno signals are transmitted to ECS 5. A portable cesium clock was also installed at Fucino as a local reference to perform every hour synchronization measurements with the other time scales.

The equipment set-up is shown in Fig. 2; each measurement sequence started with the time difference between the local 1 PPS reference UTC(FUC) and the first selected TV synchronizing pulse received from the satellite and was followed by a range measurement beginning after a 300 ms delay for instrumentation reasons. This measurement was stopped by a TV pulse from ECS 5 after nearly 250 ms (Fig. 3). The measurement resolution was 0.5 ns. The range values measured at Fucino have been reported in Fig. 4 together with the range computed for Fucino from ECS-5 orbital parameters supplied by ESA-Redu control station. The differences between the two sets of range data are reported in Fig. 5 where a maximum difference of about 1 km can be observed. This is mainly due to the uncertainty of the ESA parameters and, to a lesser extent, in having disregarded the satellite transponder delay. The typical standard deviation of a set of 25 range measurements, using the synchronizing pulses, was 1 meter.

In Fig. 6 are reported the synchronization results between UTC(IEN) and UTC(FUC) for February 1990 and, with crosses, the average of a pair of adjacent synchronization data at a half-sidereal day interval. A considerable reduction of the daily fluctuations is obtained but a long-term excursion of ± 1 us is still present. Looking at ECS longitude data for the same period (Fig. 7), with the same averaging process applied, it can be noticed that the excursion seen before matches very well the longitude-drift of the satellite. These synchronization results have been therefore corrected only for the effect of the mean longitude variation obtained from ESA position data and for the differential delay of the two stations (Fig. 8). In the same graph is reported with a dashed line the mean rate of the cesium clock at Fucino during the

experiment versus UTC(IEN) that was of +96 ns/d; the mean rate evaluated by means of ECS-5 has been found equal to +92 ns/d. The residual daily fluctuation of the order of 200 nanoseconds peak-to-peak, is of the same order of that obtained averaging synchronization data at 12 hour interval.

The bias of about 0.6 us between the two curves is due to the fact that it was not possible to evaluate separately the receiving and transmitting delay of the Fucino groundstation and that the delay of the Test Loop Translator, used for the measurement of the total delay, is not known.

The total delay of the Fucino transmitting and receiving station, measured during the experiment, was found equal to 3.918 us with an uncertainty of ± 7 ns.

The delay of the IEN station, measured by means of a satellite simulator, as described in [3], was found equal to 0.851 us with an uncertainty of ± 15 ns. The long-term stability of this delay has also been investigated for six months after having stabilized the temperature inside the satellite simulator within ± 1 K.

The measurement results, reported in Fig. 9 together with the outdoors temperature, show a correlation between the temperature and the delay variation.

3 - Orbit determination of ECS 5

The precise orbit determination of ECS 5 geostationary satellite has been performed at Telespazio using the range measurements collected in the period January 30 - February 20 1990 and discussed in the previous section. The travel times of TV synchronization signal, from Fucino ground station to ECS 5 satellite and back, have been preprocessed, converted into one way range measurements and formatted into a suitable format for GEODYN program to compute satellite orbit.

GEODYN is a NASA/GSFC program routinely used at Telespazio to analyze laser ranging data to LAGEOS and other geodetic satellites for precise orbit determination and geodetic parameter estimates. This program represents the state-of-the-art in modelling forces acting on satellites and has the capability to process various types of observations.

The model implemented into GEODYN to analyze the data is summarized in table 1. In our model we took into account the gravity of the Earth, with its spheroidal harmonics for some low degree and order terms, together with the gravitational forces due to the Sun and the Moon. Furtherly, we took into account perturbation due to the solar radiation pressure.

Due to the limited tracking geometry, we were not able to estimate the full state vector of the satellite. In fact ranging measurements from one station only do not allow the estimate of the eccentricity and the inclination of the satellite [4], for this reason we fixed these elements at the a priori values provided by ESA.

Table 1 - GEODYN setup for the ECS 5 orbit determination

ECS 5 CONSTANTS

Satellite Mass	656.5 kg
Satellite Area	20.42 m ²
Nominal Reflectance Coefficient	1.2

KINEMATICAL MODEL

Precession	IAU 1976
Nutation	IAU 1980
Lunar and Planetary Ephemeris	JPLDE118
Reference System	1950.0
Earth Semi Major Axis	6378144.11 m
Flattening	1/298.255

DYNAMICAL MODEL

Gravity field	GEM-T1(8x8)
h_2, l_2	0.6040, 0.0852
GM	$3.98600440 \times 10^{14} \text{ m}^3/\text{s}^2$
Gravity from Sun and Moon	applied

METHOD OF ANALYSIS

Single-arc with variable length

COMMON PARAMETERS ESTIMATED IN THE SOLUTION

No common parameters estimated in the solution

ARC PARAMETERS ESTIMATED IN THE SOLUTION

- Four Keplerian elements, Eccentricity and Inclination fixed at the a priori values
- Solar radiation coefficient

The entire data set has been divided into two subsets which were analyzed separately. The first subset lasts from the 29th of January to the 7th of February at 00:00 UTC, while the second one lasts from the 7th of February at 12:30 UTC to the end of the data collection. The analysis of the entire data set was not possible because some manoeuvres have been made on the satellite. Furtherly in the morning of the 7th of February some improvements in the data acquisition system were applied.

Some results from data analysis are summarized in table 2, where in the first column DATA1 refers to the first data subset and DATA2 to the second.

Table 2 - Results of ECS 5 orbit determination

	N. of obs.	Accepted obs.	Mean of orbit resid. (m)	RMS of orbit resid. (m)	RMS of poly.-resid. (m)
DATA 1	4000	3995	0.0	1.6	1.4
DATA 2	6275	6147	0.0	1.1	0.64

The second column gives the total number of observations relevant to the two data sets, while the third refers to the observations not edited after fitting the range data with the estimated orbit of the satellite. The fourth and the fifth columns give respectively the average and the RMS of the orbit residuals. Let us note that the orbit fit seems quite good. The RMS, given in the sixth column, are referred to the residuals obtained by fitting with a polynomial the orbit residuals. Therefore they give an indication of the "single shot" measurement noise. The reduction of the noise of the observations after the improvement of the data acquisition system is evident. Let us now discuss briefly about the errors associated with the estimated orbit. The RMS of orbit residuals at the 1 m level does not mean that the state vector of the spacecraft is known at the same level of precision.

The estimated formal errors in the satellite position and velocity are given in table 3. The improvement in the DATA 2 estimates is mainly due to the more robust statistics of the second data subset.

Table 3 - Scaled formal errors

	RMS of position (m)	RMS of velocity (m/s)
DATA 1	388	0.028
DATA 2	95	0.007

Table 4 shows a comparison between Telespazio and ESA estimates. The differences are of the order of few kilometers which is what could be expected taking into account the errors associated to the ESA estimates which are of the same order of magnitude.

Significant reduction of the satellite position errors could be achieved by improving the statistics and geometry of the observations (e.g. with multiple tracking stations, the use of very accurate pointing angle observations, longer tracking period etc.).

Table 4 - ESA vs. Telespazio (TPZ) estimates comparison

	<u>DATA 1</u>		
	ESA	TPZ	TPZ-ESA
x(m)	34938980.3	34941001.7	2021.4
y(m)	-23574697.3	-23571733.1	2964.2
z(m)	45867.6	45366.1	-501.5
\dot{x} (m/s)	1720.424	1720.196	-0.228
\dot{y} (m/s)	2549.790	2549.943	0.153
\dot{z} (m/s)	1.821	1.887	0.066

DATA 2

	ESA	TPZ	TPZ-ESA
x(m)	38164955.1	38160760.5	-4194.6
y(m)	-17887232.7	-17895895.3	-8662.6
z(m)	30435.4	30611.6	176.2
\dot{x} (m/s)	1305.610	1306.237	0.627
\dot{y} (m/s)	2785.039	2784.751	-0.288
\dot{z} (m/s)	0.679	0.635	-0.044

The results so far obtained are very promising. They suggest that the method of passive TV ranging is a quite good method for geostationary satellite tracking with an intrinsic precision better than 1 m. This precision is impressive, if compared with that obtained with the actual ranging based on VHF or S Band tracking, in particular considering the simplicity and economy of the used system.

4 - Use of Telespazio position data to correct the synchronization results

The position data of ECS 5 obtained from the range measurement with the procedure explained above, have been used to correct the synchronization data obtained for the period January 30 - February 20, 1990 for some of the laboratories involved, namely TUG, STA, VSL. The results, which are reported in Fig. 10, have also been corrected for the differential receiving delays: an accurate evaluation was possible in the case of TUG, STA and VSL because the GPS measurements were used to estimate the difference between the time scales and consequently to compute the mean differential delay for a satellite position given by GEODYN program. The GPS comparisons between the aforementioned laboratories have also been reported in Fig. 10.

In table 5 some figures are given to compare the performances of the ECS 5 synchronization system to the GPS common view:

Table 5 - ECS 5 versus GPS time scales comparisons - February 1990

	UTC(IEN)-UTC(TUG)	UTC(IEN)-UTC(VSL)	UTC(IEN)-UTC(STA)
mean rate (GPS)	+35 ns/d	+15 ns/d	+13 ns/d
mean rate (ECS 5)	+48 ns/d	+11 ns/d	+23 ns/d
std. dev. of residuals	83 ns	78 ns	100 ns
n. of samples	95	36	32

From the mean rates reported above, it can be seen that frequency comparisons with an accuracy of some parts in 10^{-13} for observation times of 20 days have been achieved in this synchronization experiment.

5 - Conclusions

The results obtained in the synchronization experiment between some European Laboratories, based on the passive television method applied to the signals received from Eutelsat I-F5 (ECS 5) geostationary satellite and on range measurements from one station, always using TV signals, have shown that:

- it is possible to determine the satellite position from the range measurements with an accuracy of 1 km or better;
- using these position data to correct the synchronization results, time comparisons on long baselines with a precision of 100 ns (1σ) can be performed;
- an accuracy of some parts in 10^{-13} in frequency comparisons can be achieved, over observation times of 20 days, using the same correction procedure.

References

- [1] J. Tolman, V. Ptacek, A. Soucek, R. Stecher: Microsecond clock comparison by means of TV synchronizing pulses - IEEE Transactions on Instrumentation and Measurement, Vol. IM-16, n. 3, September 1967.
- [2] O. Buzek, J. Cermak, J. Vondrak, F. Cordara, V. Pettiti, P. Tavella: Synchronization of time scales by television method using ECS satellites - Preliminary results - Proc. of 3rd European Time and Frequency Forum, pp. 204-214, Besançon, March 1989.
- [3] V. Pettiti, F. Cordara, P.G. Galliano: Status report on a synchronization experiment between European Time Scales using ECS geostationary satellite - Proc. of 21st Annual Precise Time and Time Interval Applications and Planning Meeting, pp. 323-340, Redondo Beach, November 1989.
- [4] E.M. Soop: Introduction to geostationary orbits - European Space Agency, SP-1053, November 1983.

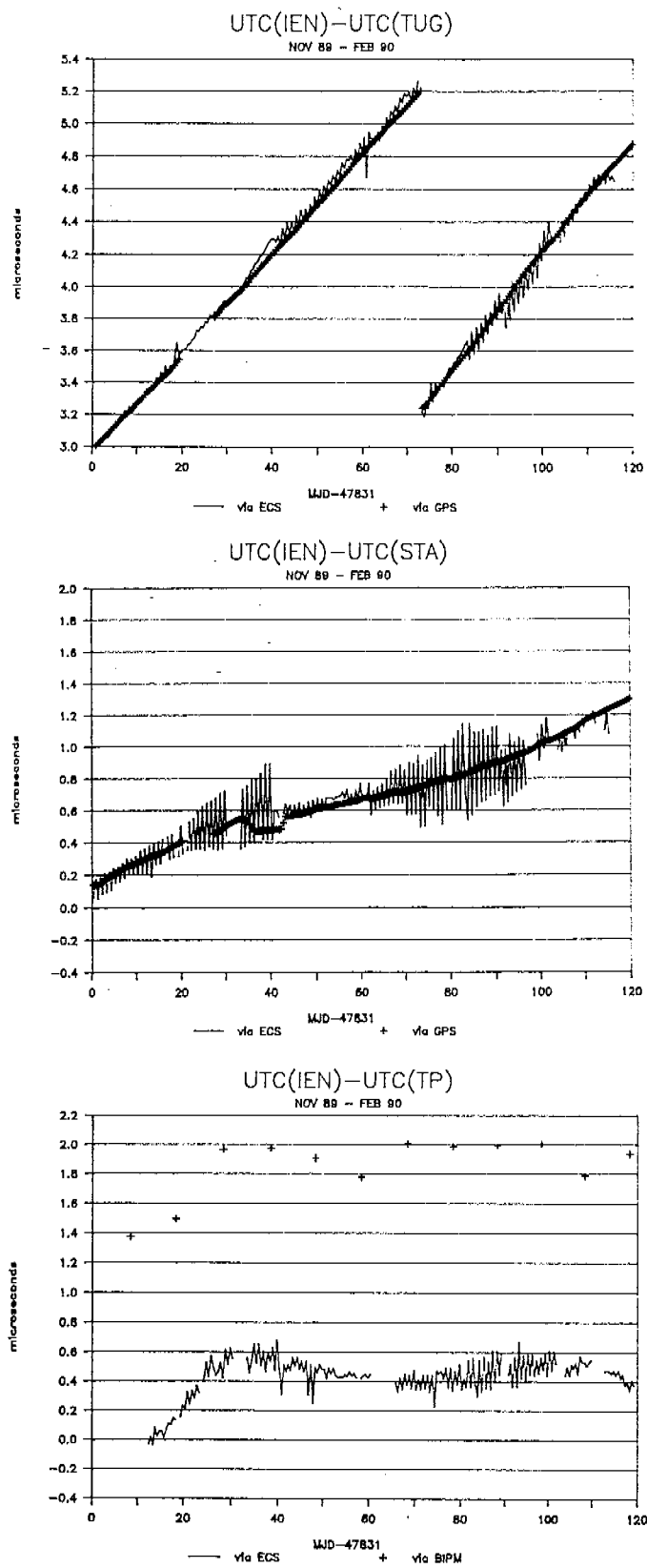
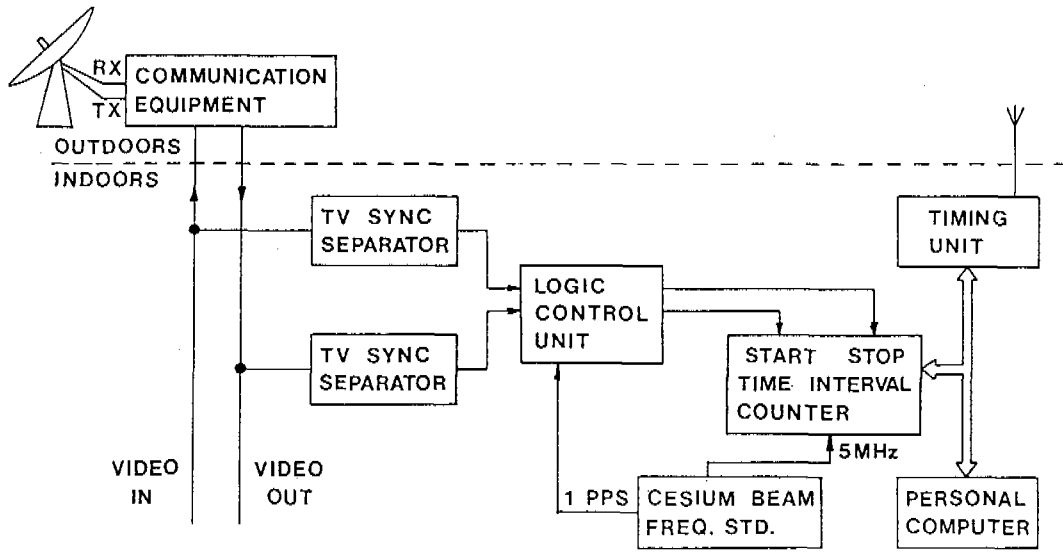
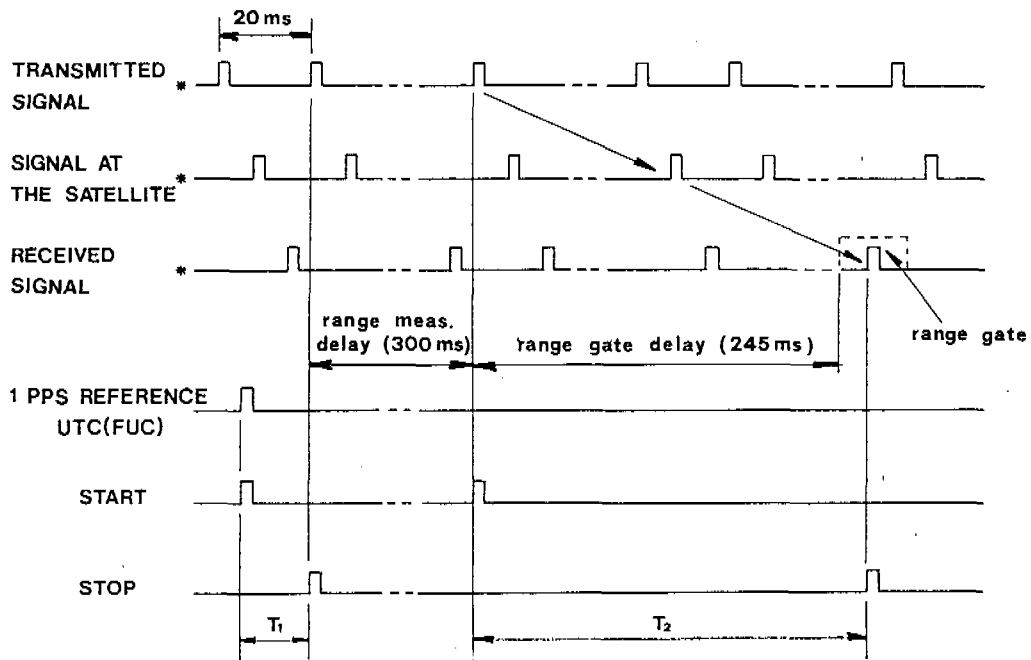

Fig. 1 -- Time scales comparisons by means of ECS 5 satellite.



TO TELESPAZIO
CONTROL AND SWITCHING SYSTEM

Fig. 2 - Equipment set-up for range measurements at Fucino Telespazio groundstation.



* only the selected frame synchronizing pulses are shown

Fig. 3 - Range and synchronization measurements sequence.

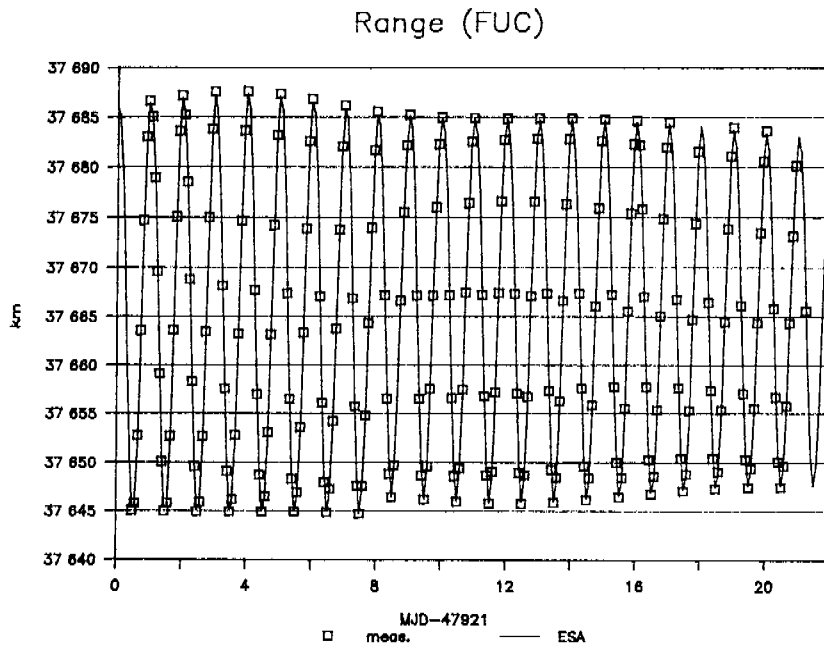

Fig. 4 - ECS 5 range measurements vs. computed range data (ESA) - February 1990.

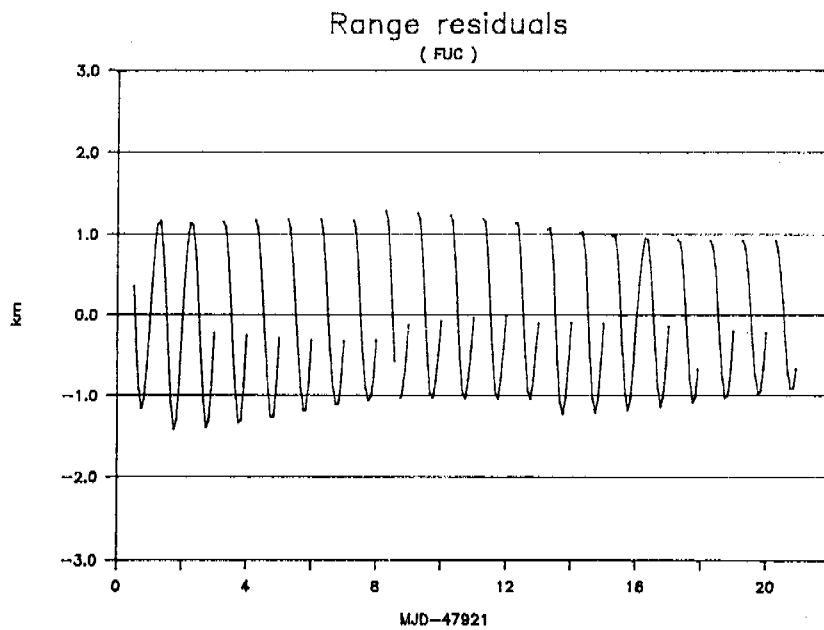

Fig. 5 - ECS 5 range residuals - February 1990.

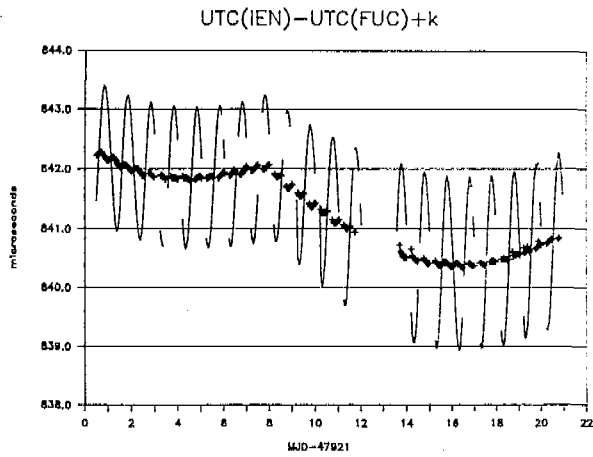

Fig. 6 - IEN-FUC synchronization results - February 1990 (+ averaged values).

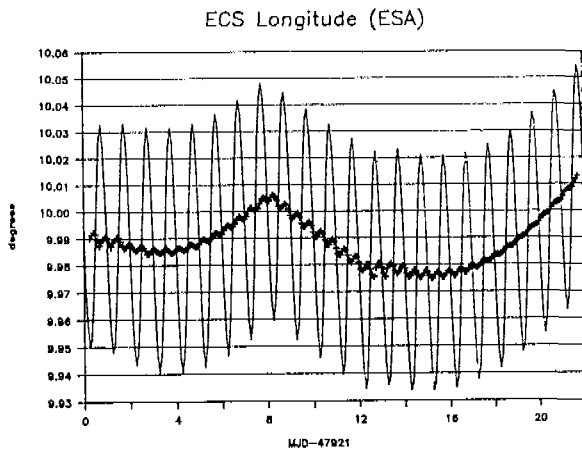

Fig. 7 - ECS 5 longitude from ESA - February 1990 (+ averaged values).

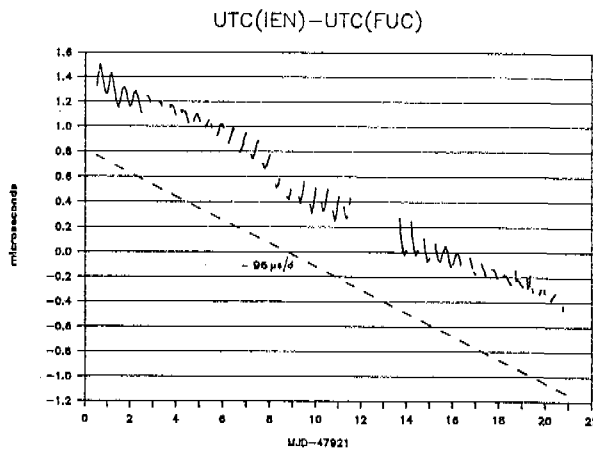

Fig. 8 - IEN-FUC corrected for the effect of longitude variations (— mean rate of the Fucino clock).

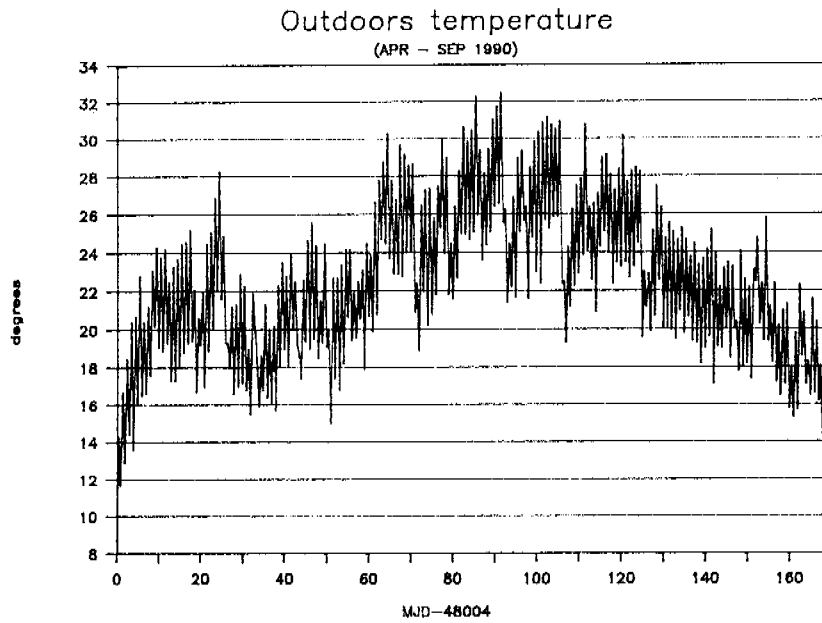
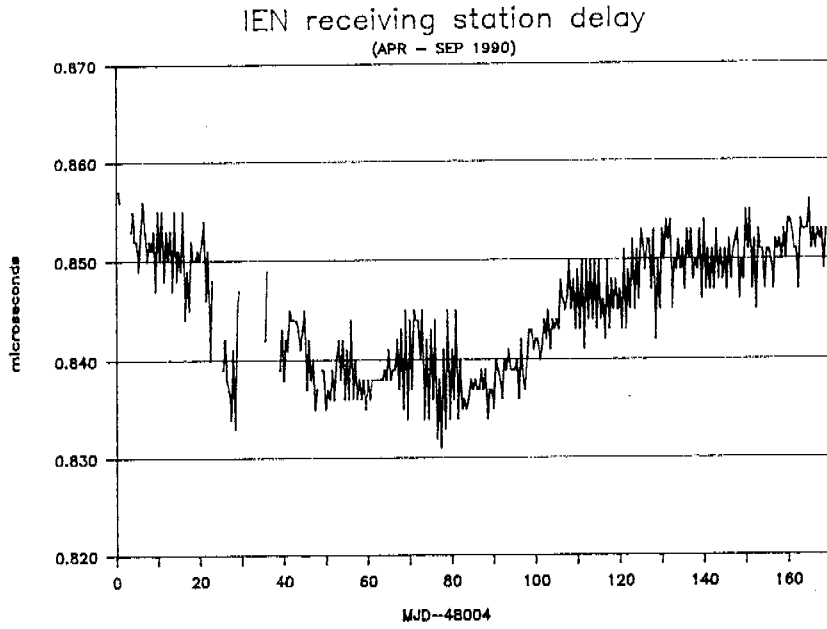

Fig. 9 - Long term delay measurements of the IEN receiving station.

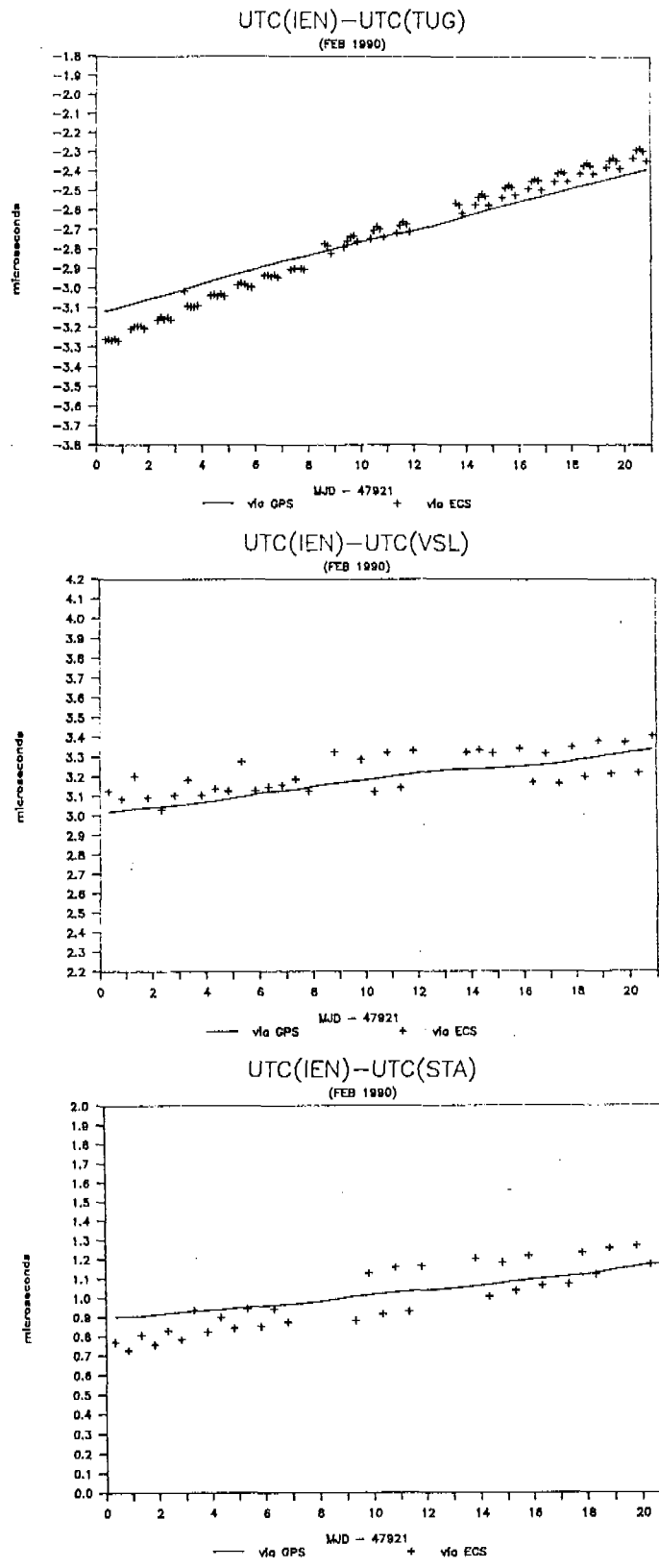

Fig. 10 - ECS 5 synchronization results corrected for Telespazio position data.