



EXCERPT FROM THE PROCEEDINGS

OF THE SEVENTH ANNUAL ACQUISITION RESEARCH SYMPOSIUM WEDNESDAY SESSIONS VOLUME I

**Acquisition Research
Creating Synergy for Informed Change
May 12 - 13, 2010**

Published: 30 April 2010

Approved for public release, distribution unlimited.

Prepared for: Naval Postgraduate School, Monterey, California 93943



Report Documentation Page

Form Approved
OMB No. 0704-0188

Public reporting burden for the collection of information is estimated to average 1 hour per response, including the time for reviewing instructions, searching existing data sources, gathering and maintaining the data needed, and completing and reviewing the collection of information. Send comments regarding this burden estimate or any other aspect of this collection of information, including suggestions for reducing this burden, to Washington Headquarters Services, Directorate for Information Operations and Reports, 1215 Jefferson Davis Highway, Suite 1204, Arlington VA 22202-4302. Respondents should be aware that notwithstanding any other provision of law, no person shall be subject to a penalty for failing to comply with a collection of information if it does not display a currently valid OMB control number.

| | | | | | |
|--|------------------------------------|-------------------------------------|---|---|---------------------------------|
| 1. REPORT DATE MAY 2010 | | 2. REPORT TYPE | | 3. DATES COVERED 00-00-2010 to 00-00-2010 | |
| 4. TITLE AND SUBTITLE The Challenge of Heterogeneously Licensed Systems in Open Architecture Software Ecosystems | | | | 5a. CONTRACT NUMBER | |
| | | | | 5b. GRANT NUMBER | |
| | | | | 5c. PROGRAM ELEMENT NUMBER | |
| 6. AUTHOR(S) | | | | 5d. PROJECT NUMBER | |
| | | | | 5e. TASK NUMBER | |
| | | | | 5f. WORK UNIT NUMBER | |
| 7. PERFORMING ORGANIZATION NAME(S) AND ADDRESS(ES) University of California, Irvine, Institute for Software Research, Irvine, CA, 92697-3455 | | | | 8. PERFORMING ORGANIZATION REPORT NUMBER | |
| 9. SPONSORING/MONITORING AGENCY NAME(S) AND ADDRESS(ES) | | | | 10. SPONSOR/MONITOR'S ACRONYM(S) | |
| | | | | 11. SPONSOR/MONITOR'S REPORT NUMBER(S) | |
| 12. DISTRIBUTION/AVAILABILITY STATEMENT Approved for public release; distribution unlimited | | | | | |
| 13. SUPPLEMENTARY NOTES 7th Annual Acquisition Research Symposium to be held May 12-13, 2010 in Monterey, California. U.S. Government or Federal Rights License | | | | | |
| 14. ABSTRACT The role of software ecosystems in the development and evolution of open architecture systems has received insufficient consideration. Such systems are composed of heterogeneously licensed components, open source or proprietary or both, in an architecture in which evolution can occur by evolving existing components or by replacing them. But this may result in possible license conflicts and organizational liability for failure to fulfill license obligations. We have developed an approach for understanding and modeling software licenses, as well as for analyzing conflicts among groups of licenses in realistic system contexts and for guiding the acquisition, integration, or development of systems with open-source components in such an environment. This work is based on empirical analysis of representative software licenses and heterogeneously licensed systems, and collaboration with researchers in the legal world. Our approach provides guidance for achieving a "best-of-breed" component strategy while obtaining desired license rights in exchange for acceptable obligations. | | | | | |
| 15. SUBJECT TERMS | | | | | |
| 16. SECURITY CLASSIFICATION OF: | | | 17. LIMITATION OF ABSTRACT Same as Report (SAR) | 18. NUMBER OF PAGES 53 | 19a. NAME OF RESPONSIBLE PERSON |
| a. REPORT unclassified | b. ABSTRACT unclassified | c. THIS PAGE unclassified | | | |

The research presented at the symposium was supported by the Acquisition Chair of the Graduate School of Business & Public Policy at the Naval Postgraduate School.

To request Defense Acquisition Research or to become a research sponsor, please contact:

NPS Acquisition Research Program
Attn: James B. Greene, RADM, USN, (Ret.)
Acquisition Chair
Graduate School of Business and Public Policy
Naval Postgraduate School
555 Dyer Road, Room 332
Monterey, CA 93943-5103
Tel: (831) 656-2092
Fax: (831) 656-2253
E-mail: jbgreene@nps.edu

Copies of the Acquisition Sponsored Research Reports may be printed from our website www.acquisitionresearch.net



The Challenge of Heterogeneously Licensed Systems in Open Architecture Software Ecosystems

Walt Scacchi—Walt Scacchi is a senior research scientist and research faculty member at the Institute for Software Research, University of California, Irvine. He received a PhD in information and computer science from UC Irvine in 1981. From 1981 to 1998, he was on the faculty at the University of Southern California. In 1999, he joined the Institute for Software Research at UC Irvine. He has published more than 150 research papers and has directed 45 externally funded research projects. In 2007, he served as General Chair of the 3rd IFIP International Conference on Open Source Systems (OSS2007), Limerick, IE. In 2010, he chaired the Workshop on the Future of Research in Free and Open Source Software, Newport Beach, CA, for the Computing Community Consortium and the National Science Foundation. He also serves as Co-chair of the Doctoral Consortium at the 6th IFIP International Conference on Open Source Systems (OSS2010), Notre Dame, IN.

Thomas Alspaugh—Thomas Alspaugh is adjunct professor of computer science at Georgetown University and visiting researcher at the Institute for Software Research at UC Irvine. His research interests are in software engineering and software requirements. Before completing his PhD, he worked as a software developer, team lead, and manager in industry and as a computer scientist at the Naval Research Laboratory on the Software Cost Reduction project, also known as the A-7E project.

Hazel Asuncion—Hazel Asuncion is a postdoctoral scholar at the Institute for Software Research. Starting Fall 2010, she will be an assistant professor in the Department of Computer Science at the University of Washington, Bothell. Her research interests focus on traceability, process workflows, software system architectures, and their interrelationships.

Abstract

The role of software ecosystems in the development and evolution of open architecture systems has received insufficient consideration. Such systems are composed of heterogeneously licensed components, open source or proprietary or both, in an architecture in which evolution can occur by evolving existing components or by replacing them. But this may result in possible license conflicts and organizational liability for failure to fulfill license obligations. We have developed an approach for understanding and modeling software licenses, as well as for analyzing conflicts among groups of licenses in realistic system contexts and for guiding the acquisition, integration, or development of systems with open-source components in such an environment. This work is based on empirical analysis of representative software licenses and heterogeneously licensed systems, and collaboration with researchers in the legal world. Our approach provides guidance for achieving a “best-of-breed” component strategy while obtaining desired license rights in exchange for acceptable obligations.

Introduction

A substantial number of development organizations are adopting a strategy in which a software-intensive system is developed with an *open architecture* (OA) (Oreizy, 2000), whose components may be open source software (OSS) or proprietary with open application programming interfaces (APIs). Such systems evolve not only through the



evolution of their individual components, but also through replacement of one component by another, possibly from a different producer or under a different license. With this approach, the organization becomes an integrator of components largely produced elsewhere that are interconnected through open APIs as necessary to achieve the desired result. An OA development process results in an ecosystem in which the integrator is influenced from one direction by the goals, interfaces, license choices, and release cycles of the component producers, and in another direction by the needs of its consumers. As a result, the software components are reused more widely, and the resulting OA systems can achieve reuse benefits such as reduced costs, increased reliability, and potentially increased agility in evolving to meet changing needs. An emerging challenge is to realize the benefits of this approach when the individual components are *heterogeneously licensed*, each potentially with a different license rather than a single OSS license as in uniformly licensed OSS projects, or a single proprietary license when acquired from a vendor employing a proprietary development scheme.

This challenge is inevitably entwined with the software ecosystems that arise for OA systems. We find that an OA software ecosystem involves not only organizations and individuals producing and consuming components, and supply paths from producer to consumer, but also:

- the OA of the system(s) in question,
- the open interfaces met by the components,
- the degree of coupling in the evolution of related components, and
- the rights and obligations resulting from the software licenses under which various components are released, that propagate from producers to consumers.

An example software ecosystem is portrayed in Figure 1.

In order to most effectively use an OA approach in developing and evolving a system, it is essential to consider this OA ecosystem. An OA system draws on components from proprietary vendors and open source projects. Its architecture is made possible by the existing general ecosystem of producers, from which the initial components are chosen. The choice of a specific OA begins a specialized software ecosystem involving components that meet (or can be shimmed to meet) the open interfaces used in the architecture. We do not claim this is the best or the only way to reuse components or produce systems, but it is an ever more widespread way. In this paper, we build on previous work on heterogeneously licensed systems (HLSs) (German & Hassan, 2009; Alspaugh & Scacchi, 2008; Alspaugh, Asuncion & Scacchi, 2009a, May) by examining the role of component licenses in OA software ecosystems and how OA development affects and is affected by software ecosystems.

A motivating example of this approach is the Unity game development tool, produced by Unity Technologies (Unity Technologies, 2008), which can be used to create game-based virtual worlds for training applications. Its license agreement, which we quote below, lists eleven distinct licenses and indicates the tool is produced, apparently using an OA approach, using at least 18 externally produced components or groups of components:



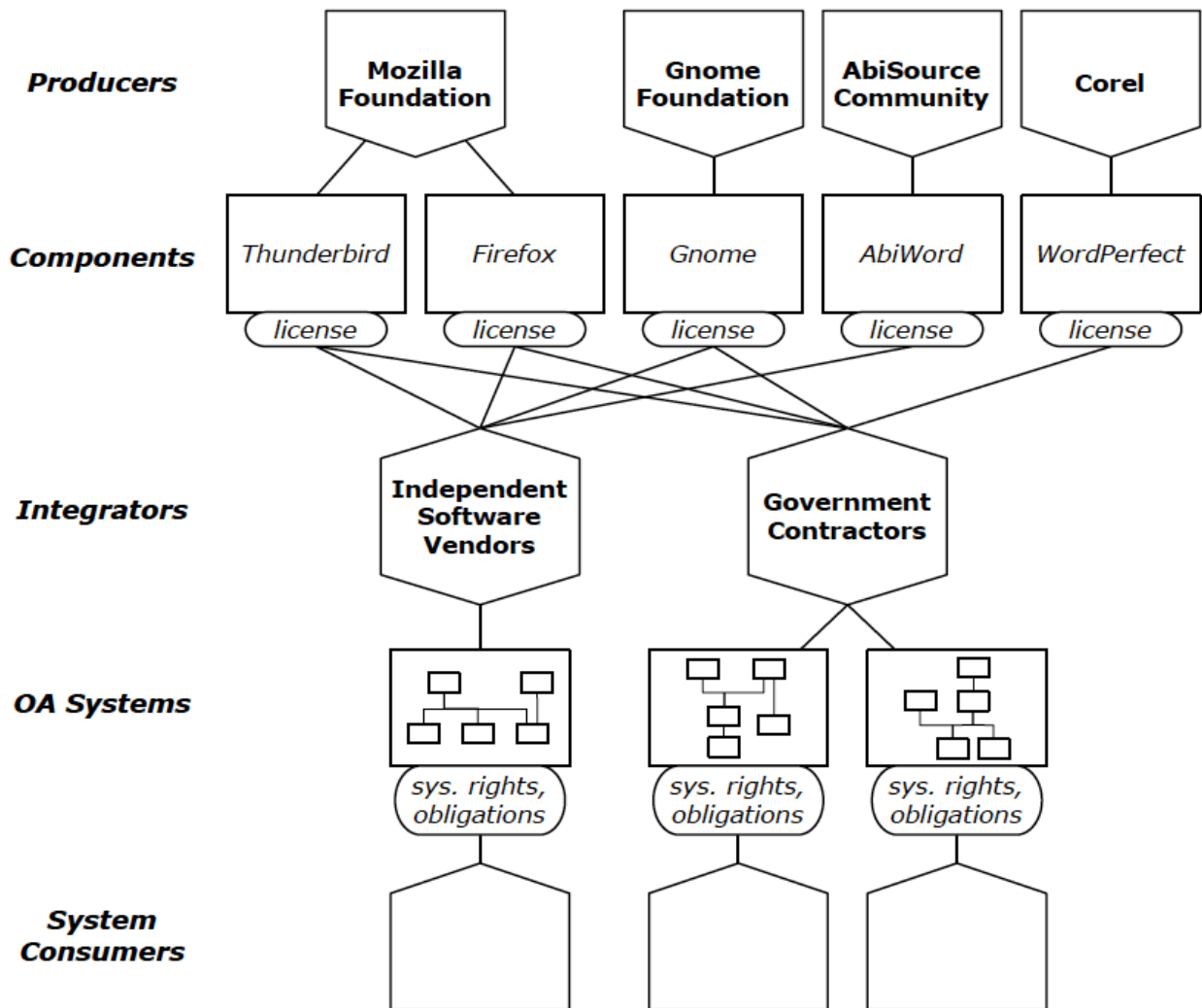

Figure 1. An Example of a Software Ecosystem in which OA Systems Are Developed

1. The Mono Class Library, Copyright 2005-2008 Novell, Inc.
 1. The Mono Runtime Libraries, Copyright 2005-2008 Novell, Inc.
 2. Boo, Copyright 2003-2008 Rodrigo B. Oliveira.
 3. UnityScript, Copyright 2005-2008 Rodrigo B. Oliveira.
 4. OpenAL cross platform audio library, Copyright 1999-2006 by authors.
 5. PhysX physics library. Copyright 2003-2008 by Ageia Technologies, Inc.
 6. libvorbis. Copyright (c) 2002-2007 Xiph.org Foundation.
 7. libtheora. Copyright (c) 2002-2007 Xiph.org Foundation.
 8. zlib general purpose compression library. Copyright (c) 1995-2005 Jean-loup Gailly and Mark Adler.
 9. libpng PNG reference library.



10. jpeglib JPEG library. Copyright (C) 1991-1998, Thomas G. Lane.
11. Twilight Prophecy SDK, a multi-platform development system for virtual reality and multimedia. Copyright 1997-2003 Twilight 3D Finland Oy Ltd.
12. dynamic bitset, Copyright Chuck Allison and Jeremy Siek 2001-2002.
13. The Mono C# Compiler and Tools, Copyright 2005-2008 Novell, Inc.
14. libcurl. Copyright (c) 1996-2008, Daniel Stenberg <daniel@haxx.se>.
15. PostgreSQL Database Management System.
16. FreeType. Copyright (c) 2007 The FreeType Project (www.freetype.org).
17. NVIDIA Cg. Copyright (c) 2002-2008 NVIDIA Corp.

An OA system can evolve by a number of distinct mechanisms, some of which are common to all systems and others of which are a result of heterogeneous component licenses in a single system.

By component evolution—One or more components can evolve, altering the overall system's characteristics (for example, upgrading and replacing the Firefox Web browser from version 3.5 to 3.6).

By component replacement—One or more components may be replaced by others with different behaviors but the same interface, or with a different interface and the addition of shim code to make it match (for example, replacing the AbiWord word processor with either Open Office or MS Word).

By architecture evolution—The OA can evolve, using the same components but in a different configuration, altering the system characteristics. For example, as discussed in Section 4, changing the configuration in which a component is connected can change how its license affects the rights and obligations for the overall system. This could arise when replacing email and word processing applications with web services like Google Mail and Google Docs.

By component license evolution—The license under which a component is available may change (for example, when the license for the Mozilla core components was changed from the Mozilla Public License (MPL) to the current Mozilla Disjunctive Tri-License), or the component may be made available under a new version of the same license (for example, when the GNU General Public License (GPL) version 3 was released).

By a change to the desired rights or acceptable obligations—The OA system's integrator or consumers may desire additional license rights (for example, the right to sublicense in addition to the right to distribute) or no longer desire specific rights or the set of license obligations they find acceptable may change. In either case, the OA system evolves, whether by changing components, evolving the architecture, or by other means, to provide the desired rights within the scope of the acceptable obligations. For example, they may no longer be willing or able to provide the source code for components within the reciprocity scope of a GPL-licensed module.

The interdependence of integrators and producers results in a co-evolution of software within an OA ecosystem. Closely coupled components from different producers must evolve in parallel in order for each to provide its services, as evolution in one will



typically require a matching evolution in the other. Producers may manage their evolution with a loose coordination among releases, for example like that between the Gnome and Mozilla organizations. Each release of a producer component creates a tension through the ecosystem relationships with consumers and their releases of OA systems using those components, as integrators accommodate the choices of available, supported components with their own goals and needs. As discussed in our previous work (Alspaugh et al., 2009a, May), license rights and obligations are manifested at each component interface then mediated through the OA of the system to entail the rights and corresponding obligations for the system as a whole. As a result, integrators must frequently re-evaluate the OA system rights and obligations. In contrast to homogeneously licensed systems, *license change across versions is a characteristic of OA ecosystems*, and architects of OA systems require tool support for managing the ongoing licensing changes.

We propose that such support must have several characteristics. It must rest on a license structure of rights and obligations (section 5), focusing on obligations that are enactable (it can be put into practice) and testable. For example, many OSS licenses include an obligation to make a component's modified code public, and whether a specific version of the code is public at a specified Web address is both enactable and testable. In contrast, the GPL v.3 provision "No covered work shall be deemed part of an effective technological measure under any applicable law fulfilling obligations under article 11 of the WIPO copyright treaty" is not enactable in any obvious way, nor is it testable—how can one verify what others deem?

- It must take account of the distinctions between the design-time, build-time, and distribution-time architectures (sections 4, 5, 6) and the rights and obligations that come into play for each of them.
- It must distinguish the architectural constructs significant for software licenses and embody their effects on rights and obligations (section 4).
- It must define license architectures (section 6).
- It must provide an automated environment for creating and managing license architectures. We are developing a prototype that manages a license's architecture as a view of its system architecture (Alspaugh et al., 2009a, May).
- Finally, it must automate calculations on system rights and obligations so that they may be done easily and frequently, whenever any of the factors affecting rights and obligations may have changed (Section 7).

In the remainder of this paper, we survey some related work (section 2), provide an overview of OSS licenses and projects (section 3), define and examine characteristics of open architectures (section 4), introduce a structure for licenses (section 5), outline license architectures (section 6), and sketch our approach for license analysis (section 7). We then close with a discussion addressing how our software license and analysis scheme relates to software products lines and to specification of software system security requirements (section 8) before stating our conclusions (section 9).

Related Work

It has been typical until recently for each software or information system to be designed, built, and distributed under the terms of a single proprietary or OSS license, with all its components homogeneously covered by that same license. The system is distributed with sources or executables bearing copyright and license notices, and the license gives



specific rights while imposing corresponding obligations that system consumers (whether external developers or users) must honor, subject to the provisions of contract and commercial law. Consequently, there has been some very interesting study of the choice of OSS license for use in an OSS development project, and its consequences in determining the likely success of such a project.

Brown and Booch (2002) discuss issues that arise in the reuse of OSS components, such as interdependence (via component interconnection at design-time or linkage at build-time or run-time) causing functional changes to propagate and versions of the components evolving asynchronously, giving rise to co-evolution of interrelated code in the OSS-based systems. If the components evolve, the OA system itself is evolving. The evolution can also include changes to the licenses, and the licenses can change from component version to version (cf. Footnote 1).

Legal scholars have examined OSS licenses and how they interact in the legal domain but not in the context of HLSs (Fontana et al., 2008; Rosen, 2005; St. Laurent, 2004). For example, Rosen surveys eight OSS licenses and creates two new ones written to professional legal standards. He examines interactions primarily in terms of the general categories of reciprocal and non-reciprocal licenses, rather than in terms of specific licenses. However, common to this legal scholarship is an approach that analyzes the interaction among licenses on a pair-wise or interlinked components basis. This analysis scheme means that if system A has OSS license of type X, system B has a licenses of type Y, and system C has license of type Z, then license interaction (matching, subsumption, or conflicting constraints) is determined by how A interacts with B, B with C, and A with C. This follows from related legal scholarship (e.g., Burk, 1998) that brought attention to problems of whether or not intellectual property rights apply depending on how the systems (or components) are interlinked (cf., German and Hassan, 2009). We similarly adopt this approach in our analysis efforts.

Stewart, Ammeter, and Maruping (2006) conducted an empirical study to examine whether license choice is related to OSS project success, finding a positive association following from the selection of business- friendly licenses. Sen, Subramaniam, and Nelson in a series of studies (2007 & 2009) similarly find positive relationships between the choice of a OSS license and the likelihood of both successful OSS development and adoption of corresponding OSS systems within enterprises. These studies direct attention to OSS projects that adopt and identify their development efforts through use of a single OSS license. However, there has been little explicit guidance on how best to develop, deploy, and sustain complex software systems when heterogeneously licensed components are involved, and thus multiple OSS and proprietary licenses may be involved. Ven and Mannaert (2008); Tuunanen, Koskinen, and Karkkainen (2009); and German and Hassan (2009) are recent exceptions.

Ven and Mannaert discuss the challenges faced by independent software vendors developing an HLS. They focus on the evolution and maintenance of modified OSS components. Tuunanen, Koskinen, and Karkkainen exemplify most work to date on HLSs, in that they focus on reverse engineering and recovery of individual component licenses on existing systems, rather than on guiding HLS design to achieve and verify desired license outcomes. Their approach does not support the calculation of HLS virtual licenses. German and Hassan model a license as a set of grants, each of which has a set of conjoined conditions necessary for the grant to be given. They analyze interactions between pairs of licenses in the context of five types of component connection. They also identify twelve patterns for avoiding license mismatches, found in an empirical study of a large group of



OSS projects, and characterize the patterns using their model. Our license model extends German and Hassan's to address semantic connections between obligations and rights we find through a textual analysis of OSS licenses.

Other previous work examined how best to align acquisition, system requirements, architectures, and OSS components across different software license regimes to achieve the goal of combining OSS with proprietary software that provide open APIs when developing a composite "system of systems" (Scacchi & Alspaugh, 2008). This is particularly an issue for the US Federal Government in its acquisition of complex software systems subject to *Federal Acquisition Regulations (FARs)* and military service- specific regulations. HLSs give rise to new functional and non-functional requirements that further constrain what kinds of systems can be built and deployed, as well as recognizing that acquisition policies can effectively exclude certain OA configurations while accommodating others, based on how different licensed components may be interconnected.

Open Source Software

Traditional proprietary licenses allow a company to retain control of software it produces and to restrict the access and rights that outsiders can have. OSS licenses, on the other hand, are designed to encourage sharing and reuse of software, and grant access and as many rights as possible. OSS licenses are classified as academic or reciprocal. *Academic OSS licenses* such as the Berkeley Software Distribution (BSD) license, the Massachusetts Institute of Technology license, the Apache Software License, and the Artistic License grant nearly all rights to components and their source code and impose few obligations. Anyone can use the software, create derivative works from it, or include it in proprietary projects. Typical academic obligations are simply to not remove the copyright and license notices.

Reciprocal OSS licenses take a more active stance towards sharing and reusing software by imposing the obligation that reciprocally licensed software not be combined (for various definitions of "combined") with any software that is not in turn also released under the reciprocal license. The goals are to increase the domain of OSS by encouraging developers to bring more components under its aegis and to prevent improvements to OSS components from vanishing behind proprietary licenses. Example reciprocal licenses are GPL, the Mozilla Public License (MPL), and the Common Public License.

Both proprietary and OSS licenses typically disclaim liability, assert no warranty is implied, and obligate licensees to not use the licensor's name or trademarks. Newer licenses often cover patent issues as well, either giving a restricted patent license or explicitly excluding patent rights.

The Mozilla Disjunctive Tri-License licenses the core Mozilla components under any one of three licenses (MPL, GPL, or the GNU Lesser General Public License LGPL). OSS developers can choose the one that best suits their needs for a particular project and component.

The Open Source Initiative (OSI) maintains a widely respected definition of "open source" and gives its approval to licenses that meet it (Open Source Initiative, 2008). OSI maintains and publishes a repository of approximately 70 approved OSS licenses.

Common practice has been for an OSS project to choose a single license under which all its products are released and to require developers to contribute their work only under conditions compatible with that license. For example, the Apache Contributor License



Agreement grants enough of each author's rights to the Apache Software Foundation for the foundation to license the resulting systems under the Apache Software License. This sort of rights regime, in which the rights to a system's components are homogeneously granted and the system has a single well-defined OSS license, was the norm in the early days of OSS and continues to be practiced.

Open Architecture

Open architecture (OA) software is a customization technique introduced by Oreizy (2000) that enables third parties to modify a software system through its exposed architecture, evolving the system by replacing its components. Increasingly more software-intensive systems are developed using an OA strategy, not only with OSS components but also proprietary components with open APIs (Unity Technologies, 2008). Using this approach can lower development costs and increase reliability and function (Scacchi & Alspaugh, 2008). Composing a system with HLS components, however, increases the likelihood of conflicts, liabilities, and no-rights stemming from incompatible licenses. Thus, in our work we define an OA system as a software system consisting of components that are either open source or proprietary with open API, whose overall system rights at a minimum allow its use and redistribution in full or in part.

It may appear that using a system's architecture that incorporate OSS components and uses open APIs will result in an OA system. But not all such architectures will produce an OA, since the (possibly empty) set of available license rights for an OA system depends on (a) how and why OSS and open APIs are located within the system architecture, (b) how OSS and open APIs are implemented, embedded, or interconnected, and (c) the degree to which the licenses of different OSS components encumber all or part of a software system's architecture into which they are integrated (Alspaugh & Anton, n.d.; Scacchi & Alspaugh, 2008).

The following kinds of software elements appearing in common software architectures can affect whether the resulting systems are open or closed (Bass, Clements & Kazman, 2003).

Software source code components—These can be either (a) standalone programs, (b) libraries, frameworks, or middleware, (c) inter-application script code such as C shell scripts, or (d) intra-application script code, as for creating Rich Internet Applications using domain-specific languages such as XUL for the Firefox Web browser (Feldt, 2007) or "mashups" (Nelson & Churchill, 2006). Their source code is available and they can be rebuilt. Each may have its own distinct license.



Executable components—These components are in binary form, and the source code may not be open for access, review, modification, or possible redistribution (Rosen, 2005). If proprietary, they often cannot be redistributed, and so such components will be present in the design- and run-time architectures but not in the distribution-time architecture.

Software services—An appropriate software service can replace a source code or executable component.

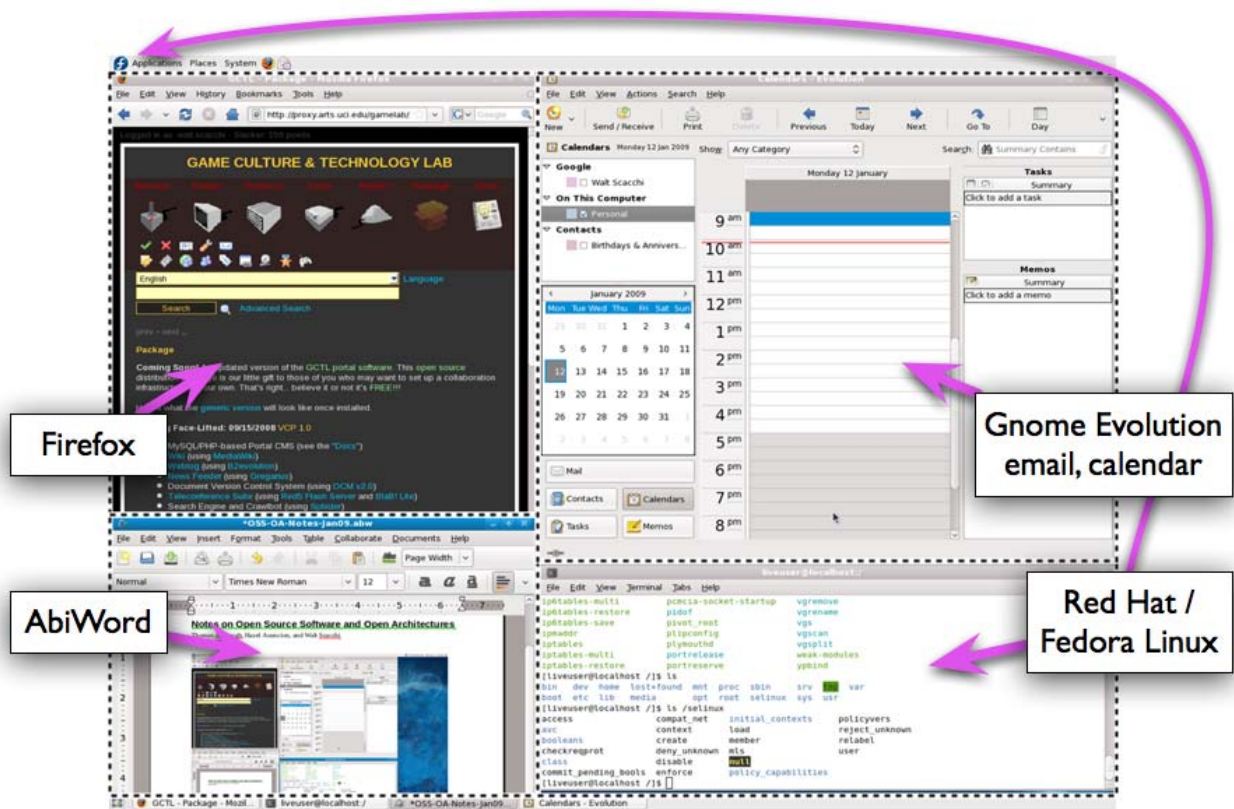

Figure 2. A Heterogeneously Licensed System Composed from Multiple Systems

Application programming interfaces/APIs—Availability of externally visible and accessible APIs is the minimum requirement for an open system (Meyers & Oberndorf, 2001). APIs are not and cannot be licensed and can limit the propagation of license obligations.

Software connectors—Software whose intended purpose is to provide a standard or reusable way of communication through common interfaces, e.g., High Level Architecture (Kuhl, Weatherly & Dahmann, 1999), CORBA, MS.NET, Enterprise Java Beans, and GNU Lesser General Public License (LGPL) libraries. Connectors can also limit the propagation of license obligations.

Methods of connection—These include linking as part of a configured subsystem, dynamic linking, and client-server connections. Methods of connection affect license obligation propagation, with different methods affecting different licenses.

Configured system or subsystem architectures—These are software systems that are used as atomic components of a larger system and whose internal architecture may



comprise components with different licenses, affecting the overall system license. To minimize license interaction, a configured system or sub-architecture may be surrounded by what we term a license firewall, namely a layer of dynamic links, client-server connections, license shims, or other connectors that block the propagation of reciprocal obligations.

Figure 3 shows a high-level view of a reference architecture that includes all the kinds of software elements listed above. This reference architecture has been instantiated in a number of configured systems that combine OSS and closed source components. One such system handles time sheets and payroll at our university; another implements the web portal for a university computer game research laboratory (the updated version now at

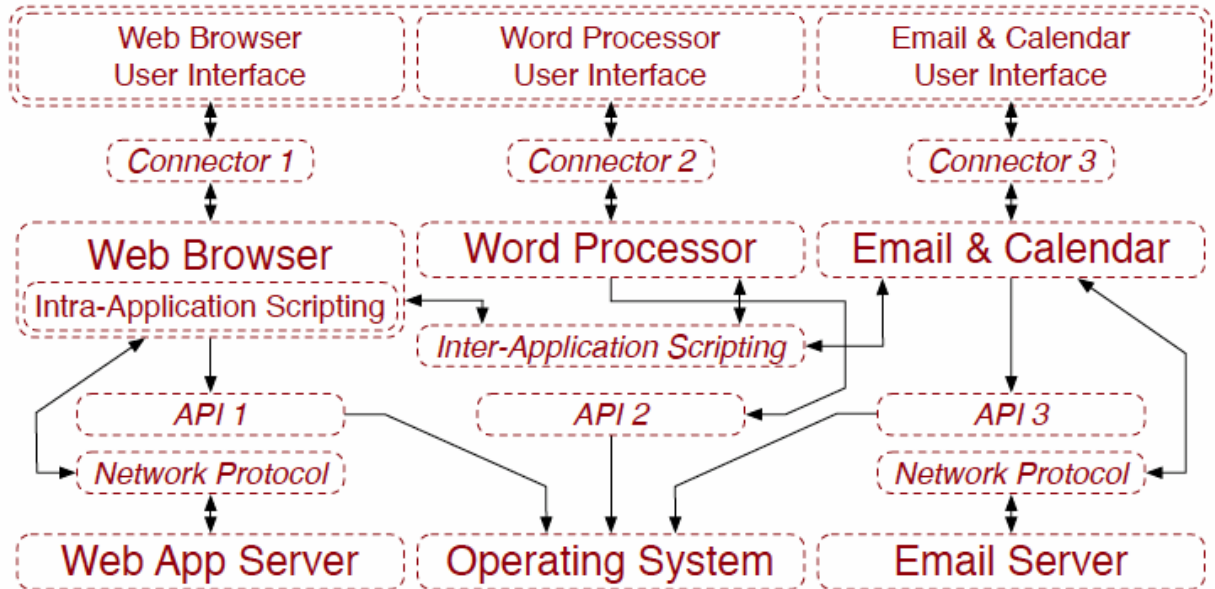

<http://cgvw.ics.uci.edu>).

Figure 3. The Design-time Architecture of the System of Figure 2



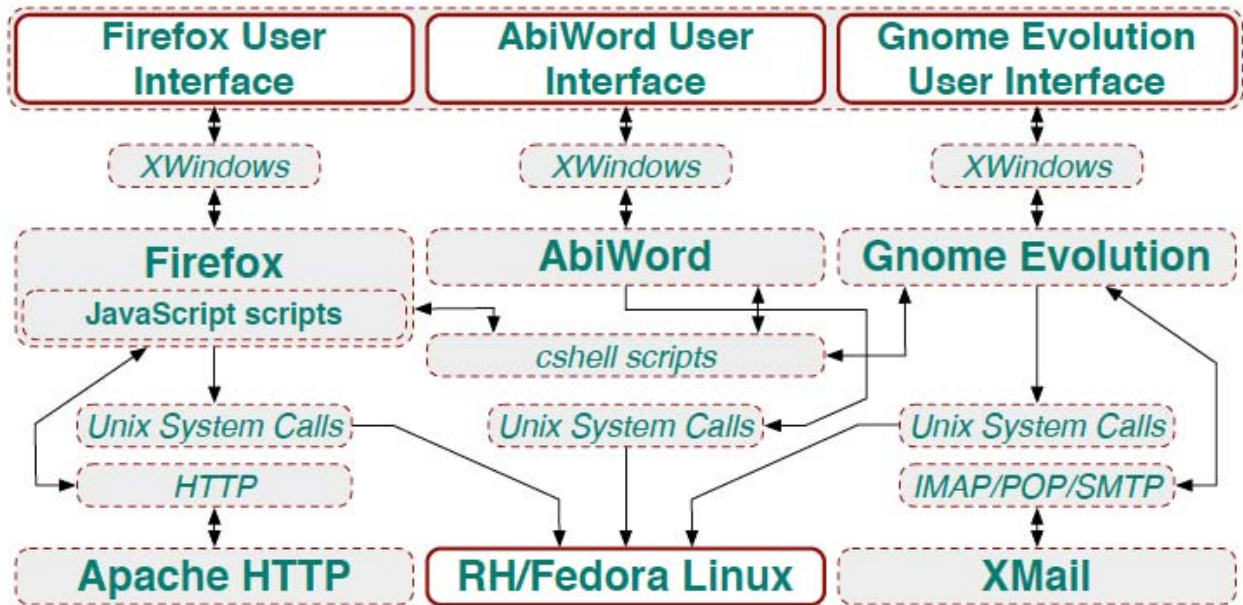

Figure 4. A Build-time Architecture Describing the Version Running in Figure 2

(Note: Components or connectors not visible in Figure 2 are shown in gray.)

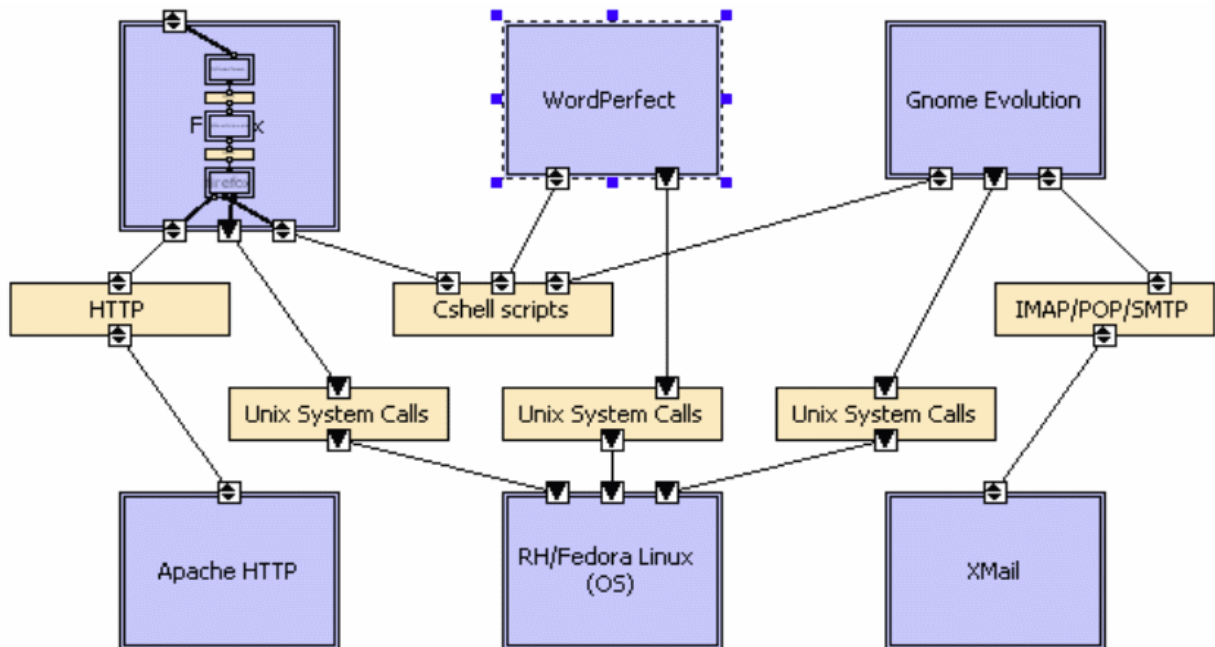

Figure 5. Instantiated Build-time Architecture (Figure 4) within ArchStudio

The configured systems consist of software components such as a Mozilla Web browser, Gnome Evolution email client, and AbiWord word processor (similar to MS Word), all running on a RedHat Fedora Linux operating system accessing file, print, and other remote networked servers such as an Apache Web server. Components are interconnected



through a set of software connectors that bridges the interfaces of components and combines the provided functionality into the system's services.

Software Licenses

Copyright law is the common basis for software licenses and gives the original author of a work certain exclusive rights: the rights to use, copy, modify, merge, publish, distribute, sub-license, and sell copies. The author may license these rights, individually or in groups, to others; the license may give a right either exclusively or non-exclusively. After a period of years, copyright rights enter the public domain. Until then, copyright may only be obtained through licensing.

Licenses typically impose obligations that must be met in order for the licensee to realize the assigned rights. Common obligations include the obligation to publish at no cost any source code you modify (MPL) or the reciprocal obligation to publish all source code included at build-time or statically linked (GPL). The obligations may conflict, as when a GPL'd component's reciprocal obligation to publish source code of other components is combined with a proprietary component's license prohibition of publishing its source code. In this case, no rights may be available for the system as a whole, not even the right of use, because the two obligations cannot simultaneously be met and thus neither component can be used as part of the system.

The basic relationship between software license rights and obligations can be summarized as follows: if the specified obligations are met, then the corresponding rights are granted. For example, if you publish your modified source code and sub-licensed derived works under MPL, then you get all the MPL rights for both the original and the modified code. However, license details are complex, subtle, and difficult to comprehend and track. So it is easy to become confused or make mistakes. The challenge is multiplied when dealing with configured system architectures that compose a large number of components with heterogeneous licenses, so the need for legal counsel begins to seem inevitable (Rosen, 2005; Fontana et al., 2008).

We have developed an approach for expressing software licenses that is more formal and less ambiguous than natural language and that allows us to calculate and identify conflicts arising from the rights and obligations of two or more component's licenses. Our approach is based on Hohfeld's classic group of eight fundamental jural relations (1913), of which we use *right*, *duty*, *no-right*, and *privilege*. We start with a tuple **<actor, operation, action, object>** for expressing a right or obligation. The actor is the "licensee" for all the licenses we have examined. The operation is one of the following: "may," "must," "must not," or "need not," with "may" and "need not" expressing rights and "must" and "must not" expressing obligations. Because copyright rights are only available to entities that have been granted a sublicense, only the listed rights are available, and the absence of a right means that it is not available. The action is a verb or verb phrase describing what may, must, must not, or need not be done, with the object completing the description. A license may be expressed as a set of rights, with each right associated with zero or more obligations that must be fulfilled in order to enjoy that right. Figures 6, 7, and 8 show the meta-model we use to express licenses, with the allowed combinations of modality, object, and license shown in Figure 6.



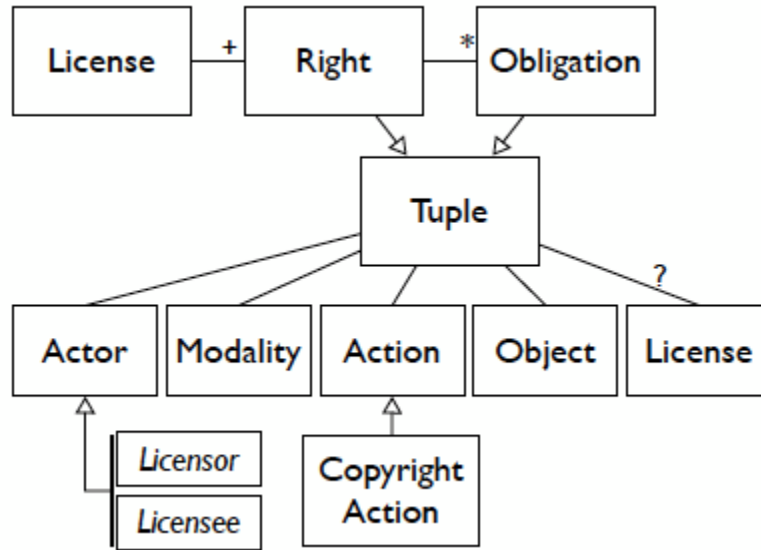

Figure 6. License Meta-model

HLS designers have developed a number of heuristics to guide architectural design while avoiding some license conflicts. First, it is possible to use a reciprocally licensed component through a *license firewall* that limits the scope of reciprocal obligations. Rather than connecting conflicting components directly through static or other build-time links, the connection is made through a dynamic link, client-server protocol, license shim (such as a Limited General Public License connector), or run-time plug-ins. A second approach used by a number of large organizations is simply to avoid using any components with reciprocal licenses. A third approach is to meet the license obligations (if that is possible) by, for example, retaining copyright and license notices in the source and publishing the source code. However, even using design heuristics such as these (and there are many), keeping track of license rights and obligations across components that are interconnected in complex OAs quickly becomes too cumbersome. Automated support is needed to manage the multi-component, multi-license complexity.

| | Modality | Object | License (optional) |
|---------------------|------------------|--|-------------------------------------|
| Abstract Right | May or Need Not | Any Under This License | This License or Object's License |
| | | Any Source | |
| | | Under This License Any Component Under This License | |
| Concrete Right | Must or Must Not | Concrete Object | Concrete License |
| Concrete Obligation | | Concrete License or Right's License | |
| Abstract Obligation | Must or Must Not | Right's Object | Concrete License or Right's License |
| | | All Sources Of Right's Object | |
| | | X Scope Sources | |
| | | X Scope Components | |

Figure 7. Modality, Object, and License



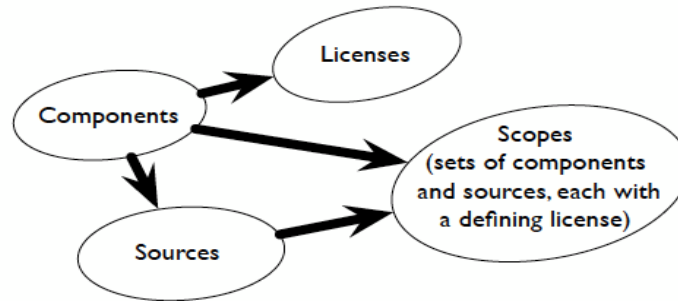

Figure 8. The License Architecture Meta-model

License Architectures

Our license model forms a basis for effective reasoning about licenses in the context of actual systems and calculating the resulting rights and obligations. In order to do so, we need a certain amount of information about the system's configuration at design-, build-, distribution-, and run-time. The needed information comprises the *license architecture*, an abstraction of the system architecture of its:

2. set of components of the system,
 18. relation mapping each component to its license,
 19. relation mapping each component to its set of sources, and
 20. relation from each component to the set of components in the same license scope, for each license for which "scope" is defined (e.g., GPL) and from each source to the set of sources of components in the scope of its component.

With this information and definitions of the licenses involved, for example, as seen in Figure 9, we calculate rights and obligations for individual components or the entire system and guide heterogeneous license matching across components, as shown in Figure 10.



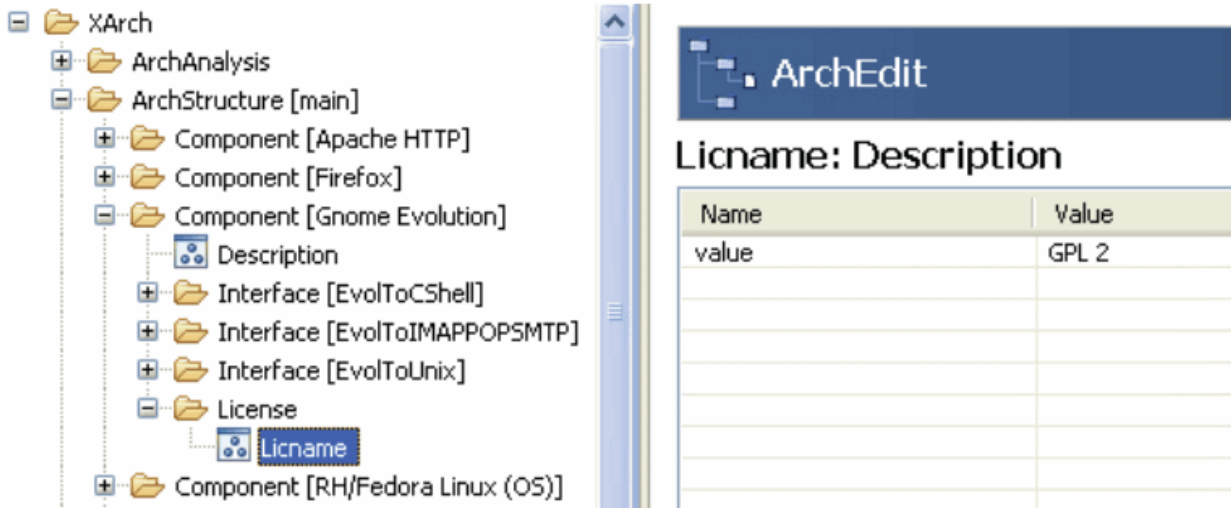

Figure 9. License Annotation of Gnome Evolution Component

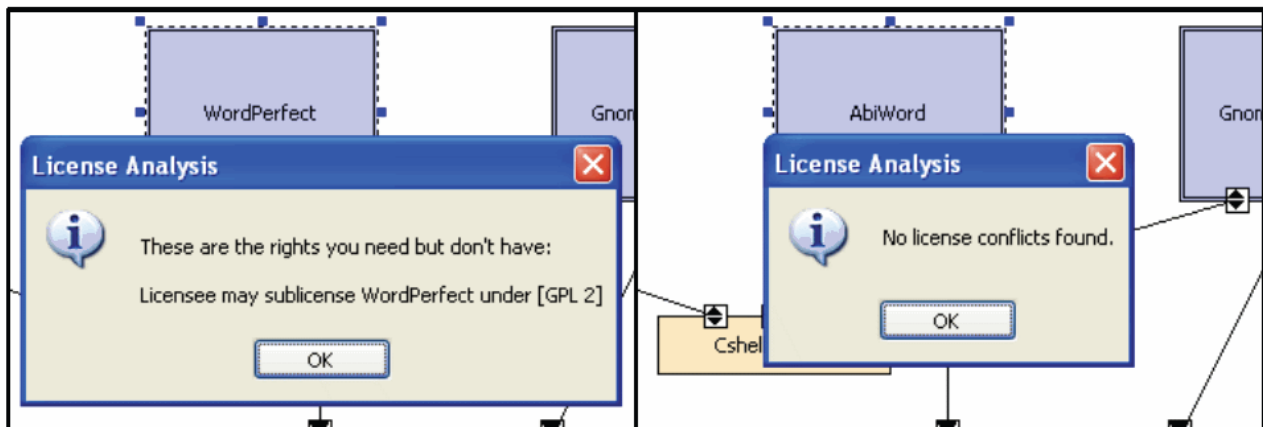

Figure 10. License Analysis Reports Before (left) and After (right) Replacing a Component System

License Analysis

Given a specification of a software system's architecture, we can associate software license attributes with the system's components, connectors, and sub-system architectures, resulting in a license architecture for the system, and calculate the copyright rights and obligations for the system's configuration. Due to the complexity of license architecture analysis and the need to re-analyze every time a component evolves, a component's license changes, a component is substituted, or the system architecture changes, OA integrators really need an automated license architecture analysis environment. We are developing a prototype of such an environment (Alspaugh et al., 2009a, May).

We use an architectural description language specified in xADL (Institute for Software Research, 2009) to describe OAs that can be designed and analyzed with a



software architecture design environment (Medvidovic, Rosenblum & Taylor, 1999), such as ArchStudio4 (Institute for Software Research, 2006). We have built the Software Architecture License Analysis module on top of ArchStudio's Traceability View (Asuncion & Taylor, 2009). This allows for the specification of licenses as a list of attributes (license tuples) using a form-based user interface in ArchStudio4 (Medvidovic, et al., 1999; Institute for Software Research, 2006). We analyze rights and obligations as described below (Alspaugh et al., 2009a, May) and as shown above in Figures 9 and 10.

Propagation of Reciprocal Obligations

We follow the widely accepted interpretation that build-time static linkages propagate the reciprocal obligations, but appropriate license firewalls do not. Analysis begins, therefore, by propagating these obligations along all connectors that are not license firewalls.

Obligation Conflicts

An obligation can conflict with another obligation or with the set of available rights by requiring a copyright right that has not been granted. For instance, a proprietary license may require that a licensee must not redistribute source code, but GPL states that a licensee must redistribute source code. Thus, the conflict appears in the modality of the two otherwise identical obligations, “must not” in the proprietary license and “must” in GPL.

Rights and Obligations Calculations

The rights available for the entire system (use, copy, modify, etc.) are calculated as the intersection of the sets of rights available for each component of the system. If a conflict is found involving the obligations and rights of linked components, it is possible for the system architect to consider an alternative linking scheme, e.g., using one or more connectors along the paths between the components that act as a license firewall. This means that the architecture and the automated environment together can determine what OA design best meets the problem at hand with available software components. Components with conflicting licenses do not need to be arbitrarily excluded but instead may expand the range of possible architectural alternatives if the architect seeks such flexibility and choice.

Discussion

At least two topics merit discussion following from our approach to semantically modeling and analyzing OA systems that are subject to heterogeneous software licenses. One is how our results might shed light on software systems whose architectures articulate a *software product line*, while the other is how our approach might be extended to also address the semantic modeling and analysis of *software system security requirements*.

First, organizing and developing software product lines (SPLs) relies on the development and use of explicit software architectures (Bosch, 2000; Clements & Northrop, 2001). However, the architecture of a SPL is not necessarily an OA—there is no requirement for it to be so. Thus, we are interested in discussing what happens when SPLs may conform to an OA, and to an OA that may be subject to heterogeneously licensed SPL components. Three considerations come to mind. If the SPL is subject to a single homogeneous software license, which may often be the case when a single vendor or



government contractor has developed the SPL, then the license may act to reinforce a vendor lock-in situation with its customers. One of the motivating factors for OA is the desire to avoid such lock-in, whether or not the SPL components have open or standards-compliant APIs. Alternatively, if an OA system employs a reference architecture much like we have in the design-time architecture depicted in Figure 3, which is then instantiated into a specific software product configuration, as suggested in the build-time architecture (shown in Figure 4), then such a reference or design-time architecture as we have presented it here effectively defines a SPL consisting of possible different system instantiations composed from similar components instances (e.g., different but equivalent Web browsers, word processors, email, calendaring applications, and relational database management systems). Finally, if the SPL is based on an OA that integrates software components from multiple vendors or OSS components that are subject to heterogeneous licenses, then we have the situation analogous to what we have presented in this paper. So SPL concepts are compatible with OA systems that are composed from heterogeneously licensed components.

Second, as already noted, software licenses represent a collection of rights and obligations for what can or cannot be done with a licensed software component. Licenses thus denote non-functional requirements that apply to a software systems or system components as intellectual property (IP) during their development and deployment. But rights and obligations are not limited to concerns or constraints applicable only to software as IP. Instead, they can be written in ways that stipulate non-functional requirements of different kinds. Consider, for example, that desired or necessary software system security properties can also be expressed as rights and obligations addressing system confidentiality, integrity, accountability, system availability, and assurance (Breux & Anton, 2005; 2008).

Traditionally, developing robust specifications for non-functional software system security properties in natural language often produces specifications that are ambiguous, misleading, inconsistent across system components, and lacking sufficient details (Yau & Chen, 2006). Using a semantic model to formally specify the rights and obligations required for a software system or component to be secure (Breux & Anton, 2005; 2008; Yau & Chen, 2006) means that it may be possible to develop both a “security architecture” notation and model specification that associates given security rights and obligations across a software system or system of systems. Similarly, it suggests the possibility of developing computational tools or interactive architecture development environments that can be used to specify, model, and analyze a software system’s security architecture at different times in its development—design-time, build-time, and run-time.

The approach we have been developing for the past few years for modeling and analyzing software system license architectures for OA systems (Alspaugh et al., 2009, August/September; Alspaugh et al., 2009b, May; Scacchi & Alspaugh, 2008), may therefore be extendable to also being able to address OA systems with heterogeneous “software security license” rights and obligations. Furthermore, the idea of common or reusable software security licenses may be analogous to the reusable security requirements templates proposed by Firesmith (2004) at the Software Engineering Institute. Consequently, such an exploration and extension of the semantic software license modeling, meta-modeling, and computational analysis tools to also support software system security can be recognized as a promising next stage of our research studies.



Conclusion

This paper discusses the role of software ecosystems with heterogeneously licensed components in the development and evolution of OA systems. License rights and obligations play a key role in how and why an OA system evolves in its ecosystem. We note that license changes across versions of components are a characteristic of OA systems and software ecosystems with heterogeneously licensed components. A structure for modeling software licenses and the license architecture of a system and automated support for calculating its rights and obligations are needed in order to manage a system's evolution in the context of its ecosystem. We have outlined an approach for achieving these and sketched how they further the goal of reusing components in developing software-intensive systems. Much more work remains to be done, but we believe this approach turns a vexing problem into one for which workable solutions can be obtained.

Acknowledgments

This research is supported by grant #N00244-10-1-0038 from the Acquisition Research Program at the Naval Postgraduate School and by grant #0808783 from the National Science Foundation. No endorsement implied.

References

- Alspaugh, T.A., & Anton, A.I. (2008, February). Scenario support for effective requirements. *Information and Software Technology*, 50(3), 198–220.
- Alspaugh, T.A., Asuncion, H.U., & Scacchi, W. (2009, May). Analyzing software licenses in open architecture software systems. In *Proceedings of the 2nd International Workshop on Emerging Trends in FLOSS Research and Development (FLOSS)*.
- Alspaugh, T.A., Asuncion, H.U., & Scacchi, W. (2009, August/September). Intellectual property rights requirements for heterogeneously-licensed systems. In *Proceedings of the 17th IEEE International Requirements Engineering Conference (RE'09)*.
- Alspaugh, T.A., Asuncion, H.U., & Scacchi, W. (2009, May). Software licenses, open source components, and open architectures. In *Proceedings of the Sixth Annual Acquisition Research Symposium*. Monterey, CA: Naval Postgraduate School.
- Asuncion, H., & Taylor, R.N. (2009, May). Capturing custom link semantics among heterogeneous artifacts and tools. In *Proceedings of the 5th International Workshop on Traceability in Emerging Forms of Software Engineering (TEFSE)*.
- Bass, L., Clements, P., & Kazman, R. (2003). *Software architecture in practice*. Boston: Addison-Wesley Longman.
- Bosch, J. (2000). *Design and use of software architectures: Adopting and evolving a product-line approach*. New York: Addison-Wesley Professional.
- Breaux, T.D., & Anton, A.I. (2005). Analyzing goal semantics for rights, permissions, and obligations. In *Proceedings of the 13th IEEE International Conference on Requirements Engineering (RE'05)* (pp. 177–188).
- Breaux, T.D., & Anton, A.I. (2008). Analyzing regulatory rules for privacy and security requirements. *IEEE Transactions on Software Engineering*, 34(1), 5–20.



- Brown, A.W., & Booch, G. (2002, April). Reusing open-source software and practices: The impact of open-source on commercial vendors. In *Proceedings of the International Conference on Software Reuse: Methods, Techniques, and Tools (ICSR-7)*.
- Burk, D.L. (1998). Proprietary rights in hypertext linkages. *Journal of Information, Law and Technology*, 2.
- Clements, P., & Northrop, L. (2001). *Software product lines: Practices and patterns*. New York: Addison-Wesley Professional.
- Feldt, K. (2007). *Programming Firefox: Building rich internet applications with XUL*. Sebastopol, CA: O'Reilly Media.
- Firesmith, D. (2004). Specifying reusable security requirements. *Journal of Object Technology*, 3(1), 61–75.
- Fontana, R., Kuhn, B.M., Moglen, E., Norwood, M., Ravicher, D.B., Sandler, K., et al. (2008). *A legal issues primer for open source and free software projects*. New York: Software Freedom Law Center.
- German, D.M., & Hassan, A.E. (2009, May). License integration patterns: Dealing with licenses mis-matches in component-based development. In *Proceedings of the 28th International Conference on Software Engineering (ICSE'09)*.
- Hohfeld, W.N. (1913). Some fundamental legal conceptions as applied in judicial reasoning. *Yale Law Journal*, 23(1), 16–59.
- Institute for Software Research. (2006). *ArchStudio 4*. Retrieved from <http://www.isr.uci.edu/projects/archstudio/>
- Institute for Software Research. (2009). *xADL 2.0*. Retrieved from <http://www.isr.uci.edu/projects/xarchuci/>
- Kuhl, F., Weatherly, R., & Dahmann, J. (1999). *Creating computer simulation systems: An introduction to the high level architecture*. Englewood Cliffs, NJ: Prentice Hall.
- Medvidovic, N., Rosenblum, D.S., & Taylor, R.N. (1999). A language and environment for architecture-based software development and evolution. In *Proceedings of the 21st International Conference on Software Engineering (ICSE'21)*, 44–53.
- Meyers, B.C., & Oberndorf, P. (2001). *Managing Software Acquisition: Open Systems and COTS Products*. New York: Addison-Wesley Professional.
- Nelson, L., & Churchill, E.F. (2006). Repurposing: Techniques for reuse and integration of interactive systems. In *Proceedings of the International Conference on Information Reuse and Integration (IRI-08)*, 490–495.
- Open Source Initiative. (2008). *Open Source Initiative*. <http://www.opensource.org/>
- Oreizy, P. (2000). *Open architecture software: A flexible approach to decentralized software evolution*. Unpublished doctoral dissertation, University of California, Irvine.
- Rosen, L. (2005). *Open source licensing: Software freedom and intellectual property law*. Englewood Cliffs, NJ: Prentice Hall.
- Scacchi, W., & Alspaugh, T.A. (2008, May). Emerging issues in the acquisition of open source software within the U.S. Department of Defense. In *Proceedings of the 5th Annual Acquisition Research Symposium*. Monterey, CA: Naval Postgraduate School.



- Sen, R. (2007). A strategic analysis of competition between open source and proprietary software. *Journal of Management Information Systems*, 24(1), 233–257.
- Sen, R., Subramaniam, C., & Nelson, M.L. (2009). Determinants of the choice of open source software license. *Journal of Management Information Systems*, 25(3), 207–240.
- St. Laurent, A.M. (2004). *Understanding open source and free software licensing*. Sebastopol, CA: O'Reilly Media.
- Stewart, K.J., Ammeter, A.P., & Maruping, L.M. (2006). Impacts of license choice and organizational sponsorship on user interest and development activity in open source software projects. *Information Systems Research*, 17(2), 126–144.
- Subramaniam, C., Sen, R., & Nelson, M.L. (2009). Determinants of open source software project success: A longitudinal study. *Decision Support Systems*, 46(2), 576–585.
- Tuunanen, T., Koskinen, J., & Karkkainen, T. (2009). Automated software license analysis. *Automated Software Engineering*, 16(3-4), 455–490.
- Unity Technologies. (2008). *End user license agreement*. Retrieved December 2008, from <http://unity3d.com/unity/unity-end-user-license-2.x.html>
- Ven, K., & Mannaert, H. (2008). Challenges and strategies in the use of open source software by independent software vendors. *Information and Software Technology*, 50(9-10), 991–1002.
- Yau, S.S., & Chen, Z. (2006). A framework for specifying and managing security requirements in collaborative systems. In *Proceedings of the Third International Conference on Autonomic and Trusted Computing (ATC 2006)* (pp. 500–510)



2003 - 2010 Sponsored Research Topics

Acquisition Management

- Acquiring Combat Capability via Public-Private Partnerships (PPPs)
- BCA: Contractor vs. Organic Growth
- Defense Industry Consolidation
- EU-US Defense Industrial Relationships
- Knowledge Value Added (KVA) + Real Options (RO) Applied to Shipyard Planning Processes
- Managing the Services Supply Chain
- MOSA Contracting Implications
- Portfolio Optimization via KVA + RO
- Private Military Sector
- Software Requirements for OA
- Spiral Development
- Strategy for Defense Acquisition Research
- The Software, Hardware Asset Reuse Enterprise (SHARE) repository

Contract Management

- Commodity Sourcing Strategies
- Contracting Government Procurement Functions
- Contractors in 21st-century Combat Zone
- Joint Contingency Contracting
- Model for Optimizing Contingency Contracting, Planning and Execution
- Navy Contract Writing Guide
- Past Performance in Source Selection
- Strategic Contingency Contracting
- Transforming DoD Contract Closeout
- USAF Energy Savings Performance Contracts
- USAF IT Commodity Council
- USMC Contingency Contracting

Financial Management

- Acquisitions via Leasing: MPS case
- Budget Scoring
- Budgeting for Capabilities-based Planning



- Capital Budgeting for the DoD
- Energy Saving Contracts/DoD Mobile Assets
- Financing DoD Budget via PPPs
- Lessons from Private Sector Capital Budgeting for DoD Acquisition Budgeting Reform
- PPPs and Government Financing
- ROI of Information Warfare Systems
- Special Termination Liability in MDAPs
- Strategic Sourcing
- Transaction Cost Economics (TCE) to Improve Cost Estimates

Human Resources

- Indefinite Reenlistment
- Individual Augmentation
- Learning Management Systems
- Moral Conduct Waivers and First-tem Attrition
- Retention
- The Navy's Selective Reenlistment Bonus (SRB) Management System
- Tuition Assistance

Logistics Management

- Analysis of LAV Depot Maintenance
- Army LOG MOD
- ASDS Product Support Analysis
- Cold-chain Logistics
- Contractors Supporting Military Operations
- Diffusion/Variability on Vendor Performance Evaluation
- Evolutionary Acquisition
- Lean Six Sigma to Reduce Costs and Improve Readiness
- Naval Aviation Maintenance and Process Improvement (2)
- Optimizing CIWS Lifecycle Support (LCS)
- Outsourcing the Pearl Harbor MK-48 Intermediate Maintenance Activity
- Pallet Management System
- PBL (4)
- Privatization-NOSL/NAWCI
- RFID (6)



- Risk Analysis for Performance-based Logistics
- R-TOC AEGIS Microwave Power Tubes
- Sense-and-Respond Logistics Network
- Strategic Sourcing

Program Management

- Building Collaborative Capacity
- Business Process Reengineering (BPR) for LCS Mission Module Acquisition
- Collaborative IT Tools Leveraging Competence
- Contractor vs. Organic Support
- Knowledge, Responsibilities and Decision Rights in MDAPs
- KVA Applied to AEGIS and SSDS
- Managing the Service Supply Chain
- Measuring Uncertainty in Earned Value
- Organizational Modeling and Simulation
- Public-Private Partnership
- Terminating Your Own Program
- Utilizing Collaborative and Three-dimensional Imaging Technology

A complete listing and electronic copies of published research are available on our website:
www.acquisitionresearch.org



THIS PAGE INTENTIONALLY LEFT BLANK





ACQUISITION RESEARCH PROGRAM
GRADUATE SCHOOL OF BUSINESS & PUBLIC POLICY
NAVAL POSTGRADUATE SCHOOL
555 DYER ROAD, INGERSOLL HALL
MONTEREY, CALIFORNIA 93943

www.acquisitionresearch.org



Acquisition Research Program:
Creating Synergy for Informed Change

The Challenge of Heterogeneously Licensed Systems in Open Architecture Software Ecosystems

Thomas A. Alspaugh and Walt Scacchi
Institute for Software Research, University of California, Irvine

Overview

- Background
- Developing Open Architectures (OAs)
- Software licenses, architectures, and analysis
- Discussion
- Conclusions



Background



OA software ecosystem – mapping rights and obligations from producers to consumers

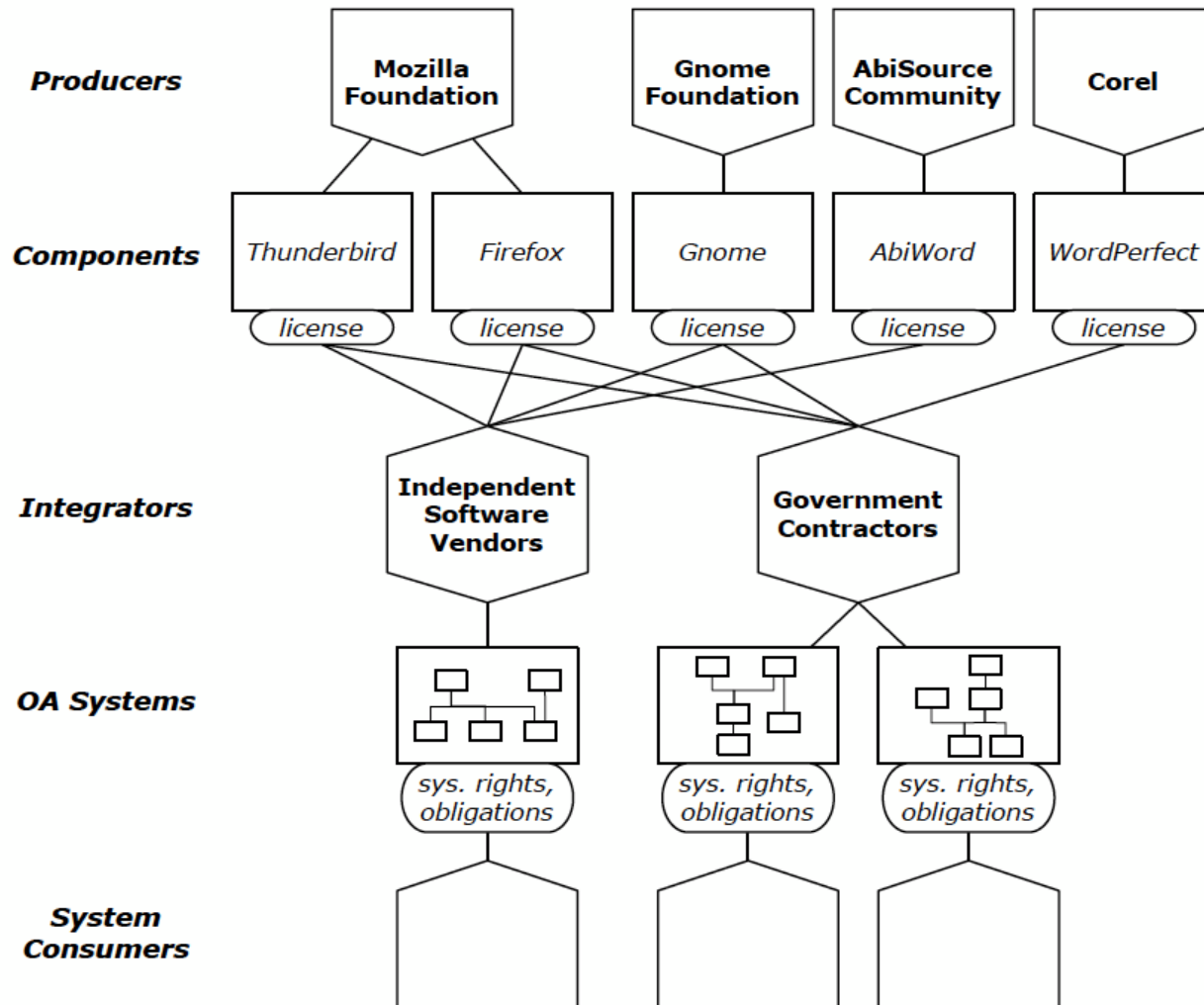

A heterogeneous software license for the *Unity 3D* software system

1. The Mono Class Library, Copyright 2005-2008 Novell, Inc.
2. The Mono Runtime Libraries, Copyright 2005-2008 Novell, Inc.
3. Boo, Copyright 2003-2008 Rodrigo B. Oliveira
4. UnityScript, Copyright 2005-2008 Rodrigo B. Oliveira
5. OpenAL cross platform audio library, Copyright 1999-2006 by authors.
6. PhysX physics library. Copyright 2003-2008 by Ageia Technologies, Inc.
7. libvorbis. Copyright (c) 2002-2007 Xiph.org Foundation
8. libtheora. Copyright (c) 2002-2007 Xiph.org Foundation
9. zlib general purpose compression library. Copyright (c) 1995-2005 Jean-loup Gailly and Mark Adler
10. libpng PNG reference library
11. jpeglib JPEG library. Copyright (C) 1991-1998, Thomas G. Lane.
12. Twilight Prophecy SDK, a multi-platform development system for virtual reality and multimedia. Copyright 1997-2003 Twilight 3D Finland Oy Ltd
13. dynamic bitset, Copyright Chuck Allison and Jeremy Siek 2001-2002.
14. The Mono C# Compiler and Tools, Copyright 2005-2008 Novell, Inc.
15. libcurl. Copyright (c) 1996-2008, Daniel Stenberg <daniel@haxx.se>.
16. PostgreSQL Database Management System
17. FreeType. Copyright (c) 2007 The FreeType Project (www.freetype.org).
18. NVIDIA Cg. Copyright (c) 2002-2008 NVIDIA Corp.



Supporting OA with heterogeneously licensed system components

- Must account for design-time, build-time, and run-time architectures
- Must distinguish architect constructs relevant to software licenses, and license effects
- Must define license architecture
- Must provide automated environment for managing system and license architectures
- Must automate calculations of system license rights, obligations, architectures as they evolve



Developing OA systems with heterogeneously licensed software components



A composed multi-component OA system

The screenshot displays a multi-component Open Architecture (OA) system. It consists of several overlapping windows:

- Top Left Window:** A Mozilla Firefox browser window titled "GCTL - Mission - Mozilla Firefox". The address bar shows "http://hideffer.net/proj/gametal/portal/content.php?". The main content area displays the "GAME CULTURE & TECHNOLOGY LAB" website, which includes a navigation menu, a search bar, and a "Mission" section. The mission text states: "The mission of the Game Culture & Technology Lab is to play with how game metaphors, design principles, and technologies can be utilized for alternative content and context delivery. The focus is on the next generation Internet and beyond. The approach combines theory and practice, art and science, education and entertainment, to create an environment that supports diverse forms of expression in a wide range of applications. The methods include sampling, misuse, hacking, appropriation, reverse engineering, and custom creation in the interest of open-source innovation and critical intervention. Since its inception in 1999, the Game Lab has been physically housed in the Claire Trevor School of the Arts (SOTA). In 2002 we established a co-located facility in The California Institute for Telecommunication and Information Technology (Calit2)." Below the mission text is a "Calendars - Evolution" window.
- Top Right Window:** A Microsoft Word window titled "*JSS-Figure4-draft.abw". The document content reads "A Composed Open Architecture Software System at Run-Time". The window includes a standard Microsoft Office ribbon and a task pane on the right.
- Bottom Left Window:** A "Calendars - Evolution" window showing a calendar for Monday, April 26, 2010. The calendar lists two events: "1:00pm Proposal review meeting" and "3:00pm Work on JSS paper draft". The window also includes a "Tasks" pane with a "Summary" button and a "Memos" pane with a "Summary" button.
- Bottom Right Window:** A terminal window titled "liveuser@localhost:~\$". The terminal shows the output of the "ls" command in the "/sbin" directory. The output is a long list of files and directories, including "access", "checkrepot", "compat_net", "deny_unknown", "initial_contexts", "nls", "policyvers", and "user".



Design-time architecture

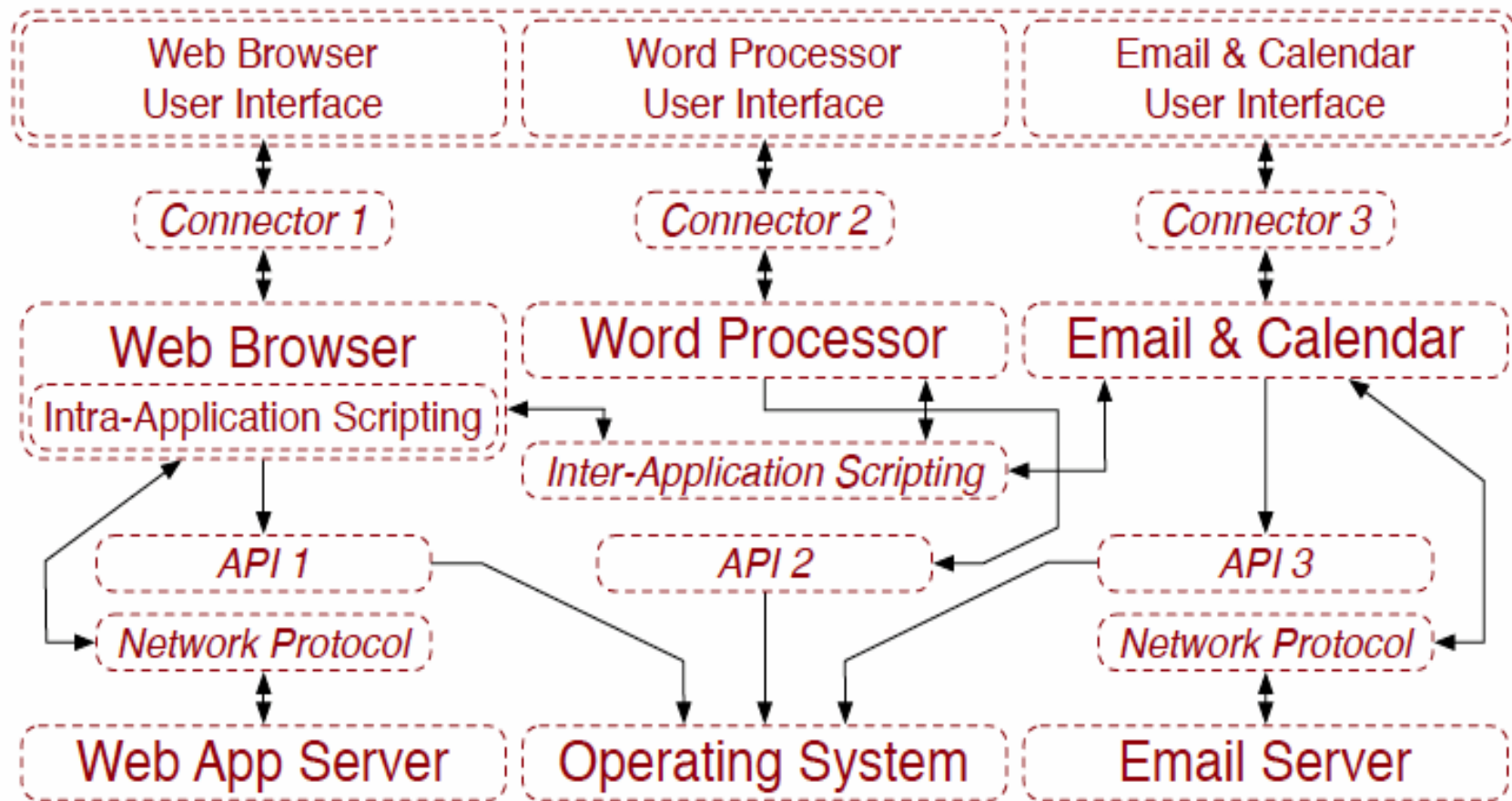

Build-time architecture

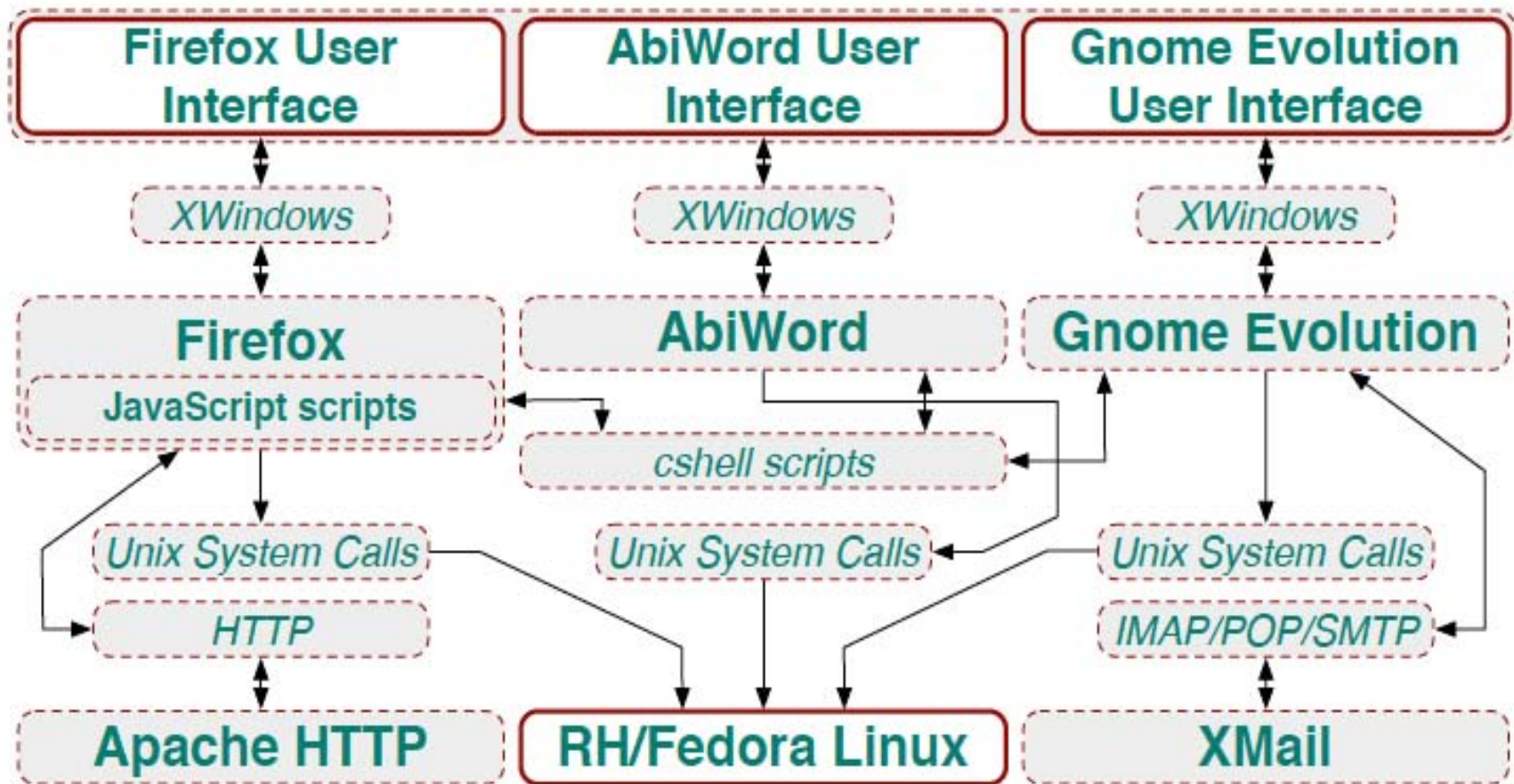

Run-time architecture (user view)

The screenshot displays a desktop environment with several windows open. On the left, a Mozilla Firefox browser window shows the 'GAME CULTURE & TECHNOLOGY LAB' website. The website has a dark theme with a navigation menu and a search bar. Below the browser, a 'Calendars - Evolution' window is open, showing a calendar for Monday, April 26, 2010. The calendar has a task at 1:00pm labeled 'Proposal review meeting' and a memo at 3:00pm labeled 'Work on JSS paper draft'. On the right, a window titled '*JSS-Figure4-draft.abw' is open, displaying a document with the title 'A Composed Open Architecture Software System at Run-Time'. Below this window, a terminal window is open, showing a list of system services and their status. The terminal output includes:

```
dnraid.static ifconfig lvchange modinfo pppoe-sniff st0isk vgrename
dmssetup ifdown lvconvert modprobe pppoe-start shutdown vgrename
dosfstck ifenslave lvcreate mount.fuse pppoe-status stattach vgs
dosfslabel ifrename lvdisplay lvxstend pppoe-stop sln vgsan
dump ifup lvxstend mount.nfs4 ppp-watch start vgsplit
dumpe2fs init lvm mount.nfs pvchange start udw weak-modules
e2fsck initctl lvchange mount.nfs-3g pvck status status ypbind
e2image initlog lvmdiskscan mount.ntfs-fuse pvcreate status
```

The terminal prompt is `[liveuser@localhost ~]$`. The desktop taskbar at the bottom shows the system tray with the date and time as 'Mon Apr 26, 3:50 PM'.



Evolutionary changes in OA Systems

- Component evolution
- Component replacement
- Architecture evolution
- Component license evolution
- Change in desired rights or acceptable obligations

- Evolutionary changes reconfigure a system's software ecosystem!



Component replacement and architecture evolution

The screenshot displays a multi-window desktop environment with the following components:

- Top Left Window:** A Mozilla Firefox browser window showing the website for the **GAME CULTURE & TECHNOLOGY LAB**. The page includes a navigation menu, a search bar, and a "Mission" section.
- Top Right Window:** A Google Docs document titled "A Composed Open Architecture Software System at Run-Time". The document content is a screenshot of the same website shown in the top-left window.
- Bottom Left Window:** A Google Calendar window showing the date **Monday, Apr 26, 2010**. The calendar grid shows events for the day, including a "Preposal review meeting" at 1:30 PM and "Work on JS3 paper draft" at 9:30 AM.
- Bottom Right Window:** A terminal window with the prompt `liveuser@localhost:~#`. The terminal displays the output of the `ls` command, listing files and directories in the `~/selinux` directory. The output is as follows:

```
liveuser@localhost:~# ls
access  checkreqprot  compat_net  deny_unknown  initial_contexts  mls  policyvers  user
avc     class          context     disable        load               null  reject_unknown
booleans  commit_pending_bools  create      enforce        member            policy_capabilities  relabel
dmraid_static  ifconfig      lvchange    modinfo        pppoe-sniff       sfdisk  vgrename
dmssetup       ifdown        lvconvert   modprobe       pppoe-start       shutdown vgrname
dosfsck        ifenslave     lvcreate    mount_fuse     pppoe-status      slattach vgs
dosfslabel     ifrename      lvdisplay   mount_nfs      pppoe-stop        start   vgsconfig
dump           ifup          lvextend    mount_nfs4     ppp-watch         start   vgsplit
dumpe2fs       init          lvm         mount_nfs      pvchange           start_udev  weak-modules
e2fsck         initctl       lvchange    mount_nfs-3g   pvck               status    yppbind
e2image        initlog       lvmdiskscan  mount_nfs-fuse  pvcreate           stop
```



Software licenses, architectures, and analysis



Software license meta-model

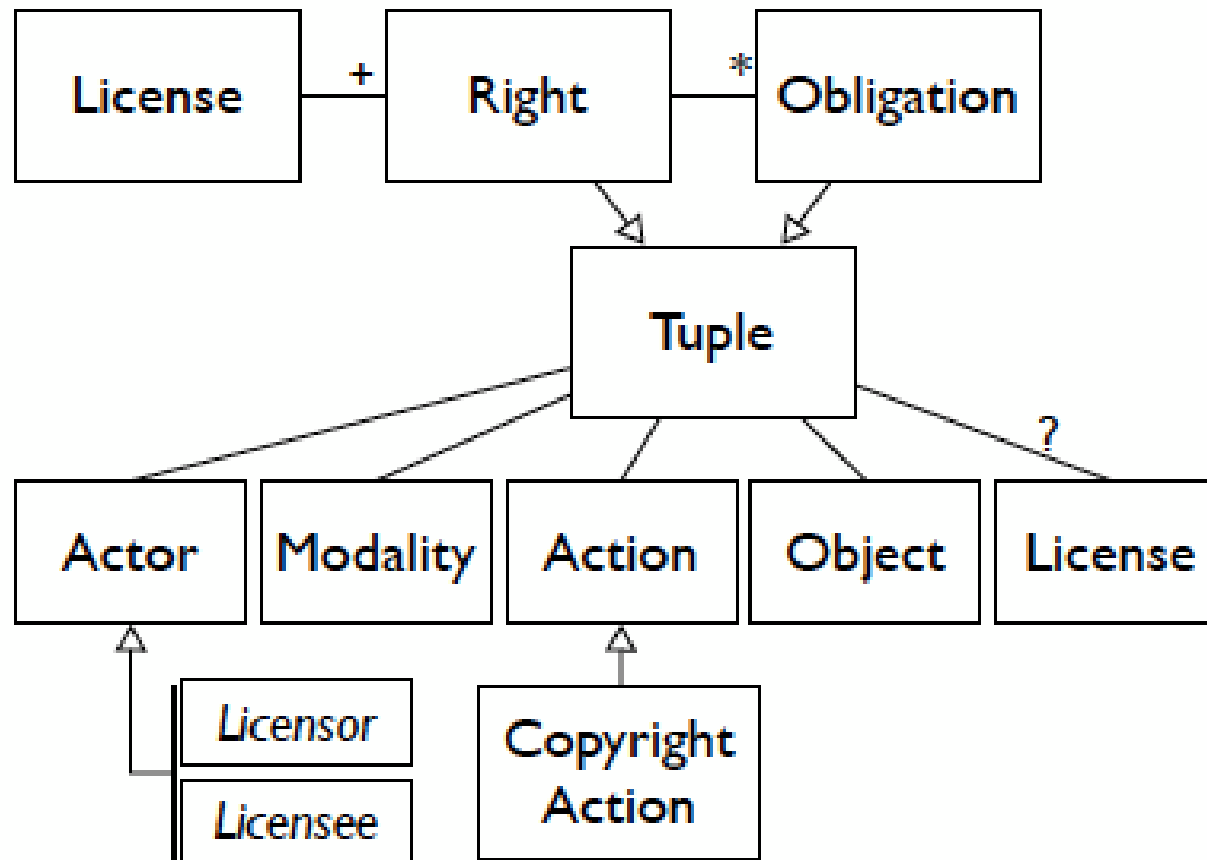

Logical modality and objects of software license rights and obligations

| | Modality | Object | License (optional) |
|---------------------|---------------------------------|---|--|
| Abstract Right | <i>May or Need Not</i> | <i>Any Under This License</i> | <i>This License or Object's License</i> |
| | | <i>Any Source Under This License</i> | |
| | | <i>Any Component Under This License</i> | |
| Concrete Right | | Concrete Object | Concrete License |
| Concrete Obligation | | | |
| Abstract Obligation | <i>Must or Must Not</i> | <i>Right's Object</i> | <i>Concrete License or Right's License</i> |
| | | <i>All Sources Of Right's Object</i> | |
| | | <i>X Scope Sources</i> | |
| | | <i>X Scope Components</i> | |



The software license architecture meta-model

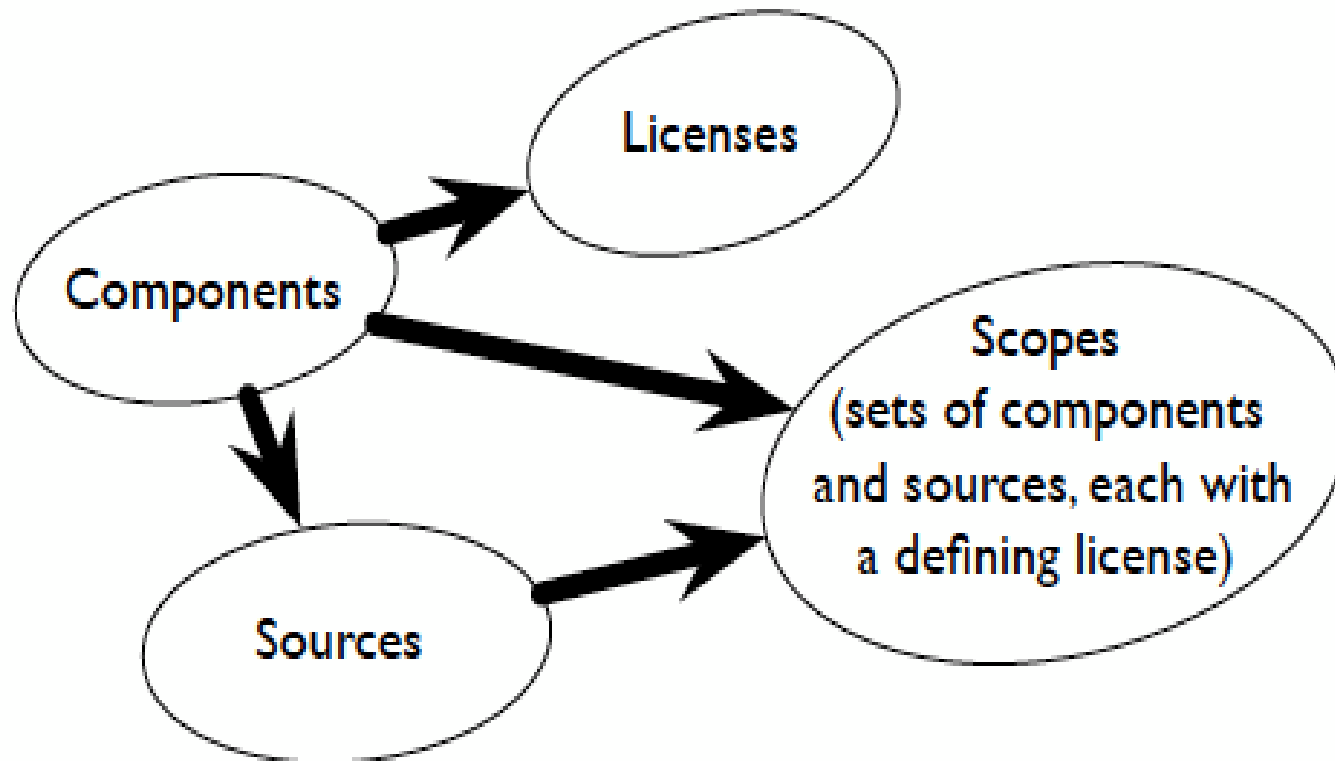

Software license analysis

- License types:
 - Strongly reciprocal (GPL), weakly reciprocal (LGPL), academic (BSD), Terms of Service, Proprietary
- Propagation of reciprocal obligations
- Conflicting obligations
- Calculating obligations and rights



Component license annotation prior to analysis

The screenshot shows the ArchEdit interface. On the left is a tree view of a project structure:

- XArch
 - ArchAnalysis
 - ArchStructure [main]
 - Component [Apache HTTP]
 - Component [Firefox]
 - Component [Gnome Evolution]
 - Description
 - Interface [EvolToCShell]
 - Interface [EvolToIMAPPOPSMTP]
 - Interface [EvolToUnix]
 - License
 - Licname
 - Component [RH/Fedora Linux (OS)]

On the right, the 'ArchEdit' window displays a table titled 'Licname: Description'.

| Name | Value |
|-------|-------|
| value | GPL 2 |
| | |
| | |
| | |
| | |
| | |
| | |
| | |
| | |
| | |



License review during license analysis

The screenshot displays the ArchStudio 4 interface. The main window shows a dependency graph with nodes for Firefox, WordProcessor, and GnomeEvolution, all connected to a central Cshell scripts node. Below this, three Unix System nodes are shown. The right-hand side of the ArchStudio window features a 'View License Information' panel with fields for License (GPL 2), Code (WordProcessor), 1st Rev # (9500), 1st License (CTL), and Latest Rev # (9504). Below this panel are sections for 'Inference Tree' and 'Options', including buttons for 'License Analysis' and 'License Preferences'. In the foreground, a Mozilla Firefox browser window is open, displaying the 'GNU General Public License Version 2, June 1991' page. The browser's address bar shows the URL 'http://www.cs.georgetown.edu/~walspaugh/pub/osl-sps/gpl2.0.html'. The page content includes a table of contents on the left, a 'Source: OSI text (2009Jul07)' link, and the beginning of the license text, including the preamble and the first section on copyright.



Results from license analyses with system component replacement

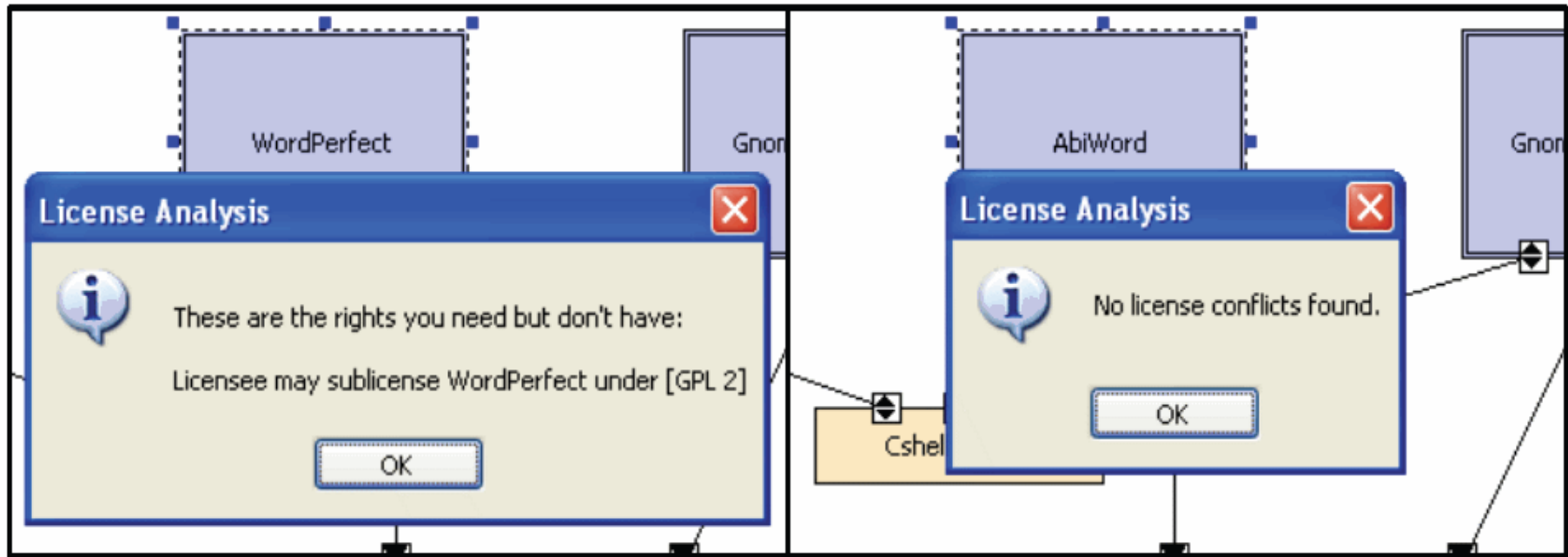

Discussion



Software product lines (SPLs) and OA systems

- An SPL may or may not be an OA system
- If SPL subject to single vendor/proprietary license, then lock-in is possible
- If OA system has design-time reference architecture and instantiated build-time architecture, then OA conforms to an SPL
- If SPL is based on OA with heterogeneously licensed components, then OA conforms to a *virtual SPL*, and works with our approach.



Specifying and analyzing system security requirements as “licenses”

- Security capabilities can correspond to “rights and obligations” in licenses
- Should be possible to specify and analyze system *security architecture* that conform to a *security meta-model*, much like we do for software licenses
- Should be possible to develop computational tools and development environments that can analyze security at design-time, build-time, and run-time, as well as when the system evolves



Conclusions

- Software component licenses and heterogeneously licensed systems becoming more widespread as we move to OA software ecosystems
- Our approach and tools demonstrate the ability to specify, model, and analyze such systems as they evolve, and are subject to diverse licenses
- Our approach is compatible with SPLs and can be extended to support system security licenses



Acknowledgements

This presentation was developed under work supported by the Naval Postgraduate School Acquisition Research Program Assistance Agreement No. #N00244-10-1-0038 awarded by the U.S. Fleet Industrial Supply Center, San Diego (FISC-SD). It has not been formally reviewed by NPS. The views and conclusions contained in this document are those of the authors and should not be interpreted as necessarily representing the official policies, either expressed or implied, of the U.S. FISC-SD and NPS. The FISC-SD and NPS do not endorse any products or commercial services mentioned in this publication.

Funding also from grant #0808783 from the National Science Foundation. No review, approval, or endorsement implied.

