Report on

**Progress Toward Security and
Stability in Afghanistan**

November 2010

Report to Congress
In accordance with section 1230 of the
National Defense Authorization Act for Fiscal Year 2008
(Public Law 110-181), as amended

Report Documentation Page

Form Approved
OMB No. 0704-0188

Public reporting burden for the collection of information is estimated to average 1 hour per response, including the time for reviewing instructions, searching existing data sources, gathering and maintaining the data needed, and completing and reviewing the collection of information. Send comments regarding this burden estimate or any other aspect of this collection of information, including suggestions for reducing this burden, to Washington Headquarters Services, Directorate for Information Operations and Reports, 1215 Jefferson Davis Highway, Suite 1204, Arlington VA 22202-4302. Respondents should be aware that notwithstanding any other provision of law, no person shall be subject to a penalty for failing to comply with a collection of information if it does not display a currently valid OMB control number.

1. REPORT DATE NOV 2010		2. REPORT TYPE		3. DATES COVERED 00-00-2010 to 00-00-2010	
4. TITLE AND SUBTITLE Report on Progress Toward Security and Stability in Afghanistan				5a. CONTRACT NUMBER	
				5b. GRANT NUMBER	
				5c. PROGRAM ELEMENT NUMBER	
6. AUTHOR(S)				5d. PROJECT NUMBER	
				5e. TASK NUMBER	
				5f. WORK UNIT NUMBER	
7. PERFORMING ORGANIZATION NAME(S) AND ADDRESS(ES) Department of Defense, 529 14th St, Washington, DC, 20004				8. PERFORMING ORGANIZATION REPORT NUMBER	
9. SPONSORING/MONITORING AGENCY NAME(S) AND ADDRESS(ES)				10. SPONSOR/MONITOR'S ACRONYM(S)	
				11. SPONSOR/MONITOR'S REPORT NUMBER(S)	
12. DISTRIBUTION/AVAILABILITY STATEMENT Approved for public release; distribution unlimited					
13. SUPPLEMENTARY NOTES					
14. ABSTRACT					
15. SUBJECT TERMS					
16. SECURITY CLASSIFICATION OF:			17. LIMITATION OF ABSTRACT	18. NUMBER OF PAGES	19a. NAME OF RESPONSIBLE PERSON
a. REPORT unclassified	b. ABSTRACT unclassified	c. THIS PAGE unclassified			

(INTENTIONALLY BLANK)

Table of Contents

Executive Summary	7
Section 1 – Strategy	11
1.1: U.S. Strategy	11
1.2: NATO Strategy, ISAF Campaign Strategy, and Strategic Objectives	11
1.2.1: ISAF Command and Control (C2).....	12
1.3: NATO ISAF Forces	14
1.3.1: Current U.S. and International Force Levels	14
1.3.2: Caveats.....	15
1.3.3: Civilian Organizational Structure	15
Section 2 – Afghan National Security Forces (ANSF).....	17
2.1: ANSF Strategy – Balancing Short and Long Term Goals.....	17
2.2: ANSF Budget.....	18
2.2.1: Afghan Security Forces Fund (ASFF).....	18
2.2.2: Direct Fund to MoD/MoI.....	19
2.2.3: International Community Funding for the ANSF.....	19
2.4: International Donations.....	19
2.5: Institutional Trainer and Mentor Status	20
2.6: ANSF Assessment	21
2.7: Ministry of Defense (MoD)	22
2.7.1: Assessment of MoD.....	22
2.7.2: Ministry of Defense Advisory (MoDA) Program.....	24
2.8: Afghan National Army (ANA) Institutional Capacity and Growth	24
2.8.1: ANA Manning – Meeting End-Strength Goals	25
2.8.2: ANA Leadership	26
2.8.3: ANA Training	27
2.8.4: ANA Equipping	29
2.8.5: ANA Logistics Capabilities	30
2.8.6: ANA Assessment.....	30
2.9: Afghan Air Force (AAF)	31
2.9.1: Transition from Afghan National Army Air Corps to Afghan Air Force.....	31
2.9.2: Long-Term Strategy.....	32

2.9.3: Building ANSF Capability.....	32
2.9.4: Aircraft Build.....	32
2.9.5: Airmen Build	33
2.10: Ministry of Interior (MoI).....	34
2.10.1: Institutional Capacity.....	34
2.10.2: Assessment of MoI	35
2.10.3: International Police Coordination Board (IPCB).....	36
2.10.4: MoI International Coordination Cell	36
2.11: Afghan National Police (ANP) Institutional Capacity and Growth	36
2.11.1: ANP Manning.....	36
2.11.2: ANP Equipping.....	39
2.11.3: ANP Logistics Capabilities.....	40
2.11.4: Women’s Police Initiatives.....	40
2.11.5: Overall Assessment of the ANP	41
Section 3 – Security	41
3.1: State of the Insurgency	41
3.2: ISAF Concept of Military Operations	44
3.3: Operations.....	45
3.3.1: Regional Command – East (RC-E).....	45
3.3.2: Regional Command – South (RC-S)	46
3.3.3: Regional Command – Southwest (RC-SW)	47
3.3.4: Regional Command – West (RC-W).....	48
3.3.5: Regional Command – North (RC-N).....	49
3.3.6: Regional Command – Capital (RC-C).....	50
3.4: Afghanistan – Pakistan Regional Cooperation	50
3.5: Population Security.....	51
3.6: Violence and Kinetic Events.....	53
3.6.1: Improvised Explosive Device (IED) Events.....	54
3.7: Civilian Casualties (CIVCAS)	55
Section 4 – Governance	57
4.1: Sub-National Governance Policy.....	57
4.2: Assessment of Governance.....	58
4.3: Rule of Law and Justice Reform.....	59
4.3.1: Land Reform	60

4.3.2: Combined Joint Interagency Task Force (CJIATF)-435	61
4.3.3: Anti-Corruption Efforts	62
4.4: Government Reform	64
4.4.1: Civil Service Reform	64
4.4.2: Elections	65
4.5: Reconciliation and Reintegration.....	66
4.6: Village Stability Operations.....	67
4.6.1: Afghan Local Police	68
Section 5 – Reconstruction and Development	69
5.1: United Nations Assistance Mission in Afghanistan (UNAMA).....	70
5.2: Provincial Reconstruction Teams (PRTs).....	71
5.2.1: RC-East.....	71
5.2.2: RC-South	71
5.2.3: RC-Southwest	71
5.2.4: RC-West.....	72
5.2.5: RC-North	72
5.3: Afghanistan Reconstruction Trust Fund (ARTF)	72
5.4: Economic Development.....	73
5.4.1: Government Revenue and Expenditure	73
5.4.2: Border Control	73
5.4.3: Local Procurement.....	75
5.4.4: Agriculture	75
5.5: Infrastructure and Essential Services	77
5.5.1: Energy	77
5.5.2: Mining.....	80
5.5.3: Telecommunications.....	80
5.5.4: Civil Society & Media	81
5.5.5: Health.....	81
5.5.6: Education	81
5.5.7: Women’s Issues	82
Section 6 – Counternarcotics (CN).....	83
6.1: Strategy and Priorities.....	83
6.2: Progress to Date on CN Activities	83
6.3: Efforts to Improve Afghan Capacity	85

6.4: Afghan Threat Finance Cell.....	87
6.5: International Coordination.....	88
Section 7 – Regional Engagement	88
7.1: Pakistan.....	88
7.2: India	89
7.3: Central Asian States	89
7.4: Iran.....	89
7.5: China.....	90
7.6: Russia.....	90
7.7: Gulf Cooperation Council States (GCC)	91
Annex A – Acronyms	92
Annex B – FY 2008 NDAA Section 1230, with FY 2010 NDAA Section 1236.....	97

Executive Summary

This report to Congress is submitted consistent with section 1230 of the National Defense Authorization Act for Fiscal Year 2008 (Public Law 110-181), as amended by the National Defense Authorization Act for Fiscal Year 2010 (Public Law 111-84). It includes a description of the comprehensive strategy of the United States for security and stability in Afghanistan. This report is the fourth in a series of reports required every 180 days through fiscal year 2010 and has been prepared in coordination with the Secretary of State, the Director of National Intelligence, the Attorney General, the Administrator of the Drug Enforcement Administration, the Administrator of the United States Agency for International Development, and the Secretary of Agriculture. This assessment complements other reports and information about Afghanistan provided to the Congress; however, it is not intended as a single source of all information about the combined efforts or the future strategy of the United States, its Coalition Partners, or Afghanistan. The information contained in this report is current as of September 30, 2010.

NOTE: This is a historical document that covers progress made in Afghanistan from April 1, 2010 to September 30, 2010. The next report will include an analysis of progress toward security and stability from October 1, 2010 to March 31, 2011.

Progress across the country remains uneven, with modest gains in security, governance, and development in operational priority areas. The deliberate application of our strategy is beginning to have cumulative effects and security is slowly beginning to expand. Although significant challenges exist, some signs of progress are evident. Areas of security in Kabul and the surrounding districts have allowed for improvements in development and governance. Progress is also visible in areas where Coalition forces have been on the ground for more than six months, such as Central Helmand Province. Socio-economic development throughout the country is slowly improving, as the Afghan Government shows initial signs of improving essential service delivery, although it is limited still by the security environment in some areas. Agricultural development and productivity has also improved. Overall governance and development progress continues to lag security gains. Governance capacity and economic development are long-term efforts that will require sustained support from the international community.

Key strategic events during this period included the U.S.-Afghanistan Strategic Dialogue in May, the National Consultative Peace Jirga in June, the Kabul Conference in July, and the Afghan Parliamentary elections in September. This period also saw the arrival of U.S. uplift forces in theater, along with more than three-fourths of the pledged North Atlantic Treaty Organization (NATO) uplift forces and remarkable growth of Afghan National Security Forces (ANSF) by about one third since November 2009. This period included several important political developments including President Hamid Karzai's approval of the Peace and Reintegration Program (APRP), a Presidential decree establishing the Afghan Local Police (ALP), the signing of the Afghanistan-Pakistan Transit Trade Agreement, and the establishment of the Joint Afghan-NATO *Inteqal* ("transition") Board (JANIB).

The increase in violence during this period was concurrent with the arrival of Coalition personnel, the dramatically accelerated pace of operations, and the spike of violence often seen on election day. The International Security Assistance Force (ISAF) is seeing some early indications that comprehensive counterinsurgency operations are having localized positive effects and are producing initial signs of progress. Indications of local resistance to insurgents continue to emerge alongside positive indications, such as newly opened schools and police stations.

ISAF and ANSF forces gradually are pushing insurgents to the edges of secured population areas, in a number of important locations. The Afghan Government and ISAF continue to face a resilient enemy that exploits governance gaps and continues to fight to retain long-standing sanctuaries where the insurgency historically has had strong roots. Yet, the insurgent-generated violence remains largely localized and does not threaten all of Afghanistan: 45 percent of all violence and two-thirds of all improvised explosive device (IED) activity take place in the south.¹

After taking command as Commander ISAF (COMISAF) and Commander U.S. Forces-Afghanistan (COMUSFOR-A) on July 4, 2010, General Petraeus issued a revised Tactical Directive. This directive provides guidance and intent for the employment of force. In addition, General Petraeus issued refined counterinsurgency (COIN) guidance to reinforce the principles of conducting COIN operations in Afghanistan, and new COIN contracting guidance to reinforce that contracting is “commanders’ business” and that commanders must understand the effects of contract spending.

The ISAF operational main effort is focused on protecting the most threatened population in the heart of the Taliban-led insurgency in Helmand and Kandahar Provinces. The split of Regional Command-South (RC-S) and Regional Command-Southwest (RC-SW) on June 14, 2010 has allowed for more effective and streamlined command and control and improved ANSF partnering in both provinces. Comprehensive civil-military efforts in RC-S and RC-SW are making slow but steady progress. Initial signs of this progress are evident especially in Central Helmand, where ISAF and ANSF have been conducting counterinsurgency operations for over a year. Despite the enemy’s continued efforts to counter coalition and ANSF actions to expand security in the south, slow and incremental gains are being achieved. Six months ago, Marjah was an insurgent command-and-control center, a base for IED assembling, and a nexus for illegal narcotics industry activities. Now the city is controlled by the Afghan Government. Signs of progress in Marjah include voter registration, increased activity in local marketplaces, and the reopening of schools that were closed for several years.

Combined ISAF and ANSF Forces in Regional Command-Capital (RC-C) continued to sustain a relatively secure environment for the people of Kabul and the surrounding districts, where approximately one-sixth of all Afghans live. Combined Afghan security forces in Kabul performed notably well in the planning and the execution of security for the Peace Jirga and the Kabul Conference, as well as during Parliamentary elections. Indeed, the transition of key security functions and responsibilities already occurring in RC-C is similar to that which is

¹ Notably, nearly 90 percent of all IED activity countrywide takes place in the south, southwest, and east, leaving the north and west with relatively low levels of violence.

envisioned to occur across the country in the coming years. In the coming months, ISAF will focus on expanding security from Kabul into surrounding provinces, particularly in Regional Command-East (RC-E).

ISAF operations in RC-E have continued to apply pressure and disrupt the leadership of the Haqqani and Taliban Networks. Combined forces in RC-E are securing critical lines of communication and infrastructure that supports the commerce to and from Pakistan. Efforts in RC-E will further increase the pressure on some of Afghanistan's most lethal enemy networks, expand population security from Kabul to key population centers in Wardak and Logar, neutralize the Haqqani Network's footholds and disrupt its access to Kabul, and secure the main economic border crossing point at Torkham.

Despite recent high-profile events, the insurgency has failed to gain significant footholds in Regional Command-North (RC-N) and Regional Command-West (RC-W). ISAF and ANSF efforts have benefitted from expanded partnering and remain focused on improving security in key terrain districts and ensuring gradually improving freedom of movement along Highway 1.

The ANSF has, at times, been considered one of the greatest risk areas of the ISAF strategy. As of the end of this reporting period, ANSF growth and development are among Afghanistan's most promising areas of progress, though numerous challenges persist. In July 2010, the Afghan National Army (ANA) and the Afghan National Police (ANP) both met their growth goal of 134,000 and 109,000 personnel, respectively, three months before the target date of October 31. The ANA end strength for July was 134,028 personnel, and the ANP end strength was 115,525 personnel. If the ANA and ANP continue to grow at a similar pace, which will be challenging, they will also meet their October 2011 goals of 171,600 and 134,000 personnel, respectively. Although the growth during this reporting period is significant, improving the quality of the force remains a serious challenge, in particular in the area of leadership development. Also, given the expanded requirements described in the Combined Joint Statement of Requirements version 10 (CJSOR v.10), released on September 1, NATO Training Mission-Afghanistan (NTM-A) will face a shortfall of ANSF trainers and mentors that will grow more acute through the fall and into next year, if troop contributions do not meet the growing need for training. If not adequately addressed, this shortfall poses significant strategic risk and threatens to delay the upcoming transition process.

Leader shortfalls in the officer and non-commissioned officer (NCO) Corps of the ANA will remain as the force grows, and low literacy rates and lack of technical expertise present challenges to force development. Mandatory literacy training and the establishment of branch specialty schools will begin to alleviate some of this challenge, and aggressive partnering is starting to address development deficits. Significant shortfalls in specialist instructor pledges, if persistent past this year's force generation process, will delay transition of institutional capacity. The ANP reached its 2010 growth objective of 109,000 three months early, but the severe attrition rate in Afghan National Civil Order Policy (ANCOP) puts the 2011 growth goal of 134,000 at risk as 90 percent of programmed growth this coming year is in the ANCOP.

In August, President Karzai authorized the establishment of the Afghan Local Police (ALP) program. ALP is a temporary, village-focused program that complements counterinsurgency

efforts by targeting select areas with limited or no ANSF presence to shape security conditions and allow for improved governance and development. In September, the Afghan Government approved ALP at 68 sites and established the first eight ALP sites. We anticipate the establishment of most of the remaining ALP sites by the end of 2010.

As President Karzai has forthrightly recognized, corruption continues to fuel the insurgency in various areas. ISAF, in coordination with the international community and the Afghan Government, established the Combined Joint Interagency Task Force (CJIATF)-*Shafafiyat* (“Transparency”) to develop a common understanding of corruption, to support Afghan-led anti-corruption efforts, and to integrate ISAF anti-corruption activities with those of key partners. CJIATF-*Shafafiyat* achieved initial operational capability in late August, with full operational capability expected in October 2010.

Embassy-Kabul, U.S. Agency for International Development (USAID), and ISAF, together with the United Nations Mission in Afghanistan (UNAMA) and non-governmental organizations (NGOs), continue to work with the Afghan Government to help improve governance and accelerate development. The Karzai Administration has improved its stance against corruption by prosecuting several high-profile senior officials. However, progress remains uneven and incremental. The Afghan Government also has improved inter-ministerial coordination, but faces several challenges and has yet to establish unified control over border control and customs – one of the primary sources of government revenue. The Kabul Bank episode continues to foster uncertainty in the financial sector and poses potential threats to investment and economic growth.

Section 1 – Strategy

1.1: U.S. Strategy

As described in the last report, on December 1, 2009, President Obama addressed the U.S. public on the way forward in Afghanistan and Pakistan. The President reiterated the U.S. Government’s goal of disrupting, dismantling, and defeating al Qaeda in Afghanistan and Pakistan by pursuing the following objectives within Afghanistan:

- Deny al Qaeda a safe haven;
- Reverse the Taliban’s momentum and deny it the ability to overthrow the Afghan Government; and
- Strengthen the capacity of Afghanistan’s security forces and the Afghan Government so that they can take lead responsibility for Afghanistan’s future.

The three core elements of the strategy to achieve these objectives are:

- A military effort to improve security and create the conditions for a transition;
- A civilian surge that reinforces positive action; and
- An effective partnership with Pakistan.

1.2: NATO Strategy, ISAF Campaign Strategy, and Strategic Objectives

The NATO strategy is based on the NATO Comprehensive Strategic and Political-Military Plan (CSPMP) and its supporting SHAPE OPLAN 10302 (Revision 1), and is implemented through the International Security Assistance Force (ISAF) Operations Plan (OPLAN) 38302.² The mission from the current OPLAN states:

“ISAF, in partnership with the Afghan Government and the international community, conducts comprehensive, population-centric counterinsurgency operations, and supports development of legitimate governance, Afghan National Security Forces, and socio-economic institutions in order to neutralize the enemy, safeguard the people, enable establishment of acceptable governance, and provide a secure and stable environment.”³

The ISAF Campaign strategy focuses on three main efforts:⁴

- Gain the initiative by protecting the population in densely populated areas where the insurgency has had significant influence;
- Separate insurgency influence from the populace and support Afghan Government sub-national structures to establish rule of law and deliver basic services; and
- Implement population security measures that connect contiguous economic corridors, foster community development and generate employment opportunities.

² ISAF OPLAN 38302, Revision 4, dated September 25, 2009 is the current plan. Revision 5 is currently in staffing and is scheduled to be approved in October 2010. The ISAF OPLAN implements the NATO CSPMP and the Joint Forces Command Brunssum (JFCB) OPLAN 3032, Revision 5 with Amendment 1 (Transition).

³ COMISAF-approved mission statement from the ISAF OPLAN 38302, Revision 5 (not yet released).

⁴ These efforts are occurring simultaneously across Afghanistan. ISAF OPLAN 38302, Rev. 4.

The concept of operations is to conduct decisive “shape-clear-hold-build” operations concentrated on the most threatened populations to neutralize insurgent groups and to establish population security measures that diminish insurgent influence over the people. Operational cohesion is a principal tenet of the campaign design and is gained by building relationships with Afghans and partnering at all levels within the ANSF with a focus on achieving local solutions. Operational actions are coordinated with the international community to enhance unity of effort and magnify effects. Missions are conducted in a manner that focuses priority on protecting the population and reducing civilian casualties.

(The OPLAN is currently under review and the revision will include phase four of operations to address the process of transition.)

On September 27, 2010, the Joint Afghan-NATO *Inteqal* (“transition”) Board (JANIB) met for the first time to discuss transition.⁵ The timescales proposed for the first output from the JANIB are ambitious but with the combined commitment and energy of ISAF and the Afghan Government, analysis of the prospects for transition in various areas should be produced by the first half of 2011.

1.2.1: ISAF Command and Control (C2)⁶

The previous report detailed several changes to the ISAF and USFOR-A Command and Control (C2) structures, including the creation of: the ISAF Joint Command (IJC) as the operational level headquarters; the NATO Training Mission-Afghanistan (NTM-A) to manage ANSF generation and institutional capacity; the Combined Joint Interagency Task Force-435 (CJIATF-435) to manage detention operations and rule of law; and a new, sixth regional command, Regional Command-Southwest (RC-SW), to address the excessive span of command and the operational tempo in Regional Command-South (RC-S). Figure 1 illustrates the current command and control structure.

⁵ The JANIB is composed of Afghan ministries and the international community and is responsible for developing the criteria, metrics, and benchmarks to assess a province's readiness to begin transition.

⁶ The roles and missions of the respective HQs are summarized in the attached annex.

Figure 1: ISAF Organizational Structure

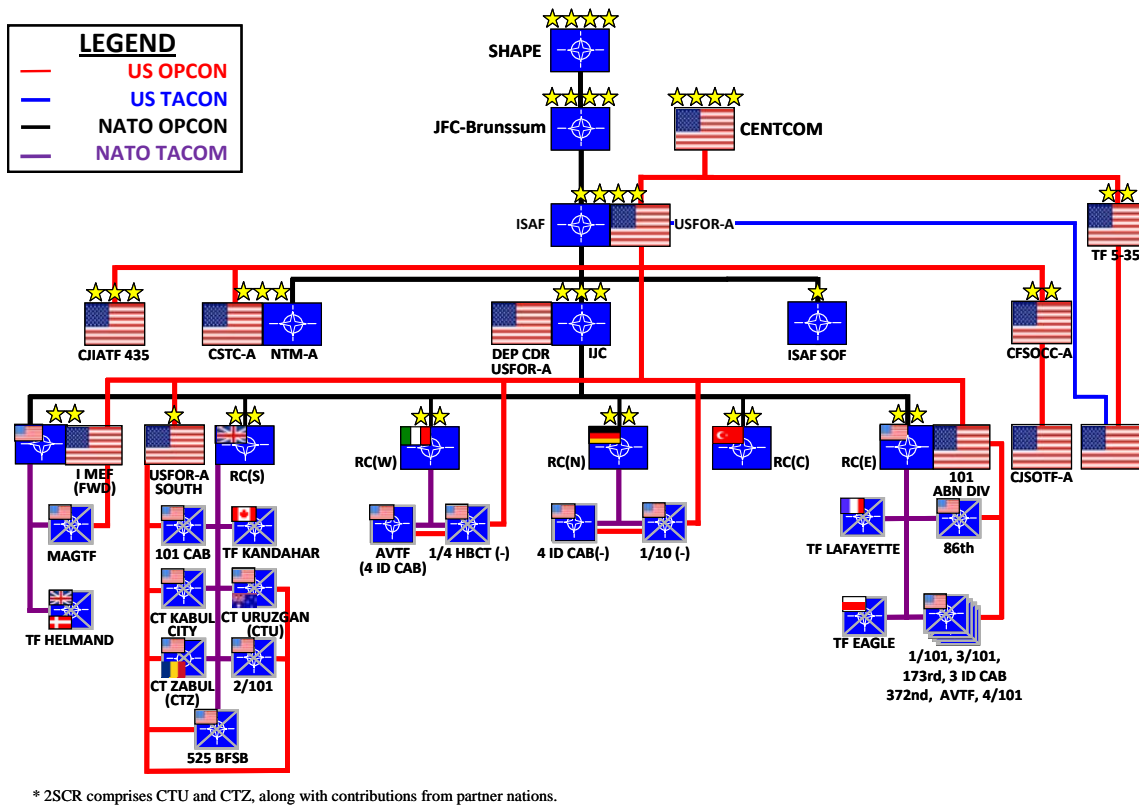

The above organizations are beginning to reach maturity and are contributing to greater unity of command and control within ISAF. During this reporting period an additional C2 change occurred – the creation of CJATF-Shafafiyat (“transparency”) to foster a common understanding of the corruption problem in Afghanistan and to plan and implement ISAF anti-corruption efforts. In particular, CJATF-Shafafiyat will oversee two additional task forces, Task Force-Spotlight and Task Force-2010, which examine the impact of U.S. contracting in Afghanistan.

Finally, President Obama’s acceptance of General McChrystal’s resignation in late June and subsequent appointment of General Petraeus as COMISAF/COMUSFOR-A marked another change in C2. As the newly appointed COMISAF, General Petraeus reiterated the need to protect the population and reviewed and revised several directives, including the Tactical Directive, to ensure that they were in line with ISAF objectives and that they provide a balance of adequate protection and flexibility to the forces on the ground.

Tactical Directive

On August 19 COMISAF issued *COMISAF Tactical Directive, Revision 1*. The directive provides guidance and intent for the employment of force, specifically fire control measures where civilians may be present. The revision clarifies that subordinate commanders are not authorized to restrict this guidance further without approval and that nothing in the guidance is intended to hinder an individual’s right of self-defense. Overall, the directive seeks to minimize incidents of civilian casualties (CIVCAS) while maintaining force protection.

Counterinsurgency (COIN) Contracting Guidance

In early September 2010 COMISAF issued COIN Contracting Guidance to ensure that money – a key tool in the COIN campaign – is used to empower the Afghan people, not malign or corrupt organizations. The guidance will connect contracting actions, particularly U.S. contracting actions, to President Karzai’s stated desire to ensure that actions are not a “source of corruption” and do not inappropriately benefit “high government officials or their relatives.” Initial implementation of this guidance includes the following actions: developing a contracts common operating picture and a contractors database; vetting vendors and incorporating contractor clauses into contracts and agreements; forming COIN contracting management boards; contracting with more small- and medium-sized Afghan businesses; ensuring contracting agencies have enough contracting officers; and establishing a COIN contracting executive steering committee.

1.3: NATO ISAF Forces

1.3.1: Current U.S. and International Force Levels

On September 30, there were approximately 96,695 U.S. Forces and approximately 48,842 international forces in Afghanistan.⁷ The U.S. 30,000 personnel force increase was comprised of three separate force packages, each built to provide specific capabilities essential to achieving the main goals of the campaign plan, particularly in RC-South and RC-East. The majority of the initial force package (FP-1) was comprised of U.S. Marine Corps (USMC) elements, which were immediately deployed in central Helmand combat operations. Additionally, FP-1 included an Army brigade to conduct training and mentoring for ANSF forces. Force Package 2 (FP-2) delivered an Army brigade to conduct operations in Kandahar Province. FP-2 also offered military intelligence assets and a rotary-wing aviation brigade. Force Package 3 (FP-3) delivered the final Army brigade to RC-East, to conduct operations in Paktika Province. Follow-on forces will continue to execute the strategy of shape-clear-hold-build, and transfer as operations continue in Kandahar. With the arrival of the 10th Mountain Division in late October/early November in RC-South, the U.S. force increase will be complete.

International force levels and pledged contributions continued to grow over the last six months to a total of 48,842.⁸ NATO accepted force pledges from 40 countries in a range of capabilities including operations, tactics, and training. ISAF received pledges of 9,700 additional personnel from NATO and non-NATO partners since the President’s December 2009 speech. As of September 2010, approximately 77 percent of these additional personnel have arrived.

⁷ Total U.S. Forces as of September 30 incorporates all forces on the ground. The Congressional Boots on the Ground (BOG) report stated that there were approximately 96,695 U.S. Forces in Afghanistan. This number is the force management level (FML) number, utilizing the Secretary of Defense Business Rule for Managing Afghanistan Forces, which does not include the overlap of transitioning forces, short-duration temporary duty personnel, U.S. Forces assigned to DoD combat support agencies, and other forces not operationally assigned and thus unavailable to the commanding general.

⁸ Total international forces include Coalition ISAF contributions and Coalition OEF contributions.

NATO Allies and partners have used several NATO ministerial meetings and international conferences as platforms to promote greater international engagement and participation in Afghanistan. The increase in international forces is a direct result of pledges made at the December 2009 NATO Foreign Ministerial and February 2010 NATO Force Generation Conference. Subsequently, on September 22 NATO held a Force Generation Conference to fill theater requirements identified by the Combined Joint Statement of Requirements (CJSOR) version 10.0 revised and released September 1, 2010. The total shortfall as of September 30, including version 9.5 not filled and version 10.0 additional requirements, is approximately 8,900 forces.⁹

The requirement for forces identified in the CJSOR is challenged by the drawdown of forces by two RC-South Allies, the Netherlands and Canada. The Dutch Government withdrew the bulk of its forces from Afghanistan when its military mandate ended August 1, 2010, at which time the Dutch Government transferred lead-nation status in Uruzgan. The Canadians, facing similar parliamentary pressure, plan to begin redeploying forces in 2011. The U.S. Government and ISAF will encourage Allies and partners to reinvest combat force reductions in non-combat missions.

1.3.2: Caveats¹⁰

SHAPE released its bi-annual *Caveat Report* on April 21, reporting an increase in overall caveats from 57 to 58. In total, 20 of the 47 nations in ISAF operate without caveats. The slight increase in overall caveats is attributable to the addition of two nations to the mission in Afghanistan. Of the 27 troop-contributing nations with caveats, 20 nations limit operations outside of originally assigned locations (usually the province where they are based), conducting counternarcotics (CN) operations with ISAF (predominantly imposed by Allies in RC-South), and Rules of Engagement caveats (the majority being held by non-NATO nations). Nearly 40 percent of the caveats are geographically-based, representing a significant challenge for COMISAF as they limit his agility.

Senior U.S. leadership, including Secretary of State Clinton and Secretary of Defense Gates, consistently emphasize the need for a reduction of caveats to allow for the greatest operational effect. The effect of geographical caveats on transition may present further challenges, as thinned-out ISAF Forces may be more difficult to redeploy in unstable, insecure areas where handoff of security responsibilities to ANSF may require ad-hoc ISAF engagement.

1.3.3: Civilian Organizational Structure

Since January 2009, the Department of State (DoS) more than tripled the number of civilians on the ground in Afghanistan to more than 1,100. These civilians include some of the top experts from eight different U.S. Government departments and agencies, including DoS, USAID, U.S. Department of Agriculture (USDA), Department of Homeland Security (DHS), Department of

⁹ The enduring shortfall is 6,900 (a combination of trainers, partners, mentors, and security forces) and the new growth is 2,040 (primarily enablers).

¹⁰ National caveats for ISAF Forces ensure that Coalition partners and international troops operate in a manner consistent with their national laws and policies. All ISAF Coalition partners within Afghanistan operate according to the ISAF Rules of Engagement (ROE) unless further restricted by national caveats.

Justice (DoJ), FBI Legal Attaché (LEGATT), Drug Enforcement Administration (DEA), U.S. Marshals Service, Department of the Treasury, Department of Transportation (DoT), and Department of Health and Human Services (HHS). U.S. civilian experts contribute to the mission in the field, especially in the East and South, where a majority of U.S. combat forces are operating and many of the additional 30,000 forces announced by President Obama have deployed. Civilian personnel will remain deployed as the security situation improves and the lead for security responsibility is transferred to the Afghans.

NATO Senior Civilian Representative (SCR)

Ambassador Mark Sedwill is NATO's senior civilian representative for the ISAF mission and is a counterpart to COMISAF. Reporting to the NATO Secretary-General, under the political guidance of the North Atlantic Council (NAC), Ambassador Sedwill has actively worked to coordinate the delivery of civil effects, e.g., political, governance, and economic effects, to the ISAF campaign in support of NATO's strategic objectives, with special attention to supporting the priorities of:

- Improving the protection of the Afghan people;
- Building ANSF capacity and facilitating their lead role in security;
- Facilitating governance and development; and
- Engaging with Afghanistan's neighbors, particularly Pakistan.

The SCR staff was expanded over the last few months to create directorates for Strategy, Political Affairs, Stability, Transition, and Communications. These are coordinated by a chief of staff and supported by a limited number of NATO civilian employees, subject matter experts, and other personnel from troop contributing nations (TCNs).

New initiatives by the SCR and his staff include: regularly scheduled meetings and briefings to Ambassadors from TCNs; active support of the UN's Special Representative of the Secretary-General for Afghanistan to develop guidelines for the 2010 Parliamentary elections; implementation of high-level strategic review boards to ensure that operational planning effectively supports NATO's political objectives; and formation of quarterly Regional Command Boards, co-chaired by the SCR, to coordinate effects and strengthen unity of effort of the SCR, ISAF, and troop-contributing nations in support of the ISAF campaign plan. Ambassador Sedwill and members of his staff now are integrated fully into Afghanistan's National Security Council deliberations process. This integration is broad and deep, and includes activities such as direct engagement with President Karzai, participation in ministerial-level Afghan Senior Security Shura and their Deputies' Committee, and collaboration with the interagency Security Operations Group.

The SCR made solid progress on the topic of transition with the drafting, negotiation, and approval of the Joint *Inteqal* (Transition) Framework and the Joint Afghan-NATO *Inteqal* Board Terms of Reference. The first joint SCR-COMISAF transition assessment was presented to the NAC on September 15.

The increase in civilian personnel reflects the President's strategy to increase civil-military cooperation at all levels of operations. The DoS organizational structure outside of Kabul parallels the military command and control structure, starting with regional SCRs, which are

counterparts to the military commander in RCs North, West, South, Southwest, and East. The regional SCRs foster civil-military integration through the civilians working under them at the Task Force, Provincial Reconstruction Team (PRT), and District Support Team (DST) levels. The regional SCRs in RC-North and RC-West will be dual-hatted as Consuls General of the projected U.S. consulates that will be established in Mazar-e Sharif and Herat, respectively.

Section 2 – Afghan National Security Forces (ANSF)

2.1: ANSF Strategy – Balancing Short and Long Term Goals

Among the most important lines of effort for the United States and ISAF is development of the ANSF to secure the Afghan population. Central to this effort is developing professional, enduring, and self-sustainable security forces. In December 2009, President Obama emphasized the importance of building the ANSF. This was followed by President Karzai, at the Kabul Conference in late July 2010, emphasizing the importance of the ANSF assuming the lead for security by 2014. Ultimately, the goal is to develop a self-reliant and professionally led ANSF with the ability to generate and sustain enduring capabilities through enablers.

The ANSF will develop and progress at different rates according to threat levels in their area of operation. The burden on the international community will be reduced as the insurgency is minimized and the capabilities of the ANSF increase. Afghanistan's revenue capability will increase as security increases and the Afghan people have the opportunity to expand development. ISAF currently projects that the ANSF will be able to take the lead for security in all provinces by 2014, albeit with some level of continued international support. This international support will involve taking an advisory role for institutions and units, while compensating for those elements of the ANSF still under development, such as the Afghan Air Force (AAF) and logistics systems.

The Joint Coordination and Monitoring Board (JCMB) of January 20, 2010 approved, the development of an infantry-centric, COIN-capable ANSF of 305,600 personnel.¹¹ Both the ANA and ANP increased their size through increased recruiting, reduced attrition, and improved retention. In July 2010, the ANA and the ANP both met their JCMB growth goal of 134,000 and 109,000 personnel, respectively, three months before the JCMB's October 31, 2010 deadline. The ANA end-strength for September was 138,164 and the ANP end strength was 115,525 personnel. If the ANSF continues to grow at a similar pace, it will also meet its October 2011 goal of 171,600 and 134,000 personnel. Although the growth accomplishments made during this reporting period are significant, the challenge of expanding the quality of the force remains, in particular in the area of developing leadership – the top priority moving forward. The emphasis on a near-term, COIN-capable ANSF created a heightened dependence on ISAF and exacerbated several challenges related to the development of leaders within the ANSF.

In the past year, ISAF has changed its approach to training and adopted a greater sense of urgency in Coalition and Afghan efforts to build the quality of the ANSF. Building a long-term

¹¹ Additional forces may be needed in the long-term, as demonstrated by several studies that were laid out in the August 2009 Commander, ISAF (COMISAF) assessment.

force is a process that requires continued effort by the United States, NATO, and international partners. Distinct challenges to quality development have been identified, such as illiteracy and high attrition rates, and plans to address them are being implemented. Illiteracy complicates the development of junior and mid-grade leaders as well as the development of enablers, such as logisticians. High attrition rates stem the overall growth of the force and slow the development of professional leaders. To mitigate these problems, ISAF has increased literacy training, and has worked with the Government of Afghanistan to raise pay and improve retention policies. Although ISAF is resourced to meet today's requirements, a lack of trainers and advisors and a decrease in funding would significantly diminish the probability of future success.

2.2: ANSF Budget

Although the Afghan Government continues to show commitment toward funding the ANSF, the increase in size and capabilities of the ANSF, in addition to the challenges of increasing government revenue, suggest that the Afghan Government will rely on significant international support for funding the ANSF in the near to mid-term. The Afghan Government included approximately 455 million U.S. dollars (USD) in its Solar Year (SY) 1389 budget, covering March 2010 to March 2011, for funding the Ministry of Defense (MoD) and Ministry of Interior (MoI). This is an increase of 140 million USD over the previous solar year, as mandated by the London Compact of 2006.

2.2.1: Afghan Security Forces Fund (ASFF)

The Afghan Security Forces Fund (ASFF) budget directly supports funding to grow, train, equip, and sustain the ANSF. In December 2009, Congress appropriated 6.6 billion USD for the ASFF. An additional 2.6 billion USD was appropriated in the Supplemental Appropriations Act of Fiscal Year (FY) 2010, signed July 29, 2010. The President requested 11.6 billion USD from Congress for ASFF for 2011, funds essential for future success.

These funds contributed to the building, training, equipping, and fielding of additional Corps Headquarters, Brigade Headquarters, Infantry Battalions, Special Operations Forces Battalions (including Commandos and Special Forces), Combat Support Battalions (including Reconnaissance, Artillery, and Engineering), Combat Services Support Battalions (logistics), Garrison Support Units (GSUs), Depots and Logistical Support Centers, Route Clearance Companies, Military Police, Military Intelligence, and small arms ranges. Investments are budgeted for military education centers including construction of the Afghan Defense University and seven Branch Schools (Human Resources & Finance, Intelligence, Legal, Medical, Military Health Professionals Institute, Combat Arms, and Religious & Cultural Affairs). The AAF will receive further expansion at five locations. In addition this funding will provide infrastructure for the fielding of an Afghan National Civil Order Police (ANCOP) brigade and three additional ANCOP kandaks (battalions), 40 Border Police (BP) companies and battalions, 24 Uniformed Police (UP) provincial and district headquarters, two MoI regional offices, a regional logistics center, the National Fire Training Academy, and an expansion of the MoI Headquarters.

2.2.2: Direct Fund to MoD/MoI

In a joint statement made on May 12, 2010, President Obama and President Karzai reaffirmed the need to further direct U.S. assistance through the Afghan Government. Pursuant to this effort, DoD is looking to develop a program to provide funding directly to the ministries. Such a program would allow the ministries to build capacity to meet the needs of the Afghan people and to prepare for eventual transition.

2.2.3: International Community Funding for the ANSF

The international community also provides funding for the ANSF. In early 2009, the North Atlantic Council (NAC) agreed to expand the NATO ANA Trust Fund beyond the limitations of ANA development to include funding for sustainment costs. Several nations have provided significant contributions to the Trust Fund, which now totals approximately 143 million USD (95 million €). Funding for police salaries, as well as other police development programs is supported by the United Nations Development Program, which oversees the Law and Order Trust Fund Afghanistan (LOTFA). From 2002-2010, the international community donated approximately 1.56 billion USD to LOTFA, of which the United States contributed 496 million USD. The United States will continue to work through diplomatic channels and international organizations to encourage Allies and partners to help sustain the ANSF, although the United States will likely continue to provide the major portion of funding for the ANSF in the near future.

2.4: International Donations

The Office of the NTM-A/CSTC-A Deputy Commanding General for International Security Cooperation (DCOM-ISC) evaluates all monetary, infrastructure, equipment, and munitions donations to the Afghan Government to ensure that each donation satisfies a valid ANA or ANP requirement and will be sustainable. The MoD and MoI subsequently evaluates and approves the donation. After NTM-A/CSTC-A and the Afghan Government make the official decision to accept an offer, transportation arrangements are made. Delivery includes receiving and accounting for all equipment, materials, and munitions at Depot 1, located in Kabul (the national depot for ANA weapons), Pol-e-Charki National ANP Ammunition/Weapons Depot, or any other Afghan depot.

Monetary donations for the ANA may be made through the original NATO Trust Fund or through the newly established (September 2009) Long-Term Sustainment component of the original NATO Trust Fund. The most prominent distinction between the two components is that the Long-Term Sustainment component works in conjunction with requirements from the Project Document. Funds may be deposited with the NATO Trust Fund and subsequently used through NATO contracting, the U.S. Army Corps of Engineers (USACE), the Air Force Center for Engineering and the Environment (AFCEE), the Afghanistan Engineer District (AED), or transferred to the U.S. Treasury. When deposited in the U.S. Treasury, NTM-A/CSTC-A may use the donated funds to purchase infrastructure, equipment, training, and sustainment items.

Nations sometimes approach the Afghan Government directly and negotiate a bilateral donation. Bilateral donations may or may not come to the attention of the NTM-A/CSTC-A. When the

Afghan Government and the donor nation advise NTM-A/CSTC-A early in the process, NTM-A/CSTC-A is able to track these cases and provide assistance, as necessary.

Specific donation information (e.g., quantities and types of equipment) is tracked in a database maintained by the DCOM-ISC. Since 2002, 45 nations (NATO and non-NATO), NATO, and six international funding agencies have contributed more than 2.36 billion USD in assistance to the Afghan Government.¹² Future solicitations will focus on equipment, infrastructure, and monetary donations for both the ANA and ANP. Monetary donations are especially critical due to the need for contracted institutional training centers, medical facilities, and standardized equipment.

2.5: Institutional Trainer and Mentor Status

The manning resources required to accomplish the mission of growing the ANSF are identified in part two of the CJSOR.¹³ NATO released CJSOR v10 on September 1, 2010, which incorporates requirements not filled in CJSOR v9.5, as well as additional requirements identified.¹⁴ Deputy Supreme Allied commander Europe (DSACEUR) increased efforts to fill the shortage in NATO ISAF institutional trainers. Following the September 23, 2010 NATO Force Generation Conference, in-place trainers and pledges increased by 18 percent and 34 percent, respectively, which decreased the remaining shortage of trainers by 35 percent. The total requirement in CJSOR v10 is 2,796, a net growth of 471 personnel. The current shortfall in CJSOR v10 for institutional trainers is 920, with 896 trainers in-place and 980 confirmed pledges for trainers (see Table 1 below for the current CJSOR trainer status). The United States currently sources 1,711 non-CJSOR trainer positions to mitigate the shortfall from CJSOR v9.5. To address the NATO CJSOR v10 shortfall temporarily, the United States is also providing an additional 868 personnel with skills not found in the deployed units. This U.S. bridging solution provides NATO with additional time to source CJSOR requirements.

Table 1. CJSOR Trainer Status (Version 10.0)

Authorized	In Place	Pledged	Shortage
2,796	896	980	920

Because not all of the trainers are needed at once, NTM-A prioritized its most critical trainer skills. Filling the top 15 most critical capabilities, depicted below in Table 2, will enable NTM-A to continue on schedule until early summer 2011, averting delays in institutional transition and ANSF professionalization.

For the fielded ANSF Force, the current shortfall is 16 Operational Mentor and Liaison Teams (OMLTs) and 139 Police Operational Mentor and Liaison Teams (POMLTs). This shortfall is

¹² For example, the following recent donations are indicative of major donations received by Afghanistan: in June 2010, a Turkish donation of 144 U.S.-produced .50 caliber machine guns, 950 81mm mortars, and more than 14,000 pair of field boots arrived in Afghanistan in support of the ANA; on July 23, 2010, Bosnia and Herzegovina made the most recent formal equipment offer to the ANSF. The staff completed the required work to accept 60 D-30 Howitzers in support of the ANA; on June 28, 2010, Australia contributed 50 million Australian dollars into the NATO Trust Fund with no caveats. This is the first of five yearly installments that comprise a total donation of 250 million Australian dollars.

¹³ The CJSOR is a capabilities-based document used by NATO to identify the forces required to execute the campaign.

¹⁴ TCNs have never completely filled the institutional trainer requirements in v9.5. Institutional trainer shortfall for the CJSOR v9.5 was 776 institutional trainers, taking into account the 646 confirmed pledges by TCNs.

compounded by the recent departure of the Dutch Forces operating in Uruzgan Province under RC-S. In 2011, the shortfalls will increase with the departure of the Canadian brigade in Kandahar and the additional growth of the ANSF. By 2011, the shortfall is projected to be 41 OMLTs and 243 POMLTs.

Table 2: NTM-A/CSTC-A Top 15 Capability Requirements

	Prioritized Capabilities	Start Date	Suggested Manning	Pledges	In-Place	Shortfall After Pledges
1	AUP Training Sustainment Sites (Shaheen, Costall)	APR 10	16, 21	SWE (9), EST (5)	None	7, 16
2	ANCOP Training Center (Methar Lam)	APR 10	40	JOR (17)	None	23
3	ANCOP Consolidated Fielding Center (Kabul)	DEC 10	70	None	None	70
4	AUP Regional Training Centers (Bayman, Jalalabad, Gardez)	APR 10	6, 38, 21	JOR (38)	None	6, 12, 9
5	ABP Training Centers (Spin Boldak, Shouz Shebergan)	JUL 10	35, 15, 15	None	None	35, 15, 15
6	Mi-17 Air Mentor Team (Kandahar, Shindand, Jalalabad, Kabul, Herat, MeS)	MAY 10	23, 23, 23, 7, 19, 23	LTU (10), ESP (8), HUN (19)	None	13, 23, 23, 7, 11, 4
7	C-27 Air Mentor Team (Kabul, Kandahar)	MAY 10	17, 17	None	None	17, 17
8	GAPTF Advance Fixed Wing AMT (Shindand)	SEP 11	5	None	None	5
9	Armed Forces Medical Academy (AFAMS) (Kabul)	OCT 10	28	None	None	28
10	ANSF National Military Hospital (Kabul)	OCT 10	28	None	None	28
11	Regional Military Hospitals (Kandahar, Mes, Herat)	FEB 10	18, 18, 18	None	None	18, 18, 18
12	Signal School (Kabul)	JUN 10	44	NOR (5), SWC (4), FIN (2)	None	33
13	RMTC HQ Senior Mentor Teams (Shorbach, MeS, Gardez, Kabul)	SEP 10	7, 7, 7, 7	HUN (3)	GBR (3)	1, 7, 7, 7
14	RMTC Trainers (Kabul, Shorbach, Shindand, MeS)	JAN 11	38, 38, 38, 38	None	None	38, 38, 38, 38
15	COIN Academy (Kabul)	FEB 10	57	FRA (5), ITA (3)	AUS, FRA, GBR, ITA (10)	39
			825			684

2.6: ANSF Assessment

Since the previous report, IJC changed the ANSF assessments process from the Capability Milestone (CM) Rating System to the Commander’s Unit Assessment Tool (CUAT) and Rating Definition Level (RDL) system. The new rating systems measure operational effectiveness and readiness in comparison to the CM Rating System, which measured the preparedness. The CUAT assesses the ANSF using qualitative methodology that is underpinned by quantitative data. The RDL system allows for the subjective evaluation of capabilities or functional areas in ANSF units, as well as objective evaluation of status report information, such as personnel, logistics, and training data and statistics. The CUAT enables the Coalition force partner to address the challenges, strengths, weaknesses, opportunities, and threats, in a narrative report. In addition, the CUAT addresses systems and doctrine, as well as simple status problems, and encourages problem solving within the chain of command. The CUAT provides inputs to a common database, thereby providing open access for analysis.

RDLs are specific, measured ratings with clear definitions that assess areas not considered under previous rating schemes. The RDL system differs fundamentally from the CM rating methodology, and therefore the two systems should not be compared. The RDL definitions are described in the attached unclassified annex.

2.7: Ministry of Defense (MoD)

2.7.1: Assessment of MoD

The MoD, with advisory support from U.S. Forces, is developing systems and institutions required to grow and professionalize the force. Ministerial development is supported through advising, key leader engagements, combined and joint meetings/working groups, inter-ministerial coordination, advisor councils, functional boards, and the Ministerial Development Board. Advisor-led development teams build enduring institutional capability and capacity, while contract civilians with prerequisite skills support development of the core management and operational systems essential to enable the MoD to plan, program, manage, and sustain the ANA. Approximately 272 United States and Canadian military personnel, government civilians, and contractors are currently involved in this initiative. These entities are developing capacity in four key functional areas: horizontal integration and strategy management support to operations, personnel management, and national logistics. Assessment of these efforts is accomplished through a revised system that focuses exclusively on establishing the capabilities within the MoD/ General Staff (GS) and ANA in order to enable transition. Development plans establish objectives, measures of effectiveness and measures of performance to assess ministerial development and report progress to the Ministerial Development Board.

NTM-A/CSTC-A uses the CM rating system to track the development of the MoD, MoI, ANA General Staff, and sustaining institutions and intermediate commands. An enhanced CM rating system has been developed for greater precision in measuring progress. The ratings CM-4 and CM-3 remain the same. Ratings CM-2 and CM-1 are parsed further into CM-2B, CM-2A, CM-1B, and CM-1A. Current CM Ratings are defined in the annex.

Table 3: MoD/GS CM Ratings (September 2010)

MoD Overall: CM-3	Current CM	Projected CM-1B (CY)
Support to Operations	3	4th Qtr 11
MoD Intel	3	2nd Qtr 11
GS G2	3	1st Qtr 12
Operations	2B	3rd Qtr 11
Force Mgmt	3	1st Qtr 12
Communications	2B	3rd Qtr 11
CSU	2A	4th Qtr 10
Medical	3	NET 13
Reserve Affairs	4	1st Qtr 12
Disaster Response	2B	1st Qtr 11
Facilities Engineering	3	4th Qtr 11
Personnel Mgmt	3	2nd Qtr 11
GS G1	3	1st Qtr 12
Personnel (Ministry)	2B	1st Qtr 11
Education (Ministry)	3	4th Qtr 11
Recruiting	2A	1st Qtr 11
Religious & Cultural Affairs	2B	1st Qtr 11
National Logistics	3	2nd Qtr 12
AT&L	3	1st Qtr 12
GS G4	3	3rd Qtr 11
Logistics Command	3	3rd Qtr 11
Acquisitions Agency	3	2nd Qtr 11
Hor. Int. & Str. Mgmt	3	3rd Qtr 11
MoD	2A	1st Qtr 11
1st Deputy MoD	2B	1st Qtr 11
CGoS	3	3rd Qtr 11
VCGoS	3	3rd Qtr 11
Strategy & Policy	3	3rd Qtr 11
Parliamentary Affairs	2A	3rd Qtr 11
MoD Legal	3	1st Qtr 11
GS Legal	3	4th Qtr 11
Public Affairs	2A	4th Qtr 10
MoD IG	2A	1st Qtr 11
GS IG	2A	1st Qtr 11
MoD Finance	2A	2nd Qtr 11
GS Finance	2A	2nd Qtr 11

CM ratings improved in select departments during the reporting period (see Table 3 above for ratings as of September 10); however, overall MoD capability remains at CM-3. In May 2009, all of the assessed departments were rated CM-3 except for two rated CM-2 (Inspector General and Budget & Finance) and one rated CM-4 (Reserve Affairs). As of July 2010, 15 of the departments had achieved CM-2 rating or better; 16 were rated at CM-3; and one (Reserve Affairs) remained at CM-4. Based on current assessments and the ministerial development plans, the MoD is expected to achieve CM-2B in January 2011 and CM-1A by the end of 2012.

2.7.2: Ministry of Defense Advisory (MoDA) Program

Seventeen civilians from the MoDA Program have successfully integrated into NTM-A/CSTC-A – ten as advisors to the MoD and ANA GS and seven as advisors to the MoI. The MoDA advisors provide specific skill sets to improve Afghan institutional-level competencies throughout the ministry. MoDA advisors are an addition to current Joint Manning Document (JMD) and Crises Establishment (CE) billets, and provide expertise to develop processes and systems in key functional areas, including Installation Management, Budget, Finance, Logistics, Parliamentary Affairs, and Personnel, and Education. They are deployed in theater for a minimum of one year. NTM-A/CSTC-A has requested 30 additional MoDA billets to increase the total MoDA personnel to thirty-three.

2.8: Afghan National Army (ANA) Institutional Capacity and Growth

NTM-A/CSTC-A continues to execute the MoD and GS development program to synchronize MoD organizational development and management and operational systems development.

The MoD developed process and policy foundations in personnel and logistics systems. In personnel, the Minister of Defense approved the first active duty service obligation (ADSO) policy. This policy, aligned with the recently passed Inherent Law for Officers and NCOs (ILON), codifies three, five, and ten-year service obligations for enlisted personnel, NCOs, and officers, respectively. The policy also mandates a 3:1 service obligation for education and training abroad. Overall, the ADSO policy now enables the MoD to retain its investment of trained personnel.

The MoD and NTM-A/CSTC-A introduced a first generation personnel information management system (PIMS). PIMS Basic is scheduled to be activated in each of the six corps HQ and in the HQ of the nine main intermediate commands by the end of November. A single corps – at the rate of 200 records per week - will require approximately 100 weeks to create a complete PIMS Basic record. PIMS Basic will enhance the ANA's ability to track, account for, and deploy personnel for operations. The tool can also support other administrative purposes, such as monitoring ethnic and gender balancing. The MoD and NTM-A/CSTC-A will conduct the first Human Resources Branch School course in October 2010. Following the training, graduates will rejoin their corps commands and provide their PIMS expertise. PIMS Extra, currently under development, will forecast gains and losses; link a line in the personnel establishment (tashkil) to an individual and link an individual to a tashkil line; show pay details; specify an individual's obligations incurred due to specialized training; and inform personnel managers of qualifications and duty limitations.

In logistics, the Minister of Defense signed and implemented four important decrees in August, addressing transportation, ammunition, fuel, and maintenance policies. These policies define common operating procedures, quality controls, and distribution methods. The policies are enduring documents that now form a large part of the policy backbone of the ANA logistics system. Supply discipline and decree enforcement will be important for progress in these four functions. Effective coaching and monitoring by NTM-A advisors placed at the MoD, Logistics Command, and national and forward supply depots will ensure success.

2.8.1: ANA Manning – Meeting End-Strength Goals

Since November 2009, the Afghan people have responded to ANA’s recruitment drive, and subsequently the ANA grew by more than 37,000 personnel. During this period, ANA consistently met or exceeded all monthly recruitment goals. As of August 2010, the ANA exceeded its October 2010 goal of 134,000 personnel, by 7,106 personnel. If current trends continue, the ANA will meet the 2011 goal of 171,600 personnel at or ahead of schedule. One risk to the projected ANA growth is attrition. In July and August, attrition rates increased over the 12-month average, 3.0 percent and 2.4 percent, respectively.¹⁵ If attrition rates remain elevated, the ANA will not meet its October 2011 growth goals. Figure 2, below, depicts ANA growth in relation to attrition, recruiting, and retention.

Figure 2: ANA End-Strength (October 2009 - September 2010)

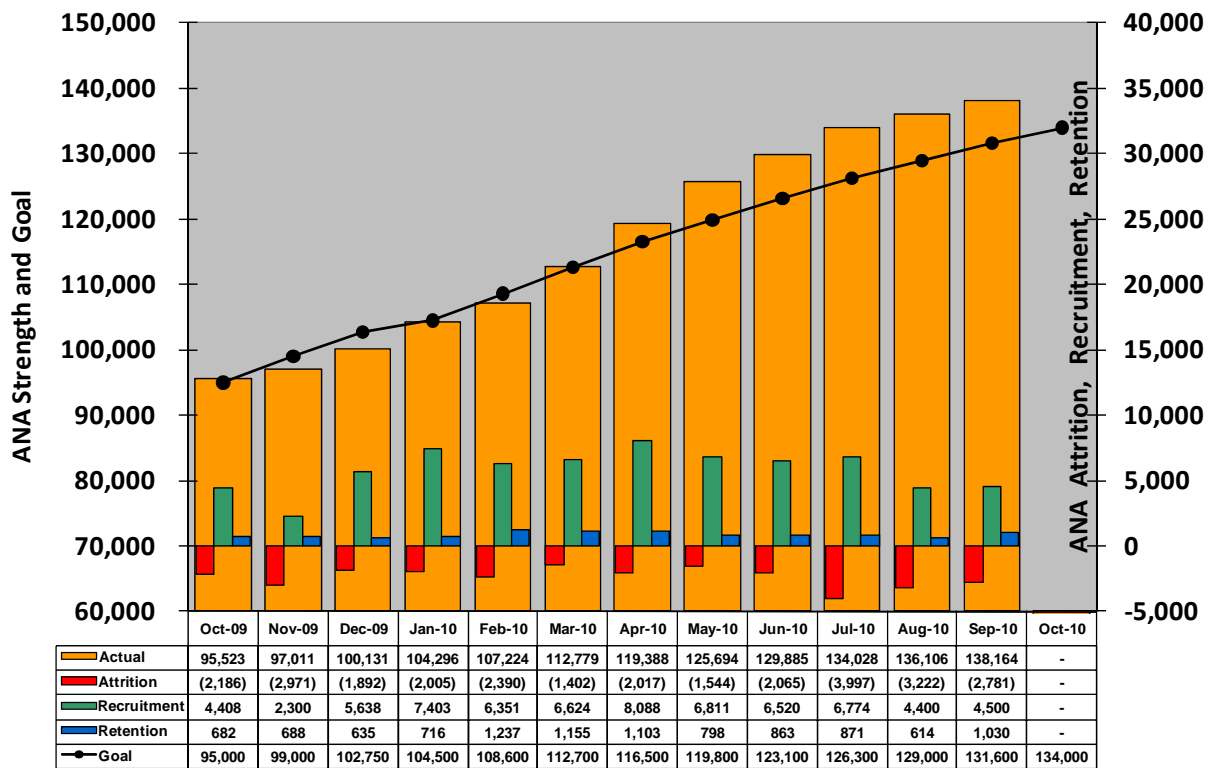

To reduce high attrition rates, the MoD and NTM-A conducted a review of the most likely causes of attrition within the ANA, and devised a plan to address them. The review identified the following factors as contributing to attrition trends: the seasonal impact of work available in farming and construction; poor management of leave time; and the lack of accountability of unit commanders across the ANA for their strength management. Despite these negative factors, two positive factors were identified as slowly reducing attrition at the same time: the pay increase in December 2009 and greater leadership in select units. Several proactive measures are being implemented to improve attrition rates. First, command emphasis has been a priority of the Chief of the General Staff (CoGS), and new commanders have been formally counseled.

¹⁵ Footnote the 12-month average – final August monthly report.

Second, corps and brigade-level commanders will be assigned set performance goals for AWOL levels, re-contracting, and promotions, with future promotions to sergeant (E5) tied to graduation from a professional development course. In addition, the Special ANSF Leave Travel Program was introduced in August 2010. This program provides regular air transport between Kabul and locations at 215th Corps (Helmand), 207th Corps (Herat), and 205th Corps (Kandahar), to provide travel, increase leave opportunities, and reduce AWOL-related attrition.

Recruiting of southern Pashtuns remains a significant challenge. Although the majority of recruits from the southern provinces are Pashtun, these provinces only produced 3 percent of this solar year’s recruits. MoD and NTM-A have set a 4 percent goal for the coming year to promote recruitment of this ethnicity. Overall, the total number of Pashtuns in the ANA meets national ethnicity goals, however, southern Pashtuns are underrepresented. The MoD is addressing this shortfall in several ways. First, a ministerial delegation of Pashtun leaders was dispatched to the region in September 2010 to meet with elders and other people of influence in the region. Second, ANA Recruiting Command (ANAREC) is developing a "Return to Protect Your Home" program, which will allow enlistment by southern Pashtuns into either of the two southern-based ANA Corps. Third, recruiters in the southern regions and the ministerial delegation are coordinating with local ANA and NATO force commanders so that recruiting efforts closely follow successful security operations.

2.8.2: ANA Leadership

Although the ANA has met several goals, challenges remain. Currently within the ANA, there are significant officer and NCO shortages. Figure 3 below depicts the goal for officer strength in yellow and the actual number in green, projecting out to November 2011. The MoD and NTM-A/CSTC-A have implemented the following measures to stem the 4,543 officer shortfalls: adding four additional Officer Candidate School training companies; doubling course seats in the Mujahedeen Integration Course; and expanding class size at the National Military Academy of Afghanistan. At the current pace, the officer shortfall is projected to steadily decrease through FY 2012.

Figure 3: ANA Officer Strength Goal and Actual (November 2009 - November 2011)

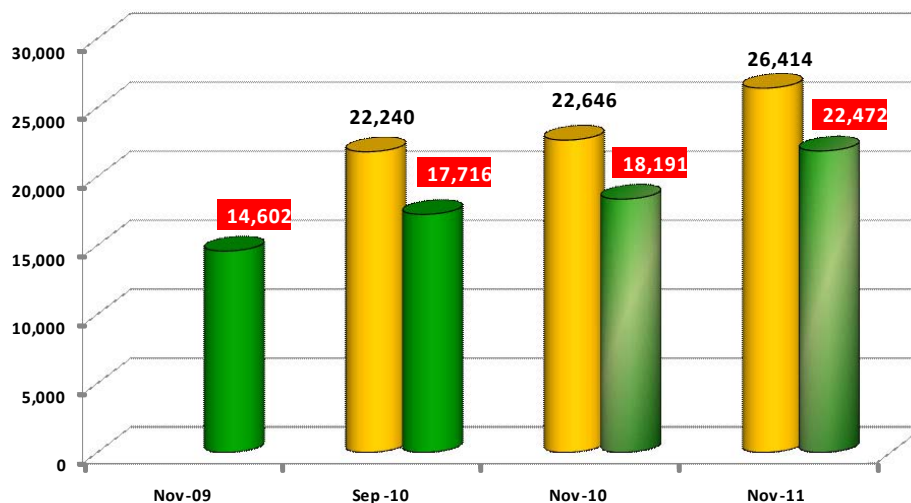

The NCO shortage, illustrated in Figure 4 below, also poses a significant challenge. Initial action taken to mitigate the 10,536 NCO shortfall includes a course capacity increase in the “1U” direct-entry NCO program, introduced in early 2010 and conducted at various training sites. At the Turkish-run Camp Gazi, which concentrates exclusively on NCO production, the “1U” course graduated its first class of 396 new ANA NCOs in August and will expand to a course size of 900 by December 2010. However, these efforts alone cannot eliminate the NCO shortage. Additional adjustments are underway to increase NCO training capacity. For example, the Regional Military Training Center (RMTC)-Capital in Darulaman will shift from Basic Warrior Training (BWT) training to a NCO Training Center of Excellence, with the expanded capacity to conduct more Team Leader Courses (TLC) (E5 level) and 1U (E6 level) training. Additionally, TLC courses across all regions will increase from 150 to 200 students per course. Beyond the element of capacity, rank structure is also an issue. MoD leadership will review the number of NCOs in the ANA force structure to reduce grades for specific billets that do not require NCOs, such as radio operators, ceremonial guards, and machine gunners. In sum, the measures outlined here are projected to eliminate the NCO shortfall by the end of FY 2012.

Figure 4: ANA NCO Goal and Actual (November 2009 - November 2011)

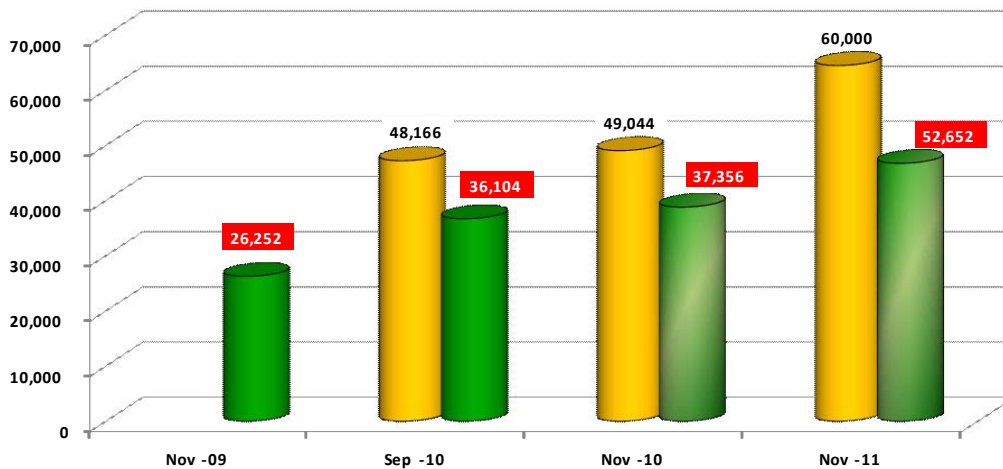

2.8.3: ANA Training

NTM-A/CSTC-A has implemented several changes to improve both individual and collective training for the ANA. In November 2009, individual ANA recruits had a 1:79 instructor-to-student ratio, no end-of-course testing or assessment, and limited driver and literacy training. By August 2010 the ANA instructor-to-student ratio had improved to 1:29; mid- and end-of-course testing and driver training programs had been implemented; and literacy instruction had been expanded to basic warrior training and advanced combat training programs. The improved instructor-to-student ratio has led to improvements in basic training. One illustrative example of this improvement is basic rifle marksmanship: ANA trainee qualification rates improved from 35 percent in November 2009 to 97 percent in August 2010.

In addition to the ANA’s flagship training center in Kabul (Kabul Military Training Center), five RMTC’s are now operational at temporary sites, enabling the routine training of 20,000 ANA soldiers each day across the country. The 6th RMTC at Shorabak will go online in November

2011. Additionally, seven of 12 Branch Schools are fully operational, providing the ANA with specialty skills training to support specific units and required capabilities across the force. All Branch Schools are projected to be in operation by February 2011.¹⁶ By February 2011, contingent on the arrival of a full complement of CJSOR v10 trainers, all Branch Schools will be initial operating capability (IOC), including those for artillery, engineering, human resources, military police, and armor.

Another addition to the institutional training base is the Military Skills Instructor (MSI) Course, recently implemented by the ANA Training and Education Command. The course consists of a six-week class for select NCOs and Officers that combines drill sergeant training with advanced instructor training. In August 2010, 25 NCOs graduated from the initial MSI course, representing the first cadre of certified military trainers and setting the standard for future ANA instructors.

IJC-partnered operations are designed to increase the quality of the fielded force. Currently, IJC is developing methods to quantify the effect of partnering on capability improvement. However, developing such metrics is challenging while concurrently carrying out a major COIN operation and it will require additional time. Experienced U.S. and coalition officers report anecdotally that partnering increases the quality of the ANSF by allowing partnered units to rely heavily on ISAF capabilities to control operations and perform long-term planning, thereby enabling the ANSF units to focus on and improve upon immediate operational objectives.

Table 4: ANA Partnering Status (September 2010)¹⁷

RC	Units	Kandaks	HQs	Embedded Partner		Partnered		Mentor		Uncovered	
				Kandaks	HQs	Kandaks	HQs	Kandaks	HQs	Kandaks	HQs
RC Capital	20	18	2	4	0	5	0	6	2	4	0
RC East	54	44	10	13	3	27	4	11	3	0	0
RC West	16	13	3	3	0	7	2	6	3	1	0
RC North	19	15	4	1	0	6	2	13	4	0	0
RC SW	24	20	4	11	1	6	2	7	1	0	0
RC South	31	26	5	6	0	16	5	15	3	1	0
TOTAL:	164	136	28	38	4	67	15	58	16	6	0

ANA Women Training

The inaugural female Officer Cadet School class of 37 female cadets began in May 2010. There was significant attrition, but 29 cadets graduated on September 23, 2010. The program of instruction (POI) consists of basic marksmanship, leadership, military subjects, and Military

¹⁶ The seven branch schools are logistics, intelligence, artillery, engineering, human resources, military police, and armor. The infantry school opened in August, 2010.

¹⁷ Embedded Partner = Live / Train / Operate with Afghan formations; Partner (-) = train / operate with Afghan formation; Mentor = units have dedicated mentors and focus on developing capacity of the key unit leadership; Uncovered = no Coalition partnered or mentor units present. Partnering data is current as of September 26, 2010. Note, numbers in this chart may not add because some ANA units are partnered with more than one Coalition force unit.

Occupational Specialty (MOS)-specific skills. Five of the graduating officers will remain at the Afghan National Army Training Command (ANATC) as Officer Candidate School (OCS) instructors to train future female OCS cadets.

Literacy Training

An important ongoing program is literacy training. Literacy training increases the ability of the ANA to operate effectively and provides an attractive recruiting incentive. Literacy is crucial to building enablers like military intelligence, signal engineers, and artillery. Each ANA unit also includes a religious/cultural officer who provides additional literacy training to recruits once the unit is fielded.

Over the past several months, NTM-A/CSTC-A has increased the literacy training program. In November 2009, literacy training was voluntary with only 5,700 ANA personnel enrolled. As of August 2010, 12,056 ANA personnel were enrolled. This is expected to expand to approximately 18,400 personnel by November 2010. Fielded units deliver most of this training so that it can be coordinated with operational commitments. Currently, 3,124 ANA personnel receive literacy training during professional development, from the Basic Warrior Training for recruits through the Sergeant Major Course for senior NCOs. Literacy training throughput will expand to 15,124 total by July 2011.

2.8.4: ANA Equipping

Building sustainable combat capacity in the ANA depends on the acquisition and fielding of critical shoot, move and communicate capabilities to meet accelerated fielding of a force of 171,600 personnel by October 2011.

NATO standard weapons are basic issue for both individual and crew served weapons. Individual weapons include M16 rifles, M4 carbines, M203 grenade launchers, M249 squad automatic weapons, and M9 pistols; crew served weapons include M240B machine guns, M2 heavy machine guns, and 82-mm and 81-mm mortars. Through a judicious approval of equipment accelerations, NTM-A/CSTC-A has issued 162,452 weapons to ANA and is currently equipping units to 100 percent of authorization.

The terrain of Afghanistan necessitates a diverse fleet of sustainable and reliable vehicles. U.S.-built vehicles meet these characteristics and to-date more than 21,900 pieces of rolling stock in 49 variants have been delivered. The Up-Armored High Mobility Multipurpose Wheeled Vehicle (UAH), light-tactical-vehicles (LTV), and medium-tactical-vehicles (MTV) are functional elements of the fleet. Logistics and transportation elements are equipped with heavy equipment transport (HET) tractors, and M915 and M916 tractors with trailers. Engineer units operate bulldozers, cranes, excavators, road graters, and scrapers. UAHs have been fielded at 70 percent of authorization, and LTVs and MTVs are being fielded at 100 percent of authorization. Logistics, transportation, and engineer units have been fielded at near-authorization levels. In the future, ANA leadership must emphasize equipment maintenance and accountability, both of which are assessed weaknesses.

To enable command and control functions, fielding of high frequency (HF), very high frequency (VHF), and wired communications equipment continues throughout the ANA. To date, 47,968

pieces of communications equipment have been delivered since initiating the first procurement action in August 2003. At the squad, platoon, and company levels, handheld and man-pack configurations are fielded. At battalion, brigade, and corps levels vehicular configurations, base stations, and retransmission sites are critical for unit command and control. Although formerly a shortage of radios restricted equipment fielding to no more than 70 percent of authorization, today this shortage largely has been resolved, and units are now receiving the full equipment authorization. As of August 29, 2010, the ANA has been fielded with more than 46,000 pieces of communications equipment. Communications equipment shortages have been resolved and units now receive full equipment authorization.

2.8.5: ANA Logistics Capabilities

The ANA logistics system has not been fully established. Priority for capability development was given to combat units to support COIN operations. Logistics capability is one focus area for 2011. ANA logistics planning has improved in preparation for the October 2010 logistics enablers fielding. The overarching Logistics Strategy Plan is being completed with the ANA. The strategy addresses structure, policy, training, supply, maintenance, and logistics automation.

The Corps Logistics Battalion (CLB) manning and equipment requirements are being completed. The first CLB is scheduled to stand up late fall 2010, and the remaining five will follow in CY2011. The blueprint for the first CLB is being tuned to the mission of medical support, equipment maintenance, and a distribution capability. The blueprint will be used to field the other five CLBs.

Two contracts will be awarded in the fall 2010 for the national depot operations and national vehicle maintenance. Both include a training provision highlighting the shortfall of trained personnel that will continue until the Logistics School is fully operational.

NTM-A/CSTC-A fielded an off-the-shelf inventory management/logistics automation system to provide greater accountability and visibility to ANA and NTM-A/CSTC-A decision-makers. The fielding of the system is supported by a network infrastructure down to the Corps and Field Support Depots.

Logistics leadership is assessed as a weakness. Clear command and control lines remain influenced along ethnic lines and logistics planning remains more of a discussion topic than a tool for execution. Sustaining functional development, while simultaneously supporting COIN operations, will remain a challenge for NTM-A/CSTC-A and the ANA.

2.8.6: ANA Assessment

Once kandaks graduate from collective training at the Consolidated Fielding Center (CFC), their progress is tracked by a Rating Definition Level (RDL) system. ANA kandaks progress through the RDL ratings over a period of time with assistance from partnered units, Embedded Training Teams (ETTs), and OMLTs that perform coaching, training, and advising roles for their units. These training teams continually assess the kandaks and report their status through IJC through the Regional Commands utilizing the IJC Commander's Unit Assessment Tool (CUAT) process, which operates on a six-week assessment cycle. As of September 2010, 10 units were "Effective

with Assistance” and nine were “Dependent on Coalition Forces for Success (see Figure 5 below).

IJC partnering and partnered operations have successfully increased the quality of the fielded force. However, significant challenges remain. Partnered units continue to rely heavily on ISAF to control operations and long-term planning is often ineffective due to the focus on current operations. Staff members’ low literacy levels hinder their ability to use computers, effectively manage staff functions, and exercise command and control. Partnering is essential to provide necessary supervision and oversight of planning for supplies (i.e., fuel and ammunition).

Figure 5: ANA Operational Effectiveness by Corps and Brigade (September 2010)

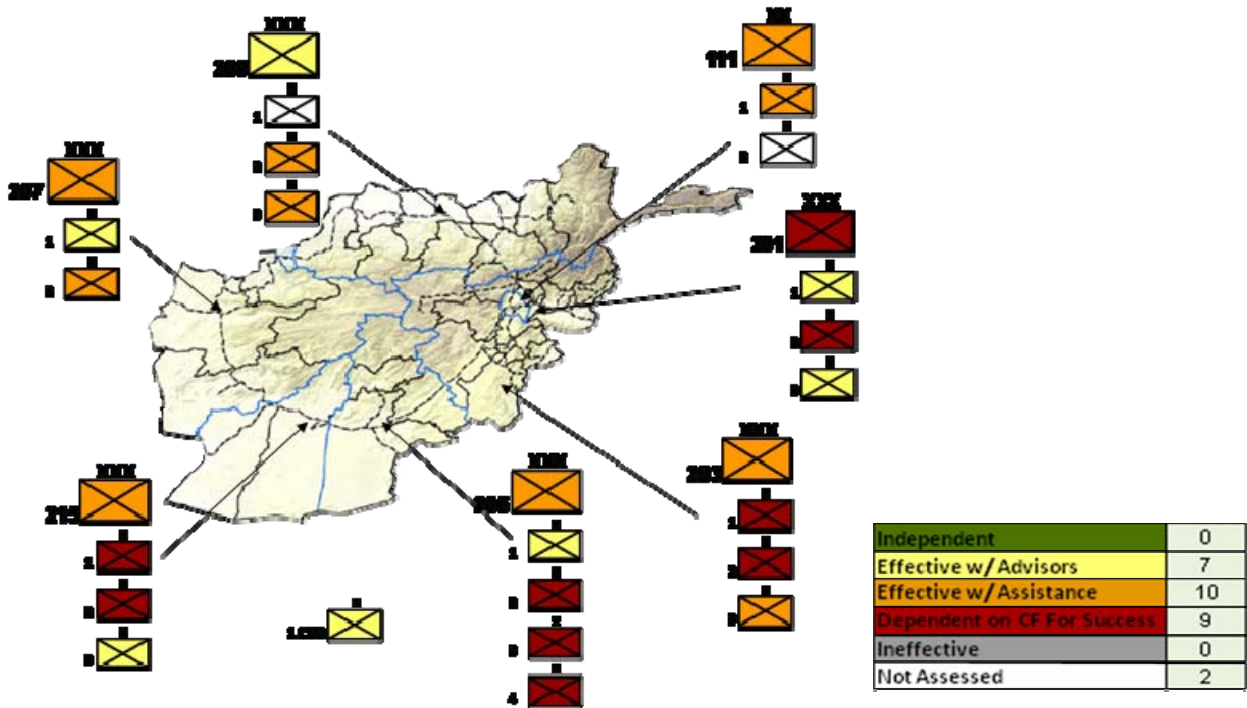

*Ratings are made with the RDL system.

2.9: Afghan Air Force

2.9.1: Transition from Afghan National Army Air Corps to Afghan Air Force

In June 2010, the President of Afghanistan directed that the organization known as the Afghan National Army Air Corps (ANAAC) be called the Afghan Air Force (AAF). Though the name change does not establish the AAF as independent from the ANA within the MoD structure, the move affirms Afghan intent to eventually return to its historical precedent of having an independent military air service.

2.9.2: Long-Term Strategy

The long-term strategy for the development of the AAF is the creation of a COIN-capable air force by 2016. This force will be capable of Presidential transport, airlift, rotary and fixed-wing close air support (CAS), medical evacuation (MEDEVAC), casualty evacuation (CASEVAC), and reconnaissance. The AAF will develop the ability to sustain its capacity through indigenous training institutions, including a complete education and training infrastructure. The air fleet will consist of a mix of older Russian and modern Western airframes, giving Afghanistan a bridge to the future for more advanced air capability if economic conditions permit sustainment. Afghan airmen will be trained in accordance with NATO procedures, and will be able to support their ground security forces effectively with all components of COIN airpower.

Afghanistan's harsh terrain, ground-based threats, and regional geography hinder efforts to build linked infrastructure, necessitating a prominent air force. Tactical airlift is necessary to support the provincial reconstruction teams (PRTs) in Afghanistan. Rotary-wing air power has proven effective for the Afghan Government, providing battlefield mobility, MEDEVAC to the ANSF, and humanitarian assistance and disaster relief to the Afghan people. Air capability has enabled Afghanistan to reach out to its neighbors, flying diplomatic, non-combatant evacuation, and humanitarian relief missions to surrounding countries.

2.9.3: Building ANSF Capability

The NATO Air Training Command-Afghanistan (NATC-A) is a NTM-A/CSTC-A organization that builds air power in Afghanistan along four lines of operation: aircraft build; airmen build; infrastructure build; and operational capability. The institutional development of the AAF integrates these four lines of operation by building a professional, self-sustaining institution.

2.9.4: Aircraft Build

In March 2010, the AAF aircraft inventory totaled 42 aircraft. At the end of September, the AAF had 50 aircraft, or approximately 34 percent of the planned build of 146 aircraft (see Figure 6 below). Aircraft currently on hand include 27 Mi-17 helicopters, nine Mi-35 attack helicopters, six C-27 airlifters, five An-32 airlifters, one An-26 airlifter, and two L-39 fixed-wing jets (the L-39s are awaiting refurbishment and do not currently fly). The AAF fleet reflects the COIN air power priorities. The C-27 is the first modern, all-weather-capable aircraft within the AAF. The Mi-17 is an effective rotary-wing airframe due to its lift capacity at high altitude and its durable structure.

Figure 6: Afghan Air Force Aircraft Fleet Growth (November 2009 - October 2010)

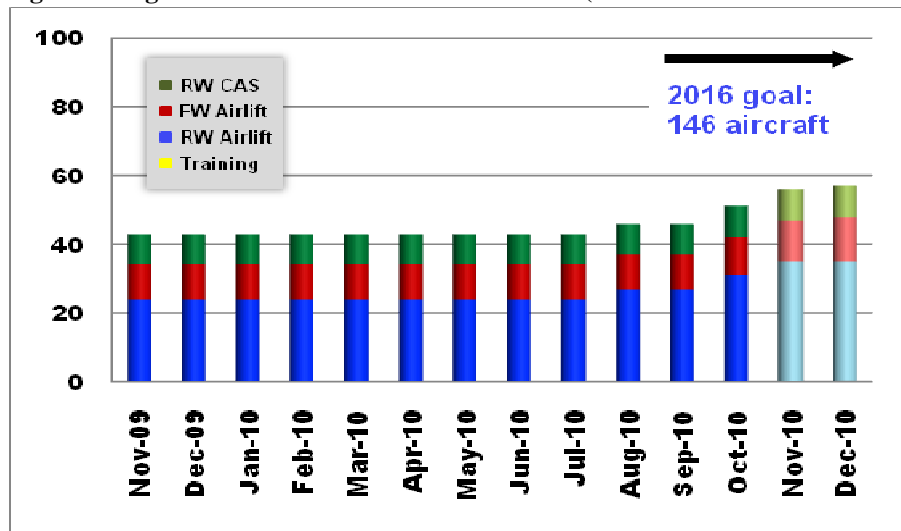

NTM-A/CSTC-A has planned and funded a comprehensive aircraft modernization plan. The key elements of this plan are:

1. The C-27—a turboprop, fixed-wing airlifter—will replace the six Antonov An-32 and An-26 platforms currently in use. The first Afghan C-27s arrived in November 2009. There are six in the fleet now, and the planned acquisition is 18 with an option for a total of 20 C-27s by 2012.
2. Procurement of six rotary-wing trainer aircraft will be selected with expected delivery by September 2011.
3. Procurement of up to 32 “Cessna-like” fixed-wing aircraft for initial flight and basic fixed-wing training with expected delivery by fiscal year 2013. The U.S. Air Force will conduct the source selection of this airframe.
4. Procurement of up to 20 aircraft for fixed-wing close air support (CAS). The U.S. Air Force will also conduct the source selection for this airframe.

The AAF currently maintains 27 Mi-17 medium-lift helicopters. An additional eight are in the United Arab Emirates for cockpit modifications, and will continue to arrive throughout 2010. The Mi-17 fleet will grow to 56 by 2016. Of these, 17 Mi-17s are expected to leave the fleet, either through battlefield loss or mechanical time-out, during fiscal years 2012 through 2016.

2.9.5: Airmen Build

AAF growth is currently encompassed in overall ANA statistics. By September, end-strength should reach approximately 4,530 airmen. The total will have increased by 1,141 personnel over the March 2010 strength of 3,389 personnel, a gain of 34 percent. The current Tashkil-authorized end strength for the AAF is 5,616 personnel. Attrition stands near 0.5 percent per month, which is an acceptable level to maintain the professional and technical skills required for a modern air force. The limiting factors in growing the number of critical AAF personnel include English language and pilot training, which occurs outside Afghanistan. A secondary limiting factor in producing a capable AAF is training personnel who are able to perform the technically-advanced specialties required for aircraft maintenance and airfield support.

Assembling an experienced, professional AAF, including an instructor cadre that can provide pilot and technical training, is the focus of NATC-A's "Airmen Build" line of operation.

AAF basic pay scales mirror those of the ANA. NATC-A assisted the AAF in introducing an Aviation Incentive Pay (AIP) program to recruit and retain qualified personnel for specialized skills positions. This plan increases the pay for aircraft maintainers who achieve and maintain various levels of technical competence useful for repairing aircraft. For pilots, the AIP increases pay based on the ability to perform flying missions and the ability to speak English. Both qualifications are routinely evaluated as part of the program. The AIP program will help the AAF recruit literate, technically capable personnel, thereby building a strong foundation of competent, professional leadership.

2.10: Ministry of Interior (MoI)

2.10.1: Institutional Capacity

President Karzai swore in Bismullah Mohammadi as Minister of Interior on June 30, 2010. He is fully engaged with Coalition advisors and Afghan key leaders to move ministerial development efforts forward. The MoI remains assessed as not being able to accomplish its mission without significant Coalition assistance. Of the 25 Ministerial Development Areas assessed, seven departments are able to accomplish their mission, with only some Coalition assistance. Of the 18 remaining ministerial development areas, two departments are assessed as existing but not able to accomplish their mission and 16 are assessed as not being able to accomplish their mission without significant Coalition assistance (see Table 5 below).¹⁸ Significant challenges remain with the logistics, facilities development, and infrastructure management departments. The most recent Ministerial Development Board Review (MDBR) projects the MoI achieving self-sufficiency, most optimistically, no earlier than December 2012. This quarter, there was significant Afghan participation in the Ministerial Development Coordination Meeting (MDCM) – a forum that assesses ministerial development. MoI support for the July 20 Kabul Conference was a success for Afghan security forces with no major incidents occurring and several attacks prevented.

¹⁸ Ratings are based on systems-level capability milestone ratings produced by NTM-A. The rating scale consists of six categories. CM-1A: Ministries capable of autonomous operations. CM-1B: Ministries capable of executing functions with coalition oversight. CM-2A: Ministries capable of executing functions with minimal coalition assistance. CM-2B: Can accomplish its mission but requires some coalition assistance. CM-3: Cannot accomplish its mission without significant coalition assistance. CM-4: The department exists but cannot accomplish its mission.

Table 5: MoI CM Ratings (September 2010)

Mol Overall: CM-3	Current CM	Projected CM-1B (CY)
Ministry of Interior		
Parliamentary Affairs	4	1st Qtr 11
Public Affairs	2B	3rd Qtr 11
Inspector General	2B	1st Qtr 11
Anti-corruption	2B	3rd Qtr 11
Legal Affairs/LEGAD	3	1st Qtr 12
DM of Counter-Narcotics		
Counter Narcotics	3	3rd Qtr 11
DM of Strategy and Policy		
Strategic Planning	2B	3rd Qtr 11
Policy	3	3rd Qtr 11
DM of Security		
Afghan Uniform Pol	3	3rd Qtr 11
Afghan Border Pol	2B	3rd Qtr 11
GDPSU	4	1st Qtr 12
Anti-Crime	2B	1st Qtr 11
ANCOP-(G)	3	4th Qtr 12
Operations Planning	2B	3rd Qtr 11
Force Readiness	3	1st Qtr 12
Intelligence	3	2nd Qtr 11
DM of Admin & Support		
Personnel Mgmt	2B	3rd Qtr 11
Logistics	3	3rd Qtr 12
Finance & Budget	3	1st Qtr 12
Facilities & Installation	3	NET 13
Surgeon Medical	2B	1st Qtr 12
Info, Comms & Tech	3	1st Qtr 12
Training Mgmt	3	4th Qtr 11
Acquisition & Procurement	3	4th Qtr 11
Force Mgmt	3	1st Qtr 12

2.10.2: Assessment of MoI

The roles of advisors in building MoI capacity include assisting Afghans to develop strong organizational functions and systems and developing quality leaders. More than 200 international community (IC) advisors are assisting the Afghan MoI to develop national government coordination by developing relationships and processes to deal with other ministries, such as the Office of the National Security Council, the Parliament, the President of Afghanistan, and synchronization within the MoI.

Recently appointed Minister Mohammadi has developed six priorities: training and education; leadership development; fighting corruption; promoting quality living and working conditions;

review and reform of the Tashkil; and development of a recognition and discipline system. Minister Mohammadi is actively working to hold leaders at all levels accountable for their organizations. He has re-assigned 19 key ministerial appointees and has articulated his intent to take similar action at the regional, provincial, and district levels.

2.10.3: International Police Coordination Board (IPCB)

The International Police Coordination Board (IPCB) is the main forum for providing strategy and policy advice on issues of significant police development. The IPCB's charter is designed to enhance the understanding of the International Police Development effort, identify potential areas of duplication, and identify shortfalls in police development activity that may require international focus.

The IPCB is comprised of members from NTM-A/CSTC-A, ISAF, the E.U. Police Mission in Afghanistan (EUPOL), and the international community. IPCB members work with the Deputy Commander – Police (DCOM-P) Institutional Development Working Group and with Afghan partners to separate political influence and control of the police. The IPCB advises the Minister of Interior on key policy and security issues and facilitates staff collaboration.

2.10.4: MoI International Coordination Cell

The coordination of IC support to ANP development is assessed as ineffective. The MoI lacks a comprehensive system for effectively managing programs, activities, and resources. To address this issue, NTM-A/CSTC-A and other relevant organizations are developing an MoI-led International Coordination Cell (MICC). The MICC will manage international contributions and provide effective project planning to improve project execution and efficiency.

2.11: Afghan National Police (ANP) Institutional Capacity and Growth

2.11.1: ANP Manning

Since March 2010, the ANP has sustained growth ahead of monthly objectives. Current ANP end-strength through August 2010 is 119,639 – exceeding the 2010 goal of 109,000 (see Figure 7 below). The Afghan Uniformed Police (AUP) has also met its attrition and retention goals in the past six months, which has allowed the force to retain more experienced personnel. Afghan Border Police (ABP) attrition over the past six months averaged 1.62 percent, close to the 1.4 percent goal. ANCOP attrition, though declining, averaged 3.2 percent over the past six months, well in excess of the 1.4 percent goal. ANP recruiting efforts are on track despite the historically challenging summer months, with 1,874 new recruits for the month of August. ANCOP recruiting remains significantly below target and actions to improve ANCOP recruitment are being planned. Without significant improvement, the ANP goal of 134,000 for November 2011 will not be met.

Figure 7: ANP End-Strength (October 2009 - September 2010)

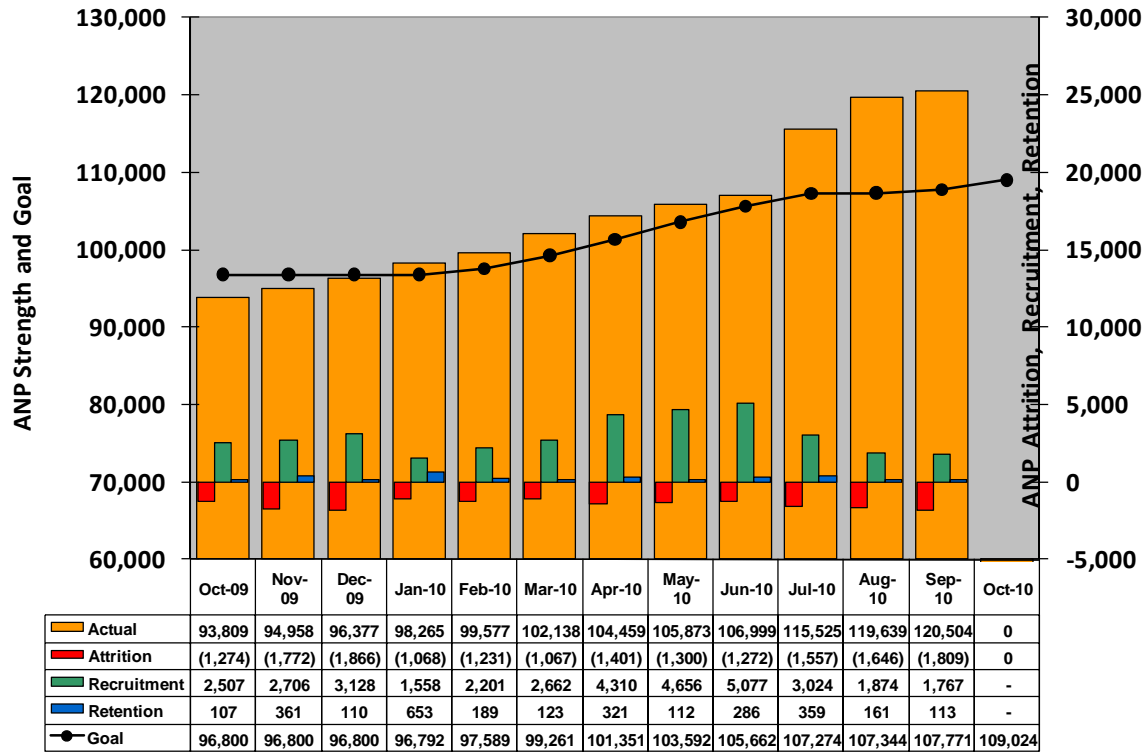

Afghan National Civil Order Police (ANCOP)

The ANCOP remains a top priority. Current attrition rates are the principal challenge for ANCOP growth. Attrition declined from 11.7 percent in December 2009 to 1.7 percent in August 2010 but still hovers above the target goal of 1.4 percent. The attrition challenge is compounded by poor recruiting, which has fallen short of expectations. Measures are being implemented to address these challenges, including: coupling literacy training with the NCO course; lowering entry-level recruiting literacy standards; partnering the centralized recruiting system with local units of employment; improving leadership with training and development (command and staff courses); and changes to leave practices. Implementation of a disciplined, operational deployment cycle (ODC) is the key to reducing attrition and increasing retention. The ANCOP ODC implementation will begin December 1, 2010.

The new Minister of Interior is a strong proponent of the ANCOP force. Targeted efforts to improve ANCOP's regeneration capacity and individual units' resilience have increased ANCOP's capability and are expected to improve attrition rates. These efforts include pay initiatives, partnering, and improved pre-deployment preparation, which has expanded to include pre-mission training with Special Forces. Moreover, the planned ANCOP growth includes logistics battalions and the addition of a 5th Brigade. Special Forces and IJC unit partnering, combined with focused pre-deployment preparations training, are improving the operational effectiveness of fielded units. If initiatives do not improve ANP growth, ANCOP, and subsequently the ANP, will not meet November 2011 strength goals.

ANP Partnering and Operational Effectiveness

Development of the ANP continues, with particular focus on increasing the operational effectiveness of the force. Development of the AUP fielded force continues to be a challenge. One unit is assessed as “Independent”, six as “Effective with Advisors” and “Effective with Assistance”, with seven still “Dependent on Coalition Forces for Success” as shown in Figure 8.¹⁹

Figure 8: ANP Operational Effectiveness (September 2010)

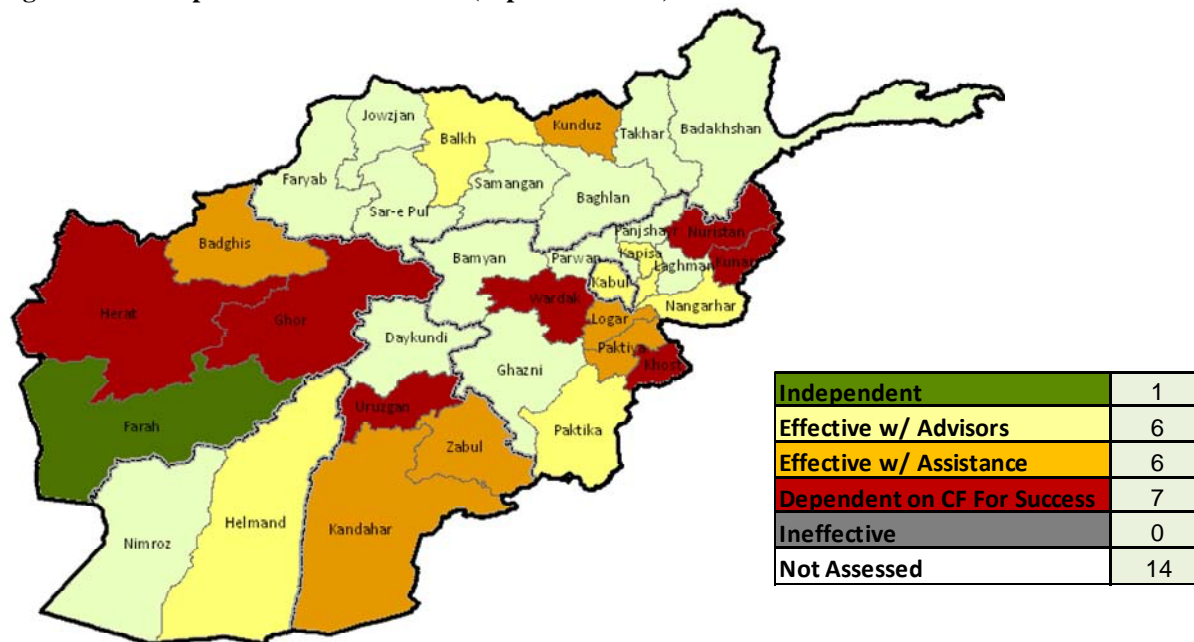

Corruption and the perception of corruption continue to negatively affect the reputation of the AUP among the Afghan population. Only a few areas have positive popular perception ratings of the AUP.²⁰ Despite some efforts by the Government of Afghanistan to eliminate corruption and improve rule of law, overwhelming reports of corruption continue. If corruption activities continue to go unchecked at current levels, they threaten to keep the population separated from the government. Corruption at the provincial headquarters and district headquarters (PHQ/DHQ) level negatively affect the trust of the populace.

However, as Table 6 shows, 16 of 17 AUP provincial headquarters are partnered (94 percent) and 74 of 81 (91 percent) key terrain district units are covered, meaning they have some form of partnering or mentoring.²¹ As of late September, U.S. law enforcement advisors were embedded to provide intensive, on-the-job, subject matter expertise for partnered ANP units in key terrain districts. We do not have data on police in non-key terrain provinces. The territorial organization of the ANP mirrors that of the ANA Corps. The AUP are arrayed in six zones with

¹⁹ Provinces with either key terrain districts or area of interest districts.

²⁰ HQ ISAF polling from June 27, 2010 indicates that people perceive improvement on security due to AUP in last 6 months in the following percentages: Badakhshan (80 percent), Badghis (77 percent), Panjshir and Sar-e Pul (59 percent both), Laghman (58 percent), Parwan (56 percent), Faryab (55 percent), Samanghan (54 percent), Balkh (51 percent).

²¹ Embedded Partner = Live / Train / Operate with Afghan formations; Partner (-) = train / operate with Afghan formation; Mentor = units have dedicated mentors and focus on developing capacity of the key unit leadership; Uncovered = no Coalition partnered or mentor units present.

associated Regional Police Headquarters with subordinate provincial and district police structures. The ANCOP is currently structured in four brigades with a total of 20 battalions.

Quality of the ANP Force

NTM-A/CSTC-A is working with ANP leadership at the colonel and general officer levels to develop and improve leadership skills to overcome inadequate training and lack of experience. This leadership training incorporates the following measures:

1. Partnering with ANP leaders and key staffs in all police forces including national systems, pillared police commands as well as the regional, provincial, and district levels.
2. Developing a top-down system of accountability and discipline from MoI that is grounded in a code of service discipline with appropriate checks and balances.
3. Developing a top-down and bottom-up system of reward, recognition, promotion, and appointment planning.
4. Implementing institutional leader development systems and schools, all within an officer and NCO professional development program.

NTM-A/CSTC-A is working with the ANP to increase the quantity and quality of its Officer Corps. An Officer Candidate School is now operational, and its abbreviated six-month program of instruction efficiently trains officers to supplement the Afghan National Police Academy. NTM-A/CSTC-A plans to send approximately 1,000 ANP officers to Turkey to attend a six-month OCS class. NTM-A/CSTC-A has implemented a number of leadership development programs for officers and senior NCOs, such as ANCOP company and battalion commander courses and AUP district and provincial commander seminars. Implementation began in July and will continue through November. The ANP staff college, which is intended to become the center of excellence for Afghan police officer professional development, is preparing to deliver its first course in December 2010.

Table 6: ANP HQ Partnering Status (September 2010)

ANP Type	Units	Embedded Partner	Partnered	Limited Partnering	Mentor	Uncovered
AUP (Prov. HQ)	18*	1	7	0	6	4
ABP (Zone HQ)	7**	2	1	0	1	3
ANCOP (BDE HQ)	4	0	1	0	3	0
TOTAL:	29	3	9	0	10	7

*AUP (PHQ)- 4 Provinces w/ no Partner: Kunar, Nangarhar, Badghis, Kapisa

**ABP HQ- Added Kabul ABP National HQ

2.11.2: ANP Equipping

The ANP Equipment Tashkil comprises three categories: shoot, move, and communicate. Nearly all equipment is ordered from commercial off-the-shelf sources. Weapon systems and Up-Armored HMMWV (UAH) are the exception to this rule.

ANP units have received all of the required weapons with the exception of 40 mm Non-Lethal Multiple Launchers. NTM-A/CSTC-A will be able to fill this requirement for the riot suppression system by March 2011. The MoI and MoD are working to distribute Former Warsaw Pact (FWP) weapons in order to meet near and long-term fielding requirements.

The SY 1389 Tashkil provides for the ANP to receive 30,641 various types of vehicles. The preponderance of vehicles are the Light Tactical Vehicle (LTV), the Medium Tactical Vehicle (MTV), and the UAH, but also includes water trucks, trailers, motorcycles, forklifts, and buses. The ANP has received 17,732 vehicles (or 58 percent of the SY 1389 Tashkil requirements). There are over 1,321 vehicles in Kabul awaiting fielding and the remaining 11,588 pieces have yet to be delivered from donor sources.

ANP command and control (C2) capabilities have been enhanced through the extension of the MoI network to the six Regional Headquarters and 28 of 34 Provincial Headquarters, as well as by the delivery of approximately 2,000 trunked radios to the Kabul area. The SY 1389 Tashkil designates 64,180 radios of various types for the ANP. The majority of these systems are the handheld HF, VHF, and UHF radios.

There remain challenges with compatibility and coordination between the ANA and ANP C2. Currently the ANA and ANP operate on different radio frequencies thereby frustrating communication. NTM-A/CSTC-A is considering fielding a networking system that would patch communications between the ANA and ANP radios. Operational communications between the ANA and ANP are effective at the Operational Control Centers and National Military/Police Command Centers.

2.11.3: ANP Logistics Capabilities

ANP logistics capabilities are not as well-developed as ANA logistics, due in part to the focus on COIN operations. With some of the focus shifting to governance and development functions, the ANP/MoI has received more attention. To leverage capabilities of the ANA, NTM-A/CSTC-A is working jointly with the MoI and MoD in the development of a standing Cross Ministry Service Agreement where the overarching aim is to create an integrated National Logistics System.

As with ANA in 2009, NTM-A/CSTC-A has requested an external logistics assessment team from Army Central Command (ARCENT) and Defense Logistics Agency (DLA), to provide an in-depth look into the current state of MoI logistics. The assessment will include recommendations for transition and a synchronized ANP logistics strategy. The overall objective is efficiency and affordability, necessitating the building of a single national logistics system or one that is as close as culturally possible.

2.11.4: Women's Police Initiatives

Currently there are 1,191 women serving across the MoI, of which 929 are serving in the ANP. There are 176 female officers (three General Officers), 417 female NCOs, and 336 female patrolmen. The Afghan National Police Strategy aims to increase the number of women serving in the ANP to 5,000 over the next five years. This includes both civilian and active police positions. The majority of women serve in the Family Response Units which are currently established in all 34 provinces. Other areas suggested for female service include Information Technology, Intelligence, Counter-Narcotics, Border Control, Counter-Kidnapping, Healthcare, Recruiting, Biometrics, Logistics, Public Affairs, Instructor Cadre, Crime Scene Investigation,

Criminal Investigation, Education, Finance, Legal, Force Management, Communications, and Administrative. The SY 1389 Tashkil included 706 positions specifically coded for women, up from 432 in the last solar year.

Although recruiting women into service remains challenging, ANP Recruiting Command now has a female recruiting branch, formed specifically to focus on the recruitment, retention and career advancement of women in the ANP. The ANP Recruiting Command has directed effort on accessing women into the police force. Initiatives include running a focused female-centric advertising and media campaign and hosting several Female Recruiter Conferences and workshops to discuss employment of women in the ANP.

A policy has been drafted to address specifically the recruitment and treatment of women who serve in the ANP and will be incorporated into an overarching accessions policy, currently awaiting final review and approval by the MoI. Once approved, the ANP will have a tool for protecting women from discrimination and afford equal opportunity for them to serve in all ranks and branches.

Additionally, the training base has made adjustments to better suit the requirements of a female student. The basic six-week course was extended to eight weeks for women, allowing them to go home in the evenings for traditional household roles. Further adjustments are planned to make training more regionally available.

2.11.5: Overall Assessment of the ANP

Progress in the ANP is tracked by a RDL system. ANP units progress through the RDL ratings over a period of time with assistance from partnered units and POMLTs that perform coaching, training, and advising roles for their units. Partners and OMLTs continually assess the unit and report their status through IJC through the Regional Commands utilizing the IJC Commanders Unit Assessment Tool briefing process based on a six-week assessment cycle.

Section 3 – Security

3.1: State of the Insurgency

The insurgency retains momentum in certain areas; however, in others the momentum is shifting in favor of Afghan Forces and ISAF. The regional and domestic factors that sustain the insurgency and impede effective COIN operations remain unchanged; in some cases they are still trending in the insurgency's favor, while in others, the trends have been reversed. While kinetic activity is at a historic high, we are seeing some early indications that comprehensive COIN operations are having localized effects in portions of Helmand and Kandahar Provinces.

Efforts to reduce insurgent capacity, such as safe havens and logistic support originating in Pakistan and Iran, have not produced measurable results, though the Haqqani Network has sustained losses in the Pakistani tribal areas. Pakistan's domestic extremist threat and the 2010 floods reduce the potential for a more aggressive or effective Pakistani effort in the near term.

While ANSF and ISAF operations have increased pressure on insurgent networks over the past several months, the insurgency has proven resilient with sustained logistics capacity and command and control. Larger and more aggressive security operations are beginning to increase pressure on insurgent capacity and operations; however, the insurgents will retain operational momentum in some areas as long as they have access to externally supported safe havens and support networks.

The insurgency in Afghanistan is Taliban-dominated and includes three major groups: the Quetta Shura Taliban (QST), Hezb-e Islami Gulbuddin (HIG), and the Haqqani Network (HQN). These groups cooperate and coordinate at times, with their areas of operations appearing geographically and demographically determined.²² However, increased tension between HIG and QST commanders in northeastern Afghanistan is apparent. Al-Qaeda continues to provide facilitation and funding while relying on insurgent safe havens in Pakistan. The insurgency operates mainly in the Pashtun-majority areas of Afghanistan in the south and east, and in Pashtun pockets in the north.

The Taliban's strategic goal remains causing sufficient losses to Coalition forces to damage international support for the ISAF mission and prompt a rapid withdrawal of foreign forces from Afghanistan. To achieve their goal, insurgents commenced their 2010 "Victory" campaign, launching several high-profile, complex attacks and subsequently generating significant media attention. This campaign seeks to undermine the increased Afghan Government presence in contested areas by targeting those who are working with the government or ISAF. The Taliban's strength lies in the Afghan population's perception that Coalition forces will soon leave, giving credence to the belief that a Taliban victory is inevitable. The Taliban is not a popular movement, but it exploits a population frustrated by weak governance.

On July 1, Taliban leader Mullah Omar released his guidance and approval for murder and intimidation, containing five major points:

- Fight Coalition forces to the death without withdrawing or surrendering; attempt to capture Coalition forces whenever possible.
- Capture or kill Afghans who support or work for the coalition or Afghan Government.
- Capture or kill Afghan women who help or provide information to the Coalition.
- Recruit anyone who has access to Coalition forces bases and who has the ability to collect detailed information about Coalition forces.
- Purchase or obtain more heavy weapons such as rocket propelled grenades, machine guns, and anti-aircraft machine guns.

The insurgency continues to adapt and retain a robust means of sustaining its operations, through internal and external funding sources and the exploitation of the Afghan Government's inability to provide tangible benefits to the populace. External funding to the insurgency is top-down, while internal funding is bottom-up, providing the Taliban consistent streams of money to fund operations sufficiently. Externally, funding originates in Islamic states and is delivered via couriers and *hawalas*.²³ During Ramadan, as seen in previous years, insurgent fundraising efforts increase in Islamic nations. Internally, a significant portion of funds are derived from the opium

²² Operational-level coordination amongst the insurgency occurs, but the best and most frequent coordination is observed at the tactical level.

²³ The *hawala* system is an informal value transfer system based on the performance and network of money brokers, called *hawaladars*.

trade or other illicit activities, such as timber smuggling and illegal chromite mining in RC-East. Small arms weapons and ammunition, in addition to materials and technology for IEDs and Home-made Explosives (HMEs), are readily available throughout the region. Insurgents leverage tribal friction and exploit internally displaced persons and refugees. Without a change in social and economic conditions, they will exploit Afghanistan's youth bulge to fuel their recruitment needs. The insurgents exploit the Afghan Government's inability to provide tangible benefits for the populace by leveraging religious, ethnic, and tribal affinities with local Afghans for recruitment, resources, and freedom of movement.

The insurgency has a number of strengths, the most significant strength and main effort being the speed and decisiveness of their information operations and media campaign. Organizationally, the insurgency's capabilities and operational reach have been qualitatively and geographically expanding, as evidenced by a greater frequency and wider dispersion of insurgent-initiated attacks; however, that spread is being increasingly challenged by the ISAF surge forces conducting operations. Despite the increase in ANSF and ISAF capabilities to counter insurgent attacks, the insurgents' tactics, techniques, and procedures (TTPs) continue to evolve in sophistication. In addition, the insurgency continues to inhibit the expansion of a legitimate Afghan Government through an effective shadow governance process that provides dispute resolution, rule of law, and other traditional services in a number of areas.

The insurgency also has a number of weaknesses and vulnerabilities. The insurgency is comprised of multiple, locally-based tribal networks, which at times can make execution difficult. Persistent fissures among insurgent leadership endure at the local level and further complicate coordination. The Taliban is not a popular movement. It is dependent on marginalized and threatened segments of the Pashtun population and is over-reliant on external support. Despite the presence of shadow governors, the insurgency still cannot deliver sustainable development or administer governance beyond the crudest dispensation of justice.

The porous border between Afghanistan and Pakistan continues to allow insurgent groups in Pakistan's Federally Administered Tribal Areas (FATA) and Khyber Pakhtunkhwa (KPk)²⁴ Province to conduct cross-border operations in the Pashtun-dominated areas of eastern and southern Afghanistan. Pakistan's domestic extremist threat and the recent flood reduce the potential for more aggressive or effective COIN efforts over the next three months. Militant groups in Pakistan's FATA and KPk are part of a broader syndicate of extremist groups, including al Qaeda, Taliban, the Haqqani Network, and Lashkar-e-Taiba. Militant groups in KPk are capitalizing on the 2010 flood by providing relief aid and other assistance to KPk residents, especially in areas deemed either too remote or dangerous for aid workers to reach. Islamic charities linked to militant groups will continue to use the natural disaster to demonstrate to Pakistanis their ability to provide aid and services that the Government of Pakistan cannot provide.

Iran continues to provide calibrated support to the Afghan insurgency in the form of small arms, ammunition, RPGs, and materials used to create IEDs. An assessment of Iranian support to the Afghan insurgency over the past year indicates neither a significant increase in Iranian support, nor the provision of more advanced Iranian signature weaponry.

²⁴ The KPk was formerly known as the North Western Frontier Province.

Kinetic activity continues to exceed historical trends. There have been increases in all methods of attacks, except IEDs, which were lower in August 2010 than they were in August 2009, and direct fire (DF) is increasing at a higher rate than indirect fire (IDF). This is possibly due to the amount of resources it takes to attack utilizing IDFs versus DF and IEDs. Overall kinetic events are up 300 percent since 2007 and up an additional 70 percent since 2009. The Afghan Government and ISAF presence continues to increase in contested areas, prompting the insurgency to increase its targeting on those working with the government and/or with ISAF.

Overall, despite public polling showing a lack of support for the Taliban, Afghan nationals are likely to remain non-committal until the Afghan Government and Coalition forces can convincingly provide security, governance, and economic opportunities. The Taliban have sufficient organizational capability and support to pose a threat to the government's viability, particularly in the south. If the security situation erodes, regional stability will rapidly decline as well.

3.2: ISAF Concept of Military Operations

The ISAF concept of operations is depicted in Figure 9. The operational main effort remains focused on the Central Helmand River Valley, where comprehensive civil-military efforts are aimed at bringing improved governance, development, and security to the more than 500,000 Afghans living in these six districts. Overall progress, however, is slow, with significant challenges in the governance and security lines of operation as discussed in detail in the following sections of this report.

Figure 9: ISAF Concept of Operations²⁵

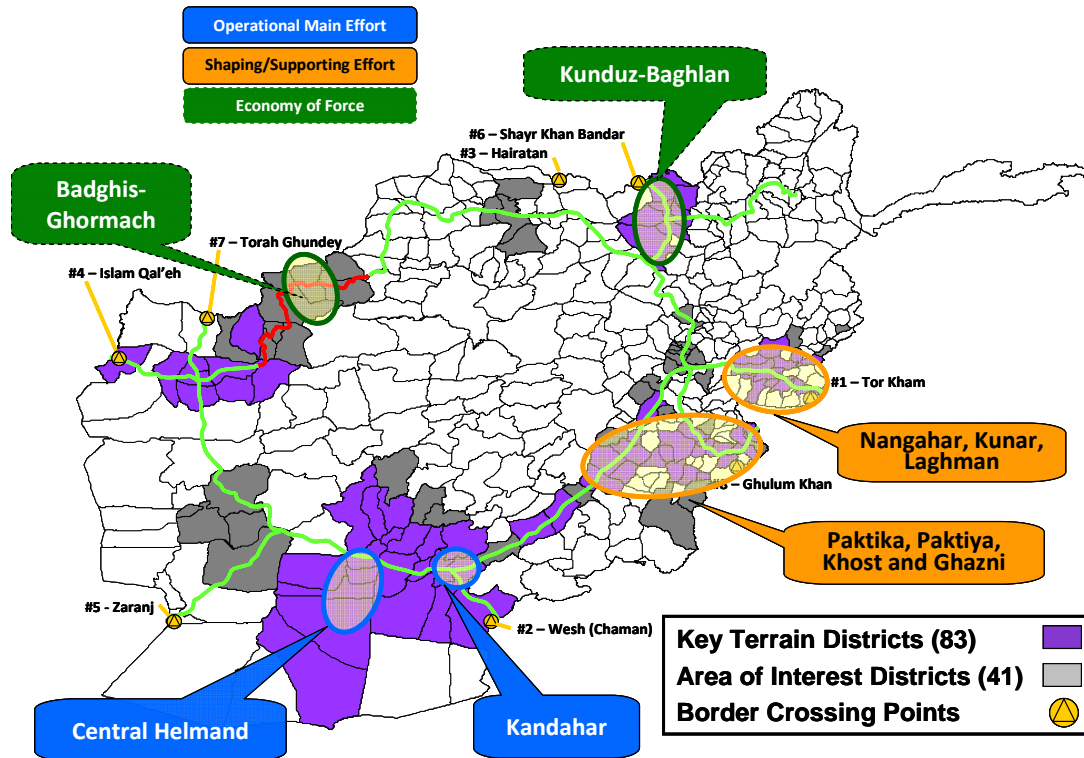

3.3: Operations

3.3.1: Regional Command – East (RC-E)

RC-East operations over the past six months included: building and reinforcing Afghan National Security Forces (ANSF) competence, capacity, and credibility in a partnered effort to protect the population; connecting credible and benign governance to the people; supporting sustainable development; gaining freedom of movement for the Afghan population; and neutralizing the insurgents. RC-E operations are combined and unified, partnered ANSF and Coalition military operations, and collaborative civil-military efforts with U.S. interagency and international partners – civilian, governmental, and non-governmental organizations – at all levels. Through combined and unified action, RC-E increased the Combined Team’s depth of coverage over the populace, reaching out to the district and village leaders. The ANP are the RC-E priority of effort to connect Afghan governance to the populace. Governance and development initiatives are aimed at creating tangible and measurable progress, and they support efforts to improve security and promote sustained stability.

Major operations during the period strived to deny enemy safe havens and staging areas, and disrupt enemy freedom of action. In Nangarhar, Konar, and Laghman provinces, RC-E emphasized improved service delivery, civil training programs, and stability projects in key population centers. RC-E operations improved security conditions for Parliamentary elections

²⁵ As of July 14, 2010, Tagab District was designated “key terrain” bringing the total key terrain districts to 83. The term “focus districts” refers to the 124 key terrain districts plus the area of interest districts.

and protected the southern approaches to Kabul City in the Wardak and Logar provinces. RC-E operations also cleared areas of eastern Ghazni, western Paktika, and western Khowst provinces to set the conditions for the arrival of Force Package 3 forces. Over the next few months, ANSF and ISAF will expand security in Kabul's neighboring provinces of Wardak, Logar, and Kapisa; they will increase their presence in Ghazni and Wardak Provinces to improve freedom of movement along Highway 1; they will extend security through Paktika, Nuristan, and Laghman Province to limit insurgent freedom of movement; and finally they will extend operations in the southern districts of Kapisa to limit insurgent influence in Tagab District.

Combined Team operations against the HQN and the HiG reinforced the credibility of the ANSF and disrupted enemy sanctuaries in eastern Afghanistan. The integration of Force Package 3 into RC-E is expected to achieve improved security effects in Ghazni, Paktika, Nangarhar, and Laghman provinces by December 2010. From April 2009 to April 2010, the numbers of Afghans who reported improved security increased by 20 percent. The Afghan Perceptions and Attitudes Survey conducted quarterly in RC-E since April 2007, with roughly 6,400 samples per survey revealing additional evidence. In addition, during the first half of 2010, more than half the Afghans surveyed perceived security to be holding steady, and nearly one-third of those surveyed reported that they thought security had improved.

During the beginning of this reporting period RC-E completed a relatively seamless Relief in Place and Transfer of Authority, from the 82nd Airborne Division Headquarters, to the 101st Airborne Division [Air Assault] Headquarters. ISAF operations in the East seek to protect the critical infrastructure that supports the eastern lines of commerce into the country from Pakistan, and to provide a screen to reduce the effects of the Haqqani and Taliban networks launching operations out of Pakistan. RC-E operations continued to be partnered with ANSF and to disrupt insurgent leadership and networks. RC-E forces conducted 95 percent of their operations partnered with ANSF, with ANSF in the lead in approximately 18 percent of those operations.

3.3.2: Regional Command – South (RC-S)

Regional Command-South (RC-S) officially split into RC-S and RC-SW on June 14, 2010. This division allowed for more effective command and control and subsequently a concentration of resources on key terrain areas in each regional command. This improvement in unity of command and effort has been a more rational and effective approach to partnered and comprehensive counterinsurgency in both Helmand and Kandahar provinces. Operations in the vicinity of Kandahar City, Afghanistan's second largest city, have been the major RC-S operations in support of Operation Hamkari. Operation Hamkari is steadily beginning to show positive effects in the Arghandab River Valley; along the outer Kandahar City Security Ring Protection Force check points; around the inner city Police Sub-Station check points; and now in the Zharay and Panjwai Districts, west of Kandahar. ANCOP and ANP units are beginning to outnumber the ANA, and ANCOP measures have shifted from clear operations to hold operations with persistent security presence. Casualties have increased because friendly forces are contesting areas with significant Taliban presence and support infrastructure. A secure Kandahar will build the confidence of the Kandahari citizens in their security forces and their government institutions. Since Kandahar City represents a critical population hub for cultural, commercial, and institutional activities in the south, RC-S is modeling operations on RC-C's

successes in Kabul and RC-C. RC-S conducts 100 percent of its operations partnered with ANSF, of which 44 percent are ANSF-led.

RC-S executed ten major operations during the reporting period, emphasizing several priorities: protecting the population; separating the insurgents from the population (physically and psychologically); partnering with the ANSF at all levels; and expanding the authority of the Afghan Government. Shaping operations for Operation Hamkari, the RC-S main effort, showed marked improvement following President Karzai's endorsement of Provincial Governor Wesa's brief on June 12, 2010 and the Shura in Kandahar on June 13, 2010. President Karzai also provided clearer direction to ensure that his cabinet ministers provided support to the Independent Directorate of Local Governance (IDLG)-led Hamkari conference in Kandahar, held on June 21, 2010.

Other operations that support the RC-S main effort in Kandahar city include: improving the freedom of movement for the Afghan population; clearing local insurgent safe havens in the region; pinpointing and neutralizing the insurgent network which threatens and attacks Highway 1; and undertaking key leader engagements with Afghan Government officials to connect more credible governance to the population.

3.3.3: Regional Command – Southwest (RC-SW)

ISAF established Regional Command-Southwest (RC-SW) on June 14, 2010. The new headquarters assumed responsibility for former portions of the RC-S area of operations. To enable the new command structure, the Marine Expeditionary Brigade (MEB) doubled in size and transitioned into I Marine Expeditionary Force (Forward) (I MEF (FWD)), just after the beginning of this reporting period. These forces ultimately grew to 20,000 Marines. I MEF (FWD) continued to operate as Task Force Leatherneck (TF-Leatherneck) under the command and control of RC-S. I MEF (FWD) began to operate as a separate regional command through May, undergoing an assessment phase, which RC-S and the IJC monitored, supported, and validated. At the end of May, RC-S and I MEF (FWD) briefed the Commander, IJF (COMIJC) on their final assessment to confirm that this organization met the criteria to command and control a regional command. On May 28, 2010, the NAC officially recognized the establishment of Regional Command-Southwest (RC-SW), the sixth RC in the Afghanistan theater of operations. On June 1, 2010, Helmand Province, Nimroz Province, and area of operations (AO) Tripoli, consisting of three districts from Farah Province, were officially designated as RC-SW AO with Task Force Helmand (TF-Helmand) in control. COMIJC officially recognized I MEF (FWD) as RC-SW on June 14, 2010.

The creation of RC-SW resulted in improved and focused command and control, which helped establish conditions for the success of Operation Moshtarak. This new command and control architecture also enabled RC-SW forces to mutually support each other in remote areas in Helmand and to the west and south. This arrangement also allows RC-SW and RC-S to build their unique and expanding groupings of "cleared-held-built" districts to connect them ultimately along Highway 1 from west to east. The improved command and control achieved under RC-SW also strengthens those elements' capacities to man and control critical border points through which insurgents, narco-traffickers, and terrorists have traditionally infiltrated. The combined forces under RC-SW have reduced previous insurgent safe-havens in the Central Helmand River

Valley and toward Sangin. The recent rotation of the ANCOF units to RC-SW will further strengthen the ANSF/ISAF security posture and increasingly put Afghan Forces in the lead for sustaining security in and around Helmand Province. RC-SW forces continue to partner most of their operations actively at a one-to-one level, seeing battalions partnered with battalions. During this reporting period, RC-SW partnered 77 percent of all operations, of which 8 percent had Afghan Forces in the lead.

The main effort for RC-SW remains Operation Moshtarak in the Central Helmand River Valley. This operation seeks to extend the authority of the Afghan Government to the previously ungoverned Nad 'Ali District, including the town of Marjah. TF-Helmand and TF-Leatherneck conducted operations to clear lines of communication, interdict insurgents to reduce their influence over the population, and support development and legitimate governance. RC-SW supported two other operations with the purposes of clearing IEDs along lines of communication and targeting the insurgents responsible for emplacing those IEDs in northern Helmand Province. RC-SW also emphasized improving provincial governance and building relationships with the Afghan civilian and security leaders who will ultimately take the full lead in Afghanistan. RC-SW leaders and the Nimroz Provincial Governor travelled to Zaranj to build relationships and to connect the provincial government with the local Afghan leadership. RC-SW implemented measures to counter the movement of illicit materials and drugs. Special Operations Forces and a Light Armored Reconnaissance battalion executed coordinated interdiction operations resulting in the destruction of illicit drugs valued at approximately 135 million USD. This success reduced the insurgents' ability to fund their operations in Helmand Province and disrupted their supply routes through the south-to-north axis in Helmand Province (Barham Chah north to Lashkar Gah).

The ANA 215th Corps' operations in RC-SW have shown steady improvements. The 215th Corps continues to demonstrate planning and leading capability with less partner support. This corps orchestrated two ANA-planned and -led battalion-level operations (Operation OMID DO and Operation OMID SEY) with ISAF coalition mentors and advisors. These operations successfully disrupted insurgent presence and asserted friendly freedom of movement. RC-SW strives to mentor more of these operations to amplify the increasingly credible ANSF capacity and to strengthen the Afghan Government's commitment to provide services and administration on behalf of the Afghan people. RC-SW will continue to increase ANSF-led operations to illustrate Afghan Government capacity and subsequently build confidence among the populace.

3.3.4: Regional Command – West (RC-W)

Regional Command-West (RC-W) operations focused on the critical Herat-to-Iran commerce route, as well as the expansion of security along key areas related to the future construction of Highway 1. The Highway 1 infrastructure project is pending construction. The effects of Iranian influence in the area remain a source of tension and RC-SW will continue to assess this factor. RC-W forces execute 67 percent of their operations partnered with ANSF Forces; 8 percent of these operations see ANSF in the lead.

RC-W conducted seven operations during the reporting period, all partnered with ANSF. The RC-W main effort during this period, Operation SOB BAKHAIR, conducted operations in Bala Morghab and Moqur Districts in Badghis Province to ensure Afghan freedom of movement, with

emphasis on Highway 1. RC-W continued to conduct route clearance operations along main and alternate routes to reduce IED threats in the Bala Morghab security area. RC-W forces conducted supporting operations along Route Lithium to support Afghan freedom of movement and to hold gains in Herat, Ghowr, and Farah Provinces. RC-W efforts also focused on building the Afghan population's confidence in the ANSF. In Ghowr Province operations included civil-military coordination and information operations. In Herat Province operations in the southern portion of the region focused in Zerkoh Valley and the stretch of Highway 1 between Showz and Adraskan.

3.3.5: Regional Command – North (RC-N)

Regional Command-North (RC-N) operations during the reporting period focused on shape-hold-build in the key terrain districts (Pul-e Khumri and Baghlan-e Jadid) in Baghlan Province. The RC-N supporting efforts were in the western portions of its area of operations, tracing the key terrain along Highway 1. RC-N focused on area of interest districts to expand tactical gains achieved in Pastun Kot, Qaisar, Almar, and Ghormach Districts in Faryab Province, and to set conditions for the construction to complete Highway 1. The purpose of these operations was to maintain Afghan freedom of movement in the rural districts of Chahar Bolak and Chintal in Balkh Province, to the west of Mazar-e Sharif.

The RC-N main effort during this reporting period was Operation TAOHID III, which executed comprehensive and partnered COIN in the key terrain districts of Pul-e Khumri, Baghlan-e Jadid, and in Dahanah-ye Ghorri District in Baghlan Province. The purposes of Operation TAOHID III were: to disrupt insurgent leadership infrastructure in the Baghlan-Kunduz corridor near Highway 1 and 3; to shape the operational environment for hold and build operations; to establish freedom of access to the Chahar Darah District in Kunduz Province; and to support provincial-level training of local village security. As a consequence of focused development projects and aggressive key leader engagements, RC-N has observed security improvements west of Kunduz River. RC-N conducts 75 percent of its operations in partnership with ANSF units; 25 percent of those operations are led by the ANSF.

RC-N conducted three other major operations during the reporting period to ensure Afghan freedom of movement, disrupt insurgent command and control, and support local shuras by promoting local and regional governance and providing local infrastructure development. The capacity of RC-N to provide security improved with the addition of another BCT during this period. This brigade conducted partnered operations with the Afghan Uniformed Police in the Ghormach and Qaisar area of interest districts in Faryab Province; it has also partnered with the ANA 1st Brigade of the 209th Corps, which repositioned to cover the Maimanah and Ghormach Districts. ISAF/ANSF operations were executed to improve freedom of movement and to create security conditions favorable to the completion of the Highway 1 Ring Road project.

During this period, RC-N improved its capacity and methods for disrupting insurgent support operations and interdicting Taliban leadership infrastructure. RC-N also expanded the scope of partnered operations with ANSF and continued to strengthen security toward increasing Afghan freedom of movement. RC-N will continue to encourage provincial leaders and district village elders to support the initiatives for establishing Afghan Local Police where appropriate.

3.3.6: Regional Command – Capital (RC-C)

Regional Command-Capital (RC-C) continued to develop a security model that could be applied in other regions of Afghanistan. The Afghans in RC-C increasingly have confidence in the ability of the Afghan Government and the ANSF to sustain a relatively secure environment for the people of RC-C. Operations in Kabul Province are joint ANA and ANP operations. These operations involve combined MoD, MoI, NDS, and ISAF planning and preparation with combined ground and air reconnaissance and security patrols, as well as the integration of ISAF and Coalition shaping operations to disrupt and interdict insurgent network planning and attack threats against the capital. Combined ANSF effort in Kabul performed notably well in supporting the April 2010 Peace Jirga, the July 2010 International Kabul Conference, and the September 2010 Parliamentary elections. Although insurgents did attempt attacks against these venues, security at these events was generally a success. RC-C conducts 100 percent of its operations partnered with ANSF who lead operations in all but one district, and insurgent attack levels have generally gone down in recent months. In the months ahead ISAF troops are likely to thin out in some Kabul districts, enabling the expansion of clearing operations by ISAF into Sarobi District.

3.4: Afghanistan – Pakistan Regional Cooperation

The Pakistan Military (PAKMIL) operational main effort during the first half of the reporting period centered on operations in Orakzai, in the FATA. The PAKMIL reported clearing 60 percent of the geographical area before they shifted to stabilization operations, which continue. Clearing operations continue in Bajaur, Mohmand, and South Waziristan, but the PAKMIL primary effort shifted during the reporting period to flood relief operations. Despite changing priorities, PAKMIL cooperation and coordination with Afghan and ISAF Forces continues to improve. The PAKMIL Frontier Corps maintained a presence along Afghanistan's southern border to complement ISAF and ANSF operations in southern Afghanistan.

Approximately 60,000 PAKMIL troops have supported flood relief operations. Although the PAKMIL reports no diversion of resources from COIN operations, the large commitment of troops, helicopters, and boats have slowed the pace of counterinsurgency operations. On September 4, 2010 the AAF completed a 27-day humanitarian mission to neighboring Pakistan. The AAF accomplished 401 sorties with four Mi-17s assisting those endangered by regional flooding, with 1,904 persons transported, including 120 actual rescues and 188.5 tons of aid moved. Pakistan Flood relief was the first independent effort by the fledgling AAF.

Tripartite cooperation between the ANSF, ISAF, and the PAKMIL was strengthened with several important cross-border, military-to-military visits designed to share information and strengthen coordination efforts. A Tripartite Military Intelligence Sharing Working Group was held at the PAKMIL General Staff Headquarters in Rawalpindi, Pakistan on June 8, 2010, with a Campaign Coordination Planning Conference conducted at the IJC in Kabul on June 10, 2010. The follow-on August 9, 2010 Tripartite Conference, held at ISAF Headquarters in Kabul, reaffirmed the parties' commitment to enhance border security and management. Meeting topics addressed the following: developing procedures for responding to cross-border insurgent activity; encouraging decentralized decision-making; strengthening relationships and sharing

intelligence and information to counter the IED threat; improving cooperation on biometric collection; and maintaining transparency in military operations near the border. The conference attendees also pledged to deny insurgents the use of the border region and to share counter-insurgency best practices.

Most recently, in mid-September President Karzai and COMISAF travelled to Islamabad to meet with General Ashfaq Kayani, PAKMIL Chief of the Army Staff. The meeting reinforced mutual support and the need for collaboration to secure both countries. Concerns about insurgents along the border, acknowledgment of extensive PAKMIL operations, and the need to further develop trade between the countries dominated the meeting.

3.5: Population Security

Security remains tenuous and still needs considerable improvement in many areas. Progress is slow and deliberate. The security gains this period have resulted from persistent and effective combined coalition and ANSF operations focused primarily in the south and the east, but also in select areas in the north, west, and capital regions. Security forces have made progress moving violence away from the population and expanding security regions. Operations in Central Helmand Province focused on tightening the security ring around the Kandahar City security zone in southern Afghanistan. Operations in the east continue to disrupt insurgent activity and support the extension of governance and development. The U.S. force increase continued through the end of the summer and additional pledged NATO coalition forces will continue to arrive in theater through October 2010. The continued force uplift and ongoing ANSF force generation will continue to build upon efforts started in July 2009 in the Central Helmand River Valley.

The proportion of the population residing within the 124 key terrain and area of interest districts living in areas rated as “satisfactory” remains relatively unchanged over the past three quarters, (a “satisfactory” rating comprises the highest two rating levels, “Secure Environment” and “Occasional Threats.”) The map in Figure 10 below depicts the current ratings of the 124 key terrain and area of interest districts as assessed by IJC. The arrows indicate districts that have increased to or decreased from a rating of “satisfactory” compared to June 2010. In RC-East, three districts’ ratings decreased from June to September 2010. In particular, the Nawah ye Barakzai district in RC Southwest improved its security rating.

Figure 10: District-level Security Assessment (September 2010)²⁶

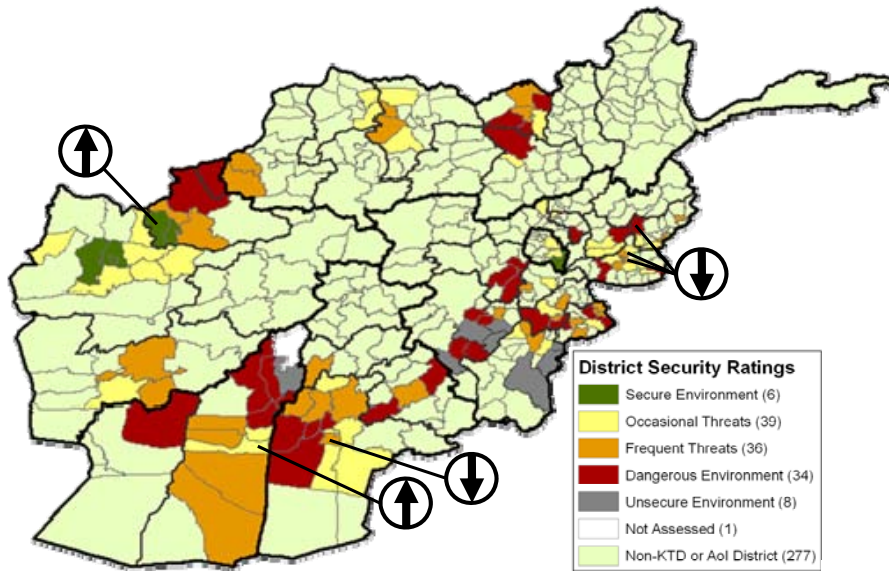

The map shows the 02 September 2010 security district assessment results. The arrows indicate positive or negative change compared to the 18 March 2010 security district assessment. The change captured in the above figure is a district that changed to or from a “satisfactory” rating. A “satisfactory” rating is equal to green (secure environment) or yellow (occasional threats).

Positive perceptions of security have declined since the March 2010 Nationwide Survey, as shown in Figure 11. The number of Afghans rating their security situation as “bad” is the highest since the nationwide survey began in September 2008. This downward trend in security perception is likely due to the steady increase in total violence over the past nine months.

Figure 11: Afghan perceptions of security (September 2010)²⁷

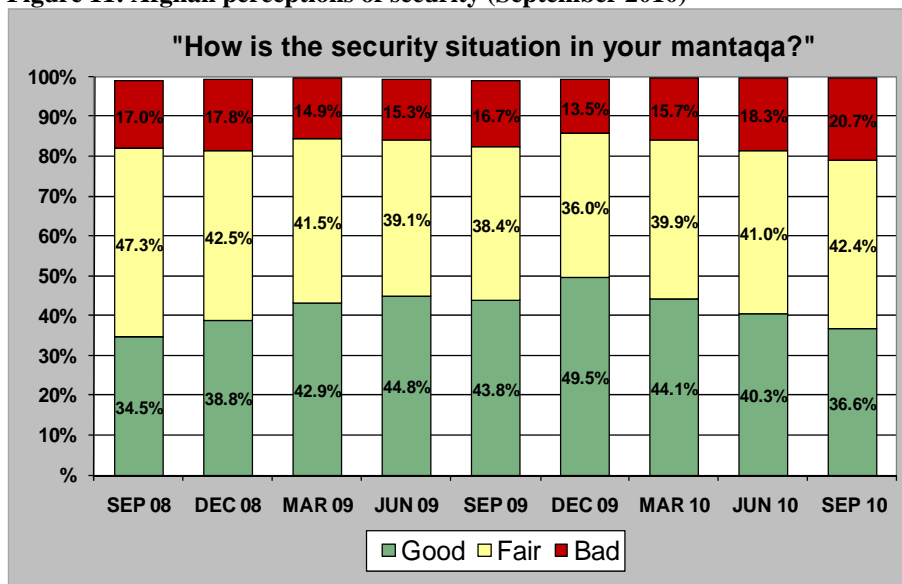

²⁶The map is a quick summary of where net change occurred. There were more changes than shown on the map; the circles represent a net change, positive or negative, comparing RCs.

²⁷ Afghanistan Nationwide Survey, September 2010.

3.6: Violence and Kinetic Events

One indicator for illustrating violence levels is kinetic events (KEs).²⁸ Total kinetic events increased nearly 55 percent over the previous quarter and 65 percent compared to the third quarter, 2009, as Figure 12 below indicates. The overall increase was driven primarily by increased incidents of direct fire. Insurgent-initiated attacks also increased this quarter by over 60 percent, and direct fire attacks comprised the majority of this increase. The rise in violence is partly attributable to the increase in Coalition Forces and ANSF as well as greater operational tempo. The sharp increase in insurgents' use of direct fire attacks may be significant, as it suggests capacity limitations for the insurgents. During the second quarter of the reporting period, over 90 percent of all kinetic events occurred in RCs South, Southwest, and East as shown in Figure 13.

Figure 12: Total Weekly Kinetic Events (July 2008 - September 2010)²⁹

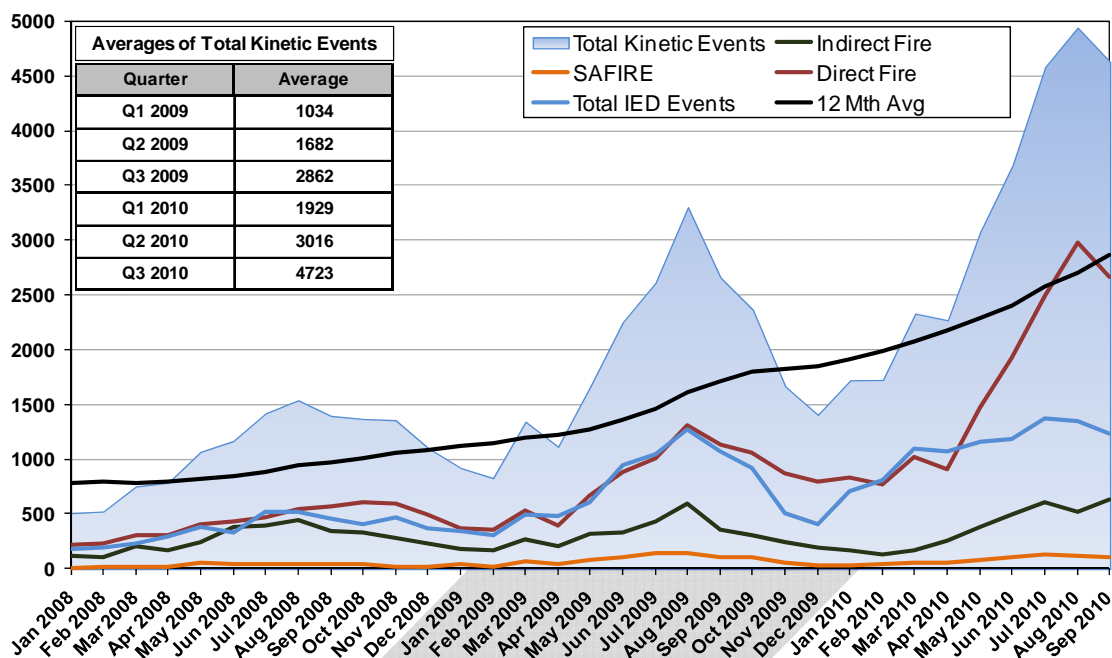

Kinetic Events (KE) include Direct Fire (DF), Indirect Fire (IDF), Surface to Air Fire (SAFIRE), Improvised Explosive Device (IED) events. IED events comprise IED exploded, IED found/cleared, mine strike, mine found/cleared, and turn-ins.

²⁸ Kinetic activity is defined as the "IJC Kinetic Activity" option as found in the ISAF-Secret Combined Information Data Network Exchange (CIDNE) database. This includes: direct fire, indirect fire, SAFIRE (surface-to-air fire), IED explosion, IED found/cleared, IED hoax, Mine found/cleared, Mine strike, own goal, and premature detonation.

²⁹ Data from Afghanistan Mission Network (AMN) CIDNE and ISAF CIVCAS Database, as of October 2, 2010.

Figure 13: Monthly kinetic incidents for 2010 by type and location³⁰

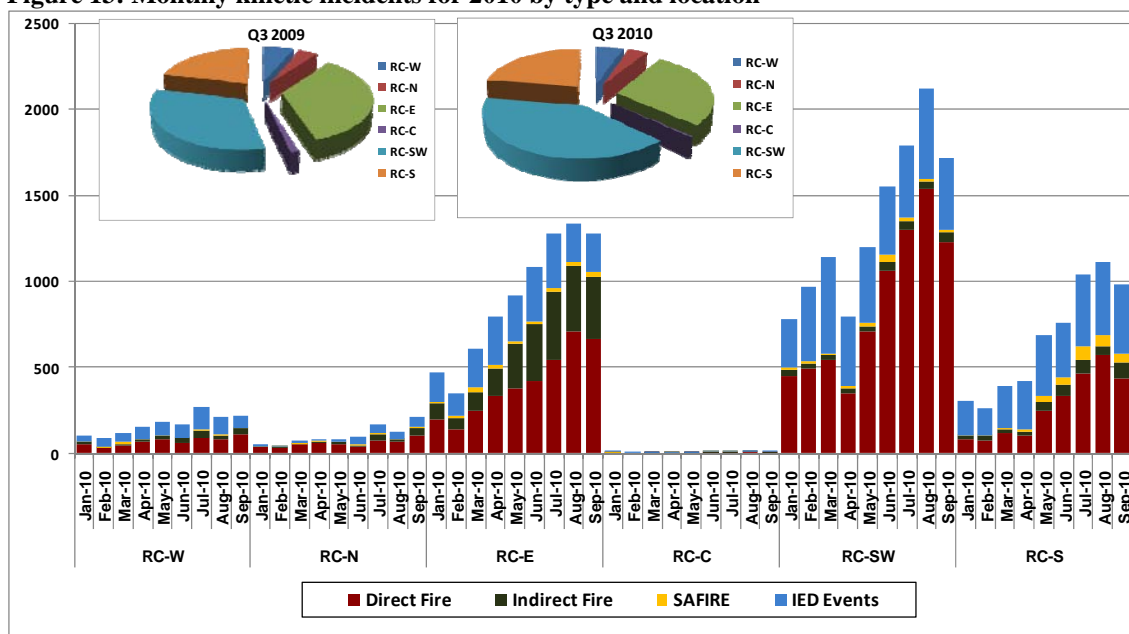

Moreover, seasonal patterns observed during the last few years suggest a correlation between increased violence and the end of the poppy harvest season. Another trend is the increase in insurgent activity before high-profile events such as the Presidential election in August 2009, the Consultative Peace Jirga in early June 2010, and the Parliamentary elections in September 2010. The number of coalition forces on the ground has increased by 37 percent this year compared to last year.

3.6.1: Improvised Explosive Device (IED) Events

IEDs continue to pose a significant threat to U.S. and Coalition forces in Afghanistan. Although IEDs constitute approximately one-third of kinetic attacks over this reporting period, they account for nearly 60 percent of coalition and half of Afghan Security Force casualties.³¹

As with all kinetic incidents, IED trends show seasonality, as illustrated in Figure 14 below. Comparison of IED events is more relevant when data is viewed relative to the same period over the previous year. This spring and summer, increased Coalition security operations in Helmand and Kandahar Provinces, coupled with steady levels of activities in other regions, likely contributed to the overall increase in IED events. This spring there was twice the number of IED attacks during the same period last year. IED attacks represent approximately 25 percent of all kinetic activity during this period, although they increased at a much lower rate than direct fire during the reporting period.

³⁰ Data from AMN CIDNE, as of October 2, 2010.

³¹ Kinetic attacks refer to direct fire, indirect fire, IED events, and surface-to-air fire incidents.

Figure 14: IED Events (January 2009 - September 2010)

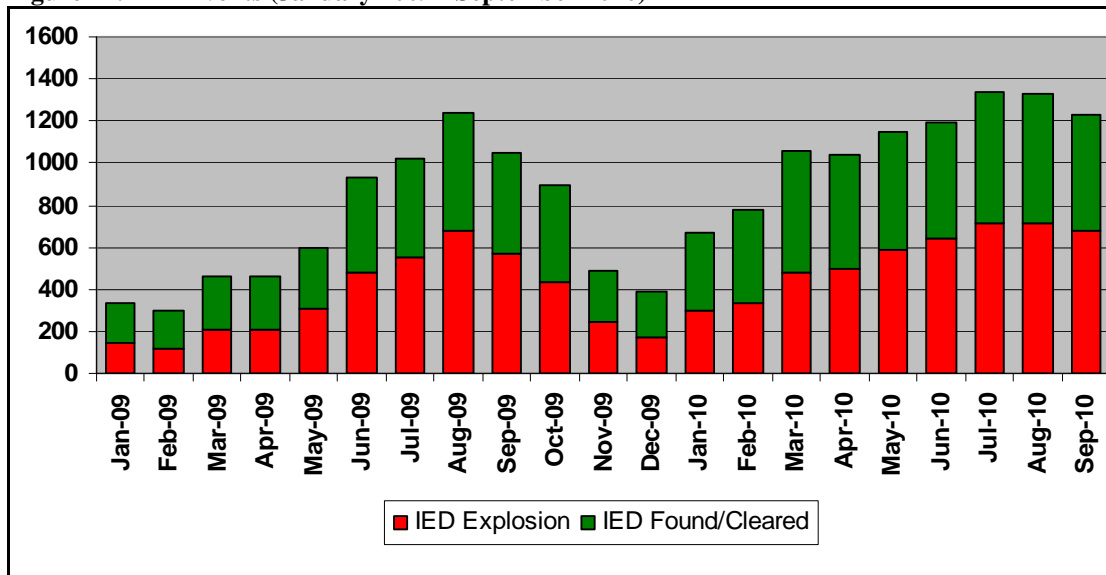

Table 7 below shows IED activity within each regional command. The majority (89 percent) of IED events take place in three commands – East, South, and Southwest. Although the number of IED events in RC-East was higher than the previous six months, the number of IED incidents in that region was nearly 9 percent lower than the same period a year ago. In RC-South and Southwest, IED incidents are higher than they were a year ago, as Coalition and Afghan Security Forces conduct clearing operations in areas previously occupied by insurgent forces. IED events in RC-West and North are also higher from the previous six months, consistent with seasonal norms, but are higher for the same period a year ago. Due to increased security, IED events in Kabul were substantially lower than the totals in April – September 2009.

Table 7: IED Events (April 2010 - September 2010)

	IED Explosion	IED Found /Cleared	Other	Total IED
RC-East	791	636	114	1541
RC-South	947	1005	105	2057
RC-Southwest	1321	1068	32	2421
RC-West	241	240	27	508
RC-North	104	72	16	192
RC-Capital	12	13	3	28
Total	3416	3034	297	6747

[Refer to classified annex for additional information.]

3.7: Civilian Casualties (CIVCAS)

A theater-wide emphasis on best-practice COIN fundamentals, which emphasized population protection and judicious use of lethal force, resulted in a reduction of CIVCAS attributable to Coalition forces. Before 2009, civilian casualties caused by air and SOF alienated the local populace and fueled the insurgency. ISAF and its Coalition partners recognize that civilian casualties can undermine efforts to protect the population and create durable security and governance.

Beginning with the August 2009 tactical directive, and continuing with General Petraeus' 2010 Counterinsurgency Guidance and Tactical Directive (Rev 2), forces operate under an imperative to reduce ISAF-caused civilian casualties, while still providing for their own protection. The trend line for 2010 in the figure below manifests a decreasing trend in ISAF caused civilian casualties during a sample 12-week period, compared to the same time period during 2009. ISAF and coalition forces have experienced a reduction in civilian casualties in spite of a spike in total violence during the summer fighting season. Insurgent-caused CIVCAS increased during the summer months, in line with the seasonal violence trends. Figure 15 illustrates the total number of ISAF-caused civilian casualties during this reporting period. The drop in CIVCAS compared to last year is attributable to both ISAF and insurgents. Insurgent-caused CIVCAS from direct fire doubled during the second half of the reporting period compared to 2009, which is likely due to insurgent shift in TTPs to a much greater use of direct fire.

Figure 15: Weekly CIVCAS versus Security Incidents (July 2008 - September 2010)³²

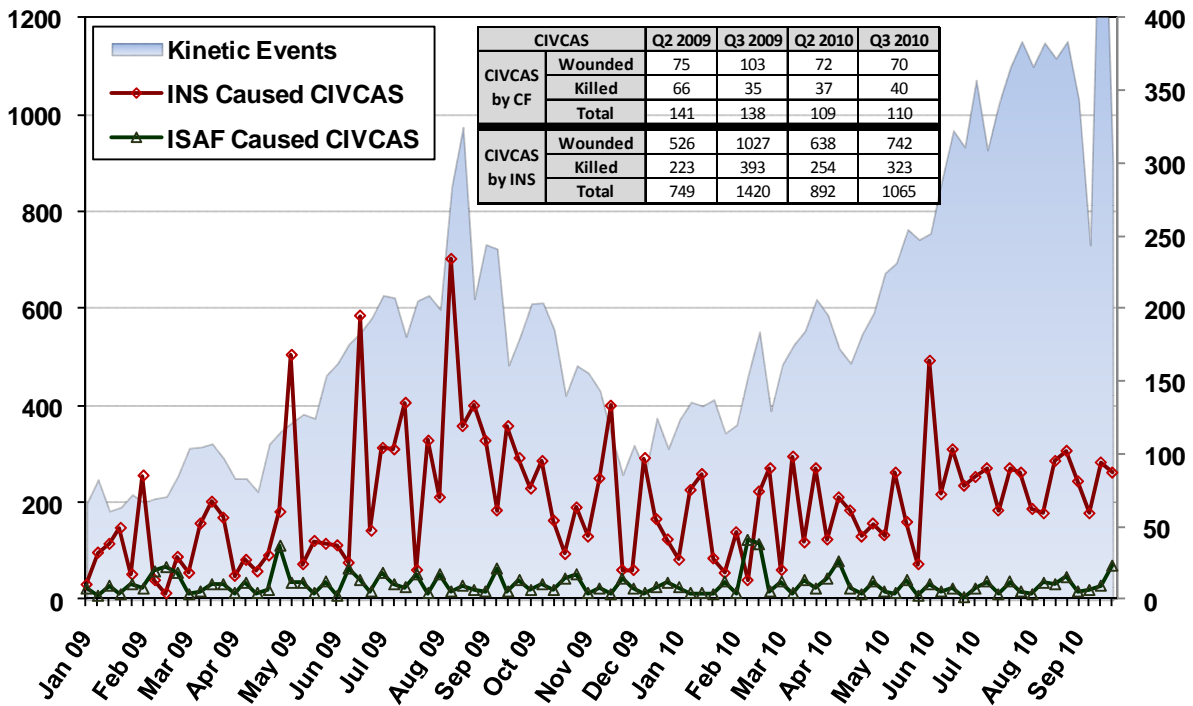

Data indicates that ISAF continues to make progress in the effort to minimize CIVCAS.³³ Despite the rise in kinetic activity, troop levels, and operational tempo, ISAF is proportionally hurting fewer civilians per kinetic event, confirming the trend of the previous quarter.

³² Data from AMN CIDNE and ISAF CIVCAS Database, as of October 2, 2010.

³³ Civilian Casualty (CIVCAS) data is taken from the HQ ISAF CJ3 CIVCAS Database, dated October 2, 2010.

Section 4 – Governance

Bringing sub-national governance across Afghanistan is a slow, challenging process. Low levels of literacy, limited educational opportunities, competition from international aid organizations (which offer much higher salaries to educated and experienced Afghans than the government can afford), and widespread corruption complicate efforts to recruit, train, and retain quality personnel. Poor inter-ministerial coordination and the slow appointment of key cabinet and governorship offices limit effective governance.

4.1: Sub-National Governance Policy

The Sub National Governance (SNG) Policy establishes a framework for instituting government reforms over the next 15 years.³⁴ The framework was developed jointly by the Independent Directorate of Local Governance (IDLG) and the United Nations Assistance Mission to Afghanistan (UNAMA). Individual elements of the plan will be tested before implementation and will be introduced gradually. The implementation plan has four basic components:

1. **Laws, regulations, and guidelines** - To implement the policy fully, six new laws must be drafted, 22 laws amended, 10 regulations revised, and 17 new regulations drafted. A commission has been established by the Ministry of Justice (MoJ) to review proposed legislation before they are forwarded to the Cabinet for approval.
2. **Programmatic intervention** - A government-wide program review will ensure that existing governance and development initiatives, such as the National Solidarity Program and the Afghan Social Outreach Program, align with the new SNG policy. The review will include donor-funded programs.
3. **Sub-national planning and finance** - The MoF, in coordination with the international community and other government ministries and agencies, will define the funding needed to implement all the conditions of the new policy successfully. In addition, a Cabinet committee on Sub-national Planning and Finance, chaired by the Vice President, will be created, and will meet three times a year to review implementation progress from a financing perspective.
4. **Municipal governance** - A key component of the SNG policy reform will be to draft a new “Municipal Law” to define the governance role of Afghanistan’s existing 153 municipalities, with emphasis on their responsibilities in delivering basic services to urban populations.

The policy is complex and ambitious, and it will place a significant burden on leadership and accountability within the Afghan Government. In addition, SNG implementation will focus attention on the MoJ, which will be expected to expand and enhance rule of law institutions,

³⁴ On March 22, the Sub National Governance (SNG) Policy was signed by President Karzai. The intent of the new policy is to change the administrative structures in Afghanistan in ways that will make the central government in Kabul and its representatives more accountable to citizens by formally sharing authority—including the power to develop and execute budgets—with provincial and district officials.

particularly in key terrain districts and associated municipalities. Finally, the SNG Policy will test the ability of the IC and Coalition forces to work together in the areas of building governance and the justice sector because of the relatively low level of capacity and expertise applied toward these two sectors across the community.

4.2: Assessment of Governance

The September 2010 assessment of governance in the 124 focus districts shows that 38 percent of the population live in areas rated as having “emerging” or “full authority” Afghan governance. This reflects no substantial change since March 2010. An important aspect of progress in governance is the people’s perception of improvement. The latest nationwide survey shows that 48 percent of Afghans polled believe that Afghanistan is heading in the right direction.³⁵

The main deficiencies in key terrain district governance remain corruption, lack of education/training of government officials, and lack of appropriate funding of districts. Of note, the IDLG has initiated the transition of approximately 180 district governor positions and 14 Deputy Provincial Governors as part of the implementation of its sub-national governance policy. Transition will require the establishment of a transparent, merit-based hiring process, and the creation of a civil service cadre that should improve local governance.

Many public officials in Afghanistan are ill prepared for their roles, although the Afghan Government and IC are attempting to address this problem. Training programs by the European Union (EU), the Afghanistan Stabilization Initiative (ASI), and the Afghan Government are ongoing in different districts at the moment. RC-East has made progress in developing civil servant capacity in Sar Kani, which has already been discussed in previous reports.³⁶ In addition, the Afghan Government is investing substantial resources in programs (84 million USD in 2010) with signs of progress visible in locations such as Herat District. The Afghanistan Civil Service Institute (ACSI), in particular, is very active, training civil servants throughout the country, currently focusing in Zabul, Kandahar, and Logar Provinces. The ACSI offers courses on various topics including financial management, project management, procurement, human resources, and strategic planning.³⁷

The lack of available government personnel hinders district governors from filling tashkils. Although not enough data is available to accurately assess the level of fill for governance tashkil in Afghanistan, a lack of line ministry and other personnel is indicated in RC reports (eight key terrain districts out of 83 reports this problem).³⁸ Only 15 key terrain districts have an assessed tashkil, and of those, only three can show a tashkil fill of over 50percent (Injil and Herat in RC-West and Marjeh in RC-South). This is particularly true in districts where the security situation is dangerous and officials appear reluctant to accept positions due to the hazards. The IDLG is an incentive pay program to reduce vacant positions in dangerous areas. Funding and work

³⁵ ISAF Nationwide Survey, September 2010.

³⁶ IJC AAG OAR 4th cycle: “The lack of training is being addressed in seven districts in RC-South and RC-East by the Afghanistan Stabilization Initiative (ASI) and other education programs for government officials. SAR KANI, an Area of Interest district in RC East that has benefited from these programs, has improved its governance since the last cycle. Although not statistically relevant, this success might indicate significant potential for these programs. Further developments in other districts receiving ASI programs will be watched carefully in order to assess the actual effectiveness of this program”

³⁷ Governance and Development Information Summary; June 12, 2010.

³⁸ RCs Assessment Working Group and Commander’s Update Assessment slides.

conditions are also problematic. In many districts even the basic facilities are missing and it is very difficult to start expensive projects without proper funding. As many as six key terrain district assessment reports highlighted the lack of facilities for government offices as a problem.³⁹

Security still limits the development of governance capacity. Efforts are underway to assess and improve freedom of movement for Afghan personnel and goods along the national road network. Increased freedom of movement will enable elected officials to operate effectively within their district and to facilitate economic growth through commerce and exchange.

4.3: Rule of Law and Justice Reform

Progress is slow in the justice sector. Extensive work is needed to improve the Afghan Government’s ability to provide rule of law and justice to the Afghan people. The latest survey of Afghan perceptions of the Afghan Government’s rule of law capacity (see Figure 16 below) shows an almost 7 percent decline in Afghans’ confidence in their government’s ability to deliver reliable formal justice. This is likely due to continued corruption and to the slow progress in hiring and placing justice professionals at the provincial level. Additional polling shows that fewer than half of Afghans polled trust the Afghan Government to settle a legal dispute.⁴⁰

Figure 16: Afghan Confidence in Afghan Government Rule of Law Capacity

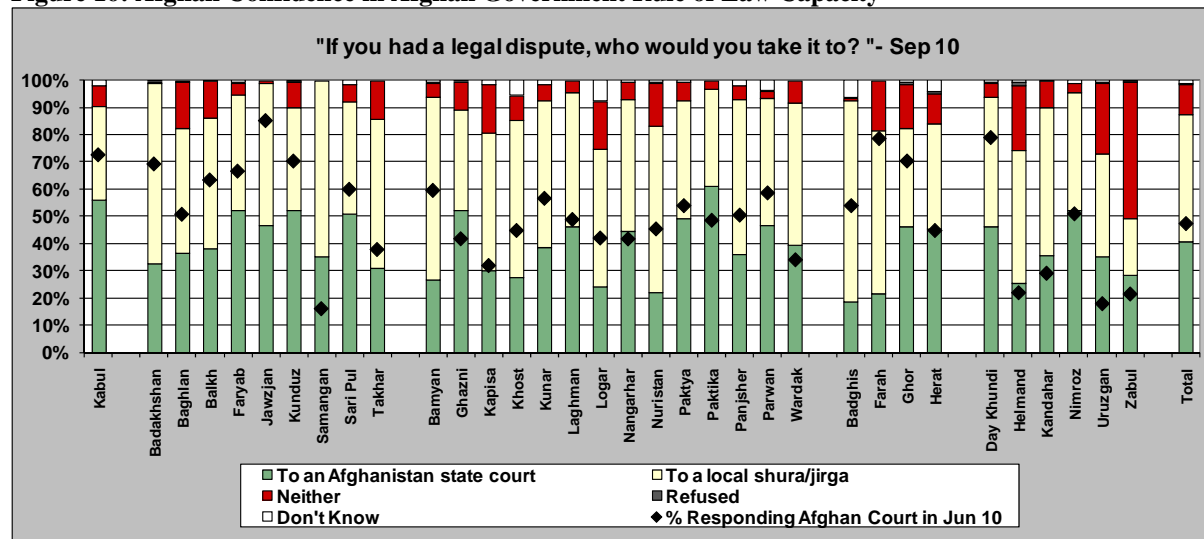

The Afghan Government still has not met its Rule of Law commitments from the London Conference. Specifically, the MoJ has abandoned plans to develop the promised national policy on relations between the formal justice system and dispute-resolution councils and instead has formed a committee to draft a new law. In addition, despite ambitious intentions, the Afghan Government still lags in implementing key legislative and administrative reforms: the enactment and implementation of the Criminal Procedure Code is still pending; the Taqin (legal review)

³⁹ RCs Assessment Working Group and Commander’s Update Assessment slides.

⁴⁰ Afghanistan Nationwide Survey, September 2010.

department lacks the capacity to cope with its workload; and despite promised initiatives, the outreach of the justice system has not improved over the reporting period.

Over the past quarter, the number of lawyers registered with the Afghan Independent Bar Association (AIBA) continued to rise—to a total of 781 lawyers in 25 provinces, an increase of 17.3 percent. The MoJ also took steps to increase the efficiency of the legal aid process by setting up a board under the ministry’s Legal Aid Department; the board will coordinate with AIBA to ensure the provision of pro bono cases. Both the increase in lawyers and the creation of the new board are first steps towards strengthening legal aid capacity, which has generally been provided across Afghanistan by non-governmental organizations (NGOs).

4.3.1: Land Reform

Land disputes and property rights are central issues on which Afghans seek resolution, predominantly from informal justice mechanisms. USAID has assisted the Afghan Government in the transfer and documentation of land ownership for 1.5 million Afghan citizens in informal settlements around Kabul, Mazar-e Sharif, Kunduz, and Taluqan. In addition, U.S. Government support of the National Land Policy, approved in 2007, has aided the Afghan Government in streamlining land registry offices in 21 provinces. A land survey and mapping curriculum at the Kabul Polytechnic University will also assist in creating Afghan capacity to record and resolve disputes over land.

The Land Reform in Afghanistan (LARA) project is valued at up to 140 million USD over five years and dedicated solely to land market reform. USAID will continue to reduce corruption in land transactions by informing citizens of land processes and procedures, by eliminating unnecessary steps and delays in land transactions, and by establishing a legal and regulatory framework for land administration. Increased cooperation with the Supreme Court streamlined the registration of immovable property from 34 steps to just three and four for urban and rural land, respectively.

In July, the Afghan Government announced a pilot program to establish a single point of authority for land management. The Afghan Land Authority (ALA), founded in 2009, will be responsible for revising and simplifying land laws; surveying, mapping, and inventorying government land; and then opening a transparent “one-stop-shop”, both online and at offices across Afghanistan, for potential investors. With a common inventory of land available via the ALA, farmers can acquire deeds to their farmland and seek advice on what crops are best suited for their land. The land inventory will identify unused government land. This available land can then be sold to investors to use for economic enterprise, in turn generating revenue and taxes.

The ALA pilot phase will run through 2013 and will be established first in secure areas of the country. ALA is expected to merge with the Afghan Geodesy and Cartography Head Office and become responsible for the newly mandated Land Usurpation Board. The Afghan Government is currently requesting support from the USAID-funded LARA program to assist with execution of ALA in late 2010.

4.3.2: Combined Joint Interagency Task Force (CJIATF)-435

The CJIATF-435 was formed under the Commander, U.S. Forces-Afghanistan (USFOR-A) to assume responsibility for detention operations from the United States. CJIATF-435 aligns Operation Enduring Freedom (OEF), USFOR-A, and ANSF detention procedures from point of capture to release and/or reintegration, in order to facilitate the partnered development of a consolidated Afghan Government owned process. To reduce the strategic vulnerability that detention operations can create, success requires increasing confidence of Afghan citizens and the international community that the U.S. and the Afghan Government detainee operations are humane, legal, legitimate, and necessary to defeat the insurgency. Transitioning detention operations to the Afghan Government and assisting the government to strengthen their judicial system are steps required to ensure Afghan sovereignty. At present, we must fully partner the collective forces of contributing nations with the Government of Afghanistan to develop a comprehensive, Afghan-led, Afghan-owned process.

After reaching initial operational capability in January 2010, CJIATF-435 conducted the first “post-release shura,” in which former detainees from the Detention Facility in Parwan (DFIP) were brought to Kabul to illustrate lessons learned with the reintegration process. Former detainees were able to express their views and a survey was conducted among them to determine their level of contact and interaction with tribal elders, members of sub-national governance, and the ANSF.⁴¹ Overall results of the survey were mixed, with former detainees indicating positive and frequent contact from tribal elders and sporadic to negligible contact from members of sub-national governance. The current recidivism rate is 1.2 percent. CJIATF-435 assesses that reintegration programs are working to prevent previously detained individuals from rejoining the insurgency.⁴² However, disparities in economic activity and high unemployment remain a concern. The Detention Review Board process appears to be successful in separating non-threats and the reconcilable from the irreconcilable.

In spite of slow growth and development of the Afghan Correction Officer’s (ACO) Brigade, CJIATF-435 remains committed to begin transitioning DFIP to Afghan control on January 1, 2011. The ability to field a capable ACO Brigade has been impeded by officer and NCO shortfalls, attrition, and absence rates amongst junior enlisted personnel. Current manning remains low with only 72 percent of required positions filled. Partnered U.S. units are acting to mitigate risk to future DFIP transition and are crafting solutions to address ACO Brigade leadership deficiencies.

The Biometrics Order was signed on June 28, 2010, by the Minister of the Interior (acting), allowing Task Force Biometrics to hire 1,000 Afghans to support the ministry’s enrolment efforts. These Afghan enrollers will be trained and equipped with biometrics collection equipment to support accelerated enrolment at all 14 main ports of entry, within specific key terrain districts and areas of interest. They will support key programs, such as the driver’s license program. Human intelligence reporting and engagement with local nationals was positive, indicating Afghan support for the program. The total number of enrolments, as of June 30, 2010 was 922,415, with 107,294 enrolled this quarter.

⁴¹ An informal survey was conducted at the post-release shura.

⁴² Specific programs include: literacy and education in basic subjects, religious training, and vocational education (e.g., agriculture, sewing, and baking).

On June 8, 2010 four Afghans were convicted of being directly involved in or facilitating IED activity. The case was heard by the Justice Center in Parwan and biometrics data retrieved from IED components, specifically fingerprint data, proved critical in securing the conviction. This marks a major milestone for the facility. Additional judges, prosecutors, and investigators are required to build a self-sustaining capability.

4.3.3: Anti-Corruption Efforts

Corruption continues to have a corrosive effect on ISAF efforts in Afghanistan. Afghan perceptions of injustice and the abuse of power fuel the insurgency in many areas more than the Afghan Government's inability to provide services do. To further address concerns regarding corruption, COMISAF established the CJIATF-Shafafiyat ("Transparency"), in coordination with the IC and in support of the Afghan Government, to foster a common understanding of the corruption problem in Afghanistan, plan and implement ISAF anti-corruption efforts, and integrate USFOR-A anticorruption activities with those of key partners. The organization will focus on identifying how corrupt activities and organizations undermine the security situation and on coordinating anti-corruption efforts, with the objective of reducing corruption so that it does not continue to undermine the Afghan Government.

CJIATF-Shafafiyat achieved an initial operational capability in late August and anticipates full operational capability in October 2010. The task force will integrate intelligence with planning, operations, engagement, and strategic communications. Shafafiyat will help integrate military intelligence and law enforcement information and evidence to map criminal patronage networks and generate a common understanding of the problem. The organization will use CJIATF-Nexus (CJIATF-N) in Kandahar for intelligence analysis and will also initiate or advocate for adjustments in intelligence collection, intelligence databases, and reach-back analytical capability to improve visibility on the corruption problem.

The task force will incorporate the ongoing efforts of Task Force Spotlight (Private Security Company-focused) and Task Force 2010 (linking contracting with the desired counter-insurgency effects). U.S. and other international contracting agencies must ensure that contracts that inadvertently enrich powerbrokers, criminals, and insurgents are severed and not renewed. Companies enmeshed with these actors must be suspended and debarred. Contracting expenditures represent a powerful tool in the anti-corruption fight, and U.S. and international contracting agencies must be pushed to look beyond cost, schedule, and performance and to focus most intently on the impact of select contracts on the counterinsurgency effort and on Afghan perceptions regarding the credibility of the Afghan Government.

The September 2010 survey shows that 80.6 percent of Afghans polled believe corruption affects their daily lives.⁴³ This is consistent with the view that corruption is preventing the Afghan Government from connecting with the people and remains a key reason for Afghans supporting the insurgency.

⁴³ ISAF ANQAR nationwide survey, September 2010.

The Executive Order (hukum), signed on May 9, 2010 by President Karzai, supplements the anti-corruption powers set forth in the Presidential Decree (ferman) signed on March 18, 2010. These decrees are intended to strengthen the powers of the High Office of Oversight (HOO) and provide important legal reforms to counter corruption in Afghanistan. Despite the success of having the Executive Order signed, it must be noted that the text changed at the last minute and a number of clauses were added that weaken the capacity of this directive.⁴⁴

Afghan Government intentions to combat sub-national governance corruption remain unclear. In the month of May, there were only 18 changes of officials throughout Afghanistan, only four of which openly involved corruption or other criminal activity. This suggests that the burst of changes in April, which included a number of removals of government officials for crime-related issues, were not due to the start of a major effort on the part of the Afghan Government, as it might have seemed at the time, but probably only a reorganization of local governance (many of the April changes took place in Helmand Province due to pressure by Provincial Governor Mangal).

In the month of June, 40 key leader changes took place. Of those changes, 22 were caused by IDLG routine shuffles. Criminal activities or corruption, resignations to join Parliamentary elections, or death of involved officials made up the remaining changes. Of the eight changes caused by criminal/illicit activities, only two were prosecuted by central Afghan Government agencies, while the others were addressed by higher ranking officials or local police agencies.⁴⁵

Since its inception, the Anti-Corruption Unit (ACU) has referred 203 cases to the Anti-Corruption Primary Court, of which 84 cases have reached a verdict (the vast majority convictions.) There were 151 cases under investigation before the ACU was shut-down in September by order of the Attorney General as a result of the indictment and arrest of Mohammad Zia Salehi. The recent investigation and arrest of the Head of Administration of the Afghan National Security Council, Mohammad Zia Salehi, is of particular concern. The investigation and arrest were completely Afghan-led and conducted by the Sensitive Investigative Unit (SIU) with limited support from the Major Crimes Task Force (MCTF). The Afghans arrested Salehi after allegedly compiling solid evidence that he had accepted a bribe in exchange for his official influence. Upon learning of his arrest, President Karzai ordered his release and demanded two separate investigations of the MCTF for illegal activities and violations of Salehi's human rights. While neither investigation found evidence of wrongdoing by the MCTF and Afghan officials continually profess respect for the organization, Karzai seems to be taking steps to reign-in their activities. This may include bringing the MCTF under palace authority or forcing it to submit to MoJ oversight. In addition, the use of polygraphs as a vetting tool and salary enhancements for Afghan prosecutors and judges in these units ceased following the arrest. For several weeks DoJ mentors were refused access to Afghan prosecutors in the ACU.

The HOO began publishing the asset declarations of senior officials, following commitments made in January, however far fewer than expected have been completed or published. The declarations have only been published in an official Kabul gazette despite encouragement from

⁴⁴ IDC governance and development information summary, May 12, 2010.

⁴⁵ IJC Key Leaders scorecards.

the IC to publish them on the internet. Some senior leaders have not completed their declaration despite requests from the HOO and the President. The delay in starting to publish declarations and continuing delays in completing and publishing declarations indicate a reluctance of the HOO to undertake serious reforms that may be politically sensitive.

As coalition and Afghan leaders recognize how corrupt behavior is perpetuating state weakness, thwarting the collection of revenue, and strengthening the insurgency, it will be critical to determine what concrete steps to take together to reduce corruption, strengthen governance and rule of law, and make progress toward achieving the Kabul Conference commitments.

4.4: Government Reform

Capable ministry executives and civil servants are vital to increasing and improving the capacity of the Afghan government at the national and sub-national levels. Significant progress in this area will not be achieved in months but in years. Currently, the Government of Afghanistan, United Nations, and donor community collaborate on programs to assist in policy reform, organizational reform, and public administration systems reform. These initiatives are vital to the Government of Afghanistan's efforts to gain the trust of its people and to strengthen its legitimacy both domestically and internationally. Some of the reforms seek to implement the systems and processes that will enable sustainable long term growth of the ministries and the permanent staff of the ministries.

4.4.1: Civil Service Reform

The Afghan Government recognizes that its lack of civil-service capacity is a roadblock to progress. Accordingly, the Independent Administrative Reform and Civil Service Commission (IARCSC) has set an ambitious program to recruit and hire more than 100,000 new civil servants (including 80,000 new teachers) by March 2011, and build the capacity to offer job training to between 12,000-16,000 employees. As of August 2010, they had trained more than 11,000 civil servants in 18 provinces.

Over the past quarter, the IARCSC's training arm—the Afghan Civil Service Institute (ACSI)—has launched a new initiative to improve the skills of civil servants in five core competencies: leadership, finance, time management, policy, and strategy. From May through June, 1,000 civil servants completed or entered training in the provinces of Kandahar, Pansher, Bamiyan, Jalalabad, Nangahar, Kunduz, and Balkh. ACSI will implement an internship program to bring students into the government to assist local officials; the first program in Kandahar will be launched in early July.

In late June, the ACSI launched a first-ever training program for existing or newly hired district governors in Zabul Province. Under the program, the governors stay for at least a week at one of the regional ACSI campuses to learn how to more effectively manage their districts and provide the basic services to the populations that they were hired to support. In addition, the ACSI has an internship program that has placed 1,400 interns in 18 ministries.

However, security continued to be the largest factor impeding governance efforts during the quarter. Civil service training was postponed in Kandahar due to the deterioration in security

and the unwillingness of civil servants to participate in the training in Kandahar City. Mitigating steps included moving training locations to secure venues.

4.4.2: Elections

Election preparation for the September 18 Parliamentary elections was deliberate and detailed. During the 2nd and 3rd Quarters of 2010, the Independent Elections Commission (IEC) intensified planning for the Parliamentary Elections. The IEC announced on June 22 a preliminary candidate list of approximately 2,600 candidates, including 406 women (a 24 percent increase in women candidates from the 2005 Parliamentary Elections), and 52 Kuchis. Voter registration was conducted from June 12 to August 12 in all 34 provinces and resulted in 377,000 new voters.

In a positive departure from planning for last year's national elections, the IEC independently developed and published a plan on improved Anti-Fraud Measures for the Wolesi Jirga Election. The plan accounted for numerous risks identified in the Vulnerability to Corruption Assessment (VCA) on the election process that HQ ISAF developed in May and on which the international community and ISAF subsequently coordinated. The IEC also took the initiative to prepare and release an "anti-fraud measures" document to guide election workers.

However, even with preparations by the Afghan Government, ANSF, IEC, and a robust international and civil society monitoring presence, significant concerns about the validity of the electoral process remained. In particular, top concerns were:

- Manipulation of candidate slots and insufficient candidate vetting;
- Fraud in the conduct of elections;
- Manipulation of, or inaction during, the electoral complaints process; and
- Susceptibility of election workers to local powerbroker influence.

Election Day had no sensational or high profile attacks. There were approximately 610 enemy initiated attacks on election day, however, the Taliban was not successful in keeping the Afghans from exercising their right to vote, with 4.3 million votes cast, including 1.4 million by women, at 5,510 sites open for polling.⁴⁶ In addition, the IEC process during this election was viewed as a significant improvement from last year's Presidential Election. The next step is for the IEC to adjudicate election complaints and certify results.

Final results are scheduled to be published October 30, 2010. However, the Electoral Complaints commission (ECC) received approximately 3,800 complaints of irregularities, deception, or willful manipulation of election materials and procedures. Initial indications are that the IEC was able to prevent wholesale fraud. Final results are expected to be released at the end of October.

⁴⁶ With an estimated 12 million Afghans registered to vote, approximately 38 percent voted in the Parliamentary elections. Preliminary reports estimate female turnout at approximately 40 percent.

4.5: Reconciliation and Reintegration

Since the last report, the Afghan Government made significant progress in developing its peace and reintegration program. In April, the Afghan Government issued interim guidance in order to guide response actions to reintegration activities occurring before they finalized the official Afghan Government reintegration program. Although the lack of formal Presidential authority limited the impact of this guidance, it gave a framework for reintegration activity to take place. The framework guidelines have proven essential in guiding the Afghan Government in the management of reintegration events. The guidelines have also shaped ISAF's role in supporting reintegration.

Following the Afghan Government's interim guidance, the National Consultative Peace Jirga occurred from June 2-4, 2010, with an attendance of 1,600 Afghan men and women representing all religious, ethnic, tribal, and institutional groups in the country. The Jirga provided President Karzai, in its 16-point resolution, a clear mandate to pursue peace and end the conflict. In late June, President Karzai issued a decree to establish the Afghanistan Peace and Reintegration Program (APRP), an initiative endorsed by Kabul Conference participants in July. The APRP requires the establishment of national, provincial, and district-level government structures to execute reintegration activities. President Karzai signed and the Afghan Government issued the Joint Order on implementation of the Afghan Peace and Reintegration Program (APRP) on August 29. The Joint Order empowers the national-level reintegration structures to provide guidance to the sub-national structures and directs provincial governors to conduct reintegration activities.

At the national level, a High Peace Council was established in September to provide strategic guidance and broad-based political support for peace and reintegration activities. Also mandated by the decree at the national level are a Joint Secretariat, answerable to the High Peace Council, to manage reintegration events, and a Financial Oversight Committee. The Oversight Committee consists of Afghan Government ministers and two rotating international donor representatives (currently U.K. and Japan) to serve as the approving authority for all APRP project proposals funded through the Reintegration Finance Mechanism. ISAF is focused on assisting the national-level reintegration bodies, as well as helping the Afghan Government to develop sub-national reintegration structures.

Field reporting shows low-level informal reintegration continues in all areas where insurgents are active. The majority of this activity involves a fighter opting to leave the battlefield, return home, and be accepted by his community. The Afghan Government's ability to verify and formalize such reintegration events is limited in part because the government has yet to establish the organizations and structures set out in the APRP to manage such activity. This situation should improve as current steps to mobilize action at the sub-national level take effect. In certain provinces where the Afghan Government has prioritized the APRP - such as Herat, Helmand, and Baghlan - sub-national structures have been established and are supporting reintegration activities. More "formal" reintegration events are occurring with representatives of groups of fighters, numbering from 10 - 400, approaching Afghan Government officials to discuss reintegration. Such events have occurred in Baghlan, Herat, Badghis, Samangan, and Helmand, among others. In Helmand, the provincial governor organized a Provincial Reintegration Committee and also a district committee in Nad-e Ali, which have enabled formal reintegration

to take place. In others provinces, national-level Kabul-based teams and enablers support and guide reintegration activity. Although the number of insurgents who have so far reintegrated is limited, many groups have come forward to begin discussing options.

Security and access to credible grievance resolution processes are critical enablers to reintegration. Insurgents need to be confident that they will not be subjected to reprisal before they agree to come forward. Assessments indicate that a small minority of insurgents are ideologically driven. Most are driven to pick up arms by grievances or local disputes. Moreover, most insurgents operate within their communities. APRP's focus on addressing local grievances separates it from previous DD&R (Disarmament, Demobilization & Reintegration) programs in Afghanistan.

Finally, the U.S. Department of Defense's Afghanistan Reintegration Program, as authorized in the FY 2010 National Defense Authorization Act (NDAA), is starting to deliver support for Afghan-led reintegration. Notably, while expenditure is as of yet modest, the presence of its funds has given the Afghan Government and a wide range of international and government organizations the confidence to create supporting actions plans. Intentional delays in exercising this authority were enacted this spring to prevent the Coalition from getting out in front of the Afghan Government. Since July, NDAA funds have been used to support reintegration of detainees into their communities. They have also provided secure housing for ex-combatants in RC-North. As the civil-military campaign gains momentum, reintegration opportunities are expected to increase, making continuation of this NDAA authority in FY 2011 critical to overall success in Afghanistan.

[Refer to classified annex for additional information.]

4.6: Village Stability Operations

The VSO program is a bottom-up strategy to provide local security, enable development, and foster governance at the village level. It focuses on Afghan communities who have opted to resist the Taliban and other insurgent groups through grass-roots initiatives, especially in areas that have limited ANSF and ISAF presence. VSO is grounded in a tradition of rural Afghan villages providing basic self-defense and security in their communities, with the support of the Afghan Government. These are not militias, a term often used in Afghanistan to refer to large offensive forces under the command of individual warlords. Instead, they are small, defensive, village-level policing entities under the supervision of local shuras and the oversight of the MoI. The first VSO site was established in July 2009 (when the program was called the Community Defense Initiative).

The VSO model uses embedded U.S. and Afghan forces in villages to help provide security. The ANA Special Forces, which have been deployed to a growing number of sites, facilitate security, development, and governance. Presently, there are eight ANA Special Forces teams, and a total of 72 teams are scheduled to be trained by December 2011. In addition to security, VSO concentrates on improving development and governance at the village level. Afghanistan's Ministry of Rural Rehabilitation and Development and USAID provide development to local

communities, along with the U.S State Department Provincial Reconstruction Teams, who connect Afghan Government officials at the provincial and district levels to the local villages.

In April 2010, local villagers in Gizab District, Daykundi Province, successfully revolted against the Taliban with support from the Afghan Government and ISAF. Since April several other local Afghan communities have resisted the Taliban in specific areas of other provinces, such as Herat, Paktika, Paktia, Oruzgan, Konduz, and Farah. The VSO program is beginning to show positive results. In several areas of Kandahar Province, for example, early indications suggest that security has significantly improved for Afghan villagers. Schools have reopened and economic conditions are gradually improving as the increasing security environment provides space for basic activities, such as markets, to occur. Local Afghans are supporting the program and the local force by identifying IEDs, reporting on insurgent movement, and finding weapons caches. Persistent Taliban intimidation of VSO communities is one challenge to the program's effectiveness. With the establishment of the Afghan Local Police (ALP) program, VSO sites will eventually transition into ALP sites under the Ministry of Interior.

4.6.1: Afghan Local Police

The ALP Program is a temporary (two-to-five year) village-focused program that complements COIN efforts by targeting selected areas with limited to no ANSF presence to shape conditions for improved security, governance, and development. President Karzai approved the establishment of the ALP program, and signed the subsequent policy on Aug 17, 2010, to create operational impacts to the Afghan security framework in select locations. Thus, ALP is an enabler for COIN operations by further expanding and extending security and stability through village stability operations in remote areas. The MoI subsequently identified 68 locations for ALP elements of 250-350 personnel and stood up the first eight sites in September.

ALP had its roots in several past programs. Through the feedback process, numerous lessons were learned from past programs and the best aspects of each were combined. In particular, the best of both the Afghan Public Protection Program (AP3) and the Afghan Public Protection Force (APPF) were combined with the Combined Forces Special Operations Command-Afghanistan (CFSOCC-A) Community Defense Initiative (CDI). The Afghan Government approved the concept, originally named APPF-Village Stability (VS), prior to its final designation of ALP.

ALP allows for transition of its eligible personnel to regular ANSF or other forms of employment. Therefore, ALP does not detract from ANSF growth, but helps close a gap in security coverage. ALP personnel trained and organized into village watch teams, will serve as an early warning and initial village defense element against insurgent activity, and will provide a pool of trained personnel that can apply to join ANA or ANP in the future. The ALP will not count against the Joint Coordination and Monitoring Board (JCMB)-approved ANP end-strength.

Numerous control measures will be implemented to mitigate Afghan Government concerns that this effort does not reconstitute the militias or warlords that once terrorized Afghanistan, exacerbate tribal or ethnic imbalances within or among villages, or undermine the authority of the state.

ALP sites will be established in a deliberate manner to ensure sufficient time for assessment of local area dynamics, structured training, arrangement of an oversight system, and establishment of remote support procedures in coordination with U.S. SOF and Battlespace Owners (BSO). ALP sites will be established at a pace congruent with Afghan Government capacity for oversight and U.S. SOF and/or ANA SOF capacity for partnering. As the program grows, ALP will expand beyond the capability of those forces; some sites with greater potential will transition from SOF to BSO control and oversight. Future sites will be stood-up directly by BSO units. One imperative is that all ALP units are partnered and mentored; another is that they are appropriately assessed before moving forward.

The ALP program complements reintegration by supporting the provision of security for communities and individuals who reintegrate. Reintegration efforts may be amplified at locations where ALP is implemented; however, reintegration efforts do not necessarily dictate the location(s) of ALP sites.

As a U.S.-funded program, ALP is financed through the Afghan Security Forces Fund.

Section 5 – Reconstruction and Development

The Afghan Government is making slow but steady progress implementing the Integrated Economic Development Plan endorsed at the London Conference in January 2010. The Plan prioritizes strategic development objectives and promotes synergy among key Ministries to achieve sustainable economic growth and job creation. Since the London conference, the MoF established three clusters, grouping 16 Afghan Government ministries to organize the Afghan National Development Strategy (ANDS) planning and programming into three principal areas: agricultural and rural development, infrastructure/economic development, and human resource development.

At the Socio-Economic Standing Committee of the JCMB in April, ministry cluster coordinators reported on the establishment of working groups to address:

- Developing natural and water resources, agricultural productivity, and agribusiness development to improve rural livelihoods;
- Preparing Afghans for the labor market through technical and vocational education, literacy, and development of labor regulations; and,
- Creating an enabling economic environment and infrastructure to attract investment, create high value industries, and connect Afghanistan to the region and the world.

The first draft of the ANDS Prioritization Plan, prepared by the three cluster ministries, was presented for discussion with the International Community at the June session of the Socio-Economic Standing Committee. Ministry clusters were represented by the Minister of Agriculture, Irrigation and Livestock (MAIL), Minister of Mines (MoM), and Ministry of Education (MoE). The objective is to create a more effective framework for Afghan Government delivery of public services with donor support. The plan includes 15 Economic and Social Development Cluster National Bankable Program Summaries, totaling 8 billion USD presented at the Kabul Conference in July.

Poor planning, insufficient infrastructure, and corruption continue to hinder development. The back log at the Hairaton border crossing demonstrates the Afghan Government's difficulty in providing consistent access to international markets. The Afghan Government will continue to be dependent on international aid to address these issues. In addition, the government asked for between 14-15 billion USD for a wide variety of development projects on security, economy, agriculture, human resources, rural development, and good governance during the Kabul Conference.⁴⁷

Development continues to improve slowly in the face of poor security, inadequate Afghan Government capacity, and malign foreign influence. Natural resources continue to be exploited outside of government regulation. Illegal mining, timber felling, and smuggling reduce Afghan Government revenues. Bringing these industries into the licit economy would strengthen the government and create additional employment opportunities.

Security challenges and contracting difficulties continue to impede progress on development projects. The Khost-Gardez road is an example of this. High levels of insurgent activity have delayed the project many months. Initially planned to be completed in March 2010, the road is currently still under construction with work halted entirely on some parts of the road due to the security situation.

5.1: United Nations Assistance Mission in Afghanistan (UNAMA)

UNAMA currently operates 23 field offices throughout Afghanistan (eight regional offices and 15 provincial offices). UN Security Council Resolution 1917 (2010) reaffirms the importance of strengthening and expanding the presence of UNAMA and other UN agencies, funds, and programs in the provinces. Eight regional offices typically oversee UNAMA's work in several provinces, while provincial offices ensure action and follow-up at provincial and district level.

UN Special Representative of the Secretary General (SRSG) to Afghanistan Staffan de Mistura arrived in Kabul on March 13, 2010. Under SRSG de Mistura's leadership, UNAMA identified four priorities in support of the overall UN role to assist the government and people of Afghanistan in creating conditions for sustainable peace and development. Three of the priorities support Afghanistan's political development: support for elections, reconciliation and reintegration, and regional cooperation. The fourth priority is to promote aid coherence.

On May 8, 2010 SRSG de Mistura launched the Kabul Silk Road initiative, co-chaired with the Ministry of Foreign Affairs. The initiative provides an informal forum for the ambassadors of Afghanistan's neighbors and near-neighbors to discuss their shared interest in long-term stability in Afghanistan. SRSG de Mistura continued to meet with ambassadors and envoys of countries in the region to discuss issues affecting their bilateral relations with Afghanistan and their support for the further stabilization and development of Afghanistan.

⁴⁷ IDC Unclassified Environmental Overview (NIUANU).

5.2: Provincial Reconstruction Teams (PRTs)

5.2.1: RC-East

RC-East's PRT structure consists of 162 U.S. Government employees: 52 DoS, 80 USAID, and 30 USDA. During the reporting period, the RC-E civilian platform focused on preparations for the September Parliamentary Elections, infrastructure development, and devolution of authority to increase flexibility at lower levels. Civilian efforts vary widely across RC-E and even across provinces. Generally, however, improving legitimate governance and the visibility of the Afghan Government through the delivery of services remains critical to progress in the RC.

In particular, RC-E civilians assessed need for improvements in infrastructure, particularly in electrical power supply. U.S. Government civilians in RC-E are working with the military to support the proposed electrification project for RC-E. Efforts also continue to improve partnership between Afghan security forces, USAID, and the U.S. military in order to move along stalled road projects that are significantly behind schedule.

5.2.2: RC-South

RC-South's PRT structure consists of 73 U.S. Government employees: 29 DoS, 36 USAID, and 8 USDA. The civilian focus in RC-S has been on building the capacity of sub-national governance institutions, supporting outreach by government officials, and developing the agricultural sector. Significant civilian effort has been dedicated to stabilizing Kandahar City and surrounding districts as security operations progress in those areas. The objective sought over the reporting period in Kandahar City was for civilians, partnering with provincial and district officials at all levels, to develop the Afghan Government presence and responsiveness, which included working with Kandahar Governor Wesa and Kandahar City Mayor Hamidi to launch and expand shuras led by local officials.

While civilian efforts continue, the security situation in RC-S remains a significant challenge to overall progress in the region. Under-staffed district and provincial offices were further hindered in their efforts by the assassinations of district governors during the reporting period. The PRTs will continue to work with the military to ensure, where possible, improvements in security are reinforced by governance efforts.

5.2.3: RC-Southwest

RC-Southwest's PRT structure currently consists of 36 U.S. Government employees: 17 DoS, 14 USAID, and 5 USDA. Since this RC was established in June 2010, the PRTs have focused on enhancing the capability, accountability, and responsiveness of governance institutions, improving legitimacy and accessibility of government-sanctioned justice systems, increasing capability and capacity of the ANP, and enhancing freedom of movement in central Helmand. Civil-military effort in RC-SW has led to improvement in the security and freedom of movement of Afghans in this RC. To ensure continued progress in RC-SW the PRTs will continue working with the Afghan Government to increase their capacity to deliver services and to collect taxes for revenue.

5.2.4: RC-West

RC-West's PRT structure consists of 20 U.S. Government employees: 6 DoS, 10 USAID, and 4 USDA. Over the reporting period the civilian effort in RC-W has been on opening the Herat Consulate with a regional USAID mission, ensuring adequate life support for RC-W, and establishing U.S. Government presence at non-consulate locations to better provide the Afghans with assistance. Overall, Herat Province is viewed as second only to Kabul in development and basic infrastructure. The PRT effort in RC-W has continued to build upon the professional leadership already available, although there is still a need for capacity building and skills training for mid-level civil servants. Furthermore, the civilian effort needs to continue to work with the Afghan Government to develop systems of accountability to manage corruption in the region.

5.2.5: RC-North

RC-North's PRT structure currently consists of 23 U.S. Government employees: 8 DoS, 10 USAID, and 5 USDA. The primary operational priority over the reporting period for PRTs in RC-North was to establish a consulate-like function at the RC-N HQ. To this end, RC-N has expanded field presence at five PRTs (Faryab, Balkh, Kunduz, Badakhshan, and Baghlan) and established presence at four additional RC-N provinces (Jowzjan, Samangan, Sar-i-pol, and Takhar.) To ensure mobility and life support for the U.S. Government personnel assigned to the German and Swedish PRTs, DoS negotiated memorandums of understanding with each respective international PRT.

RC-N PRTs continued to support Coalition development efforts in RC-N key terrain districts. Coordinating with USAID, the PRTs expanded stability support programs into new provinces and field officers facilitated complementary use of Commander's Emergency Response Program (CERP) fund and Embassy Quick Response Funding to promote development. In addition, the civilians supported sub-national governance capacity building by expanding judiciary training, initiating Hairaton border post mentoring, and supporting the sub-national budget training initiative.

Annual flooding in RC-N was particularly severe, affecting most provinces in the RC. Disaster management and preparedness continue to challenge the ability of provincial officials to provide basic services, particularly timely response during emergency situations. RC-N PRTs continue to work with and through UNAMA on building Afghanistan National Disaster Management Authority (ANDMA) capacity to assist in these situations.

5.3: Afghanistan Reconstruction Trust Fund (ARTF)

The Afghanistan Reconstruction Trust Fund (ARTF) is administered by the World Bank under the supervision of a Management Committee comprising the Asian Development Bank (ADB), the Islamic Development Bank, the World Bank, and the United Nations Development Program (UNDP). The multilateral ARTF was set up in May 2002 to provide support to Afghanistan in two areas: 1) it will provide for the recurrent costs of the government, such as the salaries of teachers, health workers, civilian staff in ministries and provinces, operations, and maintenance expenditures; and bulk purchases of essential goods for the government; and 2) it will support

investment projects, capacity building, feasibility studies, technical assistance, and the return of expatriate Afghans.

5.4: Economic Development

Poverty is widespread in Afghanistan. National poverty rates in Afghanistan are approximately 35 percent, or approximately nine million Afghans who are not able to meet their basic needs. The poverty rate varies between provinces, ranging from 20 percent in Helmand, Farah, Jawazjan, and Baghlan, to over 55 percent in the south and central provinces of Paktika, Paktya, Logar, and Wardak.⁴⁸ In some provinces, the poverty rate is as high as 90 percent. From 2006 to 2010, economic growth averaged 12 percent annually, with a surge to approximately 22 percent in 2009-2010 as a result of an increase in rainfall and a subsequent bumper crop. However, job creation remains slow. ISAF and the international community are working with the Afghan Government to increase efforts to establish an economy that supports private sector trade and investment. USAID's economic growth program assists the Afghan Government in developing sound economic governance and works with the private sector to stimulate investment and business opportunities. USAID is a partner, supporting Afghans, in establishing an economy that welcomes investment, generates sustainable employment, and expands markets.

5.4.1: Government Revenue and Expenditure

Domestic revenue collection continued to improve in the first quarter (March, April, May) of the Afghan Fiscal Year (FY) 2010-2011, during which the Afghan Government collected revenue of 17.6 billion Afghanis (Afs)—367 million USD—an increase of 22 percent over the same period 2009-2010. Revenues in the first quarter normally account for 21 percent of revenue raised within a year, with second, third, and fourth quarters accounting for 23, 22, and 33 percent, respectively. If this strong performance holds, final revenues for Afghan FY 2010-2011 could be as much as 83 billion Afs (1.7 billion USD), a 30 percent increase from Afghan FY 2009-2010.⁴⁹ Improved tax and customs administration and the introduction of an ad-valorem tax on imports have been the major drivers of revenue growth.

However, while growth in government revenue has been substantial over the past few years, Afghanistan still collects revenue equal to only nine percent of GDP (up from 6.9 percent in Afghan FY 2008-2009). As a comparison, Pakistan and India execute 13.4 percent and 15.0 percent, respectively. The Afghan Government is able to cover only 54 percent of its operating expenditures in the absence of grants.

5.4.2: Border Control

Afghanistan's 5,529 km border remains a strategic vulnerability as well as a potential economic engine. The lack of a comprehensive border control strategy and corresponding lack of unity of effort among multiple agencies with border control interest challenges security as well as efforts to increase customs revenue.

⁴⁸ National Risk and Vulnerability Assessment (NRVA), 2007/2008.

⁴⁹ Of note, during FY 2009-2010 the Afghan Government collected 63.8 Afs (1.3 billion USD), a 53 percent increase from the year prior.

There are over 20 agencies within the Afghan Government that oversee the border crossing points to include the MoI, MoD, MoF, and the Ministry of Transportation and Civil Aviation. The primary coalition oversight is provided by ISAF, DoS, the Border Management Task Force (BMTF), and USAID. Figure 17 below shows key border crossing points and major airports.

Despite persistent problems, improvements have been made at many of the major border crossing points (BCP). The four key BCP's reported increased capacity with the adoption in August 2010 of extended operating hours facilitating increased cargo importation into Afghanistan. Kabul International Airport also reported an increase in the number of flights per day as well as in the number of passengers served. Border revenue at key border points is provided in Table 8.

Table 8: Key Border Revenue (September 2010) ⁵⁰

Border Control Points	Revenue
Tor Kham Gate	\$14.2M
Islam Qal'eh	\$18.6M
Hairaton	\$13.7M
Wesh Chaman	\$3.96M

Notwithstanding the poor unity of effort within the Afghan Government, the IC has often been less than effective due to fractionalized efforts to provide border support and assistance. The Torkham BCP in RC-E has been identified as the “model” BCP. Torkham will receive priority attention for unity of effort, development of Afghan Government capacity, and engagement with Pakistan. Some of the noteworthy initiatives that will be employed at Torkham BCP include:

- Implementing RC-E Chief of Mission authority for all interagency enablers operating in support of Torkham Gate BCP.
- Direct authorization with Ministry of Commerce (MoC) and MoF to improve Afghan Government customs operations.
- Mentor Nangarhar provincial governor to address bribes and corruption within the Afghan Border Policy, Afghan Customs Police, and local government.
- Address critically low funding of ABP, ACP, MoF, and Customs and mediate inter-governmental disputes.
- Initiate dialogue with Government of Pakistan to coordinate bilateral infrastructure/road improvements to Torkham Gate.
- Establish direct support roles and responsibilities for all enablers to support Task Force Torkham.

The ISAF Borders Issues Working Group is currently assisting the Afghan Government develop a comprehensive border policy. This policy is expected to be implemented by the Fall 2010. Other ISAF priorities and strategic engagement efforts support legislation, regulations and administrative frameworks in support of the border policy; prioritized employment of Afghan Customs Department officials in accordance with Afghan Government 2010-2011 priorities (8 BCPs, 7 inland Customs Depots, 4 airports); institution of a government-led Border Area Management Steering Group; and ensuring unified and consistent messaging with IC partners.⁵¹

⁵⁰ As reported in the ISAF Strategic Assessment Report, August 2010.

⁵¹ ISAF Strategic Approach to Border Area Management Briefing, 19 September 2010.

Figure 17: Key Border Crossing Points, Afghanistan and Pakistan

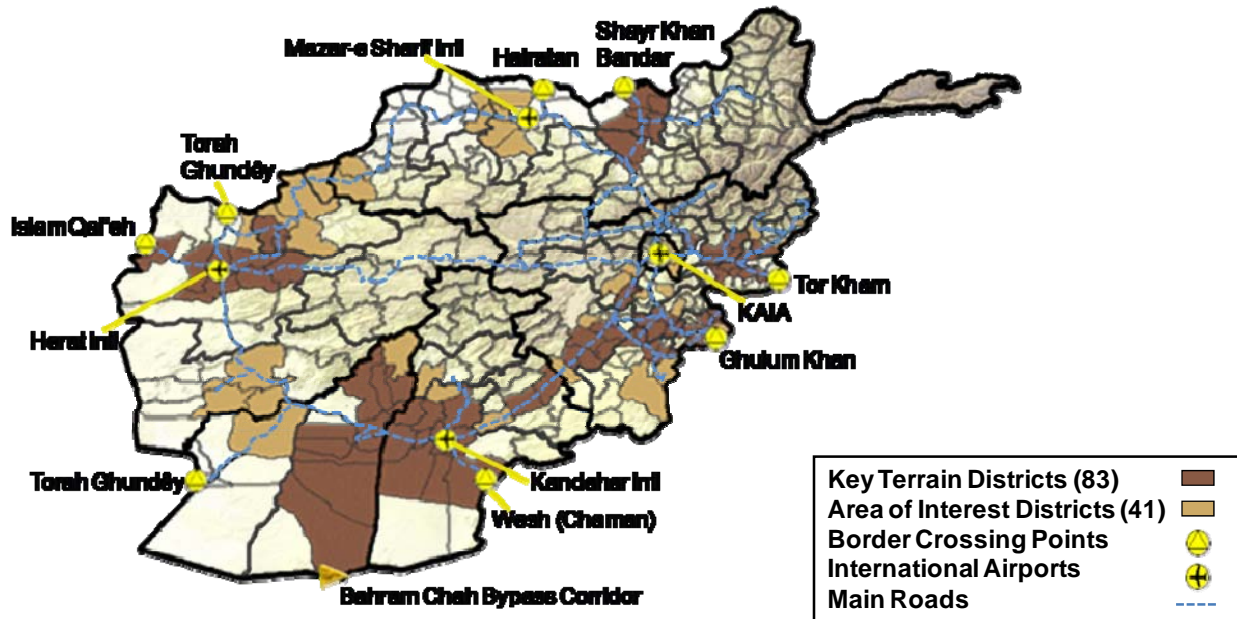

5.4.3: Local Procurement

The U.S. Embassy and USFOR-A *Afghan First* policy encourages local procurement of Afghan products to benefit and improve the well-being of the Afghan people. Procuring goods and services from Afghan companies promotes economic development, supports the growth of a modern and competitive business sector, and boosts Afghan employment. The Coalition military and development agencies are significant players in the Afghan economy; their influence will be more positive to the extent that they actively partner with Afghans and Afghan companies to create jobs. Abating unemployment requires a comprehensive U.S. Government approach.

Local procurement also makes good business sense from the buyer’s perspective. Afghan firms know the terrain and can often provide goods and services with comparable quality at competitive prices. With a shorter supply chain, local procurement is often the best way for the buyer to maximize value and timely delivery of needed goods and services. Such business engagement can broaden Afghan support for our mutual strategic objectives in Afghanistan. Most importantly, it helps local businesses to grow, gain experience, and generate jobs in the industrial, commercial, and agriculture sectors.

5.4.4: Agriculture

An estimated 85 percent of Afghans derive their income from agriculture. While poppy production and the opium trade have a significant monetary share of the country’s agricultural economy, the number of farmers growing opium continues to decline. Farmers continue to take advantage of opportunities to produce and market traditional crops that are Afghanistan’s historical strengths as licit alternatives to opium. Licit commercial agriculture continues to play a growing role in increasing the income of rural populations, who recognize that the opium trade is destabilizing, contributes to insecurity and the insurgency, and undermines rule of law.

As a result of strong collaboration among USAID, the Afghan Government, other U.S. Government agencies and donors, there are 22 poppy-free provinces and this number continues to increase as opium cultivation continues to decline. Maintaining and building on such success requires programs that restore Afghanistan to its historical strengths in high-value licit crops in all regions. The poppy harvest has ended in Central Helmand with indications of low yields and concurrent reduced revenue for farmers. The secondary effect of the degraded harvest is expected to drive local farmers to request IC assistance with Alternative Livelihood programs. The decrease in narcotics revenue has continued to push local insurgents to increase their illegal taxation efforts in order to increase their operational funding, despite instruction from Taliban leadership to the contrary. Increasingly, over the past reporting cycle illegal taxation has been met by Afghan resistance. This defiance is expected to further aggravate insurgents' revenue shortfalls which could result in increased violence, intimidation, and hostilities toward the local Afghans.⁵²

In order to assist with development of the agricultural sector, and in conjunction with the U.S. Government's broader civilian up-lift efforts, the USDA increased its civilian presence in Afghanistan from 13 agriculture experts in October 2009 to 63 experts in September 2010. These experts are embedded within the civilian-military structure at the district, provincial, Task Force, Regional Command and National levels. They focus on capacity building of the Ministry of Agriculture, Irrigation, and Livestock (MAIL) personnel and Afghan farmers. Areas of focus include improved agronomic practices, water utilization, post harvest handling techniques, and plant and animal health practices that aim to increase productivity and income of Afghan farmers. Of particular high importance is building the capacity of MAIL at national and local levels to perform and deliver these services to Afghan farmers. Of the 63 experts, USDA has five agricultural experts embedded in MAIL headquarters in Kabul to assist with the following Ministry-identified priorities: extension, change management (a Ministry reorganization initiative), and sanitary and phytosanitary issues. Recruitment efforts are underway for three additional areas of expertise identified by the Ministry including water resources, natural resources, and agribusiness management. Additionally, USDA has four employees serving in Afghanistan under the Department of Defense.

During April – September 2010, food security in Afghanistan improved, due in part to above average production of cereals during the summer of 2009. USAID's Famine Early Warning System projects that up to 21 provinces will be "Generally Food Secure" during both the second and third quarters of 2010, compared to 11 provinces during the same period the previous year. Afghanistan is expected to have a national wheat deficit of approximately 700,000 tons in 2010. Since June, market wheat prices steadily increased in all reference markets. The monthly wheat price increase was higher in July than in August indicating sufficient wheat supply and production in the country between July and August. However, food security conditions are expected to deteriorate in cereal deficit provinces in southern, eastern, and central Afghanistan due to wheat shortages in Afghanistan's traditional suppliers, Russia and Kazakhstan, and flooding in Pakistan.

⁵² IDC Environmental Summary, May 6-13, 2010.

Progress has been made in donor funded voucher and Cash for Work (CFW) programs to create short term employment opportunities as a component of stabilization programs to support Operation Moshtarak, where 20,000 jobs have been created, and planning for Operation Hamkari, where similar programs are expected to be implemented in four key districts. Across the country, substantial repair of irrigation canals through CFW programs has improved over 52,000 hectares of irrigation and reforestation in three key watersheds. In general, over 365,000 farmers across 18 provinces have received vouchers. Of these, 358,000 have been redeemed. So far, in support of stability operations in the south, 37,000 farmers have received training in improved agricultural techniques in Helmand and Kandahar provinces.

Progress has been realized in short-term programs that could have some impact upon productivity. However, a systematic approach for agribusiness development involving MAIL strategy and objectives is unclear at this time. Future efforts will link short term gains to a long term strategy and plan for agricultural reconstruction that can set the stage for agribusiness development as a sustainable way forward in achieving economic development.

Agribusiness Development Teams (ADTs)

The Agribusiness Development Team (ADT) is a self-contained volunteer unit composed of 58 Army National Guard Soldiers with backgrounds and expertise in various sectors of the agribusiness field. Their mission is to provide training and advice to Afghan universities, provincial ministries, and local farmers with the goal of providing increased stability and improved opportunities for Afghanistan's re-emerging agribusiness sector. ADTs ensure that improvements are sustainable with local assets and within the context of MAIL abilities. To be immediately effective, ADT personnel must be in place to affect the next growing season.

Eight ADTs are currently deployed to RC-E, and one ADT located in RC-S augmenting the PRTs in Afghanistan. The ADTs currently include soldiers from the states of Missouri, Texas, Kentucky, Indiana, Oklahoma, Iowa, Kansas, Arkansas, and South Carolina. Since the inception of the program in 2007, 21 ADT deployments have provided support to 14 provinces and contributed to over 282 sustainable agriculture projects, generating more than 21 million USD in revenue for the people of Afghanistan.

The ADT efforts will focus on areas where progress in security and stability has been made. At least four additional provinces will be targeted for additional ADT deployments. The USAID and the USDA are both enthusiastic about supporting the ADT initiative.

5.5: Infrastructure and Essential Services

5.5.1: Energy

Progress has been made in a number of strategic infrastructure projects that can consolidate security gains, increase freedom of movement, and lay the foundation for economic development and job creation.

Afghanistan's energy system lacks cohesion. Three major isolated networks—plus many small basic diesel and hydroelectric plants—compose the system, much of which was built before the

civil war and has since been destroyed or damaged. The reconstruction of power plants and transmission lines has been hampered by the security situation. The three main existing power grids (shown in Figure 18 below) are the North-East Power System (NEPS), the South-East Power System (SEPS), and the Western Power System (WPS). A newly built 220 kV transmission line between the Afghan-Uzbek border and Kabul, funded by the Afghan Development Bank and the Government of India, became operational in early 2009, connecting the capital region to the NEPS and supplying Kabul with continuous power. Generally, consistent power supplies via a power grid system are limited to Afghanistan's urban centers; however, this does not mean everybody within those areas has access to electricity.

Figure 18: Afghanistan Electric Power System

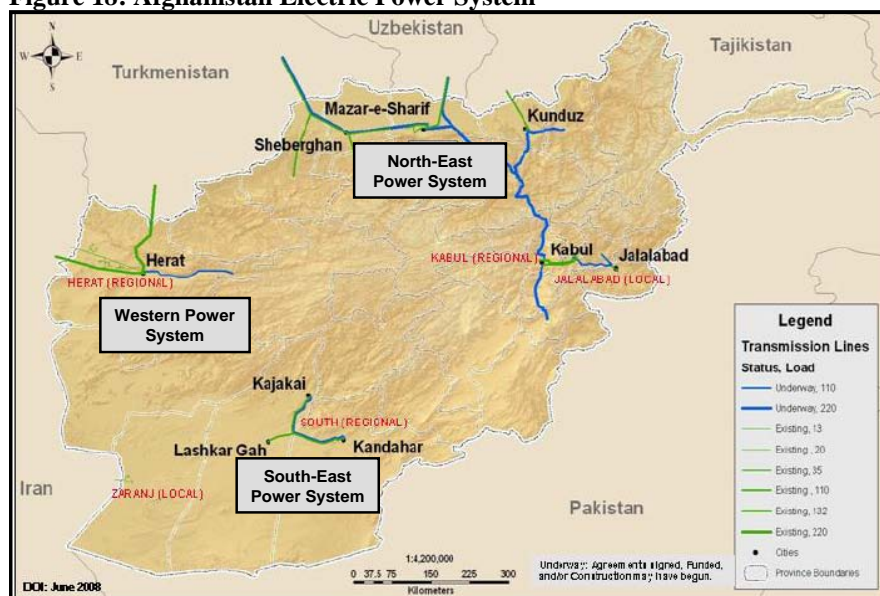

Afghanistan's generating capacity is mainly hydro-based with total hydro potential estimated to be large enough to provide Afghanistan long-term opportunities to become independent from the imported fuel and electricity that comes from more expensive gas-based generation in neighboring countries. However, current plans to increase hydro electrical power production will likely not be sufficient to eliminate the country's dependence on imported electricity.

In 2010, on average, Afghanistan produced 35.6 percent of its electricity in hydro power plants, 4.6 percent in thermal power plants; the remaining 59.8 percent was imported. Afghanistan imports the majority of its energy from Uzbekistan, Tajikistan, Turkmenistan, and Iran.

Although availability of electricity has increased due to higher import levels, Afghan total satisfaction (country-wide) remained the same from June to September 2010 as shown in Figure 19. Satisfaction with electricity availability is negative, largely because the rural population is not yet connected to the power grid. The rural areas that have electricity are from self or community generated diesel and hydropower.

Figure 19: Afghan Satisfaction with Electricity (September 2010)⁵³

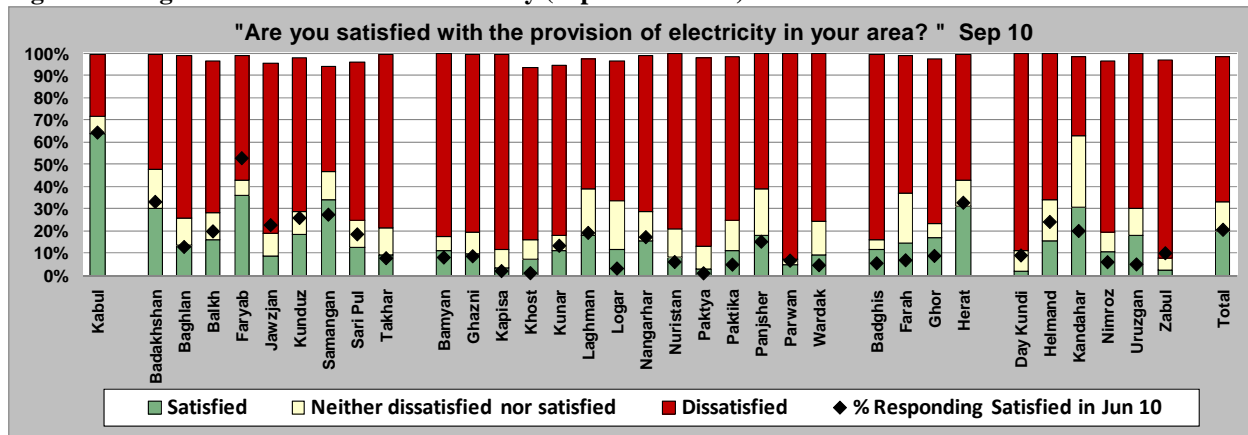

The ADB is supporting a long term 570 million USD Energy Sector Development Investment Program to finance a range of power sector investments on transmission and distribution rehabilitation and extensions of the main NEPS bringing imported electricity from Tajikistan. The first 164 million USD was directed to Kunduz and Baghlan, two strategically important provinces where stabilization efforts are expected to begin shortly.

Freedom of movement objectives are being addressed through road and rail projects and civil airport construction, to create strategic infrastructure connecting Afghanistan to the region and beyond. For example, USAID funded construction of 106 km Bamiyan to Doshi road that will provide an all season bypass to the Salang Tunnel linking Kabul to the northern region of the country. Secondly, USAID funded the Strategic Provincial Roads program providing for construction of 26 secondary roads (23 roads are under construction and three are completed) connecting districts to provincial centers.

Construction is ahead of schedule on a 75 km railway line linking Mazar-e-Sharif, the principal cultural, economic, and political center in the northern region to Hairaton on the Uzbekistan border. This ADB-funded project represents the first phase of a larger rail network planned across the north and west to improve internal, regional, and ultimately international connectivity, to stimulate cross-border trade and commerce.

Several projects are underway to upgrade civil aviation transport facilities and operations to link provincial capitals to Kabul and the international community. Projects include: construction of a new terminal at Mazar-e-Sharif; a six-year program for airport construction in seven provincial capitals; a modern air traffic control system; and training for Ministry of Transportation and Civil Aviation (MoTCA) technicians at Kabul International Airport.⁵⁴

The outcome of these efforts in creating the elements of a modern strategic and economic infrastructure will take time, but these programs play a critical role in enabling key Afghan Government Ministries to develop the capacity needed to effectively assume responsibility and accountability for the provision of basic services, to promote the public welfare, and to develop

⁵³ Afghan Nationwide Survey, September 2010.

⁵⁴ Airports are planned for Bamiyan, Ghowr, Badakhshan, Faryab, Nimroz, Farah, and Baghdis

and maintain the critical economic and strategic infrastructure to support the agricultural development, trade, and commerce necessary for sustainable economic growth and job creation.

5.5.2: Mining

The Afghan Government continues work to develop the mineral sector in Afghanistan with the long-term goal of using mineral development as a platform for infrastructure development and GDP growth. The Afghan Ministry of Mines (MoM) has approved amendments to the mining law that, when enacted, will enhance the investment climate. Full development of the mining sector will require large-scale foreign investment, which is dependent on improving security conditions, increasing investor confidence in the capacity of the Afghan Government to support international investment, and developing rail and power infrastructure to support mining.

In 2008 a Chinese company was awarded the rights to develop copper deposits at Aynak. Land acquisition and environmental issues continue to delay development of this mine and commercial production by several years. In Sheberghan, the capital of Jowzjan Province, the MoM and the ADB signed a contract to develop gas deposits. The 25.4 million USD project will take up to three years to complete and includes setting up power generators. This development should boost public electricity supply and benefit a Kod-e Barq factory in Balkh Province, positively affecting regional economic development and employment.⁵⁵

Black market smuggling of precious stones and chromite from mines in Khost Province continues to undercut government revenues and weaken the legitimate economy, while supporting criminal and insurgent networks. Legal mining is, otherwise, one of Afghanistan's most promising sectors. A recent U.S. National Geologic Survey estimates that Afghanistan has nearly 1 trillion USD in untapped mineral deposits, highlighting the potential of Afghanistan's mining sector to be a major source of revenue. Engineer Laiq, Director of Mining, Khost Province, said that smuggling from mines in Tanai District to Pakistan's port city, Karachi, and to China had been going on for several years.⁵⁶ Khost provincial governor, Abdul Jabbar Naimi, admitted there is large-scale smuggling of chromite from the area. The employment of a private security company, with 300 guards, has not stopped smuggling. Jawad Omar, a spokesman for the Ministry of Mines, said the government was planning to lease the mines in an effort to increase revenue and provide jobs to local populace.

5.5.3: Telecommunications

Afghanistan's mobile phone penetration is estimated at close to 40 percent of the population, and quickly growing. To date there are over 12 million cell phone accounts in Afghanistan, a country of almost 29 million people. Mobile phones account for 99 percent of all lines. The mobile phone market also serves as the country's largest taxpayer, employs more than 100,000 people, and generates as much as one billion USD in annual revenue for the country's five operators.

[Refer to classified annex for additional information.]

⁵⁵ HQ RC-N Weekly Assessment Report, 092359D JUN 10 classified NIS.

⁵⁶ Pajhwok Afghan News, Kabul, May 25.

5.5.4: Civil Society & Media

The U.S. Government has assisted in the development of media and telecommunication capacity in Afghanistan in a number of ways. During the reporting period the U.S. Government assisted the Afghan Telecom (AfTel) firm in preparing a comprehensive report that quantified the fiscal impact of AfTel. In addition, the U.S. Government is working with AfTel to negotiate agreements with neighboring countries, which will potentially reduce internet access costs 100-fold and increase Afghan Telecom revenues, not only contributing to Afghan Telecom capacity but also to sustainability.

5.5.5: Health

Afghanistan has one of the highest maternal and child mortality rates in the world. About one in six children dies before the age of five and one out of every eight Afghan women die from causes related to pregnancy and childbirth each year. Life expectancy is only 54 years for women and 47 years for men. While these statistics are tragic, there has been progress. Recent reports indicate that 85 percent of the population has access to basic health services within one hour of travel to any health facility (68 percent for those on foot), up from nine percent in 2002. Infant mortality decreased by 33 percent and child mortality dropped 37 percent since 2000. During the reporting period the U.S. Government continued to work with the Ministry of Public Health (MoPH) to improve its capacity to plan and manage activities, allocate resources, increase human capacity, and strengthen the health information system. The U.S. and international support to, and the efforts of the Afghans, led the MoPH to become the first line ministry in Afghanistan eligible to receive direct funding from the U.S. Government. As such, the MoPH continues to be a model of good governance and “Afghanization.” The Host Country Contract (HCC) agreement, which allows the MoPH to implement 236 million USD of health activities over five years, continues to enable the Afghan Government to make its own decisions in procuring NGO services to deliver health care to Afghans.

5.5.6: Education

Afghanistan has a population of almost 29 million people and one of the highest illiteracy rates in the world. An estimated 9.5 million Afghans are illiterate. In rural areas, where three-fourths of all Afghans live, 90 percent of women and more than 60 percent of men are illiterate. Under the Taliban girls were not allowed to go to school and fewer than 900,000 boys were enrolled. In the same period, university enrollment was only 7,881. In stark contrast, nearly seven million students are now enrolled in primary and secondary schools (37 percent are female) and university enrollment has grown to 62,000.

USAID and DoS continue to work with the Afghan Government to improve access to and quality of education in Afghanistan by focusing on improving basic education, supporting higher education, expanding youth and adult literacy, and developing and/or providing the necessary resources, such as textbooks, schools, and teachers, to support these areas. Presently, the U.S. Government is working with the Ministry of Education (MoE) and other international partners to implement the second National Education Strategic Plan (2010-2014). In addition, to ensure that teaching remains a viable career option and to address the severe shortage of teachers, the international community is also assisting the MoE in developing its human resource management

system. This includes assisting in the design and implementation of a teacher credentialing system as well as salary reforms.

The U.S. – funded technical advisory unit within the MoE continues to assist the National Literacy Center develop and implement the National Literacy and Productive Skills Program, which started mobilization in an additional 700 communities in 10 provinces. This program offers hands-on, learner-centered literacy, and numeracy instruction to over 60,000 youth and adults ages 15 and over. In addition, at the end of June, an estimated 13,000 grades 7 through 12 teachers received training in teaching methods for science and math subjects. To further support education in Afghanistan the U.S. Government Community-based Education Program was modified to include an emergency community-based education component. As a result of this modification, the program mobilized over a dozen communities to implement the program in Helmand, Uruzgan, and Kandahar Provinces and provided pedagogical training to more than 100 emergency community-based schoolteachers.

India will fund construction of 13 school buildings in Kunar Province. These new schools represent an increase in the number of education facilities by approximately 11 percent in the province. Almost two-thirds of all children that attend school do not have proper facilities and often have to study in tents or under the open sky. Construction will take place over the next nine months at a cost of about 1.4 million USD. The new classrooms will be built in the districts of Dangan, Khas Kunar, Marawara, Narang, Sarkani, Sawkai, Shigal, and in the provincial capital Asadabad. The greater number of schools than the actual number of school buildings implies that education is a priority to Afghans in Kunar.⁵⁷

In the area of higher education a newly constructed building for the English Department at Kabul University was inaugurated on July 2, 2010. Funded by the World Bank, the faculty includes two conference halls, a computer room, eight classrooms and administrative offices.⁵⁸ In addition, the American University of Afghanistan (AUA) will offer accounting degrees in the Fall semester 2010, using a 1.3 million USD grant from an Afghan donor aimed at expanding the only private university in the country. Head of the AUA, Dr. Michael Smith, on May 27, signed a contract with the donor, Harakat, a private Afghan firm.⁵⁹

A lack of security in several key districts in Afghanistan has continued to hinder progress by forcing closures of schools. In districts where Afghans feel secure, more children attend school. Improvements in security are necessary to build an enduring and viable education program. Delays in confirming the Minister of Higher Education limit progress, as many high-level education decisions await this confirmation. Some of these important issues include setting up key committees and establishing the donor coordination group to support the implementation of the National Higher Education Strategic Plan.

5.5.7: Women's Issues

The promotion of women's rights is integrated into the overall U.S. strategy and all the key programs, including education/literacy, health care, security, rule of law, political participation, and economic development, are described in the State Department's Regional Stabilization Plan for Afghanistan and Pakistan. Progress in improving women's rights has been uneven.

⁵⁷ IDC Environmental Summary, April 29– May 6, 2010

⁵⁸ Pajhwok Afghan News, Kabul, May 29.

⁵⁹ Pajhwok Afghan News, Kabul, May 28.

Improvements in women's education, health, and political participation are evident over the past six months, although violence against women and girls continues and women's health indicators remain among the worst in the world.

Between April and June 2010, the Ambassadors' Small Grant Program awarded 109 Quick Impact Grants to women-led Civil Service Organizations for a total of 696,000 USD awarded. The program also awarded its first Targeted Sustainability grant to the Afghan Women's Educational Center (AWEC), the "legacy" organization that will take over the program when the USAID Cooperative Agreement ends with Creative Associates International, leaving the program entirely Afghan led and managed. The ASGP was also officially expanded to the entire 34 provinces, with a total ceiling of 38 million USD. This will allow all women's groups to benefit from this important program. The ASGP also developed a database and is working on launching its website so that all interested parties and stakeholders can track the progress of the program. Since the beginning of the program, a total of 157 grants have been obligated by USAID with a total value of 1.4 million USD.

Section 6 – Counternarcotics (CN)

6.1: Strategy and Priorities

DoD continued efforts in support of the U.S. Government's CN strategic goals for Afghanistan. The strategy has two main goals: 1) Counter the link between narcotics and the insurgency, and significantly reduce the support the insurgency receives from the narcotics industry; and 2) address the narcotics-corruption-insurgency nexus and reinforce the government of Afghanistan. DoD, in partnership with the interagency, continues to prioritize efforts to counter this nexus in order to achieve objectives in support of the COIN campaign. RC-S and RC-SW retain priority of military efforts. These districts comprise the majority of Afghan poppy fields as well as large insurgent threats. U.S. and international forces continue to partner with ANSF to target narcotics traffickers and facilities supporting the insurgency. The Afghan Government maintains the lead for all CN operations.

The Afghan Ministry of Counternarcotics (MCN) has drafted a new Strategic Plan with a revised vision, mission statement, and set of goals. The Strategic Plan does not identify a new direction, but rather provides a comprehensive approach in a single document. The strategic plan highlights the importance of making CN a cross-cutting issue in the implementation of the ANDS and the National Drug Control Strategy.

6.2: Progress to Date on CN Activities

Afghan National Security Forces (ANSF) with support from ISAF, Combined Joint Interagency Task Force – Nexus (CJIATF-N), and the Interagency Operations Coordination Center (IOCC) continued to conduct law enforcement operations resulting in seizures of 20,795 kilograms (kg) of opium; 1,765 kg of morphine; 7,629 kg of heroin; 23,546 kg of hashish; 7,745 kg of solid precursor chemicals; and 4,590 liters of liquid precursor chemicals. Several suspects were also arrested during the reporting period.

The Drug Enforcement Administration (DEA) continues to conduct CN activities throughout Afghanistan in close partnership with the interagency community. Between April 1, 2010 and July 31, 2010, DEA conducted 37 operations which resulted in 40 arrests and the seizure of 443 kg of opium, 82 kg of heroin, 318 kg of hashish, 3,930 kg of solid precursor chemicals, and 315 liters of liquid precursor chemicals.

CJIATF-N continued to expand its capacity and improve its targeting support. It is fully operational and continues to provide support for law enforcement investigations and military operations by analyzing key trafficking networks and improving visibility on powerbroker corruption in RC-S and RC-SW. CJIATF-N, in close coordination with military and law enforcement, initiated actions against corrupt officials. CJIATF-N will establish detachments nationwide to eliminate seams and attack complex threats, such as the insurgent-narcotics-corruption nexus. CJIATF-N targets network functions – safe haven, movement, communications, and finance – rather than targeting only individuals to disable the networks’ resiliency. CJIATF-N has enabled the Coalition to conduct a relentless assault on the insurgency, corruption, and the drug trade while amplifying pro-Afghan Government actors.

The Counternarcotics Training Academy (CNTA) continued to provide advanced training for Counternarcotics Police of Afghanistan (CNPA) officers. During the reporting period, the CNTA trained 122 officers. Its curriculum remains unchanged.

Supply reduction programs have been realigned to better support reductions in opium poppy cultivation and to capitalize on the blight that affected large portions of the poppy crop in the 2010 harvest season. The MCN presented a comprehensive national public awareness campaign, including a significant component dedicated to urging farmers to pursue licit alternatives in the upcoming planting season. Department of State’s International Narcotics and Law Enforcement (INL) will provide over 600,000 USD in public information funding in support of this pre-planting campaign through its implementing partner, the Colombo Plan.

The United States no longer conducts eradication. However, the United States supports the Afghan Government in its execution of the program of Governor-Led Eradication (GLE). The Afghan GLE Program will be an important contributor to potential reductions in the 2010 poppy crop. GLE ended in June, and although the overall number of hectares eliminated by Afghan officials under GLE is down by 20 percent from 2009, improved targeting and efforts by key governors will have an impact on the 2010 harvest. Eradication efforts took place in 11 provinces including the main poppy growing provinces with the notable exception of Kandahar, where cultivation has been growing in recent years. A total of 2,535 hectares of poppy eradication has been verified by the MCN and United Nations Office on Drug and Crime (UNODC).⁶⁰ In Helmand, it is assessed that there has been a steep change in the quality of eradication. The Governor of Helmand Province was forceful and focused in his approach to eradication in rich agricultural areas. GLE reached Nad-i-Ali District in Helmand province for the first time, resulting in the elimination of poppy in some of the province’s most fertile agricultural land. The Governor of Farah, for the first time, was able to conduct significant GLE

⁶⁰ MCN/UNODC Periodical Report on Poppy Eradication Verification in Afghanistan, June 28, 2010, No. 17 (report covers Feb - Jun 2010).

operations, leading to the elimination of 200 hectares of poppy. The MCN has directed GLE to increase the number of poppy-free provinces in 2010 by at least two provinces.

There has been both passive and active resistance to eradication. In Helmand Province, the eradication teams were attacked eight times during eradication operations, and there have also been attacks in Nangarhar. In these attacks, a total of 24 police and three farmers were killed; 21 police, six farmers and five tractor drivers were injured.⁶¹

6.3: Efforts to Improve Afghan Capacity

CNPA's specialized units continued to improve and deliver effects with the arrest of corrupt officials and drug traffickers. DoD, in coordination with INL and DEA, continued to provide training, equipment, and infrastructure support for CNPA's specialized unit. The MoI expanded the National Interdiction Unit (NIU) by reallocating 250 billets from the Poppy Eradication Force (PEF). DoD is continuing to provide training support for the NIU through the Regional Training Team (RTT) and Operational Support Team (OST). DoD also continued to provide support for the CNPA Development Unit (CDU), formerly known as the CNPA Development Cell (CDC). The CNPA, with support from the CDU, continues to improve its capabilities. The CDU, in concert with the CNPA leadership, designed and established a two-tier planning and management development program in the CNPA. At the executive level, the Deputy Minister and his principal division leaders established an Executive Planning Team (EPT) that is providing strategic direction and policy guidance for organizational development and improved policy and management decision making. In addition to the EPT, the CDU conducted a strategic workshop during which the mission, strengths and weaknesses, and critical organizational improvement goals and actions were developed. These goals, along with recent international and national assessment report recommendations, are driving the operational level and second tier plan execution. Each of the five operational directorates of the CNPA now has a Directorate Planning Team responsible for implementing the strategic development initiatives as well as daily operational planning and management efforts. The whole organization is now linked together in a comprehensive effort to define the improvements necessary to reach a higher level of professional performance across the CNPA and is committed to achieving that goal. To support the administrative sustainment of these planning and management teams, a strategic support unit is being trained within the Chief of Staff's office that will coordinate and support both the executive level and operational level planning actions.

The IOCC continues to provide support to law enforcement and interface with the military for law enforcement entities. The IOCC also works with the CNPA to improve the flow of information, build capacity, and develop an IOCC-like capability within the CNPA. DoD will continue to provide support for IOCC's efforts to build capacity.

The 20 million USD Counter Narcotics Advisory Teams (CNAT) program has been cancelled while new capacity building programs for the MCN are being designed in order to transfer increasing responsibility to the Ministry. CN Minister Zarar has increased the profile of counternarcotics issues within the Afghan government, securing a spot for the MCN on the Afghan National Security Council, preparing position papers for the Kabul Conference, and

⁶¹ Ibid.

leading a review of the Afghan National Drug Control Strategy. In June, at Minister Zarar's urging, President Karzai gave his first major speech on Afghanistan's narcotics problem.

In early June, the MoI's CNPA opened a new, U.S.-funded headquarters. For the first time, the CNPA's constituent units – including its lab, intelligence unit, and command structure – will be co-located, allowing for more effective investigations. The CNPA's specialized units, mentored by the DEA, continue to assume increased responsibility over complex investigations and interdictions.

The DEA, with DoD and DoS contractor support and funding, continues to support, train, and equip three specialized units within the CNPA: the National Interdiction Unit (NIU), the Technical Investigative Unit (TIU), and Sensitive Investigative Unit (SIU). The 320-member NIU – established by the DEA as a specialized tactical arm of the CNPA – is capable of safely conducting interdiction operations and seizures and serving arrest and search warrants in a high-threat environment, much like a U.S. Special Weapons and Tactics (SWAT) team. The Afghan NIU also includes a SIU of 43 specially vetted and trained host nation law enforcement officers. The SIU carries out complex counter drug investigations using intelligence developed by the TIU. The TIU is currently staffed by 11 specially vetted officers who perform the court-authorized judicial intercepts.

In June 2010, the DEA, in conjunction with the TIU and SIU, and the Afghan Ministry of Interior (MoI), utilized telephone intercepts to identify the threat and plan of attack inside the Peace Jirga Conference held in Kabul on June 2-4, 2010. As a result, authorities were able to locate three bombers. The MoI took all three individuals into custody. All three co-conspirators are members of the Taliban insurgent network.

Beginning in 2009 and currently ongoing, DEA began an expansive effort to target high-value drug traffickers through both focused mentoring of elite Afghan CN Forces and an increased operational presence. In particular, the DEA in-country staff is partnered with the Afghan Government to establish the drug enforcement institutions and capabilities needed to enforce the rule of law in Afghanistan. The Afghan Government has shown some improvement in prosecuting narcotics traffickers to date. On March 9, 2010, a DoJ-mentored Criminal Justice Task Force (a three judge panel) convicted and sentenced CNPA Operational Commander Sayed Hassan Karimi under the 2005 Afghanistan Counter Narcotics Law for violation of Article 15 (Drug Trafficking and Sale of Precursor Chemicals). Karimi was sentenced to 15 years imprisonment — the maximum prison sentence allowable under the minimum mandatory sentencing guidelines of the 2005 Afghanistan Counter Narcotics Law. This was a significant prosecution; no other Afghan defendant has been sentenced in excess of 15 years for trafficking precursor chemicals. He was also fined one million Afghans.

Afghanistan Vouchers for Increased Production in Agriculture (AVIPA) Plus Program in the South is a 250 million USD program for Helmand and Kandahar provinces. There are four components to this program. First, after an area is "cleared", the Cash-for-Work program provides alternative employment for Afghans. Cash-for-Work has employed over 110,000 people this year through the AVIPA program. Second in the process, small grants, currently averaging 100,000 USD each, are used. More than 13 million USD in small grants have been

dispersed this year and an additional nine million USD contracted. Third, vouchers are targeted toward high-value horticultural crops that will profitably compete with *poppy* production. Approximately 117,000 farmers have received vouchers so far this year with a value of 27 million USD. Training elements are included in each of the above components to improve the level of recipient technical capacity. A total of 111,000 people have received training this year. Currently 886 Afghans are working for the AVIPA program.

6.4: Afghan Threat Finance Cell

The Afghan Threat Finance Cell (ATFC) was formed to identify and disrupt the sources of funding supporting insurgent and terrorist organizations operating in Afghanistan. The ATFC works to develop information that will be used to prosecute or designate individuals, either in the United States or Afghanistan, who provide financial support to insurgents. The ATFC conducts a vast majority of its investigations and operations with vetted Afghan personnel from the DEA mentored SIU, the Public Prosecutors Office, and vetted judges. Information developed by the ATFC is passed to Afghan counterparts for their assistance and action, as well as to U.S. Government and ISAF law enforcement, military, and intelligence communities for action.

The ATFC is led by the DEA and comprises personnel from DoD, Department of the Treasury, Joint Warfare Analysis Center (JWAC), Federal Bureau of Investigations (FBI), and Immigration and Customs Enforcement (ICE). Personnel from the U.K. Serious Organized Crime Agency (SOCA) and the Australian Federal Police (AFP) are also assigned to work with the ATFC.

The ATFC achieved success in identifying and disrupting sources of funding to the Taliban, as well as other illicit financial activity. Specifically, the ATFC built target packages on Taliban financial facilitators to help shape the battlefield prior to operations in Marjah and built district level financial audits for Helmand, Kandahar, Farah, and Nimroze, mapping Taliban funding streams for use by battle space commanders. Recently, the ATFC generated tips and leads resulting in a warrant for the arrest of a senior Afghan United Bank official, accused of bribing senior Afghan government officials, causing President Karzai to order a handpicked commission to review scores of past and current anticorruption inquiries. In July 2010, Afghan vetted police officers arrested Mohammed Zia Salehi in Kabul, Afghanistan. As previously mentioned, Salehi is the Head of Administration of the Afghan National Security Council. Following the arrest of Salehi, President Karzai ordered his release and formed two commissions to examine the legality of the arrest. Although the commissions did not determine that the arrest was illegal, President Karzai's response to the Salehi arrest has raised concern within elements of the U.S. interagency and international coalition partners on how best to partner with the Afghan Government to meaningfully address corruption. Salehi's case remains pending with the second commission formed by President Karzai; it is unclear if the case will ever judicially proceed. Salehi is reportedly still a member of the Afghan National Security Council.

6.5: International Coordination

DoD continues to support organizations tasked to provide support for interdiction operations. The United States and United Kingdom conducted a joint review of the IOCC during the reporting period. The recommendations of the review team are being implemented in order to improve coordination at the tactical, operational, and strategic levels. The U.S. and U.K. Joint Narcotics Analysis Center (JNAC) in London will continue to conduct strategic level analysis while providing operational reach-back support for the IOCC. CJATF-N will focus on tactical operations while the IOCC conducts operational level network analysis and provides support to law enforcement.

Section 7 – Regional Engagement

The long-term stability and security of Afghanistan is intertwined in the dynamics of the region and the continuing influence, both positive and negative, of Afghanistan’s neighbors.

7.1: Pakistan

Afghanistan and Pakistan are inextricably linked. The Office of the Defense Representative, Pakistan (ODRP) assesses that Pakistani Violent Extremist organizations (VEOs) based in the FATA and the Khyber Pakhtunkhwa (KPk) maintain the intent and capability to conduct attacks both cross-border into Afghanistan as well as within Pakistan. The PAKMIL has been involved in nearly continuous operations since June 2009 in the KPk and the FATA. PAKMIL Forces in the FATA and the KPk remain at about 140,000 personnel. As the PAKMIL’s areas of operation have expanded, they have struggled to “hold and build” cleared terrain, although the PAKMIL has successfully disrupted insurgent networks in parts of the FATA and KPk. U.S. Special Operations Forces conducting train-and-equip activities with the PAKMIL made overall gains, particularly in the fusion of intelligence, and the overall military-to-military partnership has improved.

While the U.S. Government recognizes the tremendous effort continuous PAKMIL operations represent for the Pakistan Government, insurgent safe havens along the border will remain the primary problem to achieving a secure and stable Afghanistan. One initiative toward this end is increasing the cooperation between Afghanistan, ISAF, and Pakistan Forces along the border to provide a more comprehensive approach to eradicating the insurgency. Pakistan Army General Headquarters recently approved an ODRP and Coalition presence at the PAKMIL 12 Corps HQ in Quetta, Balochistan.

Overall, U.S. relations with the PAKMIL have improved. There have been many positive steps taken to dismantle extremist networks and deny terrorists safe havens in Pakistan. There is still much work to be done, but there is a positive trend line toward achieving the overall strategic goals.

7.2: India

India's presence in Afghanistan cannot be understood without considering the tense, fragile relationship between Pakistan and India. In the beginning of the reporting period, April 26-27, President Karzai visited New Delhi. The visit was seen as successful from both sides, with India reaffirming its commitment to Afghanistan as a reliable partner.

India continues to be one of Afghanistan's largest assistance donors, providing 1.3 billion USD funding for major infrastructure projects like power transmission, power lines, roads, etc. Work on the Salma hydroelectric dam in Herat Province continues. In addition, India provides agriculture assistance and has increased access to degree scholarships and training programs.

7.3: Central Asian States

The countries of Central Asia (Kazakhstan, Uzbekistan, Tajikistan, Kyrgyzstan, and Turkmenistan) continue to show their commitment to Afghanistan's development, especially in terms of energy cooperation. Uzbekistan is building a railway line from Hariton to Mazar-e-Sharif, and Kazakhstan has brought the first group of Afghan students to study in Kazakh universities under a \$50 million USD program to develop Afghan professionals. Most importantly, officials from Central Asia have worked closely with U.S. officials to diversify lines of communication (LOC) into, and out of, Afghanistan. These LOCs, including over-flight permissions and ground transit agreements, have provided critical additional logistics capacity through development of the Northern Distribution Network (NDN), providing alternative transportation routes into Afghanistan for commercial vendors to bring supplies to U.S. and ISAF forces in Afghanistan.

7.4: Iran

Iran continues active attempts to influence events in Afghanistan through support for the Karzai government; economic and cultural outreach to the Afghan population, particularly to minority populations; and covert support for various insurgent and political opposition groups, including weapons and training. Iran seeks to play a dominant role long term in the region and the Iranian Government assesses that the economic and security situation in Afghanistan will greatly impact the politics in the region over the mid-term.

At the highest political levels, Iran seeks to maintain positive relations with the Afghan Government, including President Karzai. In addition to maintaining a diplomatic presence in Afghanistan, Tehran often uses high-level visits and key leadership engagements to publicly criticize the presence of international community in Afghanistan and call for the withdrawal of ISAF. Since 2001, Tehran has pledged over 1 billion USD in aid to Afghanistan, but has actually disbursed only a fraction of that amount.

Iran continues to provide lethal assistance—including weapons and training—to elements of the Taliban. Tehran's support to the Taliban is inconsistent with their historic relationship. However, Tehran's actions support its overall strategy of backing many groups to ensure a

positive relationship with potential leaders and hedging against foreign presence and the host government.

Iran's historical, cultural, and economic ties with much of western Afghanistan, its religious affinity with Afghan minority groups, and its extensive border with Afghanistan will ensure that Tehran continues to play an active role in Afghanistan for the foreseeable future.

7.5: China

China's leaders continue to seek improved relations with, and stability and security for, Afghanistan, primarily in terms of an economic relationship focused on mineral extraction. Since 2002, China donated a total of 130 million USD in aid to the Government of Afghanistan. In 2009, China announced it would provide an additional 75 million USD over the next five years. Chinese companies are investing in Afghanistan, but progress is slow on the largest project, the four billion USD investments by the China Metallurgical Group Corporation and the Jiangxi Copper Corporation in the Aynak copper mine in Logar Province. In June, Afghan and Chinese delegations met under the umbrella of the Afghanistan-China Joint Economic Commission Committee in Kunming, China.

China is concerned about the security situation in Afghanistan, including issues such as narcotics trafficking and the safety of People's Republic of China workers in the country. China's Deputy Permanent Representative to the United Nations in June stated that "China had been keeping a close eye on developments there" and that "improving security in Afghanistan is of prime concern," noting the "marked increase in security incidents since the beginning of the year." China helped train Afghan security personnel, including dozens of minesweepers over the past year.

7.6: Russia

President Medvedev recognizes that Afghanistan remains a "common cause" between Russia and NATO-ISAF. For Russia, minimizing the threat of instability in the Northern Caucasus is closely tied to seeing through the mission in Afghanistan, where institutions and principles will serve as an impediment to the spread of extremism and narcotics smuggling across Russia and its close neighbors.

The Afghanistan Air Transit Agreement--offered by President Medvedev during the Presidents' April 2009 meeting in London, and signed at the July 2009 Moscow Summit--is a key contribution to the efforts in Afghanistan. The Air Transit Agreement allows for up to 4,500 military flights and unlimited commercial flights to transit Russian airspace on their way to Afghanistan each year. This agreement provides a significant diversification of ISAF supply routes to Afghanistan, by reducing transit times and fuel usage. Since the United States began exercising the agreement in October 2009, flights have become routine and have flown more than 71,000 personnel over Russia en route to Afghanistan. This is in addition to the thousands of containers of non-military supplies delivered to Afghanistan by Russian rail on the NDN. We continue to explore other transit cooperation agreements with Russia and other countries in the

region, with the aim of expanding the list of approved cargo to include military equipment and increasing bi-directional movement through Russia.

Russian officials, concerned about Afghan heroin trafficking, have a counternarcotics liaison in Afghanistan. Russia also operates a training course for Afghan counternarcotics police officers at a center at Domodedovo through the NATO-Russia Council Counter-Narcotics Project.

7.7: Gulf Cooperation Council (GCC) States

The member nations of the Gulf Cooperation Council continued to provide support to the Afghanistan stabilization effort. In addition to the military and financial contributions detailed elsewhere in this report, members of the GCC provided key basing facilities and access for forces operating in Afghanistan. In addition, several of the GCC countries provided critical air bases and overflight and transit rights for operations in Afghanistan and logistical support for these operations.

For example, Qatar continues to host the Coalition Air Operations Center, which provides airpower command and control for Afghanistan. Qatar also hosts CENTCOM's forward headquarters, which has a crucial command and control responsibility for Afghanistan. Bahrain hosts the NAVCENT headquarters, a key supporting effort for Afghan operations. Other GCC countries host key air and naval facilities and provide staging capability for combat, ISR, and logistics operations in support of the Afghan mission.

We expect the importance of GCC member states to rise as NATO Forces increase their numbers in Afghanistan.

Annex A – Acronyms

AAF	Afghan Air Force
ABP	Afghan Border Police
ACO	Afghan Correction Officer
ACSI	Afghan Civil Service Institute
ACU	Anti Corruption Unit
ADT	Agribusiness Development Team
AED	Afghanistan Engineer District
AFCEE	Air Force Center for Engineering and the Environment
AFP	Australian Federal Police
AIP	Aviation Incentive Pay
ALA	Afghan Land Authority
ALP	Afghan Local Police
ANATC	Afghan National Army Training Command
ANA	Afghan National Army
ANAAC	ANA Air Corps
ANAREC	ANA Recruiting Command
ANCOP	Afghan National Civil Order Police
ANDS	Afghan National Development Strategy
ANP	Afghan National Police
ANSF	Afghanistan National Security Forces
AO	Area of Operations
AP3	Afghan Public Protection Police
APPF	Afghan Public Protection Force
APRP	Afghan Peace and Reintegration Program
ARCENT	Army Central Command
ARTF	Afghanistan Reconstruction Trust Fund
ASFF	Afghan Security Forces Fund
ASI	Afghan Stabilization Initiative
ATFC	Afghan Threat Finance Cell
AUAF	American University of Afghanistan
AUP	Afghan Uniformed Police
AVIPA	Afghanistan Vouchers for Increased Production in Agriculture
AWEC	American Women's Education Center
BCP	Border Crossing Points
BSO	Battle Space Owner
BWT	Basic Warrior Training
C2	Command and Control
CAS	Close Air Support
CASEVAC	Casualty Evacuation
CDI	Community Defense Initiative
CDU	CNPA Development Unit
CE	Crises Establishment
CENTCOM	U.S. Central Command

CERP	Commander's Emergency Response Program
CIVCAS	Civilian Casualties
CFSOCC-A	Combined Forces Special Operations Component Command-Afghanistan
CFW	Cash for Work
CJIATF	Combined Joint Interagency Task Force
CJIATF-N	Combined Joint Interagency Task Force–Nexus
CJSOR	Combined Joint Statement of Requirements
CLB	Corps Logistics Battalion
CM	Capability Milestone
CN	Counternarcotics
CNAT	Counter Narcotics Advisory Teams
CNPA	Counternarcotics Police of Afghanistan
CNTA	Counternarcotics Training Academy
CoGS	Chief of the General Staff
COIN	counterinsurgency
COMIJC	Commander, ISAF Joint Command
COMISAF	Commander, International Security Assistance Force
COMUSFOR-A	Commander, US Forces - Afghanistan
CSTC-A	Combined Security Transition Command-Afghanistan
CUAT	Commander's Unit Assessment Tool
DCOM-ISC	Deputy Commanding General for International Security Cooperation
DCOM-P	Deputy Commander – Police
DEA	Drug Enforcement Administration
DF	Direct Fire
DFIP	Detention Facility in Parwan
DHQ	District Headquarters
DHS	Department of Homeland Security
DLA	Defense Logistics Agency
DoD	Department of Defense
DoJ	Department of Justice
DoS	Department of State
DSACEUR	Deputy Supreme Allied commander Europe
DST	District Support Team
ECC	Electoral Complaints Commission
EPT	Executive Planning Team
ETT	Embedded Training Team
EUPOL	European Union Police
FATA	Federally Administered Tribal Areas
FBI	Federal Bureau of Investigation
FP	force package
FWP	Former Warsaw Pact
FY	Fiscal Year
GCC	Gulf Cooperation Council
GDP	Gross Domestic Product
GS	General Staff
GSU	

HET	Heavy Equipment Transport
HF	high frequency
HHS	Health and Human Services
HIG	Hezb-e Islami Gulbuddin
HME	Home-made Explosives
HMMWV	Up-Armored High Mobility Multipurpose Wheeled Vehicle
HOO	High Office of Oversight
HQN	Haqqani Network
IARCSC	Independent Administrative Reform and Civil Service Commission
IC	International Community
ICE	Immigration and Customs Enforcement
IDF	Indirect Fire
IDLG	Independent Directorate of Local Governance
IEC	Independent Elections Commission
IED	improvised explosive devices
IJC	ISAF Joint Command
ILON	Inherent Law for Officers and NCOs
INL	International Narcotics and Law Enforcement Affairs Bureau
IOC	Initial Operating Capability
IPCB	International Police Coordination Board
ISAF	International Security Assistance Force
JANIB	Joint Afghan-NATO <i>Inteqal</i> Board
JCMB	Joint Coordination and Monitoring Board
JWAC	Joint Warfare Analysis Center
KE	Kinetic Event
KPk	Khyber Pakhtunkhwa
LEGATT	Legal Attaché
LeT	Lashkar-e Tayyiba
LOC	Line of Communication
LOTFA	Law and Order Trust Fund-Afghanistan
LTV	Light Tactical Vehicle
MAIL	Ministry of Agriculture, Irrigation and Livestock
MCTF	Major Crimes Task Force
MCN	Ministry of Counternarcotics
MDBR	Ministerial Development Board Review
MDCM	Ministerial Development Coordination Meeting
MEDEVAC	Medical Evacuation
MEF	Marine Expeditionary Force
MICC	MoI-led International Coordination Cell
MoD	Ministry of Defense
MoDA	Ministry of Defense Advisor
MoE	Ministry of Education
MoI	Ministry of Interior
MoM	Ministry of Mines
MOS	Military Occupational Specialty
MOTCA	Ministry of Transportation and Civil Aviation

MTV	Medium Tactical Vehicle
NAC	North Atlantic Council
NATC-A	NATO Air Training Command-Afghanistan
NATO	North Atlantic Treaty Organization
NCO	Non Commissioned Officer
NDAA	National Defense Authorization Act
NDN	Northern Distribution Network
NEPS	Northeast Power System
NGO	Non Governmental Organization
NIU	National Interdiction Unit
NTM-A	NATO Training Mission Afghanistan
OCS	Officer Candidate School
ODC	Operational Deployment Cycle
ODRP	Office of the Defense Representative, Pakistan
OEF	Operation Enduring Freedom
OMLT	Operational Mentoring and Liaison Team
OPLAN	Operations Plan
OST	Operational Support Team
PAKMIL	Pakistan military
PEF	Poppy Eradication Force
PHQ	Provincial Headquarters
PIMs	personnel information management system
PME	Professional Military Education
POI	program of instruction
POMLT	Police Operational Mentoring and Liaison Teams
PRT	Provincial Reconstruction Team
QST	Quetta Shura Taliban
RC	Regional Command
RDL	Rating Definition Level
RMTC	Regional Military Training Center
RTT	Regional Training Team
SCR	Senior Civilian Representative
SEPS	Southeast Power System
SIU	Sensitive Investigative Unit
SNG	Sub National Governance
SOCA	Serious Organized Crime Agency
SOF	Special Operations Forces
SRSG	Special Representative of the UN Secretary-General for Afghanistan
SY	Solar Year
TCN	troop contributing nations
TF	Task Force
TIU	Technical Investigative Unit
TLC	Team Leader Courses
TTP	Tehrik-e Taliban Pakistan
UAH	Up-Armored High Mobility Multipurpose Wheeled Vehicle
UK	United Kingdom

UN	United Nations
UNAMA	United Nations Assistance Mission-Afghanistan
UNDP	United Nations Development Program
UNODC	United Nations Office on Drugs and Crime
U.S.	United States
USACE	U.S. Army Corps of Engineers
USAID	Agency for International Development
USD	U.S. Dollars
USDA	U.S. Department of Agriculture
USFOR-A	United States Forces-Afghanistan
USMC	United States Marine Corps
VEO	Violent Extremist Organization
VCA	Vulnerability to Corruption Assessment
VSO	Village Stability Operations
WPS	Western Power System

Annex B – FY2008 NDAA Section 1230, with FY2010 NDAA Section 1236

PUBLIC LAW 110-181—JAN. 28, 2008

122 STAT. 385

SEC. 1230. REPORT ON PROGRESS TOWARD SECURITY AND STABILITY IN AFGHANISTAN.

(a) **REPORT REQUIRED.**—Not later than 90 days after the date of the enactment of this Act, and every 180 days thereafter through the end of fiscal year 2010, the President, acting through the Secretary of Defense, shall submit to the appropriate congressional committees a report on progress toward security and stability in Afghanistan. President.

(b) **COORDINATION.**—The report required under subsection (a) shall be prepared in coordination with the Secretary of State, the Director of National Intelligence, the Attorney General, the Administrator of the Drug Enforcement Administration, the Administrator of the United States Agency for International Development, the Secretary of Agriculture, and the head of any other department or agency of the Government of the United States involved with activities relating to security and stability in Afghanistan.

(c) **MATTERS TO BE INCLUDED: STRATEGIC DIRECTION OF UNITED STATES ACTIVITIES RELATING TO SECURITY AND STABILITY IN AFGHANISTAN.**—The report required under subsection (a) shall include a description of a comprehensive strategy of the United States for security and stability in Afghanistan. The description of such strategy shall consist of a general overview and a separate detailed section for each of the following:

(1) **NORTH ATLANTIC TREATY ORGANIZATION INTERNATIONAL SECURITY ASSISTANCE FORCE.**—A description of the following:

(A) Efforts of the United States to work with countries participating in the North Atlantic Treaty Organization (NATO) International Security Assistance Force (ISAF) in Afghanistan (hereafter in this section referred to as “NATO ISAF countries”).

(B) Any actions by the United States to achieve the following goals relating to strengthening the NATO ISAF, and the results of such actions:

(i) Encourage NATO ISAF countries to fulfill commitments to the NATO ISAF mission in Afghanistan, and ensure adequate contributions to efforts to build the capacity of the Afghanistan National Security Forces (ANSF), counter-narcotics efforts, and

reconstruction and development activities in Afghanistan.

(ii) Remove national caveats on the use of forces deployed as part of the NATO ISAF.

(iii) Reduce the number of civilian casualties resulting from military operations of NATO ISAF countries and mitigate the impact of such casualties on the Afghan people.

(2) **AFGHANISTAN NATIONAL SECURITY FORCES.**—A description of the following:

(A) A comprehensive and effective long-term strategy and budget, with defined objectives, for activities relating to strengthening the resources, capabilities, and effectiveness of the Afghanistan National Army (ANA) and the Afghanistan National Police (ANP) of the ANSF, with the goal of ensuring that a strong and fully-capable ANSF is able to independently and effectively conduct operations and maintain security and stability in Afghanistan.

(B) Any actions by the United States to achieve the following goals relating to building the capacity of the ANSF, and the results of such actions:

(i) Improve coordination with all relevant departments and agencies of the Government of the United States, as well as NATO ISAF countries and other international partners.

(ii) Improve ANSF recruitment and retention, including through improved vetting and salaries for the ANSF.

(iii) Increase and improve ANSF training and mentoring.

(iv) Strengthen the partnership between the Government of the United States and the Government of Afghanistan.

(3) **PROVINCIAL RECONSTRUCTION TEAMS AND OTHER RECONSTRUCTION AND DEVELOPMENT ACTIVITIES.**—A description of the following:

(A) A comprehensive and effective long-term strategy and budget, with defined objectives, for reconstruction and development in Afghanistan, including a long-term strategy with a mission and objectives for each United States-led Provincial Reconstruction Team (PRT) in Afghanistan.

(B) Any actions by the United States to achieve the following goals with respect to reconstruction and development in Afghanistan, and the results of such actions:

(i) Improve coordination with all relevant departments and agencies of the Government of the United States, as well as NATO ISAF countries and other international partners.

(ii) Clarify the chain of command, and operations plans for United States-led PRTs that are appropriate to meet the needs of the relevant local communities.

(iii) Promote coordination among PRTs.

(iv) Ensure that each PRT is adequately staffed, particularly with civilian specialists, and that such staff receive appropriate training.

(v) Expand the ability of the Afghan people to assume greater responsibility for their own reconstruction and development projects.

(vi) Strengthen the partnership between the Government of the United States and the Government of Afghanistan.

(vii) Ensure proper reconstruction and development oversight activities, including implementation, where appropriate, of recommendations of any United States inspectors general, including the Special Inspector General for Afghanistan Reconstruction appointed pursuant to section 1229.

(4) COUNTER-NARCOTICS ACTIVITIES.—A description of the following:

(A) A comprehensive and effective long-term strategy and budget, with defined objectives, for the activities of the Department of Defense relating to counter-narcotics efforts in Afghanistan, including—

(i) roles and missions of the Department of Defense within the overall counter-narcotics strategy for Afghanistan of the Government of the United States, including a statement of priorities;

(ii) a detailed, comprehensive, and effective strategy with defined one-year, three-year, and five-year objectives and a description of the accompanying allocation of resources of the Department of Defense to accomplish such objectives;

(iii) in furtherance of the strategy described in clause (i), actions that the Department of Defense is taking and has planned to take to—

(I) improve coordination within the Department of Defense and with all relevant departments and agencies of the Government of the United States;

(II) strengthen significantly the Afghanistan National Counter-narcotics Police;

(III) build the capacity of local and provincial governments of Afghanistan and the national Government of Afghanistan to assume greater responsibility for counter-narcotics-related activities, including interdiction; and

(IV) improve counter-narcotics-related intelligence capabilities and tactical use of such capabilities by the Department of Defense and other appropriate departments and agencies of the Government of the United States; and

(iv) the impact, if any, including the disadvantages and advantages, if any, on the primary counter-terrorism mission of the United States military of providing enhanced logistical support to departments and agencies of the Government of the United States and counter-narcotics partners of the United States in their interdiction efforts, including apprehending or eliminating major drug traffickers in Afghanistan.

(B) The counter-narcotics roles and missions assumed by the local and provincial governments of Afghanistan and the national Government of Afghanistan, appropriate

departments and agencies of the Government of the United States (other than the Department of Defense), the NATO ISAF, and the governments of other countries.

(C) The plan and efforts to coordinate the counter-narcotics strategy and activities of the Department of Defense with the counter-narcotics strategy and activities of the Government of Afghanistan, the NATO-led interdiction and security forces, other appropriate countries, and other counter-narcotics partners of the United States, and the results of such efforts.

(D) The progress made by the governments, organizations, and entities specified in subparagraph (B) in executing designated roles and missions, and in coordinating and implementing counternarcotics plans and activities, and based on the results of this progress whether, and to what extent, roles and missions for the Department of Defense should be altered in the future, or should remain unaltered.

(5) **PUBLIC CORRUPTION AND RULE OF LAW.**—A description of any actions, and the results of such actions, to help the Government of Afghanistan fight public corruption and strengthen governance and the rule of law at the local, provincial, and national levels.

(6) **REGIONAL CONSIDERATIONS.**—A description of any actions and the results of such actions to increase cooperation with countries geographically located around Afghanistan's border, with a particular focus on improving security and stability in the Afghanistan-Pakistan border areas.

(d) **MATTERS TO BE INCLUDED: PERFORMANCE INDICATORS AND MEASURES OF PROGRESS TOWARD SUSTAINABLE LONG-TERM SECURITY AND STABILITY IN AFGHANISTAN.**—

(1) **IN GENERAL.**—The report required under subsection (a) shall set forth a comprehensive set of performance indicators and measures of progress toward sustainable long-term security and stability in Afghanistan, as specified in paragraph (2), and shall include performance standards and progress goals, together with a notional timetable for achieving such goals.

(2) **PERFORMANCE INDICATORS AND MEASURES OF PROGRESS SPECIFIED.**—The performance indicators and measures of progress specified in this paragraph shall include, at a minimum, the following:

(A) With respect to the NATO ISAF, an assessment of unfulfilled NATO ISAF mission requirements and contributions from individual NATO ISAF countries, including levels of troops and equipment, the effect of contributions on operations, and unfulfilled commitments.

(B) An assessment of military operations of the NATO ISAF, including of NATO ISAF countries, and an assessment of separate military operations by United States forces. Such assessments shall include—

(i) indicators of a stable security environment in Afghanistan, such as number of engagements per day, and trends relating to the numbers and types of hostile encounters; and

(ii) the effects of national caveats that limit operations, geographic location of operations, and estimated number of civilian casualties.

(C) For the Afghanistan National Army (ANA), and separately for the Afghanistan National Police (ANP), of the Afghanistan National Security Forces (ANSF) an assessment of the following:

(i) Recruitment and retention numbers, rates of absenteeism, vetting procedures, and salary scale.

(ii) Numbers trained, numbers receiving mentoring, the type of training and mentoring, and number of trainers, mentors, and advisers needed to support the ANA and ANP and associated ministries.

(iii) Type of equipment used.

(iv) Operational readiness status of ANSF units, including the type, number, size, and organizational structure of ANA and ANP units that are—

(I) capable of conducting operations independently;

(II) capable of conducting operations with the support of the United States, NATO ISAF forces, or other coalition forces; or

(III) not ready to conduct operations.

(v) Effectiveness of ANA and ANP officers and the ANA and ANP chain of command.

(vi) Extent to which insurgents have infiltrated the ANA and ANP.

(vii) Estimated number and capability level of the ANA and ANP needed to perform duties now undertaken by NATO ISAF countries, separate United States forces and other coalition forces, including defending the borders of Afghanistan and providing adequate levels of law and order throughout Afghanistan.

(D) An assessment of the estimated strength of the insurgency in Afghanistan and the extent to which it is composed of non-Afghan fighters and utilizing weapons or weapons-related materials from countries other than Afghanistan.

(E) A description of all terrorist and insurgent groups operating in Afghanistan, including the number, size, equipment strength, military effectiveness, sources of support, legal status, and any efforts to disarm or reintegrate each such group.

(F) An assessment of security and stability, including terrorist and insurgent activity, in Afghanistan-Pakistan border areas and in Pakistan's Federally Administered Tribal Areas.

(G) An assessment of United States military requirements, including planned force rotations, for the twelve-month period following the date of the report required under subsection (a).

(H) For reconstruction and development, an assessment of the following:

(i) The location, funding (including the sources of funding), staffing requirements, current staffing levels, and activities of each United States-led Provincial Reconstruction Team.

(ii) Key indicators of economic activity that should be considered the most important for determining the prospects of stability in Afghanistan, including—

(I) the indicators set forth in the Afghanistan Compact, which consist of roads, education, health, agriculture, and electricity; and

(II) unemployment and poverty levels.

(I) For counter-narcotics efforts, an assessment of the activities of the Department of Defense in Afghanistan, as described in subsection (c)(4), and the effectiveness of such activities.

(J) Key measures of political stability relating to both central and local Afghan governance.

(K) For public corruption and rule of law, an assessment of anti-corruption and law enforcement activities at the local, provincial, and national levels and the effectiveness of such activities.

(e) **FORM.**—The report required under subsection (a) shall be submitted in unclassified form, but may include a classified annex, if necessary.

(f) **CONGRESSIONAL BRIEFINGS.**—The Secretary of Defense shall supplement the report required under subsection (a) with regular briefings to the appropriate congressional committees on the subject matter of the report.

(g) **APPROPRIATE CONGRESSIONAL COMMITTEES DEFINED.**—In this section, the term “appropriate congressional committees” means—

(1) the Committee on Armed Services, the Committee on Appropriations, and the Committee on Foreign Affairs of the House of Representatives; and

(2) the Committee on Armed Services, the Committee on Appropriations, and the Committee on Foreign Relations of the Senate.

SEC. 1231. UNITED STATES PLAN FOR SUSTAINING THE AFGHANISTAN NATIONAL SECURITY FORCES.

(a) **PLAN REQUIRED.**—Not later than 90 days after the date of the enactment of this Act, and annually thereafter through the end of fiscal year 2010, the Secretary of Defense shall submit to the appropriate congressional committees a report on a long-term detailed plan for sustaining the Afghanistan National Army (ANA) and the Afghanistan National Police (ANP) of the Afghanistan National Security Forces (ANSF), with the objective of ensuring that a strong and fully-capable ANSF will be able to independently and effectively conduct operations and maintain long-term security and stability in Afghanistan.

(b) **COORDINATION.**—The report required under subsection (a) shall be prepared in coordination with the Secretary of State.

(c) **MATTERS TO BE INCLUDED.**—The report required under subsection (a) shall include a description of the following matters relating to the plan for sustaining the ANSF:

(1) A comprehensive and effective long-term strategy and budget, with defined objectives.

(2) A mechanism for tracking funding, equipment, training, and services provided for the ANSF by the United States, countries participating in the North Atlantic Treaty Organization (NATO) International Security Assistance Force (ISAF) in Afghanistan (hereafter in this section referred to as “NATO ISAF countries”), and other coalition forces that are not part of the NATO ISAF.

(3) **DEFENSE SERVICES.**—The term “defense services” has the meaning given the term in section 644(f) of such Act (22 U.S.C. 2403(f)).

(4) **MILITARY AND SECURITY FORCES.**—The term “military and security forces” means national armies, national air forces, national navies, national guard forces, police forces and border security forces, but does not include non-governmental or irregular forces (such as private militias).

(h) **EXPIRATION.**—The authority provided under subsection (a) may not be exercised after September 30, 2010.

(i) **EXCESS DEFENSE ARTICLES.**—

(1) **ADDITIONAL AUTHORITY.**—The authority provided by subsection (a) is in addition to the authority provided by section 516 of the Foreign Assistance Act of 1961.

(2) **AGGREGATE VALUE.**—The value of excess defense articles transferred to Iraq or Afghanistan during fiscal year 2010 pursuant to section 516 of the Foreign Assistance Act of 1961 shall not be counted against the limitation on the aggregate value of excess defense articles transferred contained in subsection (g) of such Act or against the limitation on the aggregate value of defense articles transferred contained in subsection (b)(1) of this section.

(j) **RULE OF CONSTRUCTION.**—Nothing in this section shall be construed as to provide the authority to refurbish, transport, or otherwise assist in the transfer to Iraq or Afghanistan of excess defense articles outside of Iraq or Kuwait as of the date of the enactment of this Act.

SEC. 1235. ANALYSIS OF REQUIRED FORCE LEVELS AND TYPES OF FORCES NEEDED TO SECURE SOUTHERN AND EASTERN REGIONS OF AFGHANISTAN.

(a) **STUDY REQUIRED.**—The Secretary of Defense may, in support of the Commander of United States Forces for Afghanistan (USFOR-A), enter into a contract with a Federally Funded Research Development Center (FFRDC) to provide an analysis of the required force levels and types of forces needed to implement the Commander’s strategic objectives in Afghanistan, including securing the southern and eastern regions of Afghanistan in order to provide a space for the Government of Afghanistan to establish effective government control and provide the Afghan security forces with the required training and mentoring.

(b) **FUNDING.**—From funds made available for the Department of Defense by section 301(5) for operation and maintenance, Defense-wide activities, \$3,000,000 may be used to carry out subsection (a).

SEC. 1236. MODIFICATION OF REPORT ON PROGRESS TOWARD SECURITY AND STABILITY IN AFGHANISTAN.

(a) **REPORT REQUIRED.**—Subsection (a) of section 1230 of the National Defense Authorization Act for Fiscal Year 2008 (Public Law 110-181; 122 Stat. 385) is amended by striking “2010” and inserting “2011”.

(b) **MATTERS TO BE INCLUDED: STRATEGIC DIRECTION OF UNITED STATES ACTIVITIES RELATING TO SECURITY AND STABILITY IN AFGHANISTAN.**—Subsection (c) of such section is amended—

(1) in paragraph (1)—

(A) by redesignating subparagraph (B) as subparagraph (C); and

(B) by inserting after subparagraph (A) the following new subparagraph:

“(B) A description of commitments or agreements by NATO ISAF countries regarding the following:

“(i) Mutually agreed upon goals.

“(ii) Strategies to achieve such goals.

“(iii) Resource and force requirements.

“(iv) Commitments and pledges of support regarding troops and resource levels.”;

(2) by redesignating paragraphs (2) through (6) as paragraphs (3) through (7), respectively; and

(3) by inserting after paragraph (1) the following new paragraph:

“(2) NON-NATO ISAF TROOP-CONTRIBUTING COUNTRIES.—A description of commitments or agreements with non-NATO ISAF troop-contributing countries regarding the following:

“(A) Mutually agreed upon goals.

“(B) Strategies to achieve such goals.

“(C) Resource and force requirements.

“(D) Commitments and pledges of support regarding troops and resource levels.”.

(c) MATTERS TO BE INCLUDED: PERFORMANCE INDICATORS AND MEASURES OF PROGRESS TOWARD SUSTAINABLE LONG-TERM SECURITY AND STABILITY IN AFGHANISTAN.—Subsection (d)(2) of such section is amended—

(1) in subparagraph (A), by striking “individual NATO ISAF countries” and inserting “each individual NATO ISAF country”;

(2) by redesignating subparagraphs (C) through (K) as subparagraphs (D) through (L), respectively;

(3) by inserting after subparagraph (B) the following new subparagraph:

“(C) With respect to non-NATO ISAF troop-contributing countries, a listing of contributions from each individual country, including levels of troops and equipment, the effect of contributions on operations, and unfulfilled commitments.”;

(4) by redesignating subparagraphs (F) through (L) (as redesignated) as subparagraphs (G) through (M), respectively;

(5) by inserting after subparagraph (E) (as redesignated) the following new subparagraph:

“(F) An assessment of progress in ending the ability of the insurgency (including the Taliban, Al Qaeda, and other anti-government elements), to establish control over the population of Afghanistan or regions of Afghanistan and establish safe havens in Afghanistan, and to conduct attacks inside or outside Afghanistan from such safe havens.”; and

(6) in subparagraph (J) (as redesignated)—

(A) by redesignating clause (ii) as clause (iv); and

(B) by inserting after clause (i) the following:

“(ii) The coordination of reconstruction and development activities in Afghanistan, including—

“(I) the roles of members of the Armed Forces and non-Armed Forces personnel within the staffing of United States-led Provincial Reconstruction Teams;

“(II) the use of members of the Armed Forces for reconstruction, development, and capacity building programs outside the jurisdiction of the Department of Defense; and

“(III) the coordination between United States-led and other international-led programs to develop the capacity of national, provincial, and local government and other civil institutions as well as reconstruction and development activities in Afghanistan.

“(iii) Unfilled staffing and resource requirements for United States reconstruction, development, and civil institution capacity building programs.”

(d) **CONFORMING AMENDMENT.**—Subsection (d)(2) of such section, as amended, is further amended in subparagraph (K) (as redesignated) by striking “subsection (c)(4)” and inserting “subsection (c)(5)”.

(e) **EFFECTIVE DATE.**—The amendments made by this section shall apply with respect to any report required to be submitted under section 1230 of the National Defense Authorization Act for Fiscal Year 2008 (Public Law 110-181; 122 Stat. 385) after December 31, 2009.

SEC. 1237. NO PERMANENT MILITARY BASES IN AFGHANISTAN.

None of the funds authorized to be appropriated by this Act may be obligated or expended by the United States Government to establish any military installation or base for the purpose of providing for the permanent stationing of United States Armed Forces in Afghanistan.

Subtitle C—Other Matters

SEC. 1241. REPORT ON UNITED STATES ENGAGEMENT WITH IRAN.

(a) **IN GENERAL.**—Not later than January 31, 2010, the President shall submit to Congress a report on United States engagement with Iran. President.

(b) **ELEMENTS.**—The report required by subsection (a) shall include the following:

(1) **DIPLOMATIC ENGAGEMENT.**—With respect to diplomatic engagement, the following:

(A) A description of areas of mutual interest to the Government of the United States and the Government of the Islamic Republic of Iran in which cooperation and discussion could be of mutual interest.

(B) A discussion and assessment of the commitment of the Government of the Islamic Republic of Iran to engage in good-faith discussions with the United States to resolve matters of concern through negotiation.

(C) An assessment of direct contacts between the Government of the United States and the Government of the Islamic Republic of Iran, including any direct discussions, exchange of letters, or other activities.

(2) **SUPPORT FOR TERRORISM.**—An assessment of the types and amount of support provided by Iran to groups designated by the United States as foreign terrorist organizations and