

16th CCRTS
“Collective C2 in Multinational Civil-Military Operations”

Title of Paper:

**An Open Source Graphical User Interface Surrogate C2 System
for Battle Management Language Experimentation**

Topics:

Topic 6: Experimentation, Metrics, and Analysis
Topic 8: Architectures, Technologies, and Tools
Topic 10: C2, Management, and Governance in Civil-Military Operations

Authors:

Mohammad Ababneh [STUDENT] and J. Mark Pullen

C4I Center
George Mason University
4400 University Dr.
Fairfax, VA 22030
mpullen@c4i.gmu.edu

Report Documentation Page

Form Approved
OMB No. 0704-0188

Public reporting burden for the collection of information is estimated to average 1 hour per response, including the time for reviewing instructions, searching existing data sources, gathering and maintaining the data needed, and completing and reviewing the collection of information. Send comments regarding this burden estimate or any other aspect of this collection of information, including suggestions for reducing this burden, to Washington Headquarters Services, Directorate for Information Operations and Reports, 1215 Jefferson Davis Highway, Suite 1204, Arlington VA 22202-4302. Respondents should be aware that notwithstanding any other provision of law, no person shall be subject to a penalty for failing to comply with a collection of information if it does not display a currently valid OMB control number.

1. REPORT DATE JUN 2011	2. REPORT TYPE	3. DATES COVERED 00-00-2011 to 00-00-2011			
4. TITLE AND SUBTITLE An Open Source Graphical User Interface Surrogate C2 System for Battle Management Language Experimentation		5a. CONTRACT NUMBER			
		5b. GRANT NUMBER			
		5c. PROGRAM ELEMENT NUMBER			
6. AUTHOR(S)		5d. PROJECT NUMBER			
		5e. TASK NUMBER			
		5f. WORK UNIT NUMBER			
7. PERFORMING ORGANIZATION NAME(S) AND ADDRESS(ES) George Mason University, C4I Center, 4400 University Dr, Fairfax, VA, 22030		8. PERFORMING ORGANIZATION REPORT NUMBER			
9. SPONSORING/MONITORING AGENCY NAME(S) AND ADDRESS(ES)		10. SPONSOR/MONITOR'S ACRONYM(S)			
		11. SPONSOR/MONITOR'S REPORT NUMBER(S)			
12. DISTRIBUTION/AVAILABILITY STATEMENT Approved for public release; distribution unlimited					
13. SUPPLEMENTARY NOTES Presented at the 16th International Command and Control Research and Technology Symposium (ICCRTS 2011), Qu?c City, Qu?c, Canada, June 21-23, 2011. U.S. Government or Federal Rights License.					
14. ABSTRACT Battle Management Language (BML) has been under development since 2003. BML shows a promising capability for command and control to simulation interoperability, enabling a robust system of systems for training, mission rehearsal, and course of action analysis. An important issue in BML development is the ability to inspect and modify XML-encoded information flowing among C2 and simulation systems. We have developed an open-source tool for this purpose called the BMLC2GUI. Our work was inspired by Fraunhofer FKIE's C2 Lexical Grammar GUI. The BMLC2GUI provides an easy to use, open-source graphical user interface for BML users and developers. It can serve not only as a development tool but also as a surrogate for C2 system input/output. The BMLC2GUI was developed as a Java application. It uses other open-source tools to generate a user interface. JAXFront, from Xcentric, generates forms at run-time, based on the schema of an XML document. OpenMap, from BBN, is used to display geospatial data and control features residing in the BML document (Orders and Reports) on the map. The BMLC2GUI is able to act as data source or sink and provide an examination capability for development testing by pushing and pulling XML files from the supporting Web service and also by subscribing to a publish/subscribe interface. Moreover, it has the facilities necessary to stand in for a minimal C2 system that can be used when developing simulations and interfacing them to BML.					
15. SUBJECT TERMS					
16. SECURITY CLASSIFICATION OF:			17. LIMITATION OF ABSTRACT Same as Report (SAR)	18. NUMBER OF PAGES 69	19a. NAME OF RESPONSIBLE PERSON
a. REPORT unclassified	b. ABSTRACT unclassified	c. THIS PAGE unclassified			

Abstract

Battle Management Language (BML) has been under development since 2003. BML shows a promising capability for command and control to simulation interoperability, enabling a robust system of systems for training, mission rehearsal, and course of action analysis. An important issue in BML development is the ability to inspect and modify XML-encoded information flowing among C2 and simulation systems. We have developed an open-source tool for this purpose, called the BMLC2GUI. Our work was inspired by Fraunhofer FKIE's C2 Lexical Grammar GUI. The BMLC2GUI provides an easy to use, open-source graphical user interface for BML users and developers. It can serve not only as a development tool but also as a surrogate for C2 system input/output.

The BMLC2GUI was developed as a Java application. It uses other open-source tools to generate a user interface. JAXFront, from Xcentric, generates forms at run-time, based on the schema of an XML document. OpenMap, from BBN, is used to display geospatial data and control features residing in the BML document (Orders and Reports) on the map. The BMLC2GUI is able to act as data source or sink and provide an examination capability for development testing by pushing and pulling XML files from the supporting Web service and also by subscribing to a publish/subscribe interface. Moreover, it has the facilities necessary to stand in for a minimal C2 system that can be used when developing simulations and interfacing them to BML.

1. Introduction

This paper describes a developmental supporting technology for interoperation of command and control (C2) systems with simulation systems. The general technology area on which we report is Battle Management Language (BML), which aims to provide an unambiguous information exchange for such interoperation [1-3]. C2 electronic documents implemented in BML are Orders and Reports; also, in the future Requests (documents that provide tasks to be done, but without the force of command; for example, Request for Fire). The supporting technology is the BML Command & Control Graphical User Interface (BMLC2GUI), which provides a tool for development of BML interfaces by inspection/modification of data in BML messages encoded in the Extensible Markup Language (XML) and also can stand in for a minimal C2 system to generate orders and receive reports. We refer to the BMLC2GUI at some places in this document as “the GUI.”

1.1 BML and BML experiments

The NATO Modeling and Simulation Group (MSG) technical activity 048 (MSG-048) was chartered to evaluate the potential of BML for coalition C2-simulation interoperability. Coalition operations have a need for interoperability that is even greater than that of national Service and Joint operations. Because coalitions must function under greater complexity due to significant differences among doctrine and human language barriers, the agility to train and rehearse rapidly

before the actual operation is highly important [4]. MSG-048 adopted a SOA approach [5]; its first major demonstration employed the WS development for JBML. Our organization developed SBML to support subsequent demonstrations and experimentation by MSG-048. The scope of the final experimentation conducted by MSG-048 [6-8] is evident in Figure 1. The potential of this approach to extend to multinational civil-military operations, based on the availability of C2 systems and simulations that work across the civil-military boundary, is evident.

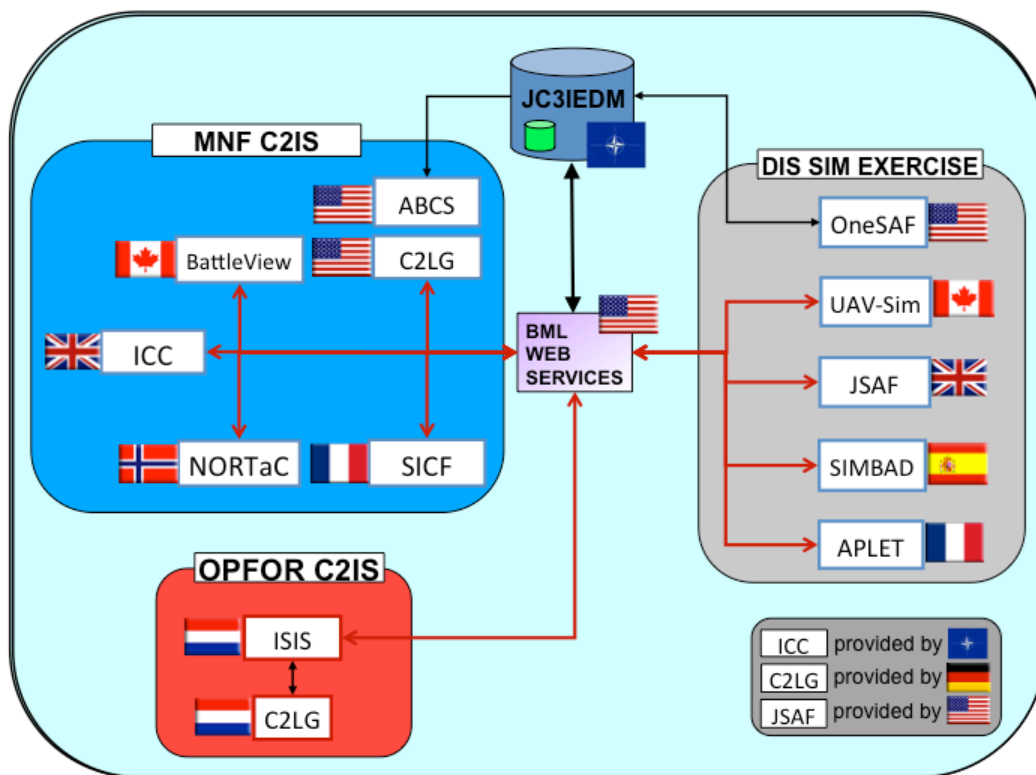

Figure 1. MSG-048 Experimentation Architecture

During MSG-048 experimentation, the Command and Control Lexical Grammar graphical user interface (C2LG) system element in Figure 1, developed by Fraunhofer FKIE, proved a valuable system element in that it supported review and, where necessary, modification of BML orders in the experimental environment. In consultation with Fraunhofer FKIE, we determined that an open-source interface with similar functionality would provide a valuable capability for the BML community as it engages in developing, prototyping, and experimentation.

1.2 BMLC2GUI

Accordingly, we have developed the BMLC2GUI, based on inspiration from Fraunhofer FKIE's C2LG GUI with additional functionality described in this paper, as part of the open source tools associated with our Scripted BML (SBML) server project [9]. The GUI is an open-source user interface tool that represents information flowing to/from C2 and simulation systems in text and image formats.

The main purpose of the GUI is to provide an easy-to-use graphical user interface to BML users and developers that can serve as a surrogate input/output C2 GUI or alternately to monitor (and, if necessary, revise) BML documents flowing to/from BML client systems. The GUI is a Java application that generates an interface using other open-source tools: Xcentric's JAXFront and BBN's OpenMap. Figure 2 shows a screen capture of the GUI.

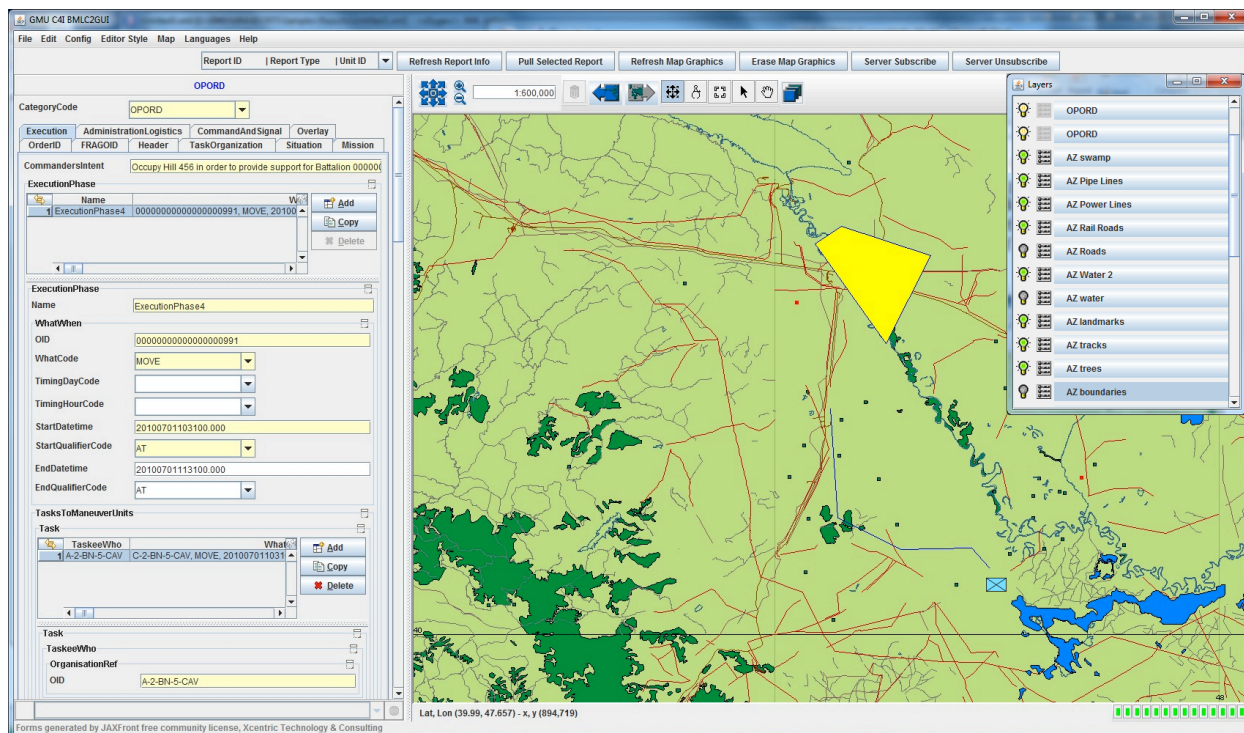

Figure 2. The BMLC2GUI

The GUI provides an easy and efficient alternative for the end user to edit, validate, and push BML orders to the SBML Web Services and also to pull and view BML reports from the services. The GUI also can subscribe to the SBML subscription service so that the GUI will be updated whenever a new report is published. The map will depict geospatial information from the BML document the user is editing or revising, displaying the correct symbols representing the objects or units in addition to all the mapping capabilities supported by OpenMap. BMLC2GUI uses the OpenMap implementation of military standard MilStd2525b for unit and object symbol representation [10].

Editing and issuing a BML order or report is simple to achieve using the GUI. It requires only data field entry and selection of items from drop down lists, which are populated automatically from enumerations in the associated schema. The GUI can accommodate changes in BML schemas easily because all of the GUI generation happens at run time. Furthermore, the GUI provides for serialization for BML documents, enabling manual edit of XML, including validate, save, and push capabilities.

2. GMU Open Source BML Systems

The BMLC2GUI was developed to enhance the use and implementation of BML and related technologies. In this section we provide some background information about these. The software and extensive documents are available at <http://c4i.gmu.edu/BML>.

2.1 BML

Battle Management Language (BML) and its various proposed extensions are intended to facilitate interoperation among command and control (C2) and modeling and simulation (M&S) systems by providing a common, agreed-to format for the exchange of information such as Orders and Reports. This is accomplished by providing a repository service that the participating systems can use to post and retrieve messages expressed in BML, which allows a configuration with multiple C2 and simulation systems to operate without all systems online and functioning simultaneously, resulting in a more robust overall system.

The BML service is implemented as middleware and can be either centralized or distributed. Recent implementations have employed standard XML along with Web service (WS) technology, a choice that is consistent with the Network Centric Operations strategy currently being adopted by the US Department of Defense and its coalition allies [5]. As an academic research center, our mission is to support the extension of knowledge, both through research and by supporting development of early versions of a new capability. One way we do that is to implement open source software systems, designed for use in a prototyping or experimental environment, that are sufficiently robust to support community developmental efforts broadly. The Scripted BML server and BMLC2GUI were developed as part of such an effort.

2.2 Scripted BML

Experience in development of BML indicates that the language will continue to grow and change. This is likely to be true of both the BML itself and of the underlying database representation used to implement the BML Web Services. However, it also has become clear that some aspects of BML middleware are likely to remain the same for a considerable time, namely, the XML input structure and the need for the BML WS to store a representation of BML in a well-structured relational database, accessed via the Structured Query Language (SQL). This implies an opportunity for a re-usable system component: a Scripting Engine, driven by a BML Schema combined with a Mapping File that accepts BML *push* and *pull* transactions and processes them according to a script, also written in XML, but with an alternate representation in a more concise Condensed Scripting Language (CSL). While the scripted approach may have lower performance when compared to hard-coded implementations, it has several advantages:

- new BML constructs can be implemented and tested rapidly
- changes to the data model underlying the database can be implemented and tested rapidly
- the ability to change the service rapidly reduces cost and facilitates prototyping
- the scripting language provides a concise definition of BML-to-data model mappings that facilitates review and interchange needed for collaboration and standardization

The heart of SBML is a scripting engine, described in [9], that implements a BML WS by converting BML data into a database representation and also by retrieving information from the database and generating BML as output. It could implement any XML-based BML and any SQL-realized underlying data model. Current SBML scripts implement the Joint Command, Control and Consultation Information Exchange Data Model (JC3IEDM). In the following description, any logically consistent and complete data model could replace JC3IEDM.

Version 2 of SBML implements a publish/subscribe capability [7], using the Java Message Service (JMS) as implemented by JBoss in open source [12]. Version 2 also implements the XML Path Language (XPATH) [13,14], wherever a relative path in the input is required. JBoss 4.2.3 JBoss Messaging, an implementation Java JMS 1.1 [15] which provides both point to point messaging between two entities (JMS Queues) and a subscription based distribution mechanism (JMS Topics) for publishing messages to multiple subscribers. JMS provides reliable delivery of messages for all subscribers to a particular Topic.

SBML version 2.3 provides a set of preconfigured JBossMQ Topics, which are used for the distribution of incoming Orders and periodic Reports to any interested subscribers. There is an XPath statement associated with each Topic, serving as a filter to determine whether each received message should be written to that Topic. The publish/subscribe architecture is depicted in Figure 3.

2.3 *BMLC2GUI*

The GUI complements SBML in our open source suite of tools. It is beneficial because C2 and simulation client systems do not necessarily display the XML documents they produce and consume. However, it sometimes is beneficial to modify those XML documents in system prototyping and software debugging and to display geospatial data from the XML documents graphically. The GUI performs these functions. It is available as open source and so can be modified to meet related needs in other BML projects. Thus it can expedite prototyping and component development for future BML systems.

The GUI implements the SBMLSubscriber Client application to connect to the subscription service of the SBMLServer. This client connectivity enables the GUI to listen to any BML activity such as Reports being generated. The Subscriber in the GUI accepts new BML Reports of any type and displays them immediately on the screen in the editing/viewing panel in addition to extracting the geospatial information and displaying it in the map panel. This extends the power of publish/subscribe operation to the GUI.

3. *BMLC2GUI* Requirements

This section describes the basic functional requirements of the GUI, in terms of the supporting technologies it encapsulates.

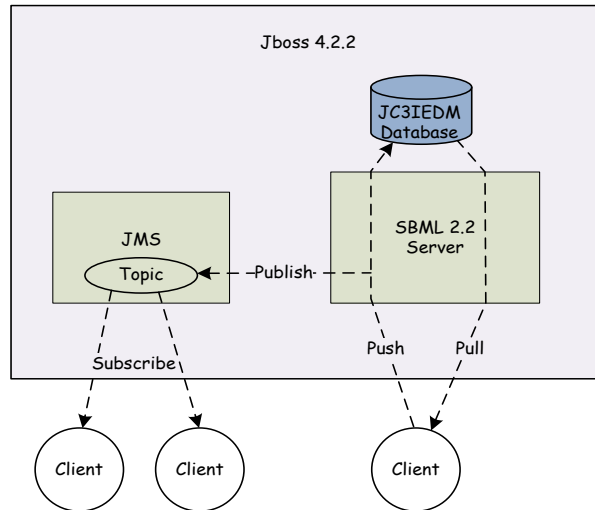

Figure 3. Publish/Subscribe Architecture for SBML

3.1 Generating BML Forms Automatically

The GUI uses the Free Community version (Open-Source) of JaxFront as its major component for editing BML documents. JaxFront is a technology developed by Switzerland's Xcentric Technology & Consulting GmbH, which can "generate graphical user interfaces on multiple channels (Java Swing, HTML, PDF) on the basis of an XML schema" [16]. It can be used to dynamically generate GUIs that allow the user to edit XML data without understanding the underlying XML technology. JAXFront is both an open-source and a commercial product. It has some restrictions if it is to be used as open-source in any project. The most significant of these is that the project has also to be open-source and publicly available. Figure 4 shows the architecture of JAXFront.

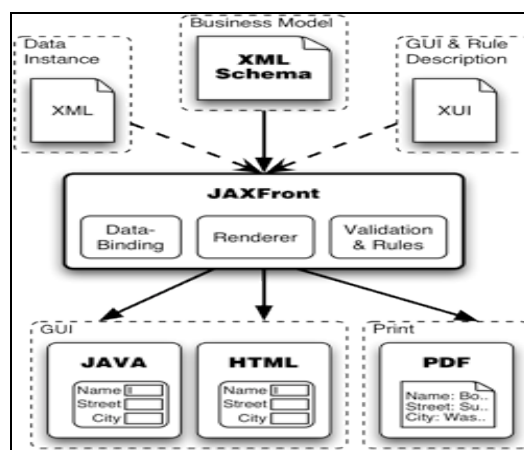

Figure 4. JAXFront's Architecture.

3.2 JAXFront's XUI Editor

In addition to the open-source distribution libraries, JAXFront provides an “XUI Editor”. The XML User Interface (XUI) editor is used to produce XUI definitions (.xui files). The XUI file defines and describes features of the user interface in XML, providing control and customization capability for the user interface.

The GUI is able to generate the user interface without an XUI definition causing a default view, by assigning a null value to the xuiUrl configuration variable. However, we use the XUI editor to create a “Tab” view that generally is more suitable for BML documents.

3.3 Embedded Geographic Information System Interface

OpenMap is an open-source JavaBeans-based geospatial development tool. OpenMap can be used to quickly build applications and applets that access data from legacy databases and applications. It provides various capabilities to allow users to see and manipulate geospatial information. Currently, the GUI uses OpenMap 4.6.5, released March 5, 2009 [17].

OpenMap supports various map data files; as of writing the GUI is using ESRI shape files. Our GUI uses OpenMap to display multiple data layers on the map in addition to drawing BML objects, units and control measures. The GUI uses the OpenMap implementation of the MilStd2525b unit symbols as illustrated in figure 5. It also can show associated geographical information layers if available in the map file.

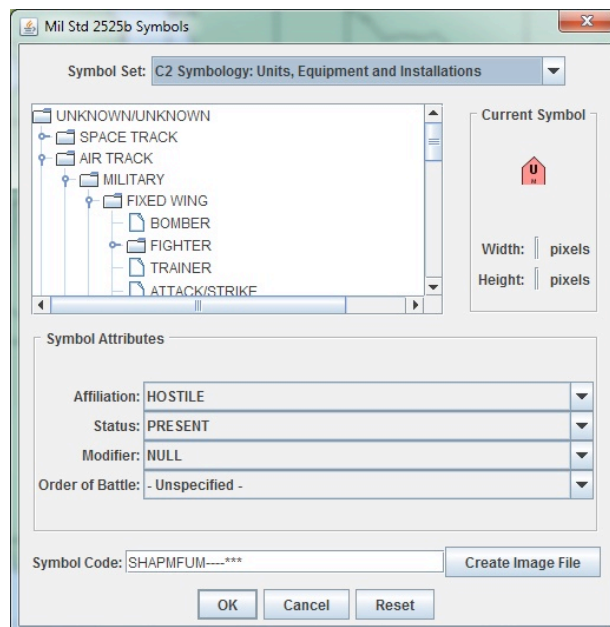

Figure 5. OpenMap MilStd2525b implementation

4. Development of the BMLC2GUI

The development of the GUI required two significantly different efforts. The first of these was the development of the tool itself, including implementation of the two major open-source tools described above, without which the GUI could not exist. The second effort was integration of other BML technologies developed by the larger BML team. These included implementation of the SBML client, subscription to the service, and interaction with the various query services that respond to the GUI requests. The following subsections provide more details about the development. Additional information is available in [18]; open-source software and documentation is available at <http://c4i.gmu.edu/BML>.

4.1 *BMLC2GUI development goals inspired by C2LG-GUI*

Command and Control Lexical Grammar (C2LG) is a formal grammar supporting and enforcing BML [19,20]. It enables the generation of standard representation of BML Orders, Reports or Requests. The C2LG GUI was developed to make it easier for the user to formulate correct C2LG messages [8].

The BMLC2GUI's goals differ from those of the C2LG GUI:

- Open source: The BMLC2GUI employs two well-developed open source tools; JaxFront and OpenMap, and is itself open source software. This makes it available for the BML community to adapt and customize without being limited and constrained by the licensing conditions of other software. C2LG was developed under support of the German Ministry of Defense and is not available for general use.
- Quick response to changes: in a prototyping or experimental environment, where the XML schema may change frequently, the ability for the tools to adapt automatically without reprogramming is important.
- Ease of use: The BMLClient depicted in Figure 3 employs XML tools including an XML Editor but without requiring the user to know technical details of operating system interaction that is required to employ the SBML package. The GUI hides these details from the user. Further, because of its open source nature, the GUI makes available a working code example of SBML client implementation for developers of other clients.
- Low development cost: making use of open-source tools greatly accelerated the development and reduced the cost of the GUI.

4.2 *User interface development*

The core of the GUI employs JAXFront open source libraries to build a new and a customized type of XML Document Object Module (DOM) that can be rendered as Java Swing objects. The DOM Builder requires the following parameters to generate a JAXFront document:

- The XML document: in W3C-standard XML format [21]
- The schema: in W3C-standard XSD format [22]
- The optional JaxFront XML User Interface (XUI) file
- Identification of the document's root node

BML orders and reports both are treated as XML documents. The only difference between the two lies in the parameters used to build the document, particularly the XUI file, which controls the view of the document in addition to the schema. JAXFront's DOMBuilder uses Xerces DOM [23] to build the renderable XML document.

The other important JAXFront component used by the GUI is the EditorPanel, which is a Java Swing panel that hosts all the Swing components generated by the DOMBuilder. The GUI uses a Java swing JSplitPane that displays the JAXFront Editor Panel in its left component. A complementary tool is displayed in the right component; in the present implementation, this is the OpenMap MapPanel.

After successful rendering of the XML document, the GUI extracts geospatial information and displays it on the map. Latitude and longitude (LAT-LON) coordinates represent positions of objects. This is accomplished by using the JAXFront document "getRootType" method to parse the document into a string and then populate an array with the document's elements and values.

The MapHandler class in OpenMap is responsible for managing the layers of geospatial data that need to be displayed on the MapPanel. The GUI implements a RouteLayer class for drawing BMLs geospatial data. The RouteLayer constructor accepts an array representing the LAT-LON coordinates of control measure objects and the locations and positions of other objects. Based on the type of the object and count of LAT-LON pairs, the RouteLayer draws the corresponding shape, which can be one of the following basic shapes:

- Point: if there is only one LAT-LON coordinate pair
- Polygon: if the number of pairs is greater than 1 and the last pair was the same as the first pair.
- Line: if the number of pairs is greater than 1 and the last pair was not the same as the first pair (actually, this is a sequence of connected line segments).

The RouteLayer also extracts the UnitID value and invokes the SBML Service "ListWho" to get the rest of unit information in order to collect the 14 characters used by MILSTD2525b to draw the correct symbol at the exact position. If the unit information is unavailable, then a default symbol will be drawn.

The GUI can be configured to subscribe to the SBML server's publish/subscribe service. If this is done, the GUI will receive Java Messaging Service (JMS) Topic messages from the server. These are BML/XML documents: Orders and Reports. The GUI uses XPath to parse the document to obtain the report type and then calls the "openReportWS" method that displays the report in the Editor Panel, extracts the geospatial data and displays the corresponding graphical object(s) at the correct position. When multiple reports arrive consequently, and they are all related to a single BML information element such as unit position, the GUI can be considered to be in a role serving as a command and control (C2) system for situational awareness. Figure 6 shows a unit moving along a track, which is actually an accumulated view of multiple position reports.

5 BMLC2GUI Functions

In this section, we provide a brief description of the main functionality of the GUI.

5.1 Editing a BML document

The GUI can edit any type of BML/XML document. The user has the capability in the GUI to create a new order or a report or to edit an existing one. This includes changing, deleting, validating, and serializing the document; also the ability to push the document to a Web service. This capability was the core of our project: providing an easy-to-use, user-friendly interface to BML/XML documents that otherwise would have to be edited manually through a text editor or with a more generic XML editor.

5.2 Serialization of a BML document

The GUI provides a capability to access the XML source of any document being edited. The user can save this serialized source to a standard XML file that can be used with any application supporting the XML standard. This feature is very useful to users may want to view the XML-coded format and also in setting up experiments related to newly developed BML capabilities. We anticipate that it also will be useful with integration efforts when BML is used between systems or organizations, including civil/military interoperation.

5.3 Validating a BML document

The GUI provides a capability to validate a BML document against the XML schema pertaining to that document. This allows validation before sending the document to the Web service in order to confirm conformance with the schema, without which the BML document will not be usable by the Web service. When the validation option is selected, validation problems can be displayed in the GUI's status bar and also a red box can be produced around the XML text area exhibiting the problem.

5.4 Pulling a BML document

The GUI provides a capability to pull BML documents from the SBML server in three possible ways:

1. From the file system, by entering the OrderID or ReportID. If the Order or Report exists, it will be displayed in the editor otherwise an error message will be generated.
2. By activating the "SBMLSubscriber" listener client application, which subscribes to a Topic, listens to published BML documents (most often, Reports), automatically detects the type of BML document, and displays it in the editor area. It will also extract any geospatial data from the report and display it on the map.
3. By selecting the desired report from a Report Information list of the latest reports added from the Web service. The report info includes: "Report ID", "Report Type" and "Object ID". The user can get the latest reports by pressing the "Refresh Report Info" and after selecting the report "Pull Selected Report" will open it.

5.5 Pushing a BML document

The GUI provides a capability to create, edit, validate (optionally) and push any BML/XML document. This is used most often for Orders. In the community of BML users, it is highly desirable to have a tool that provides a clear, simple user interface for creating and editing BML documents. The GUI provides the capability for validation also as described in section 5.3; however, in some situations (for example, when it is known the producing software is providing valid output documents), validation might be skipped.

When the user is ready to push the order, the GUI provides a simple user interface to do so with a click of a button. This activates the SBMLClient application with parameters representing the target of this push operation (server designation plus the document to be pushed). Based on these parameters, the server processes the Order or Report, publishes it, and saves it to the intended servers according to its configuration.

5.6 Retrieving latest reports

The GUI provides a capability to obtain a drop-down list of reports consisting of the Report ID, Type and Object/Unit ID. The user has the capability to refresh this list manually in addition to the automatic update while the subscriber is running. The user can select any report from the list and view that report on the GUI, both document view and geospatial information representation.

5.7 Configuration and customization at runtime

The BMLC2GUI makes use of the same JAXFront editing capabilities to configure its environment variables that would otherwise need to be hard-coded (for example, the SBML server name or network address, the domain name, and the location of the folder containing most of the tool components). An XML file describing this data can be edited at runtime to redefine the GUI configuration. After editing and saving these changes, the configuration is activated immediately. Appendix 2 shows a sample configuration XML file and its schema. Figure 7 shows the GUI Configuration screen.

Some of the most important configuration items in the GUI are:

- SBML Server: designates server from which orders are pulled or subscribed
- Report BML type
- Order Server: designates server to which orders are pushed.
- Domain Name: used to indicate how SBML will handle the document
- WhereXPath of the geospatial information in the BML document:
used to display the information on the map
- Initial map LAT-LON for startup
- Map scale for startup
- BMLC2GUI software path in the host computer

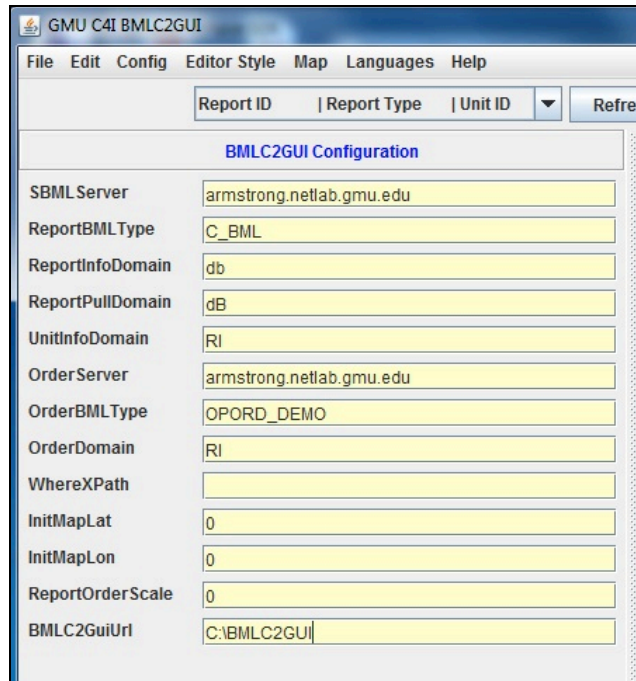

Figure 7. BMLC2GUI Configuration

5.8 Map configuration

The BMLC2GUI geospatial interface is modular and could be used with various mapping or image display components. As of this writing, the GUI uses OpenMap version 4.6.5 in this role and is able to take advantage of all OpenMap features. OpenMap supports a variety of data formats; this release of the GUI uses ESRI “shape” format (extension .shp). The user can add or remove any of the map data files by editing the “BMLC2GUI.properties” OpenMap configuration file. This avoids coding the information in the GUI code and gives the user the flexibility to specify graphic layers that can be enabled to support the C2 view.

6 Using the GUI as Surrogate C2 system

In this section we provide two examples that demonstrate the use of the BMLC2GUI tool as an editor with geospatial capabilities and a surrogate command and control tool.

6.1 Example 1: IBML Order and Reports: OneSAF and IBML/SBML

This example shows the use of the GUI in the Integration of OneSAF and Integrated BML (IBML) [8] technologies. The role that the GUI played in the reported integration experiment spanned all phases. While this experiment provided evidence of the compatibility with other technologies, it also showed the accuracy of the tool in representing available geospatial information. Figure 8 shows the principal functions employed.

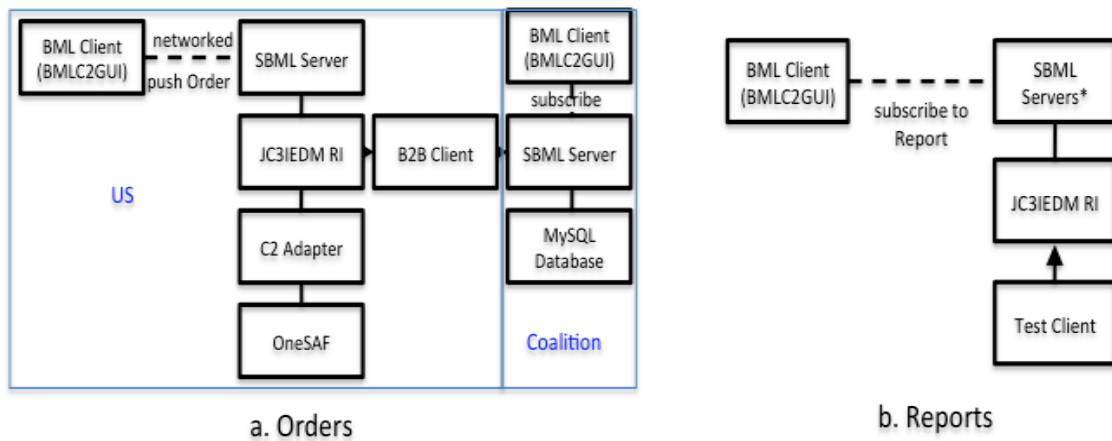

Figure 8. Using the BMLC2GUI in Integration Process

The steps of the experiment and the role of the BMLC2GUI are as follows:

1. Editing the IBML order: The GUI was used to open an existing IBML order and edit it to reflect the intended contents. Figure 9 shows the GUI's editor with the IBML order.

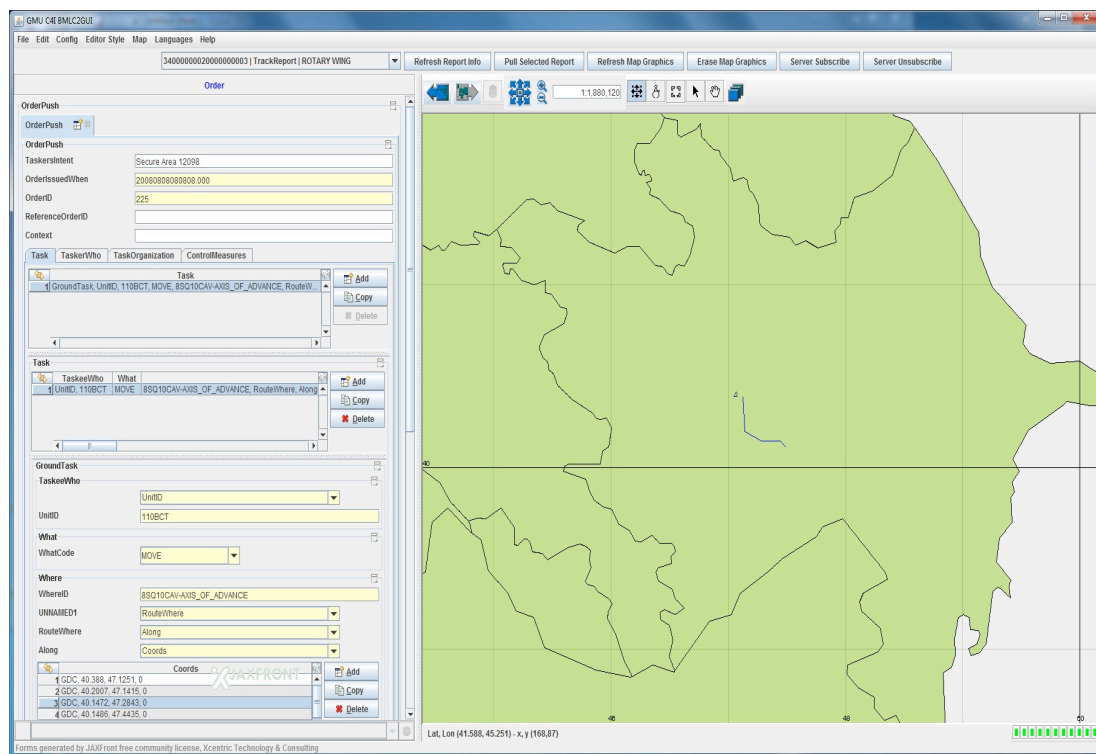

Figure 9. IBML Order in text panel of GUI

2. Validating the IBML Order: The GUI operator can validate the IBML order by selecting a menu option. The validation results will be displayed and the operator can behave accordingly.
3. Pushing the Order: The operator selects to push the order by selecting the menu option and gets feedback whether the order was pushed successfully.
4. Pulling the Order: The operator pulls the Order by selecting a menu option and providing the OrderID; the GUI retrieves the order from the web services and the persisted database.
5. Subscription: The Operator subscribes to the Subscription service of the SBML server by clicking a button. The OneSAF simulation will start generating reports according to the Order. These Reports go to the SBML server and are published to subscribing clients.
6. Receiving reports: The GUI will start receiving position reports as shown in Figure 10. The unit details level depends on the unit and the Report format, and can be confirmed on the OneSAF display.

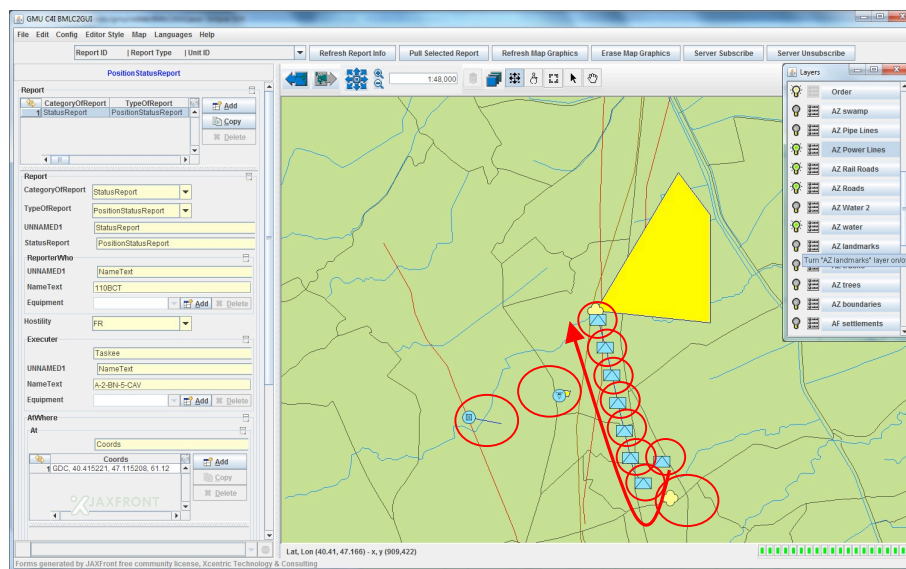

Figure 10. Experiment position, track, mine and bridge reports

6.2 Example 2: NATO OPORD using SISO C-BML draft schema

This example shows the benefit of using the BMLC2GUI with BML technologies under development. At the time of writing, a new C-BML schema is being developed by the SISO Coalition Battle Management Language Product Development Group (C-BML PDG) [24]. In situations where the schema is still under development it is beneficial to give the users and the development community an immediate feedback for every change or addition. This is facilitated by the GUI's ability to generate forms at runtime, based on the latest schema draft.

Supporting the C-BML development team at GMU, the BMLC2GUI assisted in various ways.

1. Based on the schema under development, the GUI provided a graphical interface form for OPORD editing; entry and modification giving the developers an instantaneous feedback of the quality and the correctness of each new idea implemented. This editor part was generated easily through a menu item selection and provided a tab view of the OPORD. It also provided drop down menus for the selection of already enumerated values from the schema. Figure 11 shows the OPORD in the GUI.

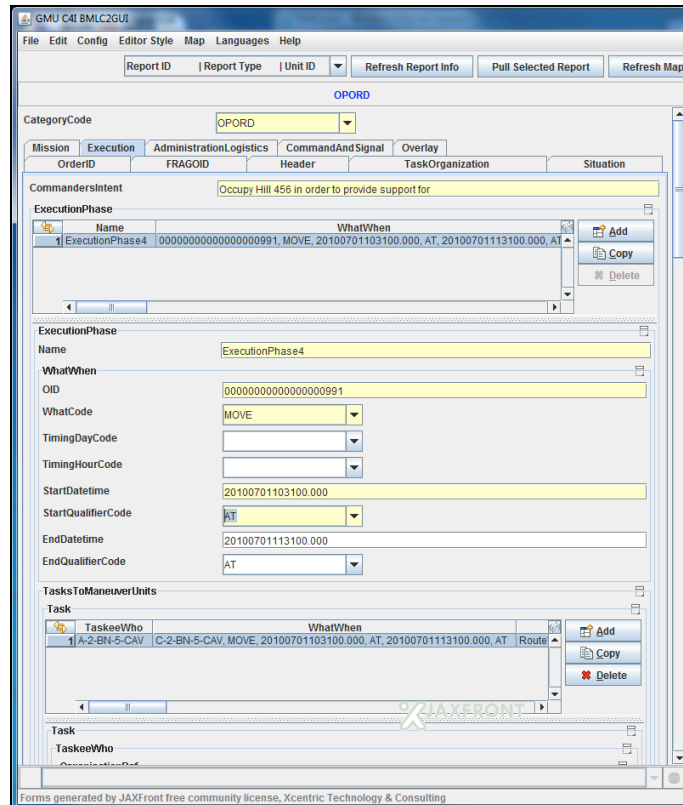

Figure 11. OPORD in the BMLC2GUI Editor based on draft schema

2. The GUI played a useful role in validating the schema and the OPORD documents because of the built-in validation capabilities provided by JaxFront. This is essential for any development effort working with XML encoding; having it provided automatically by the GUI relieved the developers from running a separate validation step.
3. The GUI was used to generate example OPORD documents containing geospatial information, based on the new schema. The GUI is able to generate realistic examples containing accurate location and unit movement information and display them on the map in addition to geographical layers available. Figure 12 shows the geographical information representation of the OPORD on the map.

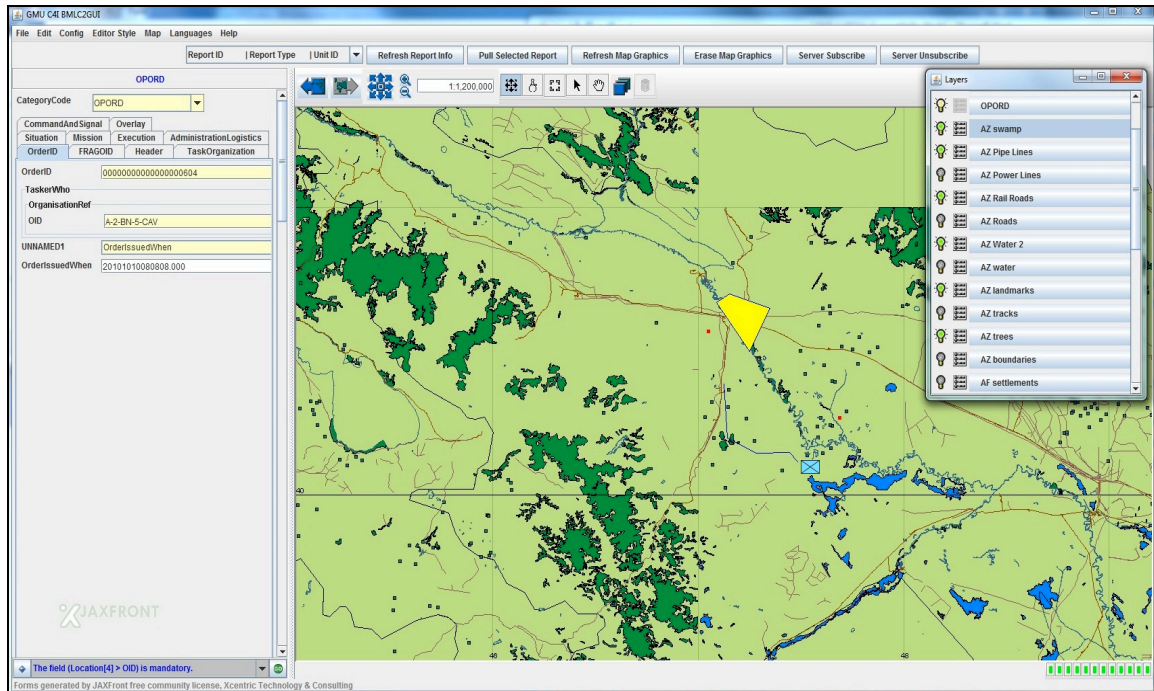

Figure 12. BMLC2GUI OPOrd Mapping capabilities supported by OpenMap.

4. The BMLC2GUI was used to receive the reports generated after pushing the OPOrd through the SBML web services using the publish/subscribe capabilities of the SBML Server and the client implemented in the GUI tool. Various types of reports are displayed immediately after being published, so developers may see the units or objects either positioned in their locations or moving towards their targets in a manner similar to Figure 10 above.

7 Conclusions and Future Work

The BMLC2GUI provides a powerful, easy-to-use tool for BML developers that also can be used as a surrogate C2 system, with these capabilities:

- Generates easy-to-use forms for entering, reading, and editing XML documents, based on latest schemas available at runtime.
- Relieves the user from the use of a separate XML editor and knowledge of platform specific instructions to run BML pull and push commands.
- Provides capability of seeing the geospatial information in the documents being edited or viewed.
- Enables the user to validate and serialize the documents even without being connected to the services at the editor level instead of waiting until the execution results appear.
- Has open source availability that makes it less expensive to obtain and operate such a tool and at the same time makes possible customization and enhancements by the BML community.

Our original intention for creating the BMLC2GUI was to support the development process. However, we have used it multiple times to stand in for C2 systems that either were unavailable or would have been expensive to obtain for experimental work. This gives the GUI even more potential value to the C2, simulation, and operational communities as the use of BML grows. We look forward to seeing its use and adaptation for US, coalition, and civil-military systems that interoperate C2 and simulations.

8 References

- [1] Carey, S., M. Kleiner, M. Hieb, and R. Brown, "Standardizing Battle Management Language – A Vital Move Towards the Army Transformation," IEEE Fall Simulation Interoperability Workshop, Orlando, FL, 2001
- [2] Sudnikovich, W., J. Pullen, M. Kleiner, and S. Carey, "Extensible Battle Management Language as a Transformation Enabler," in *SIMULATION*, 80:669-680, 2004
- [3] Levine, S. *et al.*, "Joint Battle Management Language (JBML) Phase 1 Development and Demonstration Results," IEEE Fall Simulation Interoperability Workshop, Orlando, FL, 2007
- [4] Tolk, A, M. Hieb, K. Galvin, L. Khimeche, and J. Pullen, "Developing a Coalition Battle Management Language to facilitate Interoperability between Operation CIS and Simulations in support of Training and Mission Rehearsal", 10th Command and Control Research and Technology Symposium, McLean, VA, 2005
- [5] Pullen, J., M. Hieb and S. Levine, "Using Web Service-Based Command and Control to Support Coalition Collaboration in C2 and Simulation," 13th International Command and Control Research and Technology Symposium, Seattle, WA, 2008
- [6] de Reus, N., R. de Krom, O. Mevassvik, A. Alstad, U. Schade and M. Frey, "BML-enabling national C2 systems for coupling to Simulation," IEEE Spring Simulation Interoperability Workshop, 2008, Newport, RI
- [7] Heffner, K. *et al.*, "NATO MSG-048 C-BML Final Report Summary," SCS/SISO Euro-Simulation Interoperability Workshop, Ottawa, Canada, 2010
- [8] Pullen, J. *et al.*, "Integrating National C2 and Simulation Systems for BML Experimentation," SCS/SISO Euro Simulation Interoperability Workshop, Ottawa, Canada, 2010
- [9] Pullen, J., D. Corner, L. Nicklas and S. Singapogu, "Supporting NATO C2-Simulation Experimentation with Scripted Web Services", 15th International Command and Control Research and Technology Symposium, Quebec, Canada, 2011
- [10] US Department of Defense, "Interface Standard Common War fighting Symbology MIL-STD-2525B w/Change 1", July 2005
- [11] Corner, D., J. Pullen, S. Singapogu and B. Bulusu, "Adding Publish/Subscribe to the Scripted Battle Management Language Web Service," IEEE Spring 2010 Simulation Interoperability Workshop, Orlando FL, 2010
- [12] <http://www.jboss.org>
- [13] <http://www.w3.org/TR/xpath>
- [14] World Wide Web Consortium, "XPath Language Version 1.0", November 16, 1999
- [15] Sun Microsystems, "JAVA Message Service 1.1" April 12, 2002.
- [16] <http://www.jaxfront.org>
- [17] <http://openmap.bbn.com>
- [18] Ababneh, M. and J. Pullen, "Battle Management Language – Command and Control Graphical Use Interface," IEEE Fall Simulation Interoperability Workshop, Orlando, FL, 2010

- [19] Schade, U. and M. Hieb, "Development of Formal Grammars to Support Coalition Command and Control: A Battle Management Language for orders, Requests, and Reports, 11th International command and Control Research and Technology Symposium, Cambridge, UK, 2006
- [20] Schade, U., and M. Hieb. "Battle Management Language: A Grammar for Specifying Reports," IEEE Spring Simulation Interoperability Workshop, 2007, Norfolk, VA
- [21] World Wide Web Consortium, "Extensible Markup Language (XML)", <http://www.w3.org/standard/techs/xml>
- [22] World Wide Web Consortium, "XML Schema: Formal Description", <http://www.w3.org/standards/xml/schema>
- [23] <http://xerces.apache.org>
- [24] <http://www.sisostds.org/StandardsActivities/DevelopmentGroups>

Appendix 1: A Sample Mine Field Report XUI File

```
<?xml version="1.0" encoding="UTF-8"?>
<?jaxfront version=2.61;time=2010-02-04
11:09:03.218;xsd=IBMLSIMCIReports.xsd;nsMapping=%KEYhttp://www.jaxfront.com/xui%VAL%KEYht
tp://www.w3.org/2001/XMLSchema%VALxsd%KEYhttp://www.w3.org/2001/XMLSchema-
instance%VALxsi?>
<XUI xsi:schemaLocation="http://www.jaxfront.com/xui
jar:file:/C:/Program%20Files/JAXFront-2.6/lib/jaxfront-core.jar!/xui.xsd"
xmlns="http://www.jaxfront.com/xui" xmlns:xsi="http://www.w3.org/2001/XMLSchema-
instance">
  <component xpath="/MINOBREP">
    <style>
      <treeEntry>
        <occurrence>
          <visibility>
            <never/>
          </visibility>
        </occurrence>
      </treeEntry>
    </style>
  </component>
  <component xpath="/MINOBREP/CornerLocation/bml:ControlFeature">
    <style>
      <mode visible="false">
        <message/>
      </mode>
    </style>
  </component>
  <component xpath="/MINOBREP/Parameters/BypassGrid/bml:ControlFeature">
    <style>
      <mode visible="false">
        <message/>
      </mode>
      <treeEntry>
        <occurrence>
          <visibility>
            <never/>
          </visibility>
        </occurrence>
      </treeEntry>
    </style>
  </component>
</XUI>
```

Appendix 2: A Sample BMLC2GUI Configuration File

```
<?xml version="1.0" encoding="UTF-8"?>
<?jaxfront version=2.50;time=2011-01-28
10:41:12.45;xui=BMLC2GUIConfigView.xui;xsd=BMLC2GUIConfig.xsd?>
<SBMLServer xmlns:xsi="http://www.w3.org/2001/XMLSchema-instance"
xsi:noNamespaceSchemaLocation="BMLC2GUIConfig.xsd">
  <SBMLServer>armstrong.netlab.gmu.edu</SBMLServer>
  <ReportBMLType>C_BML</ReportBMLType>
  <ReportInfoDomain>db</ReportInfoDomain>
  <ReportPullDomain>dB</ReportPullDomain>
  <UnitInfoDomain>RI</UnitInfoDomain>
  <OrderServer>armstrong.netlab.gmu.edu</OrderServer>
  <OrderBMLType>OPORD_DEMO</OrderBMLType>
  <OrderDomain>RI</OrderDomain>
  <WhereXPath/>
  <InitMapLat>0</InitMapLat>
  <InitMapLon>0</InitMapLon>
  <ReportOrderScale>0</ReportOrderScale>
  <BMLC2GuiUrl/>
</SBMLServer>
```

An Open Source Graphical User Interface Surrogate C2 System for Battle Management Language Experimentation

Lt. Col. Mohammad Ababneh, Jordan AF (Student)

Dr. Mark Pullen

George Mason University C⁴I Center

{mababneh, mpullen} @ c4i.gmu.edu

Presentation Overview

- BML and BML experiments
- GMU open-source BML software
- BML C2 GUI requirements
- Open-source development
- Functionality
- Use as surrogate C2 system
- Conclusions

BML Overview

Background - BML

- Facilitates C2-Simulation interoperation
 - Exchange of Orders and reports in standard format
- Current architecture uses a repository service to hold state submitted by client C2 and Simulation systems
 - Web service with XML input – Network Centric
 - Data stored in JC3IEDM and can be replicated

BML Architecture

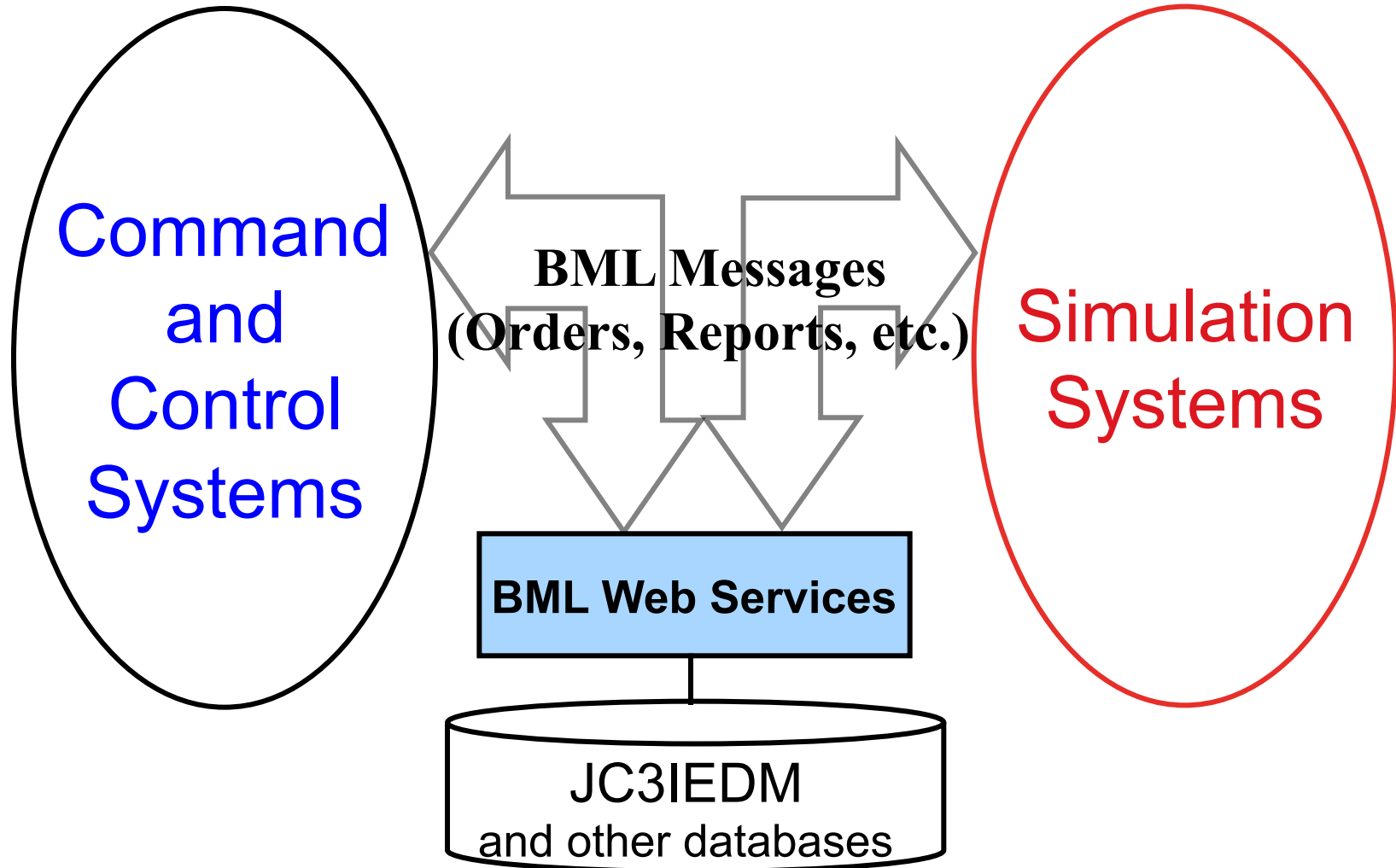

MSG-048 2009 Architecture

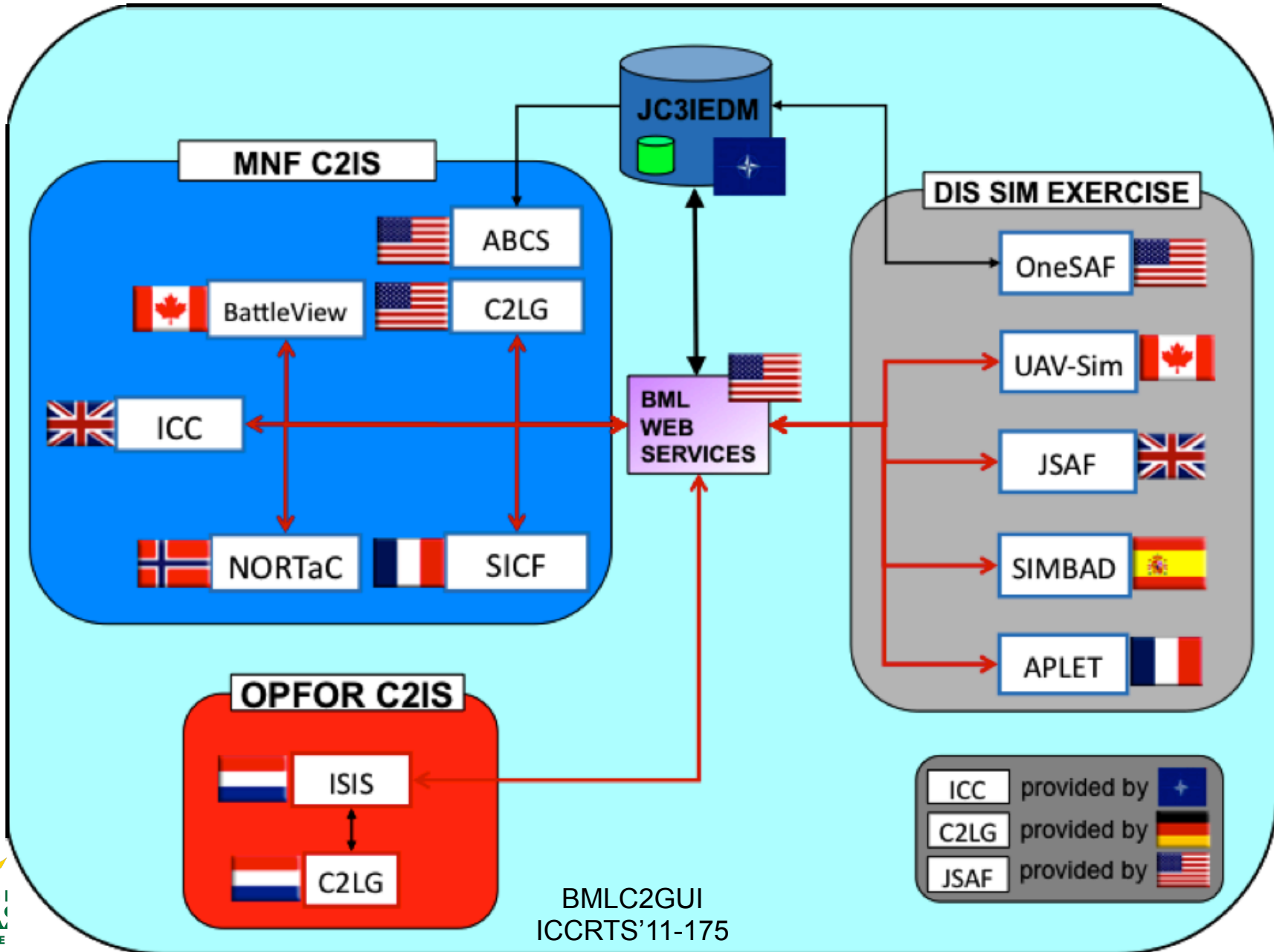

C2LG GUI

- Command & Control Lexical Grammer (C2LG) Graphical User Interface (GUI) was constructed by the German research center FGAN.
- The C2LG GUI was created to generate “pure” BML statements that were valid grammar statements.
- In many BML activities, the C2LG GUI was used as an “integration hub” to take the input from C2 systems and construct a “valid” JBML Order that could be sent and ingested by different nation’ s simulations.
- FGAN operates under rules that would not allow them to release the C2LG GUI to the whole BML community.

C2LG GUI

- Screen Shot

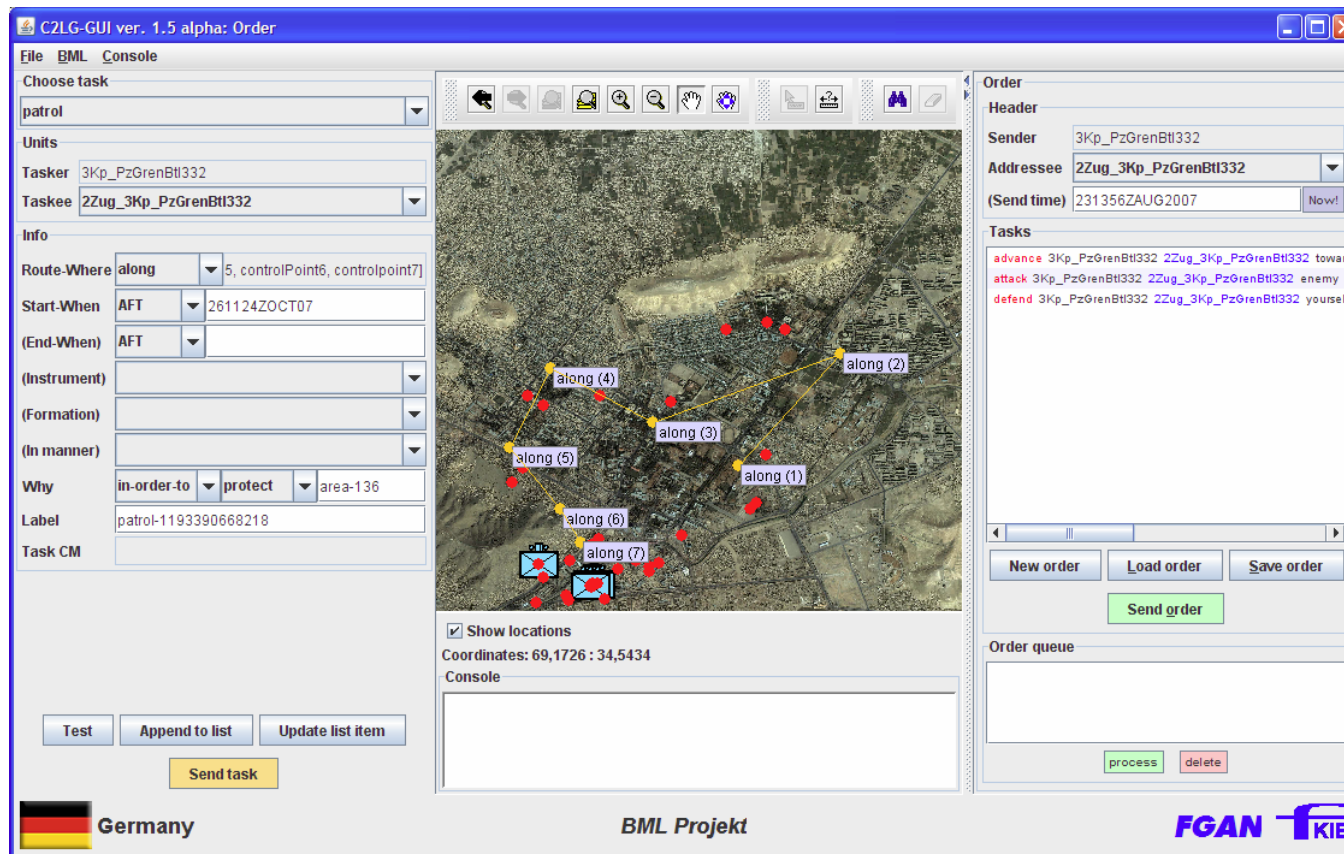

BML C2 GUI

BML C2 GUI

- Patterned after Fraunhofer-FKIE C2LG GUI
 - Usable as editor or monitor
 - Reads/writes Orders and Reports
 - Auto-configures to any BML schema
 - View and modify a BML-XML file
 - Map/image display shows 2525B icons from XML
 - Future version will enter geolocation data in BML-XML file
 - Open source at <http://c4i.gmu.edu/BML>

BML C2 GUI

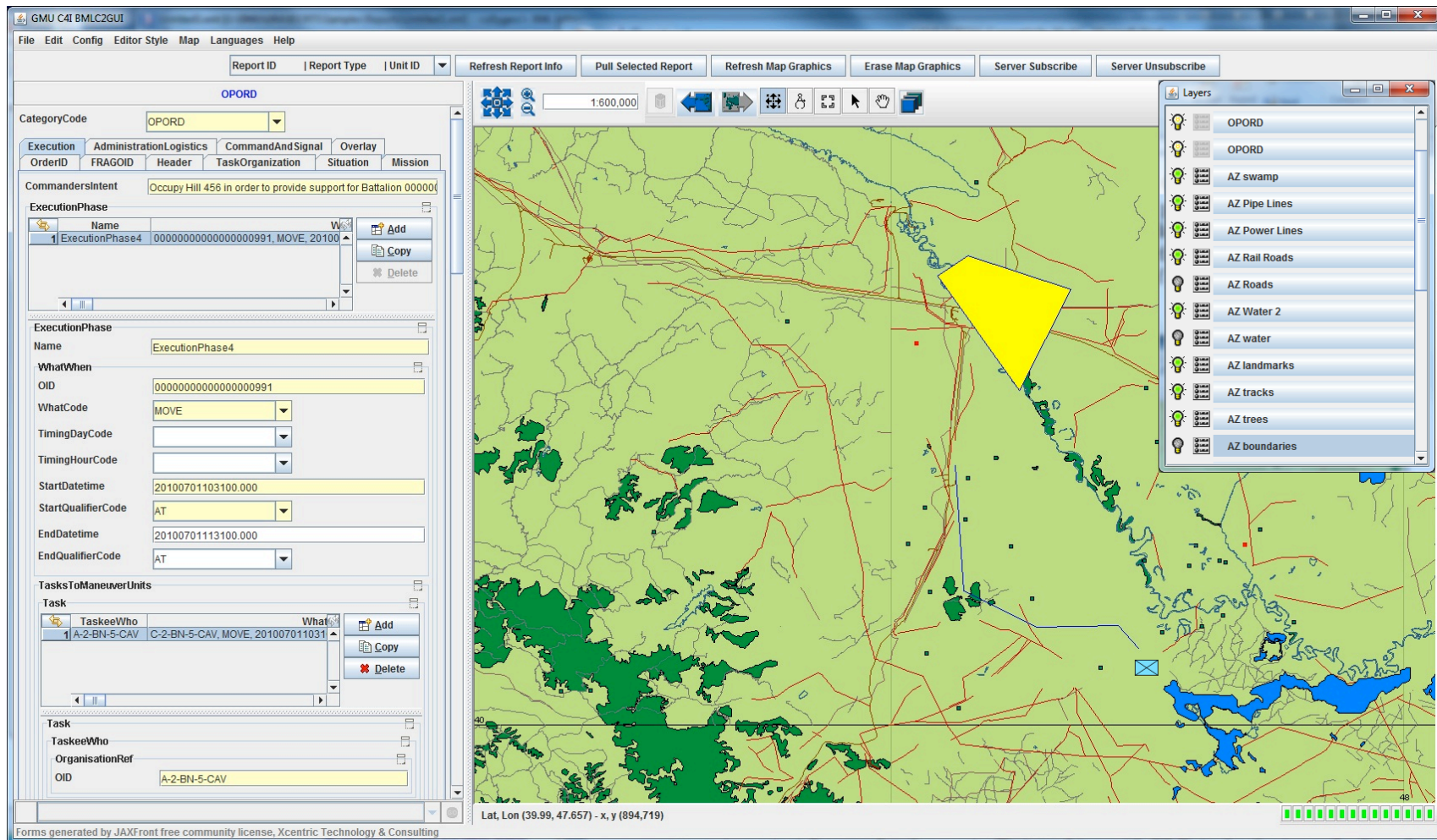

BML C2 GUI : ORDER

Task TaskerWho TaskOrganization ControlMeasures

Task	
1	GroundTask, UnitID, 2TF A TEAM, SEIZE, HADES 3, AtWhere, JBMLAtWhere, HADES 3, AREAOFINTEREST, AREA, WhereLocat...
2	GroundTask, UnitID, 2TF B TEAM, SEIZE, HADES 3, AtWhere, JBMLAtWhere, HADES 3, AREAOFINTEREST, AREA, WhereLocat...

Task

TaskerWho	What	Where
UnitID, 2TF A TEAM	SEIZE	HADES 3, AtWhere, JBMLAtWhere, HADES 3, AREAOFINTEREST, AREA, WhereLocation, GDC, 4

GroundTask

TaskerWho

UnitID

What

Where

WhereID

UNNAMED1

AtWhere

WhereLabel

WhereCategory

WhereClass

WhereValue

WhereLocation

1 GDC, 40.0646754, 48.8700762, 0.0

BML C2 GUI : CONTROL FEATURES

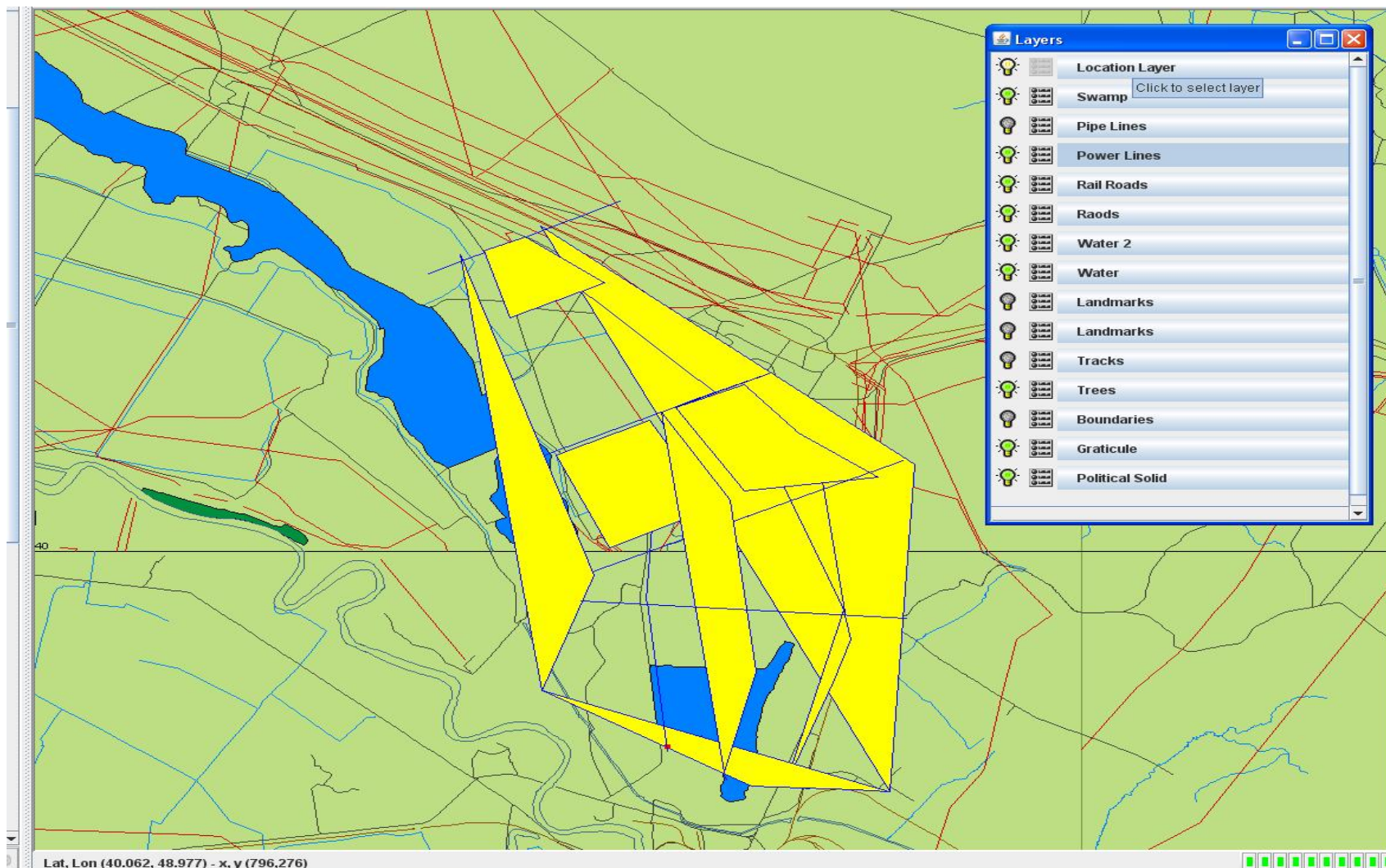

Scripted BML Server

- Middleware functions don't change
 - Mapping BML to JC3IEDM and push/pull to database
 - Program these once and get them right
- Interpreted WS offers flexibility
 - Rapid implementation of new BML constructs
 - Easy to modify underlying data model
 - JC3IEDM also continues to change
 - Reduces time and cost for prototyping
 - Scripting language provides a concise definition of BML-to-data model mappings
 - Although bugs still happen, the number of possible mistakes is far smaller
- Scripted operation may, however, be slower
 - We've multithreaded the server
 - 8 processors achieved over 10 Reports/sec
 - Believe it will scale at least to 16 processors (20 Reports/sec)

Scripted BML WS Configuration

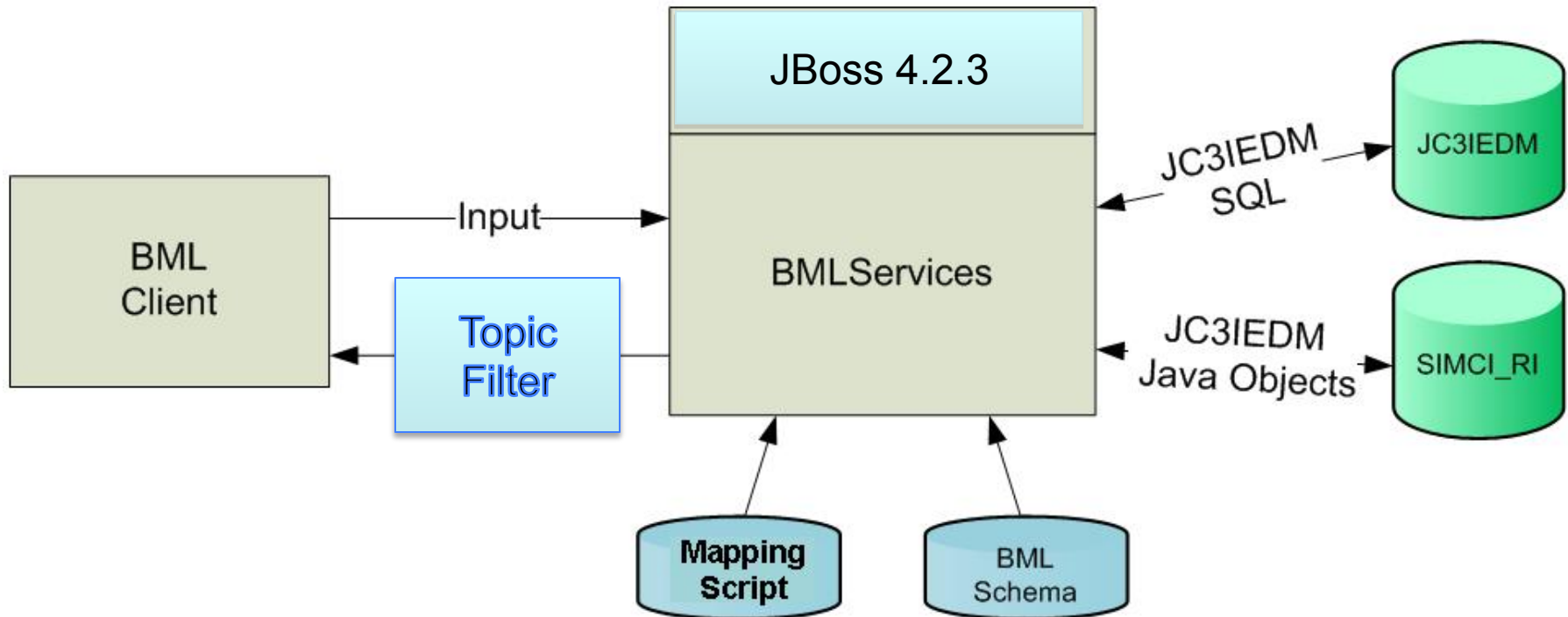

Two implementations: MySQL and SIMCI RI

Polling vs Publish/Subscribe

- “Pure” Web Service is always accessed by *push* or *pull* transaction from client
 - No provision for server to initiate action
- For clients to stay up to date they must pull latest status from server at rate determined by their need for up-to-date information (called *polling*)
 - Result: MSG-048 server in 2008 spent most of its time responding to status pulls
- Publish/subscribe gets around this by letting clients identify the categories of information they need – they *subscribe* to *Topics*
 - Server sends them a copy of every update associated with each subscribe Topic
 - More timely updates and a dramatic reduction in overhead

Publish/Subscribe Architecture

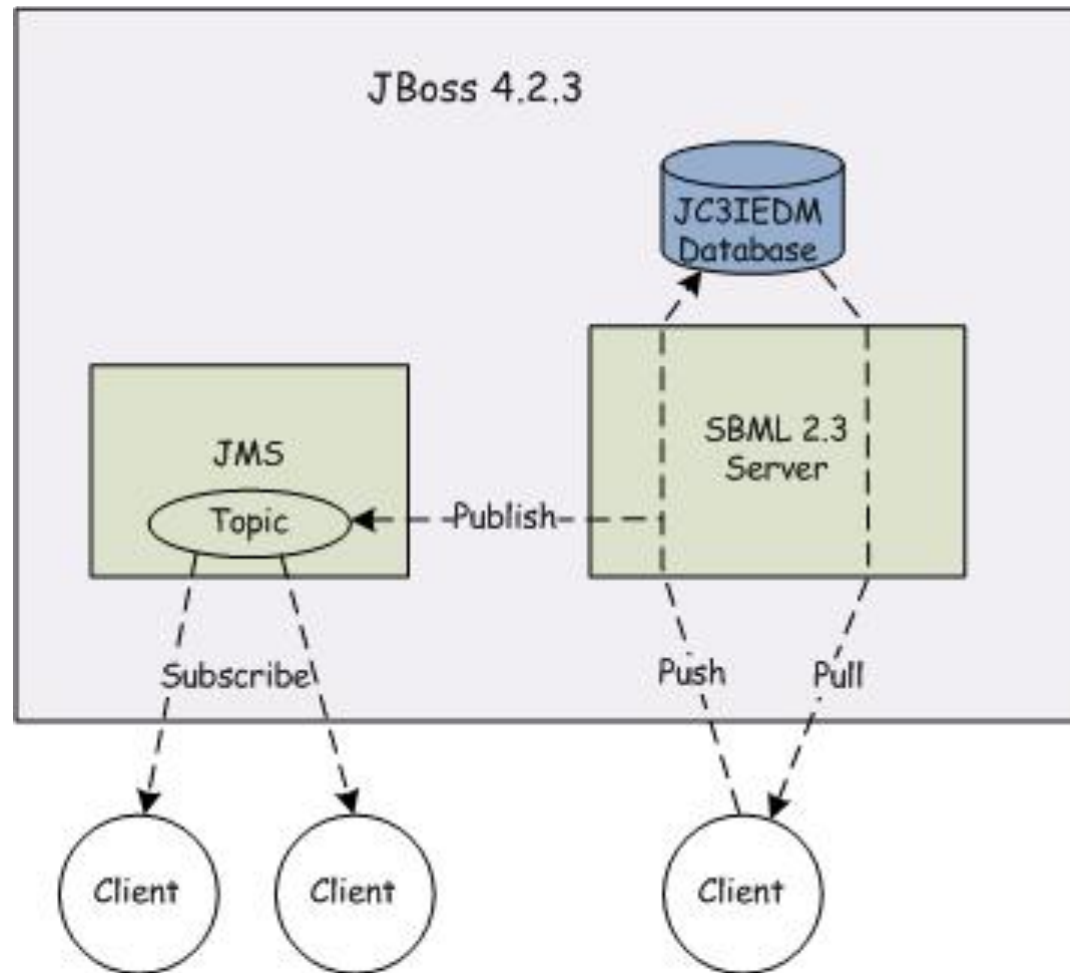

SBML in NATO MSG-048

- Paper 10S-SIW-049 describes a significant NATO Technical Activity that used SBML
- Six national C2 systems and five national simulations interoperating
- Six months of preparation culminated in a week of experimentation at Manassas, VA
- Publish/subscribe essential to meet performance needs
- See companion paper for more information

SBML Services in the BML C2 GUI

- The BMLC2GUI uses the Web Services maintained by SBMLServer through the SBMLClient application.
 - CallListWho: is used by the GUI to bring up all the necessary information about a unit given its UnitID in order to compose the MILSTD2525b key (String characters) that enables the tool to draw the correct unit symbol in its desired position.

```
<callListWho>  
<UnitID>3</UnitID>  
</callListWho>
```

- The BMLC2GUI is open source - could be modified to use other source of Unit information

SBML Services in the BML C2 GUI

- The BMLC2GUI uses the following Web Services maintained by SBMLServer through the SBMLClient application.
 - GetLatestReportIDs: is used by the GUI to build a list of report information:

```
<GetLatestReportIDs>  
</GetLatestReportIDs>
```

- ReportPull: is used by the GUI to pull a report from the SBML Web Service so that it can be viewed or edited and its geospatial information be extracted and illustrated on the map.

```
<ReportPull>  
<ReportID>410</ReportID>  
</ReportPull>
```

BML C2 GUI Requirements

JaxFront – Open Source XML Java Editing

- JaxFront is a technology developed by Switzerland's Xcentric Technology & Consulting GmbH.
- It is “a technology to generate graphical user interfaces on multiple channels (Java Swing, HTML, PDF) on the basis of an XML schema”.
- Web site <http://www.jaxfront.org>
- The BML C2 GUI uses the Free Community version (Open-Source) of JaxFront as a major component for editing BML documents.
- The user can dynamically generate GUIs that allow the user to edit XML data without being exposed to the underlying XML technology.

JaxFront – Open Source XML Java Editing

- JAXFront architecture

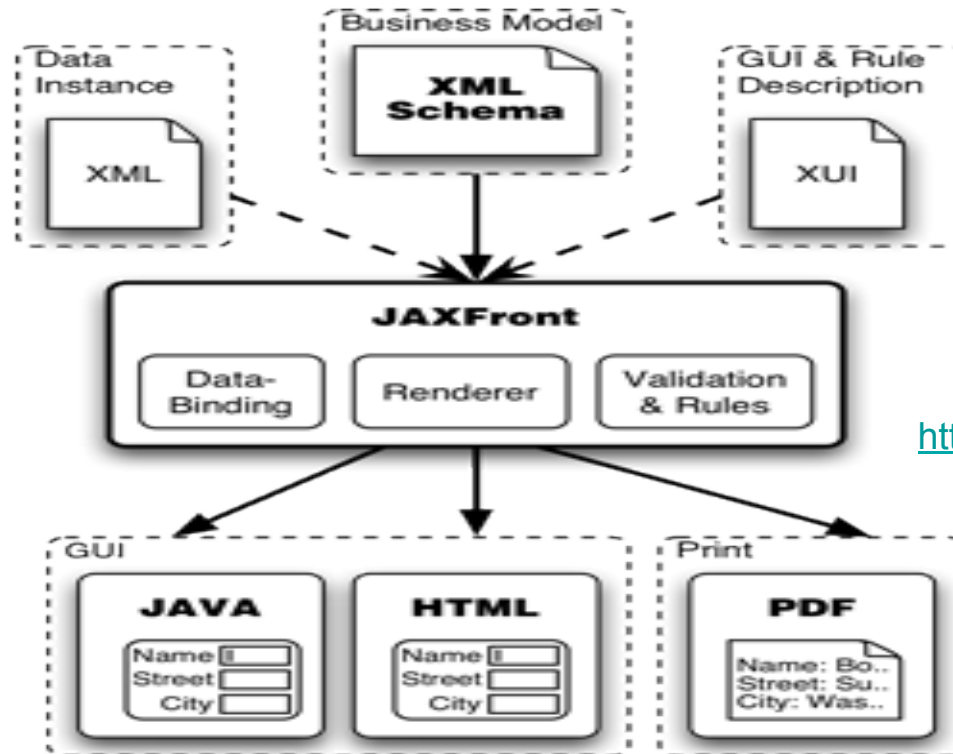

Source:
<http://www.jaxfront.org>.

- JAXFront also provides XML User Interface (XUI) Editor to customize its forms

BML C2 GUI Development Goals

- Core functions like C2LG GUI
- Differences from C2LG GUI:
 - Open resource
 - Quick response to changes
 - Ease of use
 - Low development cost

Open-Source Development

BML C2 GUI Development

- The core of the BMLC2GUI is the use of JAXFront's libraries to build a new and a customized type of XML Document Object Module (DOM) that can be rendered as Java Swing objects.
- The JaxFront's DOM Builder takes the following parameters to generate a JAXFront document:
 - The XML document.
 - The Schema.
 - The XUI (optional): XML User Interface file used to customized the view of the XML document. The default is a tree view.
 - The XML root node

BML C2 GUI Development

- JaxFront's EditorPanel renders the generated DOM using Java Swing components with the help of the XUI file.

```
currentDom = DOMBuilder.getInstance().build  
("default-context", xsdUrl, xmlUrl, xuiUrl, root);
```

BML C2 GUI Development

- After the successful rendering of the XML document, we start extracting the geospatial information (Latitude, Longitude coordinates representing positions or dimensions of objects) on the map.
- We parse the document and pass the elements and values to OpenMap's MapHandler
- The MapHandler draws and controls the following types of layers:
 - Country or area of interest geospatial data layers. In our case (ESRI shape files).
 - BML objects and geospatial information: unit, minefield, bridge, spot, track.
 - MIL-STD-2525b symbols

Open Map

- Open Source JavaBeans based Geospatial development tool.
- From BBN Technologies, now part of Raytheon.
<http://openmap.bbn.com>
- BMLC2GUI is using the latest version of OpenMap 4.6.5, released March 5, 2009.
- It provides various capabilities to allow users to see and manipulate geospatial information.
- OpenMap supports various map data file formats.

Open Map

- This release of the BMLC2GUI is using ESRI shape files.
- The BMLC2GUI uses OpenMap to display the different data layers on the map in addition to drawing BML objects, units and control measures at their corresponding locations.

Open Map - MIL-STD-2525B

- The BMLC2GUI makes use of the OpenMap's implementation of MIL-STD-2525B symbols
- The unit/object symbol is constructed from the UnitID / objectType during the geospatial information extraction.
- The corresponding unit/object symbol is drawn at the Lat-Lon coordinates
- Objects can be minefield, bridge, spot,...

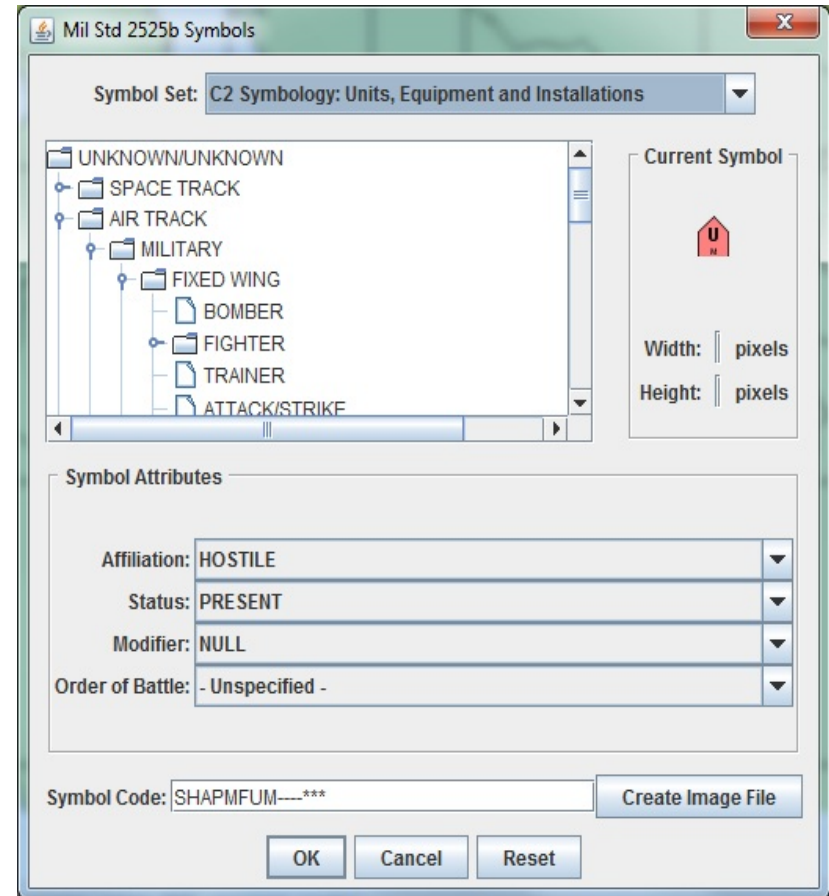

BML C2 GUI

Capabilities & Functionality

BML C2 GUI - Functions

- Editing a BML Document
- Serialization of a BML Document
- Validation of a BML Document
- Pulling a BML Document
- Pushing a BML Document
- Retrieving Latest Reports
- C2 Capability

BML C2 GUI - Functionality

- Editing a BML Document
 - The BML C2 GUI can edit any type of BML documents.
 - The user has the capability to create a new order or a report in the GUI or open an existing document from the file system.
 - The user has the flexibility of modifying, validating, serializing the document

The screenshot displays the BML C2 GUI interface. At the top, the window title is "GMU C4I BMLC2GUI". The menu bar includes "File", "Edit", "Config", "Editor Style", "Map", "Languages", and "Help". The main content area is titled "Order" and contains an "OrderPush" form with the following fields:

- OrderPush: [Icon]
- OrderPush: [Icon]
- TaskersIntent: Secure Area 12098
- OrderIssuedWhen: 20080808080808.000
- OrderID: 225
- ReferenceOrderID: [Empty]
- Context: [Empty]

Below the form are three tabs: "Task", "TaskerWho", "TaskOrganization", and "ControlMeasures". The "Task" tab is active, showing a table with one row:

Task
1 GroundTask, UnitID, 110BCT, MOVE, 8SQ10CAV-AXIS_OF_ADVANCE, RouteW...

Buttons for "Add", "Copy", and "Delete" are visible to the right of the table. Below this is another "Task" table with columns "TaskerWho", "What", and "Where":

Task
1 UnitID, 110BCT, MOVE, 8SQ10CAV-AXIS_OF_ADVANCE, RouteWhere, Along

Buttons for "Add", "Copy", and "Delete" are also present. Below this is a "GroundTask" form with the following fields:

- TaskerWho: [Empty]
- UnitID: 110BCT
- What: [Empty]
- WhatCode: MOVE
- Where: [Empty]
- WhereID: 8SQ10CAV-AXIS_OF_ADVANCE
- UNNAMED1: RouteWhere
- RouteWhere: Along
- Along: Coords

At the bottom, there is a "Coords" table with four rows:

Coords
1 GDC, 40.388, 47.1251, 0
2 GDC, 40.2007, 47.1415, 0
3 GDC, 40.1472, 47.2843, 0
4 GDC, 40.1486, 47.4435, 0

Buttons for "Add", "Copy", and "Delete" are visible to the right. The footer of the window reads "Forms generated by JAXFront free community license, Xcentric Technology & Consulting".

BML C2 GUI - Functionality

- Serialization of a BML Document
 - The BML C2 GUI provides the user with the capability to see the XML source of any document he is editing.
 - This feature is very useful, especially to the experienced and advanced users.

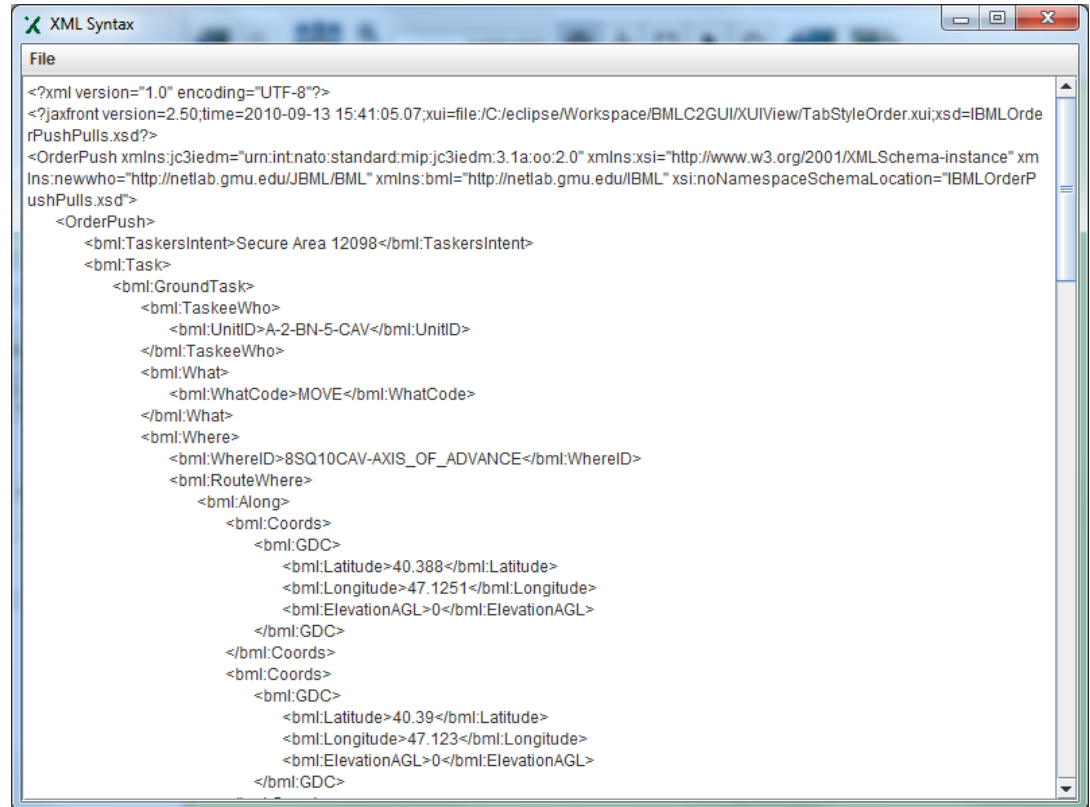

```
<?xml version="1.0" encoding="UTF-8"?>
<?jxfront version=2.50,time=2010-09-13 15:41:05.07;xui=file:/C:/eclipse/Workspace/BMLC2GUI/XUIView/TabStyleOrder.xui;xsd=IBMLOrderPushPulls.xsd?>
<OrderPush xmlns:jc3iedm="urn:int.nato.standard:mip:jc3iedm:3.1a:oo:2.0" xmlns:xsi="http://www.w3.org/2001/XMLSchema-instance" xmlns:newwho="http://netlab.gmu.edu/IBML/BML" xmlns:bml="http://netlab.gmu.edu/IBML" xsi:noNamespaceSchemaLocation="IBMLOrderPushPulls.xsd">
  <OrderPush>
    <bml:TaskersIntent>Secure Area 12098</bml:TaskersIntent>
    <bml:Task>
      <bml:GroundTask>
        <bml:TaskeeWho>
          <bml:UnitID>A-2-BN-5-CAV</bml:UnitID>
        </bml:TaskeeWho>
        <bml:What>
          <bml:WhatCode>MOVE</bml:WhatCode>
        </bml:What>
        <bml:Where>
          <bml:WhereID>8SQ10CAV-AXIS_OF_ADVANCE</bml:WhereID>
          <bml:RouteWhere>
            <bml:Along>
              <bml:Coords>
                <bml:GDC>
                  <bml:Latitude>40.388</bml:Latitude>
                  <bml:Longitude>47.1251</bml:Longitude>
                  <bml:ElevationAGL>0</bml:ElevationAGL>
                </bml:GDC>
              </bml:Coords>
            </bml:Along>
          </bml:RouteWhere>
        </bml:Where>
      </bml:GroundTask>
    </bml:Task>
  </OrderPush>
</OrderPush>
```

BML C2 GUI - Functionality

- Validation of a BML Document
 - The BML C2 GUI provides the user with the capability to validate the BML document against its schema.
 - This serves as a validation option **before** sending the document to any web service in order to guarantee well conformance with the schema.
 - When the validation option is selected, all the possible validation problems can be displayed in the GUI's status bar and also a red box can be drawn around the text area having the problem.

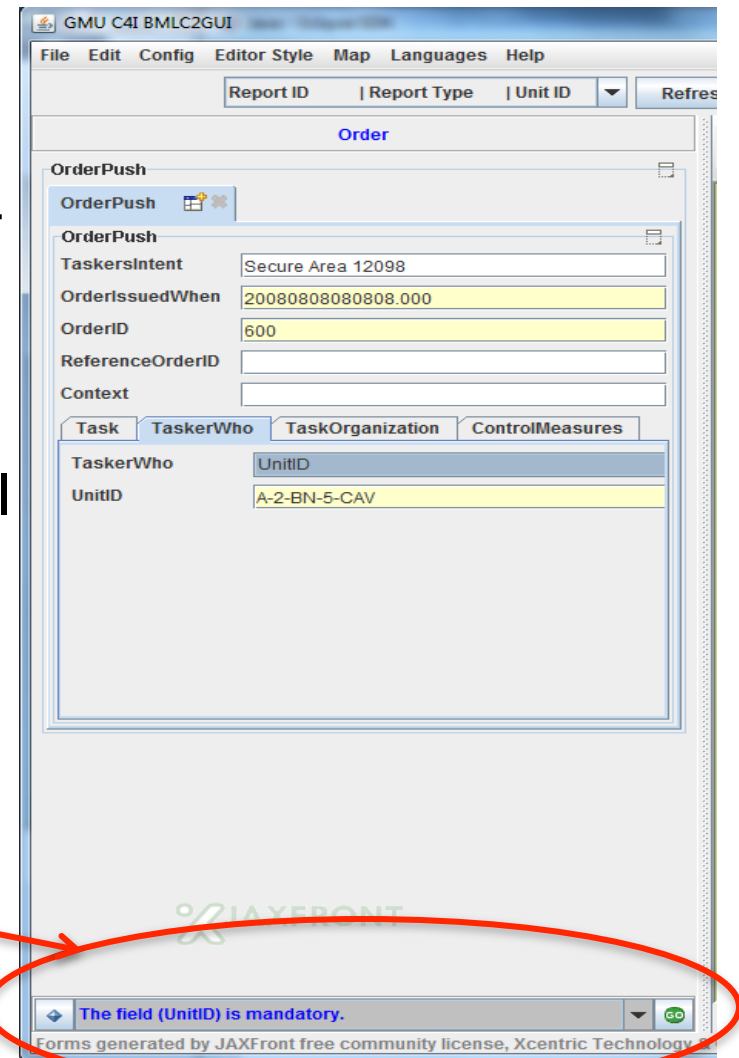

The screenshot shows the BML C2 GUI interface. The main window is titled "GMU C4I BMLC2GUI" and has a menu bar with "File", "Edit", "Config", "Editor Style", "Map", "Languages", and "Help". Below the menu bar, there are input fields for "Report ID", "Report Type", and "Unit ID", along with a "Refresh" button. The main content area is titled "Order" and contains a form for "OrderPush". The form has several fields: "TaskersIntent" (Secure Area 12098), "OrderIssuedWhen" (20080808080808.000), "OrderID" (600), and "ReferenceOrderID". Below these fields are tabs for "Task", "TaskerWho", "TaskOrganization", and "ControlMeasures". The "TaskerWho" tab is selected, showing a table with columns "UnitID" and "UnitID", and a row with the value "A-2-BN-5-CAV". At the bottom of the window, a status bar displays a validation error: "The field (UnitID) is mandatory." A red oval is drawn around this status bar, and a red arrow points from the text in the list above to the status bar.

BML C2 GUI - Functionality

- Pulling a BML Document
 - The BML C2 GUI provides the user with the capability to pull reports from the SBMLServer through two paths:
 - Subscriber: By activating the “SBMLSubscriber” listener application, which listens to any coming new report and automatically detects its type and displays it in the editor area. It will also extract any geospatial data from the report and display it on the map.
 - Manually: By selecting the desired report from a Report Information list of the latest reports added from the web service.

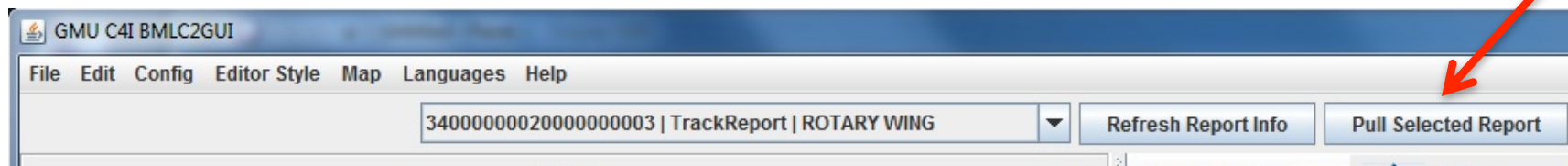

BML C2 GUI - Functionality

- Pushing a BML Document
 - The BMLC2GUI provides the capability to create, edit, validate (optional) and push any type of BML document
 - When a user decides that the order or report is ready to be pushed, the GUI provides him with a simple user interface to do so with a click of a button.
 - Off-course this interface is a shell to the call of the SBMLClient.

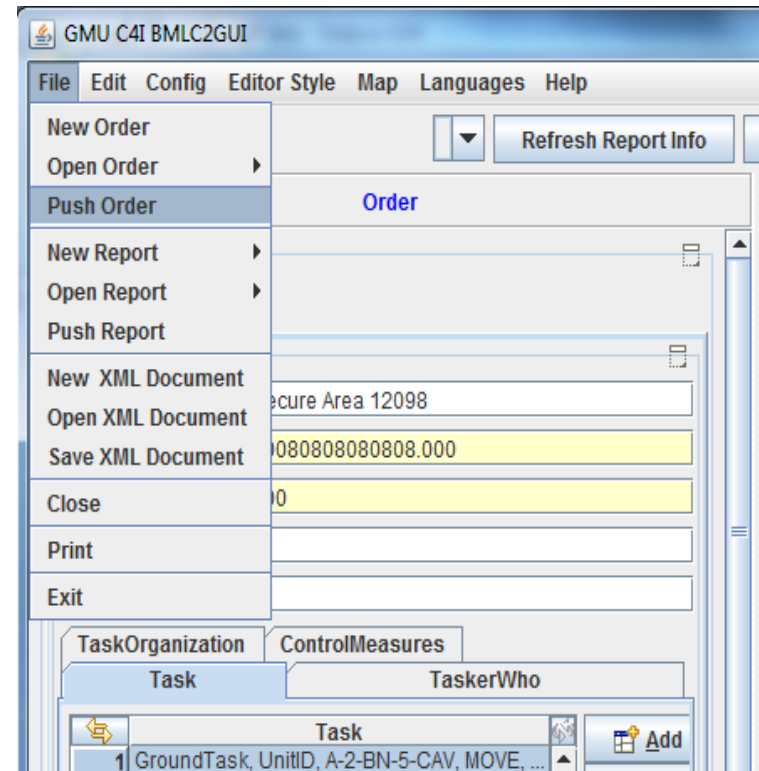

BML C2 GUI - Functionality

- Retrieving Latest Reports
 - The BMLC2GUI provides the user with the capability to see a list of reports consisting of the Report ID, Type and Object/Unit ID.
 - The user has the capability to refresh this list manually in addition to the automatic update while the subscriber is running.
 - The user can select any report from the list and get a view of that report: document view and geospatial information representation.

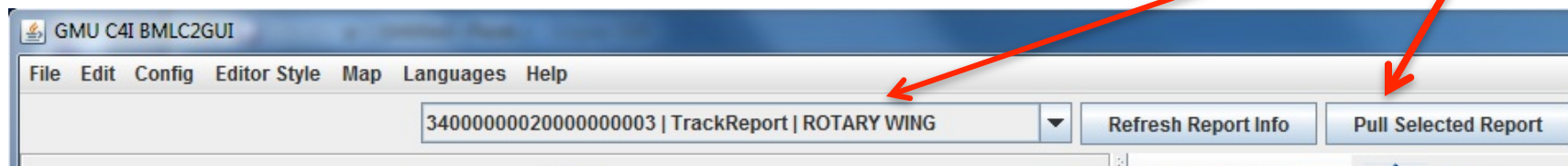

BML C2 GUI - Configuration

- The BMLC2GUI makes use of the same JAXFront editing capabilities to configure its environment variables

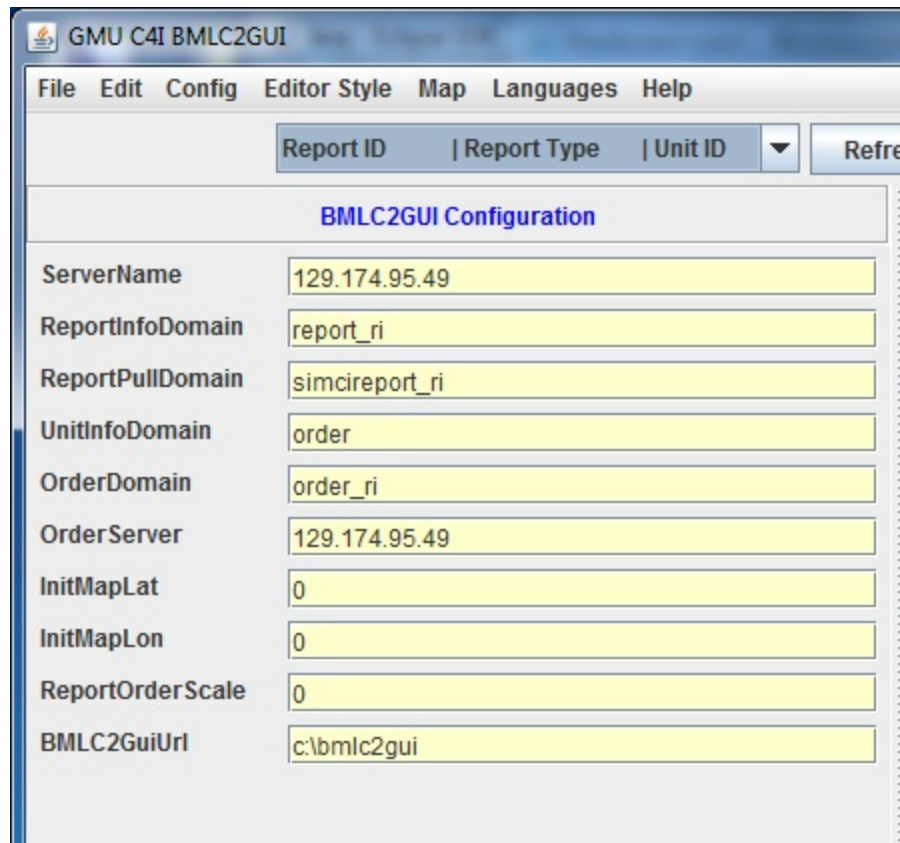

The screenshot shows a web-based configuration interface for the BMLC2GUI. The window title is "GMU C4I BMLC2GUI". The menu bar includes "File", "Edit", "Config", "Editor Style", "Map", "Languages", and "Help". Below the menu bar, there are three tabs: "Report ID", "Report Type", and "Unit ID", with a "Refre" button to the right. The main content area is titled "BMLC2GUI Configuration" and contains a list of configuration variables, each with a corresponding text input field:

Variable Name	Value
ServerName	129.174.95.49
ReportInfoDomain	report_ri
ReportPullDomain	simcireport_ri
UnitInfoDomain	order
OrderDomain	order_ri
OrderServer	129.174.95.49
InitMapLat	0
InitMapLon	0
ReportOrderScale	0
BMLC2GuiUrl	c:\bmlc2gui

BML C2 GUI - Functionality

- C2 Capability
 - The BMLC2GUI implements the SBMLSubscriber Client application to connect to the subscription service of the SBMLServer.
 - This client connectivity enables the GUI to listen to any BML activity such as reports being generated.
 - The main usage of the Subscriber in the GUI is to pull new BML reports of any type and display them immediately on the screen in the editing/viewing panel in addition to extracting the geospatial information and display it in the map panel.
 - Some modifications to the code can make it a more advanced C2 system.
 - Examples to be shown in the coming integration demo slides

BML C2 GUI in the Integration Process

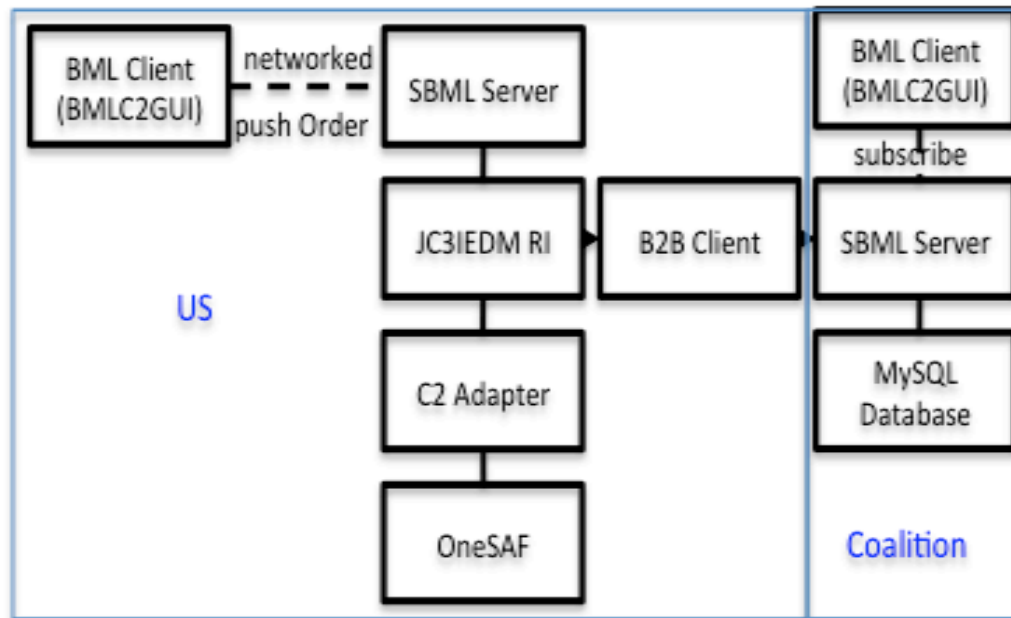

a. Orders

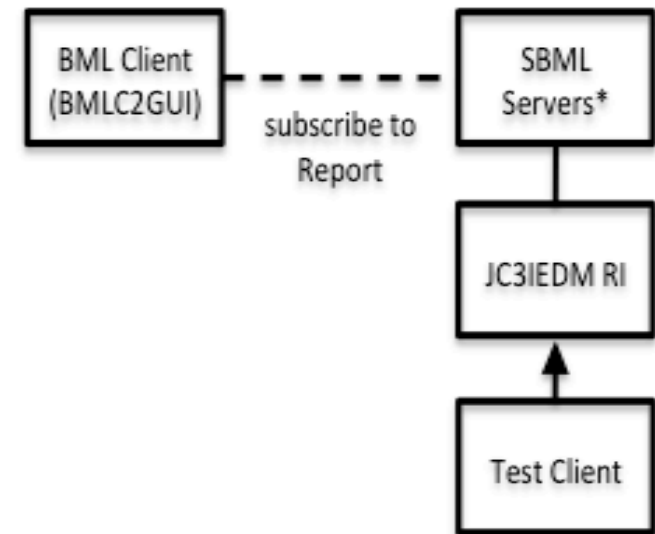

b. Reports

Use as Surrogate C2 System

Reports in BML C2 GUI

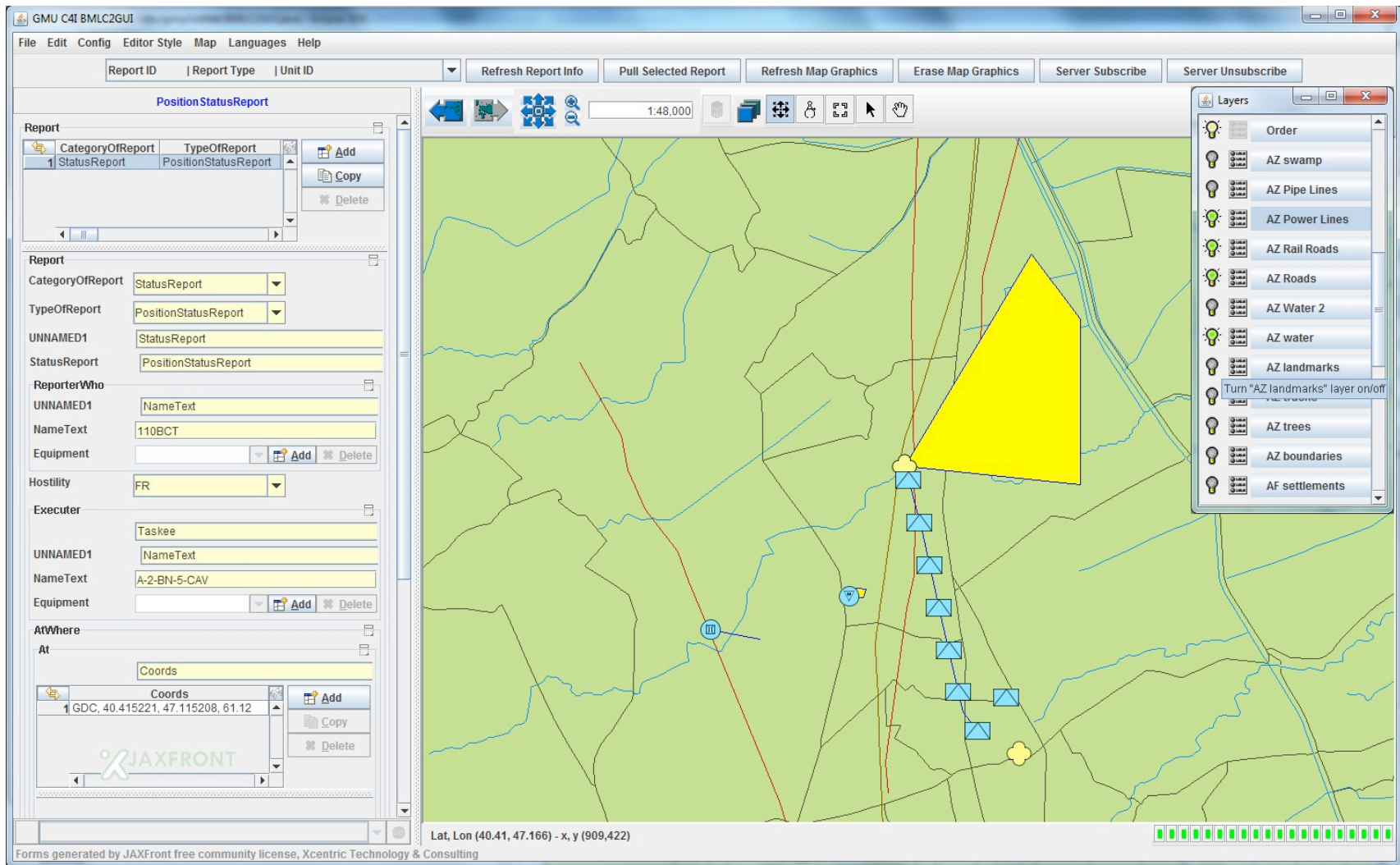

OPORD using SISO C-BML

The screenshot displays the GMU C4I BMLC2GUI application window. The title bar reads "GMU C4I BMLC2GUI". The menu bar includes "File", "Edit", "Config", "Editor Style", "Map", "Languages", and "Help". Below the menu bar, there are input fields for "Report ID", "Report Type", and "Unit ID", along with buttons for "Refresh Report Info", "Pull Selected Report", and "Refresh Map G".

The main content area is titled "OPORD" and features a "CategoryCode" dropdown menu set to "OPORD". Below this, there are tabs for "Mission", "Execution", "AdministrationLogistics", "CommandAndSignal", and "Overlay". Under the "Execution" tab, there are sub-sections for "OrderID", "FRAGOID", "Header", "TaskOrganization", and "Situation".

The "CommandersIntent" field contains the text "Occupy Hill 456 in order to provide support for". Below this is the "ExecutionPhase" section, which includes a table with the following data:

Name	WhatWhen
1 ExecutionPhase4	00000000000000000991, MOVE, 20100701103100.000, AT, 20100701113100.000, AT

Buttons for "Add", "Copy", and "Delete" are visible to the right of the table. Below the table, the "ExecutionPhase" details are shown in a form with the following fields:

- Name: ExecutionPhase4
- WhatWhen: 00000000000000000991
- WhatCode: MOVE
- TimingDayCode: [Empty]
- TimingHourCode: [Empty]
- StartDatetime: 20100701103100.000
- StartQualifierCode: AT
- EndDatetime: 20100701113100.000
- EndQualifierCode: AT

Below the "ExecutionPhase" details is the "TasksToManeuverUnits" section, which includes a table with the following data:

Task	TaskeeWho	WhatWhen
1 A-2-BN-5-CAV	C-2-BN-5-CAV	MOVE, 20100701103100.000, AT, 20100701113100.000, AT

Buttons for "Add", "Copy", and "Delete" are visible to the right of the table. Below the table, the "Task" details are shown in a form with the following fields:

- Task: A-2-BN-5-CAV
- TaskeeWho: C-2-BN-5-CAV

The bottom of the window shows a footer with the text "Forms generated by JAXFront free community license, Xcentric Technology & Consulting".

OPORD Mapping Capabilities

The screenshot displays the GMU C4I BMLC2GUI application. The interface is divided into several sections:

- Top Menu:** File, Edit, Config, Editor Style, Map, Languages, Help.
- Toolbar:** Report ID, Report Type, Unit ID, Refresh Report Info, Pull Selected Report, Refresh Map Graphics, Erase Map Graphics, Server Subscribe, Server Unsubscribe.
- Left Panel (Data Entry):**
 - CategoryCode: OPORD
 - CommandAndSignal: Overlay
 - Situation: Mission, Execution, AdministrationLogistics
 - OrderID: FRAGOID, Header, TaskOrganization
 - OrderID: 00000000000000000604
 - TaskerWho: OrganisationRef, OID: A-2-BN-5-CAV
 - UNNAMED1: OrderIssuedWhen
 - OrderIssuedWhen: 20101010080808.000
- Map Area:** A satellite-style map with a yellow polygon overlaid on a road. The scale is 1:1,200,000.
- Right Panel (Layers):** A list of map layers including OPORD, AZ swamp, AZ Pipe Lines, AZ Power Lines, AZ Rail Roads, AZ Roads, AZ Water 2, AZ water, AZ landmarks, AZ tracks, AZ trees, AZ boundaries, and AF settlements.
- Bottom:** A status bar with a message: "The field (Location[4] > OID) is mandatory." and a footer: "Forms generated by JAXFront free community license, Xcentric Technology & Consulting".

Conclusions

- The BMLC2GUI provides an easy-to-use, comprehensive tool for the BML developer and end user
- Platform-independent and command-line free BML editing and viewing
- Geospatial capabilities
- Validation and Serialization
- Being open-source makes it less expensive to own and operate
- Customization and enhancements possible by the BML community
- Open source at <http://c4i.gmu.edu/BML>