

The logo for ATEC (Advanced Test and Evaluation Center) features the letters 'ATEC' in a bold, blue, sans-serif font. To the left of the letters is a stylized graphic of a yellow and orange flame or explosion.

White Sands Missile Range Overview & Introduction

Test Capabilities Briefing

K.G. Nebhan

WSMR Business Development Office

7 November 2011

Army Proven
Battle Ready

*Approved for public release. Distribution is unlimited.
OPSEC review conducted on 7 Nov 2011.*

Report Documentation Page

*Form Approved
OMB No. 0704-0188*

Public reporting burden for the collection of information is estimated to average 1 hour per response, including the time for reviewing instructions, searching existing data sources, gathering and maintaining the data needed, and completing and reviewing the collection of information. Send comments regarding this burden estimate or any other aspect of this collection of information, including suggestions for reducing this burden, to Washington Headquarters Services, Directorate for Information Operations and Reports, 1215 Jefferson Davis Highway, Suite 1204, Arlington VA 22202-4302. Respondents should be aware that notwithstanding any other provision of law, no person shall be subject to a penalty for failing to comply with a collection of information if it does not display a currently valid OMB control number.

1. REPORT DATE 07 NOV 2011	2. REPORT TYPE	3. DATES COVERED 00-00-2011 to 00-00-2011			
4. TITLE AND SUBTITLE White Sands Missile Range Overview & Introduction: Test Capabilities Briefing		5a. CONTRACT NUMBER			
		5b. GRANT NUMBER			
		5c. PROGRAM ELEMENT NUMBER			
6. AUTHOR(S)		5d. PROJECT NUMBER			
		5e. TASK NUMBER			
		5f. WORK UNIT NUMBER			
7. PERFORMING ORGANIZATION NAME(S) AND ADDRESS(ES) Army Test and Evaluation Command (ATEC), White Sands Missile Range, White Sands Missile Range, NM, 88002-5000		8. PERFORMING ORGANIZATION REPORT NUMBER			
9. SPONSORING/MONITORING AGENCY NAME(S) AND ADDRESS(ES)		10. SPONSOR/MONITOR'S ACRONYM(S)			
		11. SPONSOR/MONITOR'S REPORT NUMBER(S)			
12. DISTRIBUTION/AVAILABILITY STATEMENT Approved for public release; distribution unlimited					
13. SUPPLEMENTARY NOTES					
14. ABSTRACT					
15. SUBJECT TERMS					
16. SECURITY CLASSIFICATION OF:			17. LIMITATION OF ABSTRACT Same as Report (SAR)	18. NUMBER OF PAGES 180	19a. NAME OF RESPONSIBLE PERSON
a. REPORT unclassified	b. ABSTRACT unclassified	c. THIS PAGE unclassified			



Presentation Outline



- **WSMR Mission**
- **WSMR Location & Airspace**
- **WSMR Organization**
- **WSMR Organizations & Capabilities**
 - **White Sands Test Center (WSTC)**
 - **US Air Force at WSMR**
 - **US Navy at WSMR**
 - **Other Team White Sands Organizations**
- **Future Projected Major RDT&E Capabilities and Facilities**
- **Other Unique WSMR Facilities and Sites**
- **Q & A**

WSMR Mission



WSMR Mission Statement



Provide Army, Navy, Air Force, DoD and other customers with high quality services for experimentation, test, research, assessment, development, and training in support of the Nation at war.

--

WSMR capabilities and resources are also available to Foreign Allies and Private Industry

WSMR Location

WSMR Location



- ✓ Beautiful New Mexico desert weather
- ✓ Low population density, great community support
- ✓ Wealth of expertise, and technical organizations

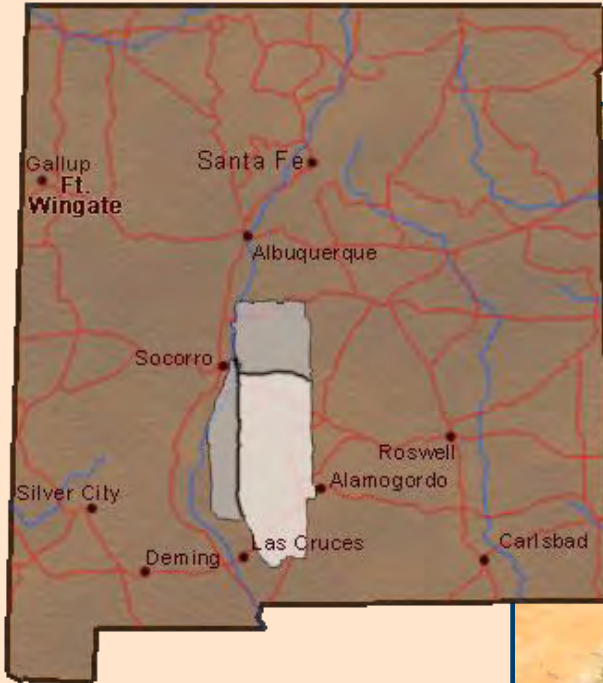

White Sands Missile Range is located in south central New Mexico



*Army Proven
Battle Ready*

Land space and Climate



**Reliable
Year-round
Test & Training**

➤ **Stable / Mild Climate**

20yr Avg. Temperature.

	Winter	Summer
High	61°F	92°F
Low	36°F	69°F

➤ **Dry / Clear Atmosphere**

Avg. RH- 42%, Avg. Rainfall 11.7"

Avg. Visibility 30 km

**Great for
Electro-optics &
Lasers**

355 VFR Flying
Days/year

*Army Proven
Battle Ready*

White Sands owns 3,421 sq. miles
(8,859 sq. kilometers)

Lease agreements add 2,453 sq. miles (6,353
sq. kilometers)

➤ Partner with Ft. Bliss adds 1,745 sq. miles (4,520
sq. kilometers)

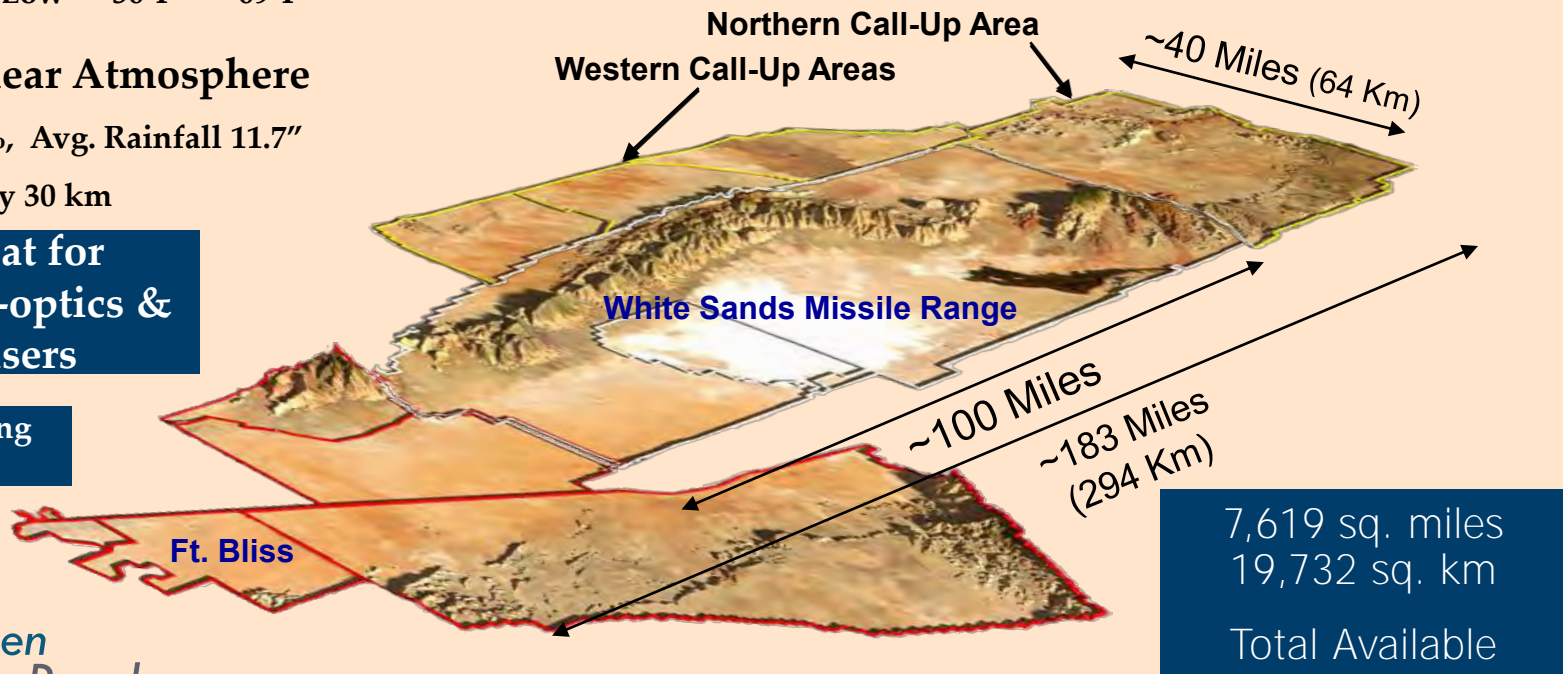

7,619 sq. miles
19,732 sq. km
Total Available

Vast and Diverse Terrain



2,189,225 acres – size of Delaware and Rhode Island combined!



RAGE / RAVE

High desert valley floor - 4,000'

Rolling grasslands, lava flows and rugged canyons

Desert and wooded mountains to 9,000'



Barren dry lake beds, sand dunes to Creosote bushes

WSMR Airspace

Army Proven
Battle Ready

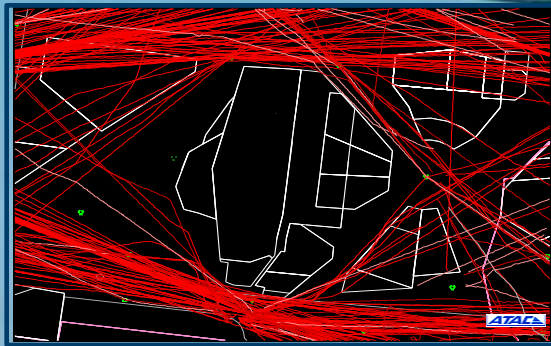
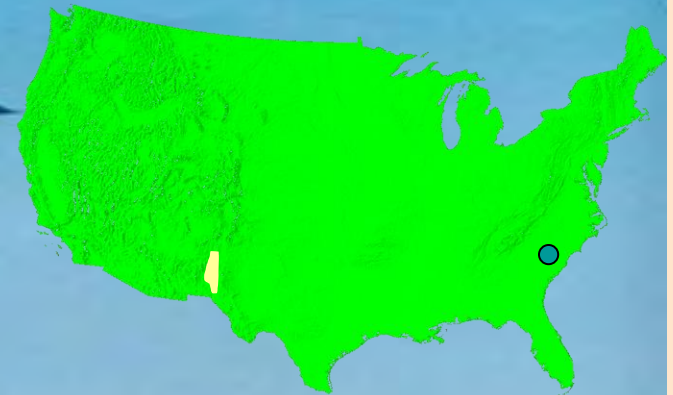
WSMR Airspace - Unique Asset -



-  FAA Command and Controlled Airspace
-  WSMR Command and Controlled Air Space

FAA "WSMR SHADOW"

Commercial Air Traffic routes around WSMR

Air Traffic Control Center;
Army owned (WSMR)
Air Force Operated (49th FW)
Joint and Multi-national Critical

- DoD Restricted Airspace with full command & control authority of the FAA – Ground to Space 24/365
- WSMR is the Controlling Authority and Manager of the Air Space



FAA Certified Air Traffic Control Center at WSMR

Regional Airspace

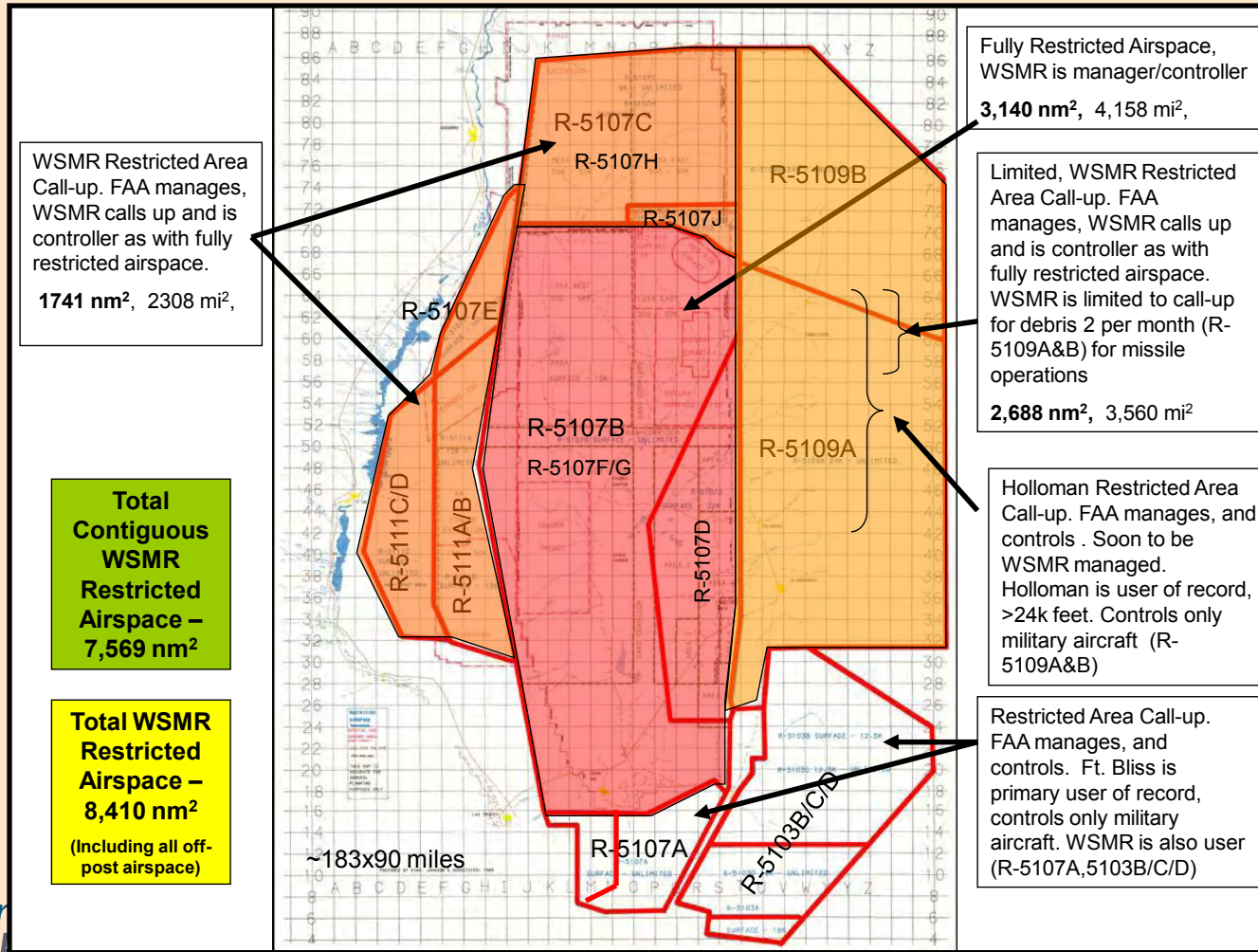

REGIONAL MOAs

WSMR Organization

Organizational Chart



Army Test & Evaluation Command



U.S. Army
Test and Evaluation Command
(ATEC)
★ ★ / SES

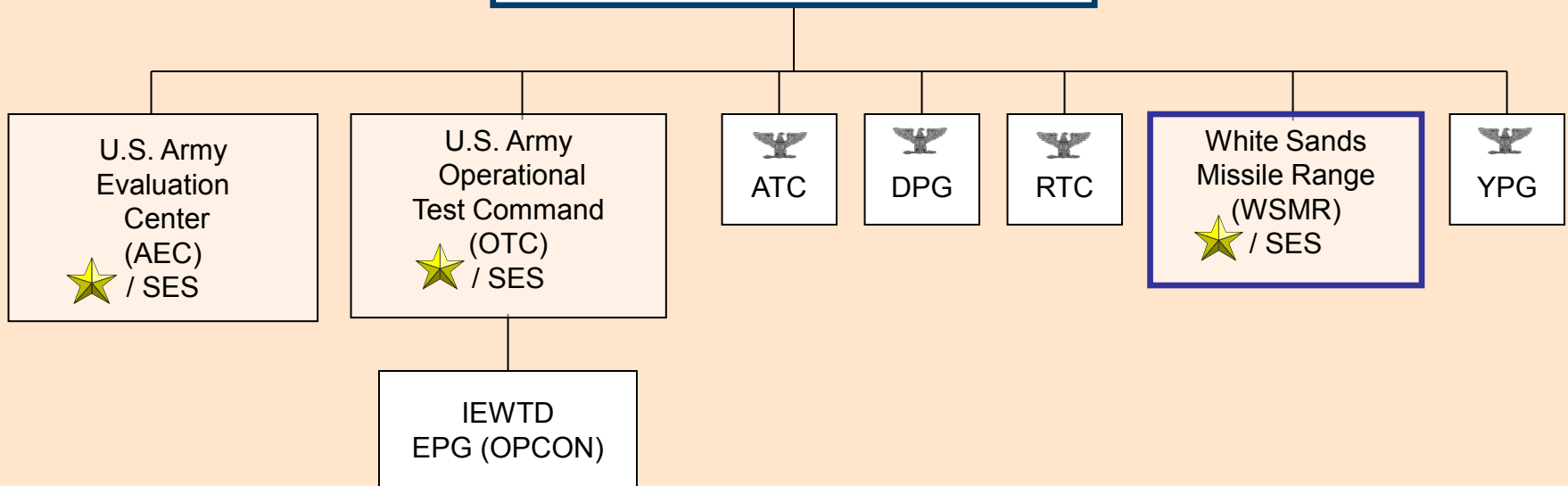



WSMR's Role within ATEC



ATEC : ...plans, conducts, and integrates developmental testing, independent operational testing, independent evaluations, assessments, and experiments in order to provide essential information to decision makers.

WSMR's Role:provide Army, Navy, Air Force, DoD and other customers with high quality services for experimentation, test, research, assessment, development, and training in support of the Nation at war.

Counter IED

ISR

UAV / UGV

Air / Missile Defense

Missiles / Rockets

C4

Systems of Systems

EM Environmental Effects (E3)

Nuclear Effects

Distributed Testing

Directed Energy

Fixed Wing Aircraft Armaments

Environmental / Climatics

Network Integration Testing

*Army Proven
Battle Ready*

Team White Sands



Commanding General
Command Sergeant Major
Executive Director

Chief of Staff

- PIO
- SE
- Safety Surety
- RCC
- RM
- SJA
- IG
- Plans & Ops
- PAO
- SGS
- PC

Deputy for Navy

Deputy for Air Force

Test Center Commander

Garrison Commander
Garrison CSM

Matériel Test Directorate

Range Operations Directorate

Information Management Directorate

Survivability, Vulnerability Directorate

Directorate of Morale, Welfare & Recreation

Directorate of Public Works

Directorate of Logistics

Directorate of Human Resources

Directorate of Emergency Services

Garrison Resource Management

Religious Services

Equal Opportunity Employment

Dir. of Plans, Training, Mobilization and Security

2nd Engineer Battalion

Test Measurement and Diagnostic Equipment

Mission & Installation Contracting Command

Civilian Personnel Advisory Center

McAfee Health Clinic

Dental Clinic

Veterinary Clinic

AAFES

Commissary

PM Capability Package SOSI

National Aeronautics and Space Administration

National Reconnaissance Office

TRADOC Analysis Center

Defense Threat Reduction Agency

Army Research Laboratory

Center for Counter Measures

National Geospatial-Intelligence Agency

- Projects utilizing Team WSMR ranges, facilities or assets are assigned a **local test sponsor**:

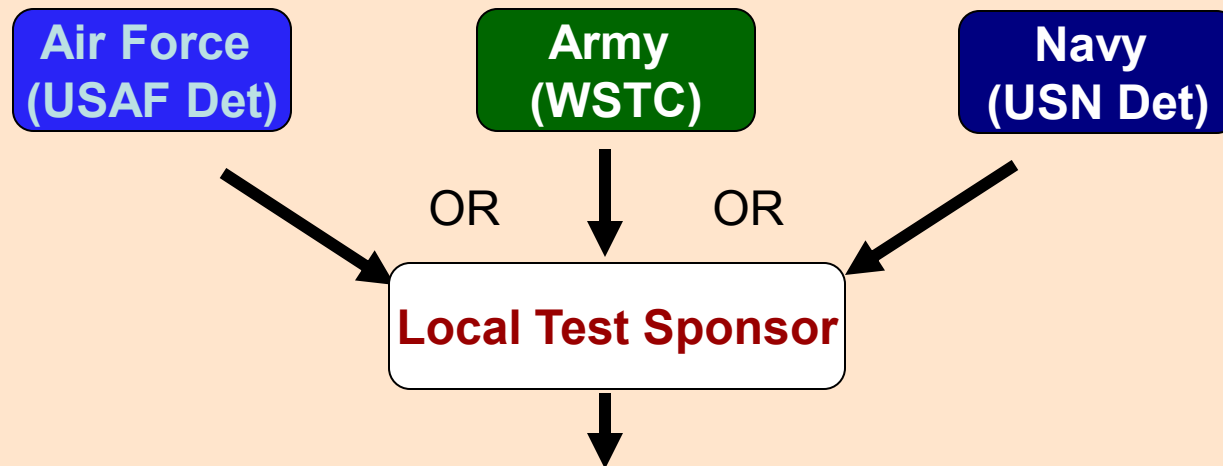

- The test sponsor will assign a **test officer (TO)** → customer's single POC for test execution:
 - Scheduling, detailed planning, cost tracking, receipt of test data, etc.

UDS Timelines

Range Scheduling
TimelinesProgram Priority
Definitions



White Sands Test Center (WSTC)

Capabilities and Test Services Overview

Army Proven
Battle Ready

WSTC Core Capability

--

Indirect & Attack Weapons Testing

Major Attack Weapon

RDT&E Capabilities & Assets

- Precision Strike Missiles
- Extended & long range artillery
- Cruise Missiles
- Smart Munitions
- Warheads testing
- Ground, hardened & deeply buried infrastructure targets
- Long range – live weapon impact areas
- Precision instrumentation
- Tactical environment
- Realistic ground/air target presentation
- Recovery – post test analysis

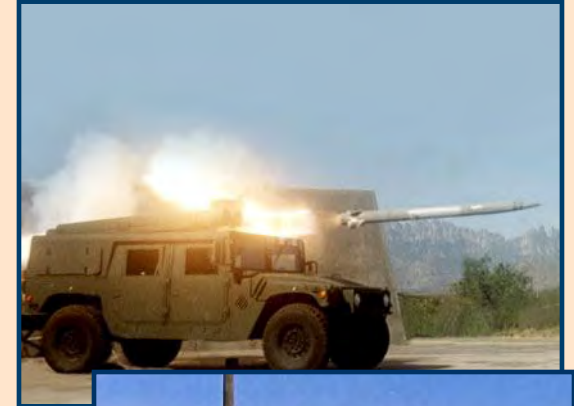

**Only Overland Range for
Extended Range Missile,
Munitions & Artillery**

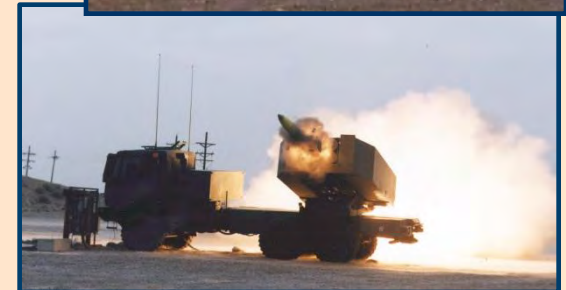

*Army Proven
Battle Ready*

Sub-scale drone launch



HERA Off-range Target



➤ Description

- An expansive array of targets are available for both threat and target presentation to systems under test

➤ Capabilities

- Unique variety / breadth of ground & air targets are available
- DFCS (Drone Flight Control System) can simultaneously control 6 aerial targets.
- TCS (Target Control System) can control ground vehicle targets
- Off-range launch with On-range impact capability (HERA @ Ft. Wingate)
- Unique targets can be supported, by request

QF-4 Full-scale drone



Tracked Target – M-60 Tank



Wheeled Target – Truck



Helicopter MANPADS target at Aerial Cable Range





Off-Range Missile Launch & Flight Corridor



Key for current & future long stand off weapons

-

Missile Defense

Small Diameter Bomb

JASSM

Tri-Service land attack

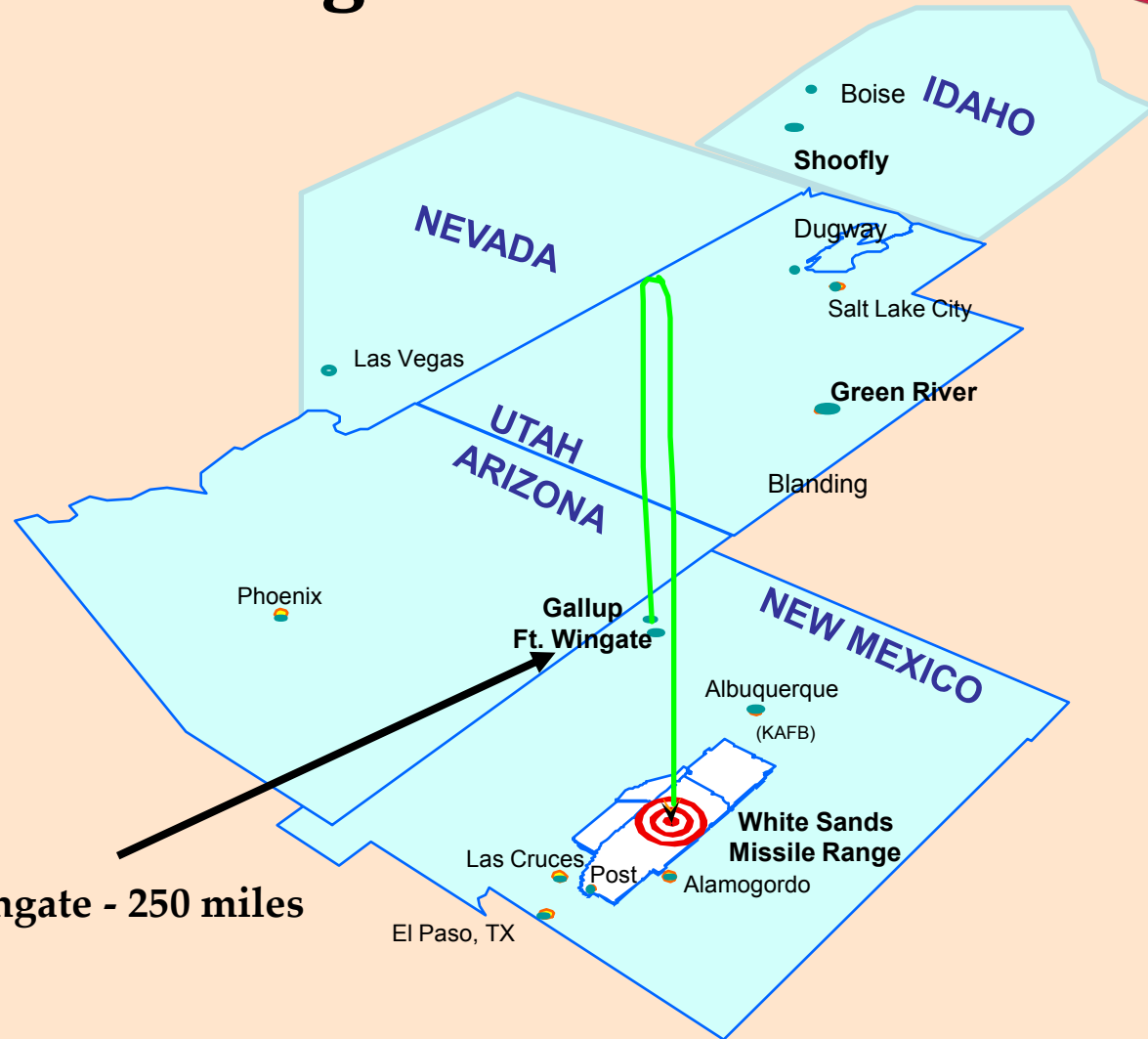

Ft. Wingate - 250 miles

Army Proven
Battle Ready

Testing at WSMR

➤ Precision Fires Rocket and Missile System (PFRMS)

- ATACMS
- MLRS
- ER-MLRS
- GMLRS
- G-SMArt
- HIMARS
- M270 / M270A1 / M270B1

➤ Ground Target @ SMR

- Foreign and US Targets
- Remote Control System

➤ PEO-SOSI Programs

- Non Line of Sight – Launch System (NLOS-LS)
 - PAM
- Manned Ground Vehicles (MGV)
- Excalibur
 - Paladin Test Bed

➤ Joint Attack Munition Systems (JAMS)

- Joint Air to Ground Missile (JAGM)
- Viper Strike

➤ Other

- NGIC
- Stinger
- HAWK
- Round-Up
- Zumwalt Track

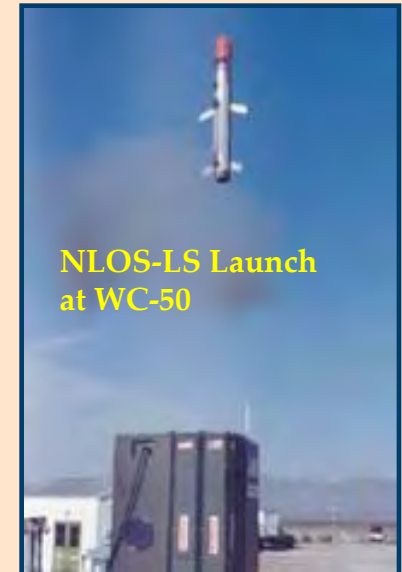

Army Proven
Battle Ready

Weapon Impact Areas



➤ Description

- Numerous weapon impact targets (WITs) to support **surface-to-surface or surface-to-air munitions impacts**

➤ Capabilities

- Impact areas in various locations support **numerous launch site options / ranges**
- Ability to handle **both unitary and cluster munitions**
- Ability to handle **both live and inert munitions**
- Ability to support **artillery, rockets, missiles and bombs**

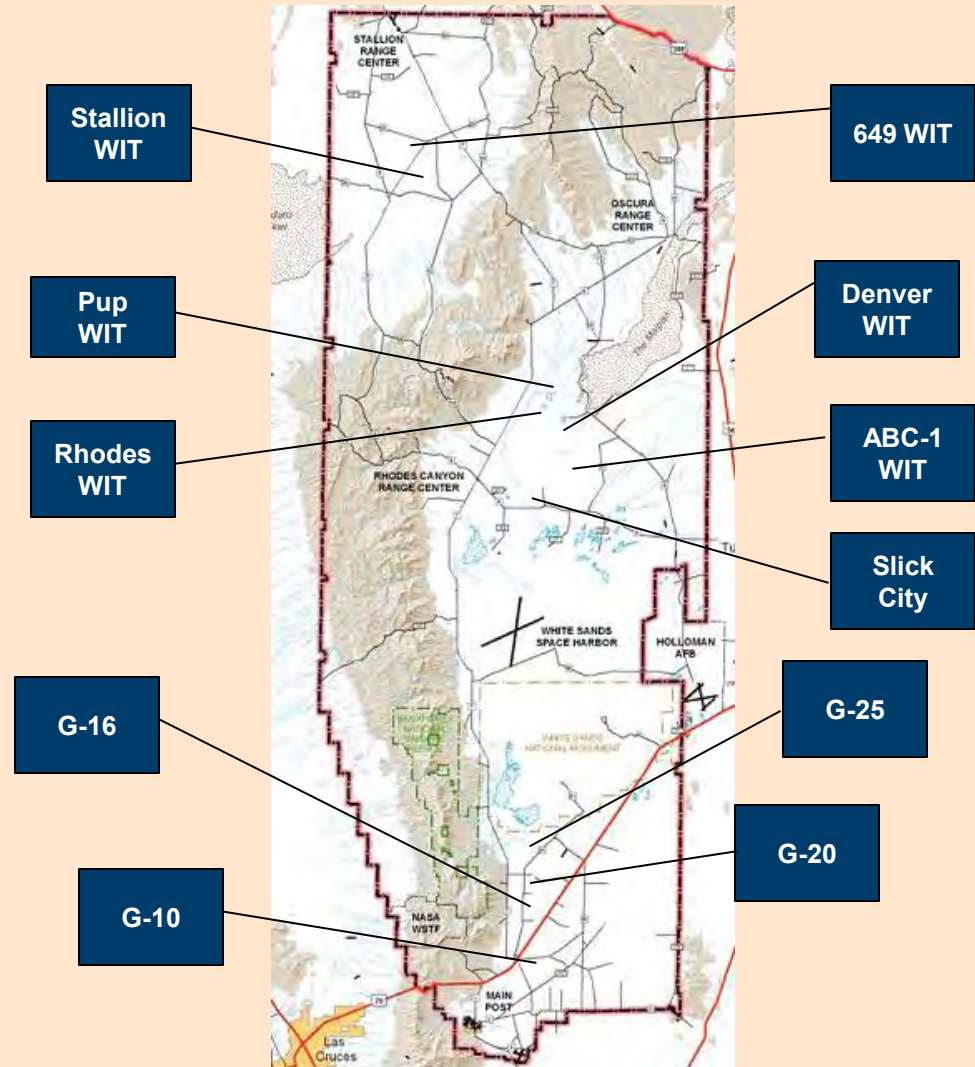



Indirect & Attack Weapons Testing at WSMR

EX. 1

- **SURFACE-TO-AIR WEAPONS TESTING:** Patriot Advanced Capability (PAC)-3

EX. 2

- **ARTILLERY / GUN TESTING:** Excalibur Artillery Round

EX. 3

- **SURFACE-TO-SURFACE WEAPONS TESTING:** MLRS (Multiple Launch Rocket System)

EX. 4

- **AIR-TO-GROUND WEAPONS TESTING:** Small Diameter Bomb (SDB)

WSTC Core Capability

--

UAV Testing

RDT&E Capabilities & Assets

➤ Air & Land Space

- Large safety buffers
- Restricted (Surface to Infinity)
- Local Air Traffic Control
- DOD Freq Mgmt on site
- Call-Up land/airspace



➤ Threat Targets

- Infrastructure
 - Caves, hardened, impact areas
- Ground Vehicles
- Aerial and Air Defense
- ISR / sensor targets
- Live Fire Weapons Release
- Lethality / accuracy verification



➤ Infrastructure

- Runways
- Secure / safe hazardous operations
- Emergency recovery (WSSH – 4 runways)

➤ Logistics

- Munitions Storage / Ammo supply point
- Hangar / Ramp space
- Fuel support



➤ Joint Interoperability

- Air Force – F-22, Predator, etc
- Army Air Defense, PEO-SOSI, Ft Bliss training
- Navy Air Defense
- Other UAV, sensor, missile customers at WSMR

➤ Instrumentation

- Communications
 - Distributed Test Data
- Radar TSPI
- Optics (TSPI, high speed cameras, etc.)
- Telemetry support
- GPS / Timing support
- Met / Wx Support

➤ Operational Environment – Ideal for Test

- Diverse Terrain
 - Mountains
 - Desert
 - Grasslands
 - Trees
- Clear skies
- RF Quiet / Controlled
- Secure (Remote)
- Jamming (EW)



**Army Proven
Battle Ready**

Primary UAV Airfields

Condron AAF and Stallion AAF

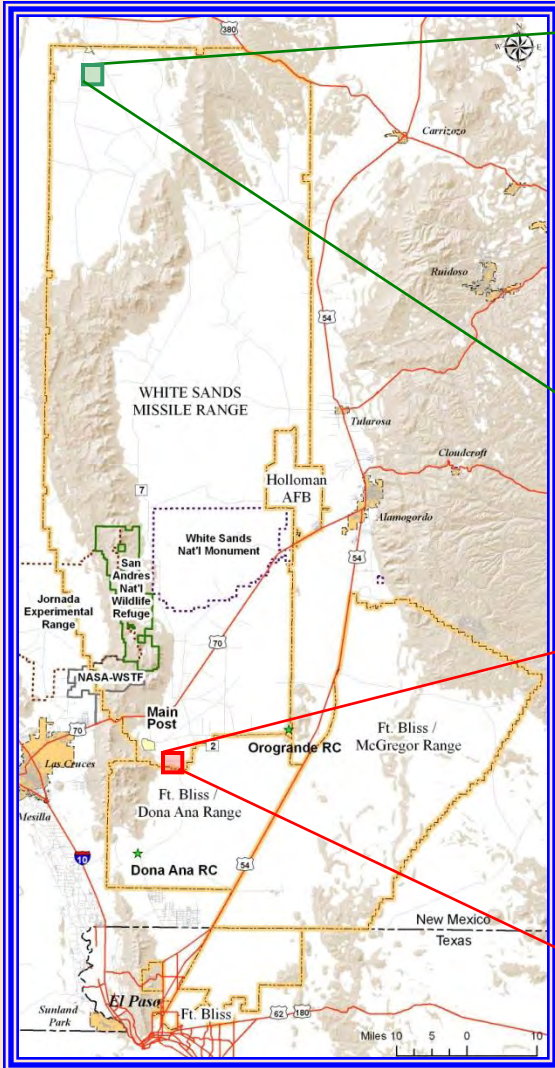

Stallion Army Airfield



Condron Army Airfield

Condron Airfield



Fabric hangar

Main parking apron

Limited logistics support

Drone apron

2 Steel aircraft shelters (concrete pad in between)

Runway 9/27
6125 ft x 100 ft (including shoulders)
Surface: asphalt (resealed in 2007)

Army Proven
Battle Ready

Stallion Airfield



*Army Proven
Battle Ready*

Proximity of UAV



Airfields to Weapon Impact Areas

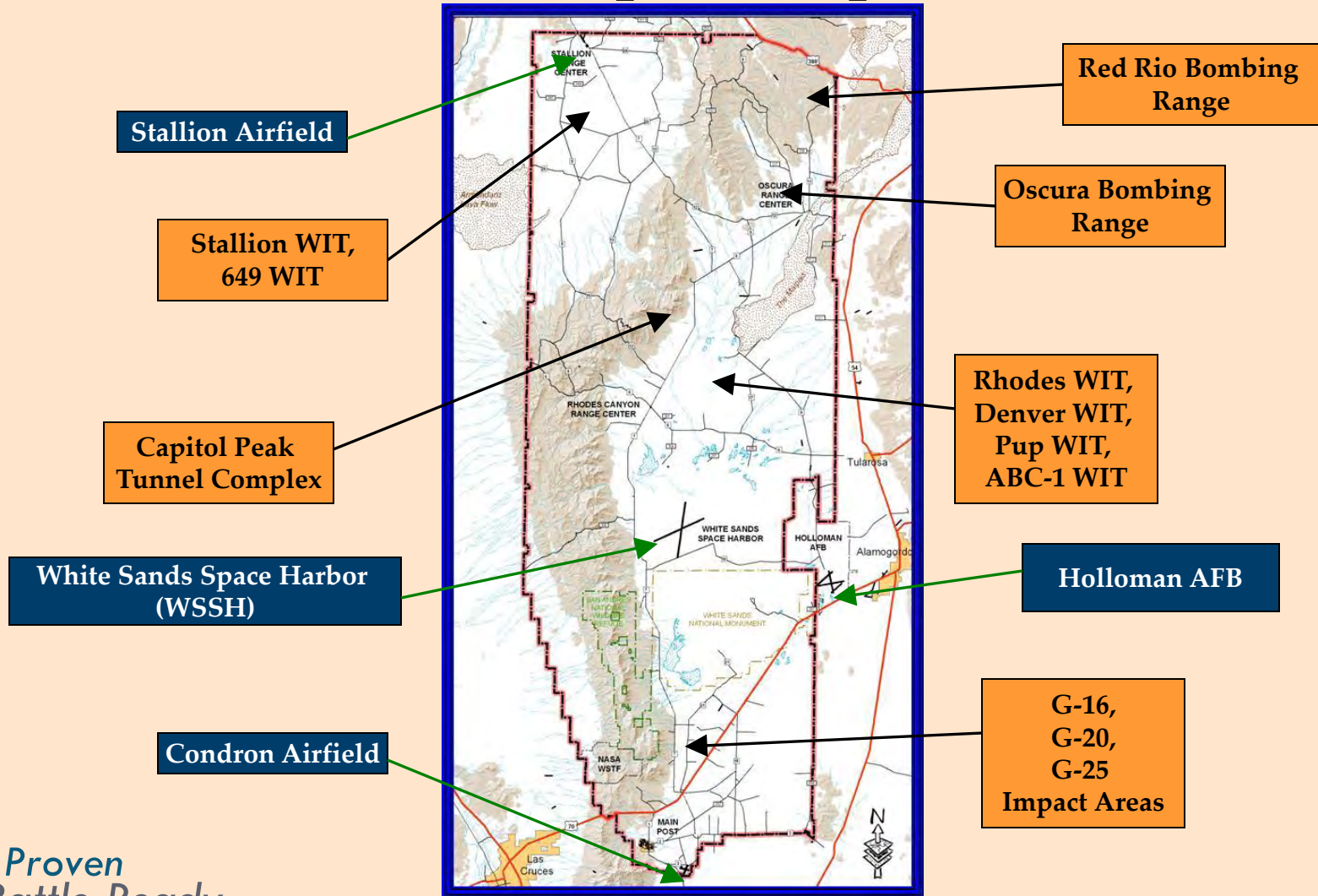



UAV Testing at WSMR

EX. 1

- UAV FLYING QUALITIES TESTING: SPAD UAV

EX. 2

- UAV SENSOR TESTING: DARPA HART System for UAV Sensors

EX. 3

- UAV WEAPONS TESTING: HUNTER UAV / VIPER STRIKE BAT

WSTC Core Capability

--

Environmental Testing

RDT&E Capabilities & Assets

- World-wide Climatic Conditions
- Service Life Shock & Vibration
- Chemical & Microbiology Laboratories
- Missile Launcher Instrumentation
- Metallurgy / Non-destructive testing
- Safari capability

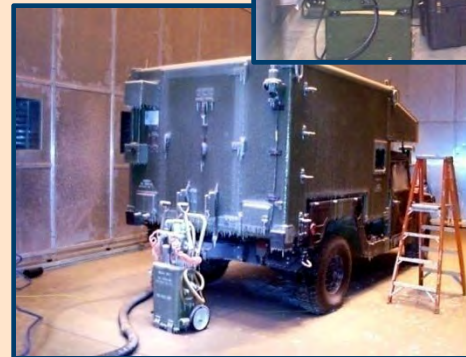

-Co-Located with Test Ranges

- Key To Accelerated / Efficient System development

-Expertise in MIL-STD-810F or G

- Environmental Testing Methodologies

*Army Proven
Battle Ready*

Temperature Test Facility



➤ Climatics testing capabilities

- Fixed and mobile test equipment
- Temperature range: -65 to 180°F
- Humidity (5-100%)
- Salt Fog (5-20%)
- Rain: 0.5-27 in/hr
- Wind gusts: 80 mph max
- Safari capability at customer's site

Army Proven
Battle Ready

➤ Temperature Test Facility (TTF)

- DOD's Largest Explosively Rated Chamber
- Large Chamber: 40'W x 50'H x 105'L
- Small Chamber: 35'W x 30'H x 20'L
- High/Low temperature, humidity, solar radiation, icing, salt fog, etc.
- Instrumented for system performance / diagnostics



Shock & Vibration

➤ Description

- Two Shock and Vibration facilities capable of testing large and small items, including at temperature extremes

➤ Capabilities

- 5 electrodynamic shakers (up to 50,000 lbf and 2 inch displacement)
- 3 shock test machines (up to 4500 lbf capacity and 100g)
- Sustained acceleration centrifuge (100g)
- Loose cargo tester
- Pyro-shock testing (using explosives or metal-to-metal impact)
- Rail impact testing (pendulum tester, or via nearby railhead at Ft Bliss)

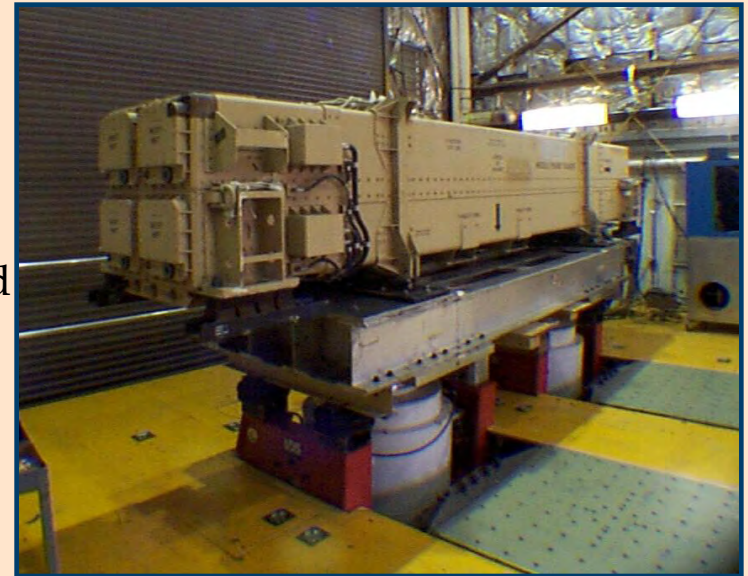



➤ Description

- Metallurgical and radiographic testing and analysis, typically as complimentary support of other test efforts occurring at WSMR
- Organizationally part of the Applied Environmental Effects Division

➤ Capabilities

- Common metallurgical evaluation techniques
- Radiographic inspection of missiles/test items
- Scanning electron microscope
- Boresight inspections



➤ Capabilities

- Conformance Testing of materials
- Toxic Gas testing of rocket/motor exhaust
- Explosives Analysis
- Environmental Measurements / Analysis
 - Hazardous Waste
 - Air / Water quality
 - Soils analysis
- Special problems

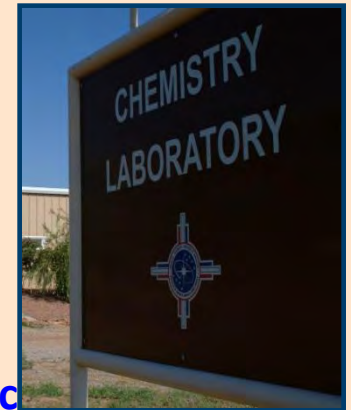

➤ Laboratory Certification

- ORELAP
- TNI Accreditation (ISO 17025)
- EPA Analysis – Certified Chemistry Lab



Environmental Testing at WSMR

EX. 1

- **CLIMATICS:** High Temperature / Solar Radiation Test

EX. 2

- **CLIMATICS:** Blowing Sand Test

EX. 3

- **CLIMATICS:** Icing Test

EX. 4

- **SHOCK / VIBRATION:** Vibration Test

EX. 5

- **RADIOGRAPHIC INSPECTION:** Rocket motor inspection

WSTC Core Capability

--

Electromagnetic Environmental Effects (E3) Testing

➤ Description

- WSMR is a recognized center of expertise for E3 testing of military systems
- Ability to test systems to the MIL-STD-461F, MIL-STD-464C, ADS-37A
- Ability to test to many DoD, NATO, Commercial standards as well

➤ Major Test Capabilities / Expertise

- EMI Electromagnetic Interference
- EMC Electromagnetic Interference Compatibility
- ESD (Electrostatic Discharge) – personnel, helicopters
- EMP Electromagnetic Pulse
- EMR (Electromagnetic Radiation) – fuel, ordnance, personnel
- HPM High Power Microwave
- LE (Lightning Effects) – Direct or Near Strike Lightning



➤ LE: Lightning Test Facility

- LTF is capable of simulating both Direct and Near-Strike Lightning
- 50m x 50m
- Peak E-field is 150 kV/m
- 2 stage high current bank



➤ EMC: Open Air 72-ton Turntables (3) at EMRE

- Full body illuminations: 100 kHz – 500 MHz
- Localized illuminations: 500 MHz – 45 GHz
- MIL-STD-464C compliant
- AM, FM, PM and CW modulations
- 33 ft diameter



➤ **EMP: Advanced Pulse Electromagnetic Pulse Simulator Facility**

**New
Facility**

- 60 radiating wires → transition to 6 per side
- 6 Kevlar guy lines
- 20-22m to pulser centerline
- 280' x 210' footprint
- 18m test volume
- 3.0MV operating voltage
- Bounded wave antenna
- 2 minute repetition rate
- 95% wave shape reproducibility
- MIL-STD-2169B compliant

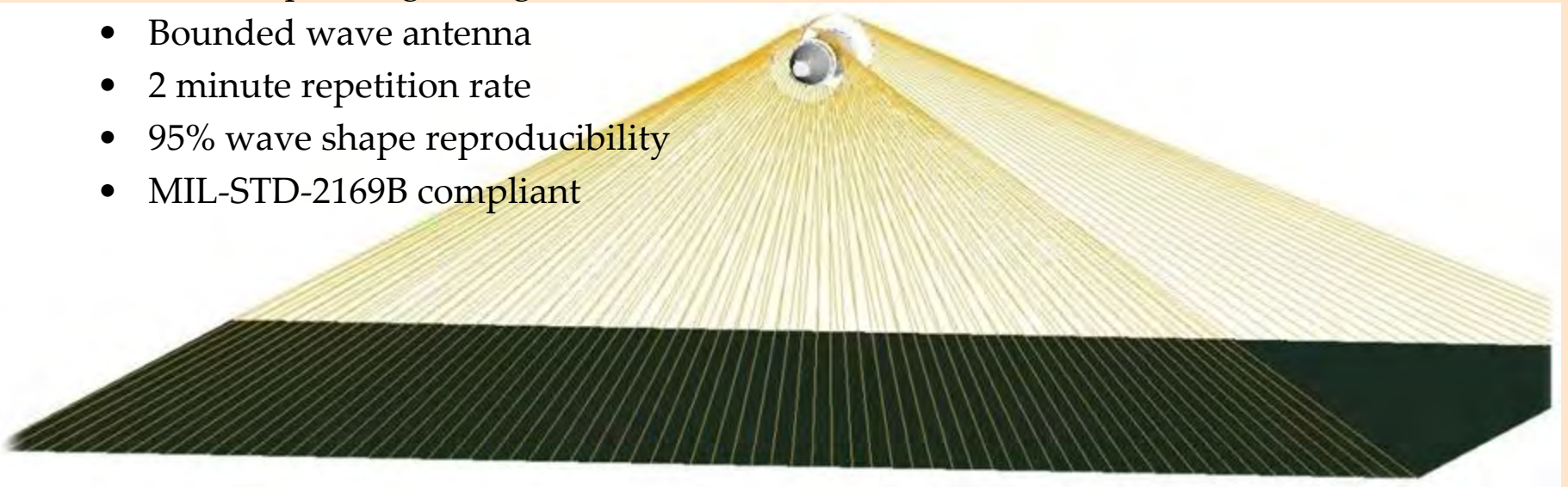

*Army Proven
Battle Ready*

New Facility

➤ **HPM: Directed Energy / High Power Microwave Facility**

- Dedicated open-air HPM testing (25 acres)
- Reinforced concrete pad (120' x 120')
- HPM Bldg (55' x 100') w/10-ton crane
 - Shielded Screen Room; Portable Clean Room
- **NB (narrow band) (36) Magnetron Threat System**
 - 140-1000 MHz & 1000-2660 MHz; 50 freqs per Magnetron
 - NB Magnetrons, 1.25-38.3 GHz, b/w 10-45 kV/m @ 1m
- **NB Super Reltron Threat System**
 - 700-3000 MHz; 55 kV/m @ 15m (4m x 3m)
- **WB (Wide band) Threat System**
 - 100-300 MHz, 30kV/m @ 1m; 220-6000 GHz, 220 V/m/Hz @ 15m
- **UWB (Ultra wide band) Threat System**
 - 670-4300 MHz, 35kV/m @ 30m





➤ EMI: Large Shielded EMI Test Facility at EMRE

- EM shielded test cell
- MIL-STD-464C compliant
- 60 ft L x 40 ft H x 40 ft H
- Exhaust system for diesel and turbine engines



➤ ESD: Electrostatic Discharge Test Facility

- Can test items up to size of a helicopter / ground vehicle
- MIL-STD-464C compliant
- HESD (helicopters): Up to 400 kV DC positive/negative
- PESD (personnel): Up to 30 kV DC positive/negative



WSTC Core Capability

--

Nuclear Effects & Characterization Testing

Nuclear Effects & Characterization Testing



➤ Description

- WSMR is a recognized center of expertise for radiation effects, evaluation and assessment
- Can simulate most aspects of a nuclear detonation, on a system under test, for nuclear survivability evaluations
- ISO 9000 Lab Suitability Certified

➤ Major Test Capabilities/Expertise

- Nuclear Blast Effects
- Gamma Radiation Environments – total, residual, low dose and high intensity
- Transient Radiation Effects on Electronics (TREE)
- Nuclear Thermal Effects
- Neutron Radiation Environment
- Space Radiation Effects
- Radiation Tolerant Electronics - certification, procurement, storage and testing

and Characterization Test Facilities

➤ Nuclear Blast: Large Blast Thermal Simulator

- LBTS simulates the blast wave from a nuclear detonation
- DTRA (Defense Threat Reduction Agency) facility
- 170 m L x 20m diameter, concrete shock tube
- Uses compressed air to produce blast wave
- Uses a Thermal Radiation Source to produce the thermal pulse



Army Proven
Battle Ready

New
Facility

➤ Gamma Dose Rate Radiation: PI-538 Machine

- PI-538 is a Flash X-ray simulator that produces the gamma dose rate environments of a nuclear weapon detonation
- Co-located with Fast Burst Reactor
- Repetition rate = 4 shots/hour
- Facility includes real-time instrumentation of the test item response and the environment
- Operates in either mode: X-ray mode or Electron beam mode



and Characterization Test Facilities

➤ Neutron Radiation Environment: Fast Burst Reactor

- FBR simulates the neutron radiation environment of a fission nuclear weapons
- Produces high-yield pulses of micro-second width, or
- Produces long term steady-state radiation



➤ Gamma Radiation: Gamma Radiation Facility

- GRF provides total gamma dose and residual gamma dose environments
- Used primarily for TREE experiments and gamma dose survivability evaluations
- Also can be used for radiography and shielding experiments

and Characterization Test Facilities



➤ Gamma Radiation: El Dorado Gamma Facility

- EGF is an Enhanced Low Dose Rate Sensitivity (ELDRS) gamma room irradiator
- Tests gamma radiation effects on semiconductors, circuit boards and entire electronic units

➤ Gamma Dose Rate Radiation: Linear Electron Accelerator (LINAC)

- LINAC simulates the high-intensity gamma spike associated with a nuclear detonation
- High energy, short duration pulses of radiation
- Used to test gamma dose-rate-sensitive electronics at the piece part, component and assembly level

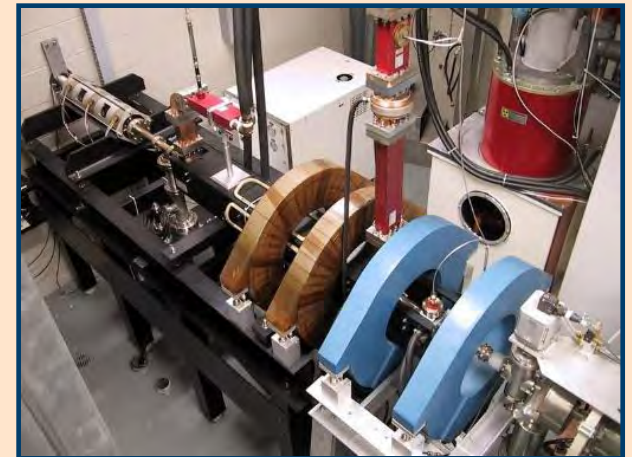

Major Nuclear Effects

and

Characterization Test Facilities



➤ Nuclear Thermal Effects: Solar Thermal Test Facility

- STTF produces intense thermal radiation to simulate the nuclear blast (1 kT to 3 MT) thermal radiation environment
- Also can produce steady state thermal radiation exposures of long duration
- At full power, can penetrate 0.5in stainless steel in 40 sec

➤ Radiation Tolerant Electronics: Radiation Tolerance Assured Supply and Support Center (RTASSC)

- RTASSC assists military and space customers in certifying, storing, testing and procuring radiation tolerant (RT) electronics due to diminishing manufacturing sources and materiel shortages
- Provides RT "cradle-to-grave" lifecycle management and solutions
- ISO 9002 certified

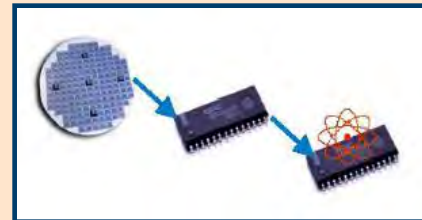
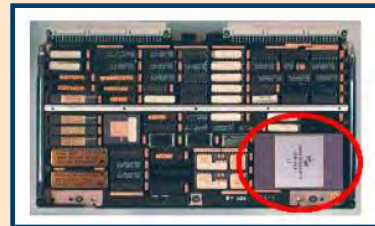

Army Proven
Battle Ready

WSTC Core Capability

--

Instrumentation & Data Acquisition

Leading Open Air Range



Instrumentation Technology Development

Reliable, Accurate and Precise Measures of Performance

- Technology development
- Long range – high altitude electro-optics
- High speed digital visible/IR
- Telemetry –fixed and mobile
- Laser, radio frequency & high power microwave
- Radar & global positioning system

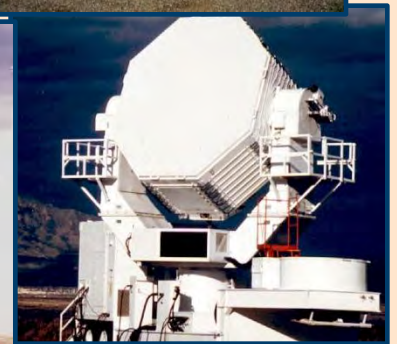

**Tri-Service technology sharing
via range commanders council**

*Army Proven
Battle Ready*

SAFARI Example



➤ Major Assets

- | | |
|---|------|
| • Advanced Range Data System (ARDS) Pods | 15 |
| • ARDS Plates | 6 |
| • CRIS (Common Range Instrum System) RPI | 100+ |
| • Master Remote Ground Stations | 10 |
| • Data Link Ground Stations (DLGS)
(Bldg 335, 1270 and one mobile) | 3 |

➤ Capabilities

- Tri-Service, Multi-Player, GPS TSPI Tracking System
- ARDS Pods/Plates are P/Y- Code, IMU-Aided Units with on-board Flash Recorders
- Supports Real-Time And Post Mission Scenarios
- High Accuracy, Mobile Systems
- Adaptable Configurations (AIM-9 Pods, plates, suitcase, Miniplates, to suite)
- Over The Horizon Tracking Via Pod to Pod Relaying
- Supports 250 TSPI Updates/Sec (25 Targets @ 10 Hz)
- Real Time Displays at RCC and/or Project Sites
- Differential Corrections Broadcast
- GPS Reference Receiver Data Collection

➤ Common applications

- Provide TSPI on a wide variety of fixed wing aircraft, helicopters, ground vehicles, drones, and cruise missiles
- ARDS also provides velocity, acceleration, attitude, and attitude rates

➤ Notional Turn-time: GPS TSPI

- Often within 4 hours
- Almost always within 1 day



➤ Major Assets

- Fixed systems (SAMS, upper air) 44
- Mobile systems (towers, trailers) 28
- Models (impact, drift, 4DWX) 8



➤ Capabilities

- Weather Forecasting, Warning, Advising, Impact Prediction, and Object Drifts.
- GPS Upper Atmospheric Sensing, Profilers, Wind Finding Radars, and SODAR.
- Automated Surface Towers with Climate Data Record for planning.
- Range Scale 4-Dimension Weather Model
- Total Lightning Mapping Array.

➤ Common Applications

- Mission planning and tailoring of meteorological requirements
- Characterizes the atmospheric effects on tests and materiel
- Defines surface conditions for testing and warning criterion
- Mobile capability and data collection in impact areas
- Impact prediction and debris cloud and chaff drift forecasts



➤ Major Assets

• Mobile Remote Tracking Mounts	16
• Mobile Remote Control Stations	4
• Mobile Infra Red Telescope (MIRT)	1
• High-Speed Digital Cameras	60
• Science Grade IR Cameras	5
• Standard Video Cameras	100
• Flight Follower	1

➤ Common Applications

- Used to document launch, intercept, dispense and impact events
- Primary mission is to provide Time, Space, Position, Information (TSPI) on missile flight tests

➤ Notional Turn-time: Optics Data

- KTM or fixed camera (non-TSPI) footage - < 1 day
- KTM TSPI data - typically 2 weeks

➤ Capabilities

- Tracking and Non-Track capabilities
- Demonstrated 1 meter accuracy
- Digital video coverage in both visual and IR up to 1000 frames per second (1024 x 1024 pixel FOV) – 12 sec run time
- Can increase to 20,000 frames per second (decreased FOV, decreased run time)

Army Proven
Battle Ready



➤ Major Assets

- Multiple Object Tracking Radars (MOTRs) 2
- Single Object Tracking FPS-16 Class Radars 10
 - Mobile 7
 - Fixed/Permanent 3
- Weibel CW Radar 1
- ASR-9 Air Surveillance Radars 3

➤ Common Applications

- Real-Time Tracking (TSPI on missile tests)
- Target Motion Resolution (Precision Doppler, Events, Coning Motions)
- Multigate (Miss Distance, Events, Debris Cloud Spread)
- Test Volume Air Surveillance

➤ Capabilities

- MOTR can track up to 40 objects
- Instrumentation Radars can track object the size of a softball to 100Km
- Accuracy of 3 yards (with transponder beacon)
- Accuracy of 5 yards (with skin track)
- Expanded ASR-9 surveillance coverage

➤ Notional Turn-time: Radar Data

- FPS-16 or MOTR TSPI - 4 hours
- Weibel TSPI – 1 hour
- Weibel predicted impact – 30 min



➤ Major Assets

- Fixed Tracking systems (Jig-56, 67, 10) 3
- Demux system (Jig-3) 1
- Mobile TM systems (MTS) 4
- RF Interferometers (MFS supt.) 2
- Launch/Impact Area Vans 2
- Telemetry Data Center 1
- Transportable Range Augmentation and Control System (TRACS) van 1

➤ Capabilities

- L & S band (1435 MHz -2400MHz)
- IRIG Modulations (multi-downlinks): PCM/FM, PCM/FM/FM, SOQPSK, FM/FM, PCM/FM+FM/FM
- Recording medium: VHS, METRUM Digital Magnetic Tape recording, Hard Drive
- Support up to 5 airborne targets on range simultaneously (with non-redundancy)

➤ Common Applications

- Off-Range, OCONUS support (Alaska, PMRF, JAPAN, Ft. Wingate)
- Real Time and Post Flight Data Review

➤ Notional Turn-time: TM Data

- Field TM recording / processing – within 1 day
- Often within 6 hours

WSTC Core Capability

--

Complex Range Operations

- Core Capability -

Complex Range Operations

- Multi-asset and Multi-mission Command & Control
- Comprehensive Launch & Live Fire Test Sites
- Network Operations
- Air Traffic Command & Control
- EOD & Recovery Operations
- “Many vs. Many” Test Scenarios
- Simultaneous C2 of ground & air test assets
- Weapons, Flight & Radiation Safety
- Expansive list
- Meteorology

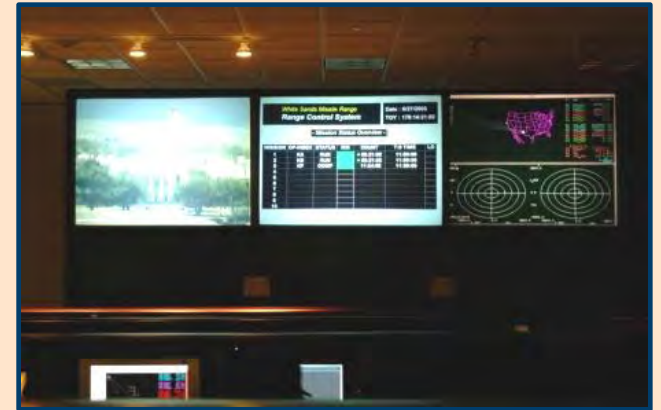

**DoD's Most Advanced Test
Control Facility**

*Army Proven
Battle Ready*

Example of Complex Mission

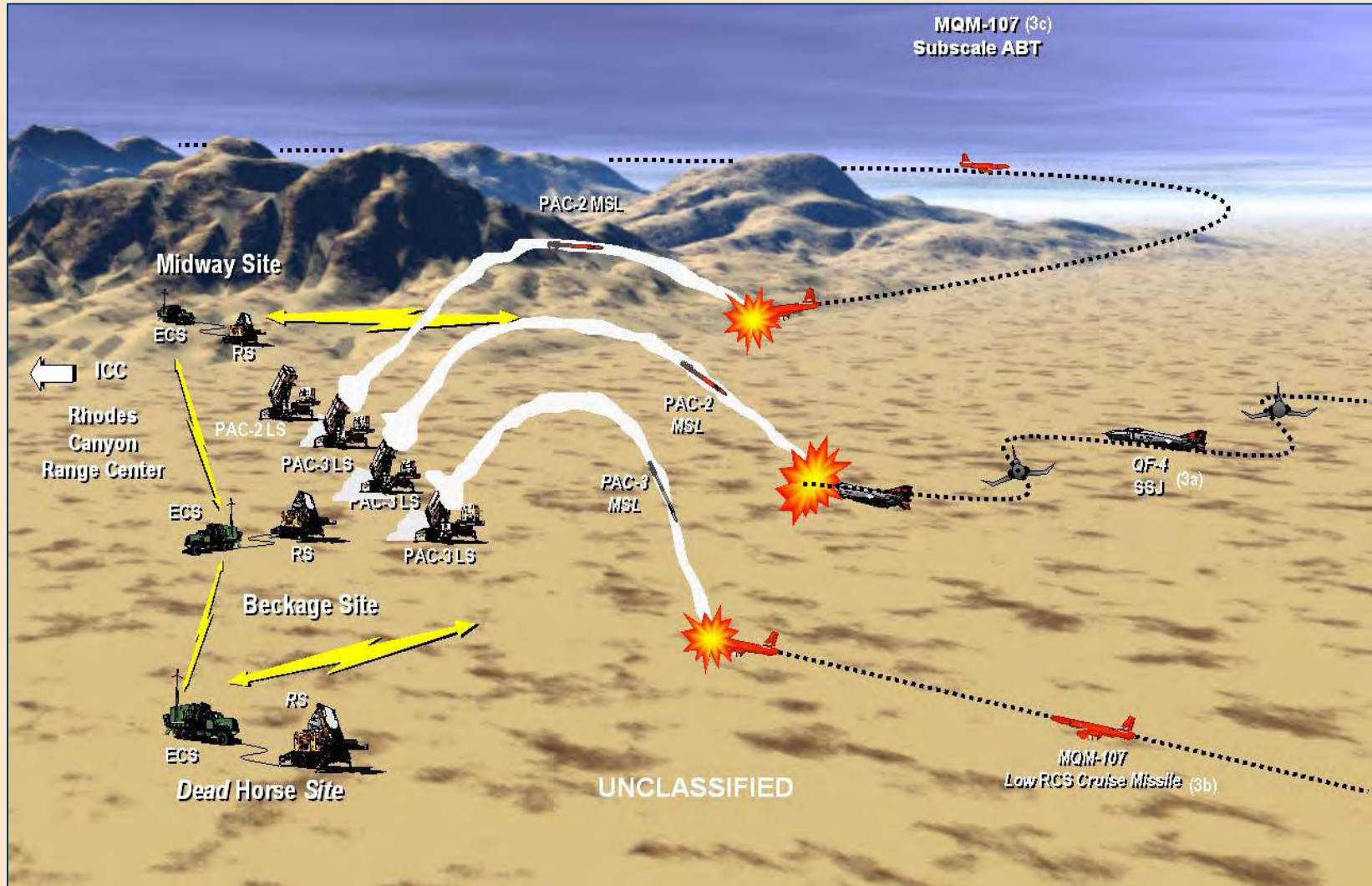

WSTC Core Capability

--

Distributed Testing

ATEC's Inter-Range Control Center (IRCC)

- Distributed Test Conduct
- Network Control/Management
- Data Management
- Viewing Portal
- Modeling & Simulation Integration

Persistent, secure connectivity to Army and Joint labs, hardware-in-the-loop test facilities, and live test ranges.



Fully interactive
voice, video, and data
distribution

Army Proven
Battle Ready



Distributed Testing Network Connectivity



➤ Test/Training Support Network (TSN)

- Fiber optic rings, 1500+ miles of fiber
- Multiple nodes – data coms entry
- Direct connect instrumentation, voice (radio), video, telemetry, radar and tactical sensors or systems and wireless transceivers

➤ Secure Wireless Network Initiative

- Mobile Information flow
- Tactical systems and C4ISR data

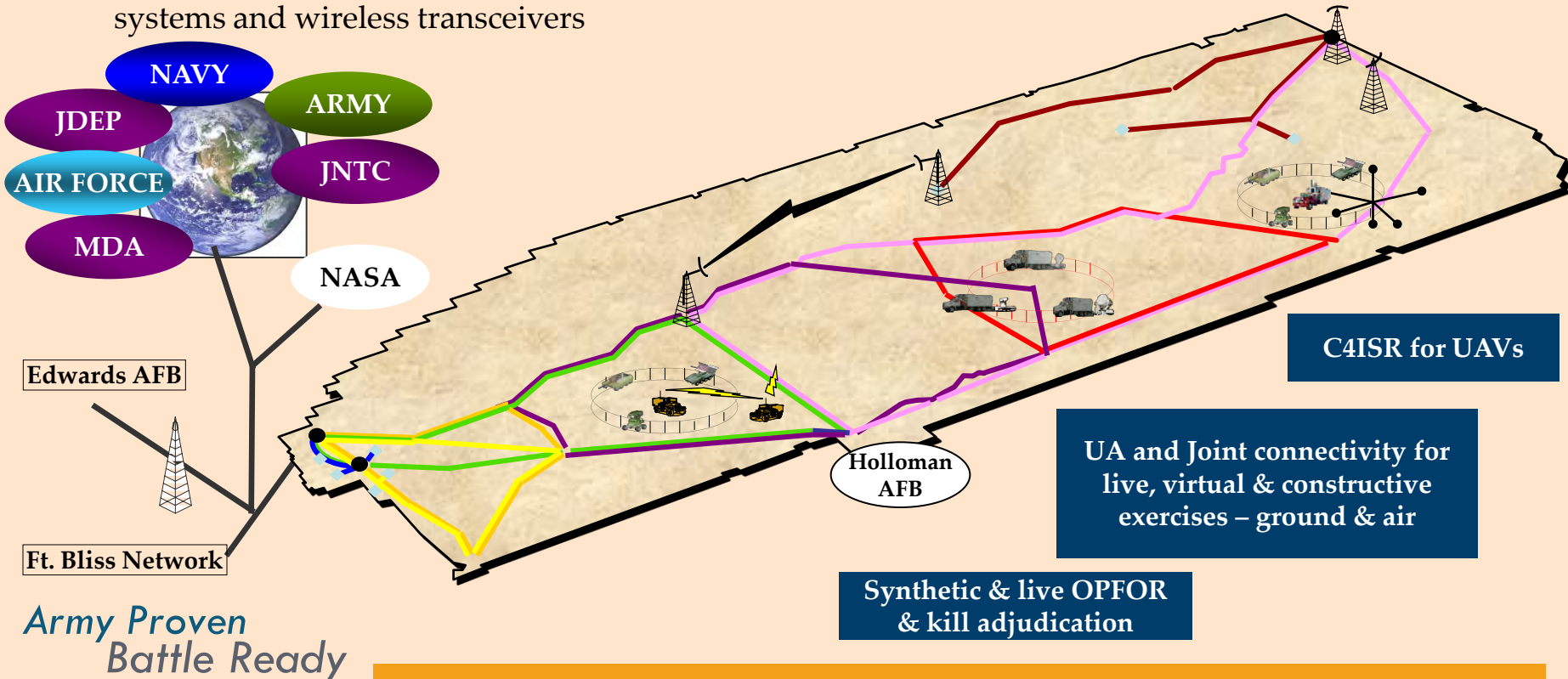

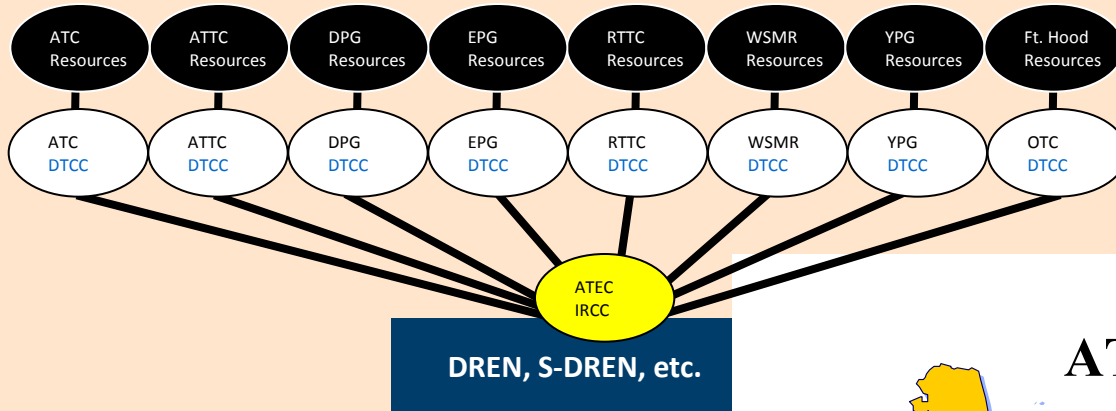

ATIN
Cross-Command
(ATEC, TRADOC, RDECOM)
Others

DTCC Common Capabilities:

- Data management across the test centers/ranges.
- Center/range teams dedicated solely to distributed test.
- Digital test control on individual center/range.
- Center/range links for sims/stims input or data exchange.

ATEC DREN Sites

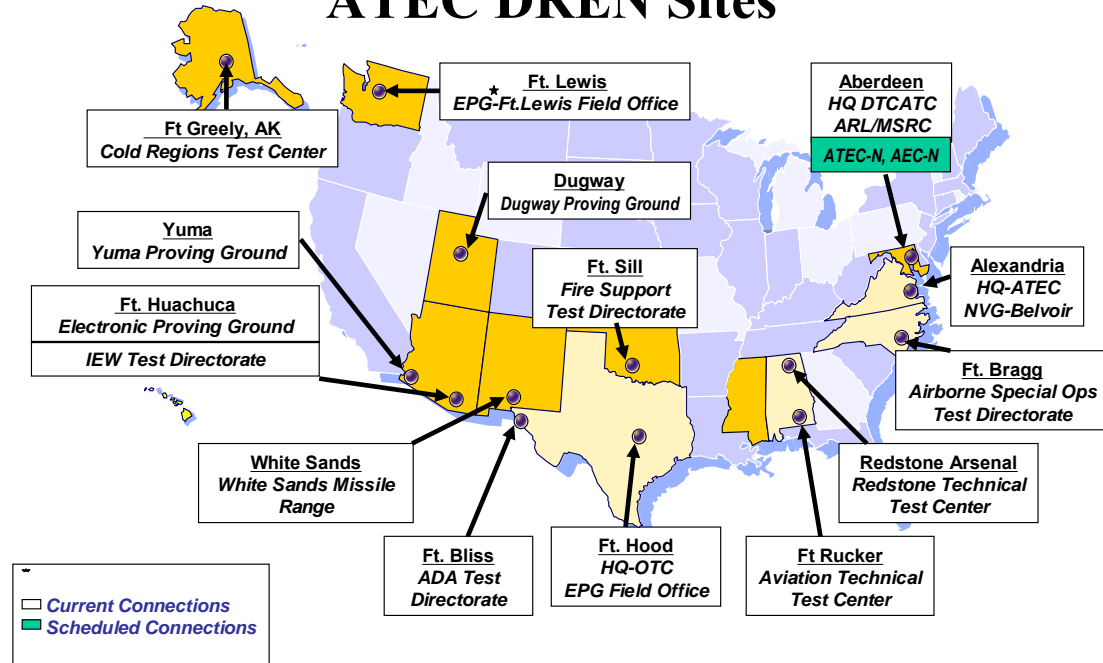

Joint Connectivity



Joint Mission Environment Test Capability (JMETC)

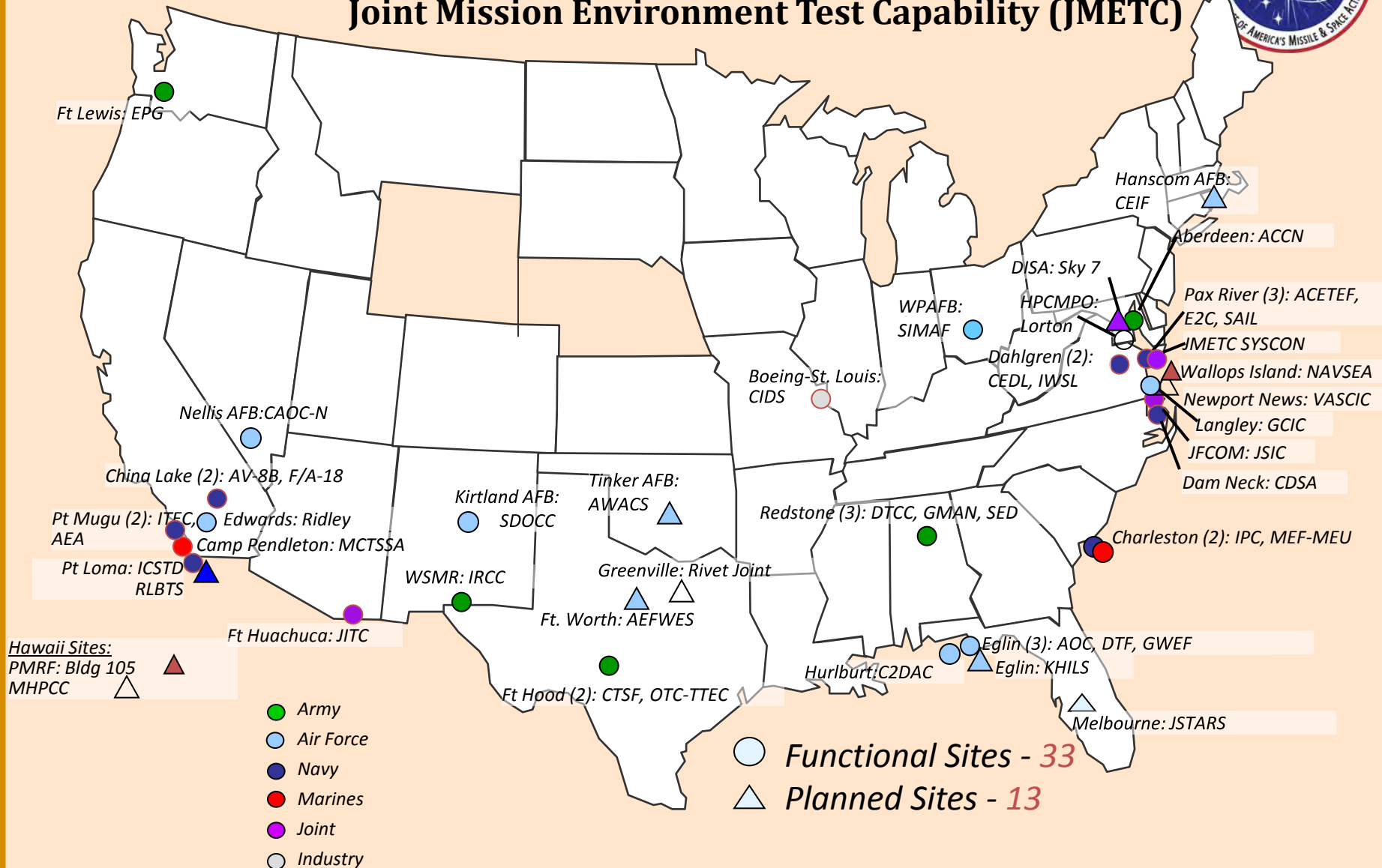

WSTC Core Capability

--

Directed Energy Testing

➤ Directed Energy Testing

- Remote location, mountain backstop
 - Radiation safety buffers
- Large airspace extending to space
 - Dynamic engagements
- Threat & Developmental Targets
 - Missiles, artillery, aircraft, vehicle
- Clear, dry air
 - Laser beam propagation
- RF quiet & remote area
 - No collateral effects





Newly Reorganized; now part
of WSMR's SV Directorate

High Energy Laser Systems Test Facility (HELSTF)

High Energy Laser System Test Capability (HELSTF)



Mission:

- Plans and conducts high energy laser T&E in operationally relevant environments
- HELSTF serves as the U.S. Army's Space and Missile Defense Command's "Directed Energy Center for Test and Evaluation."



Key Capabilities at WSMR:

- The ONLY High Energy Laser Systems Test Facility in the U.S. Associated with a Test Range
- Over-the-horizon high energy laser (HEL) test range
- High energy laser against space targets



RDT&E Assets & Capabilities

- Sea Lite Beam Director
- Hazardous Test Area
- Tactical High Energy Laser (THEL) Beam Director
- Solid State Heat Capacity Laser Test Bed
- Joint High Power Solid State Laser (JHPSSL)
- Large Vacuum Chamber (LVC)

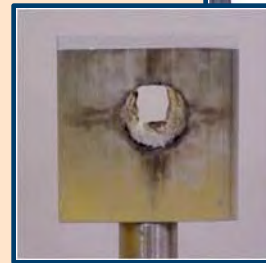

*Army Proven
Battle Ready*

RDT&E Assets & Capabilities

- Pulsed Laser Vulnerability Test System (PLVTS), Utilization of HELSTF assets for High Energy CO₂ Laser Testing for Lethality, Vulnerability and Propagation
- The transportable Advanced Pointer Tracker (APT) is a 60 cm beam director for the PLVTS to conduct dynamic tactical engagements.
- 20kW IPG SSL



*Army Proven
Battle Ready*



National Geospatial-Intelligence Agency



Department of the Air Force



PEO-Integration



Department of the Navy



Defense Threat Reduction Agency

Other Team WSMR Organizations

Capabilities and Test Services Overview



Army Research Laboratory



TRADOC Analysis Center



National Reconnaissance Office



National Aeronautics and Space Administration



Center for Countermeasures



Test Measurement and Diagnostic Equipment

Army Proven
Battle Ready



U.S. Air Force at WSMR

49 FW and 46 TG, Holloman AFB

--

Capabilities and Test Services Overview



- **F-22 Stealth Fighters**
 - Mission ready deployable assets
 - F-22 pilot training
- **Supports Air Expeditionary Force (AEF) Operations**
 - Air Transportable Medical Clinic
 - BEAR Base Operations
- **Air Traffic Control (ATC) operation for WSMR**
- **German Air Force Tornado Operations**
 - Training



*Army Proven
Battle Ready*





Holloman Air Force Base

Mission

Operate world-class test facilities for high speed sled track testing, navigation and guidance system testing, radar signature measurements, weapon systems flight testing, and Air Force Liaison for all AF programs tested at White Sands Missile Range (WSMR).

46 TG at HAFB

586 FLTS

746 TS

781 TS

846 TS

46 TG Det 1

SQUADRON MISSION:

- Avionics & Weapons Flight Test Over WSMR
- Photo and Safety Chase
- Access to Full-scale and Sub-scale aerial targets



Sub-scale aerial target

ECM pod flight tested on an AT-38B



F-15 Missile Launch

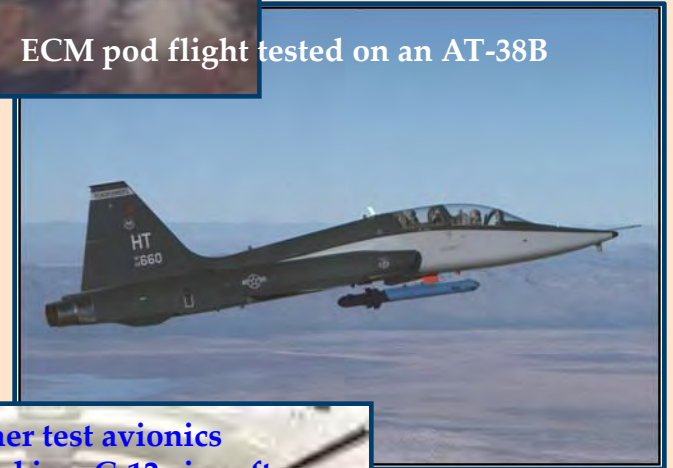

AT-38B as a photo chase



Customer test avionics mounted in a C-12 aircraft

*Army Proven
Battle Ready*

SQUADRON MISSION

- DOD's designated lead test org for GPS and GPS/INS navigation equipment
 - Operates DoD's Central Inertial Guidance Test Facility (CIGTF)
- Flight testing of GPS/INS nav systems
- GPS jamming/electronic combat testing
 - Controlled, RF-quiet open-air environment
- Inertial laboratory testing
 - Precision centrifuge; multi-axis tables
- Navigation Test & Eval Lab (NavTEL)

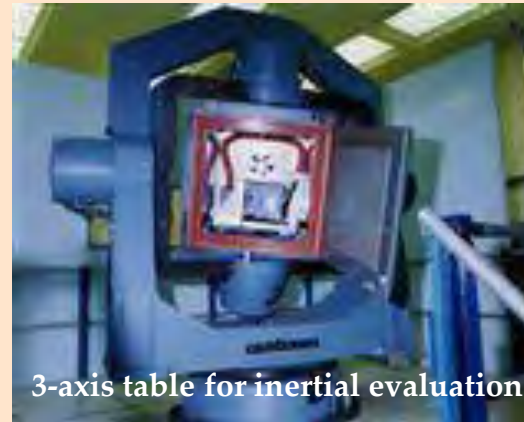

3-axis table for inertial evaluation



High-gain antenna on trailer



NavTEL facility



2-axis inertial platform with 100lb test item

*Army Proven
Battle Ready*

SQUADRON MISSION:

- Operates the High Speed Supersonic Test Track (HSSTT)
 - Lethality Testing
 - Aircrew Escape Systems
 - Guidance/Navigation Systems Test
 - Munition/Missile Performance
 - Aircraft Infrared Countermeasures



Crew escape systems testing

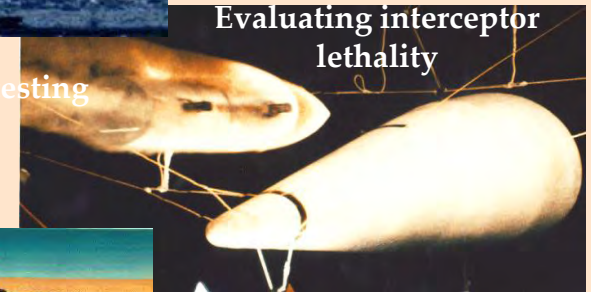

Evaluating interceptor lethality



Munition dispenser testing

Sled-mounted test item on the HSSTT



Slowing the sled at the HSSTT

Longest & most precisely aligned track in the world - 50,788 feet!

*Army Proven
Battle Ready*



DETACHMENT MISSION

- Test Sponsorship for USAF test programs at WSMR
 - Coordinating WSMR range support / documentation
 - Agent for scheduling USAF training / test missions
 - 49 FW
 - 46 TG
 - Weapons system customers



Army Proven
Battle Ready



U.S. Navy at WSMR

**Naval Surface Warfare Center, Port Hueneme Division (PHD)
White Sands Detachment**

--

Capabilities and Test Services Overview

DETACHMENT MISSION:

- Conduct land-based testing of Naval Weapon Systems, Missiles, Gun Munitions, and Directed Energy Weapons
- Conduct launch operations for sub-orbital space systems and Research Rockets
- Provide Ballistic Missile Target Systems for Fleet Testing and Training
- Coordinating WSMR range support / documentation and scheduling USN test missions

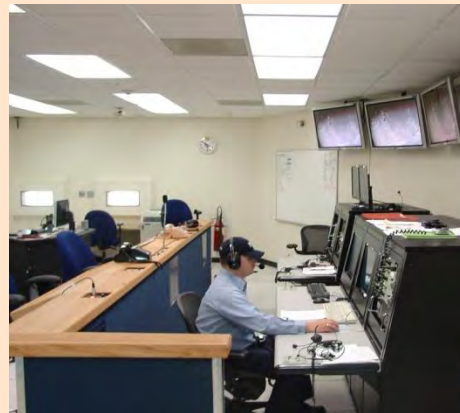
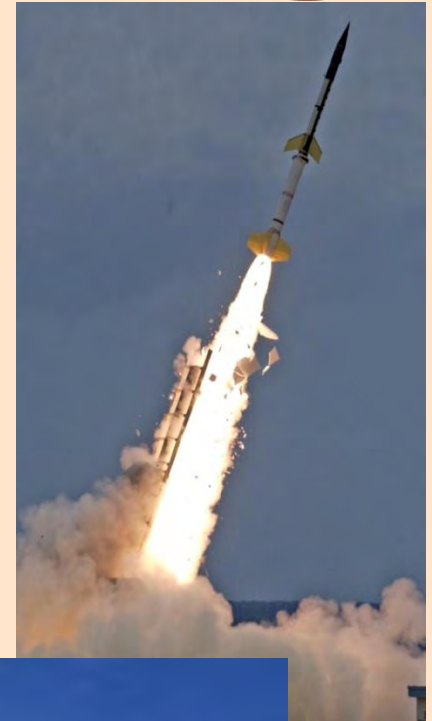

*Army Proven
Battle Ready*



Why does the Navy test over land at WSMR?

Advantages of testing over land:

- Provides a level of rigor, control and flexibility in the testing of Navy weapons that is not achievable at sea on surface combatants
- Live fire precursor to at-sea DT/OT
- High quality instrumentation & data collection of entire flight
- Recovery forensics and materials performance
- Scenario control and scheduling flexibility
- Real-time communications, display and processing flexibility/quality
- WSMR is largest DOD overland & airspace for testing Navy weapons
- Development and integration cycle (software/hardware)
- Tri-Service resources (Army, Navy, Air Force) provide a wide variety of options and opportunities for joint and stand-alone testing/training
- Wide variety of land targets available



Facilities at WSMR

- Desert Ship Complex
 - Remote Vertical Launch System (VLS) & Radar Sites
- Missile Assembly Facility (MAF)
 - 4 cells to service multiple customers
- Launch Complexes (2) – for research rockets
- Gun Firing Sites (4) – ranges up to 40 nm



U.S.S. Desert Ship



Missile Assembly Facility



Navy launch complex



Remote Navy radar site

Army Proven
Battle Ready

Navy Detachment Sites at WSMR

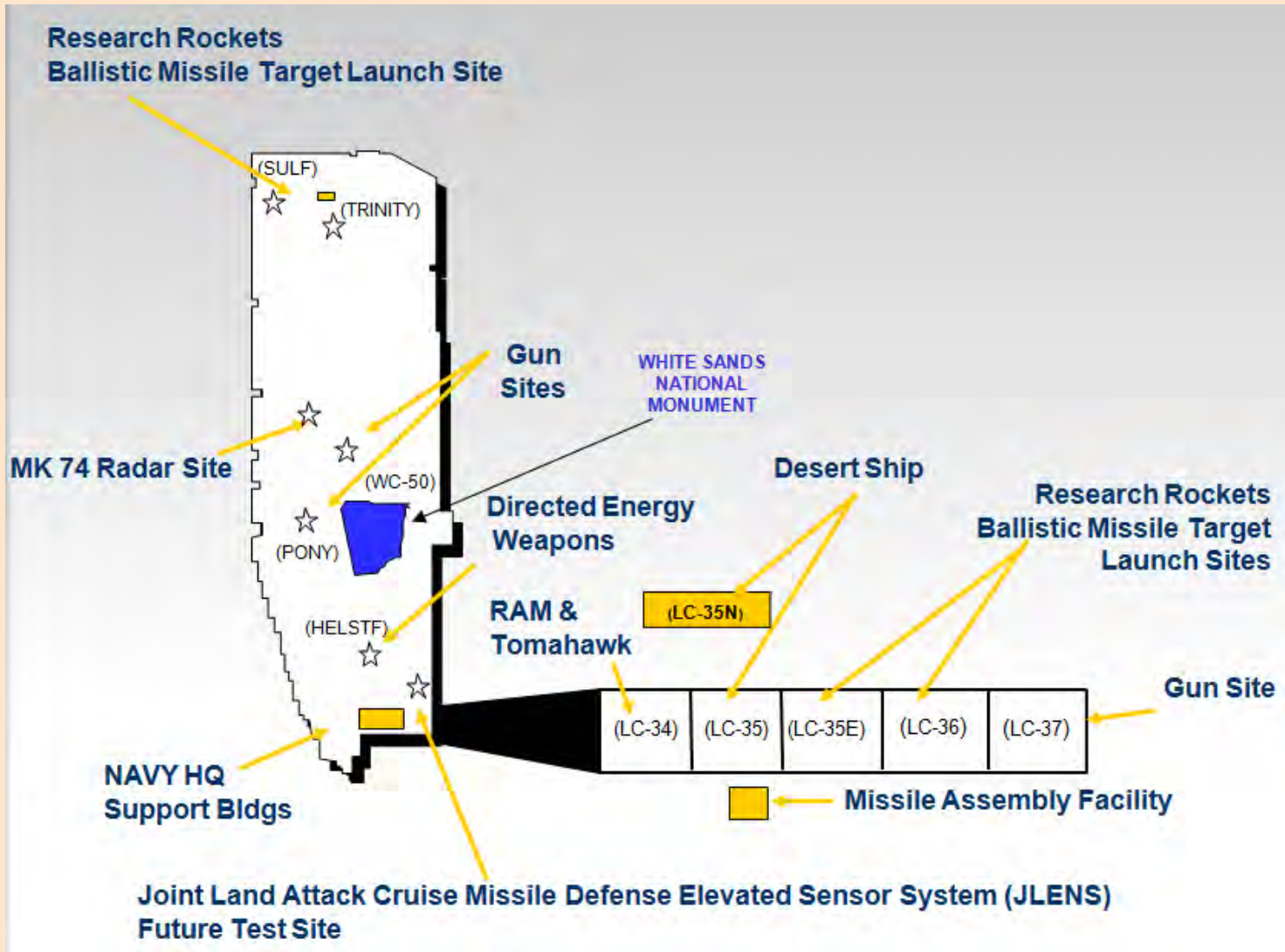

*Army Proven
Battle Ready*

Major Programs at WSMR

PROJECT

Standard Missile

ARAV (A, B, & C)

SM6

NASA Research Tests

Air Borne Laser

Advanced Guns & Munitions

Desert Ship Upgrade 2

HI-FIRE

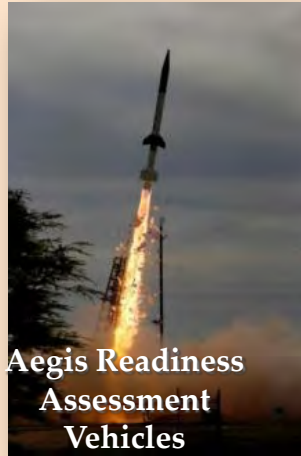

PARTNER/CUSTOMER

MDA / PD452

PEO IWS3A

NASA

MDA

PEO IWS3C

PEO IWS7

AFRL

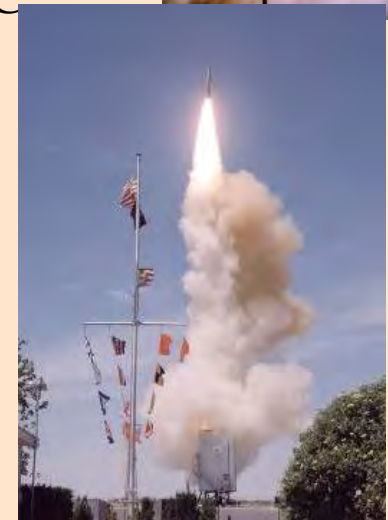

Army Proven
Battle Ready



Defense Threat Reduction Agency (DTRA) at WSMR

--

Capabilities and Test Services Overview

Defense Threat Reduction Agency (DTRA)



Mission:

- Provide end-to-end test event planning, management, safe execution and results analysis supporting DoD, Federal Agencies, and friendly nations' programs to counter proliferation of Weapons of Mass Destruction (WMDs)

Key Capabilities at WSMR:

- Unique targets and structures (joint-service, multinational)
- Tunnel tests
- Systems survivability



RDT&E Capabilities and Assets

- **Focus Areas**

- Tunnel tests
- Large-scale explosives
- Thermobaric ACTD
- Aerial deliveries



- **Test Beds**

- Capitol Peak Tunnel Site
- High Explosives (PHETS) test beds
- SHIST Sites and Alternate SHIST Sites
- Large Blast Thermal Simulator



Army Proven
Battle Ready



DTRA



Target and Structure Assets



Capitol Peak Tunnel Complex



Tomahawk



Air Force Structure 3



JDAM Hard Target Structure



Counter Terrorism Test Structure



Biological Facility Demonstration Structures



NATO Structure



JASSM Hard Target Structure



Training and Doctrine Command (TRADOC) at WSMR

--

Capabilities and Test Services Overview



Mission:

- Conduct studies that inform key decisions made by TRADOC, Army, Joint leaders
- Lead the analysis for major Army experiments
- Develop and maintain scenarios to underpin Army concepts & requirements
- Develop, configure, manage and apply verified & validated M&S
- Research, develop and share new analytical methods and modeling



TRADOC Analysis Center

RDT&E Capabilities & Assets



Key Capabilities at WSMR:

- Performance of FCS and Strategic Choices analysis for the Army
- Direct analytic support for the Future Forces Integration Directorate (FFID)
- Operational analyses for Army brigade-and-below sized units
- Development / maintenance for the Army's single approved analytic combined arms combat simulation
- Extension of test outcomes through the model-test-model paradigm → enables assessment across a wider set of conditions



Center for Countermeasures (CCM) at WSMR

--

Capabilities and Test Services Overview



Mission:

- Perform early pre-test CM assessments to support technology insertion and system development
- Determine performance and limitations of PGW systems, subsystems and related components in a CM environment
- Provide independent analysis and/or recommendations on CM/CCM effectiveness (US, allied and threats systems)
- Test CMs with emphasis on realistic environments

**CCM is a DoD agency,
under DOT&E**

Center for Counter Measures RDT&E Capabilities & Assets



JMITS – (Joint Mobile IRCM Test System)

...is a mobile, self-contained, ground-based, open-air missile simulator capable of replicating MANPADS threat signatures in both the IR and UV bands.

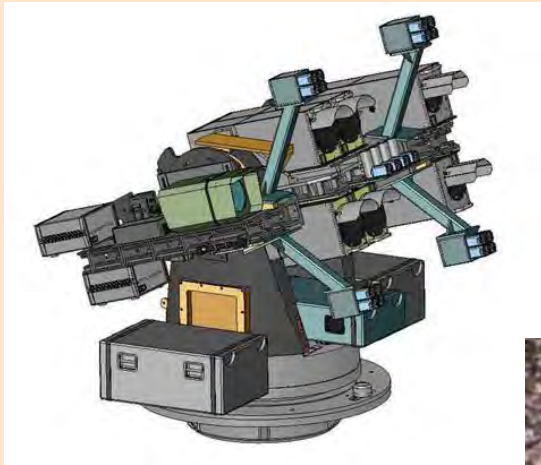

Seeker / Radiometric Van

...is a mobile system consisting of a 53-foot trailer and a Kineto Tracking Mount (KTM). This system is capable of using up to 8 IR seekers at one time, depending upon seeker configurations, to test IRCM system performance.

...coupled with this van is a radiometric suite of imagers and spectrometers, collecting signature information.



Army Proven
Battle Ready

Center for Counter Measures RDT&E Capabilities & Assets



L8A3 White Phosphorus Grenades

...used to provide IR coverage for a "valued" target.

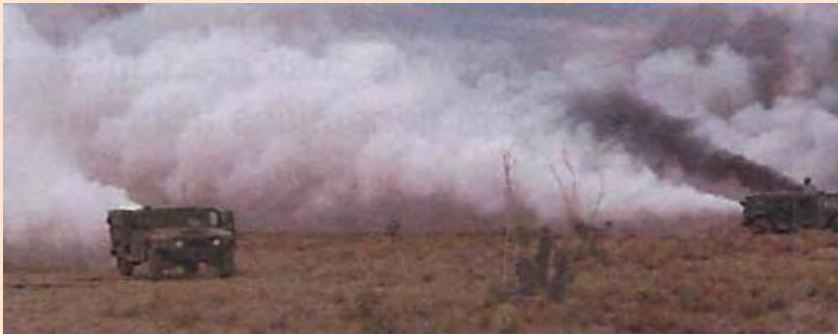

Army Proven
Battle Ready

False Target Generator

...developed by CCM, the FTG is capable of dettracting some PGMs from the intended target.



Smoke Generator "Coyotes"

...used to provide CM coverage in visible and IR bands

Examples of Past Systems Tested by CCM at WSMR

Countermeasures Systems

- HMMWV EWISSP (self-protection vs. EO PGWs and anti-tank munitions)
- CH-53 LAIRCM (test of aircraft self protection systems)



Sensors / Targeting Pods

- F-16 Litening AT Pod (signature reduction)
- AH-1Z Target Sight System (TSS)



Precision Guided Weapons

- F-16 Litening AT Pod (signature reduction)
- F-18 JSOW-A





Army Research Lab (ARL) at WSMR

--

Capabilities and Test Services Overview



Mission:

- To provide the premier source of survivability, lethality, and vulnerability expertise -- to provide experimentation, testing, and analysis throughout a system's life cycle and develop the techniques required to better understand, quantify, and enhance its survivability and lethality.
- To perform research that solves complex Army-scale atmospheric problems and results in joint weather intelligence



RDT&E Capabilities & Assets

Key Capabilities at WSMR:

- Vulnerability/Survivability assessment
- Countermeasures testing
- IR and ECM support to testing of air defense missile systems
- Development of RF and IR counter-measure models for inclusion in element/system models
- Development of next-generation mission execution forecast models, web-enables decision aids and aviation weather route planners

Information and Electronic Protection Division

- Part of ARL SLAD (Survivability/Lethality Analysis Directorate)
- **Evaluation of Countermeasure Effectiveness**
 - Airborne or ground –based jamming pods, flare dispensers, chaff, etc.
 - IEPD has over 300 EW devices for T&E of DOD weapons systems
- **Electromagnetic Vulnerability Assessment Facility (EVAF)**
 - 100-ton turntable, fume-extraction, overhead hoists
 - Two chambers: 110' x 70' x 40', 30' x 20' x 20'

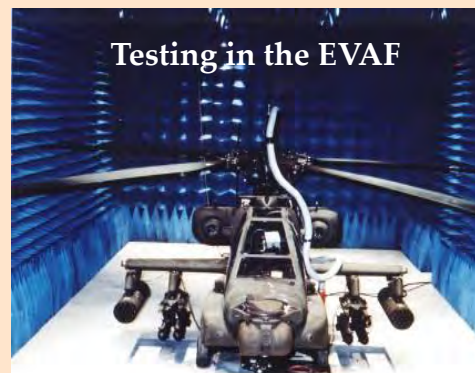

Information and Electronic Protection Division

- **Signature Measurement & Analysis**
 - Incorporation of field test data to authenticate models & simulations
- **Low energy laser vulnerability analysis for O/EO devices**
 - Ensures Army O/EO system survival in battlefield threat environment
- **Information Operations (IO) vulnerability/survivability**
 - Identifies inherent vulnerability to IO threats (EW,, computer attack, etc.)
 - Identifies weaknesses that could compromise IO (data corruption, denial of service)



IO system vulnerability assessment



O/EO vulnerability evaluation



Signature measurement & analysis

Battlefield Environment Division

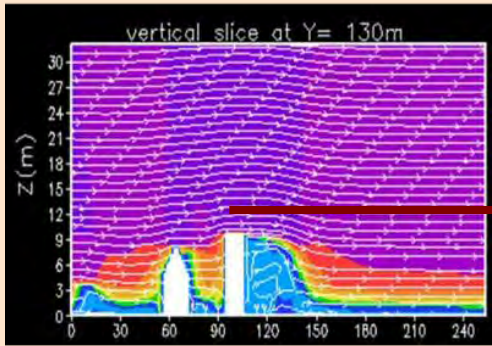

Wind Flow Experiments around Buildings at WSMR

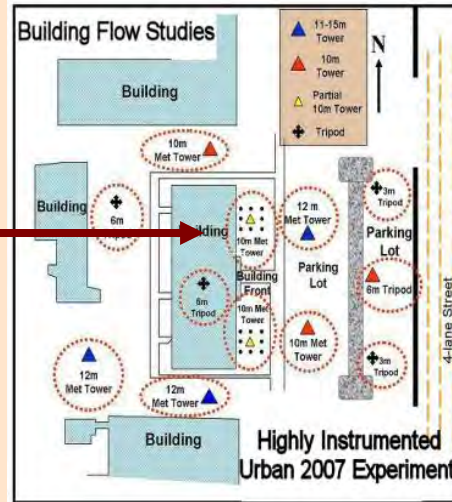

War fighter Decision Aides

Aviation Weather Routing Tool (AWRT) →

- Provides accurate weather effects information to manned/unmanned aircraft commanders
- Tactical decision aide – has an algorithm that identifies the optimum route to minimize the effect of weather on aircraft systems

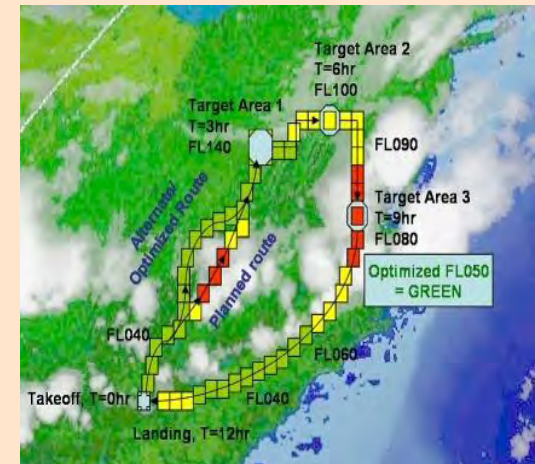



National Geospatial-Intelligence Agency (NGA) at WSMR

--

Capabilities and Test Services Overview



National Geospatial Intelligence Agency



Mission:

Provide accurate and timely expert analysis of worldwide gravity, satellite and positional information including imagery and mapping control for navigation, safety, intelligence, positioning and targeting in support of national security objectives.

Key Capabilities at WSMR:

Provide launcher azimuth verification for Missile Flight Safety Operations

Perform precise locations for test instrumentation data acquisition

Precise target and impact locations

*Army Proven
Battle Ready*



Test Measurement and Diagnostic Equipment (TMDE) at WSMR

--

Capabilities and Test Services Overview



Mission:

Provide a metrology and calibration measurement source for electrical, electromagnetic, physical, dimensional, radio frequency and nucleonics radiation measuring instrumentation

Plan and perform research, development, and related engineering efforts required to provide calibration support

Key Capabilities at WSMR:

Provides calibration and repair support (C&RS) for WSMR and all its testing activities and organizations



Mission:

The PEO-SOSI supports testing and evaluating of Brigade Combat Team (BCT) unmanned aerial and ground systems, sensors, networks, and spin-out technologies at WSMR.

Key Capabilities and Facilities at WSMR:

The Army BCT tests in a full scale, full spectrum operability and terrain environment at WSMR, which is home to the System Integration Lab, Test Complex, and test support and administrative areas for the Program Manager Lead Systems Integrator.



Network Integration Evaluation (NIE): The Army's largest and most robust network test and evaluation effort to date. A series of semi-annual events at WSMR/Ft. Bliss

NIE 11.2 conducted May 23 - July 15, 2011 → Involved T&E of **30 different systems**

NIE 12.1 will be Oct 17 – Nov 19, 2011 → Will involve T&E of **49 different systems**



- Not the typical missile, rocket, bomb testing done at WSMR
- **3300 soldiers from Fort Bliss 2nd Brigade Combat Team, 1st Armored (2/1 AD) Division**
- **1300 soldiers, government and contractor personnel** from WSMR, Fort Bliss, Fort Hood, EPG and APG and other locations are involved

PEO-SOSI Urban Test Sites



for the NIEs



17-22 single story CONEX boxes

Lee Objective
(Mountain Village 2)

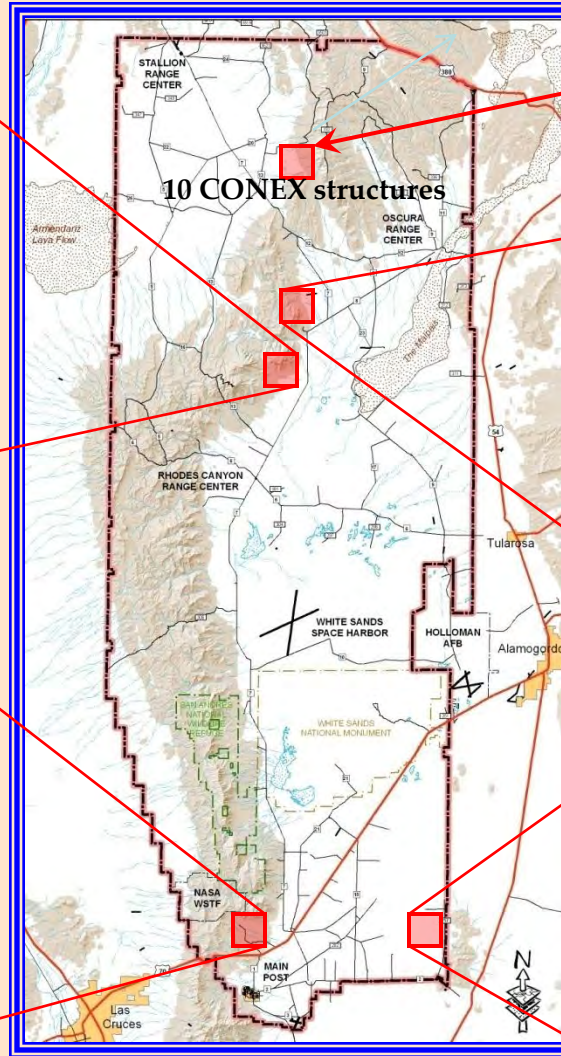

Ben Objective



20-30 wooden structures

Thurgood Objective



Mountain Village

Army Proven
Battle Ready



Yucca Village

Sample CONOPs for an NIE

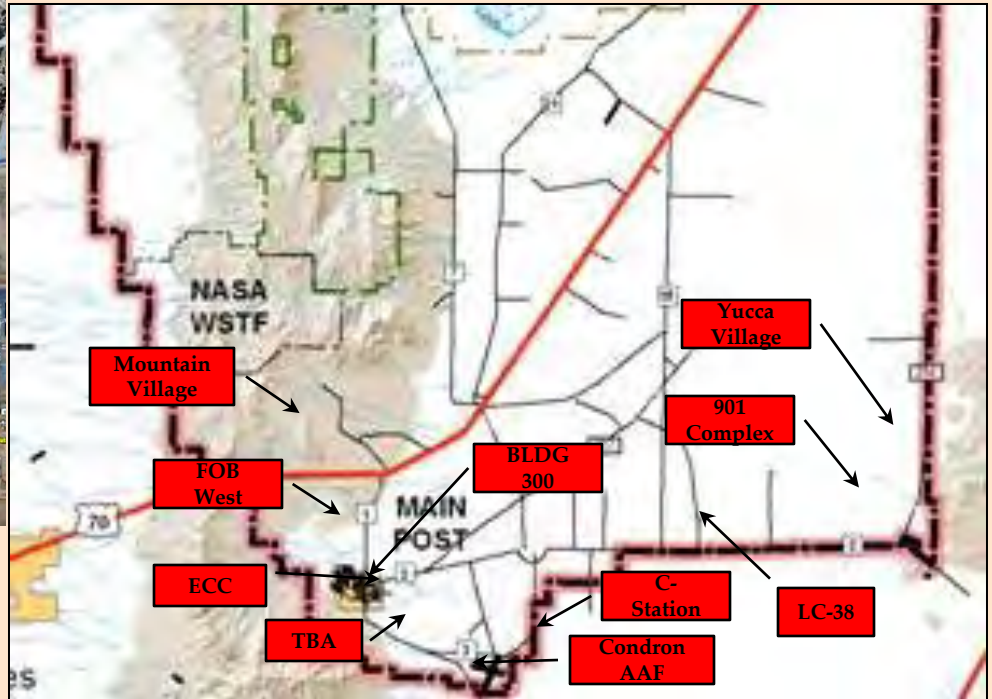
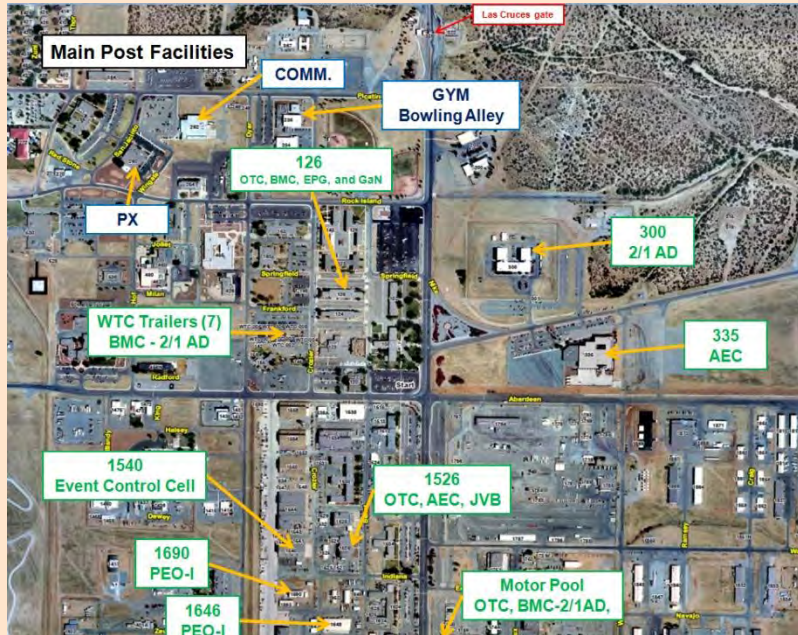

- Various ATEC, TRADOC and ASL(T) agencies will test and evaluate different systems while the soldiers of the 2nd Brigade Combat Team, 1st Armored Division use the systems in numerous tactical scenarios
- Operations take place Monday through Friday, 24 hours day

*Army Proven
Battle Ready*



Future Projected Major RDT&E Capabilities and Facilities

--

Overview

Upcoming WSTC Core Capability

--

Joint Urban Testing (JUTC)

Test Site

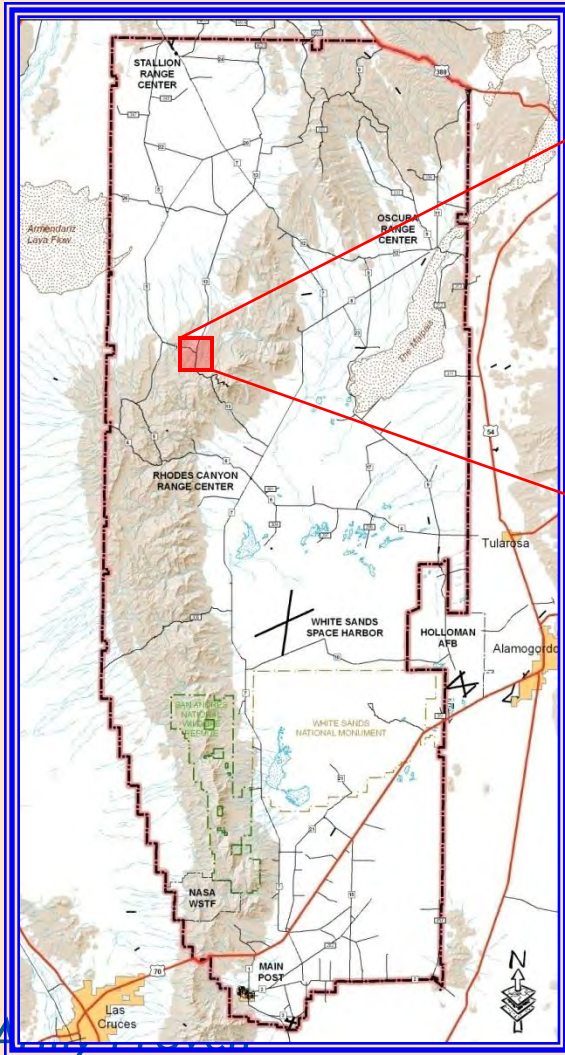

JUTC Test Site

This urban-replica test site is envisioned as a means to do C4ISR, sensor and weapon effects testing, in a realistic, reconfigurable urban setting. Special emphasis is being given to integrating the effects of EMI and “urban canyon” effects, as seen in theatre. The building are to be composed primarily of residential attached structures and commercial detached structures no taller than three stories. Currently under study, the final configuration and design of this test site is still TBD.

Notional Features and Content

- Real worldwide building materials, electromagnetic dominant factors
- Address urban canyon, closely spaced, narrow passages
- Floor to floor, building to building, interior challenges
- **Modular, reconfigurable construction**
- Stairs, curbs...
- Sub-surface sewers, utility tunnels
- **Narrow road ways, alleys, paths**
- **Multi-story buildings**
- **Overhead wires, towers**
- **Power, Coms grids (hardwire, wireless)**
- **Fences, landscaping obstacles reflectors**
- Lighting, HVAC

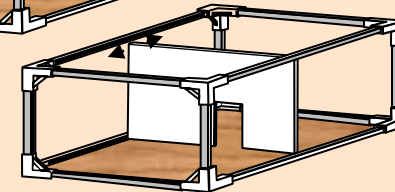
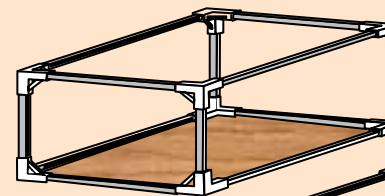
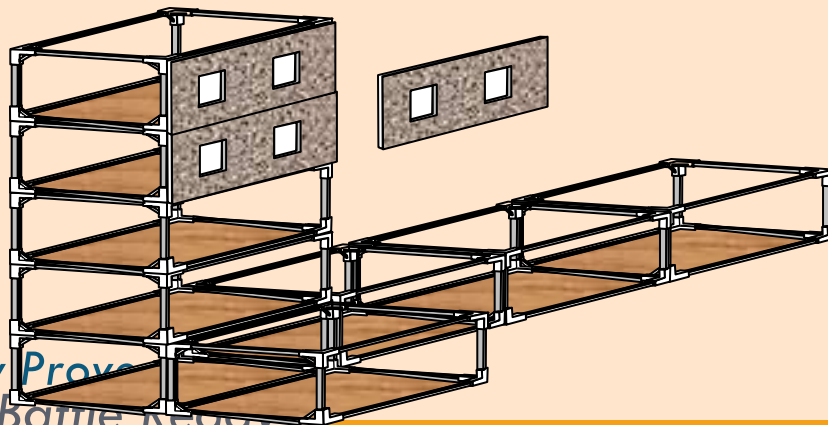

Interior walls mounted to brackets, riding in C-Channel Steel Framing



- A live physical area with reconfigurable buildings, plus roads, bridges/overpasses, tunnels, etc. representative of South West Asia, South America, Africa, Asia, etc., as required
- An Urban Electromagnetic Environment (EME) generating capability representing the theater infrastructure (cell networks, 1st responders networks, radio/TV, electrical generation/distribution, sat comms, etc.), Blue/Red/Gray force tactical equipment, and threats such as jamming.
- Augmented urban effects on systems under test
 - Obscurants,
 - Seismic,
 - Acoustic
 - Urban Clutter,
 - IR/thermal urban heat sources, etc.
- Augmented instrumentation within a generated urban environment
- Test Planning and Control, in a generated urban environment

Urban Test Sites at WSMR



JDETS



JUTC

Mountain Village



Army Proven
Battle Ready

Ben Objective

20-30 wooden
structures



Thurgood Objective

Lee Objective
(Mountain Village 2)

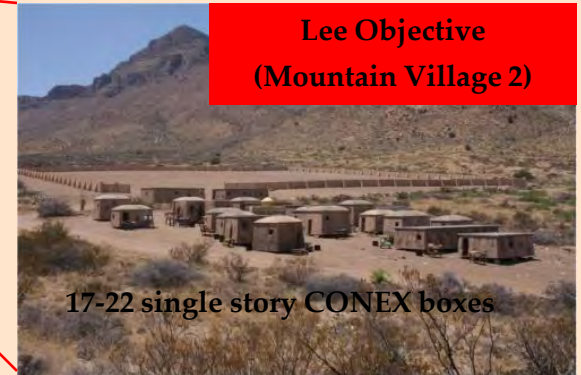

17-22 single story CONEX boxes

Yucca Village

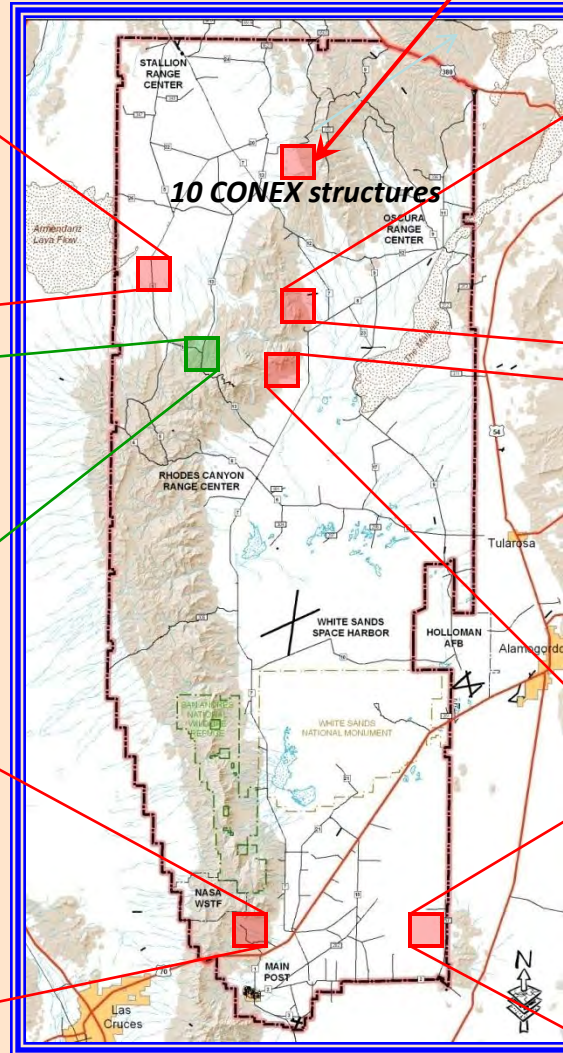



Other Unique WSMR Facilities & Sites

JLENS Test Site

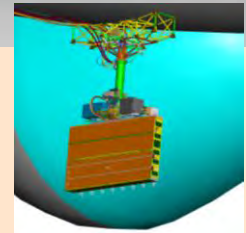
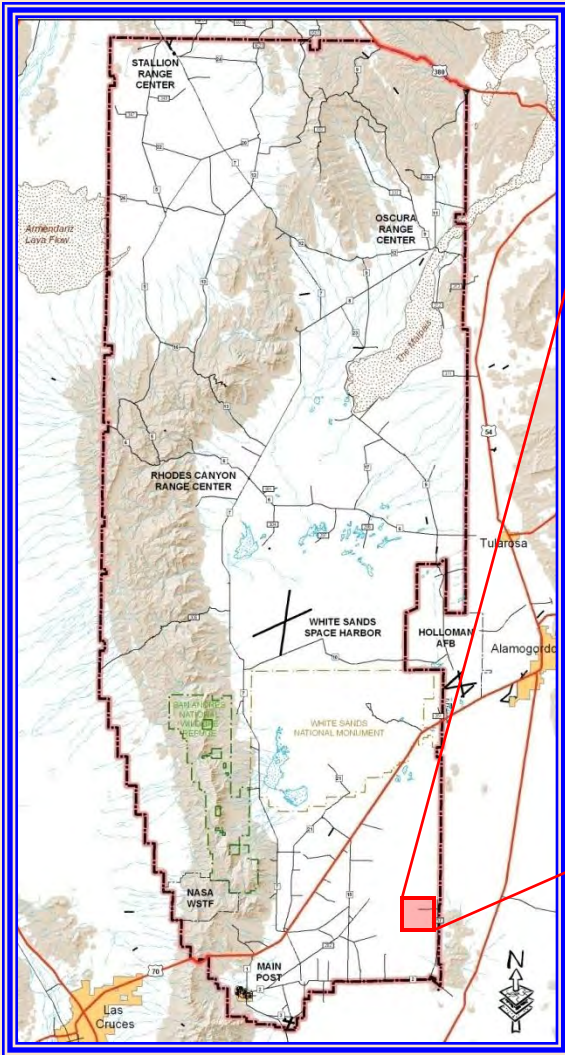

JLENS Test Site

The Joint Land Attack Cruise Missile Defense Elevated Netted Sensor (JLENS) System. The test site for this system, including a docking station for the aerostat, is located in the southeastern corner of the WSMR Range, north of Orogrande Range Camp.

Army Proven
Battle Ready

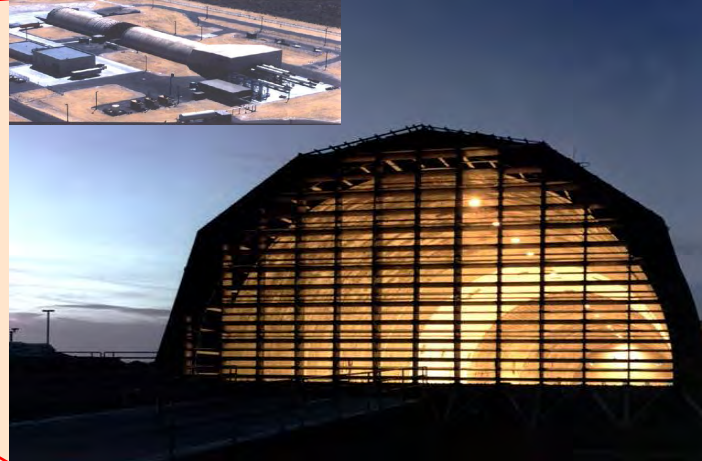
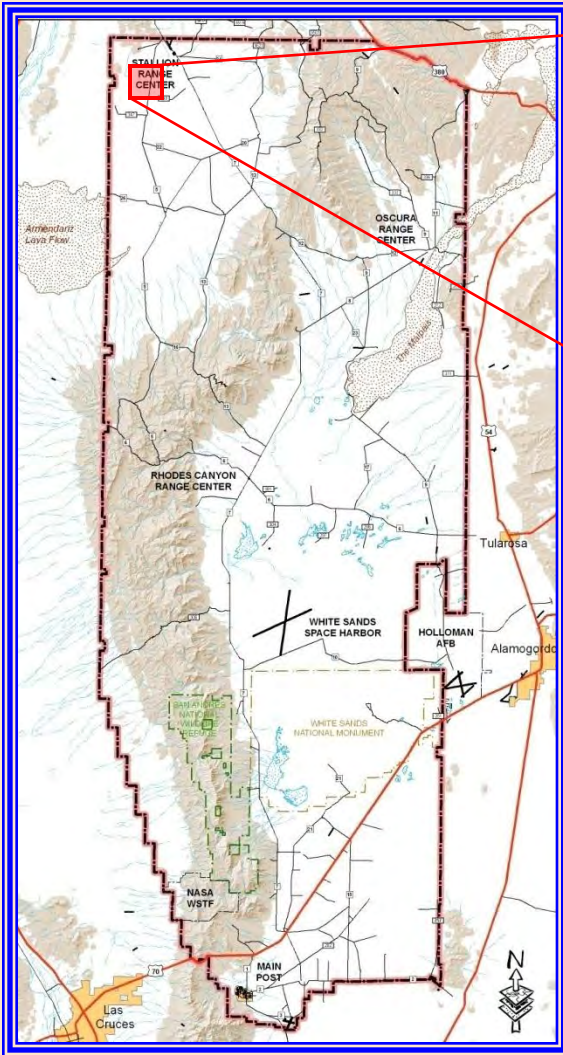

Large Blast Thermal Simulator

The Large Blast Thermal Simulator (LBTS), owned and managed by the Defense Threat Reduction Agency, is designed to simulate the thermal pulse and air blast wave from a nuclear detonation.

Customers with nuclear survivability requirement can test full scale vehicles and systems year round inside or outside the tunnel. The facility includes the capability to perform counter terrorism tests using high explosives.

The tunnel is a 170-meter long, 20-meter diameter concrete shock tube which uses heated dry nitrogen to produce a blast wave and a Thermal Radiation Source (TRS) to produce a simulated thermal pulse.

**Army Proven
Battle Ready**

Aerial Cable Range

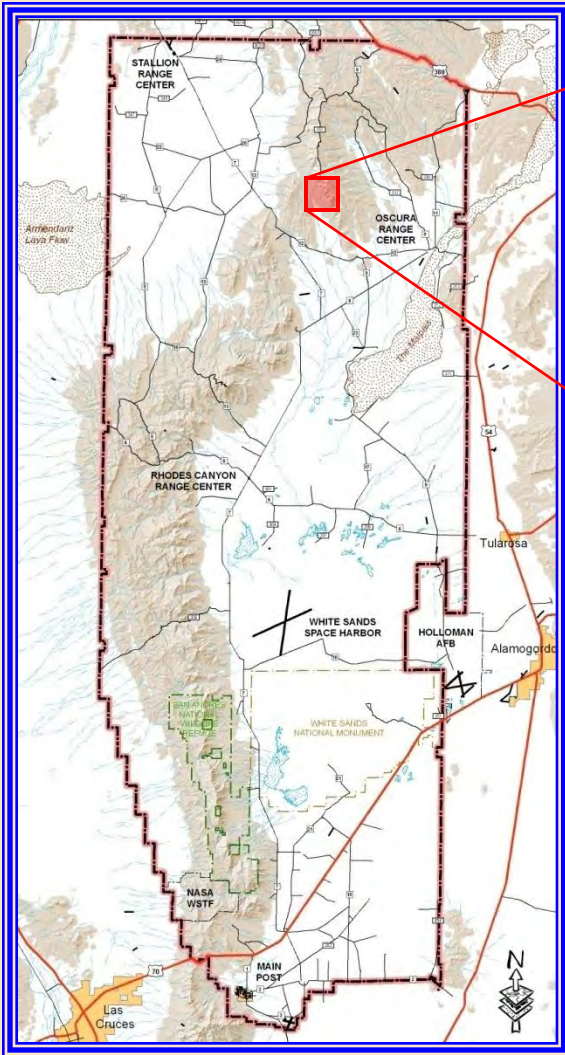

Aerial Cable Range

The Aerial Cable Range (ACR) consists of a 3 mile kevlar cable suspended between two mountain peaks used for testing missiles, sensors, airframes and countermeasures. The cable can be adjusted to suspend targets from 100 to 1,000 ft AGL, and it can accommodate payloads of up to 20K lbs. Targets can be either static or dynamic with speeds up to 250 knots.

Recently, the Department of Homeland Security has conducted countermeasures and counter-countermeasure tests on man portable air defense systems (MANPADS) for application on both civilian and military aircraft.

**Army Proven
Battle Ready**

Slick City

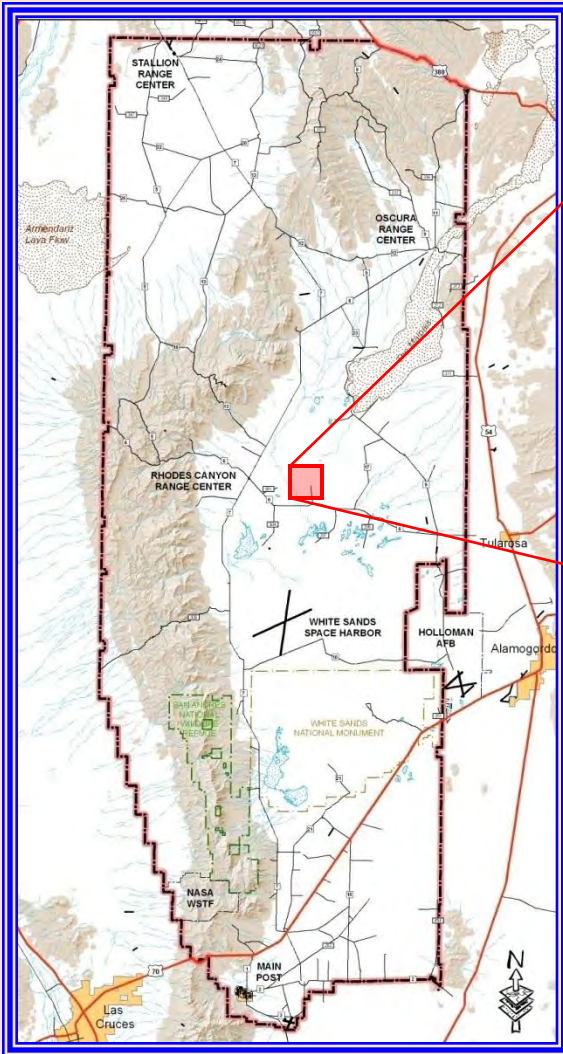

Slick City

Slick City Impact Site is an Air Force operational target area designed for use with a wide variety of air launched Precision-Guided Munitions (PGM). This site is available to air-to-surface test programs requiring a simulated depot, concrete above ground aircraft shelter and a buried command and control bunker target as well as vehicle targets of opportunity.

**Army Proven
Battle Ready**

Salinas Peak

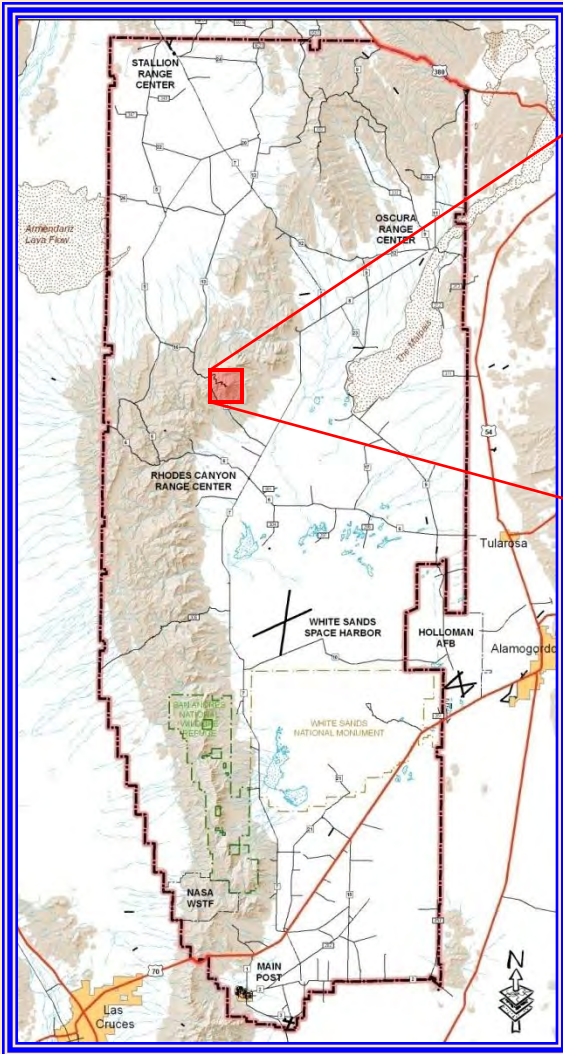

Salinas Peak

Salinas Peak has an altitude of approximately 9,000 ft MSL. Because of its mid-range location, it is one of the missile range's primary instrumentation sites.

Plus, airborne radar platforms or even satellite communications can be emulated by locating representative transmitters and receivers at this mountain peak.

**Army Proven
Battle Ready**

White Sands Space Harbor (WSSH)

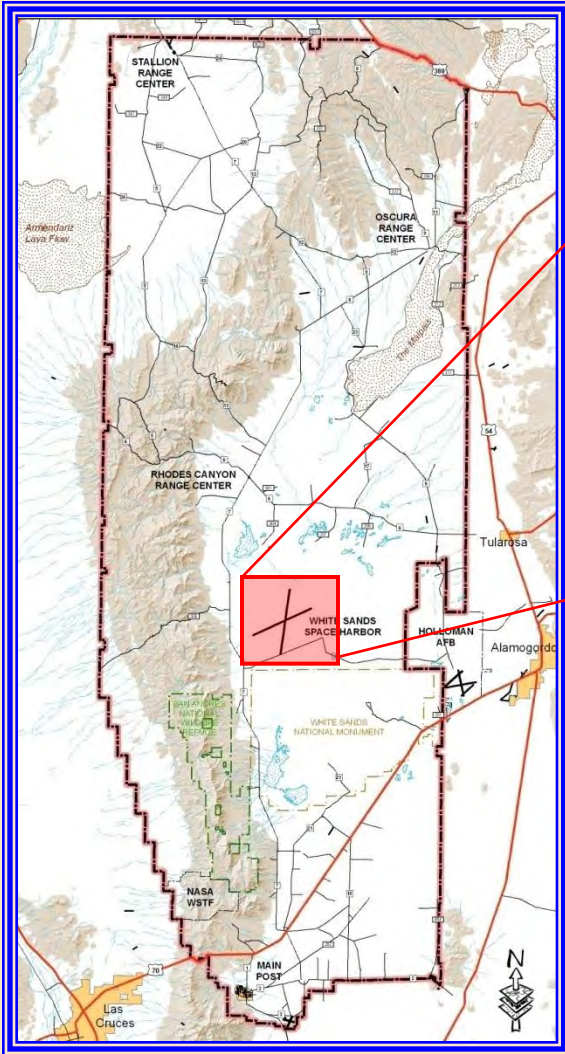

White Sands Space Harbor

White Sands Space Harbor has two strips crossing like an "X." The original and primary strip runs almost due north and south, while the secondary strip (added for shuttle program use) runs northeast/southwest. These hard packed gypsum strips are each 35,000 feet long. The strip is centered in a 100 square-mile area about 45 miles due north of WSMR Headquarters and is managed by the NASA Johnson Space Center White Sands Test Facility.

In 1982, NASA astronauts Jack R. Lousma (commander) and C. Gordon Fullerton (pilot) landed their Space Shuttle Orbiter Columbia at the WSSH.

Army Proven
Battle Ready

Red Rio Bombing Range

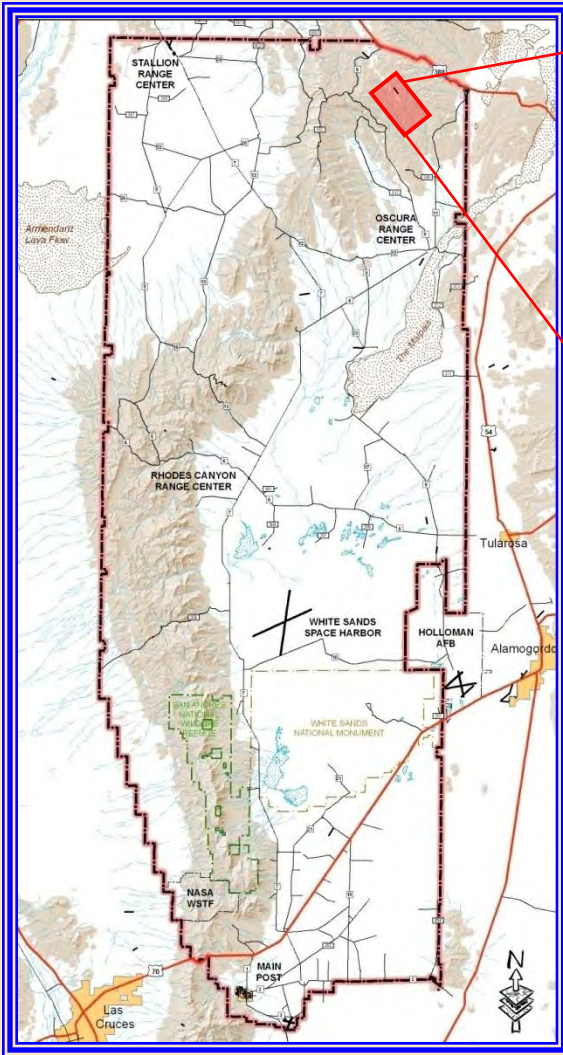

Red Rio Bombing Range

The Red Rio Bombing Range is an Air Force class "C" air-to-surface practice bombing range in the northeast corner of missile. This range is unmanned and populated with a variety of static targets arranged in convoy and depot scenarios. It supports inert bomb drops to 2000 lb and live munitions from 500 - 2000 lb. Red Rio supports several Air Force and Army units.

**Army Proven
Battle Ready**

Zumwalt Track

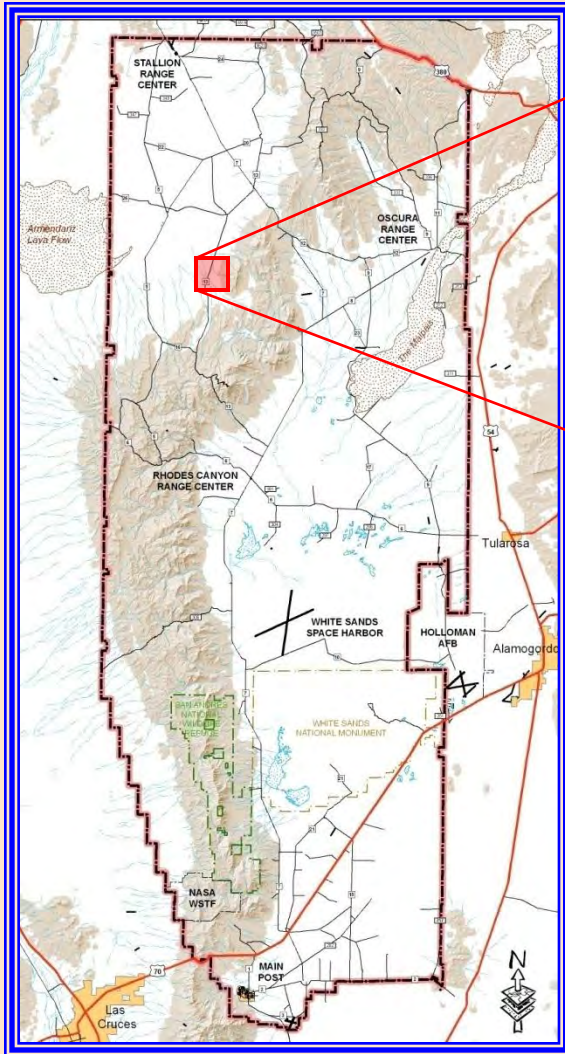

Zumwalt Track

Zumwalt Track is an 11 mile, closed-loop track including unimproved and improved road sections and a 3-mile asphalt section. The track is surrounded with many instrumentation sites including 11 state-of-the-art optic sites with fiber optic communications (secure) and firm power to collect test data.

The track is typically used to support smart munition developmental testing requiring moving, single or convoy scenario targets. Available remotely operated targets include armored personnel carriers, self-propelled howitzers, trucks, and M-60 tanks.

**Army Proven
Battle Ready**

Space Telescopes

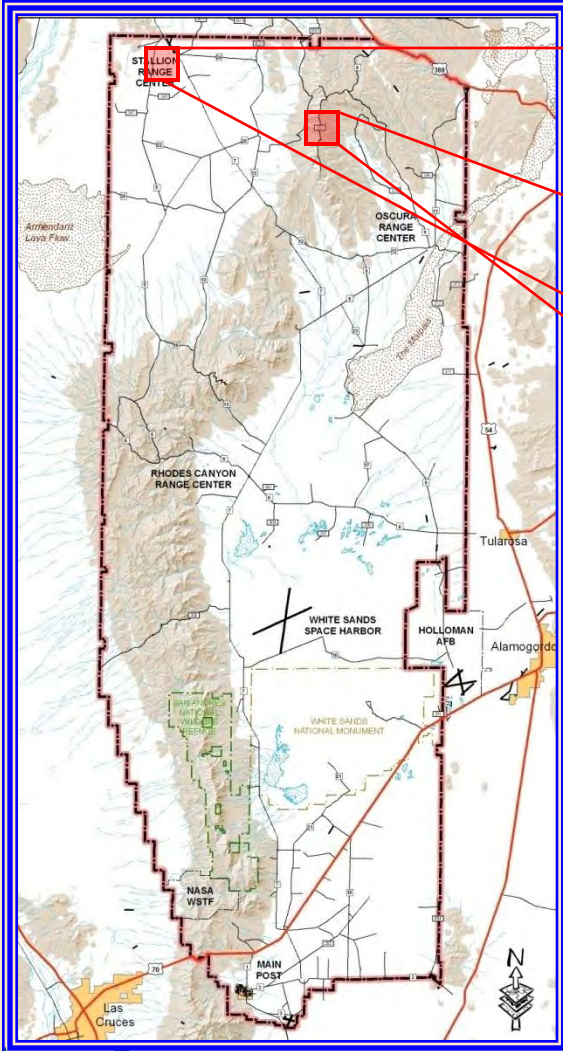

ETS and GEODSS Site One



SST Enclosure at Atom Site

GEODDS / SST / ETS

The purpose of the SST (Space Surveillance Telescope) and the ETS (Experimental Test System) / GEODDS (Ground-Based Electro-Optical Deep Space Surveillance) Site One, is to provide uncued discovery of microsatellites in deep space orbits. The SST and ETS serve as the first layer for defensive counter-space and survivability (e.g. Search → discover → track → assess)

These telescopes have 3.5m f/1.0 very wide FOV telescope, mosaic curved focal surface CCD camera.

Army Proven
Battle Ready

North Oscura Peak

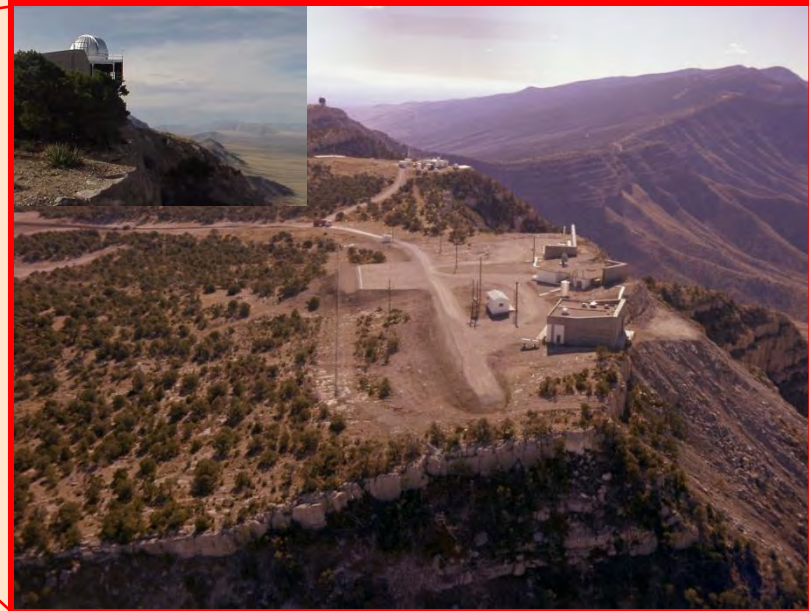
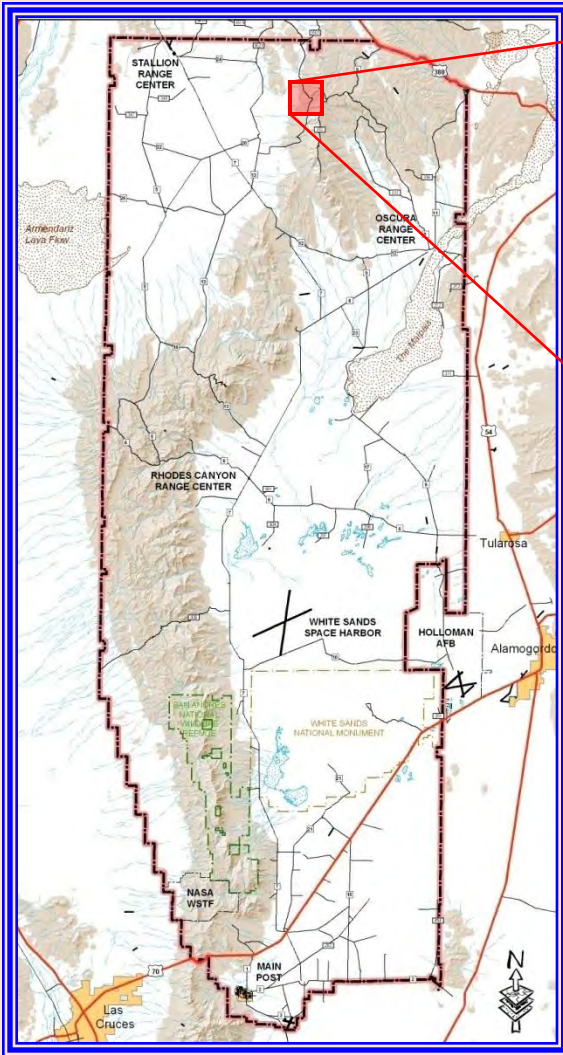

North Oscura Peak

North Oscura Peak (NOP) is a mountaintop test and instrumentation site situated at the edge of Oscura Peak and overlooking the valley 3,000 feet below.

This instrumentation site is currently utilized for several Air Force test programs, including the Airborne Laser and the Enhance Recognition and Sensing Lidar (ERASER) programs.

*Army Proven
Battle Ready*

Trinity Site

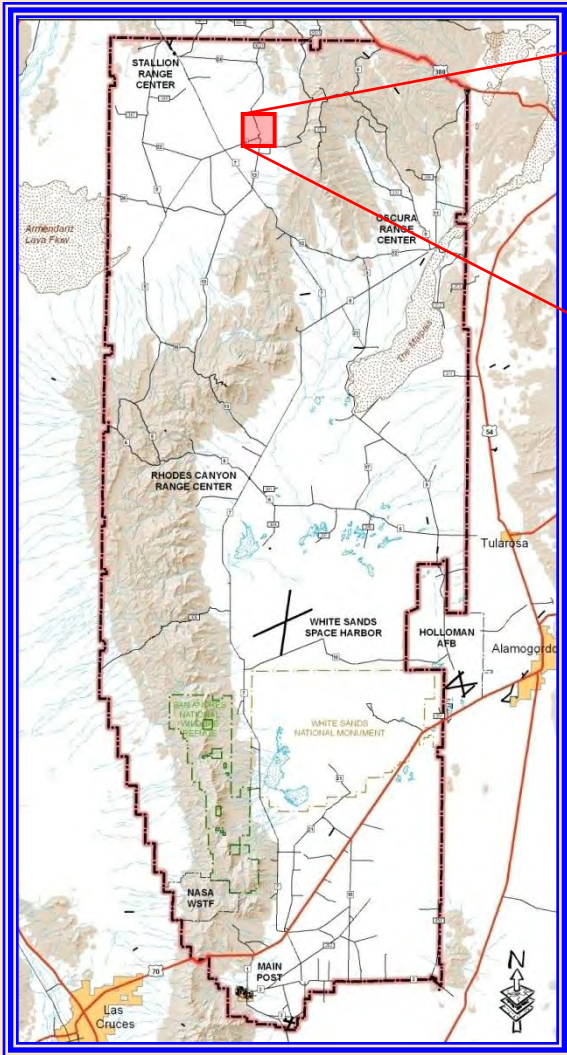

Trinity Site & McDonald Ranch House

Trinity site is where the first atomic bomb was tested at 5:29:45 a.m. Mountain War Time on July 16, 1945. The 19-kiloton explosion led to a quick end to the war in the Pacific and ushered the world into the atomic age.

The 51,500-acre area was declared a national historic landmark in 1975. The landmark includes base camp, where the scientists and support group lived; ground zero, where the bomb was placed for the explosion; and the McDonald ranch house, where the plutonium core to the bomb was assembled. The site is open to visitors twice a year on the first Saturday in April and October.

Army Proven
Battle Ready



One of the more interesting animals found on the missile range is the Oryx. This antelope is from the Kalahari region of Africa. It is a big animal, weighing between 400 and 500 pounds and is noted for its long black horns.

The animals were first introduced onto White Sands in 1969 by the New Mexico Game and Fish Department as part of its exotic game animal introduction program.

The population of Oryx on the missile range is now estimated at about 1,700 animals. Oryx have found their way off the range and can be found in Texas and on other lands surrounding the missile range.

WSMR's Relevance

Contributing to regional growth

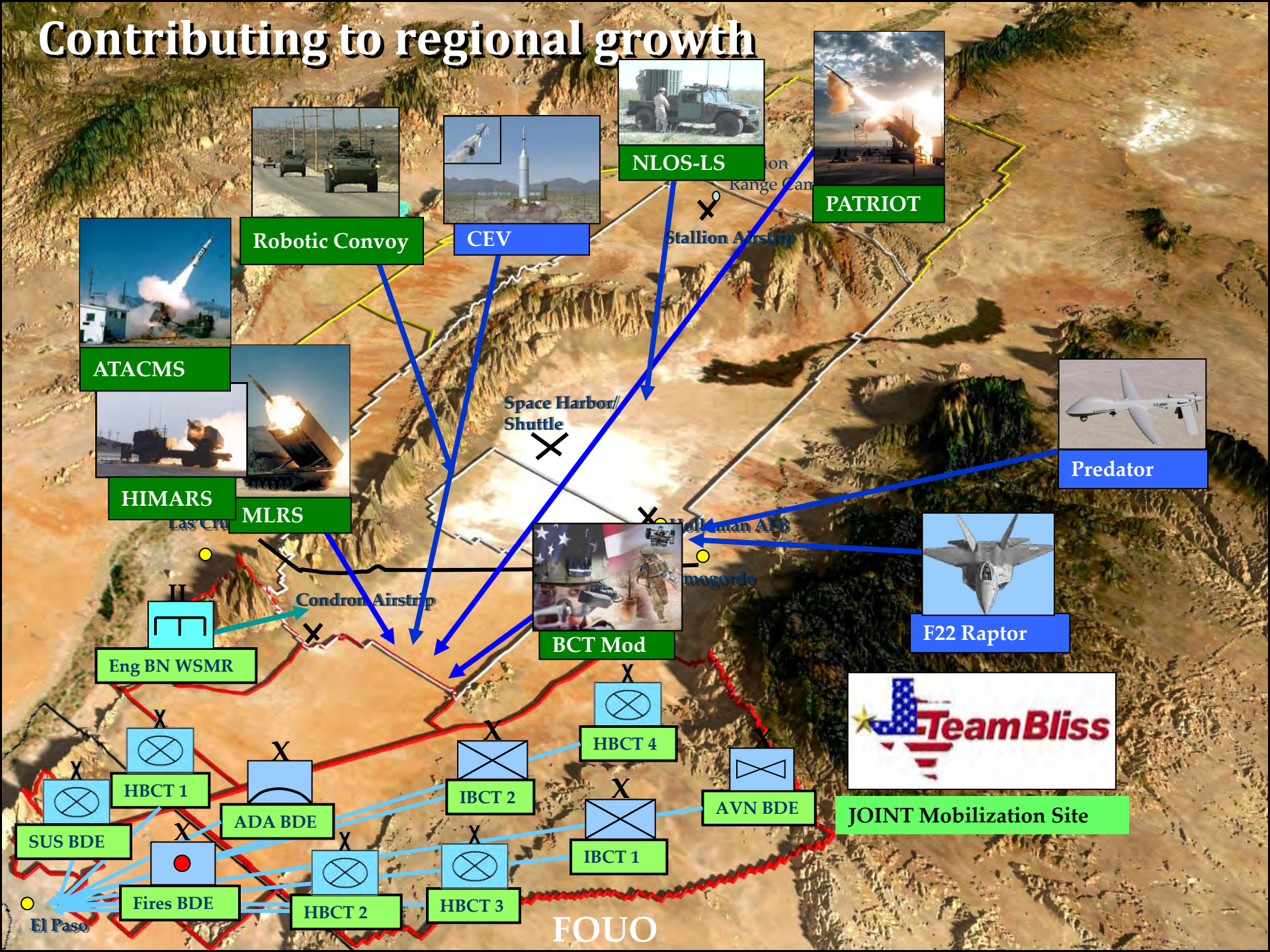



Regional Economic Impact

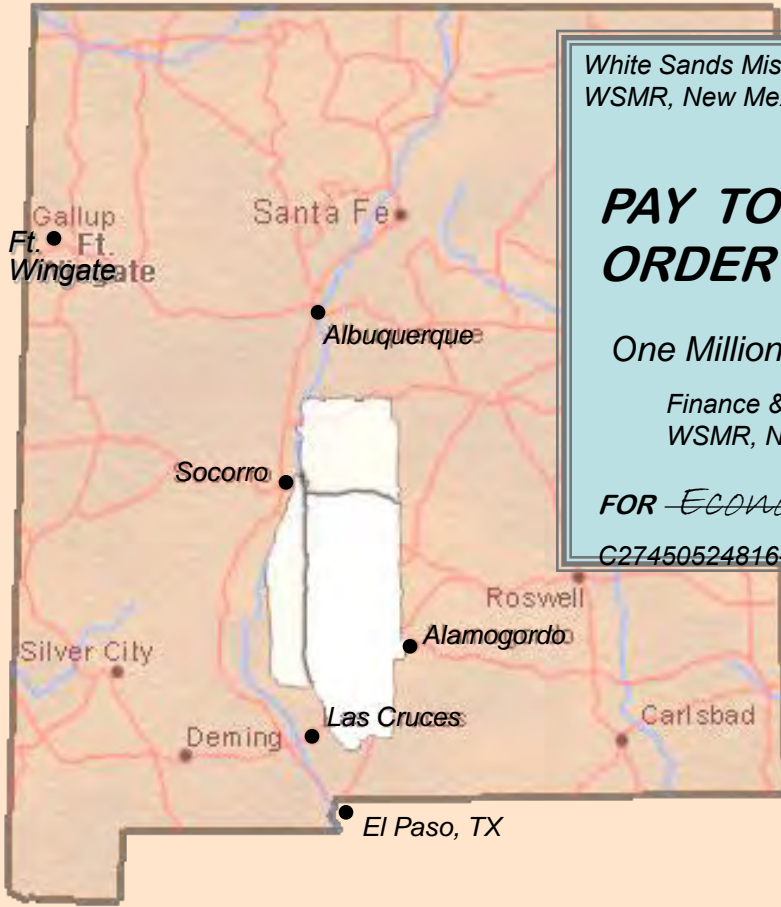

White Sands Missile Range
WSMR, New Mexico 88002

Every Day

2011

48-525/910

***PAY TO THE
ORDER OF***

Local Communities

~\$2,000,000

One Million Eight Hundred Thousand Dollars and no/100 s **DOLLARS**

*Finance & Accounting
WSMR, New Mexico 88002*

FOR Economic Impact

U.S. Government

C27450524816-9495964815"

**Army Proven
Battle Ready**

High-value Army programs choose to test at WSMR

Army Major ACAT Programs FY2011

Program	Current Estimate Billions
UH-60M Blackhawk	22
Stryker	15.5
FMTV	15.4
→ WIN-T inc 3	13.3
CH-47	12.7
Longbow Apache	11.3
AB3A remanufacture	10.4
→ Patriot PAC-3	9.5
→ JLENS	6.8
→ Patriot/MEADS missile	6.7
→ WIN-T inc 2	5.8
→ IAMD	5.3
MQ-1C UAS grey eagle	5
→ GMLRS/GMLRS AW	4.8
→ WIN-T inc 1	4.1
→ FCB2	3.6
ATIRCM/CMWS ATIRCM QRC	3.1
→ Patriot/MEADS fire unit	2.8
AB3B New Build	2.1
LUH	1.8
→ HIMARS	1.7
→ EXCALIBUR	1.6
→ Increment 1 E-IBCT	1.2
ATIRCM/CMWS	0.9

**Green =
Tested at WSMR**

**→ =
Active Program**

WSMR and the Army's Biggest Programs



WSMR Involvement

BCT Modernization	✓
Mine Resistant Ambush Protected Vehicles	✓
Abrams	✓
Patriot Advanced Capabilities, Configuration 3	✓
STRYKER	✓
JIEDDO Support	✓
Army Battle Command System	
Networks / Network Integration	✓
Bradley Fighting Vehicle Systems	✓
Terminal High Altitude Area Defense	✓
Guided Multiple Launch Rocket System	✓



BCT Modernization



PATRIOT



Joint Directed Energy Test Site IED Defeat

*Army Proven
Battle Ready*

Systems tested at WSMR have global impact



Army Proven
Battle Ready

Questions?

SLIDES

For

HYPERLINKS

Hyperlinked Slides

--

“WSMR Location” Section

RAGE (Real-Time Advanced Graphics Engine)

- Provides overall interface for remote control of battle space hardware
- Enhances test environment situational awareness for test conductor / test team



RAVE (Real-Time Augmented Video Engine)

- Provides video injection / calibration capabilities inside of RAGE
- 3-D graphic rendering of blended real time/synthetic imagery
- Image augmentation (e.g. multiple, far-flung assets, presence of obscurants, etc.)

BACK

Hyperlinked Slides

--

“WSMR Airspace” Section

WSMR / HAFB Vicinity



Regional Military Operating Areas (MOAs)

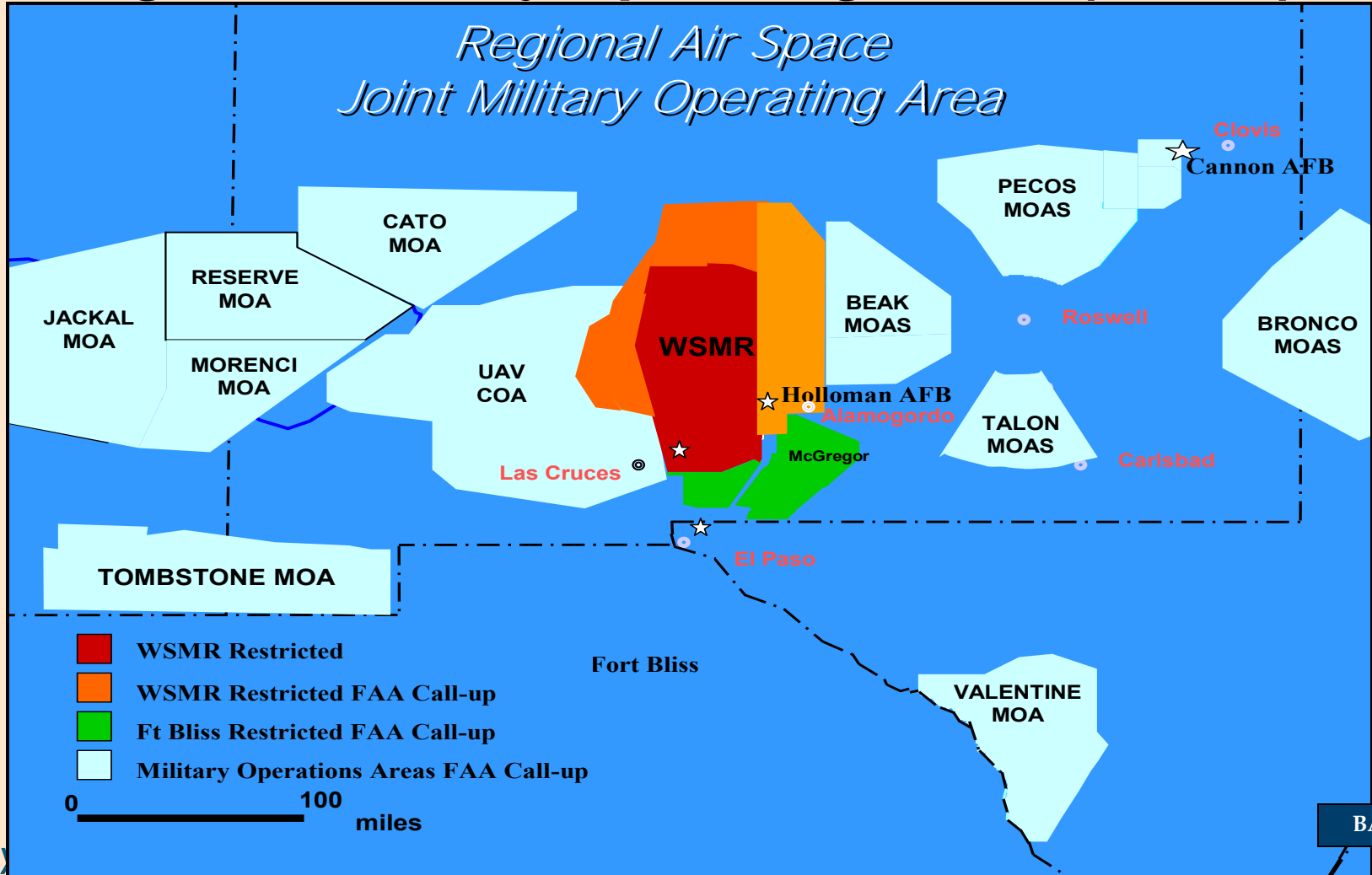

BACK

Hyperlinked Slides

--

“WSMR Org Chart” Section

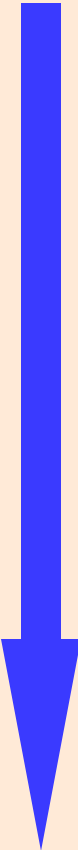

Program Priority Definitions

- 
- **PRIORITY 1:**
 - Documented Force Activity Designator (FAD) 1; GWOT; rapid deployment
 - **PRIORITY 2:**
 - Major RDT&E, full range support, multiple missions, supporting near-term milestones or acquisition decisions
 - **PRIORITY 3:**
 - Minor RDT&E, FMS, fixed or limited test windows (or campaign), full to minimal range support
 - **PRIORITY 4:**
 - Stockpile reliability, field surveillance, short duration test series, research, laboratory, full to minimal range support
 - **PRIORITY 5:**
 - Limited to minimal range support; mostly reimbursable
 - **PRIORITY 6:**
 - Minimal or no range support, training, VIP tours, hunts, environmental activities, public relations

Submittal Guidelines for

Universal Documentation System (UDS) Documents

..For a test program of this approximate size / scopethe <u>Program Introduction Document (PID)</u> should be submitted approximately this long prior to the initial test eventthe <u>Operational Requirements (OR)</u> should be submitted approximately this long prior to the initial test event ...
Small (< \$100K, minor amount of range resources)	2 months	20 working days
Medium (up to \$500K, moderate amnt of range resources)	6 months – 1 year	60 working days
Large (> \$1M, major amount of range resources)	1-2 years	90 working days

- A **single OR** could be used for either a single test event, or duplicate events requiring the same range resources...
- **“Initial test event”** = Functional Readiness Check, Hot Mission, etc.

WSMR Range Scheduling Guidelines



<p>..For a test program of this approximate size / scope...</p>	<p>...the program could be placed on the Long Term Range Forecast approximately this long prior to the initial test event...</p>	<p>.....the program will be placed on the Official Range Schedule approximately this long prior to the initial test event...</p>
<p>Small (< \$100K, minor amount of range resources)</p>	<p>2 months</p>	<p>2 weeks</p>
<p>Medium (up to \$500K, moderate amnt of range resources)</p>	<p>3 months – 6 months</p>	
<p>Large (> \$1M, major amount of range resources)</p>	<p>6 months</p>	

- **Long Term Range Forecast** = 6-month look-ahead of programs coming down the road
- **Official Range Schedule** = actually scheduled; detailed; OR required; uses Program Priority

Hyperlinked Slides

--

“WSTC Capabilities - Indirect & Attack Weapons Test” Section

Indirect & Direct Attack Weapons Testing at WSMR Example No. 1



SURFACE to AIR WEAPONS TESTING

A Patriot Advanced Capability-3 (PAC-3) missile is launched from the WSMR South Range and successfully engages a ballistic missile target.

*Army Proven
Battle Ready*

BACK

Indirect & Direct Attack Weapons Testing at WSMR Example No. 2



ARTILLERY / GUN TESTING

A **155mm Excalibur** guided artillery round is fired from a M109 Paladin at WSMR, towards a target 40 km away to assess delivery accuracy and reliability in a counter-measures environment.

Indirect & Direct Attack Weapons Testing at WSMR Example No. 3



SURFACE to SURFACE WEAPONS TESTING

A Multiple Launch Rocket System (MLRS) M26 rocket is launched at WSMR to demonstrate no degradation in capability following long term storage.

Indirect & Direct Attack Weapons Testing at WSMR Example No. 4

AIR to GROUND WEAPONS TESTING

An air-launched **Small Diameter Bomb (SDB)** destroys a target aircraft in a simulated revetment, near the Slick City target complex in the WSMR Mid-Range.



Army Proven
Battle Ready

BACK

Hyperlinked Slides

--

“WSTC Capabilities – UAV Testing” Section

UAV Testing at WSMR

Example No. 1

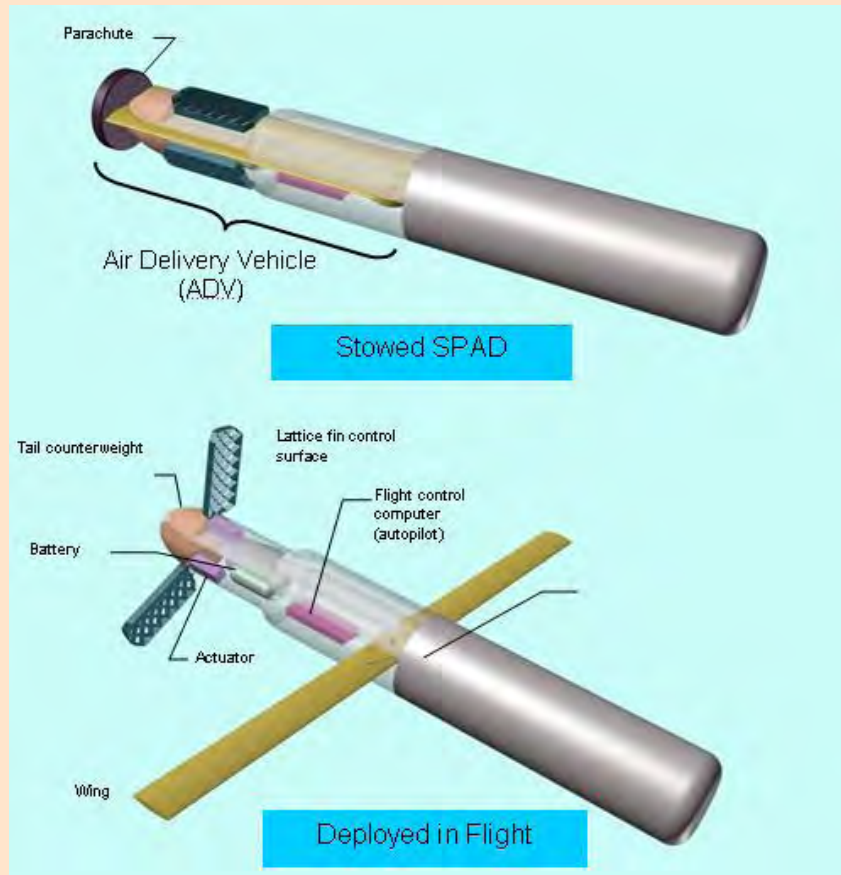

UAV FLYING QUALITIES TESTING

The Sonobuoy Precision Air Delivery (SPAD) Gliding UAV was **flight tested** during launches from a UH-1 helicopter in the WSMR North Range by Stallion Airfield.

UAV Testing at WSMR

Example No. 2



UAV SENSOR TESTING

The DARPA Heterogenous Airborne Reconnaissance Team (HART) system was a **test of UAV sensor synthesis**, during which UAV sensor data from multiple different airborne UAVs (Shadow, Hunter, Raven, Wasp, etc) was synthesized to provide real-time video and imagery data via a single ground interface.

UAV Testing at WSMR

Example No. 3



UAV WEAPONS TESTING

A Hunter UAV engages multiple moving and stationary vehicle targets with laser-seeker equipped Viper Strike Brilliant Anti-Armor (BAT) munitions during testing at WSMR's Zummwalt Track, in the WSMR North Range.

Hyperlinked Slides

--

“WSTC Capabilities – Environmental Testing” Section

Environmental Testing at WSMR Example No. 1



CLIMATICS TESTING

The USMC Expeditionary Fighting Vehicle undergoing **High Temperature / Solar Radiation testing** at the Large Temperature Test Facility (TTF)

Environmental Testing at WSMR Example No. 2



CLIMATICS TESTING

An Army Patriot Battery Command Post vehicle undergoing a **Blowing Sand and Dust test** with 2 wind machines at the outdoor test facility at ETA-I.

Only one of the two wind machines was operating, because of the orientation of the test item during this part of the test.

Environmental Testing at WSMR Example No. 3

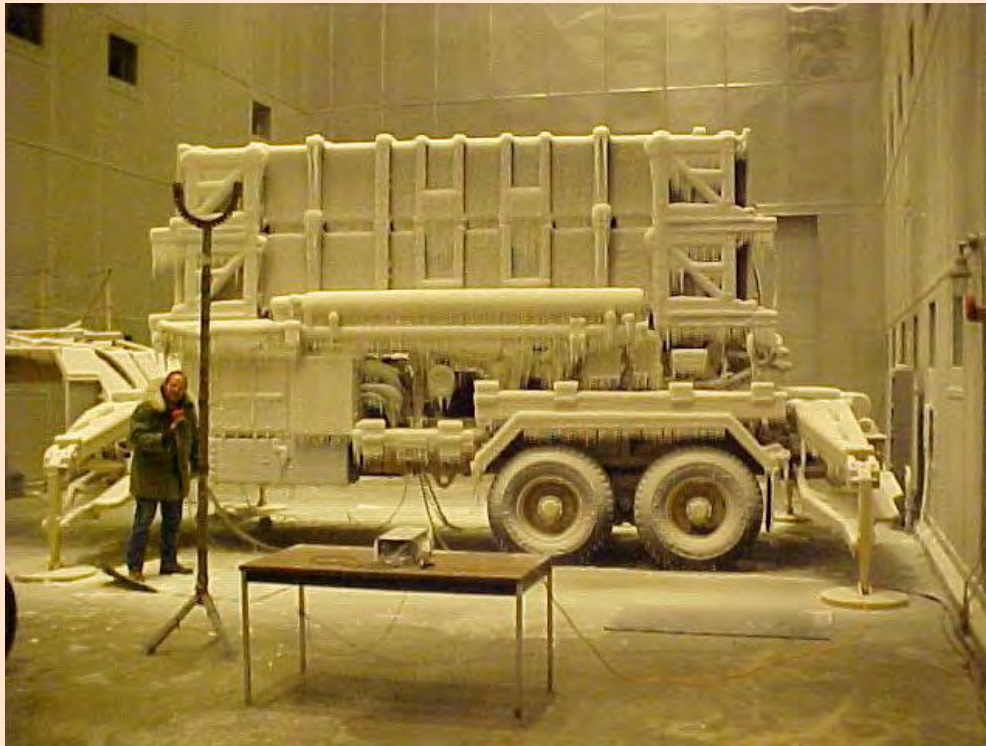

CLIMATICS TESTING

A Patriot Advanced Capability-3 (PAC-3) mobile launcher during an **icing test** at the Large Temperature Test Facility (TTF).

Environmental Testing at WSMR Example No. 4



SHOCK & VIBRATION TESTING

A Patriot Advanced Capability-3 (PAC-3) missile canister set-up for a **vibration test** at the 300K Test Facility

Two shakers were used to shake the system under test in the same direction.

Environmental Testing at WSMR

Example No. 5

RADIOGRAPHIC INSPECTION

NLOS-LS missile motor undergoing **field radiography**, using a portable 300 KV x-ray camera at the Radiation Test Facility (RTF)



Hyperlinked Slides

--

“WSTC Capabilities – E3 Testing” Section

Hyperlinked Slides

--

“WSTC Capabilities – Nuclear Effects & Characterization” Section

Hyperlinked Slides

--

“WSTC Capabilities – Instrumentation & Data Acquisition” Section

SAFARI Capability Example

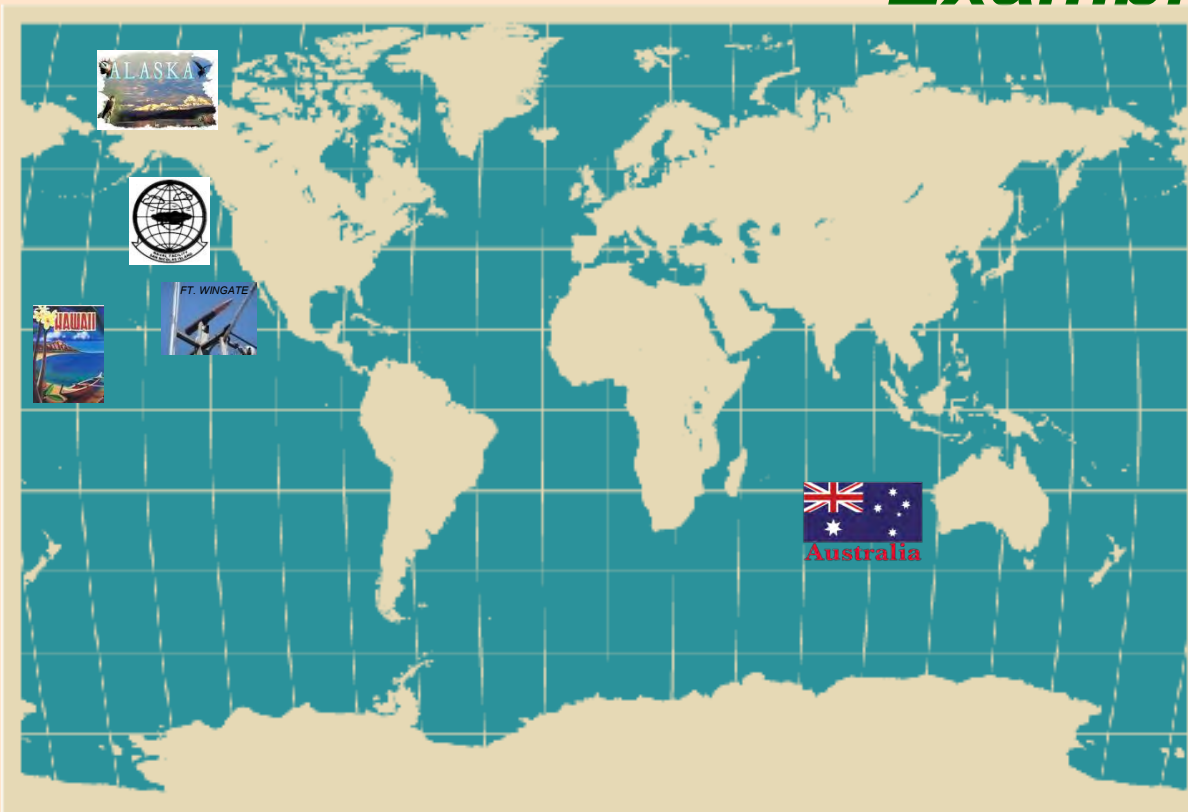

SAFARI ACTIVITY

- Australia
- Kodiak, AK
- Kauai, Hawaii
- Ft. Wingate, NM
- San Nicolas Island, CA

Hyperlinked Slides

--

“WSTC Capabilities – Complex Range Operations” Section

Hyperlinked Slides

--

“WSTC Capabilities – Distributed Testing” Section

Hyperlinked Slides

--

“WSTC Capabilities – Directed Energy Testing” Section

Hyperlinked Slides

--

“Other Team WSMR Organizations – USAF at WSMR” Section

Hyperlinked Slides

--

“Other Team WSMR Organizations – USN at WSMR” Section

Hyperlinked Slides

--

“Other Team WSMR Organizations – DTRA” Section

Hyperlinked Slides

--

“Other Team WSMR Organizations – HELSTF” Section

Hyperlinked Slides

--

“Other Team WSMR Organizations – TRADOC” Section

Hyperlinked Slides

--

“Other Team WSMR Organizations – CCM” Section

- Millimeter Wave ECM Threat Simulator (METS)
- Remote Radiometrics II vehicle
 - Remote tracking/control
 - All terrain/weather
- Suite of Countermeasures (CM)
 - Over 50 lasers for CM testing
- KTM tracking mount for live fire & aircraft tracking scenarios



METS Test Bed
(R2D2)



METS Van



Radiometrics II
Vehicle



Tracking mount
with sensors



- Digital Enhanced Seeker Van (53')
 - Remote Kineto Tracking Mount (KTM)
 - Eight Seeker Capability (Foreign & Domestic)
 - Acquires 96 analog and 256 digital signals
 - Digital Data Acquisition rate: 1.1 Mbytes/sec



Tube Mounted



Seeker Van & Tracking Mount



Mirror Mounted

*Army Proven
Battle Ready*

Hyperlinked Slides

--

“Other Team WSMR Organizations – ARL” Section

Hyperlinked Slides

--

“Other Team WSMR Organizations – NGIA” Section

Hyperlinked Slides

--

“Other Team WSMR Organizations – TMDE” Section

Hyperlinked Slides

--

“Other Team WSMR Organizations – PEO - SOSI at WSMR” Section