

Woods Hole Oceanographic Institution



Stratus 12 Twelfth Setting of the Stratus Ocean Reference Station

Cruise On Board RV *Melville* May 22 - June 4, 2012 Valparaiso, Chile - Galapagos Islands, Ecuador

by

Sebastien Bigorre,¹ Robert A. Weller,¹ Jeff Lord,¹ Nancy Galbraith,¹ Sean Whelan,¹
James Holte,¹ Ursula Cifuentes,² Eric Sanchez,² Pamela A. Labbé-Ibáñez,³ Magda Mindiola Raboya,⁴
Susan Oltman,⁵ Elsie Denton,⁶ James Shambaugh,⁷

Woods Hole Oceanographic Institution
Woods Hole, MA 02543

October 2012

Technical Report

Funding was provided by the National Oceanic and Atmospheric Administration
under Grant No. NA09OAR4320129.

Approved for public release; distribution unlimited.



Upper Ocean Processes Group
Woods Hole Oceanographic Institution
Woods Hole, MA 02543
UOP Technical Report 2012-04

- 1 Woods Hole Oceanographic Institution, Woods Hole, MA
 - 2 Universidad de Concepción, Chile
 - 3 FICOLAB, Universidad de Concepción, Chile
 - 4 National observer, Ecuador
 - 5 Teacher-At-Sea
 - 6 Volunteer
 - 7 NOAA, Volunteer
-
-

WHOI-2012-08

**Stratus 12
Twelfth Setting of the Stratus Ocean Reference Station**

by

S. Bigorre, R.A. Weller, J. Lord, N. Galbraith, S. Whelan, J. Holte, U. Cifuentes, E. Sanchez,
P.A. Labbé-Ibáñez, M. Mindiola Raboya, S. Oltman, E. Denton, J. Shambaugh.

Woods Hole Oceanographic Institution
Woods Hole, Massachusetts 02543

October 2012

Technical Report

Funding was provided by the National Oceanic and Atmospheric Administration
under Grant No. NA09OAR4320129

Reproduction in whole or in part is permitted for any purpose of the United States
Government. This report should be cited as Woods Hole Oceanographic Institution Tech.
Report., WHOI-2012-08.

Approved for public release; distribution unlimited.

Approved for Distribution:

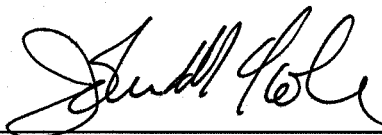

John M. Toole, Chair

Department of Physical Oceanography

Abstract

The Ocean Reference Station at 20°S, 85°W under the stratus clouds west of northern Chile is being maintained to provide ongoing climate-quality records of surface meteorology, air-sea fluxes of heat, freshwater, and momentum, and of upper ocean temperature, salinity, and velocity variability. The Stratus Ocean Reference Station (ORS Stratus) is supported by the National Oceanic and Atmospheric Administration's (NOAA) Climate Observation Program. It is recovered and redeployed annually. A NOAA vessel was not available, so this cruise was conducted on the *Melville*, operated by the Scripps Institution of Oceanography.

During the 2012 cruise on the *Melville* to the ORS Stratus site, the primary activities were the deployment of the Stratus 12 WHOI surface mooring, recovery of the previous (Stratus 11) WHOI surface mooring, in-situ calibration of the buoy meteorological sensors by comparison with instrumentation installed on the ship, and collection of underway and on station oceanographic data to continue to characterize the upper ocean in the stratus region. Underway CTD (UCTD) profiles were collected along the track. Surface drifters and subsurface floats were also launched along the track.

TABLE OF CONTENTS

Abstract	iii
Table of Contents	v-vi
List of Figures	vii-viii
List of Tables	viii
I. Introduction	1
A. Timeline	1
B. Background and Purpose	3
II. Cruise preparations	5
A. Staging and Loading in Valparaiso	5
B. Buoy Spin	6
C. Sensor Evaluation and Burn-in	7
III. Stratus 12 Mooring	14
A. Mooring Design	14
B. Buoy Instrumentation	16
1) ASIMET	16
2) Sea Surface Temperature	18
3) Air Temperature and Relative Humidity	19
4) Precipitation	19
5) Shortwave radiation	19
6) Longwave radiation	19
7) Barometric pressure	19
8) Wind	19
9) Subsurface Argos Transmitter	20
10) Telemetry	20
11) PCO ₂	20
12) Wave Package	20
13) Vaisala WXT520	21
C. Subsurface Instrumentation	21
1) VMCMs	23
2) RDI Acoustic Doppler Current profiler	23
3) Nortek	23
4) Aanderaa RCM 11s and Seaguard	23
5) SBE-39 Temperature Recorder	24
6) SBE-37 Microcat Conductivity and Temperature Recorder	24
7) Seabird 56	24
8) Seabird 16	24
9) Acoustic Release	24
D. Current Meter Setup	25
E. Antifouling Coatings	27
F. Mooring Operations	28
1) Deployment of S12 and anchor survey	28
2) Mooring deployment operations	30
G. Instrument Intercomparisons	33
1) Ship meteorological data	33
2) Intercomparison results	35
IV. Stratus 11 Mooring	40
A. Recovery	42

B.	Stratus 11 Data Return.....	43
1)	Subsurface record inventory.....	43
2)	ASIMET surface record inventory.....	49
V.	Ancillary Projects.....	53
A.	Hydrography: UCTD and CTD.....	53
1)	Operation.....	53
2)	CTD Sensor Specifications.....	54
3)	UCTD conductivity.....	55
4)	UCTD data processing.....	57
i)	Removal of outliers.....	57
ii)	Cell thermal mass.....	57
iii)	Alignment.....	57
iv)	Removal of pressure inversions.....	58
v)	Filter.....	58
vi)	Derivation.....	58
vii)	Bin average.....	58
5)	Results.....	59
B.	Ship ADCP.....	60
C.	Deployment of Argo Floats and Drifters.....	63
D.	Phytoplankton sampling and CTD.....	68
E.	Ecuadorian national observer.....	72
F.	Teacher-At-Sea.....	73
G.	Volunteer experiences.....	73
	Final notes and future recommendations.....	75
	Thanks and Acknowledgments.....	76
	References.....	76
	Appendix 1: Buoy Spins.....	77
	Appendix 2: Stratus 12 burn-in notes.....	81
	Appendix 3: Subsurface Instrument Setup (and SBE 39 ATMP).....	84
	Appendix 4: Stratus 11 Mooring Log.....	93
	Appendix 5: Stratus 12 Mooring Log.....	101

List of Figures

Fig No.	Page
1-1 Stratus 12 cruise itinerary Valparaiso - WHOI mooring – Galapagos Islands.....	2
2-1 Buoy spin of Stratus 12 buoy, in Woods Hole.....	6
2-2 Last burn-in period in Valparaiso (SWR).....	7
2-3 Last burn-in period in Valparaiso (LWR).....	8
2-4 Last burn-in period in Valparaiso (ATMP).....	8
2-5 Last burn-in period in Valparaiso (HRH).....	9
2-6 Last burn-in period in Valparaiso (WSPD).....	9
2-7 Last burn-in period in Valparaiso (WDIR).....	10
2-8 Last burn-in period in Valparaiso (Compass).....	10
2-9 Last burn-in period in Valparaiso (Wind vane).....	11
2-10 Final burn-in in Valparaiso (SST).....	11
2-11 Final burn-in in Valparaiso (COND).....	12
2-12 Final burn-in in Valparaiso (BPR).....	12
2-13 Final burn-in in Valparaiso (Precip).....	13
3-1 Representation of Stratus 9 ASIMET buoy (Stratus 12 is similar).....	14
3-2 Stratus 12 mooring diagram.....	15
3-3 Stratus 12 deployment track on May 27 2012.....	28
3-4 Stratus 12 anchor survey.....	29
3-5 Meteorological data from R/V <i>Melville</i> : ATMP, HRH, BPR, Wind, SST.....	34
3-6 Surface data from R/V <i>Melville</i> : Fluor, Precip, Salinity, Oxygen.....	35
3-7 Ship vs buoy intercomparison: ATMP, HRH, SST.....	36
3-8 Ship vs buoy intercomparison: SWR, BPR, LWR.....	37
3-9 Ship vs buoy intercomparison: Conductivity, wind east, wind north.....	38
3-10 Ship vs buoy intercomparison: HRH.....	39
4-1 Stratus 11 mooring diagram.....	40
4-2 Stratus 11 SBE 37 temperature data return.....	44
4-3 Stratus 11 SBE 37 temperature data return (deep sensors only).....	44
4-4 Stratus 11 SBE 37 salinity data return.....	45
4-5 Stratus 11 SBE 37 salinity data return (deep sensors only).....	45
4-6 Stratus 11 SBE 39 data return.....	46
4-7 VMCM data return on Stratus 11.....	46
4-8 Stratus 11 RDI ADCP velocity (U,V) data return.....	47
4-9 Seaguard velocity data return on Stratus 11.....	47
4-10 Optodes temperature data return on Stratus 11.....	48
4-11 Optodes oxygen saturation data return on Stratus 11.....	48
4-12 RCM velocity data return on Stratus 11.....	49
4-13 Stratus 11 ASIMET wind, SST, salinity and rain records on logger 4.....	50
4-14 Stratus 11 ASIMET wind, SST, salinity and rain records on logger 14.....	50
4-15 Stratus 11 ASIMET ATMP, HRH, BPR, LWR, SWR data return on logger 4.....	51
4-16 Stratus 11 ASIMET ATMP, HRH, BPR, LWR, SWR data return on logger 14.....	51
4-17 Stratus 11 air temperature and humidity record from Lascar sensor.....	52
5-1 Map of UCTD locations during Stratus 12 cruise.....	54
5-2 Conductivity, salinity and temperature from UCTD and TSG during Stratus 12.....	55
5-3 Conductivity vs salinity for UCTD and TSG.....	56
5-4 UCTD vs TSG in wet lab.....	56
5-5 Single UCTD profile with and without data processing.....	58
5-6 T-S diagram from UCTD and CTD during Stratus 12 cruise.....	59
5-7 UCTD profiles during Stratus 12 cruise, part I.....	60
5-8 UCTD profiles during Stratus 12 cruise, part II.....	60

5-9	Ship ADCP during Stratus 12 cruise.....	62
5-10	Location and time of Argo floats launches during Stratus 12 cruise	64
5-11	Typical Surface Drifter	65
5-12	Location and time of drifters launched during Stratus 12 cruise	67
5-13	CTD profile on May 23: Oxygen, fluorescence, T, S, density.....	69
5-14	CTD profile on May 26: Oxygen, fluorescence, T, S, density.....	71

List of Tables

Table No.		Page
3-1	Stratus 12 ASIMET serials/heights.....	17
3-2	Stratus 12 surface instrumentation spikes and notes.....	18
3-3	Stratus 12 Sea Surface Temperature Array	18
3-4	Set up of Stratus 12 subsurface instrumentation	22
3-5	Stratus 12 acoustic releases test on 2012/05/23	24
3-6	Setup acoustic current meters and profilers for Stratus 12.....	26
3-7	Setup acoustic current meters and profilers for Stratus 11.....	26
3-8	Stratus 12 anti-fouling application	27
5-1	Location and times of Argo floats deployments.....	63
5-2	Location and times of surface drifters deployments	66

I. Introduction

A. Timeline

The cruise began in Valparaiso, Chile, on May 22 2012, and ended in Puerto Seymour, Galapagos Islands, Ecuador, on June 4 2012. An overview of the chronology of the cruise is provided below.

May 22. Departure from Valparaiso at 16:00 local (UTC -4). WHOI floats arrived about an hour before departure. Safety and general meeting in main lab after lunch.

May 23. Sailing at 12.5 knots and COG 318°, parallel to swell. UCTD training in the morning and UCTD watches start. CTD training in the afternoon (monitor, software and rosette line handling). Exit of Chile EEZ at 1608 local time (29° 30.4'S, 75 ° 22.9'W). 2 CTD casts, one at 1500m depth with acoustic release, including stop at 500 and 1500m for communications test. Second CTD to 500m with RBR Oxygen sensors for comparisons with CTD data.

May 24. Argo float 1 and drifters 1 and 2 launched (drifters will be launched in pair during this cruise). UCTD watches continue. Test soundspeed profile from CTD as input to Multibeam. Re-enter Chile EEZ around San Felix Island at 0248 local time (28° 12'S, 76 ° 46'W). Clear sky, swell <1m, SOG 12kn. Pushed back local time one hour (UTC -5).

May 25. UCTD watches continue. Sea not as regular, SOG 11.5kn. Drifters 3+4 and 5+6. Passed over the Nazca ridge. Exit of Chile EEZ at 1318 local time (23° 21.3'S, 81 ° 50.8'W).

May 26. Pushed back local time one hour (UTC -6). UCTD watch stops. Arrive at Stratus 11 buoy site, visual inspection, communication with acoustic releases. Long line fishing boat near S11. Preparations for S12 deployment. Full depth CTD and update of sound speed into multibeam. Watches stop. Trial deployment track run during the night. Check ADCP, currents and wind. No UCTD for next few days due to long lines near Stratus buoy site.

May 27. Stratus 12 deployment. Anchor survey. Multibeam bathymetry survey begins, at 10 kn. Watches resume to check continuous multibeam data logging. Calm sea, swell only, drizzle in the morning.

May 28. Bathymetry survey continues.

May 29. Bathymetry survey ends. Back at S11 near 0400 local, bow into the wind ½ mile from S11 buoy. S11 recovery starts after breakfast. Glassballs at surface at around 0715 local. Recovery and instruments cleaning completed by 2000 local.

May 30. Bow into the wind ½ mile from S12 buoy. S11 buoy cleaning. HRH comparison between S11 primaries and S12 spare and handheld Assman psychrometer. Ship's fire drill. Deep CTD to bottom sea floor. Last visual on S12. Short bathymetry survey. Watches resume for drifters launches and UCTD, with feedback from bridge prior to deployments in case of long fishing lines in the area.

May 31. Underway to Galapagos islands, COG 345° at 11.5 knots. UCTD, drifter and float deployments continue. Swell decreases, wind around 10 knots from the east.

June 1. Underway to Galapagos islands, COG 345° at 11.5 knots. UCTD, drifter and float deployments continue. Wind around 10 knots from the east. Cloud cover thicker and more extensive. Ship's GPS recording in met data files stopped on May 30. Backed up copy of GPS from receivers in main lab. Designated individual contributions for cruise report.

June 2. UCTD, drifter and float deployments continue. Cloudy in the morning with nice stratus deck, which clears up by 1000 local. Start incorporating individual contributions into cruise report. Data dump from S11 buoy. Lost one UCTD probe. UCTD sampling ends.

June 3. Enter Ecuador EEZ at 05:00 local (4° 39.77'S, 88 ° 51.84'W).

June 4. Arrive in Puerto Seymour (Baltra island), around 0600 local. Ecuadorian officials come aboard to inspect customs and immigration papers. Divers inspect ship's hull. Science party disembarks from Melville after lunch.

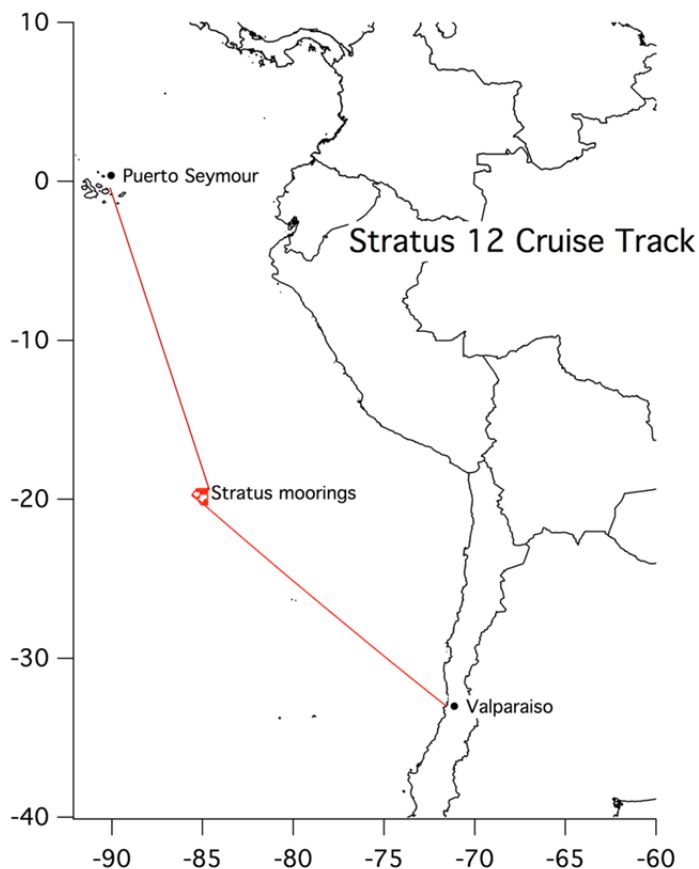

Figure 1-1. Stratus 12 cruise itinerary Valparaiso - WHOI mooring – Galapagos Islands.

B. Background and Purpose

The presence of a persistent stratus deck in the subtropical eastern Pacific is the subject of active research in atmospheric and oceanographic science. Its origin and maintenance are still open to discussion. A better understanding of the processes responsible for this system is desirable not only because better understanding of the nature of air-sea interactions in this region is needed, but also because climate models presently have SST fields that are too warm in the eastern South Pacific. There is also the need to collect in-situ data to provide ground truth for remote sensing.

The Ocean Reference Station (ORS) at 20°S, 85°W under the stratus clouds west of northern Chile is being maintained to provide ongoing, climate-quality records of surface meteorology, of air-sea fluxes of heat, freshwater, and momentum, and of upper ocean temperature, salinity, and velocity variability. The Stratus Ocean Reference Station (ORS Stratus) is supported by the National Oceanic and Atmospheric Administration's (NOAA) Climate Observation Program. It has been recovered and redeployed annually. The Stratus 11 mooring was deployed in April 2011. The new mooring was installed in May 2012 during the Stratus 12 cruise, which is detailed in this report.

During the 2012 cruise on the *Melville* to the ORS Stratus site, the primary activities were recovery of the WHOI Stratus 11 surface mooring, deployment of the new WHOI Stratus 12 surface mooring at a nearby site, and in-situ calibration of the buoy meteorological sensors by comparison with WHOI meteorological sensors mounted on the ship and between the 2 WHOI buoys while they were both deployed. CTD and underway CTD (UCTD) casts were made along the way and across an eddy, reaching depths of about 400m. Finally, surface drifters and subsurface floats were also launched during the cruise, and some chlorophyll samples were made.

The ORS Stratus buoys are equipped with two Improved Meteorological (IMET) systems, which provide surface wind speed and direction, air temperature, relative humidity, barometric pressure, incoming shortwave radiation, incoming longwave radiation, precipitation rate, and sea surface temperature. The buoy is outfitted with a PCO₂ sampling system from Chris Sabine (NOAA Pacific Marine Environmental Laboratory, PMEL). It also contains a wave measuring package designed by NDBC. The IMET data are made available in near real time using satellite telemetry. The mooring line carries instruments to measure ocean salinity, dissolved oxygen, temperature, and currents.

In preparation for the cruise, Scripps Institution of Oceanography (SIO) had applied for clearance to sample in Chilean waters (Figure 1-1). Clearance was obtained to sample the upper 500m of the ocean in Chilean waters using the UCTD. Clearance was also obtained for sampling in Ecuadorian waters as well, although no physical sample was allowed in the Galapagos Marine Reserve (digital data only). There was some uncertainty about the final destination, since very constraining rules apply to ships entering the Galapagos Islands and an alternative of Manta, continental Ecuador was considered. The rules mentioned above for example mandated that the ship be fumigated while docked in Valparaiso. We also learned on our way to the Galapagos that an inspection would be carried out in Baltra, including an evaluation of the ship's hull using

divers. These late changes meant that sailing time would be lost, but also additional fees incurred. Despite all these uncertainties, Robert Weller designed the cruise plan in advance, which was respected quite closely. The cruise plan consisted in surveying the upper ocean properties while on way to the Stratus buoy sites for the deployment of Stratus 12, recovery of Stratus 11 and comparison of telemetered data from newly deployed WHOI instrumentation with measurements made on the ship. Bottom bathymetry surveys were also planned in the WHOI Stratus buoy area using the ship's multibeam echosounder. Following the mooring operations, UCTD casts were planned for the end of the trip, en route to the Galapagos Islands. Float and drifters launches were also planned along the cruise track.

II. Cruise Preparations

A. Staging and Loading in Valparaiso

On April 2 2012, two forty-foot containers and two 20-foot containers, loaded with the buoy, mooring components and cruise support gear, were shipped from Woods Hole, Massachusetts to Valparaiso, Chile, in preparation for the Stratus 12 cruise. Arrangements were made with AJ Broom, our agent in Chile, to accept the equipment and provide support for WHOI. This support included a staging area, forklift support, shore crane, and port access. Three WHOI personnel traveled to Valparaiso on May 12, arriving in the afternoon of May 13.

On the morning of May 14, WHOI personnel traveled to Valparaiso to meet with the port Agent (AJ Broom), and begin preparations for the cruise. The containers were delivered to a staging area at 10:30 am, and a forklift was available to assist with the unloading of containers. The buoy tower top and hull were assembled with the forklift. The anchor modules were also assembled using the forklift. Some equipment was shuffled back into the containers. One container was set up with tables and chairs to serve as a lab space for preparations.

Additional WHOI personnel arrived on May 16. Buoy assembly and test, and equipment preparation continued. The pCO₂ system was installed and checked and a final buoy spin was done. The buoy ASIMET data was transmitted through Argos telemetry. This data was then evaluated a few days later, before departure, to ensure sensors performed adequately. Particular focus was given to wind direction since heavy port traffic near the buoy staging area had made the compass readings of the wind sensors very noisy during the buoy spin. These preparations continued until the arrival of the R/V *Melville* on May 18. On May 19, forklifts and a shore crane were used to get the WHOI gear moved and loaded onto the ship. The buoy hull and well assembly were mated, as they were loaded onto the ship's deck. The outgoing science party was gracious enough to let us load some of our equipment while they were still onboard.

One person from Scripps joined us while we were in port to set up Argo floats that were to be loaded on the *Melville*. One volunteer (E. Denton) and the Teacher-At-Sea joined us and helped with preparations. May 20-22 were used to get the main lab organized and the deck setup and lashed. Cruise personnel set up the local Argos receiver, GPS stations, and the WHOI flux system on the bow mast. The ships' engineers wired connectors onto the capstan and pressure washer, and welded extra lashing points for the anchor.

Two Chilean students and one observer and the Ecuadorian observer completed the science party on May 22, including the national observer. A second batch of Argo floats (from WHOI; to be deployed on the next scientific leg, out of the Galapagos) arrived at 15:00 local on May 22. The *Melville* left Valparaiso at 16:00 local on May 22.

B. Buoy spin

Buoy spins were conducted and were found to meet expectations. The buoy spin is a procedure to check the compasses on the buoy. This procedure uses a portable differential GPS monitor, which indicates the direction of true North. There is therefore no need to lock the wind vanes to a reference direction (identified by a distant landmark), but rather the vanes are locked once with respect to the buoy. The buoy is rotated in 8 different directions, with 45° increments. At each of these directions the compass from the wind sensors is read and compared with the GPS value. Once the local value of the magnetic deviation is taken into account, the difference indicates an estimate of the compass error, which is reported. Typically, compasses used for ASIMET sensors have an error less than 5°. Part of this error is probably due to soft iron effects from the metallic structure of the buoy tower itself. A first buoy spin was made in Woods Hole. Buoy spin in Valparaiso proved difficult to do due to heavy traffic of metallic materials inside the port, near the buoy. Results of buoy spin in Woods Hole are shown in Figure 2.1, where compass error is plotted as a function of buoy orientation and the sinusoidal curve is symptomatic of the buoy spin procedure. See Appendix 1 for the details of the buoy spin.

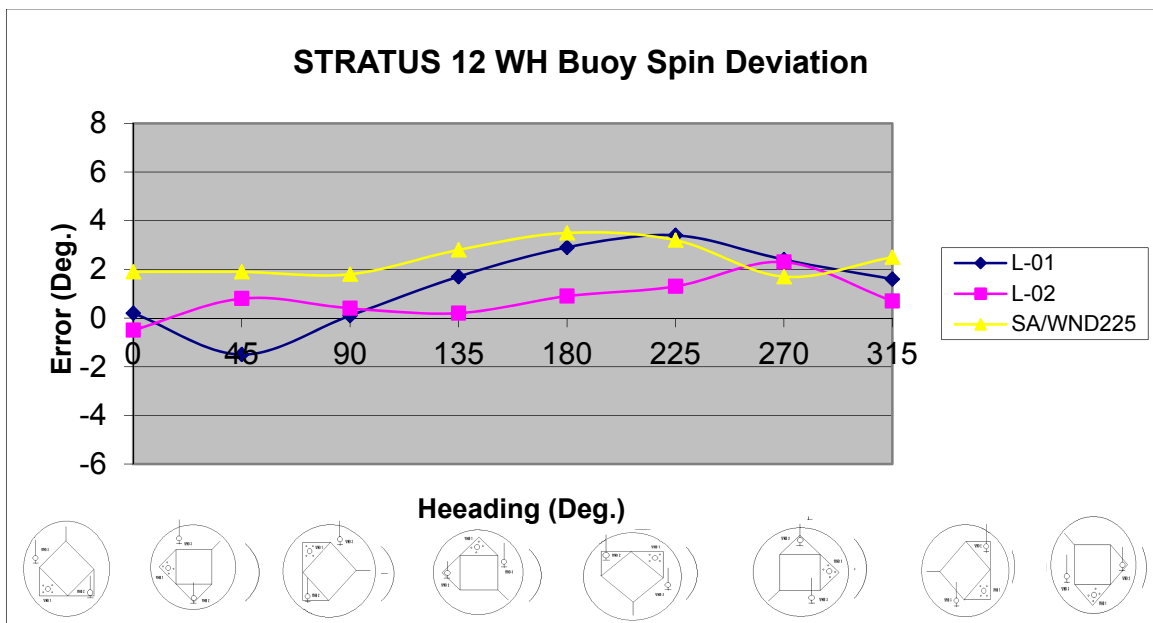

Figure 2.1. Buoy spin of Stratus 12 buoy, in Woods Hole.

C. Sensor Evaluation and Burn-in

Testing (burn-in) for the ASIMET units deployed on the Stratus 12 buoy began at the Woods Hole Oceanographic Institution on Feb 24 2012, when the primary loggers SN L-01 and L-02 were powered up and populated with barometric pressure (BPR), sea surface temperature (SST) and shortwave (SWR) instruments. On March 9 2012, a spare system (logger 17) was added. Data was evaluated on March 19 and 29 at WHOI and one last time on May 16 in Valparaiso while the buoy was on the dock. Plots from this last evaluation are shown below and cover the period May 14 18:00 to May 16 18:00 UTC. The lower panel in these plots (figures 2-2 to 2-13) is the difference between hourly averaged data from logger 1 and 2, which helps identify biases. Typically, biases increase near local noon (about 18:00 UTC) when shading from buoy tower and low wind create a different solar heating from one sensor to the other. Notes describing burn-in events are shown in Appendix 2.

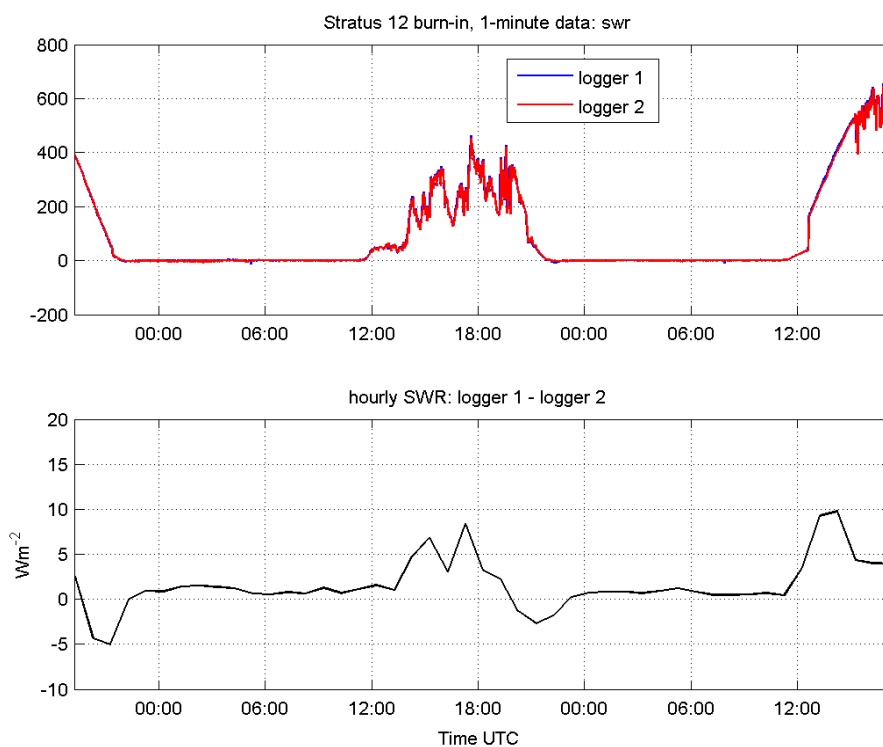

Figure 2-2. Last S12 burn-in period in Valparaiso when S12 buoy was on the dock in port. Upper panel shows time-series from 1-minute downward shortwave solar radiation (SWR) data, in Wm^{-2} . Lower panel shows the difference between sensors, averaged over one hour.

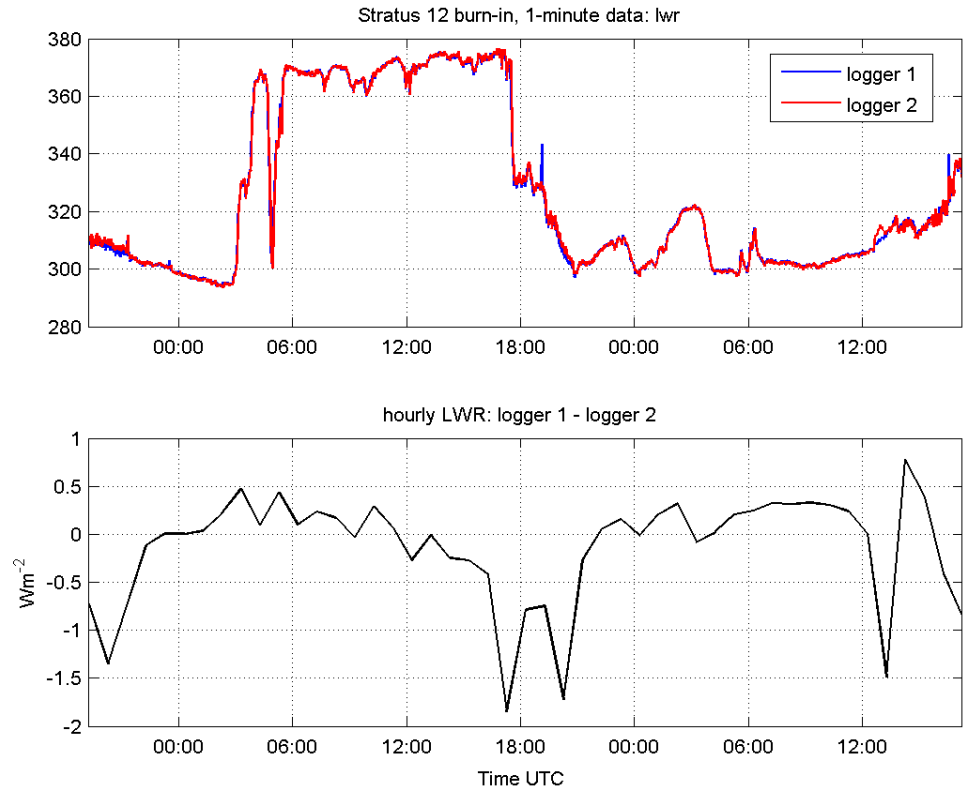

Figure 2-3. Same as Fig. 2-2, but for downward longwave radiation (LWR), in Wm^{-2} .

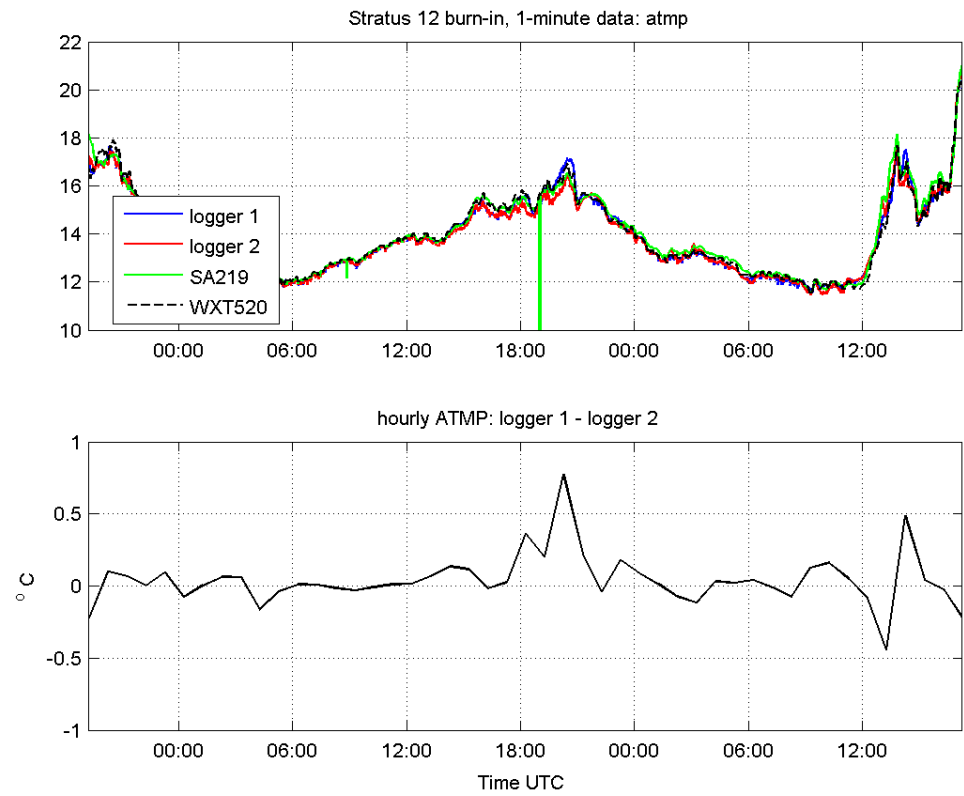

Figure 2-4. Same as Fig. 2-2, but for air temperature (ATMP), in $\text{deg } ^\circ\text{C}$.

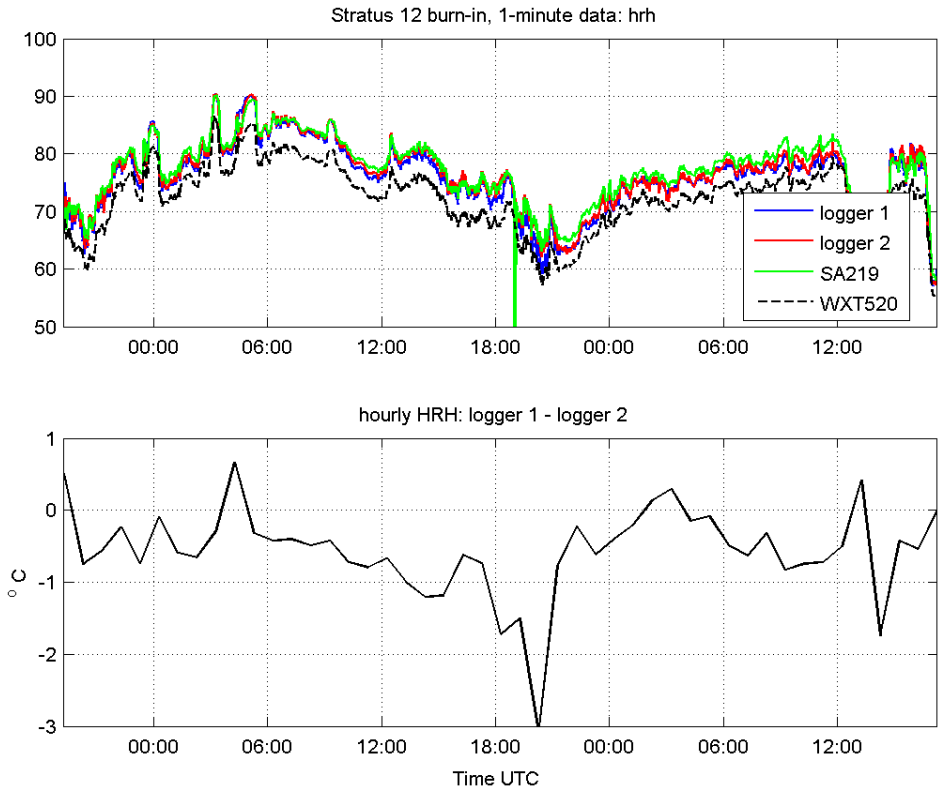

Figure 2-5. Same as Fig. 2-2, but for air relative humidity (HRH), in %RH.

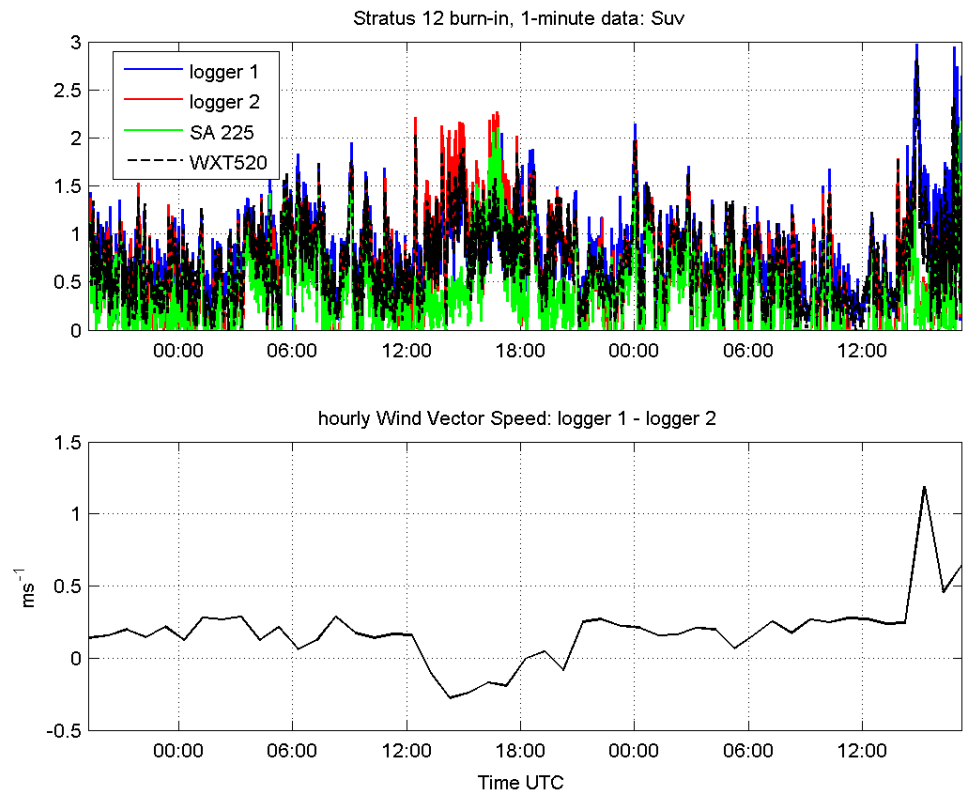

Figure 2-6. Same as Fig. 2-2, but for wind speed (WSPD), in m/s.

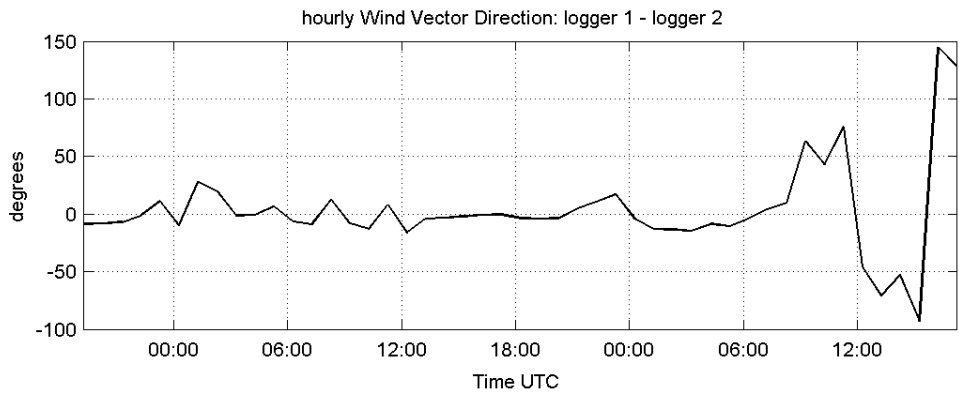
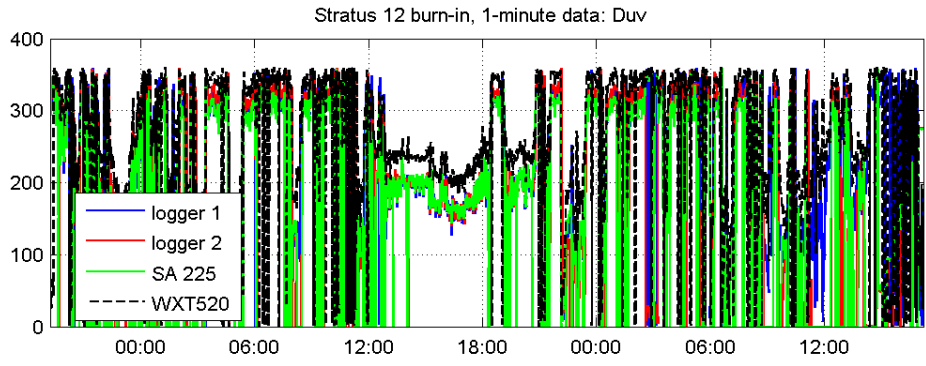

Figure 2-7. Same as Fig. 2-2, but for wind direction, in degrees.

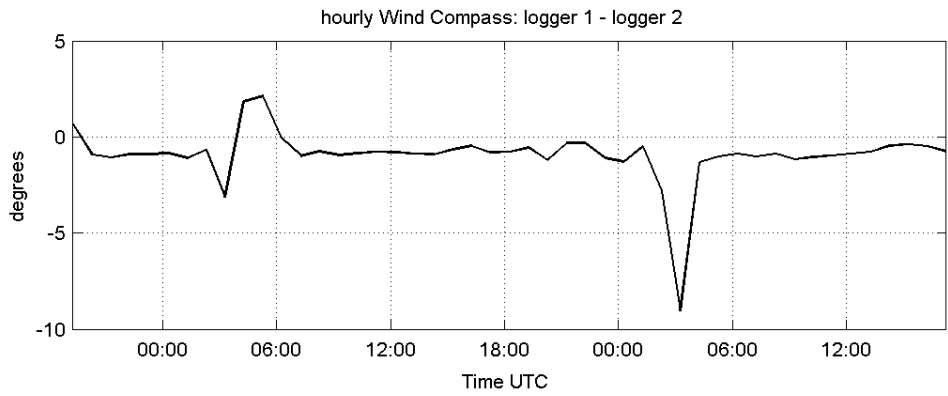
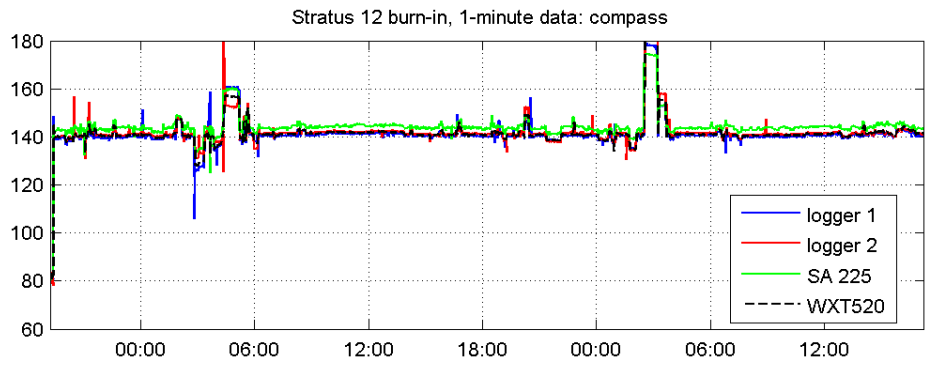

Figure 2-8. Same as Fig. 2-2, but for wind sensor compass, in degrees.

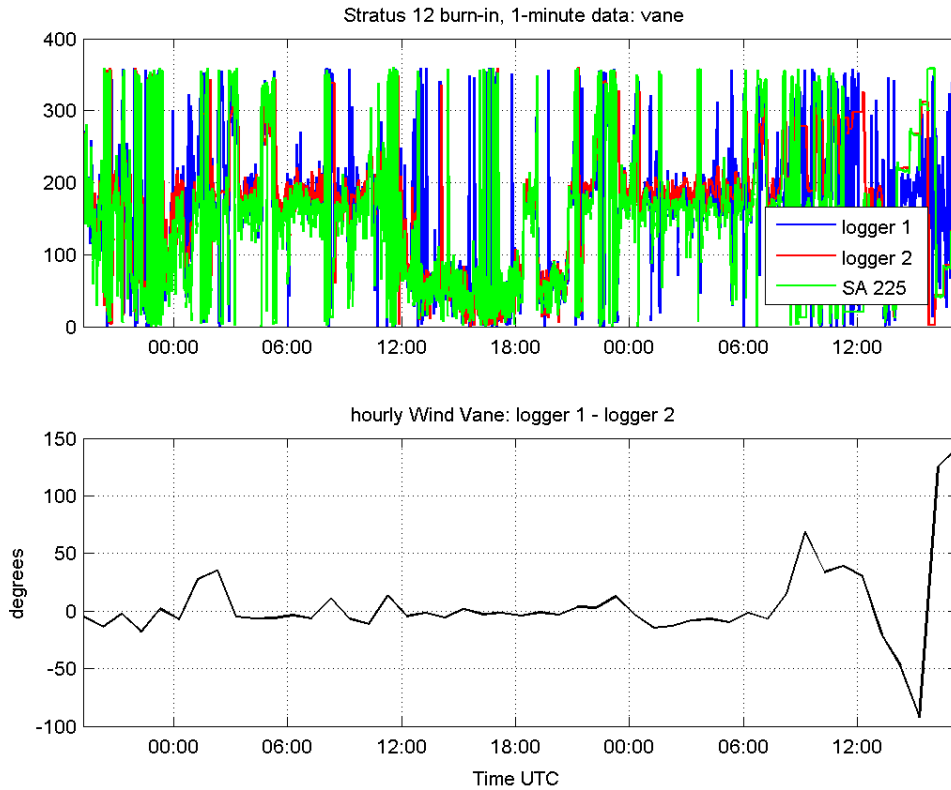

Figure 2-9. Same as Fig. 2-2, but for wind sensor vane, in degrees.

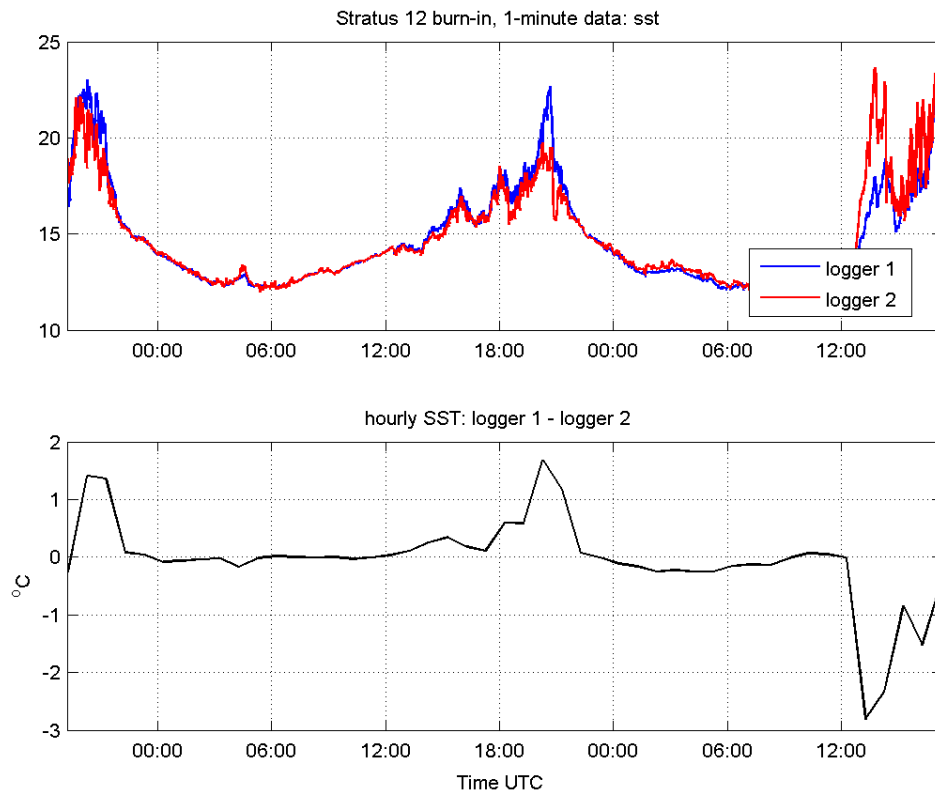

Figure 2-10. Same as Fig. 2-2, but for sea surface temperature (SST), in deg °C.

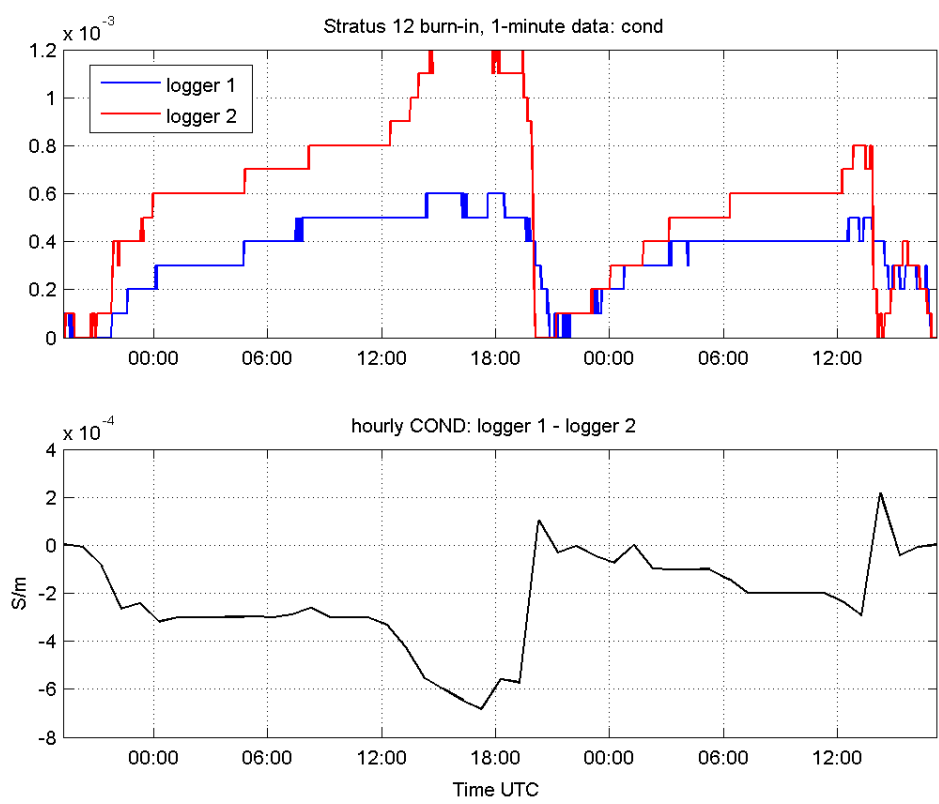

Figure 2-11. Same as Fig. 2-2, but for conductivity, in S/m.

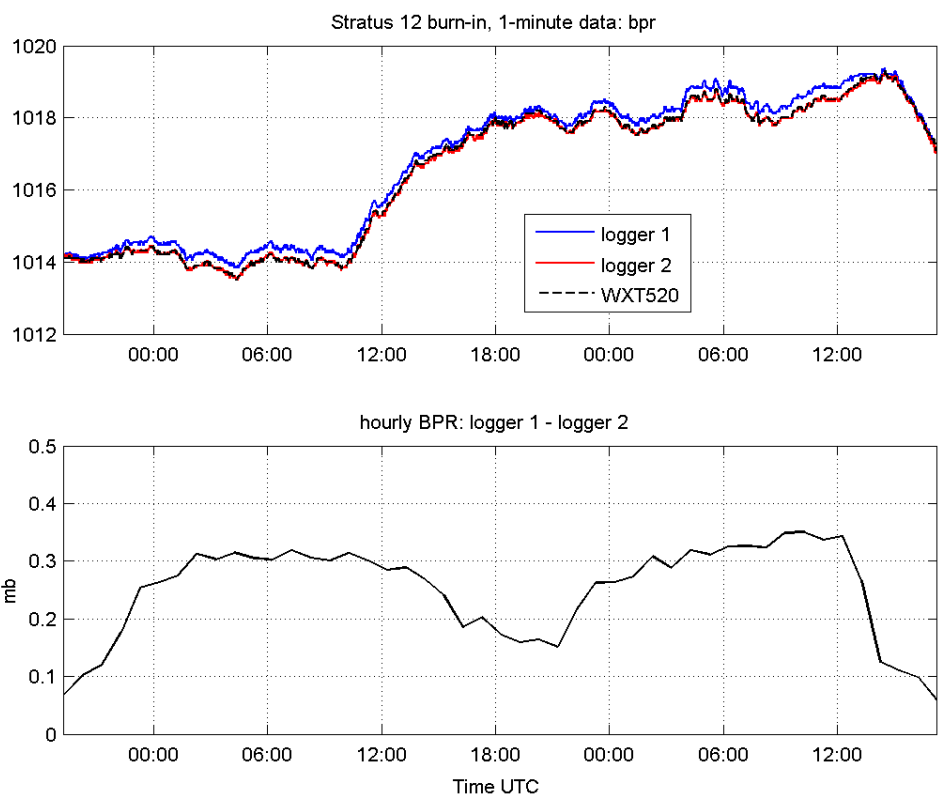

Figure 2-12. Same as Fig. 2-2, but for barometric pressure, in mbar.

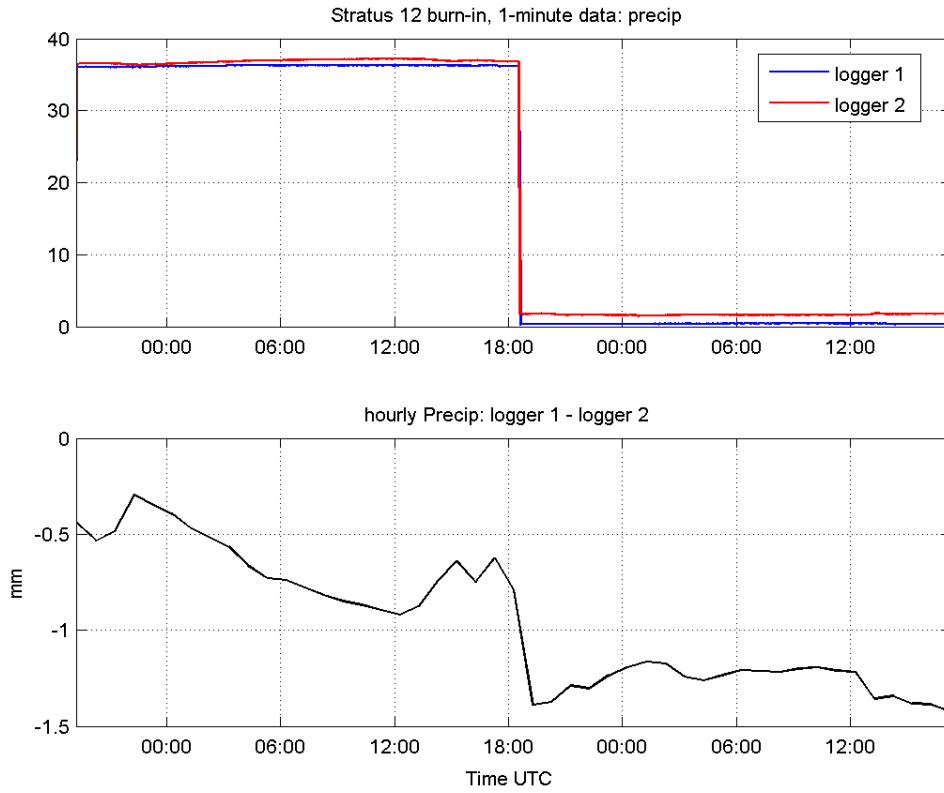

Figure 2-13. Same as Fig. 2-2, but for precipitation, in mm.

III. Stratus 12 Mooring

A. Mooring Design

The buoys used in the Stratus project are equipped with surface meteorological instrumentation, including two Improved Meteorological (IMET) systems (see Figure 3-1). The mooring line also carries subsurface instrumentation that measures conductivity and temperature and a selection of acoustic current meters and vector measuring current meters (VMCM).

The WHOI mooring is an inverse catenary design utilizing wire rope, chain, nylon and polypropylene line and has a scope of 1.25 (scope is defined as slack length/water depth). The Stratus 12 surface buoy has a 2.7-meter diameter foam buoy with an aluminum tower and rigid bridle. The design of these surface moorings takes into consideration the predicted currents, winds, and sea-state conditions expected during the deployment duration. See Figure 3-2 for the full mooring drawing.

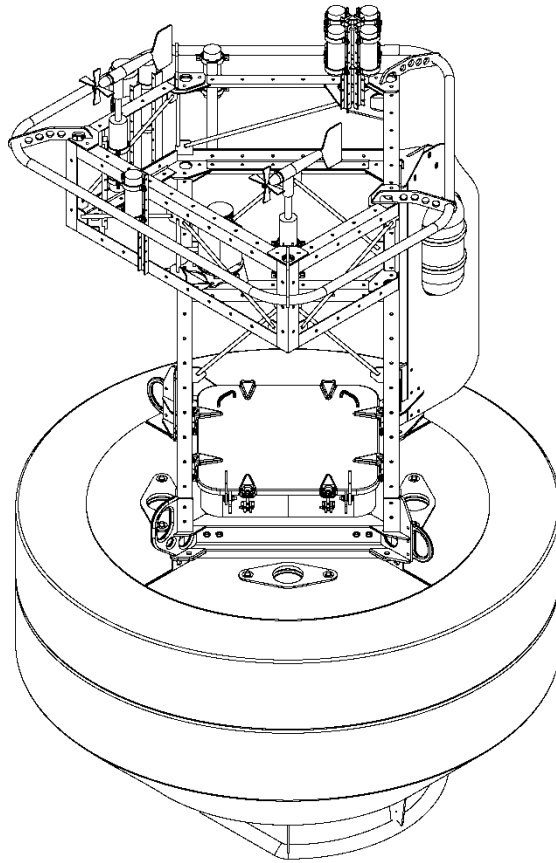
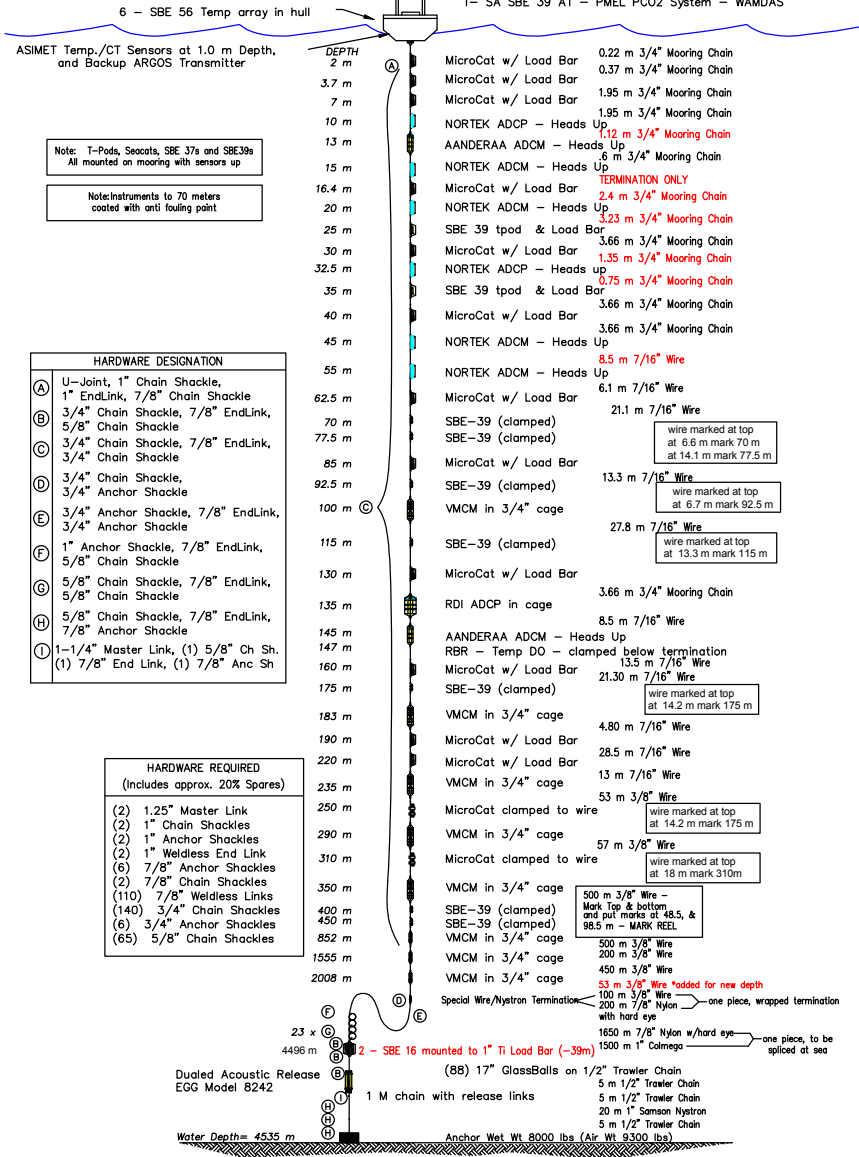

Figure 3-1: Representation of Stratus 9 ASIMET buoy (Stratus 12 is similar).

PO Mooring Number 1247

MAX. DIA. BUOY WATCH CIRCLE = 3.7 N.Miles
Anchor Pos. 19 56.31S, 17.56 W

2.7 m Surlyn Foam MOBS Buoy with:
(2) IMET/ARGOS Telemetry, 1- Vaisala WXT
1 - Sonic Wind 1 - RM Young Wind
1- Stand Alone Wind - 1 SA HRH -1 Lascar HRH
1- SA SBE 39 AT - PMEL PCO2 System - WAMDAS



STRATUS-12 MOORING As Deployed 5/27/12

Figure 3-2. Stratus 12 mooring diagram.

B. Buoy Instrumentation

The Air-Sea Interaction Meteorology (ASIMET) system is the present version of IMET, which is a suite of meteorological and sea surface sensors that are deployed with different housing and packaging depending on the application. ASIMET modules (one or more sensors plus front-end electronics) may be self-powered and self-logging, connected to a central power supply and logger, or both. Together, these modules measure air temperature (ATMP), relative humidity (HRH), sea surface temperature and conductivity (SST, SSC), wind speed and direction (WSPD, WDIR), barometric pressure (BPR), shortwave radiation (SWR), longwave radiation (LWR), and precipitation (PRC). These variables are used to compute air-sea fluxes of heat, moisture and momentum using bulk aerodynamic formulas.

On buoys, modules are packaged in titanium cylinders that include provisions for batteries and internal logging. Buoy modules are typically deployed in pairs, with 6 meteorological module pairs mounted on the buoy tower and a pair of temperature-conductivity sensors attached to the bridle leg. A central logger records one minute data from all the modules on a common time base, and also creates hourly averaged data that are transmitted to shore via Argos satellite telemetry. Some of the one minute data are averages within each minute (see ASIMET documentation on <http://frodo.whoi.edu/asimet>). The Stratus mooring also includes a pCO₂ system from Dr. Chris Sabine of NOAA PMEL and an NDBC wave sensor package.

1) ASIMET

Table 3-1 lists the ASIMET sensors deployed on Stratus 12, while Table 3-2 has the time of the spikes imposed in their data records before deployment.

Table 3-1. ASIMET instrumentation on Stratus 12 buoy (sensors heights are referenced to buoy waterline, which is 65 cm).

System 1			
Module	Serial	Firmware Version	Height (cm)
Logger	1	LOGR53 V4.11 cf	
HRH	213	VOS HRH53 V4.29 cf	231
BPR	219	VOS BPR53 V4.03 cf (Heise)	236.5
SWND	217	SONIC WND53V4.11 cf	266
PRC	204	VOS PRC53 V4.03 cf	245
LWR	219	VOS LWR53 V4.02 cf	285
SWR	501	VOS SWR53 V4.01 cf	285
SST	1725		
PTT	99538	ID's = 14644, 14652, 14653	
System 2			
Module	Serial	Firmware Version	Height (cm)
Logger	2	LOGR53 V4.11cf	
HRH	230	VOS HRH53 V4.29 cf	231
BPR	217	VOS BPR53 V4.03 cf (Heise)	236.5
WND	240	VOS WND53V4.02 cf	266.5
PRC	208	VOS PRC53 V4.03 cf	246
LWR	209	VOS LWR53 V4.02 cf	285
SWR	503	VOS SWR53 V4.01 cf	285
SST	1839		
PTT	14709	ID's = 09805, 09807, 09811	
Stand-Alone Modules			
Module	Serial		Height (cm)
WND	225	VOS WND53V4.02 cf	256
HRH	219	VOS HRH53 V4.29 cf	227
SBE39	5275	Sample 300 seconds	202
VWX	5	V4.04cf	266.5
LASCAR	9174		212
PC02, SAMI, SBE16 (PMEL)			84
SIS Argos	268	ID = 25702	
NDBC Wave package			
NDBC SN 24361, WAMDAS 4003, 3DM-GX1 8712			
Irridium modem IMEI: 300124000115920			
SIM: 89881 69312 00205 1336			

Table 3-2: Stratus 12 surface instrumentation spikes and notes.

Logger 1: start 5/14/2012 6:21:30 PM. Dump 5/16 18:00. Adjust clock 5/17 18:19
SWND 217 adjust orientation 5/17 14:20
PRC 204: 250 ml 5/14/12 19:17. Fill/drain 5/15 18:35. Add water 5/24 17:00. Fill/drain 5/27 11:51
SST 1725: Start 5/14/12 0100. In seawater 5/17 18:55. Out seawater 5/18 18:50. Unplug 5/21 16:42. Plug in 5/21 18:00
Logger 2: start 5/14/2012 6:46:30 PM. Dump 5/16 18:20. Adjust clock 5/17 18:30
PRC 208: 250 ml 5/14/12 19:17. Fill/drain 5/15 18:35. Fill/drain 5/27 11:51
SST 1839: Start 5/14/12 0100. In seawater 5/17 18:55. Out seawater 5/18 18:50. Unplug 5/21 16:42. Plug in 5/21 18:00
WND 225: Start 5/14/2012 6:48:30 PM Dump 5/16 19:30
HRH 219: Start 5/14/2012 6:48:30 PM Dump 5/16 19:15
SBE 39 5275: Start 5/14/12 0100
VWX 5: Start 5/14/2012 6:48:30 PM
Lascar 9174: Start 5/14/12 0100
Wave package: Start 5/14/2012 6:26:00 PM

2) Sea Surface Temperature

Two Sea-Bird SBE 37s are mounted to the bottom of the buoy hull at approximately one meter depth. These instruments are part of the IMET system and provide data of temperature and conductivity near the sea surface from one single measurement each minute. Hourly averages are also transmitted through Argos in near real time. The full 1-minute data are transmitted to the logger whereas the internal memory of the SBE 37 records only 5-minute data. In addition to these SST sensors, an array of Seabird 56 sensors was placed in holes in the buoy foam hull. Table 3-3 lists the SST instrument array on the buoy hull.

Table 3-3: Stratus 12 Sea Surface Temperature Array. Orientation is in degrees, positive clockwise, with buoy vane=0 (AFT) and buoy front =180 (FORWARD).

Instrument	Serial	Depth Below Deck (cm)	Orientation Degrees
SBE56	1206	-90	AFT
SBE56	1207	-90	PORT
SBE56	1208	-90	FORWARD
SBE56	1209	-120	FORWARD
SBE56	1210	-140	FORWARD
SBE56	1211	-90	STARBOARD

3) Air Temperature and Relative Humidity

Rotronic MP-101A sensor. Accuracy after UOP lab calibration, 1%RH, 0.05°C. Drift (post vs. pre cal after 1 yr): 1%RH, 0.05°C (Colbo and Weller, 2009). The sensor probe is protected by a Rotronic MF25 membrane filter and placed inside a modified R.M. Young multi-plate radiation shield for standard use. Sensors are installed opposite to the buoy vane to provide unobstructed air flow and minimize heat-island effects. Measurement is formed from one single snapshot each minute. There are indications from recent deployments during the past two years that the Rotronic sensors can drift from their calibration after shipping and lead to unacceptable biases. An additional air temperature was therefore installed on Stratus 12; it consisted of a Seabird SBE 39 with solar shield and sampled air temperature once every 5 minutes.

4) Precipitation

RM Young 50202 Self-siphoning rain gauge. Accuracy of rain rate after lab calibration, 1 mm/hr (Serra et al., 2001). Measurement is formed from one single snapshot each minute.

5) Shortwave radiation

Eppley Precision Spectral Pyranometer (PSP). Accuracy from comparison to standard, 2 W/m² (Colbo and Weller, 2009). Drift (post vs. pre calibration after 1 yr): 2 W/m² (Colbo & Weller, 2009). Sensor mounted higher than other instruments on buoy to avoid shadowing. One minute sample is formed by averaging over 6 snapshot measurements taken 10 seconds apart.

6) Longwave radiation

Eppley Precision Infrared Radiometer (PIR). Accuracy from comparison to standard, 2 W/m² (Colbo and Weller, 2009). Drift (post vs. pre calibration after 1 yr): 2 W/m² (Colbo and Weller, 2009). Measurement is formed from one single snapshot each minute.

7) Barometric pressure

Heise DXD (Dresser Instruments). Accuracy after UOP lab calibration, 0.2 mb. Drift (post vs. pre cal after 1 yr): 1.5 mb (Colbo and Weller, 2009). Measurement is formed from one single snapshot each minute.

8) Wind

R.M. Young 5103 wind monitor. Accuracy after UOP lab calibration, 1%, 3 degrees. Drift (post vs. pre cal after 1 yr): 0.1 m/s, 2.0 deg (Colbo and Weller 2009). Sensor is mounted opposite to the buoy vane to avoid flow disturbance. Velocity speed is measured from propeller rotations over 5 seconds, one vane measurement each second, and a single snapshot of compass during these 5 seconds. For each 5 seconds segment, a vector average is formed from the 5 seconds average vane and single snapshot compass. Eleven of these 5 seconds velocity vectors are averaged at the end of the minute interval to form the final velocity output. A scalar average of wind speed is also computed from the rotations of the propellers, but this measurement is noisier and recorded with less resolution.

A Gill Sonic Wind Sensor was incorporated on the Stratus 12 buoy. The anemometer measures the time taken for an ultrasonic pulse to travel from one transducer to the opposite transducer and

then compares it with the time taken for another pulse to travel in the opposite direction. Likewise, differences are measured between other pairs of transducers allowing calculations of both wind speed and direction. This sensor samples at 40 Hz and the one minute data is formed from eleven 5-second averages, similar to the RM Young wind processing.

9) Subsurface Argos Transmitter

A Subsurface Mooring Monitoring Beacon (SMM 500), built by Sensoren Instrumente Systeme GmbH (SiS), was mounted upside down on the bottom of the buoy. This is a backup recovery aid in the event that the mooring parts and the buoy capsizes.

10) Telemetry

Each ASIMET module onboard the buoy samples data every minute and records it on a dedicated flashcard. The logger receives and stores this data. It also computes hourly averages for Argos transmissions. These Argos transmissions can be picked up as well by an Alpha Omega Uplink receiver directly from the Argos antenna on the buoy. The hourly averages help to monitor the status of instruments and the quality of data they provide.

11) PCO₂

Upwelling in the equatorial Pacific leads to enhanced productivity and degassing of CO₂ across a region ranging from the coast of South America to past the International Date Line. The vast area affected makes this region a significant contributor to global biogeochemical cycles. Variability in the South American upwelling region has been linked to a wide range of ecosystem and biogeochemical changes. Understanding this variability is a primary reason for the ongoing work at the Stratus site. The PCO₂ system on the Stratus mooring is a component of the OceanSITES moored PCO₂ network.

CO₂ measurements are made every three hours in marine boundary layer air and air equilibrated with surface seawater using an infra-red detector. The detector is calibrated prior to each reading using a zero gas derived by chemically stripping CO₂ from a closed loop of air and a span gas (414 ppm CO₂) produced and calibrated by NOAA's Earth System Research Laboratory (ESRL).

A summary file of the measurements is transmitted once per day and plots of the data are posted in near real-time to the web. To view the daily data, visit the NOAA PMEL Moored CO₂ Website: http://www.pmel.noaa.gov/co2/moorings/stratus/stratus_main.htm. Within a year of system recovery, the final processed data are submitted to the Carbon Dioxide Information Analysis Center (CDIAC) for release to the public.

12) Wave Package

The WAMDAS wave system used on the Stratus 12 buoy is made by Neptune Sciences and acquired from NDBC. This includes wave measurements, GPS positions and times. It utilizes a 3-axis motion package made by MicroStrain Inc. The WAMDAS is capable of transmitting and storing data. The transmitted data is sent via Iridium communications on an hourly basis. This message is ultimately transmitted to NDBC where the data are subjected to automated quality-control checks and then posted on the NDBC web site. The data are stored in raw and processed format on a 1 GB compact flash card in the instrument.

13) Vaisala WXT520

The Vaisala Weather Transmitter WXT520 measures barometric pressure, humidity, precipitation, temperature, and wind speed and direction. It uses ultrasound to determine horizontal wind speed and direction. Barometric pressure, temperature, and humidity measurements are combined in the PTU module using capacitive measurement for each parameter. The WXT520 also measures accumulated rainfall, rain intensity and duration of the rain — all in real time. The signals exerting from the impacts are proportional to the volume of the raindrops. Hence, the signal from each drop can be converted directly to the accumulated rainfall. According to manufacturer, accuracies are 0.3 m/s or 3% for wind speed, 3° for wind direction, 0.3°C for air temperature, 3%RH below 90%RH (in practice we find this sensor to have a low bias larger than this value when compared to ASIMET sensors), 0.1 mbar for barometric pressure, 5% for rain accumulation (not including wind effects).

C. Subsurface Instrumentation

The following sections describe individual instruments on the buoy bridle and mooring line. Where possible, instruments were protected from being fouled by fishing lines using “trawl-guards” designed and fabricated at WHOI. These guards are meant to keep lines from hanging up on the in-line instruments.

Before a buoy launch and after its recovery, different physical signals are imprinted in the instruments’ records at determined times. These spikes reveal the possible presence of a drift in the internal clock of instruments. Temperature and salinity sensors are plunged into a large bucket filled with ice and fresh water for about an hour. VMCM rotors are spun and then blocked.

Table 3-4 summarizes the subsurface instrumentation set up. The details of the set up are shown in Appendix 3. Mooring logs are in Appendixes 4 and 5 and contain descriptions of deployment and mooring instrumentation for Stratus 11 and 12.

Table 3-4. Set up of Stratus 12 subsurface instrumentation.

Instrument	Serial	Depth (m)	Sample (s)	Start Date	Start Time	Spike Start	Spike Stop
SBE37	1304T	2	300 sec	14-May-12	0100	5/17/12 17:44	5/17/12 19:19
SBE37	1899	3.7	300 sec	14-May-12	0100	5/17/12 17:44	5/17/12 19:19
SBE37	1901	7	300 sec	14-May-12	0100	5/17/12 17:44	5/17/12 19:19
SBE37 P	7836p	16.4 p	300 sec	17-May-12	1600	5/17/12 17:44	5/17/12 19:19
SBE37	1902	30	300 sec	14-May-12	0100	5/17/12 17:44	5/17/12 19:19
SBE37	3821	40	300 sec	14-May-12	0100	5/17/12 17:44	5/17/12 19:19
SBE37	3824	62.5	300 sec	14-May-12	0100	5/17/12 17:44	5/17/12 19:19
SBE37	0010T	85	300 sec	14-May-12	0100	5/17/12 17:44	5/17/12 19:19
SBE37 P	8004p	130 p	300 sec	17-May-12	1600	5/17/12 17:44	5/17/12 19:19
SBE37	1900	160	300 sec	14-May-12	0100	5/17/12 17:44	5/17/12 19:19
SBE37	1903	190	300 sec	14-May-12	0100	5/17/12 17:44	5/17/12 19:19
SBE37	1905	220	300 sec	14-May-12	0100	5/17/12 17:44	5/17/12 19:19
SBE37	1907	250 c	300 sec	14-May-12	0100	5/17/12 17:44	5/17/12 19:19
SBE37	2011	310 c	300 sec	14-May-12	0100	5/17/12 17:44	5/17/12 19:19
SBE16	1876	deep	1800	14-May-12	0100	5/17/12 15:48	5/17/12 17:42
SBE16	1889	deep	1800	14-May-12	0100	5/17/12 15:48	5/17/12 17:42
SBE39	1502	25	300 sec	14-May-12	0100	5/17/12 15:17	5/17/12 15:48
SBE39	1509	35	300 sec	14-May-12	0100	5/17/12 15:17	5/17/12 15:48
SBE39	1511	70	300 sec	14-May-12	0100	5/17/12 15:17	5/17/12 15:48
SBE39	3423	77.5	300 sec	14-May-12	0100	5/17/12 15:17	5/17/12 15:48
SBE39	3434	92.5	300 sec	14-May-12	0100	5/17/12 15:17	5/17/12 15:48
SBE39	3435	115	300 sec	14-May-12	0100	5/17/12 15:17	5/17/12 15:48
SBE39	3437	175	300 sec	14-May-12	0100	5/17/12 15:17	5/17/12 15:48
SBE39	3438	400	300 sec	14-May-12	0100	5/17/12 15:17	5/17/12 15:48
SBE39	3439	450	300 sec	14-May-12	0100	5/17/12 15:17	5/17/12 15:48
SBE56	1206	0.25	15 sec	14-May-12	0100	5/17/12 15:01	5/17/12 15:48
SBE56	1207	0.25	15 sec	14-May-12	0100	5/17/12 15:01	5/17/12 15:48
SBE56	1208	0.25	15 sec	14-May-12	0100	5/17/12 15:01	5/17/12 15:48
SBE56	1209	0.55	15 sec	14-May-12	0100	5/17/12 15:01	5/17/12 15:48
SBE56	1210	0.75	15 sec	17-May-12	1400	5/17/12 15:01	5/17/12 15:48
SBE56	1211	0.25	15 sec	17-May-12	1400	5/17/12 15:01	5/17/12 15:48
							n/a
VMCM	9	100	60 sec	17-May-12	13:06	mooring log	n/a
VMCM	10	183	60 sec	17-May-12	13:28	mooring log	n/a
VMCM	30	235	60 sec	17-May-12	13:17	mooring log	n/a
VMCM	35	290	60 sec	17-May-12	13:03	mooring log	n/a
VMCM *	38	350	60 sec	17-May-12	13:34	mooring log	n/a
VMCM	58	852	60 sec	17-May-12	13:11	mooring log	n/a
VMCM	68	1555	60 sec	17-May-12	13:23	mooring log	n/a
VMCM	73	2008	60 sec	17-May-12	13:20	mooring log	n/a
Nortek 2 MHZ CM	1666	10m	900	14-May-12	0100	5/17/12 19:50	5/17/12 20:30
Nortek 2 MHz CM	2064	15m	900	14-May-12	0100	5/17/12 19:50	5/17/12 20:30

Nortek 2 MHz profiler	402	20m	1800	14-May-12	0100	5/17/12 19:50	5/17/12 20:30
Nortek 1 MHz Profiler	333	32.5m	3600	14-May-12	0100	5/17/12 19:50	5/17/12 20:30
Nortek 2 MHz CM	1688	45m	900	14-May-12	0100	5/17/12 19:50	5/17/12 20:30
Nortek 2 MHz CM	9883	55m	900	14-May-12	0100	5/17/12 19:50	5/17/12 20:30
Seaguard	235	13m	20 min	18-May-12	14:20	5/18/12 14:39	5/18/12 16:30
Seaguard	238	145m	30 min	18-May-12	14:30	5/18/12 14:39	5/18/12 16:30
RDI 307200 Hz	12254	135m	3600	14-May-12	0100	5/18/12 11:50	5/18/12 14:36
RBR DUO T.DO 02	50026	147m	4	25-May-12	0100		

1) VMCMs

The VMCM has two orthogonal cosine response propeller sensors that measure the components of horizontal current velocity parallel to the axles of the two-propeller sensors. The orientation of the instrument relative to magnetic north is determined by a flux gate compass. East and north components of velocity are computed continuously averaged and then stored. All the VMCMs deployed from Stratus 4 onward have been next generation models that have newer circuit boards and record on flash memory cards instead of cassette tape. Temperature was also recorded using a thermistor mounted in a fast response pod, which was mounted on the top end cap of the VMCM.

2) RDI Acoustic Doppler Current Profiler

The RD Instruments (RDI) Workhorse Acoustic Doppler Current Profiler (ADCP, Model WHS300-1) is mounted looking upwards on the mooring line. The RDI ADCP measures a profile of current velocities. The beams have a 20° angle. Head is in the Janus configuration (4 acoustic beams to identify upstream flow).

3) Nortek

The Nortek Aquadopp and Aquapro current meters and profilers use Doppler technology to measure currents. The Aquadopps we use on Stratus usually have 3 beams tilted at 25 degrees and use a transmit frequency of 2 MHz. The internal tilt and compass sensors give current direction. For the Aquapro, 1 MHz beams reach further.

4) Aanderaa RCM 11 and SEAGUARD

The Aanderaa RCM 11 measures the horizontal current speed and direction, as well as temperature. The instrument can operate continuously or in eight intervals from 1 to 120 minutes.

The new SEAGUARD RCM series replaces the industry Standard RCM 9 and RCM 11 series. It has been completely redesigned from bottom up and employs modern technology in the datalogger section and in the different sensor solutions. On stratus 11, these instruments also included an oxygen sensor.

5) SBE-39 Temperature Recorder

The Sea-Bird model SBE-39 is a small, lightweight, durable and reliable temperature logger. It is a high-accuracy temperature recorder (pressure optional) with internal battery and non-volatile memory for deployment at depths up to 10,500 meters (34,400 feet).

6) SBE37 MicroCat Conductivity and Temperature Recorder

The MicroCat, model SBE37, is a high-accuracy conductivity and temperature recorder with internal battery and memory. The temperature range is -5° to +35°C, and the conductivity range is 0 to 6 Siemens/meter. The pressure housing is made of titanium and is rated for 7,000 meters. The instruments were mounted on in-line tension bars and deployed at various depths throughout the moorings. The conductivity cell is protected from bio-fouling by the placement of antifoulant cylinders at each end of the conductivity cell tube.

7) Seabird 56

The SBE 56 is a low-cost, high-accuracy, battery-powered temperature and time logger. The SBE 56’s pressure-protected thermistor has a 0.5 second time constant, providing excellent accuracy (initial accuracy 0.002 °C) and resolution when fast sampling at 2 Hz (0.5 sec). It has exceptional stability; drift is typically less than 0.002 °C per year.

8) Seabird 16

The SBE 16 SEACAT is designed to measure and record temperature and conductivity in the range -5 to +35 °C at high levels of accuracy (0.01 °C) and resolution (0.001 °C) while deployed in either a fixed or moored application. Powered by internal batteries, SEACAT is capable of recording data for periods of a year or more. Data may be acquired at intervals of 15 seconds to 8 hours in one-second increments.

9) Acoustic Release

The acoustic release used on the Stratus 12 mooring is an EG&G Model 8242. This release can be triggered by an acoustic signal and will release the mooring from the anchor. Releases are tested at depth prior to deployment to ensure that they are in proper working order (Table 3-5).

Table 3-5: Stratus 12 releases test on 2012/05/23

SN 35316	Firmware: E 111273, D 111302, R 127413					
SN 31335	Firmware: E 471427, D 471442, R 447756					
		enable	range	disable	fire	disable
Stratus 12 #1	depth 500	y	y	y	y	y
	depth 1500	y	y	y	y	y
Stratus 12 #2	depth 500	y	y	y	y	y
	depth 1500	y	y	y	y	y

D. Current Meter Setup

The setup of current meters and profilers is a tradeoff between measurement precision and length of the record (battery life). For profilers, the number of cells and subsequent range is also a criterion. The setup of acoustic current meters and profilers is summarized in Tables 3-6 and 3-7 for Stratus 12 and 11, respectively. For more details of the setup, see Appendix 3.

Norteks sample at 1 Hz and we chose an averaging period between 160s and 180s to be able to average out the swell (~15s period at Stratus site) and wave signal. Power level for pinging was set to HIGH- (this is 6 dB less than HIGH, which was the setting chosen in previous deployments) since these instruments are near the surface and plenty of backscatter material should be present. With this configuration, battery utilization computed by the Nortek software during instrument setup is less than 90%, and an assumed duration of 540 days. This estimate is based on Lithium batteries (160 W.h capacity) and the housing was extended to accommodate 2 extra battery packs. The compass update rate was set at 1s, which is important for consistency with sampling rate of 1 Hz.

The RDI Workhorse Sentinel operates at 307,200 Hz, with 4 beams at 20° from the vertical. For Stratus 12 the blanking distance was set to 1.76m; 150 pings per ensemble and 1s per ping and 1hr for output sampling were selected.

Note that for a profiler near the surface, by choosing cells that are higher than the water surface, it is possible to diagnose possible problems in the data because there is a lot of backscatter caused by the air-water interface. For example, if a beam does not show a maximum in the signal intensity near the surface, its record should be used with caution. Also, if the maximum in intensity appears in different cells for different beams, it indicates that the instrument (and therefore the mooring line) was probably tilted. However, the signal is valid only below and away from the surface because of the side lobe reflections (maximum distance is therefore a function of $\cos(\alpha)$, where α is the angle of the beam with the vertical).

Table 3-6. Setup of acoustic current meters and profilers for Stratus 12.

Instrument	Nortek 333	Nortek 402	Nortek 1666, 1688, 2064, 9883	RDI 1225 4	Aanderaa Seaguard (235)	Aanderaa Seaguard (238)
Sampling Freq kHz	1000	2000	2000	307.2		
Measurement Interval (s)	3600	1800	900	3600	1200	1800
Number cells	13	8	N/A	12	1	1
Cell size (m)	1	0.5	N/A	10	2.5	2.5
Blanking distance (m)	0.41	0.2	0.37	1.76	1	0.5
Average Interval (s)	180	180	160	150	200 pings	300 pings
Measurement load (%)	88	26	9	n/a	n/a	n/a
Power level	HIGH-	HIGH-	HIGH-	n/a	n/a	n/a
Battery utilization (%)	85	87	90	n/a	n/a	n/a
Battery days	540	540	540		738	720
Compass update rate (s)	1	1	1	n/a	n/a	n/a
Vertical precision (cm/s)	0.3	0.3	1.1	n/a	n/a	n/a
Horizontal precision (cm/s)	0.8	0.9	0.6			
Notes			Diagnostics : Interval = 720 min Samples= 60			

Table 3-7. Setup of acoustic current meters and profilers for Stratus 11.

Instrument	Nortek 357	RDI 1218	Aanderaa RCM 11 (13, 78, 79)	Aanderaa Seaguard (138, 140)	Aanderaa Seaguard (141 to 144, 181, 182)
Sampling Freq kHz	2000	307.2			
Measurement Interval (s)	600	3600	1800	1200	1800
Number cells	11	12	1	1	1
Cell size (m)	1	10		2.5	2.5
Blanking distance (m)	0.4	1.76		1	0.5
Average Interval (s)	80	60		200 pings	300 pings
Measurement load (%)	9	n/a	n/a	n/a	n/a
Power level	HIGH-	n/a	n/a	n/a	n/a
Battery utilization (%)	289	n/a	n/a	n/a	n/a
Battery days	548			698	706
Compass update rate (s)	1	n/a	n/a	n/a	n/a
Vertical precision (cm/s)	0.4	n/a	n/a	n/a	n/a
Horizontal precision (cm/s)	1.2				

E. Antifouling Coatings

Early moorings at this site have been used as test beds for a number of different antifouling coatings. The desire has been to move from organotin-based antifouling paints to a product that is less toxic to the user, and more environmentally friendly. These tests have previously led the Upper Ocean Process group to rely on E Paint Company's, Sunwave and Ecominder products as the anti-fouling coating used on the buoy hull, and ZO for the majority of instruments deployed from the surface down to 70 meters.

After a full year in the ocean, the instruments have a considerable amount of biofouling regardless of the paint used on instrument housings. The bio-grease used on transducer heads has been very effective, but it is also very toxic, and is used as little as possible.

For STRATUS 11 & 12, only PVC tape was used on instrument bodies. This should make cleaning the instruments much easier, but will not act as an antifoulant. Copper guards were used on the SBE 37 C/T instruments, and Desitin diaper rash paste was used around all sensors on transducer heads. The Desitin is a viscous, zinc-based paste that has been used as an alternative to the poison paints and greases typically used.

Table 3-8 below shows methods used for coating the buoy hull and instrumentation for the Stratus 12 deployment.

Table 3-8: Stratus 12 Anti Fouling Application

DEPTH	INSTRUMENT	ANTI FOULING APPLIED
Surface	Buoy Hull	E-prime base coat E-Paint Ecominder – 5 coats – blue.
Surface	Fixed SSTs (4)	(1) Destin on vane side, (3) Aqua lube on three sides
1 M	SBE 37 – SST (2)	E-paint ZO (2 coats) & copper guards Desitin on cells
2, 3.7, 7, 16, 30, 40, 62.5 M	SBE 37 (C/T)	PVC tape, copper shield. Desitin around cell
25, 35	SBE - 39	Desitin around sensor
10, 15, 20, 32.5, 45, 55 M	NORTEK ADCP	PVC Desitin around sensor head and 2" below.
13, M	Aanderaa ADCM	PVC tape on body. Desitin on transducer heads and all around stem

Instruments recovered from the STRATUS 11 mooring had similar preparations for anti-fouling. These instruments came back relatively clean around the treated areas. This relatively benign preparation, using copper guards, PVC tape, and Desitin paste seems to work as well as all but the most toxic methods used in previous years.

F. Mooring Operations

1) Deployment of Stratus 12 and anchor survey

On arrival at the Stratus mooring area, winds became very light, and at times were out of the northwest. At the same time, the existing Stratus 11 mooring was seen to be pushed off to the west. A target with depth close to 4,525 m was identified at 19° 56.25' S, 85° 17.44'W, about 20 nm to the southeast of Stratus 11. On the evening of May 26, a trial approach was made with RV Melville from the west to the east along a heading of 090°. Moderate swell running out of the southwest proved to be a challenge for the ship, and the decision was made to steam into the swell, coming from the northeast to the southwest. Because of evidence from altimetry of an eddy and because Stratus 11 was off to the west in its watch circle, the track length was lengthened from the planned 8.0 nm to 8.5 nm.

Deployment tracking in the lab was set up using the following points:

Start	19° 51.968'S	85° 09.620'W
Target	19° 56.250'S	85° 17.440'W
End	19° 57.290'S	85° 19.256'W

The Target is the target for the anchor; the Start is 8.5 nm away; and the End is 2.0 nm past the target. The track of the ship during the deployment and subsequent three point acoustic survey of the anchor position are shown in Figure 3-3. Before breakfast on May 27, 2012, RV Melville was hove to at the start point. After breakfast the deployment began.

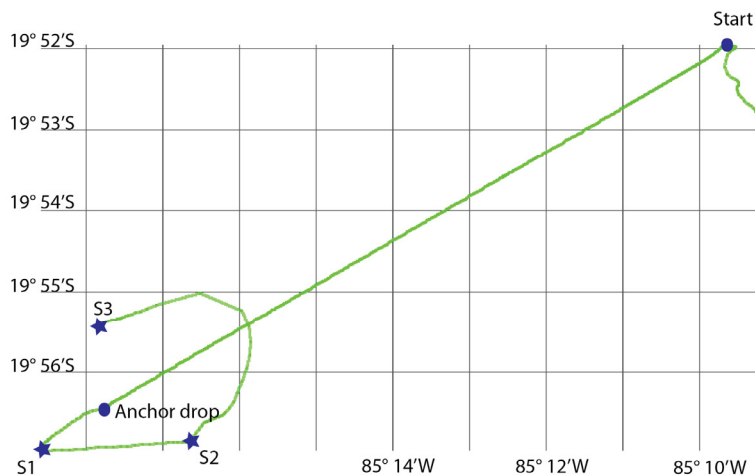

Figure 3-3. The track of the RV Melville during the deployment of the Stratus 12 surface mooring and subsequent anchor survey. The three points used in the acoustic survey are labeled S1, S2, and S3, on May 27 2012. Start of track is about 8.5 nm downwind of target anchor drop.

As the mooring was deployed the ship proceeded to the southwest along the track line. The anchor was dropped when the ship had steamed ~300m past the Target site. This was to allow for fallback. After one hour, allowing time for the anchor to reach the bottom, a three point acoustic survey was carried out using the points shown in Figure 3-3, each roughly 1 nm from the Target site. At each of these sites an Edgetech 8011A deck unit was used to communicate with the acoustic release on the mooring. Signal travel time was recorded at each site. Travel time and ship's coordinates for each site were entered into Arthur Newhall's Acoustic Survey

Software to calculate anchor position. The program uses the intersection of each range arc to calculate anchor position, see Figure 3-4.

The acoustic survey data are:

S1	19° 56.836'S	85° 18.505'W	6.470 sec	4985 m
S2	19° 56.851'S	85° 16.658'W	6.432 sec	4824 m
S3	19° 55.329'S	85° 17.567'W	6.399 sec	4799 m

The MATLAB mooring anchor position program yielded the positioning diagram in Figure 3-4. The solution yields an anchor location of 19° 56.3064'S, 85° 17.5598'W. The anchor dropped 233.5 m to the southwest of the Target and about 77 m to the northeast of the anchor drop.

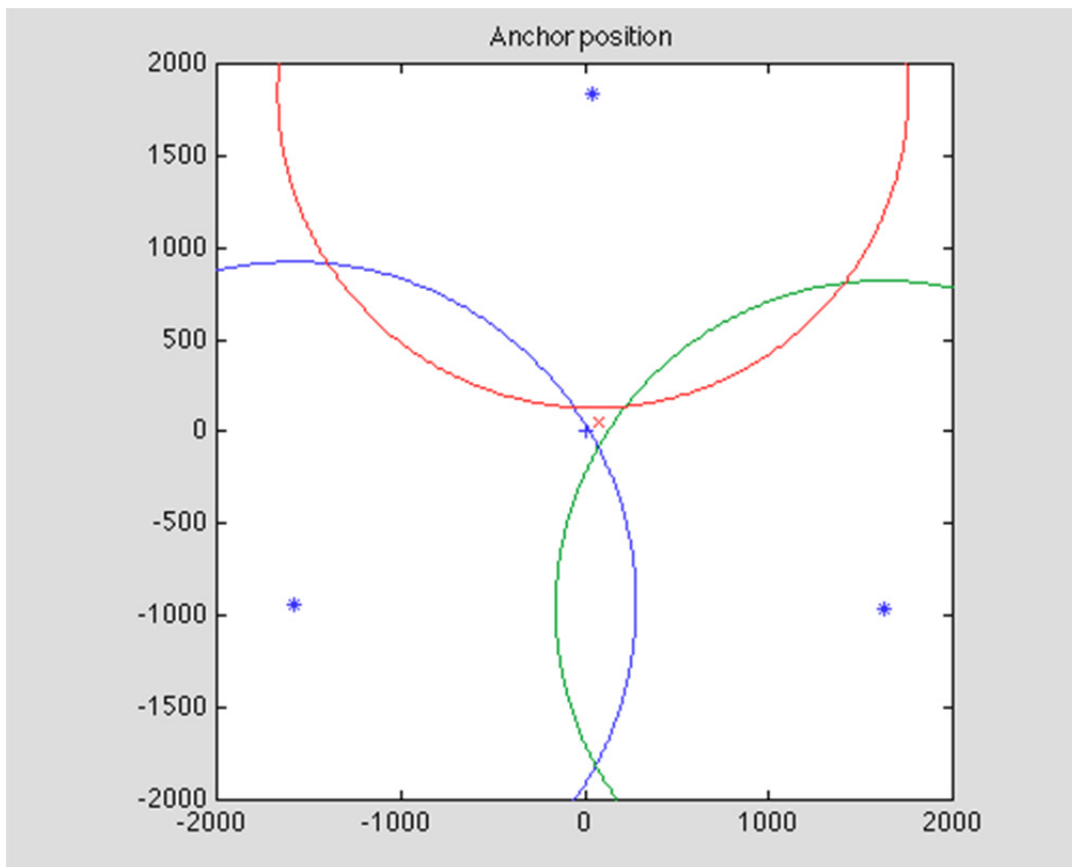

Figure 3-4. Visual solution of Stratus 12 mooring anchor position (red x). The blue + is the Drop location.

2) Mooring Deployment Operations

For the surface mooring deployment operation, the ship was positioned 8.5 nautical miles downwind and down current from the center the target site. An earlier bottom survey indicated this track would take the ship over large area with consistent ocean depth.

The Stratus 12 surface mooring was set using a two-phase mooring technique. Phase 1 involved the lowering of approximately 50 meters of instrumentation followed by the buoy, over the starboard side of the ship. Phase 2 is the deployment of the remaining mooring components through the A-frame on the stern.

The TSE winch drum was pre-wound with the following mooring components listed from deep to shallow:

- 200 m 7/8" nylon – nylon to wire shot
- 450 m 3/8" wire - nylon to wire shot
- 500 m 3/8" wire
- 500 m 3/8" wire
- 57 m 3/8" wire
- 53 m 3/8" wire
- 50 m 3/4" spectra working line

A tension cart was used to pre-tension the nylon and wire during the winding process.

Prior to the deployment of the mooring, the working line was passed out through the center of the A-frame, around the aft port quarter then forward along the rail to the instrument lowering area. Three wire handlers were stationed around the aft port rail and A-frame. The wire handlers' job was to keep the working line from fouling in the ship's propellers and to pass the line around the stern after the buoy was deployed.

To begin the mooring deployment, the ship hove to with the bow positioned with the wind slightly on the starboard bow. The crane boom was positioned over the instrument lowering area to allow a vertical lift of at least four meters. All subsurface instruments for this phase had been staged in order of deployment in the aft hangar bay. All instrumentation had chain or wire rope shackled to the top of the instrument load bar or cage. A shackle and ring were attached to the top of each shot of chain or wire.

The first instrument segment to be lowered was a Nortek ADCM at 45m. This instrument had a 3.66-meter shot of chain shackled to the top of the instrument cage, and a 8.5 meter shot of 7/16" wire rope shackled to the bottom. This segment of wire was shackled into the working line coming from the winch. The crane hook, suspended over the instrument lowering area was lowered to approximately 1 meter off the deck. A six-foot sling was hooked onto the crane and passed through a ring to the top of the 3.66-meter shot of chain shackled to the top of the current meter.

The crane was raised so the chain and instrument were lifted off the deck. The crane slowly lowered the wire and attached mooring components into the water. The line handlers positioned

around the stern eased line over the port side, paying out enough to keep the mooring segment vertical in the water. An air tugger with a chain hook was used to haul on the chain and take the load from the crane. A stopper was attached to the top link of the instrument array as a backup. The hook on the crane was removed. Lowering continued with 11 more instruments and chain segments being picked up and placed over the side.

The operation of lowering the upper mooring components was repeated up to the 7 meter SBE 37 MicroCat. The load from this instrument array was stopped off using a slip line passed through a pear link shackled into the chain above the load bar. The 2 and 3.7 meter instruments were shackled to hardware and chain connecting them to the universal joint on the bottom of the buoy. The vertical instrument array hanging in the water was joined to the two instruments attached to the bottom of the buoy.

The next operation was launching the buoy. Three slip lines were rigged on the buoy to maintain control during the lift. Lines were rigged on the buoy bottom, the tower, and a buoy deck bail. The 30 ft. slip line was used to stabilize the bottom of the buoy at the start of the lift. The 50 ft. tower slip line was rigged to check the tower as the hull swung outboard. A 75 ft. buoy deck bail slip line was rigged to prevent the buoy from spinning as the buoy settled in the water. This is used so the quick release hook, hanging from the crane, could be released without fouling against the tower. The deck slip line was removed just following the release of the buoy.

With the three slip lines in place, the crane was positioned over the buoy. The quick release hook, with a 1" sling link, was attached to the crane hook. Slight tension was taken up on the crane to hold the buoy. The ratchet straps securing the buoy to the deck were removed. The buoy was raised up and swung outboard as the slip lines kept the hull in check. The stopper line holding the suspended 45 meters of instrumentation was eased off to allow the buoy to take the hanging load. The lower slip line was removed first, followed by the tower slip line. Once the buoy had settled into the water (approximately 15 ft. from the side of the ship), and the release hook had gone slack, the quick release was tripped. The crane swung forward to keep the block away from the buoy. The slip line to the buoy deck bail was cleared at about the same time. The ship then maneuvered slowly ahead to allow the buoy to come around to the stern.

The winch operator slowly hauled in the slack wire once the buoy had drifted behind the ship. The ship's speed was increased to .5 knot through the water to maintain a safe distance between the buoy and the ship. The bottom end of the shot of wire shackled to the working line was pulled in and stopped off at the transom.

A traveling block was suspended from the crane. The free end of the working line was passed through the block. The next instrument, a 55 meter depth frame with a Nortek ADCM current meter and pre-attached wire shot was shackled to the end of the stopped off mooring. The bottom of this wire was shackled into top of the working line. The hauling line was pulled onto the TSE winch to take up the slack. The winch slowly took the mooring tension from the stopper lines.

The winch line pulled back, lifting the current meter off the deck as it was raised. The instrument was lifted clear of the deck and over the transom. The winch was payed out to the next termination. The termination was stopped off using lines on cleats, and the hauling wire removed while the next instrument was attached to the mooring.

The next several instruments were deployed in a similar manner. When pulling the slack on the longer shots of wire, the terminations were covered with a canvas wrap before being wound onto the winch drum. The canvas covered the shackles and wire rope termination to prevent damage from point loading the lower layers of wire rope and nylon on the drum. This process of instrument insertion was repeated for the remaining instruments down to 2008 meters. Smaller instruments were clamped to the wire rope as the wire was payed off the winch.

At this point, the mooring was stopped off, and a 53 meter shot of wire rope was inserted into the mooring to make up for the added water depth at the target deployment site.

The winch continued to pay out wire and nylon line until all mooring components that had been pre-wound were payed out. The end of the 200 m nylon was stopped off about 15 feet from the transom using a sling through the thimble.

An H-bit cleat was positioned aft of the TSE winch and secured to the deck. The free end of the 3150 meter shot of nylon/Colmega line, stowed in three wood-lined wire baskets was wrapped onto the H-bit and passed to the stopped off mooring line. The shackle connection between the two nylon shots was made. The line handler at the H-bit pulled in all the residual slack and held the line tight against the H-bit. The stopper lines were then eased off and removed.

The person handling the line on the H-Bit kept the mooring line parallel to the H-bit with moderate back tension. The H-bit line handler and one assistant eased the mooring line out of the wire basket and around the H-bit at the appropriate payout speed relative to the ship's speed. Another person sprayed water on the h-bit to keep the line from heating up.

While the nylon and Colmega line was being payed out, the crane was used to lift the 88 glass balls out of the open top container. These balls were staged fore and aft, in four ball segments, on the starboard side of the deck.

When the end of the Colmega line was reached, pay out was stopped and a Yale grip was used to take tension off the line. The winch tag line was shackled to the end of the Colmega line. The line was removed from the H-Bit. The winch line and mooring line were wound up taking the mooring tension away from the stopper lines on the Yale grip. The stopper lines and Yale grip were removed. The TSE winch payed out the mooring line until all but one meter of the Colmega line was over the transom.

The 88 glass balls are bolted on 1/2" trawler chain in 4 ball (4 meter) increments. The first set of glass balls was dragged into position and shackled together. One end was attached to the mooring at the transom. The other end was shackled to the winch leader. The winch pulled the mooring line tight, stopper lines were removed, and the winch payed out until three of the four balls were off the stern. Stopper lines were attached, the winch leader was removed, and two more string of glass balls were inserted into the mooring line. This process was repeated until all 88 balls were deployed.

A 1" titanium load bar with two SBE 16 C/T loggers was shackled to the last glass ball segment. After that, a five-meter shot of 1/2" chain was connected to the mooring. The winch took tension

on the mooring, stopper lines were removed, and a chain hook connected to the air tugger line running through the block on the a-frame lifted the SBE 16s off the deck. The winch payed out with the tugger, and the instruments were eased over the transom. The tugger went slack, and the chain hook was removed.

The acoustic releases were shackled to the chain. Another 5-meter chain section was shackled to the releases. A 20-meter Nystron anchor pendant was shackled to that chain, and another 5-meter section of ½” chain was shackled to the anchor pendant. The mooring winch wound up these components until it had the tension of the mooring. The acoustic releases were laying flat on the deck.

A chain hook connected to the air tugger line running through the block on the a-frame lifted the acoustic releases off the deck. The winch payed out with the tugger, and the instruments were eased over the transom. The tugger went slack, and the chain hook was removed

The winch continued to pay out until the final 5-meter shot of chain was just going over the transom. A shackle and link was attached one meter up this segment of chain. A heavy-duty slip line was passed through the link and secured to the winch leader. The winch hauled in until tension was transferred to the slip line. The chain lashings were removed from the anchor. The end of the chain was removed from the winch and shackled to the anchor on the tip plate.

At this point, the ship was still one mile from the target anchor position. The mooring was towed through the water as preparations to tip the anchor were finalized.

The ships trawl wire was fed through the a-frame block. The a-frame was positioned above the anchor, and the trawl wire was connected to the chain bridle on the anchor tip plate. A slight strain was applied to the bridle. The slip line was removed, transferring the mooring tension to the 1/2” chain and anchor. The line was pulled clear and the anchor slid off the stern without the need to raise the tip plate.

G. Instrument Intercomparisons

1) Ship meteorological data

Meteorological observations made onboard R/V Melville come mostly from sensors on the forward mast on the bow and are 55 feet above the mean water line. These sensors provide air temperature and humidity, barometric pressure, precipitation, wind speed and direction, longwave and shortwave radiations. Additionally, WHOI mounted a sonic flux system on the forward mast (12.6m above the water), comprised of a Gill R3A Ultrasonic Anemometer, a Crossbow DMU-AHRS motion package, and an Onset TT8 interface. Measurements near the sea surface come from uncontaminated seawater intake that feeds a vortex debubbler, which then supplies a flow-thru system. Different sensors then measure water temperature and conductivity, oxygen saturation, fluor. Figures 3-5 and 3-6 below show the air-sea measurements made during the cruise.

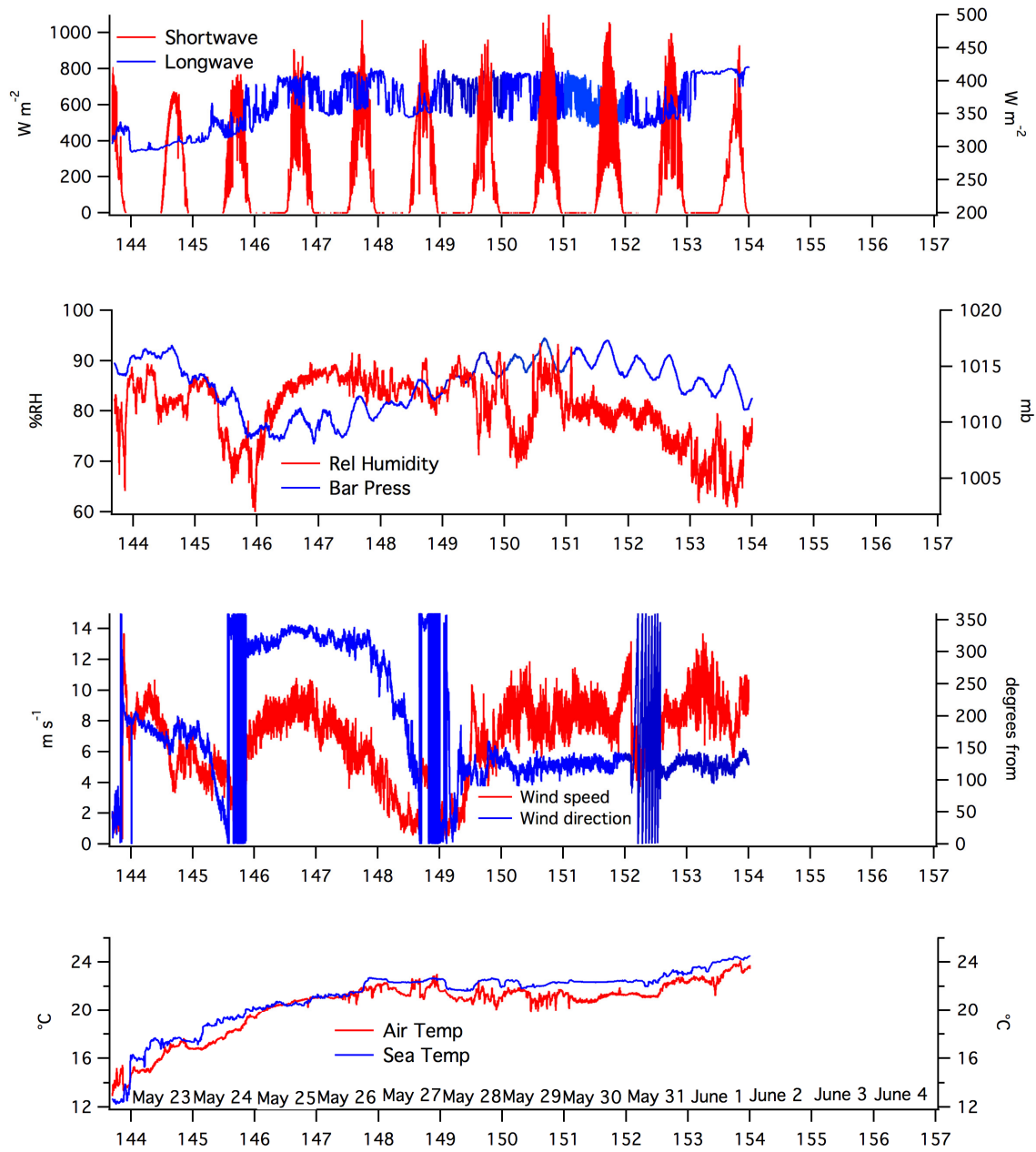

Figure 3-5. Meteorological observations made from R/V *Melville* during the Stratus 12 cruise.

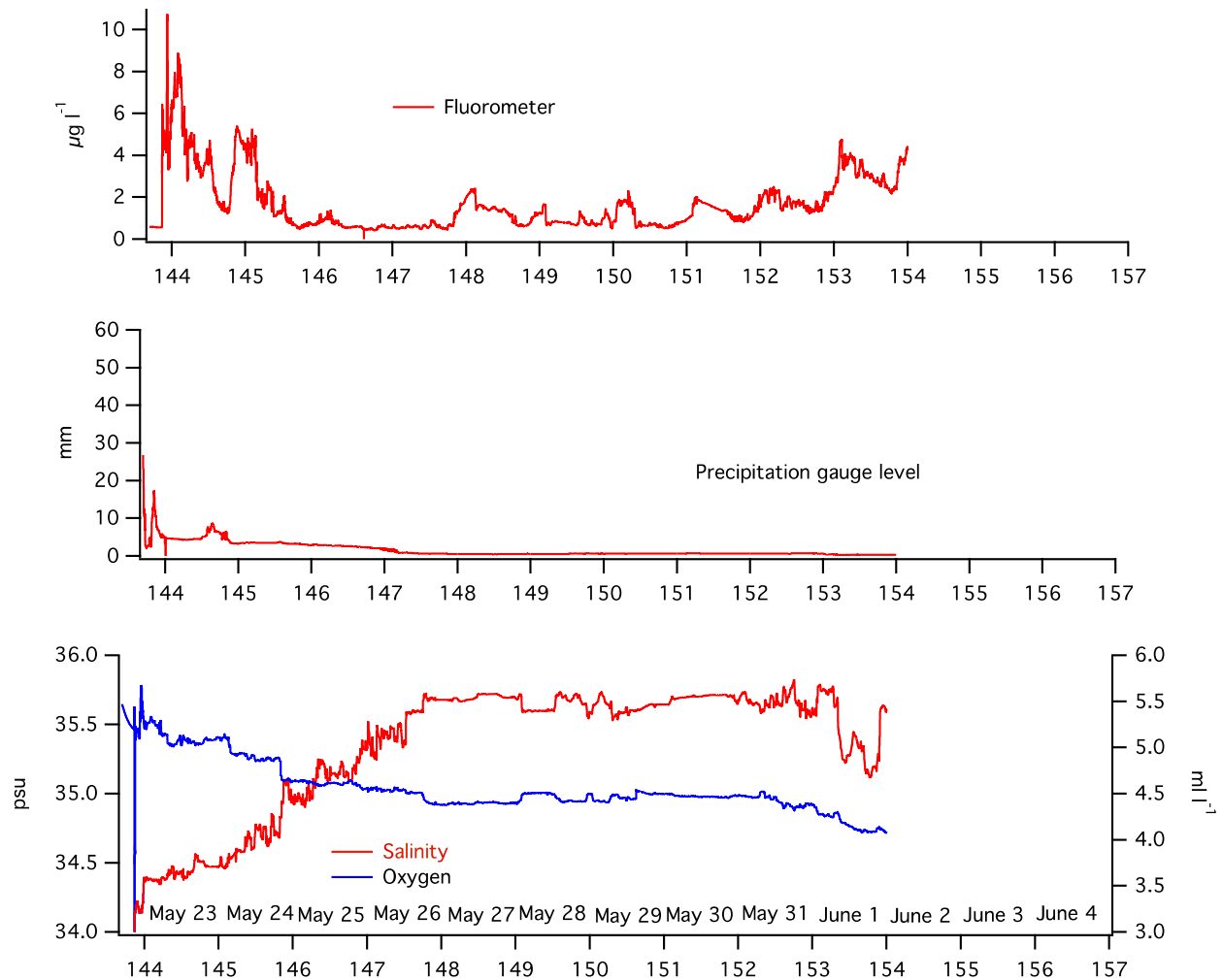

Figure 3-6. Near sea-surface and precipitation observations made from R/V *Melville* during the Stratus 12 cruise.

2) Intercomparison results

Between the deployment of Stratus 12 and the recovery of Stratus 11, R/V *Melville* conducted a bathymetry survey between the two anchor sites. Observations from the ship were made from sensors on the bow mast at a height of 55 feet above the waterline. These measurements were adjusted to 2.9m for air temperature and humidity and barometric pressure and 3.3m for wind speeds, in keeping with sensors heights on the deployed buoys. The results are presented in Figures 3-7 to 3-10. Stratus 11 HRH values are noticeably lower than every other measurement available (Fig 3-7 and 3-10), including with the Stratus 12 HRH spare which was mounted on the freshly recovered Stratus 11 buoy. Post-calibrations will be necessary to confirm the presence of such bias. The Lascar sensors on Stratus 11 seem to give reasonable data.

Figure 3-7. Comparison between ship measurements adjusted to buoy height (2.9m for ATMP, HRH, BPR and 3.3m for WSPD) and data from Stratus 11 and 12. Distance between R/V *Melville* and buoy anchor positions (top), air temperature and relative humidity (center), bulk SST (bottom).

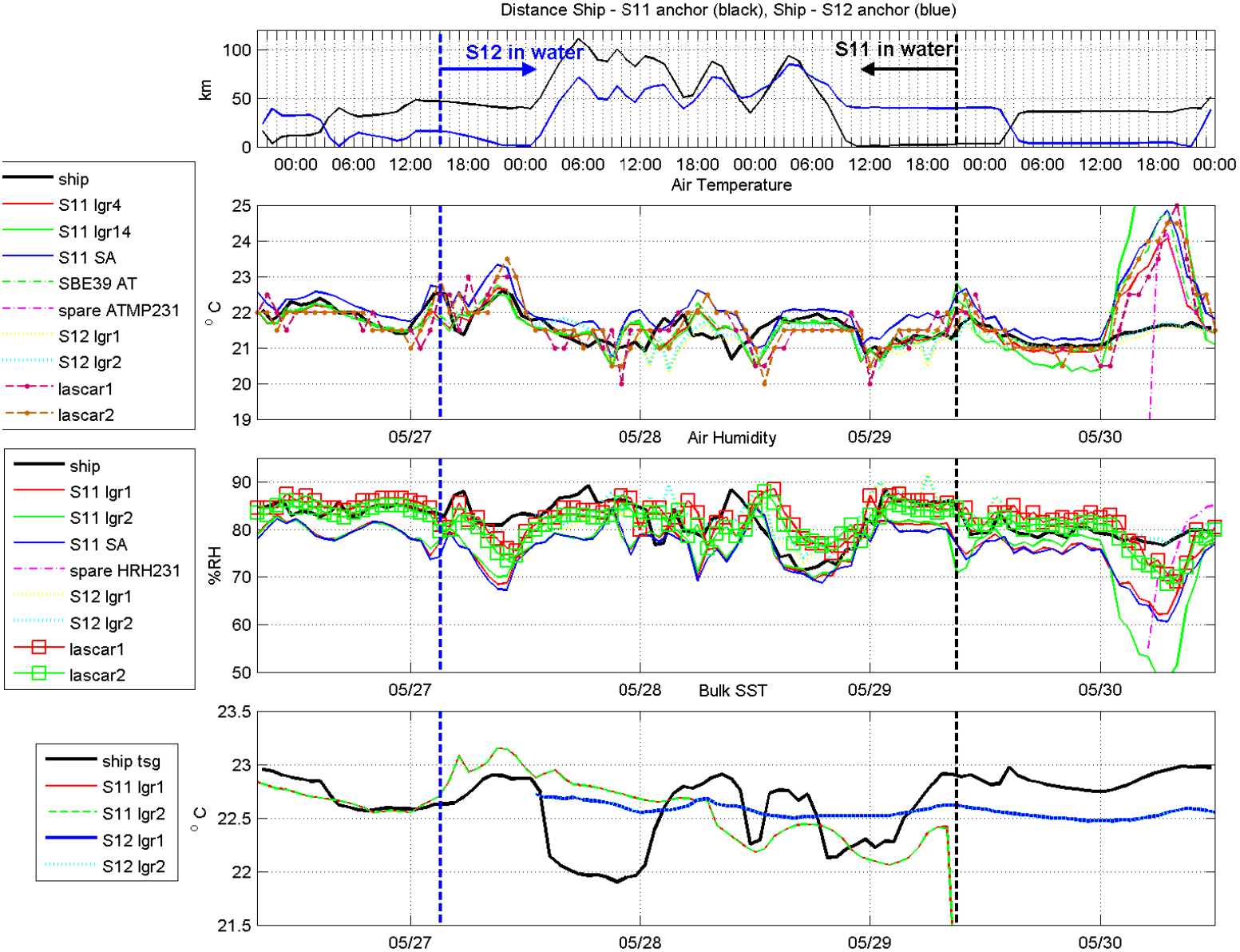

Figure 3-8. Same as Fig 3-7 but for shortwave (SWR), barometric pressure (BPR) and longwave (LWR).

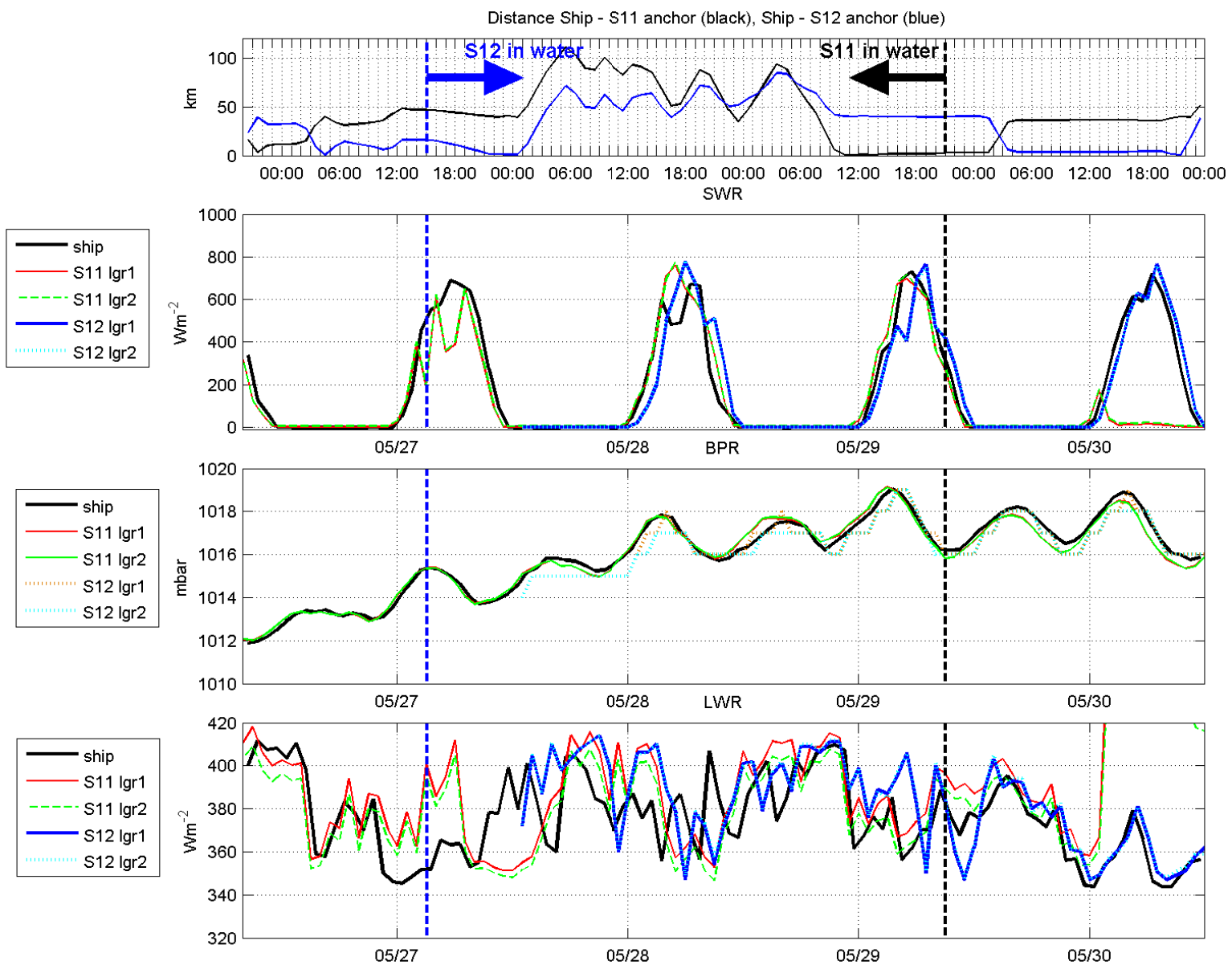
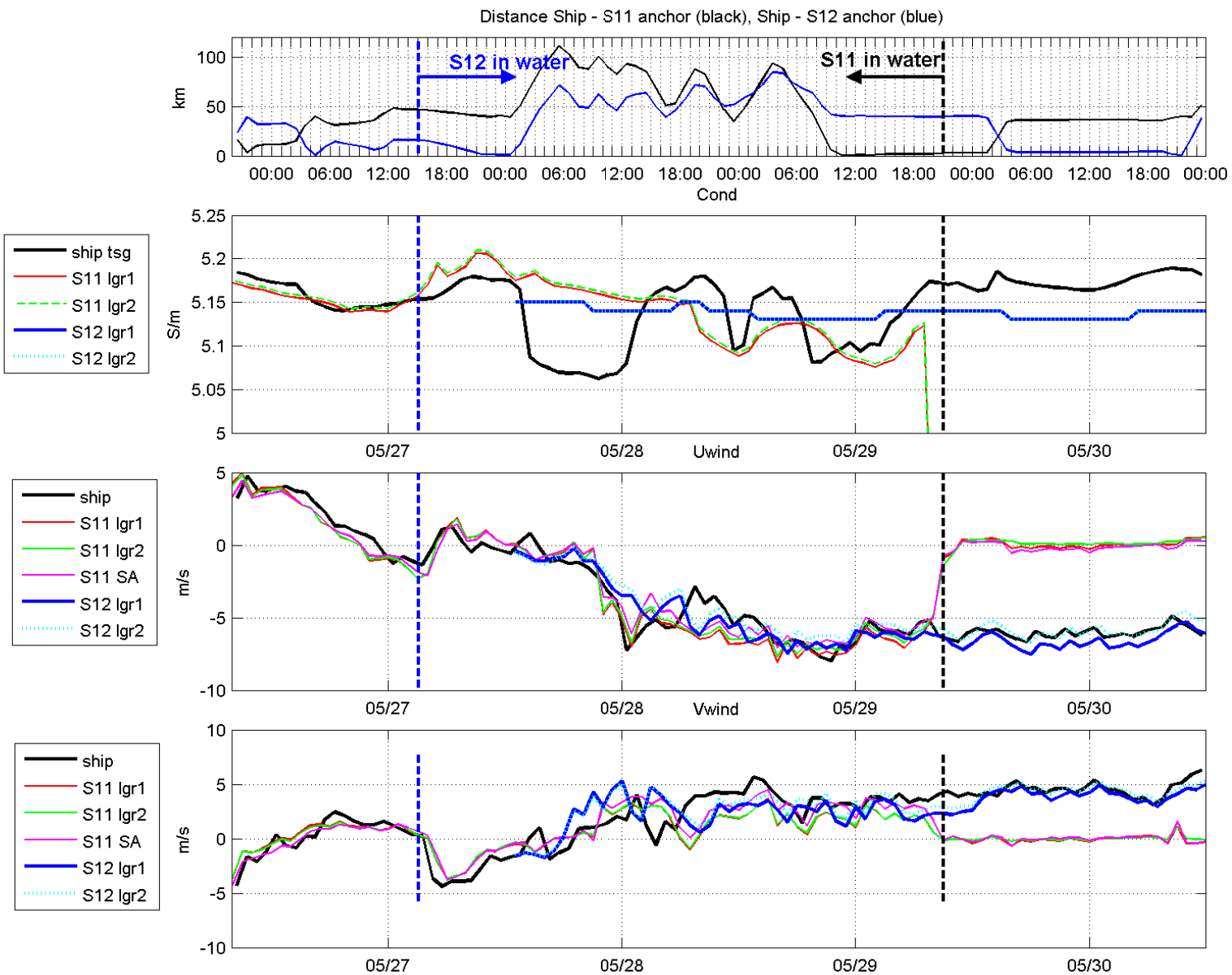

Figure 3-9. Same as Fig 3-7 but for near-surface conductivity, eastward wind speed, northward wind speed.



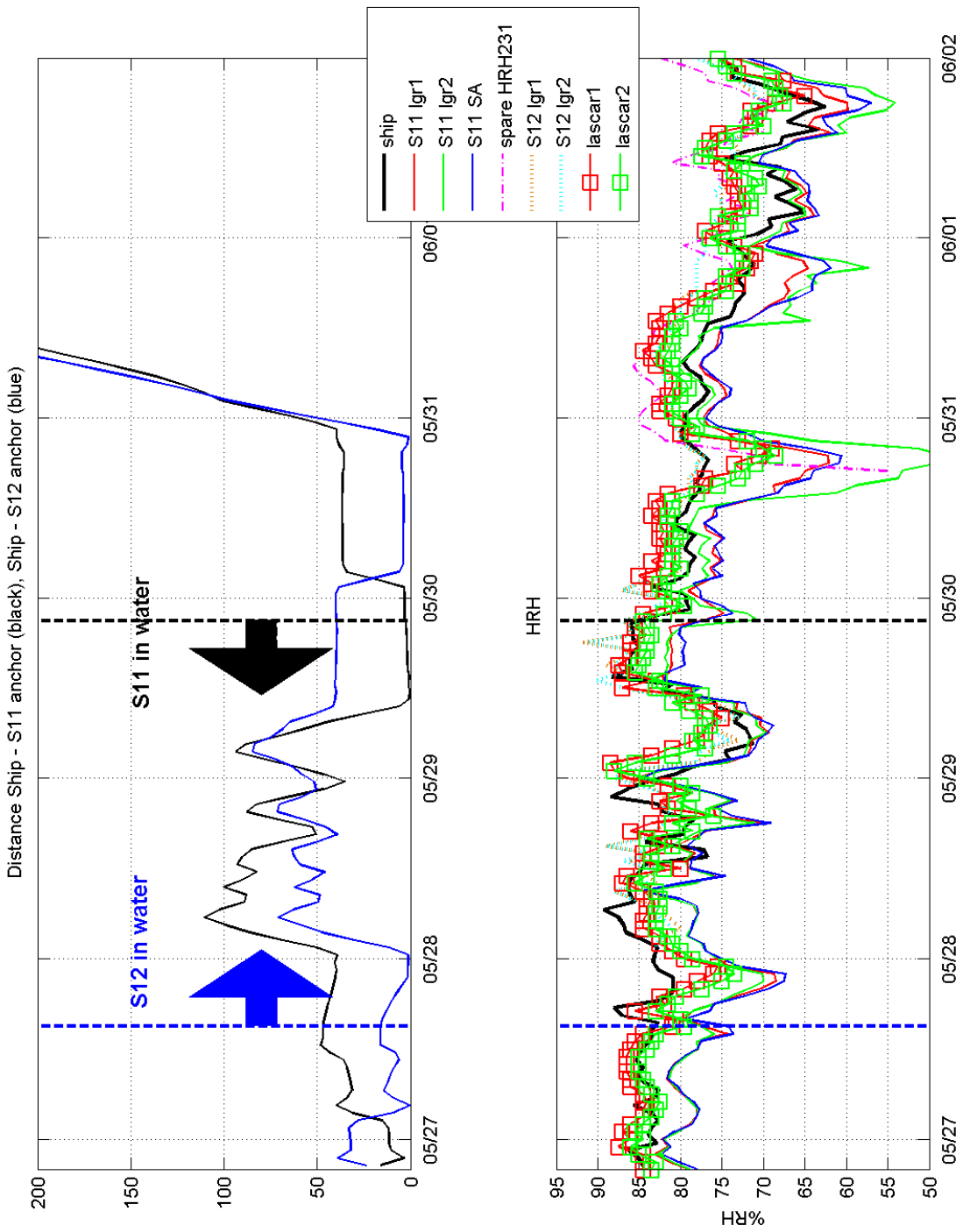

Figure 3-10. Similar to Fig 3-7 but for longer period and HRH only.

IV. Stratus 11 Mooring

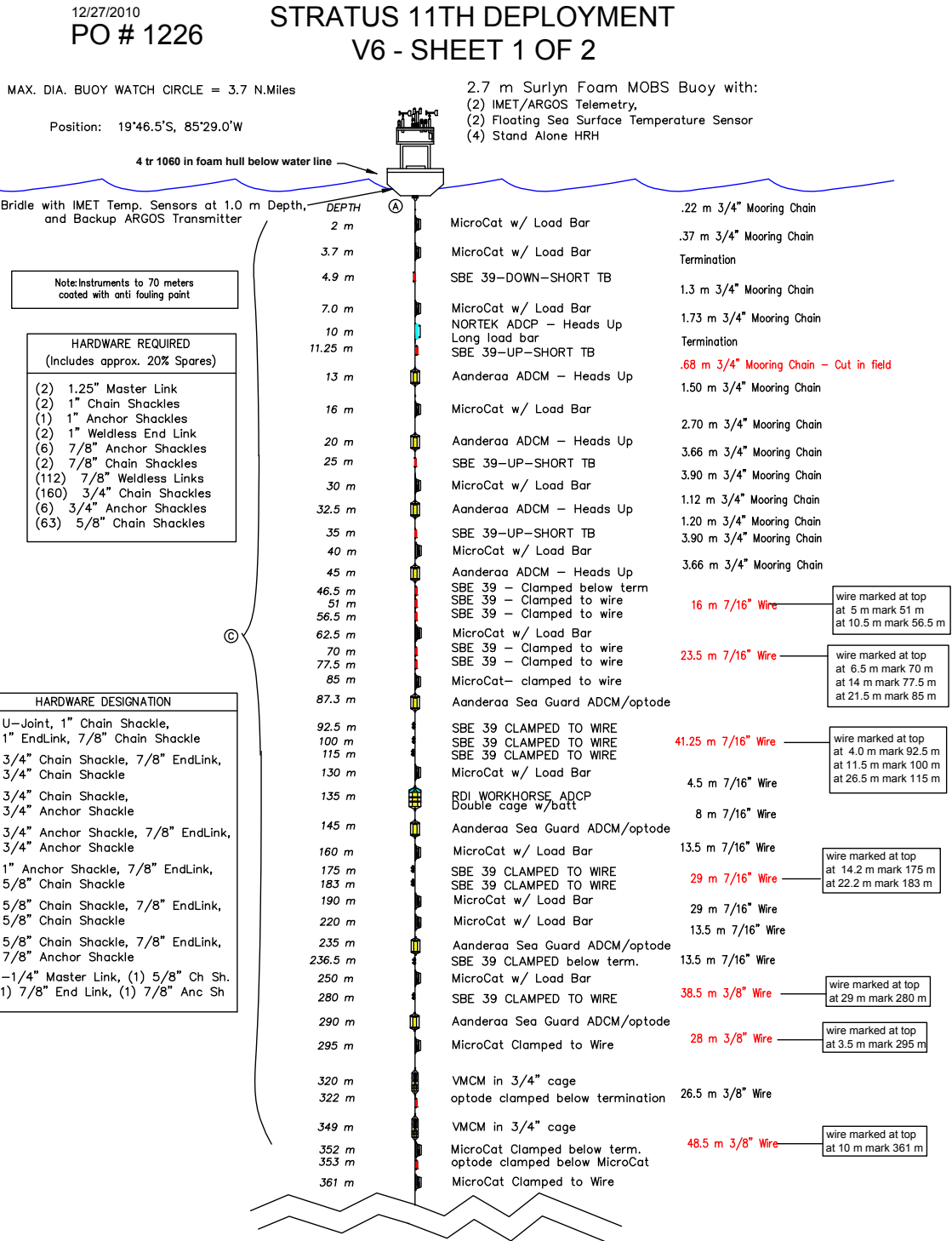

Figure 4-1. Stratus 11 mooring diagram.

STRATUS 11TH DEPLOYMENT
V6
SHEET 2 OF 2

CONTINUED AFTER 48.5 METER SHOT OF
WIRE AT 400 METERS

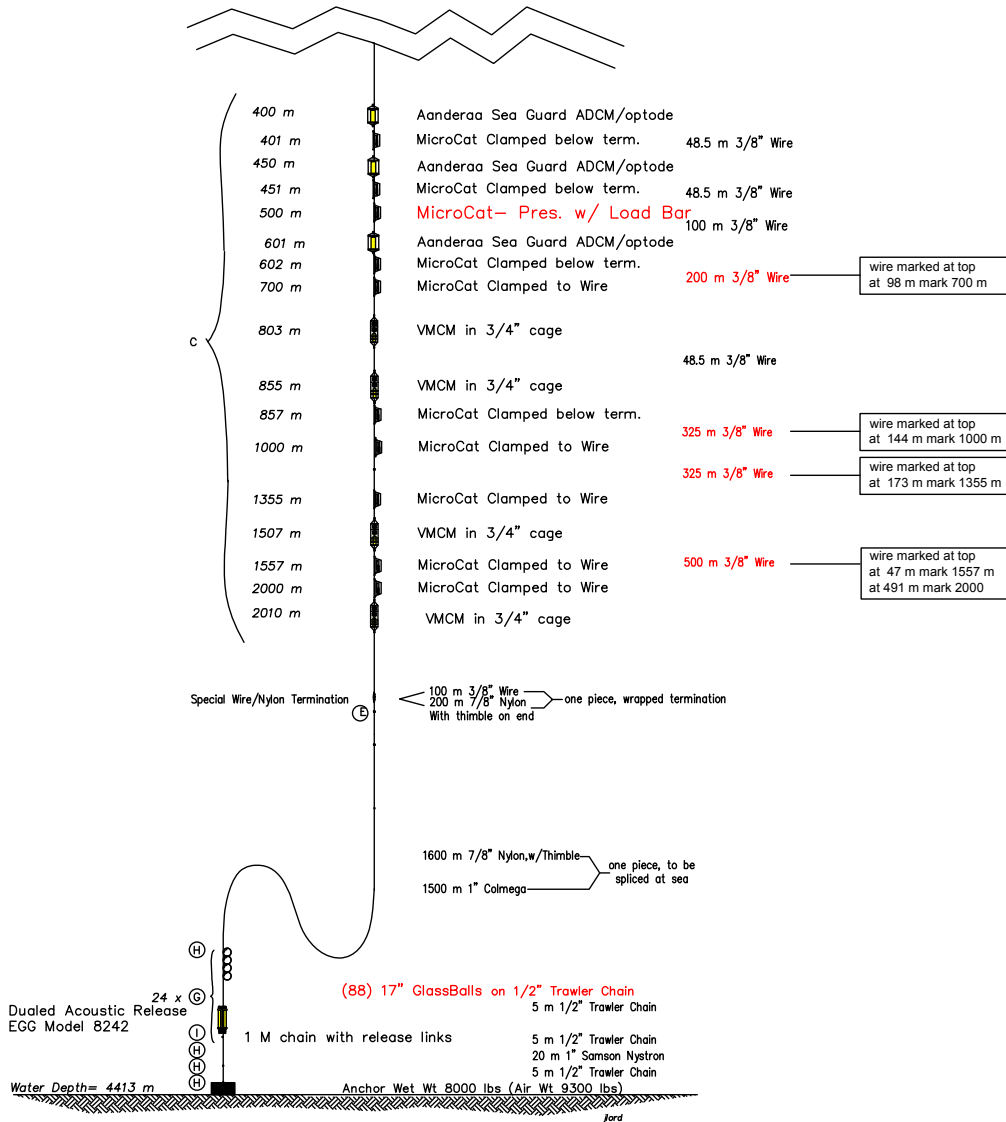

Figure 4-1, continued.

A. Recovery

The Stratus 11 mooring was recovered on May 29, 2012. To prepare for recovery the Melville was positioned roughly ¼ mile to the side of the anchor position, with the buoy streaming down wind. The release command was sent to the acoustic release to separate the anchor from the mooring line. After about 40 minutes, the glass balls surfaced. Once the glass balls were on the surface, the ship approached the cluster of balls along the starboard side. The ship's rescue boat was deployed to connect a lifting sling into the glass ball cluster. A messenger line was used to pass the lifting line from the ship to the rescue boat, where the lifting sling and lifting line were shackled together. The rescue boat was recovered before the recovery commenced.

The winch hauled in as the ship steamed ahead to get the balls lined up behind it. At this point, the ship was towing the glass balls from the winch, with the rest of the mooring trailing behind. With the A-frame fully outboard, the glass balls were slowly lifted from the water. The A-frame was brought inboard as the winch hauled in, lifting the cluster of glass above the deck. Three air tuggers were used to stabilize the cluster, and haul it forward. When the cluster was clear of the transom; it was lowered to the deck. A stopper line was used to secure the chain hanging over the stern with two acoustic releases attached to it. Another stopper line was connected to the thimble on the end of the Colmega line. The winch was disconnected from the glass ball cluster, and shackled to the release chain. The chain was disconnected from the glass ball cluster, and the winch hauled in to get the releases onto the deck.

The glass balls were disconnected and hauled to the starboard side to be lifted by crane into the ragtop container on the main deck. The ship continued to steam slowly into the wind during this operation. Once the deck was clear, a traveling block was hung from A-frame, using the large air tugger to adjust the height. A working line was tied to the 1" Colmega line, led through the block, and wrapped onto the high speed capstan. The 1500m of Colmega, and 1600m of 7/8" nylon were hauled in and fed into three wire baskets.

Hauling stopped at the end of the 1600-meter shot of nylon. Stopper lines were connected into the link between the 1600 and 200-meter shots of nylon and made fast to the deck cleats. The mooring load was then transferred from the capstan to the stopper lines. The shackle to the 1600-meter shot of nylon was removed. The winch then took the load and the stopper lines were removed. The winch continued recovering the mooring.

The traveling block was hung from the a-frame. The a-frame was positioned about 3 feet forward of the stern. The winch hauled in the wire. The first instrument was stopped about 3 feet above the deck. Two stopper lines were hooked into the sling link and made fast to the deck cleats. The winch was payed out slowly to lower the instrument to the deck. The instrument was disconnected from the hardware and moved to a staging area for pictures. The wire rope from the winch was then shackled to the load. The winch took up the slack and the stopper lines were eased off and then cleared. Hauling continued until the next instrument.

The above procedure was continued throughout the recovery operation until the Aanderaa current meter at 45 meters was recovered. Once the current meter was recovered, a slip line, passed through the link at the bottom of the 3.66m chain was used to set the buoy and remaining 40 meters of instruments adrift.

Once the buoy was set adrift from the stern recovery operation, The Melville launched its rescue boat slowly to attach a lifting sling to the buoy. The ship approached buoy, keeping it along the port side of the ship. While the ship was maneuvering, tuggers and deck equipment were readied for the final recovery. The port crane was positioned above the recovery area. As the ship maneuvered by the buoy, a messenger line was thrown to the rescue boat and tied into the lifting sling attached to the buoy. The line and buoy were pulled in towards the ship. The sling was hooked into the block of the crane. The crane lifted the buoy from the water and swung inboard so the buoy would rest on the side of the ship. A tugger line was attached to a buoy deck bale, and a steadying line was looped through the crash bar on the tower on the buoy. The buoy was hoisted up and then swung inboard while the tugger and line kept the buoy from swinging.

Once the buoy was on deck aircraft straps were used to secure the buoy. A stopper line was used to stop off on the 0.37 m shot of 3/4" chain between the first and second instruments. Tugger lines were removed from the buoy. The shackle was disconnected from the universal plate on the bottom of the buoy.

A 6-foot sling was placed through the link at the top of the first instrument and hooked in the crane's hook. The crane took the load, and the stopper line was eased off and cleared. The crane hoisted the first two instruments and the tugger line with chain hook line was attached a section of chain and pulled tight. A safety stopper was attached to the link below the instruments hanging from the crane. Once the tugger had the load, the crane lowered the instruments to the deck. The instruments were disconnected and the crane was repositioned over the load. The sling was placed through the sling at the top of the remaining instrument array hooked into the crane. The crane took the load and the tugger and safety stopper lines were eased off and cleared. The crane lifted the next section of instruments and the above procedure was repeated to recover the remaining instruments.

B. Stratus 11 data return

1) Subsurface record inventory

Figure 4-2 to 4-12 give an overview of the data recovered from subsurface instrumentation on Stratus 11 (for location of sensors, see Figure 4-1). Deep VMCMs and the RDI Workhorse stopped recording data 7 and 9 months after deployment, respectively.

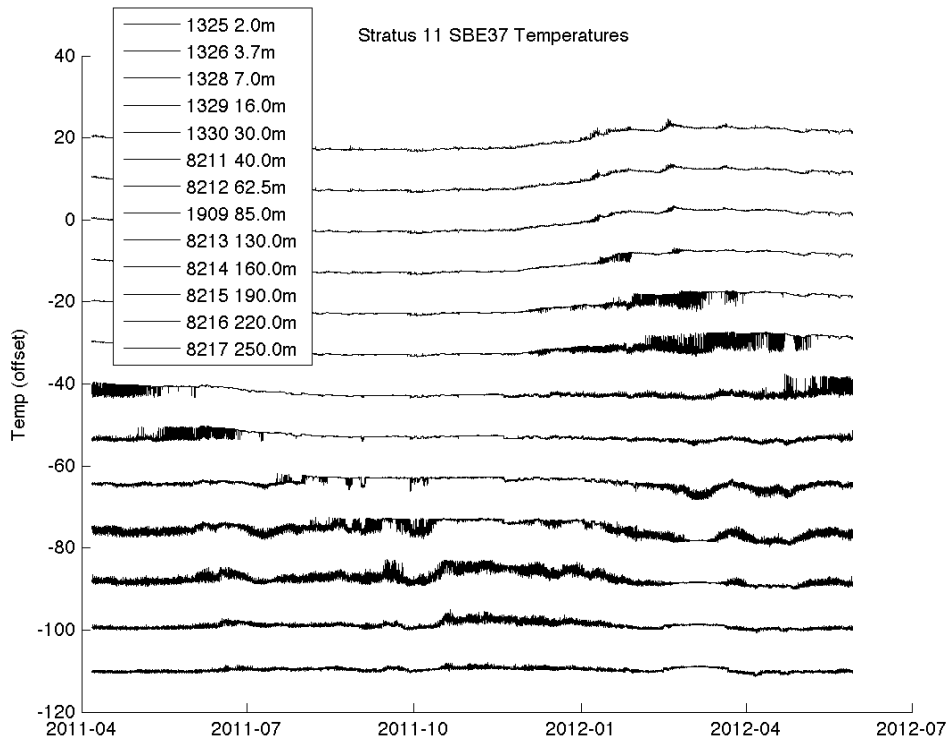

Figure 4-2. Stratus 11 SBE 37 temperature data return.

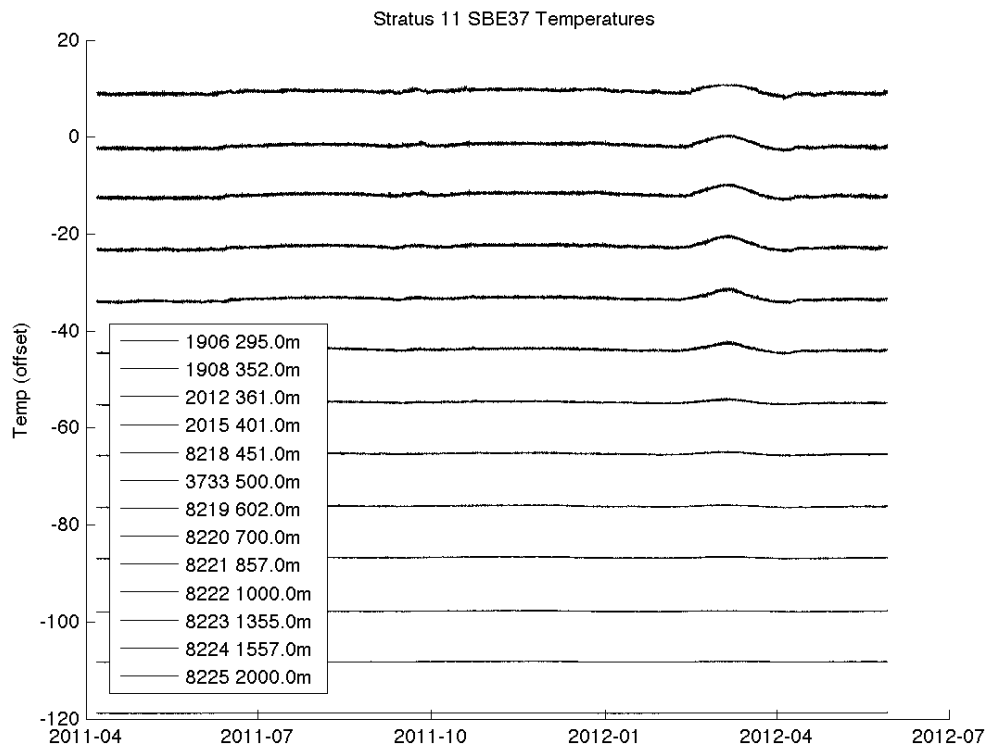

Figure 4-3. Stratus 11 SBE 37 temperature data return (deep sensors only).

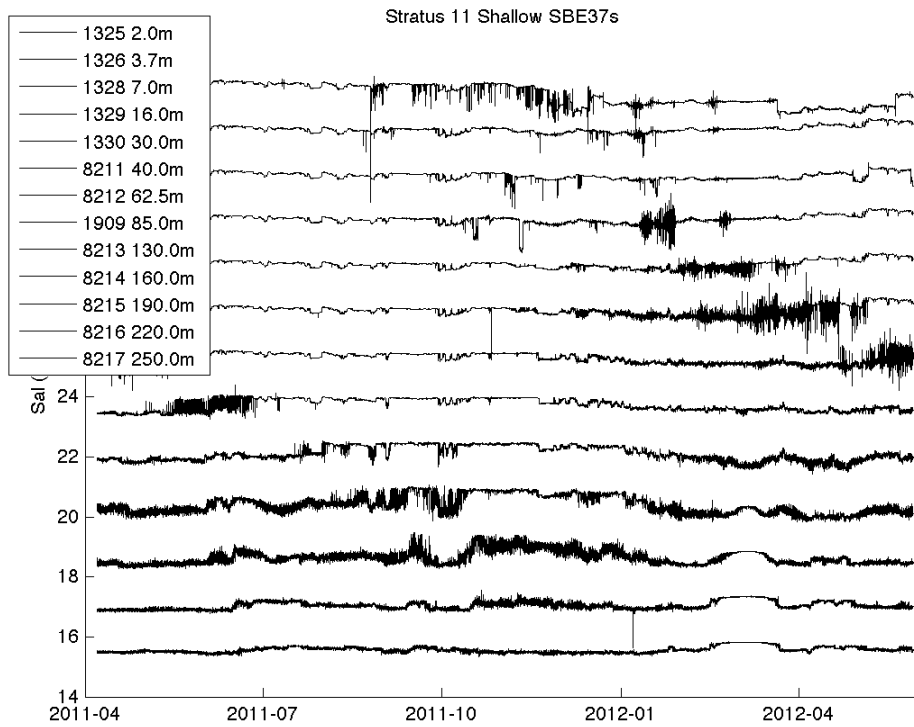

Figure 4-4. Stratus 11 SBE 37 salinity data return.

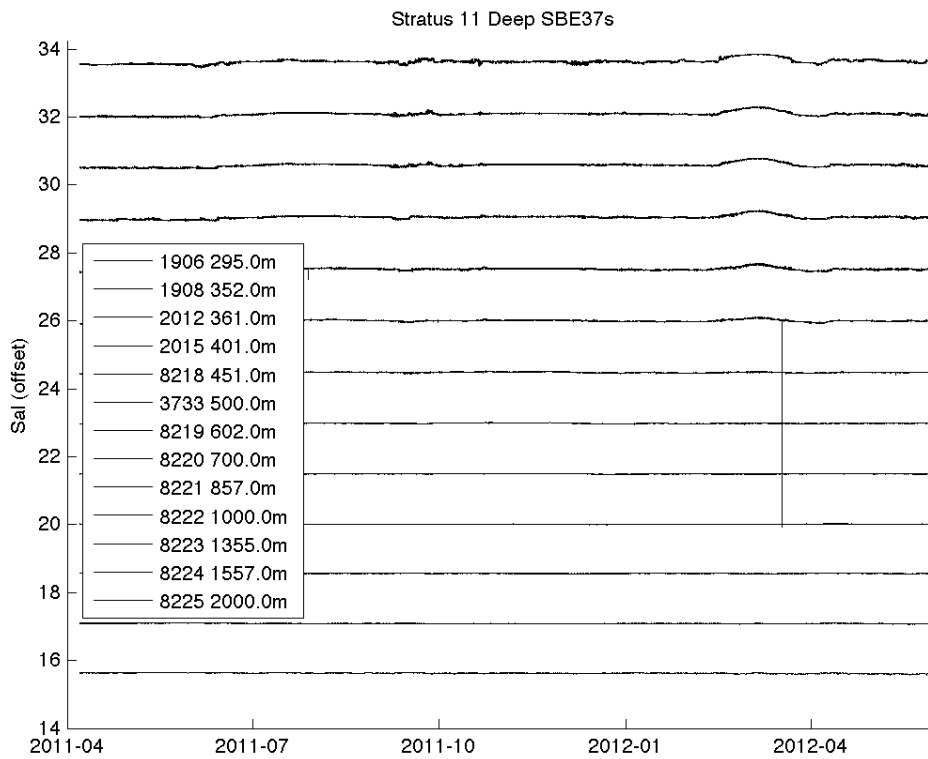

Figure 4-5. Stratus 11 SBE 37 salinity data return (deep sensors only).

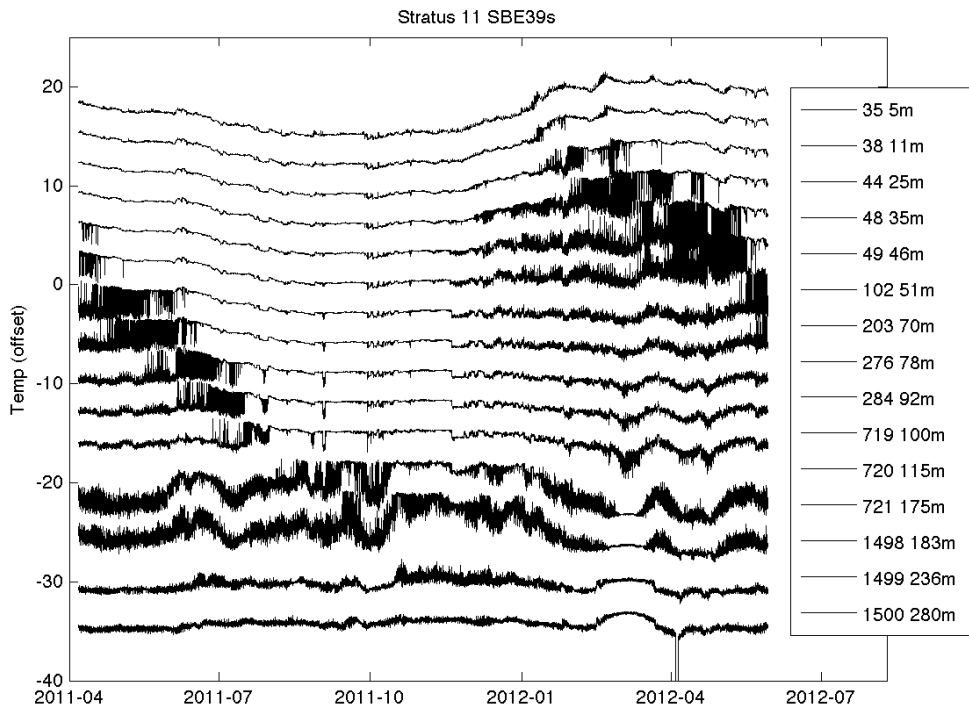

Figure 4-6. Stratus 11 SBE 39 data return.

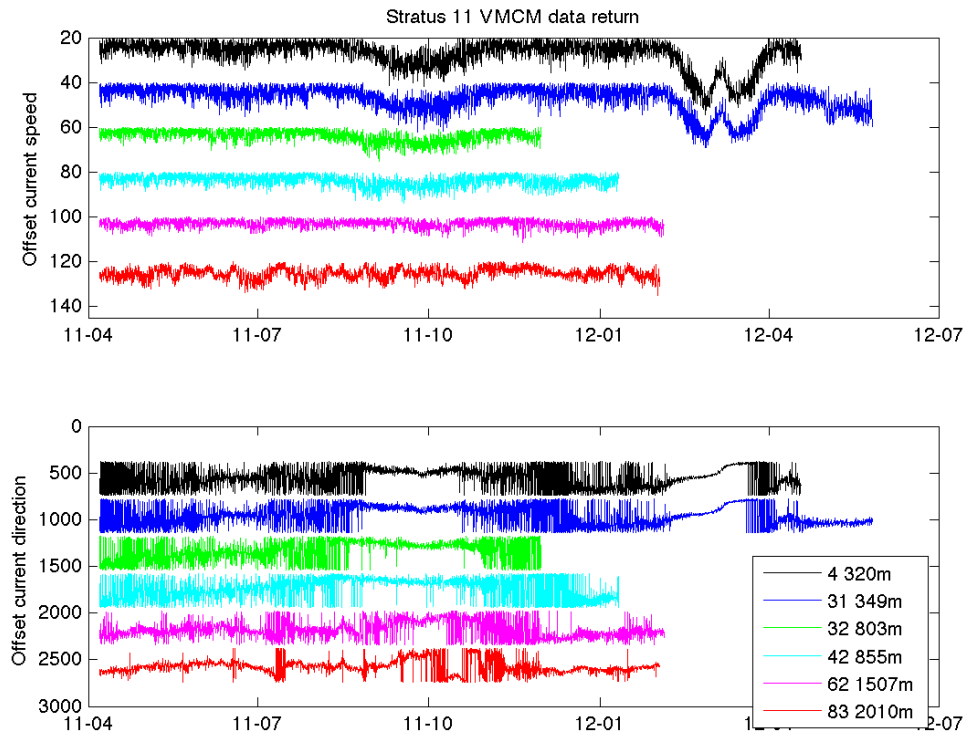

Figure 4-7. VMCM data return on Stratus 11.

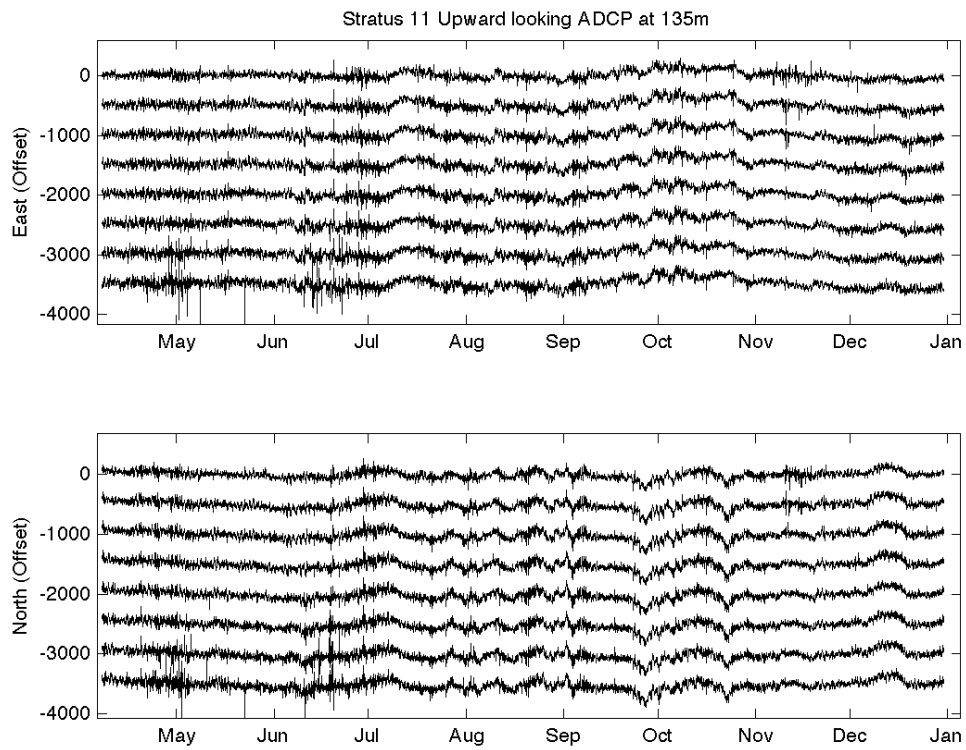

Figure 4-8. Stratus 11 RDI ADCP velocity (U,V) data return.

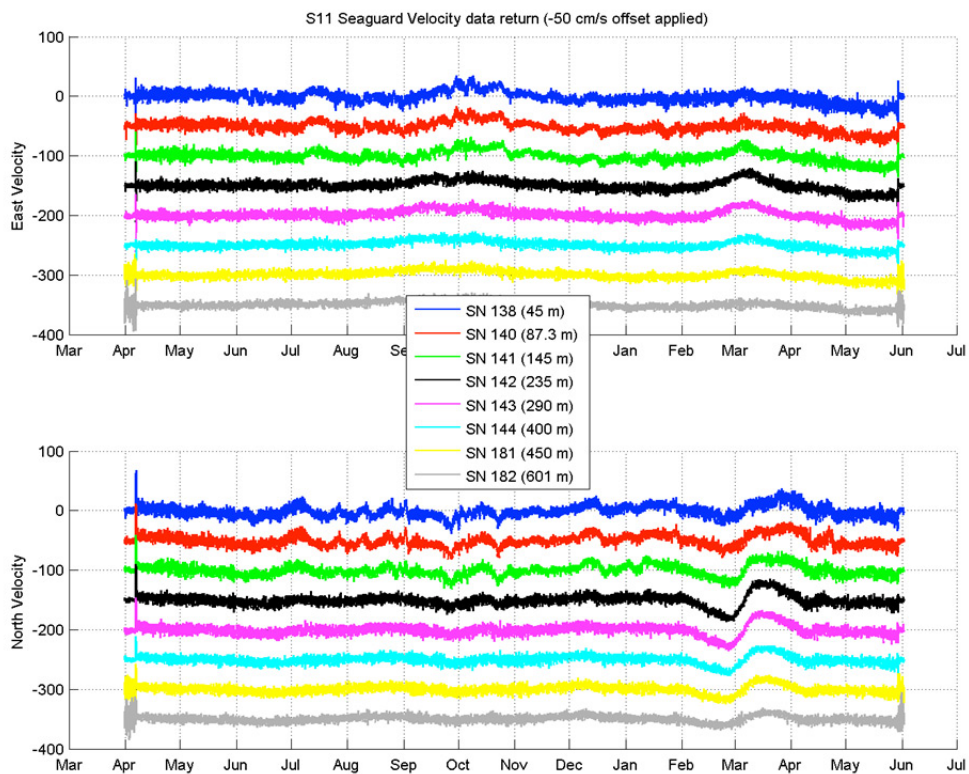

Figure 4-9. Seaguard velocity data return on Stratus 11.

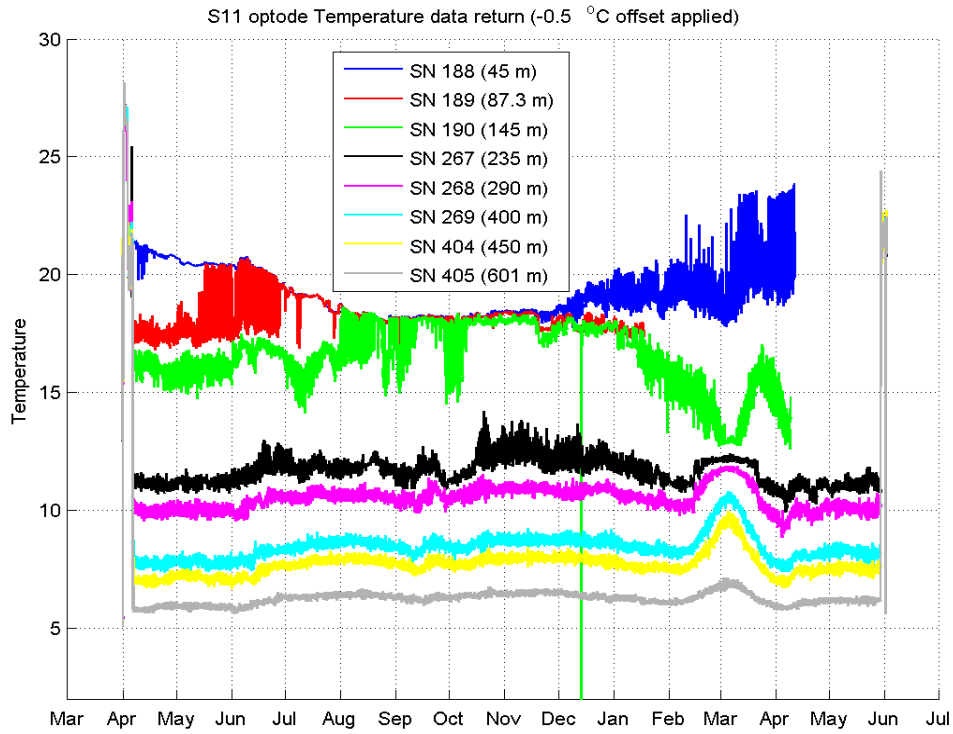

Figure 4-10. Optodes temperature data return on Stratus 11.

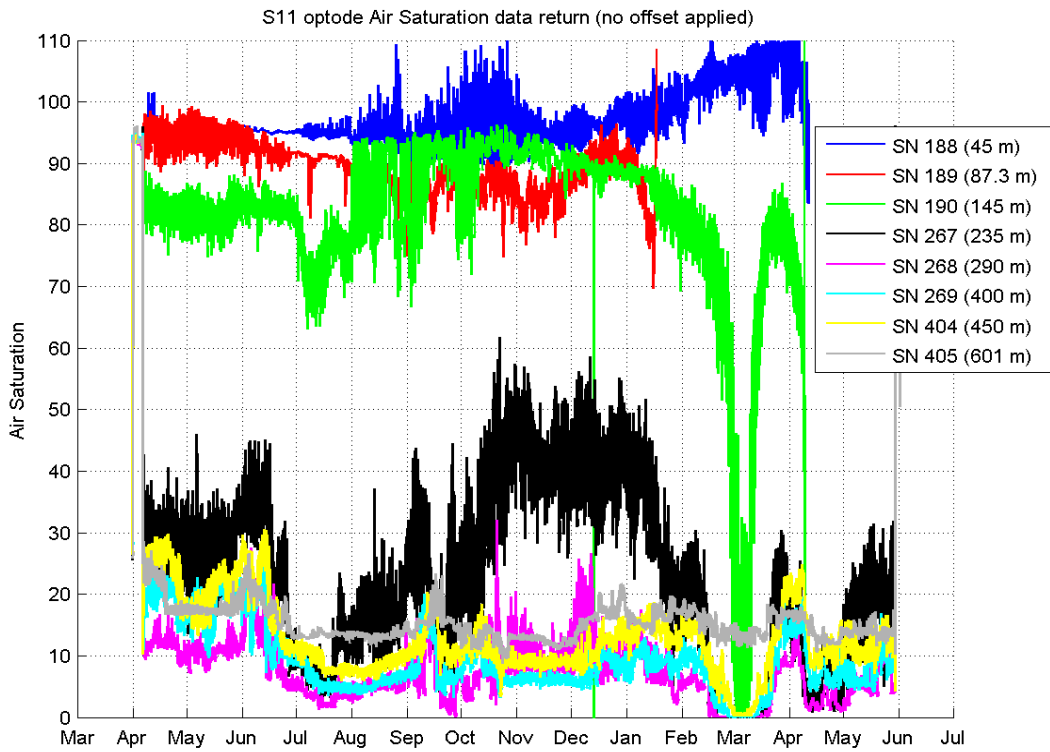

Figure 4-11. Optodes oxygen saturation data return from Stratus 11.

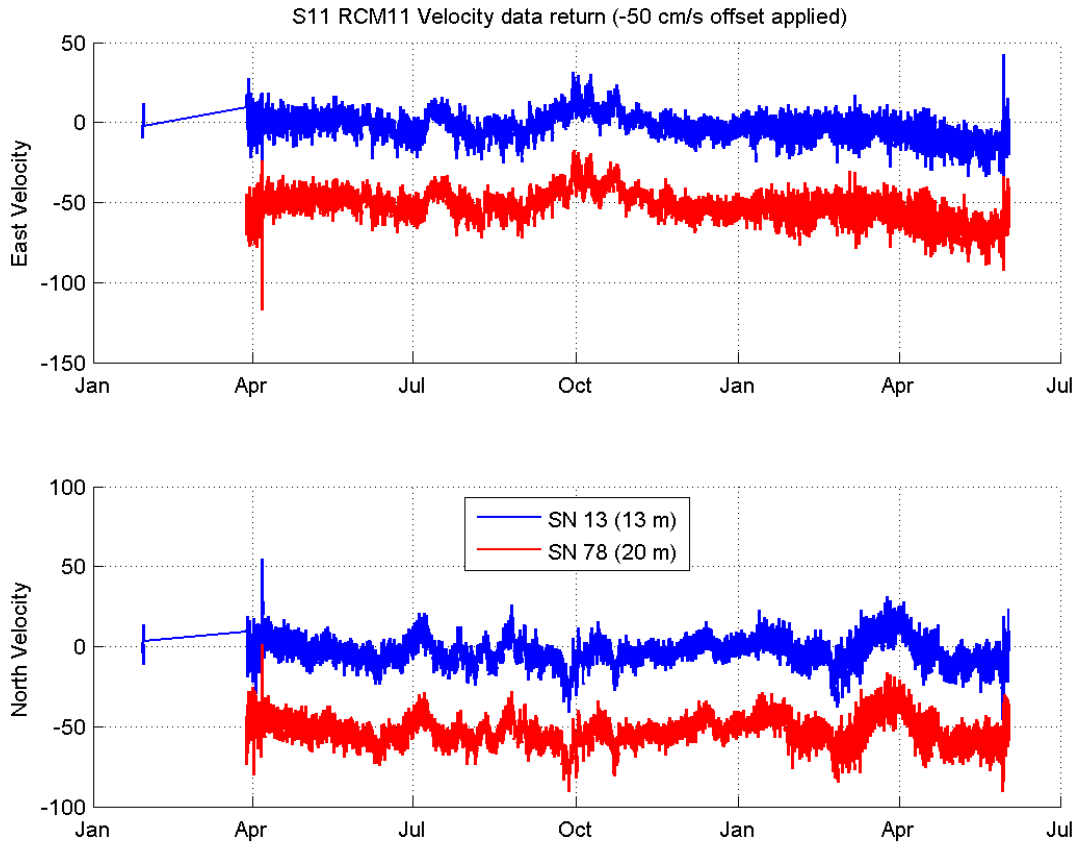

Figure 4-12. RCM velocity data return on Stratus 11. Data from RCM#79 (at 32.5 m depth) was not processed at time of publication. Note also that, temperature (not shown) from RCM#13 was suspiciously low, and maybe calibration coefficients needed to be checked.

2) ASIMET surface record inventory

ASIMET data from the two loggers on Stratus 11 buoy are shown in Figures 4-13 to 4-16 and indicate a full record for the whole deployment's duration. Lascar sensors had a similar data return (Fig 4-17).

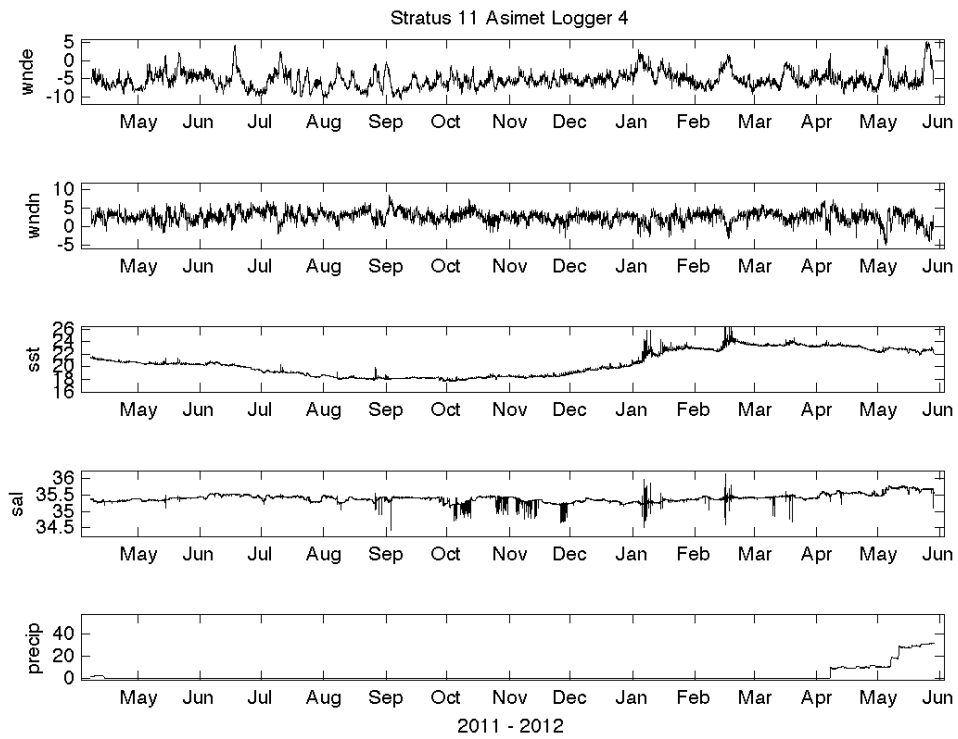

Figure 4-13. Stratus 11 ASIMET wind, SST, salinity and rain records on logger 4.

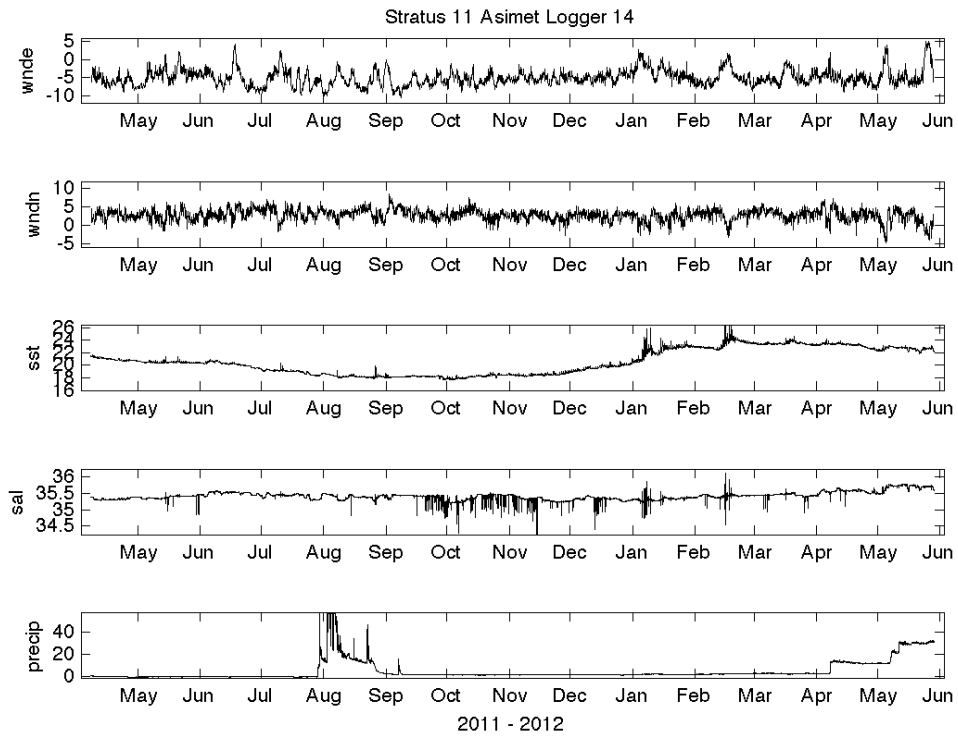

Figure 4-14. Stratus 11 ASIMET wind, SST, salinity and rain records on logger 14.

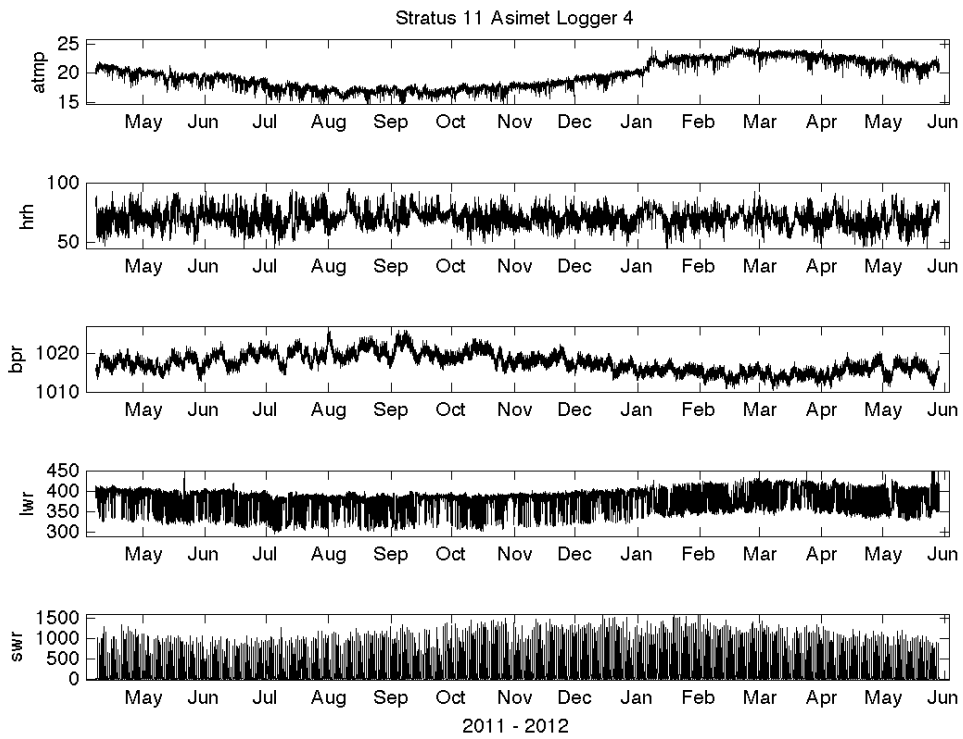

Figure 4-15. Stratus 11 ASIMET air temperature and humidity, barometric pressure longwave and shortwave downwelling radiations records on logger 4.

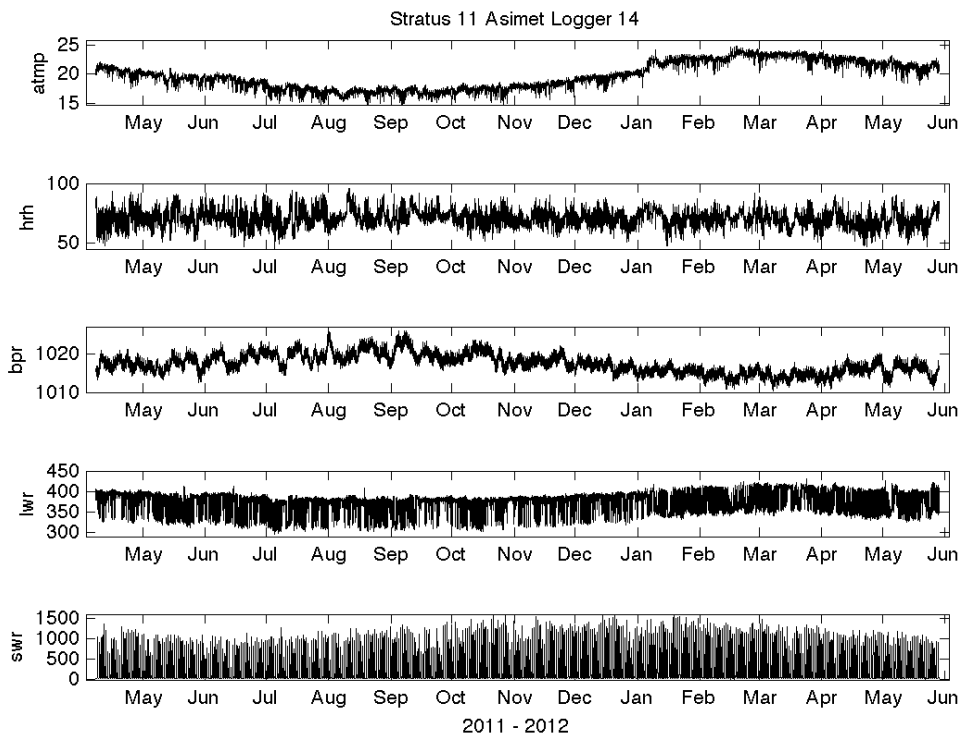

Figure 4-16. Stratus 11 ASIMET air temperature and humidity, barometric pressure longwave and shortwave downwelling radiations records on logger 14.

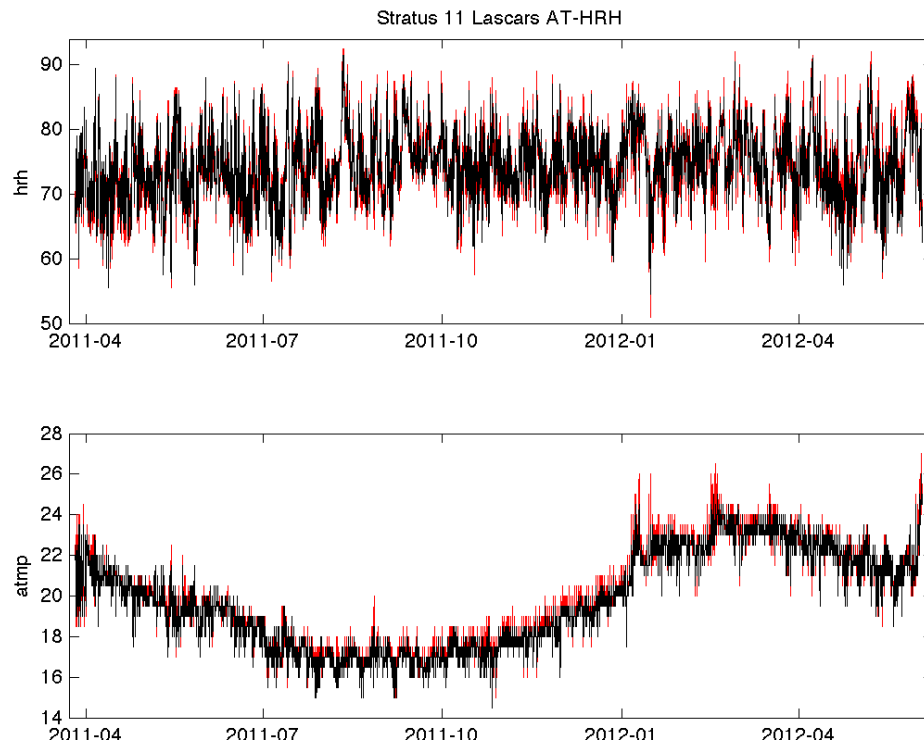

Figure 4-17. Stratus 11 air temperature and humidity record from Lascar sensor.

V. Ancillary Projects

A. Hydrography: UCTD and CTD

1) Operation

The UCTD is an underway system for acquiring conductivity and temperature profiles at ship speeds up to 13 knots. During the Stratus 12 cruise aboard the R/V *Melville*, the range of velocities was between 10.6-12.6 knots and it was possible to do UCTD-profiles between depths of 350 to 400 m in almost all cases. The sampling was conducted from the aft portion of the stern deck. A length of line equal to the desired cast depth was wound onto the CTD's tail spool (~500 m). While the ship steamed away from the drop site, the probe plunged vertically with a nearly constant drop rate independent of the ship's speed. Line was spooled automatically off the probe's tail by gravity while it dropped through the water and line tension allowed for pay out from the winch spool as the ship moved away from the drop point. The simultaneous pay out of line from the probe's tail and winch effectively made the line horizontal velocity through the water zero, allowing free fall.

The CTD probe sampled conductivity, temperature, and depth at a sampling rate of 16 Hz while descending vertically through the water column at ~ 4 m/s. Data was stored internally in flash memory and downloaded wirelessly via Bluetooth to a host computer after recovery.

The latitude and longitude of individual casts were obtained by matching an internal time stamp in the data file header to an externally collected GPS file. Synchronization of instrument and GPS time was important.

We deployed two UCTD (#29 and 30) probes on the Stratus 12 cruise. Probe 29 was used to collect 79 profiles and the probe 30 was used in 52 profiles (Figure 5-1). These profiles were measured every hour on a course between 30°S to 7°S.

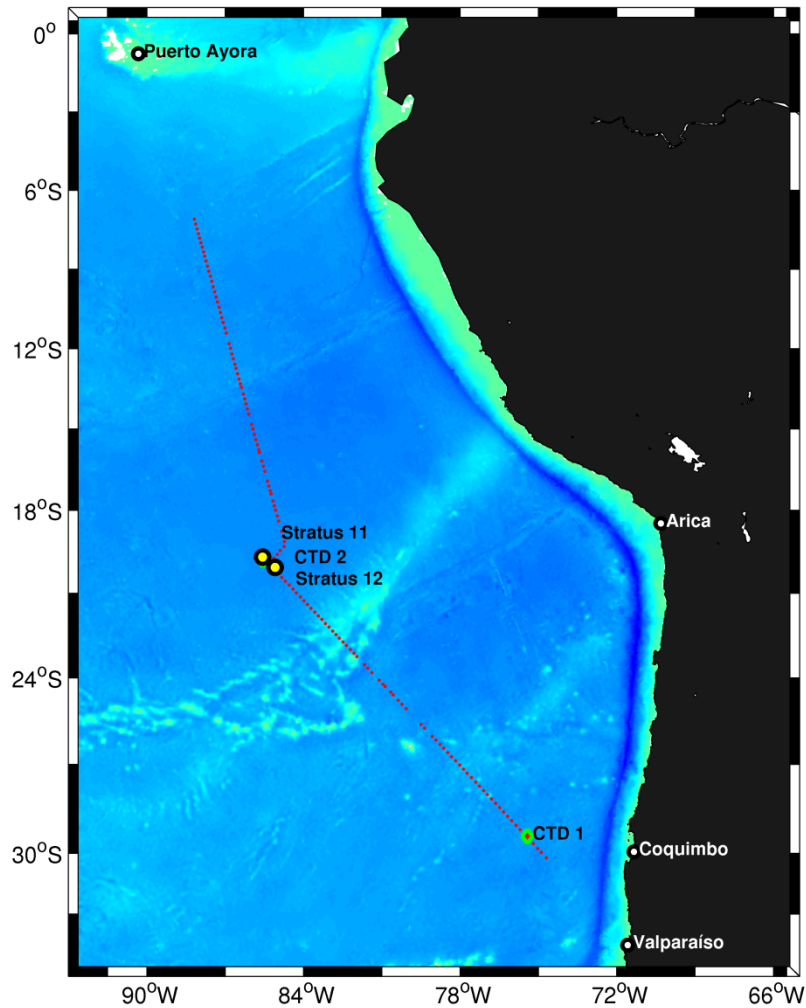

Figure 5-1. Locations of UCTD and CTD casts during the Stratus 12 cruise onboard R/V *Melville*.

2) CTD Sensor Specifications:

The temperature sensor is designed for a range between 5 to 43°C. Conductivities can be measured from 0 to 9 S/m, and the pressure range is 0 to 2000 m. The pressure housing is rated for a depth of down to 2000 m although the operating depth is normally less than 1000 m. According to the manufacturer, typical accuracies of the processed data are 0.005-0.02°C for temperature, 0.002-0.005 S/m for conductivity, 1 dbar for pressure, and 0.02-0.05 PSU for salinity. For more information about the UCTD, see <http://www.oceanscience.com/uctd.html> and also Rudnick and Klinke (2007).

3) UCTD conductivity

Data were processed using Matlab scripts. The first 10 m of data were eliminated because of noise generated by the stern of the ship. Above 10 m the UCTD data was comparable with the ship's thermosalinograph data which measured near surface water properties throughout the cruise. Both series of data, from the ship and from the probes, were closely aligned when the probes were first deployed, but profiles collected by the probes diverged progressively from the ship data with continued use. Towards the end of their use the probes displayed an apparent salinity bias error, with a difference of salinity ~ 0.2 PSU (Figures 5-2 and 5-3). In the laboratory, we observed a difference in conductivity values between thermosalinograph data and the probe 29, of -0.034 S/m (Figure 5-4). This correction was apply to the probe 29 data after the date that the data diverged significantly from that of the thermosalinograph (26-May-2012 14:02) (Figures 5-2 (lower panel), and 5-3). A laboratory calibration of probe 30 was not possible due its loss during sampling (at $\sim 7^\circ\text{S}$).

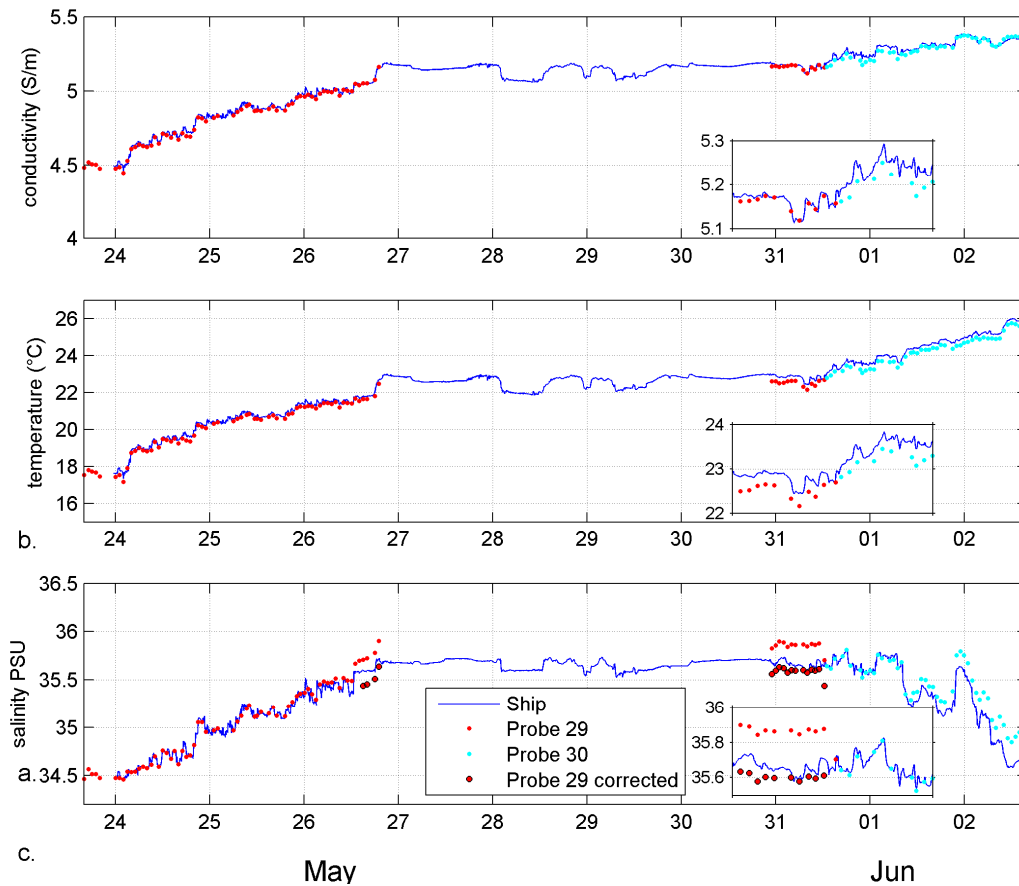

Figure 5-2. Time series of conductivity (a), temperature (b) and salinity (c) during the Stratus 12 cruise. Data from ship's thermosalinograph (blue line), UCTD probe 29 (in red points), UCTD probe 30 (in cyan points) and probe 29 data with an apparent correction (red circles with contour).

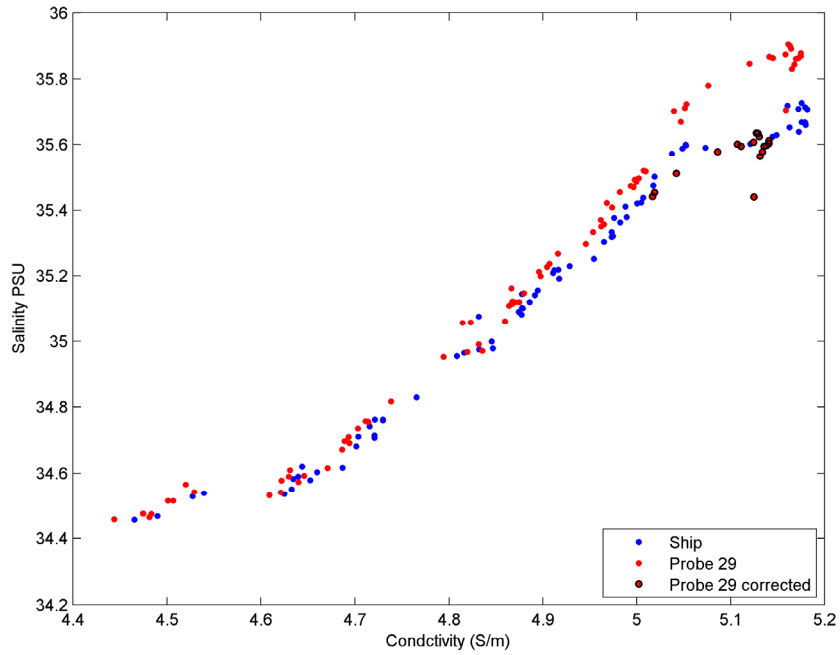

Figure 5-3. Conductivity vs. salinity of the thermosalinograph ship data (in blue circles), UCTD probe 29 (in red circles) and UCTD probe 29 with an apparent correction in conductivity (in red circles with contour).

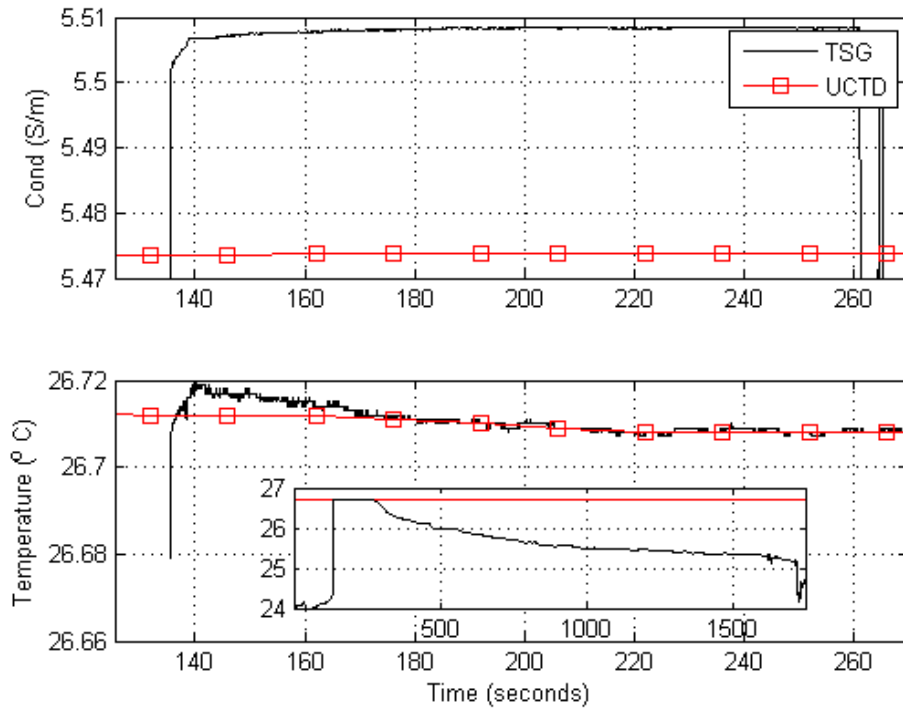

Figure 5-4. Comparison between thermosalinograph and UCTD conductivity and temperature data in the lab. The UCTD probe was placed vertically in the sink in the wet lab and flushed with the water output from the thermosalinograph at a fairly elevated and constant rate for several minutes.

4) UCTD data processing

i) Removal of outliers

There are two steps to remove outliers; using a mathematical criteria and removing manually the outliers with an appropriate script. Before the first of these steps a median filter of 5 poles was used to smooth the raw data. Then, (similar to the step “WildEdit” in SBE Data Processing), the following inequality was used on all the variables:

$$\text{If } M_i - \bar{M} > 2 \left(\frac{\sum M_i - \bar{M}}{N - 1} \right) \Rightarrow M_i = \text{NaN},$$

where M_i is the i -th value of the data time-series, \bar{M} is a bin average, N is the length of the bin and NaN denotes “Not A Number”.

Given a window of 300 values, if the distance between the value and the bin average is greater than 2 times the standard deviation, a NaN value will be assigned. To avoid that some outliers could be hidden by more extreme ones, the formula was applied twice. The optional second step, which manually selects outliers for removal was not applied. This selection process is achieved by defining an area with two points and assigning NaN values to all points within the selected zone.

ii) Cell thermal mass

Thermal inertia correction was applied to conductivity because of the existence of intense vertical gradients in temperature. The sensor perceived these changes at a lag because its glass, internal walls have high thermal capacity and are insulating. The correction was proposed by Lueck (1990) and is based on two main parameters: $\tau = 1/\beta$ the temperature anomaly nudging, and a the temperature error. Then, the conductivity correction is given by:

$$C_T(n) = -b \cdot C_T(n-1) + \gamma a [T(n) - T(n-1)],$$

where

$$a = 4 \cdot f_n \alpha \beta^{-1} (1 + 4 \cdot f_n \beta^{-1})^{-1}$$
$$b = 1 - 2 \cdot a \alpha^{-1},$$

with n is the index profile, γ is the conductivity sensibility and f_n the Nyquist frequency (8 Hz here).

Mensah et al. (2008) show that the conductivity corrections are dependent on the intensity of the gradients in the water column. In the data, gradients of 5° in 5-10 m were observed, which makes this correction very useful. Mensah et al. (2008) improve the estimation of the constants, which yields $\alpha = 0.0132$ and $\beta = 0.0829$.

iii) Alignment

The alignment consists of matching the water parcels with the corresponding cast measurements to obtain reliable values of salinity and density.

The temperature data was aligned 0.09 [s] relative to pressure. On the other hand, conductivity used a time delay of -0.1 [s] relative to pressure, this eliminated the negative salinity spikes.

iv) Removal of pressure inversions

In order to improve the consistency in the downcast data, the tugging of tides and surface currents, which produce pressure inversions, were removed.

v) Filter

A low-pass filter was applied to all the variables to eliminate the high frequency noise in the data. A moving average filter of 4 poles was used according to recommendations from the factory.

vi) Derivation

Variables of salinity and density were estimated using the toolbox routines of SeaWater version 3.3.

vii) Bin average

All the variables are averaged for each bin of 0.5 m length, which means an approximately two samples average.

To demonstrate the correction up to this point a comparison is shown between the corrected and uncorrected data (Figure 5-5). It is possible to see that the spikes are removed, along with the inversions, and also that the data is smoothed.

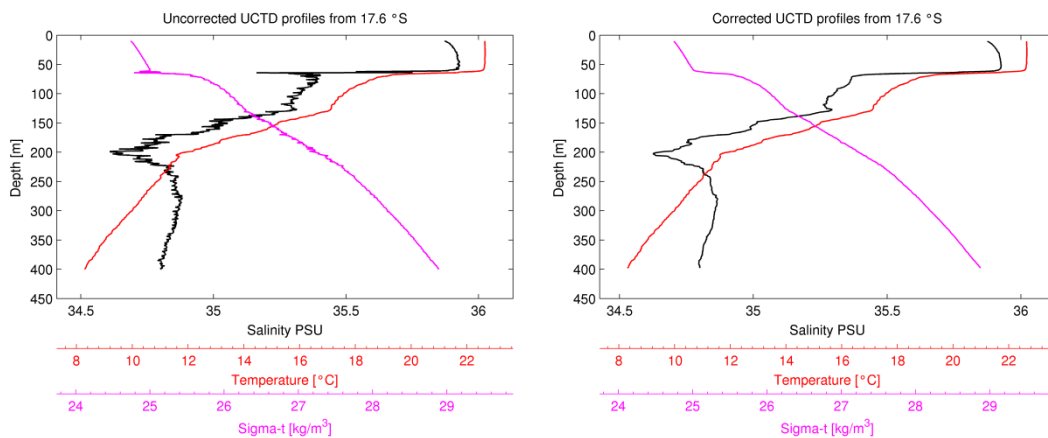

Figure 5-5. UCTD-profile uncorrected (left) and corrected (right).

5) Results

The Stratus 12 cruise consisted of two parts. The first part started on the Chilean coast from the port of Valparaíso (33°S) went to the Stratus 11 buoy. The second part was from the Stratus 12 buoy to the Galápagos Islands.

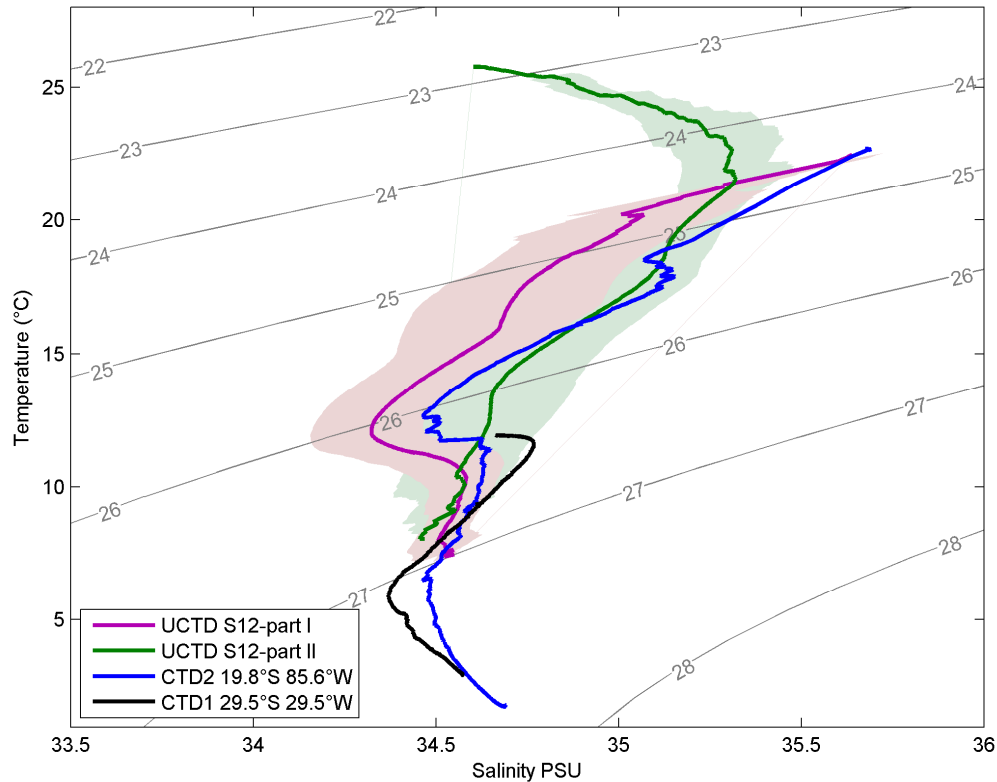

Figure 5-6. TS-diagram from UCTD Stratus 12 cruise, part I (magenta line) and part II (green line), northern CTD station (blue line) and southern CTD station (black line). Shading patch indicates the standard deviation of different UCTD-profiles, part I and II.

To analyze the data a TS-diagram was used. Different sources of data were used: UCTD-part I, UCTD-part II, CTD1 at 29.5°S, 75.5°W and CTD2 at 19.8°S, 85.6°W. The UCTD profiles were averaged using a function of density (Figure 5-6). Figures 5-7 and 5-8 show UCTD profiles as functions of latitude.

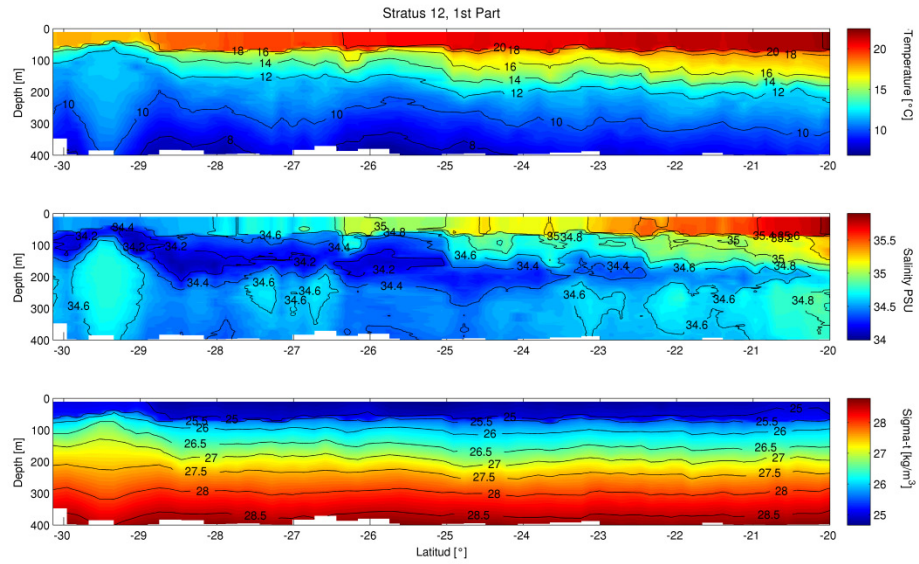

Figure 5-7. UCTD-profiles during Stratus 12 cruise, part I

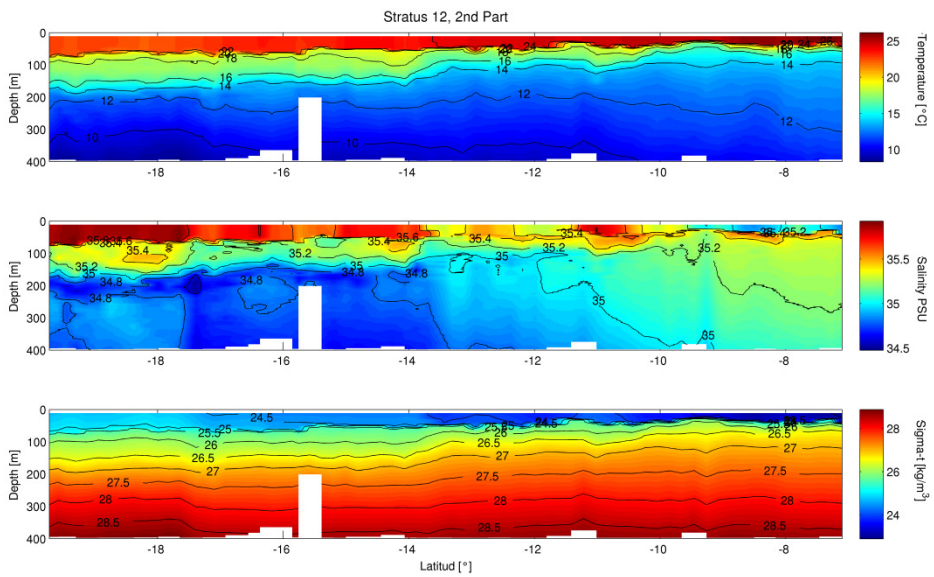

Figure 5-8. UCTD-profiles during Stratus 12 cruise, part II

B. Ship ADCP

For Stratus 12 R/V Melville's 75 kHz Ocean Surveyor ADCP was run in narrowband mode with a vertical bin spacing of 8 m. The files used to produce these figures were pulled from the ship's repository for processed ADCP files; the files contain 5-minute averaged data. No additional processing was performed. The ship's satellite position feed was lost at the start of leg two, hence the data gap. The near-surface (upper 50 m) signal was much noisier during the first leg of the cruise than in the second.

In general, the ADCP captured widely varying currents during the cruise, perhaps caused by the region's eddy field. The most notable features in the ADCP data were two anticyclonic eddies with strong velocity and hydrographic signatures (Figure 5-9). The velocity core of the first eddy, at 29.5 S, 75.5 W, penetrated to 450 m and reached speeds of 0.6 m/s. The second eddy, at 9.5 S, 87.5 W, had a much smaller velocity core, extending only from 50 to 150 m, with maximum speeds of approximately 0.3 m/s. Both eddies also featured low stratification between the 26.0 and 26.5 kg m^{-3} isopycnals (evident as bulging isopycnals in the ADCP plots), a common characteristic of anticyclonic eddies in the southeast Pacific.

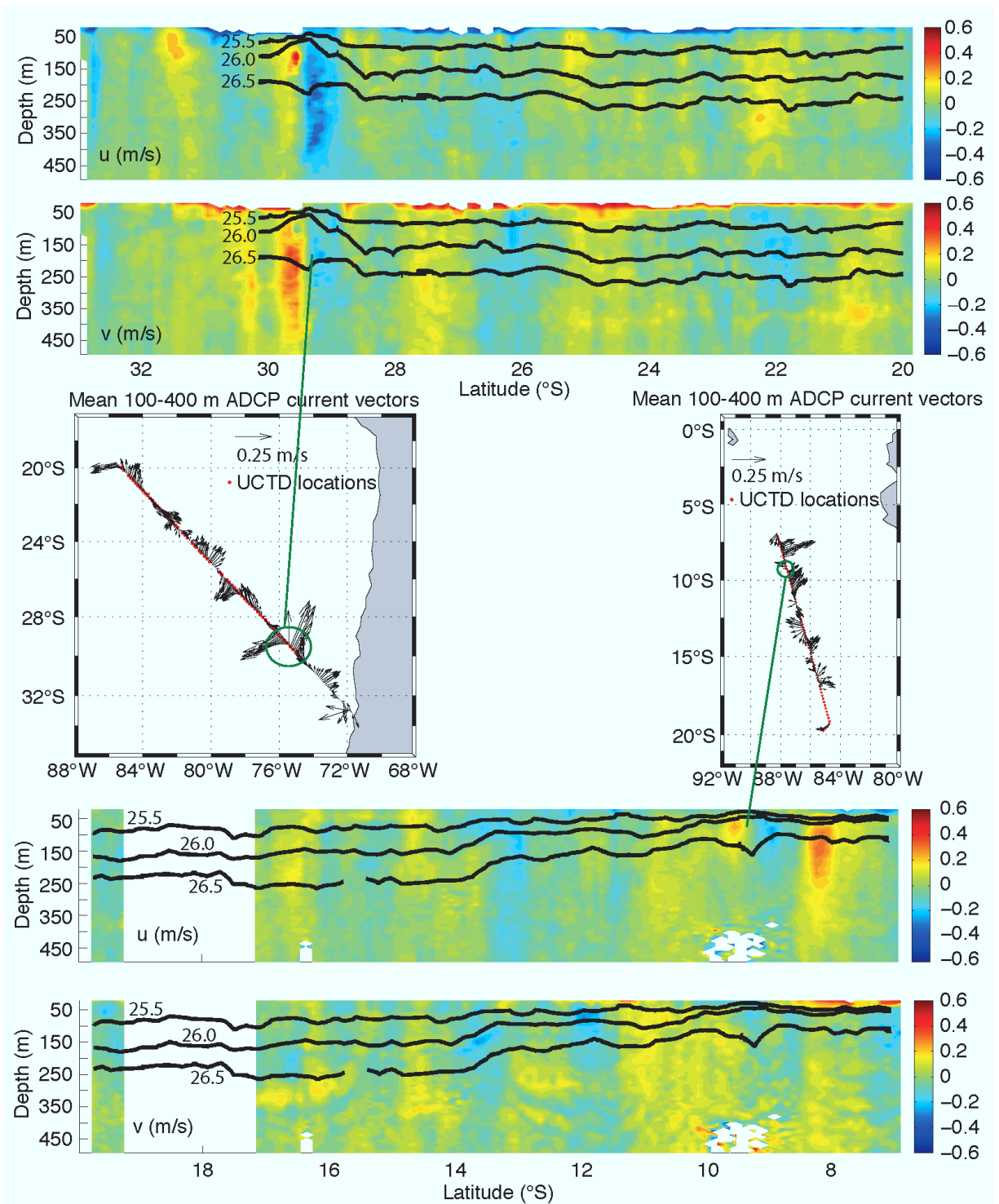

Figure 5-9. Sections of u and v for the two cruise segments. The top two panels are for leg 1, from Valparaiso to Stratus; the bottom two panels are for leg 2, after leaving Stratus. To make the section plots the 5-minute velocities were averaged into bins of 0.1 degree latitude. Potential density from the UCTD was contoured along the 25.5, 26.0, and 26.5 kg m^{-3} isopycnals. For the maps, the 5-minute velocities were averaged between 100 and 400 m. The anticyclonic eddy locations are marked by green circles.

C. Deployment of Argo Floats and Drifters

During the Stratus 12 cruise, a 24-hour under way watch schedule was established. Watch standers were responsible for UCTD casts, and for Argo floats (Table 5-1, Figure 5-10) and surface drifter deployments (Table 5-2, Figure 5-12).

Table 5-1. Location and times of the launches of the Argo floats deployed during the Stratus 12 cruise.

	float ID	START DATE/TIME (UTC)	DEPLOY DATE/TIME (UTC)	DEPLOYMENT POSITION
1	7037	5/22/12 20:10	5/24/12 2:47	28 56.2 S 75 59.5 W
2	7038	5/22/12 20:10	5/31/12 0:00	18 05.7 S, 85 02.3 W
3	7029	5/22/12 20:10	5/31/12 19:06	16 06.24 S, 85 37.19 W
4	7027	5/22/12 20:10	6/1/12 6:25	14 04.68 S, 86 12.26 W
5	7034	5/22/12 20:10	6/1/12 17:33	12 04.97 S, 86 46.48 W
6	7039	5/22/12 20:10	6/2/12 3:50	10 03.53 S, 87 20.94 W
7	7031	5/22/12 20:10	6/2/12 14:32	08 04.37 S, 87 54.54 W
8	7026	5/22/12 20:10	6/2/12 18:00	07 04.20 S, 88 11.661 W
9	7040	5/22/12 20:10	6/3/12 2:32	06 05.46 S, 88 27.89 W

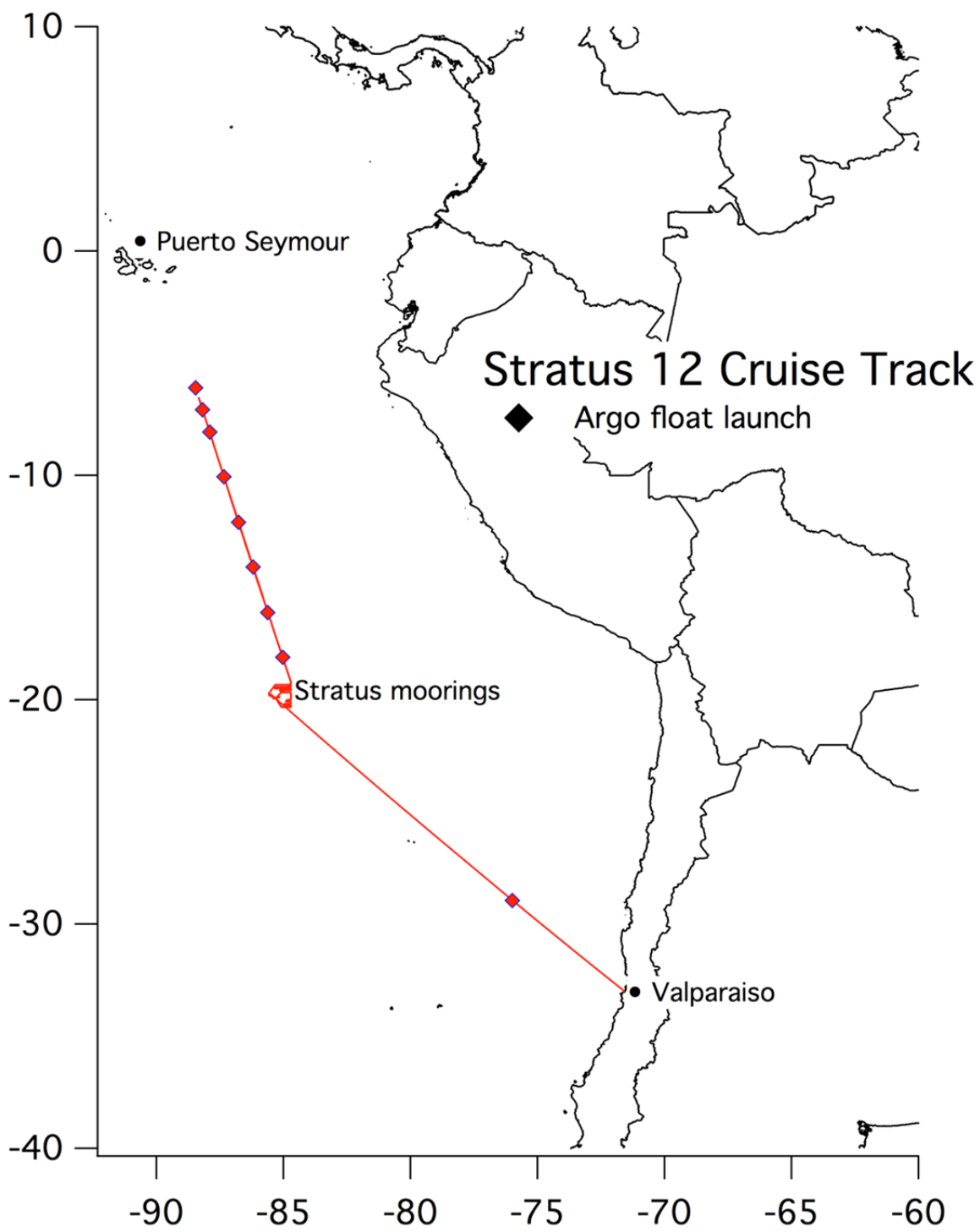

Figure 5-10. Deployment locations for Argo floats during Stratus 12 cruise.

The surface drifter, Figure 5-11, is a high-tech version of the "message in a bottle". It consists of a surface buoy and a subsurface drogue (sea anchor), attached by a long, thin tether. The buoy measures temperature and other properties, and has a transmitter to send the data to passing satellites. The drogue dominates the total area of the instrument and is centered at a depth of 15 meters beneath the sea surface. More information on the Global Drifter Program can be found at <http://www.aoml.noaa.gov/phod/dac/gdp.html>. The drifters were deployed at specified locations. The ship was not slowed for deployments of the surface drifters.



Figure 5-11. Typical Surface Drifter

Table 5-2. Location and times of the launches of the surface drifters deployed during the Stratus 12 cruise.

	DRIFTER ID	DATE	TIME (UTC)	DEPLOYMENT POSITION
1	101764	5/24/12	4:58	28 36.713 S, 76 20.175 W
2	101795	5/24/12	4:58	28 36.713 S, 76 20.175 W
3	101872	5/25/12	19:03	23 15.136 S 81 57.195 W
4	101779	5/25/12	19:03	23 15.136 S 81 57.195 W
5	101885	5/26/12	2:40	22 14.55 S, 82 59.25 W
6	101982	5/26/12	2:40	22 14.55 S, 82 59.25 W
7	101878	5/26/12	11:58	20 59.22 S, 84 15.75 W
8	101963	5/26/12	11:58	20 59.22 S, 84 15.75 W
9	101735	5/30/12	21:29	18 56.825 S, 85 18.073 W
10	101729	5/30/12	21:45	19 54.462 S, 85 17.399 W
11	101734	5/30/12	22:00	19 52.007 S, 85 16.162 W
12	101651	5/30/12	22:42	19 46.311 S, 85 10.927 W
13	101737	5/30/12	22:17	19 49.818 S, 85 14.223 W
14	101903	5/31/12	3:41	19 00.56 S, 84 46.3 W
15	101784	5/31/12	9:05	17 59.78 S, 85 04.12 W
16	101646	5/31/12	14:36	16 59.61 S, 85 21.74 W
17	101643	5/31/12	14:36	16 59.61 S, 85 21.74 W
18	36861	5/31/12	20:01	16 00.02 S, 85 39.09 W
19	36763	6/1/12	2:00	15 00.55 S, 85 56.19 W
20	36757	6/1/12	2:00	15 00.55 S, 85 56.19 W
21	101958	6/1/12	7:19	14 00.521 S, 86 13.453 W
22	101816	6/1/12	12:42	13 00.15 S, 86 30.75 W
23	101673	6/1/12	12:43	13 00.15 S, 86 30.75 W
24	101553	6/1/12	18:00	11 59.77 S, 86 47.97 W
25	101994	6/1/12	23:59?	11 01.132 S, 87 04.62 W
26	101539	6/2/12	4:18	09 59.20 S, 87 22.17 W
27	101957	6/2/12	9:24	09 00.028 S, 8738.871 W
28	101669	6/2/12	15:00	07 58.800 S, 87 56.084 W
29	101794	6/2/12	20:43	06 59.800 S, 88 12.800 W
30	82586	6/2/12	20:43	06 59.800 S, 88 12.800 W
31	101972	6/3/12	3:03	06 00.11 S, 88 29.39 W
32	101572	6/3/12	3:03	06 00.11 S, 88 29.39 W
33	101639	6/3/12	8:56	05 00.15 S, 88 46.16 W
34	101636	6/3/12	8:56	05 00.15 S, 88 46.16 W
35	36884	6/3/12	8:56	05 00.15 S, 88 46.16 W

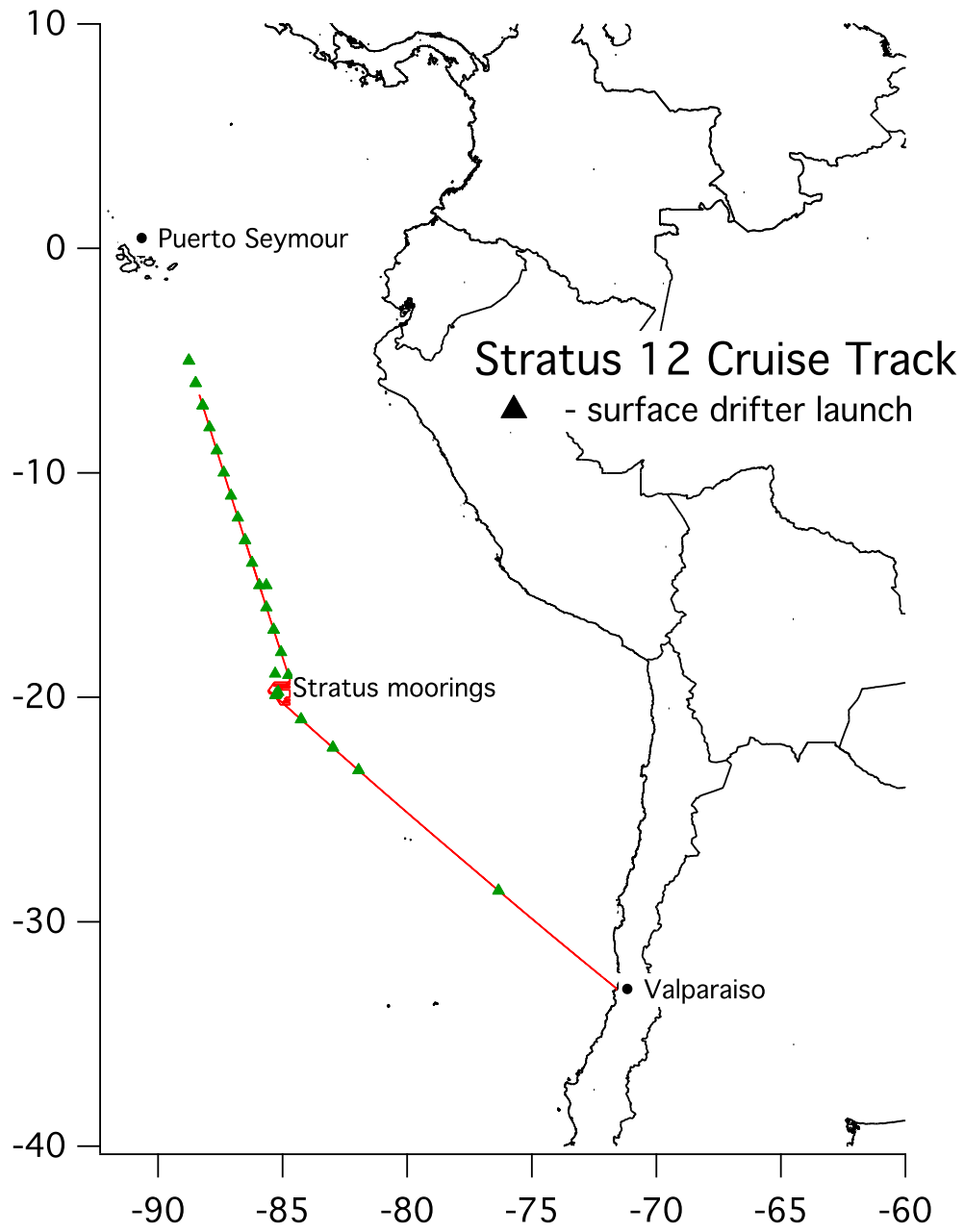

Figure 5-12. Deployment locations for surface drifters during the Stratus 12 cruise.

D. Phytoplankton sampling and CTD

Phytoplankton sampling in surface waters (c.a. 10 m) was performed next to CTD rosette casts, during the Stratus 12 Cruise onboard R/V *Melville*. The samplings were performed on three different days, with 20 ml per cast of micro-phytoplankton (c.a. size of 20 μm approximately). Each sample was placed into a 50 ml Falcon tube with approximately 30 ml of Walne medium (mainly seawater with enrichment of nutrients and vitamins). It was maintained at ambient temperature (approximately 20°C) with low light.

This sampling had as objective to isolate different species of marine phytoplankton and its strains (specific sample of species, with a specific location and specific conditions) to make a taxonomical assessment in laboratory with inverted microscopy, and then deposit this new strains in the Microalgae Culture Collection of the University of Concepción (CCM-UdeC). Long term objectives are to perform lab tests with single-species cultures in controlled environmental conditions (light, nutrients, nitrogen sources) to look for and optimize production of compounds with medium or high biotechnological value, such as proteins, carbohydrate sources, pigments and fatty acids.

Surface fluorescence sections (intrusion of cold, low fluorescence / high oxygen water mass):
During the underway data sampling of May 23 2012, a surface water mass with characteristics different from the background was noted in the ship's thermosalinograph and fluorometer (Figure 5-13). It was observed that this water mass, in contrast to the background, had low fluorescence, temperature and salinity but was rich in oxygen. This preliminary result shows that it was maybe an intrusion of water from near-coastal origin or from the Southern Ocean. It is remarkable that, generally, fluorescence and oxygen profiles mirror each other in the water column, because of the photosynthetic activity of phytoplankton. Since profiles were done at night, the high concentration of oxygen in contrast to fluorescence must be because of a decrease in light stimuli of photosynthetic apparatus of phytoplankton and a decrease of microalgal biomass without the presence of zooplankton in the water mass. Fluorescence is an indirect measurement of chloroplasts activity, being an indirect indicator of biomass and primary productivity. So, we can say that this event was an intrusion of water mass with low fluorescence / high oxygen.

Fluorescence profiles of water column, from CTD casts:

LAT -29.4688°S LONG -75.4253°W

During the first CTD cast, south of the Chilean EEZ around San Felix Island, fluorescence and oxygen profiles were obtained. Both profiles of fluorescence and oxygen match each other with a small difference in depth. Fluorescence peak is around 40 m, and oxygen peak was around 45 – 50 m. Differences in fluorescence can be explained by differences in weather conditions for a specific moment of day (e.g. clouds, sunlight, etc) because chlorophyll can vary in 30 – 60 minutes after a light stimuli, with an increase or decrease in fluorescence response. Also, fluorescence peaks match with temperature, salinity and density clines. The bottom of the photic layer is around 75 m; below this depth, fluorescence starts to decrease because phytoplankton is not common below the photic layer.

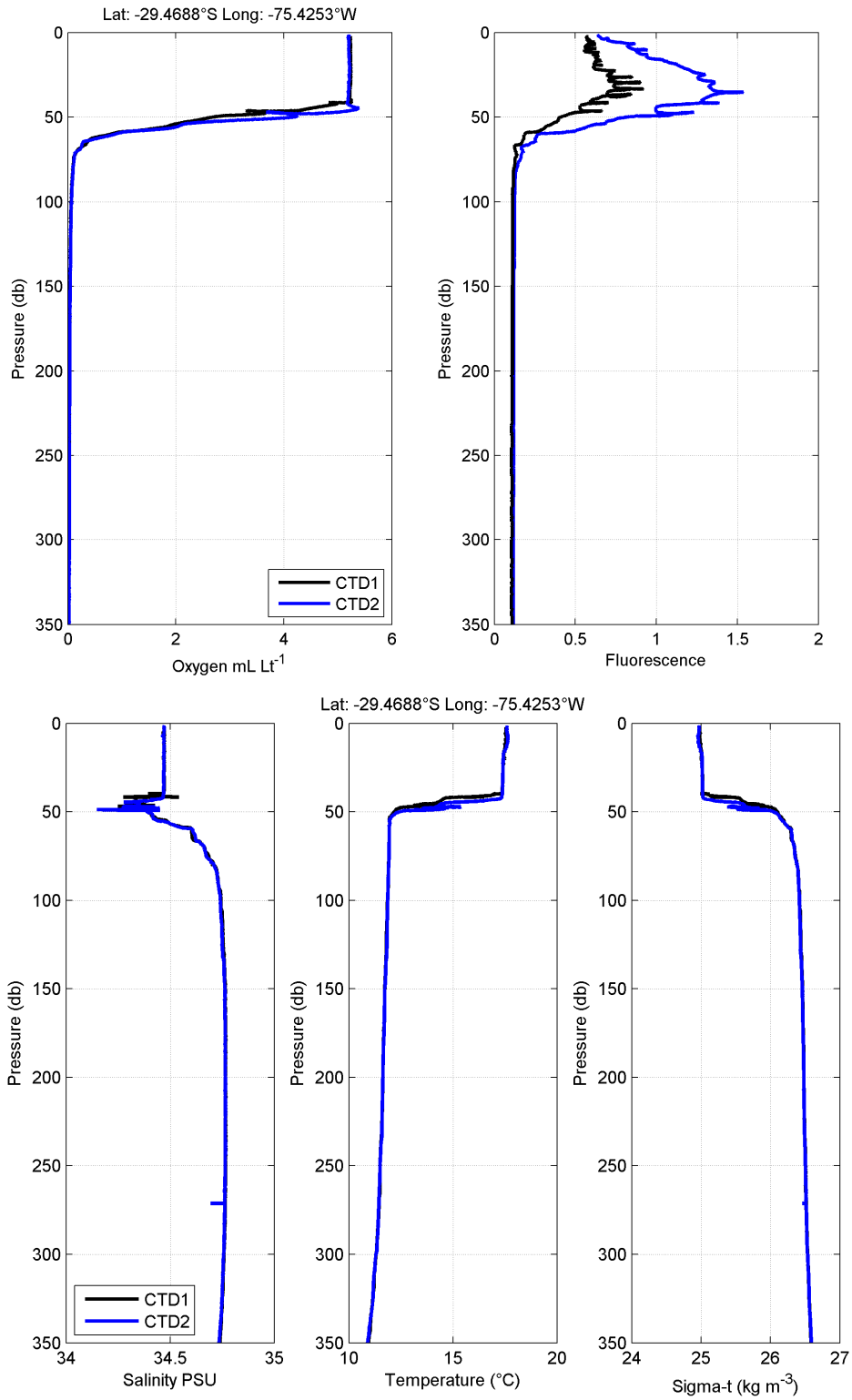

Figure 5-13. Oxygen and fluorescence (top) and salinity, temperature and density profiles from the two CTD casts made on May 23 during Stratus 12 cruise.

LAT -19.7922°S LONG -85.5545°W

Fluorescence and oxygen profiles were also made during the second CTD cast, near the Stratus mooring (Figure 5-14). Fluorescence profiles of phytoplankton match the oxygen profiles in the water column. Peak for chlorophyll fluorescence was at depth of 60 m, followed by the oxygen peak, also congruent with salinity, temperature and density clines. Photic layer usually is related, in depth, with fluorescence because of photosynthetic activity. So, for this CTD cast, the photic layer was around 175 m, deeper than the first CTD, and the surface layer was deeper, with a deeper cline. Peak of fluorescence was less than the first CTD and this can be explained because phytoplankton was concentrated in a bigger photic layer, and maybe there were fewer phytoplankters because there are less new nutrients at this latitude.

Below the photic layer, fluorescence signal is related with particles and some phytoplankters living in low light environments. At surface waters, generally phytoplankton is composed of diatoms and some representatives of Chlorophytes, Dinophytes and Cyanophytes. At depth, phytoplankton is composed of Chlorophytes and Cyanobacteria. The fluorescence is mainly related with Chl a; this type of main pigment is in all taxa of photosynthetic/mixotrophic phytoplankton.

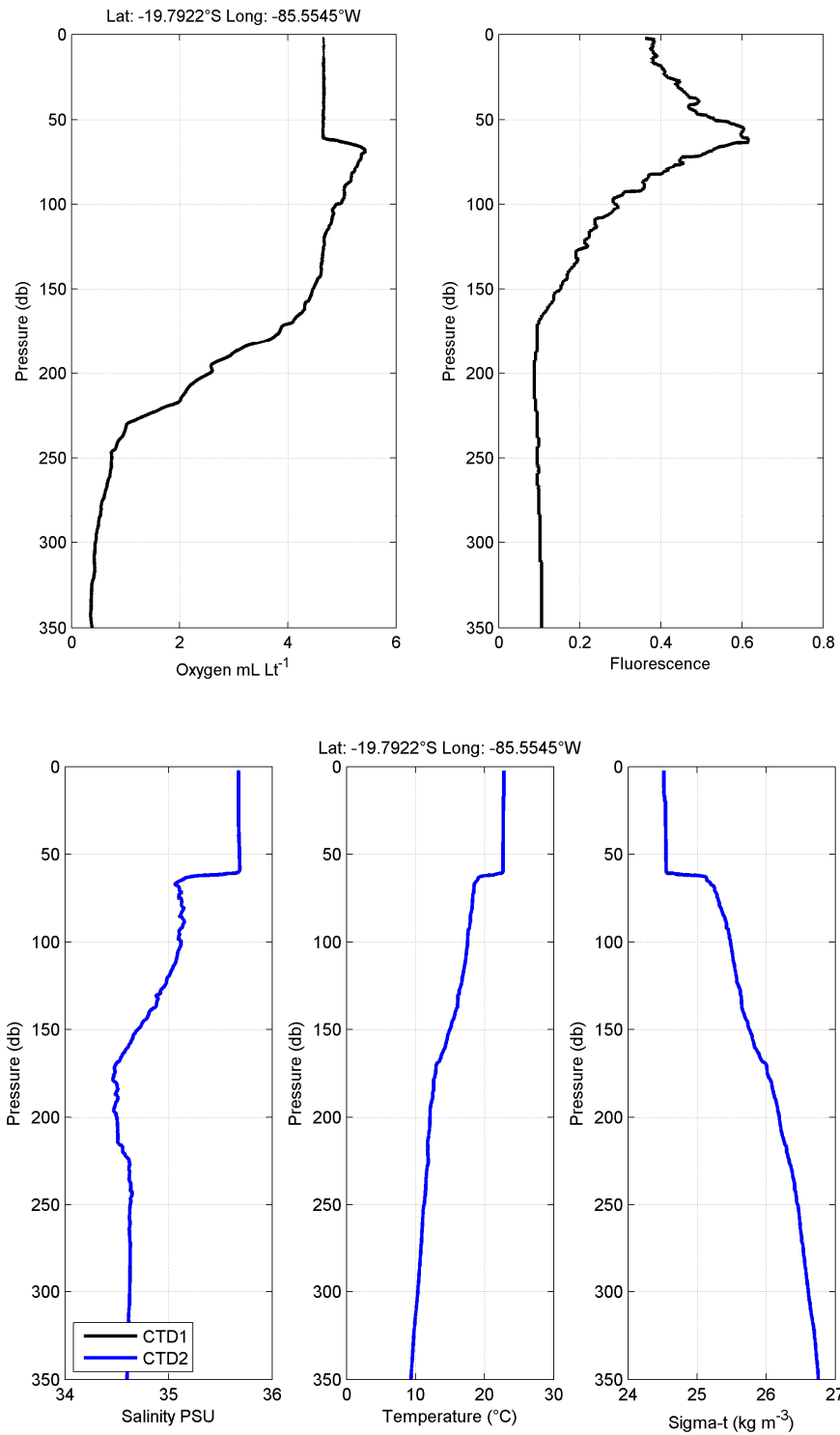

Figure 5-14. Oxygen and fluorescence (top) and salinity, temperature and density profiles from the two CTD casts made near Stratus surface mooring on May 26 during Stratus 12 cruise.

E. Ecuadorian National Observer

Due to their geographic location the costal waters of Ecuador exert a strong influence on the following masses of water:

- Agua Tropical Superficial (ATS), or Tropical Surface Water (TSW), Temperature. $> 25^{\circ}\text{C}$ and Salinity < 33 PSU; it is associated with the Gulf of Panama.

- Agua Ecuatorial Superficial (AES), or Equatorial Surface Water (ESW), Temperature $20^{\circ}\text{C} - 25^{\circ}\text{C}$ and Salinity $33 - 34.8$ PSU; it is associated with the front between the ATS and the Agua Costera Peruana (ACP), or Coastal Peruvian Water, and the Humboldt Current.

- Agua Subtropical Superficial (ASTS), or Subsurface Tropical Water (SSTW), Temperature $> 25^{\circ}\text{C}$ and Salinity > 35 PSU; it is associated with the west to east, Southern Equatorial Countercurrent.

- Agua Costera Peruana (ACP), or Coastal Peruvian Water (CPW), Temperature 19°C and Salinity 34.95 PSU; it is part of the Corriente Costera de Humboldt (ACCH), or the Coastal Humboldt Current.

- Agua Ecuatorial Subsuperficial (AESS), or Subsurface Equatorial Water (SSEW), Temperature $16^{\circ}\text{C} - 18^{\circ}\text{C}$ and Salinity $35.1 - 35.2$ PSU; it is part of the Subsurface Cromwell Current.

Between February and the first part of May, 2012, the masses of water around two oceanographic stations were recorded. These stations were located 10 miles off of the coast, one in front of La Libertad ($02^{\circ} 03' 55''$ S, $81^{\circ} 07' 15''$ W) and one in front of Manta ($00^{\circ} 52' 59''$ S, $80^{\circ} 49' 59''$ W). The TSW (ATS) was the principal water mass observed around the Manta station up until March. Starting April the ESW (AES) became predominant and still maintained its dominance as of the first days of May. The CPW (ACP) was observed at both monitoring stations. At Manta it was found between 32 and 75 meters of depth, and at La Libertad it was found between 45 and 70 meters deep. Its overall depth was found to be deeper during the month of April at both stations. A slight warming tendency was found during the transition period between the wet season (January to April) and the dry season (July to November).

Personal Experience:

My experience aboard the Melville has been unique. I have been able to observe how technology permits oceanographic data like salinity, TSM, TSA, dissolved oxygen, and fluorescence to be obtained rapidly and automatically. In addition, these data are displayed directly on the monitor in the main laboratory along side meteorological measurements like pressure, relative humidity, true and relative wind speed and other measurements important for navigation.

I also got to observe personally the deployment of an oceanic buoy along with its great quantity of instrumentation, like: CTDs, ADCPs, and Aanderaas (all with Doppler effect) and some equipment designed personally by the chief scientist, which had to be placed below 100m to avoid entanglement from fishing line as well as damage from fouling. The deepest instrumentation was nearly as far down as the anchor, around 4500m deep. I was particularly surprised to find that around the Stratus buoy's location (85°W by 20°S), some 600 miles from the mainland, that it is possible to encounter so much entangling line.

I also had the chance to participate in the launching of ARGO floats and drifters. I have been fortunate to form part of this specialized group. Everyone worked together and shared the various responsibilities as needed, all in a respectful and organized fashion. It was also an honor to work on a boat that has as many years at sea as the Melville and has traveled through every ocean, yet is still modern and capable of conducting scientific research.

F. Teacher-At-Sea

The past two weeks have been a rewarding time of hard work and learning in a very unfamiliar environment. Working closely with people I had never met before, being away from home for longer than I ever have required plenty of flexibility and a lot of patience for those who mentored me during this research cruise. There is much more to physical oceanography than I could ever amass or hope to impart to students by using textbooks and on line resources – the hands on, in person experience has allowed me to really become invested in exploring and understanding the world's oceans. Using and maintaining high tech tools to gather data for an important project, getting a glimpse of the intense work of interpreting the data, rolling up my sleeves and getting dirty, all of these are things these scientists do on a regular basis. Realizing it is only a small slice of investigating climate change and prediction has been very eye opening to me! Beyond the tools and technology, working with a group of talented individuals and seeing their problem solving skills be put to use assures me that there is talent that will discover solutions to the environmental changes our world faces. Moreover, how great a need there is for a next generation of scientists and problem solvers, some of whom I have a chance to influence. I am more equipped to take this opportunity on, including enrichment such as coaching or judging science fair projects on related topics! Climate research is a topic on the minds of many and I realize how important it is for us to put our resources and young minds into this endeavor. I have experienced the commitment that scientists have to precision and excellence in accruing the most accurate data and sharing it. Although Oceanography and Atmospheric Science is less than half of the curriculum I teach, it has now come alive to me and I return to my classroom enriched and equipped to educate and inspire. Thank you to NOAA's Teacher at Sea Program and to Dr. Weller and the WHOI team for providing this once in a lifetime opportunity to me.

G. Volunteer Experiences

Elsie Denton:

I'm a botanist by training and found my way to Chile to conduct fieldwork while my usual stomping grounds around Mount St. Helens, WA, were frozen over. I wasn't sure how long I would be in country, so I came down on a one-way ticket. Despite its connivance, air travel has become increasingly more bothersome and invasive. It also happens to be one of the worst things I can do for the environment. Since I had the spare time, I decided to find an alternative way north. As someone who believes we should change our lifestyles to protect our planet, this seemed like a good place to start.

The obvious alternative to flying is traveling by boat. A friend of mine suggested looking into the possibility of working on a scientific vessel and I managed to find Dr. Robert Weller's cruise leaving from Chile at a time that would be suitable for me. Following a brief email with my

qualifications and reasons for wanting to come, I was fortunate enough to receive an invitation to volunteer aboard the RV Melville.

I had very little idea as to what to expect. Oceanography was to me so many textbook maps of currents and wind directions, with no real accompanying knowledge of how that information was collected or developed. The cruise promised to be a tremendously interesting educational experience.

Coming on board and becoming familiarized with all of the oceanographic equipment was almost culture shock for me. In ecology our tools are generally no more complicated than rebar, flagging, a fifty meter tape and a good field guide. I was quite plainly awestruck by equipment like the Multibeam with its 191 hydrophones and the immense array of meteorological data logged every instant.

When Jeff described the engineering that went into the Status 12 mooring design, I was fascinated. So many details had to be taken into account just to install the buoy. Heavy chain loaded with instrumentation is right under the buoy to keep it stable and there are kilometers of rope: some that stretches to accommodate the tugging of the currents, and some that floats to aid in recovery. Right at the bottom with the acoustic releases are the fiberglass balls, 88 of them. These provide enough flotation to bring the whole assemblage up the surface should the buoy snap off and float away. Every little difficulty and challenge of the environment seems to have been taken into account, even those created by the buoy itself. The vector measuring current meters are placed deep within the water column to protect from the trolling line of the many fishing boats that come to take advantage of the productive waters spawned around the buoy. The source of this abundance, the fouling community clinging to the mooring, is fascinating as well: barnacles, crabs and algae, all so far away from the nearest source populations.

Another bit I was quite impressed by was the global interconnectedness of the work. This cruise and the Stratus project in general are not occurring in isolation. Built in from the beginning is the idea that data will feed into global databases and models, making the benefits of the knowledge gained widely available. Richer and fuller understandings and discoveries come from such broad collaboration. In my experience, ecology is years behind oceanography in this respect, but I suppose having one's object of study cover more than 70 percent of the world's surface several miles deep rather pushes the issue.

When I return to the US I'm planning to start a graduate program in ecology at Colorado State University. Everyone on board keeps asking me if I'm ready to change my major to oceanography yet. It's certainly tempting.

James Shambaugh:

My primary objectives in joining the 2012 Stratus Cruise were to support the PI and other scientists with basic climate research, to better understand how NOAA research is conducted in the field, to build relationships with researchers to facilitate support I provide to the NOAA Climate Observations Division, and to better understand how climate science research fits into the bigger picture.

In every respect, this mission was a huge success, and exceeded all expectations. As an honorary member of the Stratus science team, I was able to experience "science in action" and gain valuable first-hand understanding of the careful, complicated logistics involved in conducting

ocean observations, as well as the many challenges working with sensitive oceanographic equipment in harsh conditions.

Getting to know the scientists on board also gave me a better appreciation for the value and importance of the Stratus research (and ocean observations generally), how this research contributes to improved understanding of ocean processes in the eastern South Pacific, and globally, and how this research is used by climate modelers and others in the scientific and policy communities.

Most of all, I thoroughly enjoyed being part of the WHOI-led science team. Everyone was very warm and welcoming, and extremely patient as I stumbled my way through my first UCTDs and drifter and Argo deployments. The Stratus team is a highly dedicated and talented group, where everyone knows their role, everyone works well together, and all are ready to jump in and help as needed, at any time of the day and night.

Without a doubt, participating in this cruise will enable me to support the Climate Observation Division more effectively, to speak about ocean observations with far greater authority, and to engage more knowledgeably with NOAA staff and scientists.

Many thanks to the WHOI team for facilitating my participation in this mission. It has been a wonderful experience, and a true pleasure!

Final Notes and Future Recommendations

Hourly data from Alpha Omega should be saved for period when new buoy is on ship or right before deployment. Hourly data received from Argos satellite is usually starting after the buoy is officially deployed, so it does not contain the few hours just before deployment which may be useful for intercomparison purposes.

At beginning of cruise, a script should be written to automatically save data files from the ship system for a certain time window. This would simplify the delivery of data to foreign observers, which is otherwise a tedious and time consuming process to do manually, especially since ship time and UTC time are sometimes used interchangeably. Saving this data on portable USB drives is also quicker and easier than on DVDs.

The UCTD probe should be compared regularly (daily) with some reference conductivity measurements to monitor the possibility of a drift due to broken glass in the conductivity cell, happening sometimes when the probe hits the back of the ship upon recovery.

We are still trying to find the best sampling setup for some of our ADCP instruments. For the relatively new Seaguards for example we need to evaluate measurements obtained with current setup. We need to evaluate if flow distortion from the instrument impacted data for the sensor set up with a small blanking distance (0.5m).



Thanks and Acknowledgements



We wish to thank the crew of R/V *Melville* who were amazing hosts and did very professional work. Many thanks to the Chilean and Ecuadorian national observers who actively participated in the work at sea.

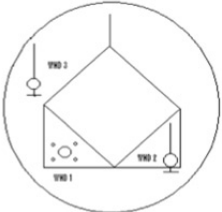

References



- Colbo K. and Weller R. A., 2009. Accuracy of the IMET Sensor Package in the Subtropics. *Journal of Atmospheric and Oceanic Technology*, **26**, 1867-1890.
- Rudnick D. L. and Klinke J., 2007. The underway Conductivity-Temperature-Depth instrument. *Journal of Atmospheric and Oceanic Technology*, **24**, 1910-1923.
- Serra Y. L. and A'Hearn P., Freitag H. P., McPhaden M. J., 2001. ATLAS self-siphoning rain gauge error estimates. *Journal of Atmospheric and Oceanic Technology*, **18**, 1989-2002.
- Mensah V. and Le Menn M., 2008. Thermal mass correction for the evaluation of salinity. *Journal of Atmospheric and Oceanic Technology*, **26**, 665-672.
- Lueck, R. G., 1990, Thermal inertia of conductivity cells: Observations with a SeaBird cell. *Journal of Atmospheric and Oceanic Technology*, **7**, 756-768.

APPENDIX 1: Buoy Spins

90 Heading					
					
	Time	Date			
Vanes Secured UTC	12:15:00	18-Mar-12			
System 1		Vane	Compass	Direction	Sample Time
Logger	L-01				
Stop Sampling	12:31:30				
SWND217		NA	225.20	NA	12:32:00
Restart Sampling	12:32:30				
System 2		Vane	Compass	Direction	Sample Time
Logger	L-02				
Stop Sampling	12:33:30				
WND240		264.70	182.10	89.50	12:34:00
Restart Sampling	17:43:30				
Standalone WND225		287.40	164.50	91.90	12:35:00
	Time	Date			
Vanes Secured UTC	12:40:00	18-Mar-12			
System 1		Vane	Compass	Direction	Sample Time
Logger	L-01				
Stop Sampling	12:56:30				
SWND217		NA	268.50	NA	12:57:00

Restart Sampling	12:57:30				
System 2		Vane	Compass	Direction	Sample Time
Logger	L-02				
Stop Sampling	12:58:30				
WND240		311.60	139.20	90.80	12:59:00
Restart Sampling	12:59:30				
Standalone WND225		332.40	119.50	91.90	13:00:30
	Time	Date			
Vanes Secured UTC	13:05:00	18-Mar-12			
System 1		Vane	Compass	Direction	Sample Time
Logger	L-01				
Stop Sampling	13:22:30				
SWND217		NA	315.10	NA	13:23:00
Restart Sampling	13:23:30				
System 2		Vane	Compass	Direction	Sample Time
Logger	L-02				
Stop Sampling	13:24:30				
WND240		357.20	93.20	90.40	13:25:00
Restart Sampling	13:25:30				
Standalone WND		16.80	75.00	91.80	13:26:30
	Time	Date			
Vanes Secured UTC	13:30:00	18-Mar-12			
System 1		Vane	Compass	Direction	Sample Time
Logger	L-01				
Stop Sampling	13:46:30				
SWND217		NA	1.70	NA	13:47:00
Restart Sampling	13:47:30				
System 2		Vane	Compass	Direction	Sample

					Time
Logger	L-02				
Stop Sampling	13:48:30				
WND240		43.00	47.20	90.20	13:49:00
Restart Sampling	13:49:30				
Standalone WND		67.30	29.10	92.80	13:50:00
	Time	Date			
Vanes Secured UTC	13:55:00	18-Mar-12			
System 1		Vane	Compass	Direction	Sample Time
Logger	L-01				
Stop Sampling	14:11:30				
SWND217		NA	47.90	NA	14:12:00
Restart Sampling	14:12:30				
System 2		Vane	Compass	Direction	Sample Time
Logger	L-02				
Stop Sampling	14:13:30				
WND240		88.50	2.40	90.90	14:14:00
Restart Sampling	14:14:30				
Standalone WND		330.80	112.70	93.50	14:15:00
	Time	Date			
Vanes Secured UTC	14:20:00	18-Mar-12			
System 1		Vane	Compass	Direction	Sample Time
Logger	L-01				
Stop Sampling	14:37:30				
SWND217		NA	93.40	NA	14:38:00
Restart Sampling	14:38:30				
System 2		Vane	Compass	Direction	Sample Time
Logger	L-02				
Stop Sampling	14:39:30				
WND240		133.70	317.60	91.30	14:40:00

Restart Sampling	14:40:30				
Standalone WND		154.80	298.40	93.20	14:41:00
	Time	Date			
Vanes Secured UTC	14:45:00	18-Mar-12			
System 1		Vane	Compass	Direction	Sample Time
Logger	L-01				
Stop Sampling	15:06:30				
SWND217		NA	137.40	NA	15:07:00
Restart Sampling	15:07:30				
System 2		Vane	Compass	Direction	Sample Time
Logger	L-02				
Stop Sampling	15:08:30				
WND240		178.10	274.20	92.30	15:09:00
Restart Sampling	15:09:30				
Standalone WND		196.40	255.30	91.70	15:10:00
	Time	Date			
Vanes Secured UTC	15:15:00	18-Mar-12			
System 1		Vane	Compass	Direction	Sample Time
Logger	L-01				
Stop Sampling	15:31:30				
SWND217		NA	181.60	NA	15:32:00
Restart Sampling	15:32:30				
System 2		Vane	Compass	Direction	Sample Time
Logger	L-02				
Stop Sampling	15:33:30				
WND240		222.90	227.80	90.70	15:34:00
Restart Sampling	15:34:30				
Standalone WND		239.40	213.10	92.50	15:35:00

APPENDIX 2: Stratus 12 burn-in notes

DATE:	ACTIVITY:
24 FEB 12	Burn in started in high bay. Primary system #1 (L-01) running with PTT, SST, BPR and SWR. Primary system # 2 (L-02) running with PTT, SST, and BPR.
25 FEB 12	Twenty degree compass cal. Performed on primary SWND and WND. WNDS added to both primary systems @ 14:41:30 UTC.
7 MAR 12	Buoy moved outside to burn in pad @ 14:45 UTC. HRH's plugged in to both primary systems @ 15:42 UTC.
8 MAR 12	Buoy moved inside @ 20:00 UTC.
9 MAR 12	Spare started up in high bay with HRH, BPR, PTT, and SST. Lascar and SBE-39- AT mounted on primary buoy and started.
12 MAR 12	Primary buoy and spare moved outside by 13:00 UTC. All SST's in bucket @ 15:07:30 UTC.
14 MAR 12	Spare SST out of bucket around 12:15 UTC. Primary SST's out of bucket @ 13:17 UTC. SST's with copper guards found "not" isolated. L-1/PRC204 plugged in @ 15:02:30 UTC. L01/PRC fill and drain @ 15:16:30 UTC. L-2/PRC208 plugged in @ 15:02:30 UTC. L02/PRC fill and drain @ 15:17:30 UTC. L-17/PRC212 plugged in @ 15:05:30 UTC. L17/PRC fill and drain @ 15:19:30 UTC. Vaisala WXT plugged in @ 15:30:30 UTC. All SST's guards fixed and back in bucket @ 17:46:30 UTC.
16 MAR 12	WND221 plugged in to spare system @ 19:33:30 UTC.
17 MAR 12	Primary SST's out of bucket @ 11:23:30 UTC. Primary buoy moved inside for wave sensor spin @ 11:30 UTC. Stand alone WND225 powered on @ 13:01:30 UTC. Buoy back outside @ 13:06 UTC. SST's back in bucket @ 13:10:30 UTC.
18 MAR 10	Primary SST's out of bucket @ 12:06:30 UTC. Primary buoy spin performed and finished by 15:37 UTC. Primary SST's back in bucket @ 15:37:30.
19 MAR 12	L-01 stopped @ 12:39:30 UTC Bytes recorded = 2202240 File:S12L01_01.dat = Bytes 2576 to 4624 Restart @ 13:01:30 UTC L-02 stopped @ 13:02:30 UTC Bytes recorded = 2201600 File:S12L02_01.dat = Bytes 2574 to 4622 Restart @ 13:21:30 UTC L-17 stopped @ 13:53:30 UTC Bytes recorded = 919680 File:S12L17_01.dat = Bytes 322 to 2119 Restart @ 14:11:30 UTC

VWX005 = 1428140 Bytes File: WXT005.dat = Bytes 1064 to 3112
 SA/WND225 = 36260 Bytes File: WND225.dat = bytes 322 to 715
 SBE39/AT File:

STRATUS12_SBE39_AT_burnin_19MAR12.asc
 WAMDAS turned on @14:30 UTC.

20 MAR 12 L01/LWR219 and L02/LWR209 plugged in @ 13:19:30 UTC.
 L02/HRH503 off @ 18:58 UTC. L02/HRH230 on @ 19:05 UTC. L17/HRH506 off
 @ 19:07
 UTC. L17/HRH231 on @ 19:13 UTC.

21 MAR 12 WAMDAS testing completed, mag. Var. changed to +7.0, FLASH erased,
 WAMDAS off @
 15:00 UTC.

23 MAR 12 L01/SWR218 unplugged @ 14:21:30 UTC. Moved to spare, L17/SWR218 plugged
 in @
 10:32:30 UTC. Un-calibrated SWR's mounted on both primary systems @18:03:30
 UTC.
 L17/LWR210 on @ ~4:28 local.

24 MAR 12 Stand alone HRH219 on @ 11:42 UTC.

26 MAR 12 All SST's out of bucket @ 18:17 UTC. Buoy and spare moved inside high bay @
 20:00 UTC.
 L01/SWR212 unplugged @ 22:45 UTC. L01/SWR501 plugged in @ 22:55 UTC.
 L02/SWR214 unplugged @ 22:39 UTC. L02/SWR503 plugged in @ 22:45 UTC.

27 MAR 12 SWR's leveled to 0.1 and 0.2 deg. difference. Buoy and spare outside by 13:15
 UTC.
 Buoy and spare back inside @19:50 UTC.

28 MAR 12 Buoy and spare outside by 11:20 UTC.

29 MAR 12 Buoy and spare inside @ 11:40 UTC.
 L-01 stopped @ 12:09:30 UTC
 Bytes recorded = 3120640 File:S12L01_02.dat = Bytes 4369 to 6417
 Restart @ 13:01:30 UTC
 L-02 stopped @ 12:42:30 UTC
 Bytes recorded = 3120640 File:S12L02_02.dat = Bytes 4369 to 6417
 Restart @ 13:21:30 UTC
 L-17 stopped @ 13:50:30 UTC
 Bytes recorded = 1840000 File:S12L17_02.dat = Bytes 1868 to 3916
 Restart @ 14:11:30 UTC
 VWX005 = 4334920 Bytes File: WXT005_02.dat = Bytes 6741 to 8789
 SA/WND225 = 214600 Bytes File: WND225_01.dat = bytes 322 to 742
 SA/HRH219 = 62976 File: HRH219_01.dat = Bytes 322 to 445
 SBE39/AT File:

STRATUS12_SBE39_AT_burnin_29MAR12.asc
 L02 stopped for ARGOS spiking testing on SWR's @ 16:40 UTC. L02 put in test
 mode.
 Spare PTT off @ 16:47, Primary PTT's off @ 17:05. Negative spikes seen on
 L02/SWR.
 WHOTS PTT's off @ 17:07 UTC. Spikes disappeared. Both Primary PTT's back
 on @

17:15, spare PTT on @ 17:20 UTC, SWR's show no negative values with all three PTT's on.

Spare SWR218 replaced FLASH card. Primary SWR501 replaced logger card, EPROM, and

flash card. Both primary system on by 23:00 UTC. Buoy put under high bay light for the

night for a test.

30 MAR 12 Primary Buoy outside @ 11:05 UTC. Spare on @ 11:15 UTC. Spare outside @ 11:20 UTC.

APPENDIX 3: Subsurface Instrument Setup (and SBE 39 ATMP)

Subsurface SBE 37s:

SBE37-SM V 2.6b SERIAL NO. 2011 17 May
2012 16:28:26
logging data
sample interval = 300 seconds
samplenum = 1050, free = 231966
do not transmit real-time data
do not output salinity with each sample
do not output sound velocity with each sample
store time with each sample
number of samples to average = 4
reference pressure = 0.0 db
serial sync mode disabled
wait time after serial sync sampling = 30 seconds
internal pump not installed
temperature = 17.05 deg C

SBE37-SM V 2.6b SERIAL NO. 1907 17 May
2012 16:28:42
logging data
sample interval = 300 seconds
samplenum = 1050, free = 231966
do not transmit real-time data
do not output salinity with each sample
do not output sound velocity with each sample
store time with each sample
number of samples to average = 4
reference pressure = 0.0 db
serial sync mode disabled
wait time after serial sync sampling = 30 seconds
internal pump not installed
temperature = 16.77 deg C

SBE37-SM V 2.6b SERIAL NO. 1903 17 May
2012 16:29:02
logging data
sample interval = 300 seconds
samplenum = 1050, free = 231966
do not transmit real-time data
do not output salinity with each sample
do not output sound velocity with each sample
store time with each sample
number of samples to average = 4
reference pressure = 0.0 db
serial sync mode disabled
wait time after serial sync sampling = 30 seconds
internal pump not installed
temperature = 16.63 deg C

SBE37-SM V 2.6b SERIAL NO. 1905 17 May
2012 16:29:28
logging data
sample interval = 300 seconds
samplenum = 1050, free = 231966
do not transmit real-time data
do not output salinity with each sample
do not output sound velocity with each sample
store time with each sample
number of samples to average = 4
reference pressure = 0.0 db
serial sync mode disabled
wait time after serial sync sampling = 30 seconds
internal pump not installed
temperature = 16.81 deg C

SBE37-SM V 2.6b SERIAL NO. 3821 17 May
2012 17:24:24
logging data
sample interval = 300 seconds
samplenum = 1061, free = 231955
do not transmit real-time data
do not output salinity with each sample
do not output sound velocity with each sample
store time with each sample
number of samples to average = 4
reference pressure = 0.0 db
serial sync mode disabled
wait time after serial sync sampling = 30 seconds
internal pump not installed
temperature = 16.87 deg C

SBE37-SM V 2.6b SERIAL NO. 3824 17 May
2012 17:26:55
logging data
sample interval = 300 seconds
samplenum = 1061, free = 231955
do not transmit real-time data
do not output salinity with each sample
do not output sound velocity with each sample
store time with each sample
number of samples to average = 4
reference pressure = 0.0 db
serial sync mode disabled
wait time after serial sync sampling = 30 seconds
internal pump not installed
temperature = 16.98 deg C

SBE37-SM V 1.6 SERIAL NO. 0010 17 May
2012 17:29:17
logging data
sample interval = 300 seconds
samplenum = 1062, free = 114536
do not transmit real-time data
store time with each sample
A/D cycles to average = 2
reference pressure = 0.0 db
serial sync mode disabled
wait time after serial sync sampling = 120 seconds
temperature = 17.29 deg C

SBE37-SM V 2.6b SERIAL NO. 1900 17 May
2012 17:30:38
logging data
sample interval = 300 seconds
samplenum = 1063, free = 231953
do not transmit real-time data
do not output salinity with each sample
do not output sound velocity with each sample
store time with each sample
number of samples to average = 4
reference pressure = 0.0 db
serial sync mode disabled
wait time after serial sync sampling = 30 seconds
internal pump not installed
temperature = 17.36 deg C

SBE37SM-RS232 3.0j SERIAL NO. 8004 17 May
2012 17:32:38
vMain = 6.95, vLith = 3.21
samplenum = 19, free = 559221
logging
sample interval = 300 seconds
data format = converted engineering
transmit real-time = no
sync mode = no
pump installed = no

SBE37SM-RS232 3.0j SERIAL NO. 7836 17 May
2012 17:36:20
vMain = 7.00, vLith = 3.09
samplenum = 20, free = 559220
logging
sample interval = 300 seconds
data format = converted engineering
transmit real-time = no
sync mode = no
pump installed = no

SBE37-SM V 2.6b SERIAL NO. 1901 17 May
2012 17:38:06
logging data
sample interval = 300 seconds
samplenum = 1064, free = 231952
do not transmit real-time data
do not output salinity with each sample
do not output sound velocity with each sample
store time with each sample
number of samples to average = 4
reference pressure = 0.0 db
serial sync mode disabled
wait time after serial sync sampling = 30 seconds
internal pump not installed
temperature = 17.08 deg C

SBE37-SM V 2.6b SERIAL NO. 1902 17 May
2012 17:38:37
logging data
sample interval = 300 seconds
samplenum = 1064, free = 231952
do not transmit real-time data
do not output salinity with each sample
do not output sound velocity with each sample
store time with each sample
number of samples to average = 4
reference pressure = 0.0 db
serial sync mode disabled
wait time after serial sync sampling = 30 seconds
internal pump not installed
temperature = 16.93 deg C

SBE37-SM V 2.6b SERIAL NO. 1899 17 May
2012 17:39:00
logging data
sample interval = 300 seconds
samplenum = 1064, free = 231952
do not transmit real-time data
do not output salinity with each sample
do not output sound velocity with each sample
store time with each sample
number of samples to average = 4
reference pressure = 0.0 db
serial sync mode disabled
wait time after serial sync sampling = 30 seconds
internal pump not installed
temperature = 16.78 deg C

SBE37-SM V 2.6b SERIAL NO. 1304 17 May
2012 17:39:14
logging data
sample interval = 300 seconds
samplenum = 1064, free = 231952
do not transmit real-time data
do not output salinity with each sample
do not output sound velocity with each sample

store time with each sample
number of samples to average = 4
reference pressure = 0.0 db
serial sync mode disabled

Subsurface SBE 39s:

SBE 39 V 2.0 SERIAL NO. 1502 17 May 2012
15:04:52
battery voltage = 8.6
logging data
sample interval = 300 seconds
samplenum = 1033, free = 598153
serial sync mode disabled
real-time output disabled
SBE 39 configuration = temperature only
binary upload does not include time
temperature = 18.93 deg C

SBE 39 V 2.2 SERIAL NO. 1509 17 May 2012
15:06:12
battery voltage = 8.6
logging data
sample interval = 300 seconds
samplenum = 1034, free = 598152
serial sync mode disabled
real-time output disabled
SBE 39 configuration = temperature only
binary upload does not include time
temperature = 16.66 deg C

SBE 39 V 2.2 SERIAL NO. 1511 17 May 2012
15:07:01
battery voltage = 8.6
logging data
sample interval = 300 seconds
samplenum = 1034, free = 598152
serial sync mode disabled
real-time output disabled
SBE 39 configuration = temperature only
binary upload does not include time
temperature = 16.40 deg C

SBE 39 V 3.0b SERIAL NO. 3435 17 May 2012
15:08:03
battery voltage = 8.7
logging data
sample interval = 300 seconds
samplenum = 1034, free = 598152
serial sync mode disabled
real-time output disabled
SBE 39 configuration = temperature only
binary upload does not include time
temperature = 16.70 deg C

wait time after serial sync sampling = 30 seconds
internal pump not installed
temperature = 16.91 deg C

SBE 39 V 3.0b SERIAL NO. 3434 17 May 2012
15:08:47
battery voltage = 8.6
logging data
sample interval = 300 seconds
samplenum = 1034, free = 598152
serial sync mode disabled
real-time output disabled
SBE 39 configuration = temperature only
binary upload does not include time
temperature = 16.09 deg C

SBE 39 V 3.0b SERIAL NO. 3423 17 May 2012
15:09:36
battery voltage = 8.6
logging data
sample interval = 300 seconds
samplenum = 1035, free = 598151
serial sync mode disabled
real-time output disabled
SBE 39 configuration = temperature only
binary upload does not include time
temperature = 16.53 deg C

SBE 39 V 3.0b SERIAL NO. 3438 17 May 2012
15:10:17
battery voltage = 8.6
logging data
sample interval = 300 seconds
samplenum = 1035, free = 598151
serial sync mode disabled
real-time output disabled
SBE 39 configuration = temperature only
binary upload does not include time
temperature = 16.17 deg C

SBE 39 V 3.0b SERIAL NO. 3437 17 May 2012
15:11:30
battery voltage = 8.7
logging data
sample interval = 300 seconds
samplenum = 1035, free = 598151
serial sync mode disabled
real-time output disabled
SBE 39 configuration = temperature only
binary upload does not include time
temperature = 17.42 deg C

SBE 39 V 3.0b SERIAL NO. 3439 17 May 2012
15:12:26
battery voltage = 8.6
logging data
sample interval = 300 seconds
samplenum = 1035, free = 598151

serial sync mode disabled
real-time output disabled
SBE 39 configuration = temperature only
binary upload does not include time
temperature = 16.89 deg C
S>

Surface Air Temperature SBE 39

SBE 39 V 3.1b SERIAL NO. 5275 01 Apr 2012 15:48:24
battery voltage = 9.1
not logging: waiting to start at 14 May 2012 01:00:00
sample interval = 300 seconds
samplenum = 0, free = 4699867
serial sync mode disabled
real-time output disabled
SBE 39 configuration = temperature only
binary upload does not include time
temperature = 16.49 deg C

Subsurface SBE 16

SEACAT V4.1b SERIAL NO. 1879 05/17/12
15:44:50.058
clk = 32767.313, iop = 101, vmain = 8.8, vlith = 5.6
at 05/14/12 01:00:00.000 sample interval = 1800 sec
samples = 174, free = 260648, lwait = 0 msec
SW1 = C0H, battery cutoff = 5.6 volts
no. of volts sampled = 0
mode = normal
logdata = YES

SEACAT V4.1b SERIAL NO. 1876 05/17/12
15:45:14.031
clk = 32768.016, iop = 105, vmain = 8.9, vlith = 5.3
at 05/14/12 01:00:00.000 sample interval = 1800 sec
samples = 174, free = 260648, lwait = 0 msec
SW1 = C0H, battery cutoff = 5.6 volts
no. of volts sampled = 0
mode = normal
logdata = YES

Nortek current meters and profilers

Deployment : STR12
Current time : 3/15/2012 3:49:50 PM
Start at : 5/14/2012 1:00:00 AM
Comment:
STRATUS12
Profile interval (s) : 3600
Number of cells : 13
Cell size (m) : 1.00
Blanking distance (m) : 0.41
Measurement load (%) : 88
Average interval (s) : 180
Power level : HIGH-
Number of wave samples : N/A
Wave interval (s) : N/A
Wave sampling rate (Hz) : N/A
Wave cell size (m) : N/A
Compass upd. rate (s) : 1
Coordinate System : ENU
Speed of sound (m/s) : MEASURED
Salinity (ppt) : 35
Analog input 1 : NONE
Analog input 2 : NONE

Analog input power out : DISABLED
File wrapping : OFF
Serial output/TellTale : OFF
Assumed duration (days) : 540.0
Battery utilization (%) : 85.0
Battery level (V) : 11.2
Recorder size (MB) : 25
Recorder free space (MB) : 24.973
Memory required (MB) : 1.9
Vertical vel. prec (cm/s) : 0.3
Horizon. vel. prec (cm/s) : 0.8
Instrument ID : AQP 0333
Head ID : AQP 0237
Firmware version : 1.17
AquaPro Version 1.34
Copyright (C) Nortek AS

Deployment : STR12
Current time : 3/15/2012 3:41:49 PM
Start at : 5/14/2012 1:00:00 AM
Comment:
STRATUS12
Profile interval (s) : 1800
Number of cells : 8
Cell size (m) : 0.50
Blanking distance (m) : 0.20
Measurement load (%) : 26
Average interval (s) : 180
Power level : HIGH-
Number of wave samples : N/A
Wave interval (s) : N/A
Wave sampling rate (Hz) : N/A
Wave cell size (m) : N/A
Compass upd. rate (s) : 1
Coordinate System : ENU
Speed of sound (m/s) : MEASURED
Salinity (ppt) : 35
Analog input 1 : NONE
Analog input 2 : NONE
Analog input power out : DISABLED
File wrapping : OFF
Serial output/TellTale : OFF
Assumed duration (days) : 540.0
Battery utilization (%) : 87.0
Battery level (V) : 11.2
Recorder size (MB) : 25
Recorder free space (MB) : 24.973
Memory required (MB) : 2.6
Vertical vel. prec (cm/s) : 0.3
Horizon. vel. prec (cm/s) : 0.9
Instrument ID : AQD 0402
Head ID : AQP 4971
Firmware version : 1.17
AquaPro Version 1.34
Copyright (C) Nortek AS

Deployment : STR12
Current time : 3/15/2012 3:31:07 PM
Start at : 5/14/2012 1:00:00 AM
Comment:
STRATUS 12
Measurement interval (s) : 900
Average interval (s) : 160
Blanking distance (m) : 0.37
Measurement load (%) : 9
Power level : HIGH-
Diagnostics interval(min) : 720:00
Diagnostics samples : 60
Compass upd. rate (s) : 1
Coordinate System : ENU
Speed of sound (m/s) : MEASURED
Salinity (ppt) : 35

Analog input 1 : NONE
Analog input 2 : NONE
Analog input power out : DISABLED
File wrapping : OFF
TellTale : OFF
AcousticModem : OFF
Serial output : OFF
Assumed duration (days) : 540.0
Battery utilization (%) : 90.0
Battery level (V) : 11.2
Recorder size (MB) : 9
Recorder free space (MB) : 8.973
Memory required (MB) : 4.7
Vertical vel. prec (cm/s) : 1.1
Horizon. vel. prec (cm/s) : 0.6
Instrument ID : AQD 1666
Head ID : AQD 1499
Firmware version : 1.21
Aquadopp Version 1.38
Copyright (C) Nortek AS

Deployment : STR12
Current time : 3/15/2012 3:33:52 PM
Start at : 5/14/2012 1:00:00 AM
Comment:
STRATUS 12
Measurement interval (s) : 900
Average interval (s) : 160
Blanking distance (m) : 0.37
Measurement load (%) : 9
Power level : HIGH-
Diagnostics interval(min) : 720:00
Diagnostics samples : 60
Compass upd. rate (s) : 1
Coordinate System : ENU
Speed of sound (m/s) : MEASURED
Salinity (ppt) : 35
Analog input 1 : NONE
Analog input 2 : NONE
Analog input power out : DISABLED
File wrapping : OFF
TellTale : OFF
AcousticModem : OFF
Serial output : OFF
Assumed duration (days) : 540.0
Battery utilization (%) : 90.0
Battery level (V) : 11.2
Recorder size (MB) : 9
Recorder free space (MB) : 8.973
Memory required (MB) : 4.7
Vertical vel. prec (cm/s) : 1.1
Horizon. vel. prec (cm/s) : 0.6
Instrument ID : AQD 1688
Head ID : AQD 1464
Firmware version : 1.21

Aquadopp Version 1.38
Copyright (C) Nortek AS

Deployment : STR12
Current time : 3/15/2012 3:27:02 PM
Start at : 5/14/2012 1:00:00 AM
Comment:
STRATUS 12
Measurement interval (s) : 900
Average interval (s) : 160
Blanking distance (m) : 0.37
Measurement load (%) : 9
Power level : HIGH-
Diagnostics interval(min) : 720:00
Diagnostics samples : 60
Compass upd. rate (s) : 1
Coordinate System : ENU
Speed of sound (m/s) : MEASURED
Salinity (ppt) : 35
Analog input 1 : NONE
Analog input 2 : NONE
Analog input power out : DISABLED
File wrapping : OFF
TellTale : OFF
AcousticModem : OFF
Serial output : OFF
Assumed duration (days) : 540.0
Battery utilization (%) : 90.0
Battery level (V) : 11.2
Recorder size (MB) : 9
Recorder free space (MB) : 8.973
Memory required (MB) : 4.7
Vertical vel. prec (cm/s) : 1.1
Horizon. vel. prec (cm/s) : 0.6
Instrument ID : AQD 2064
Head ID : AQD 1791
Firmware version : 1.19
Aquadopp Version 1.38
Copyright (C) Nortek AS

Subsurface Vector Measuring Current Meters

Model: STAR ENGINEERIN
SerNum: VM0035
CfgDat: 08APR02
Firmware: VMCM2 v3.10
RTClock: 2012/05/17 13:03:35
Logging Interval: 60; Current Tick: 50
EDI Intel-compatible 20MB PCMCIA CARD present
- CARD OK!
FLASH card capacity: 20840436
Records used: 0; available: 612954
Main Battery Voltage: 14.19
TPOD Firmware: VMTPOD53 v3.00
TPOD Info: VMTPOD VMT035 07FEB12
THERM035

Deployment : STR12
Current time : 3/27/2012 3:23:07 PM
Start at : 5/14/2012 1:00:00 AM
Comment:
STRATUS 12
Measurement interval (s) : 900
Average interval (s) : 160
Blanking distance (m) : 0.37
Measurement load (%) : 9
Power level : HIGH-
Diagnostics interval(min) : 720:00
Diagnostics samples : 60
Compass upd. rate (s) : 1
Coordinate System : ENU
Speed of sound (m/s) : MEASURED
Salinity (ppt) : 35
Analog input 1 : NONE
Analog input 2 : NONE
Analog input power out : DISABLED
File wrapping : OFF
TellTale : OFF
AcousticModem : OFF
Serial output : OFF
Assumed duration (days) : 540.0
Battery utilization (%) : 90.0
Battery level (V) : 11.3
Recorder size (MB) : 9
Recorder free space (MB) : 8.973
Memory required (MB) : 4.7
Vertical vel. prec (cm/s) : 1.1
Horizon. vel. prec (cm/s) : 0.6
Instrument ID : AQD 9883
Head ID : AQD 5298
Firmware version : 3.35
Aquadopp Version 1.38
Copyright (C) Nortek AS

Sampling GO
Aborting delayed start - entering STOP mode

Model: STAR ENGINEERIN
SerNum: VM2009
CfgDat: 08APR02
Firmware: VMCM2 v3.10
RTClock: 2012/05/17 13:07:50
Logging Interval: 60; Current Tick: 5
EDI Intel-compatible 20MB PCMCIA CARD present
- CARD OK!
FLASH card capacity: 20840436
Records used: 1; available: 612953
Main Battery Voltage: 14.20

TPOD Firmware: VMTPOD53 v3.00
TPOD Info: VMTPOD VMT009 20JAN11
THERM009
Sampling GO
Aborting delayed start - entering STOP mode

Model: STAR ENGINEERIN
SerNum: VM2058
CfgDat: 16APR02
Firmware: VMCM2 v3.10
RTClock: 2012/05/17 13:12:04
Logging Interval: 60; Current Tick: 19
EDI Intel-compatible 20MB PCMCIA CARD present
- CARD OK!
FLASH card capacity: 20840436
Records used: 1; available: 612953
Main Battery Voltage: 14.25
TPOD Firmware: VMTPOD53 v3.00
TPOD Info: VMTPOD VMT058 26JAN11
THERM058
Sampling GO
Aborting delayed start - entering STOP mode

Model: STAR ENGINEERIN
SerNum: VM2030
CfgDat: 09APR02
Firmware: VMCM2 v3.10
RTClock: 2012/05/17 13:16:34
Logging Interval: 60; Current Tick: 4
EDI Intel-compatible 20MB PCMCIA CARD present
- CARD OK!
FLASH card capacity: 20840436
Records used: 0; available: 612954
Main Battery Voltage: 14.67
TPOD Firmware: VMTPOD53 v3.00
TPOD Info: VMTPOD VMT030 13FEB12
THERM030
Sampling GO
Aborting delayed start - entering STOP mode

Model: STAR ENGINEERIN
SerNum: VM2073
CfgDat: 15APR02
Firmware: VMCM2 v3.10
RTClock: 2012/05/17 13:19:56
Logging Interval: 60; Current Tick: 11
EDI Intel-compatible 20MB PCMCIA CARD present
- CARD OK!
FLASH card capacity: 20840436
Records used: 0; available: 612954
Main Battery Voltage: 14.80
TPOD Firmware: VMTPOD53 v3.00

TPOD Info: VMTPOD VMT073 26JAN11
THERM073
Sampling GO
Aborting delayed start - entering STOP mode

Model: STAR ENGINEERIN
SerNum: VM2068
CfgDat: 15APR02
Firmware: VMCM2 v3.10
RTClock: 2012/05/17 13:24:28
Logging Interval: 60; Current Tick: 58
EDI Intel-compatible 20MB PCMCIA CARD present
- CARD OK!
FLASH card capacity: 20840436
Records used: 1; available: 612953
Main Battery Voltage: 14.23
TPOD Firmware: VMTPOD53 v3.00
TPOD Info: VMT068 13FEB12
Sampling GO
Aborting delayed start - entering STOP mode

Model: STAR ENGINEERIN
SerNum: VM2010
CfgDat: 10APR02
Firmware: VMCM2 v3.10
RTClock: 2012/05/17 13:27:47
Logging Interval: 60; Current Tick: 17
EDI Intel-compatible 20MB PCMCIA CARD present
- CARD OK!
FLASH card capacity: 20840436
Records used: 0; available: 612954
Main Battery Voltage: 14.87
TPOD Firmware: VMTPOD53 v3.00
TPOD Info: VMTPOD VMT010 26JAN11
THERM010
Sampling GO
Aborting delayed start - entering STOP mode

Model: STAR ENGINEERIN
SerNum: VM2038
CfgDat: 09APR02
Firmware: VMCM2 v3.10
RTClock: 2012/05/17 13:37:38
Logging Interval: 60; Current Tick: 8
EDI Intel-compatible 20MB PCMCIA CARD present
- CARD OK!
FLASH card capacity: 20840436
Records used: 4; available: 612950
Main Battery Voltage: 14.23
TPOD Firmware: VMTPOD53 v3.00
TPOD Info: yyyyy VMT038 13FEB12
THERM038
Sampling GO

Subsurface RDI workhorse profiler

WorkHorse Broadband ADCP Version 50.36

Teledyne RD Instruments (c) 1996-2009

All Rights Reserved.

Instrument S/N: 12254

Frequency: 307200 HZ

Configuration: 4 BEAM, JANUS

Match Layer: 10

Beam Angle: 20 DEGREES

Beam Pattern: CONVEX

Orientation: UP

Sensor(s): HEADING TILT 1 TILT 2 TEMPERATURE

Temp Sens Offset: -0.15 degrees C

CPU Firmware: 50.36 [0]

Boot Code Ver: Required: 1.13 Actual: 1.13

DEMODO #1 Ver: ad48, Type: 1f

DEMODO #2 Ver: ad48, Type: 1f

PWRTIMG Ver: 85d3, Type: 4

Board Serial Number Data:

50 00 00 05 88 CB C8 09 PIO727-3000-00G

6D 00 00 05 89 4C AD 09 DSP727-2001-04G

50 00 00 05 88 C6 7D 09 REC727-1000-04E

E7 00 00 05 88 C9 5F 09 CPU727-2000-00J

Bytes used on device #1 = 0

Total capacity = 2301042688 bytes

Total bytes used = 0 bytes in 0 files

Total bytes free = 2301042688 bytes

Current deployment name = STR12

TS = 12/03/15,14:05:00 --- Time Set (yr/mon/day,hour:min:sec)

>DEPLOY?

Deployment Commands:

CF = 11011 ----- Flow Ctrl (EnsCyc;PngCyc;Binry;Ser;Rec)

CK ----- Keep Parameters as USER Defaults

CR # ----- Retrieve Parameters (0 = USER, 1 = FACTORY)

CS ----- Start Deployment

EA = +00000 ----- Heading Alignment (1/100 deg)

EB = +00000 ----- Heading Bias (1/100 deg)

ED = 01350 ----- Transducer Depth (0 - 65535 dm)

ES = 35 ----- Salinity (0-40 pp thousand)

EX = 11111 ----- Coord Transform (Xform: Type,Tilts,3 Bm,Map)

EZ = 1111101 ----- Sensor Source (C,D,H,P,R,S,T)

RE ----- Recorder ErAsE

RN ----- Set Deployment Name

TE = 01:00:00.00 ----- Time per Ensemble (hrs:min:sec.sec/100)

TF = 12/05/14,01:00:00 --- Time of First Ping (yr/mon/day,hour:min:sec)

TP = 00:01.00 ----- Time per Ping (min:sec.sec/100)

TS = 12/03/15,14:08:21 --- Time Set (yr/mon/day,hour:min:sec)

WD = 111 100 000 ----- Data Out (Vel,Cor,Amp; PG,St,P0; P1,P2,P3)
WF = 0176 ----- Blank After Transmit (cm)
WN = 012 ----- Number of depth cells (1-128)
WP = 00150 ----- Pings per Ensemble (0-16384)
WS = 1000 ----- Depth Cell Size (cm)
WV = 170 ----- Mode 1 Ambiguity Vel (cm/s radial)

APPENDIX 4: Stratus 11 mooring log

Moored Station Log

(fill out log with black ball point pen only)

ARRAY NAME AND NO. STRATUS II MOORED STATION NO. 1226

Launch (anchor over)

Date (day-mon-yr) 6 APR 2011 Time 1928 UTC
 Deployed by LORD Recorder/Observer GALBRAITH
 Ship and Cruise No. MOANA WAVE Intended Duration 12 MONTHS
 Depth Recorder Reading _____ m ^{DEPTH} Correction Source SEABEAM MAP SOURCE
 Depth Correction 10 m (+5m MATHEW STABLE + 5m DUCER DEPTH)
 Corrected Water Depth 4440 m Magnetic Variation (E/W) _____
 Anchor Drop Lat. (N/S) 19° 41.675 Lon. (E/W) 85° 33.826
 Surveyed Pos. Lat. (N/S) 19° 41.4783 Lon. (E/W) 85° 34.0093
WATCH CIRCLE NM 3.7
 Argos Platform ID No. _____ Additional Argos Info on pages 2 and 3

EDGE TECH ORE
 Acoustic Release Model 842 8242 XS Tested to _____ m

Release No. 1 (sn) <u>30843</u>	Release No. 2 (sn) <u>35118</u>
Interrogate Freq. <u>11</u>	Interrogate Freq. <u>11</u>
Reply Freq. <u>12</u>	Reply Freq. <u>12</u>
Enable <u>166433</u>	Enable <u>202705</u>
Disable <u>166456</u>	Disable <u>202726</u>
Release <u>151313</u>	Release <u>224233</u>

Recovery (release fired)

Date (day-mon-yr) 29/05/2012 Time 12:30:00 UTC
 Latitude (N/S) 19 41.136 Longitude (E/W) 085 34.606
 Recovered by _____ Recorder/Observer _____
 Ship and Cruise No. Melville 1207 Actual duration _____ days
 Distance from waterline to buoy deck ~65 cm

4561 stand range 1

ARRAY NAME AND NO. STATOS XI MOORED STATION NO. 1226

Surface Components			
Buoy Type <u>FOAM</u> Color(s) Hull Tower <u>YELLOW, BLUE BELOW WHITE-TOWER</u>			
Buoy Markings <u>VANE: WHITE USA 50P 54 1401. SAME ON HULL, + "IF FOUND CONTACT..."</u>			
Surface Instrumentation			
Item	ID #	Height*	Comments
HRH	247	226.5	ON LOGGERSN 4
BPR	503	236	
SWND	219	267.5	
PRC	207	250	
LWR	503	279.5	CLEANED 1142 APR 6'11
SWR	502	279.5	
SST-SBE37	2053		
HRH	250	226.5	ON LOGGERSN 4
BPL	212	236.5	
WND	238	267	
PRC	206	249	
LWR	224	279.5	
SWR	208	279.5	
SST-SBE37	1838		
HRH	248	224.5	
WND	239	266	
LASCAR HRH	1	232	
LASCAR HRH	2	201	
SBE 39	1447	232	
PCO2			
WAMIDAS	4002	MODEM 24297	IMEI 300124000010620
ARGDS MET PTT	12789	LGR 4	IDS 27916 27917 27918
ARGDS MET PTT	18171	LGR 14	IDS 27919 27920 27921
*Height above buoy deck in centimeters			

ARRAY NAME AND NO. Stratus X1 MOORED STATION NO. 1226

Item No.	Length (m)	Item	Depth	Inst No.	Time Over	Time Back	Notes
1		BUOY				2107	STOP H.A.H. HIT SIDE OF SHIP 537 SHIELDS BENT
2	.22	3/4" CHAIN					
3		SBE 37	2	1325	1226	2126	
4	.37	3/4" CHAIN					
5		SBE 37	3.7	1326	1226		
6		SBE 39	4.9	35	1226	2137	DOWN
7	1.3	3/4" CHAIN					
8		SBE 37	7	1328	1214		
9	1.73	3/4" CHAIN					S.W. VEC
10		ADCP ADREX	10	357	1212		TOTAL WY COV 66% W/ 60% W/ 67
11		SBE 39	11.25	38	1212		
12	.68	3/4" CHAIN					
13		ADCP ADCM	13	13	1211		HEADS UP
14	1.5	3/4" CHAIN					
15		SBE 37	16	1329	1211	2202	
16	2.7	3/4" CHAIN					
17		ADCP ADCM	20	78	1209		
18	3.66	3/4" CHAIN					
19		SBE 39	25	44	1207	2208	UP
20	3.9	3/4" CHAIN					
21		SBE 37	30	1330	1203		CLEAN SENSORS!
22	1.12	ADCP ADCM	30				
23		ADCP ADCM	32.5	79	1202	2211	
24	1.2	3/4" CHAIN					
25		SBE 39	35	48	1202		

ARRAY NAME AND NO. STRATUS XI MOORED STATION NO. 1226

Item No.	Length (m)	Item	Depth	Inst No.	Time Over	Time Back	Notes
26	3.9	3/4 CHAIN					
27		SBE 37	40	8211	1200	2218	
28	3.66	3/4 CHAIN					
29		AANDAA ADCM	45	138	1240	2008	SEAGUARD W OPTODE
30	16	7/16 WIRE					# 10242 24 B
31		SBE 39	46.5	49	1247	2006	
32		SBE 39	51	102	1248	2005	
33		SBE 39	56.5	103	1249	2003	
34		SBE 37	62.5	8212	1255	2000	
35	23.5	0 7/16 WIRE SBE 39	70	203	1300 1255	1959	# 10242 23 A
36		SBE 39	77.5	276	1301	1957	
37		SBE 37	85	1909	1303	1956	WITH P
38		ADCM	87.3	140	1312 1307	1954	AANDAA SEAGUARD W/OPTODE
39	41.25	7/16 WIRE					# 10242 -19
40		SBE 39	92.5	284	1315	1953	
41		SBE 39	100	719	1315	1952	
42		SBE 39	115	720	1316	1951	
43		SBE 37	130	8213	1319	1947	
44	4.5	7/16 WIRE					# 10242 22 A
45		ADCM	135	1218	1325	1943	RDI WORKHORSE
46	.38	3/4 CHAIN					
47	8	7/16 WIRE					# 10242 20 B
48		ADCM	145	141	1329	1939	AANDAA SEAGUARD, OPTODE <small>VERY MILD SOME ERRORS IN SERIAL</small>
49	13.5	7/16 WIRE					# 10242 25
50		SBE 37	160	8214	1333	1936	

ARRAY NAME AND NO. STATOS XI MOORED STATION NO. 1226

Item No.	Length (m)	Item	Depth	Inst No.	Time Over	Time Back	Notes
51	29	7/16 WIRE					# 10142 21 LOTS OF FISHING LINE
52		SBE 39	175	721	1324	1924	
53		SBE 39	183	1498	1326	1932	FISH HOOK WITH FOULING IN JAW GEAR
54		SBE 37	190	8215	1340	1929	
55	29	7/16 WIRE					# 10242 22
56		SBE 37	220	8216	1342	1925	
57	13.5	7/16 WIRE					# 10242 26
58		ADCM	235	142	1347	1921	FISHING GEAR AANDERAA SEAGUARD, OPTODE
59	13.5	7/16 WIRE					# 10242 27
60		SBE 39	236.5	1499	1347	1921	AT TERMINATION
61		SBE 37	250	8217	1356	1919	
62	38.5	3/8 WIRE					# 10242 15
63		SBE 39	280	1500	1359	1917	
64		ADCM-0	290	143	1405	1914	AANDERAA SEAGUARD W OPTODE
65	28	3/8 WIRE					# 10242 17
66		SBE 37	295	1906	1408	1913	SANIT SAND ↓ 2037
67		VMCM	320	4	1420	1907	BANDS OFF 1414 SPUN LINE IN PROPS in water 1420 PROPS STRAPPED FLASHING
68	26.5	3/8 WIRE					# 10242 18 MISC GEAR
69		OPTODE	322	691	1420	1907	in water 14:20 SW T SAND 2035
70		VMCM	349	31	1425	1902	bands off, spun 14:22 LINE IN PROPS ON RECOVERY
71	48.5	3/8 WIRE					10242-11 LOTS OF FISHING LINE
72		SBE 37	352	1908	1426	1900	
73		OPTODE	353	943	1429	1900	
74		SBE 37	361	2012	1430	1900	
75		ADCM-0	400	144	1431	1855	

ARRAY NAME AND NO. STRATUS XI MOORED STATION NO. 1226

Item No.	Length (m)	Item	Depth	Inst No.	Time Over	Time Back	Notes
76	48.5	³ 8 WIRE					LOTS OF FISHING LINE ON #1024214 THIS SITE
77		SBE 37 ADCM-0	401	2015	14:35	18:54	
78		ADCM-0	450	181	14:39	18:49	
79	48.5	³ 8 WIRE					#1024212
80		SBE 37	451	8218	14:39	18:48	FISHING LINE W+ AROUND SENSORS
81		SBE 37P	500	3733	14:43	18:44	WITH PRESS
82	100	³ 8 WIRE					#10242-9
83		ADCM-0	601	182	14:49	18:40	
84	200 200	³ WIRE SBE 37	602				#102425
85		SBE 37	602	8219	14:49	18:37	
86		SBE 37	700	8220	14:52	18:35	
87		VMCM	803	32	14:56	18:31	20 34 → PIN + BAND BANDS OFF SPIN 1452
88	48.5	³ 8 WIRE					#10242-10
89		VMCM	855	42	15:01	18:27	SPIN BAND 20 32 BANDS OFF SPIN 1458
90		SBE 37	857	8221	15:01	18:24	ON 10242-4
91	325	³ 8 WIRE				18:14	#10242-4
92		SBE 37	1000	8222 8222	15:09	18:19	CLAMP HAD TO BE REDRILLED FOR 3/8 WIRE
93	325	³ 8 WIRE					#10242-3
94		SBE 37	1355	8223	15:18	18:07	
95		VMCM	1507	62	15:24	17:58	BAND SPIN OFF SPIN 1519 2030 BAND
96	500	³ 8 WIRE					#10242-1
97		SBE 37	1557	8224	15:26	17:55	
98		SBE 37	2000	8225	15:39	17:41	CLEAN
99		VMCM	2010	83	15:40	17:39	ONE PROPELLER IS NOT SPINNING (LOWERS) BANDS OFF SPIN 1527 2028 SPIN + BAND
100	100	³ 8 WIRE			15:40	17:36	9074-6 WRAPPED TERMINATION

ARRAY NAME AND NO. Stratus XI MOORED STATION NO. 1226

Date/Time	Comments
ITEM# LENGTH	ITEM
200	7 BAYLOR WRAPPED TERMINATION 1719- 15:44 in water BASIC
1600	7 BAYLOR O/H BIT 1717-1626- START (200) 1557- START (300) 1717
1500	1" COCMEGA 1532- ~ 1630- START (300) 1717
5	88 GLASS BALLS 2012/5/29 BACK 144-1455 2012 5 29 1314 ON SUB 2 DONE 1741
5	CHAIN -1753
1	RELEASED (ON 1 M CHAIN) 2012/5/29 BACK 14556
5	CHAIN
20	NYETRON
5	CHAIN
	ANCHOR OVER 1928
2012 05 29 ~ 1405	SMALL BOAT TO HOOK ON TO BALLS
1419	HOOKED ON TO BALLS
1427	LINE TO BOAT - TO BALLS . 1441 BROKEN BALLS:

APPENDIX 5: Stratus 12 Mooring Log

Moored Station Log

(fill out log with black ball point pen only)

ARRAY NAME AND NO. STRATUS XII MOORED STATION NO. 1247

Launch (anchor over)

Date (day-mon-yr) 27 MAY 2012 Time 22:03:04 L
 Deployed by JLORD Recorder/Observer N GALBRAITH
 Ship and Cruise No. MELVILLE MV1207 Intended Duration 1 year
 Depth Recorder Reading 2442 4562.2 m MULTIBEAM DEPTH Correction Source CTD
 Depth Correction CTD fed to Seabeam m Sound speed 1503.3 m/s
 Corrected Water Depth 4538.97 m Magnetic Variation (E/W) 10.5
 Anchor Drop Lat. (N/S) 19° 56.333 Lon. (E/W) 85° 17.594
 Surveyed Pos. Lat. (N/S) 19 56.3064 Lon. (E/W) **85 17.5598**
 Argos Platform ID No. _____ Additional Argos Info on pages 2 and 3

Acoustic Release Model _____ Tested to _____

Release No. 1 (sn) <u>35316</u>	Release No. 2 (sn) <u>31335</u>
Interrogate Freq. <u>11</u>	Interrogate Freq. <u>11</u>
Reply Freq. <u>12</u>	Reply Freq. <u>12</u>
Enable <u>111 273</u>	Enable <u>471 427</u>
Disable <u>111 303</u>	Disable <u>471 442</u>
Release <u>127413</u>	Release <u>447756</u>

Recovery (release fired)

Date (day-mon-yr) _____ Time _____ U
 Latitude (N/S) _____ Longitude (E/W) _____
 Recovered by _____ Recorder/Observer _____
 Ship and Cruise No. _____ Actual duration _____ da

ARRAY NAME AND NO. STRATUS XII MOORED STATION NO. 1247

Item No.	Length (m)	Item	Depth	Inst No.	Time Over	Time Back	Notes
1		BODY			1507		HOI SPT, LOG PORT
2	.22	³ / ₄ CHAIN					
3		SBE 37	2	1904			
4	.37	³ / ₄ CHAIN					
5		SBE 37	3.7	1899			
6	1.95	³ / ₄ CHAIN			1444		
7		SBE 37	7	1901	1444		
8	1.95	³ / ₄ CHAIN					
9		NORTEK ADCP	10	1666	1442		1MHZ PROFILER
10	1.12	SAMPLET CHAIN ADCP	10				
11		SAMPLET ADCP	13	235	1440		SEAWARD
12	.6	³ / ₄ CHAIN					
13		NORTEK ADCP	15	2064	1438		2MHZ CM
14	↑	SBE 37P	16.4	7836	1438		
15	2.4	³ / ₄ CHAIN					
16		NORTEK ADCP	20	402	1428		2MHZ CM
17	3.23	³ / ₄ CHAIN					
18		SBE 39	25	1502	1426		
19	3.66	³ / ₄ CHAIN					
20		SBE 37	30	1902	1424		
21	1.35	³ / ₄ CHAIN					
22		NORTEK ADCP	32.5	333	1422		2MHZ PROFILER
23	.75	³ / ₄ CHAIN					
24		SBE 39	35	1509	1420		SEAWARD
25	3.66	³ / ₄ CHAIN					

ARRAY NAME AND NO. STRATUS XII MOORED STATION NO. 1247

Item No.	Length (m)	Item	Depth	Inst No.	Time Over	Time Back	Notes
26		SBE37	40	3821	1417		
27	3.66	³ / ₄ CHAIN					
28		NORTEK ADCM	45	1688	1414		2MHz CM
29	8.5	⁷ / ₁₆ WIRE		10242-28A			10242-28A 1412-
30		NORTEK ADCM	55	9883	1520		2MHz CM
31	6.1	⁷ / ₁₆ WIRE		11237-14			
32		SBE37	62.5	3824	1527		
33	21.1	⁷ / ₁₆ WIRE		11237-18			
34		SBE39	70	1511	1531		
35		SBE39	77.5	3423	1533		
36		SBE37	85	10	1538		
37	13.3	⁷ / ₁₆ WIRE					
38		SBE39	92.5	3434	1540		
39		VMCM	100	9	1559		1540 HANDS OFF
40	27.8	⁷ / ₁₆ WIRE					
41		SBE39	115	3435	1601		
42		SBE37P	120	8004	1603		
43	3.66	³ / ₄ CHAIN					
44		RDI ADCP	135	12254	1605		WORKHORSE 300kHz
45	8.5	⁷ / ₁₆ WIRE					
46		AAUDERAA ADCM	145	238	¹⁶¹⁰ / ₁₆₀₉		SENGUARD
47	13.5	RBR OKY WIRE					
48		RBR OKY	147	50026	¹⁶¹⁰ / ₁₆₀₉		
49		SBE37	160	1900	1614		
50	21.3	⁷ / ₁₆ WIRE					11237-16

ARRAY NAME AND NO. STRATOS XII MOORED STATION NO. 1247

Item No.	Length (m)	Item	Depth	Inst No.	Time Over	Time Back	Notes
51		SBE 39	175	3437	1616		
52		VMCM	183	10	1619		BANDS OFF SPIN 1617
53	4.8	7/16 WIRE					11237-15
54		SBE 37	190	1903	1623		
55	28.5	7/16 WIRE					11237-17
56		SBE 37	220	1905	1628		
57	13	7/16 WIRE					11237-18
58		VMCM	235	30	1635		1627 BANDS/SPIN
59	53	3/8 WIRE		11237-7			
60		SBE 37	250	1907	1636		
61		VMCM	290	35	1640		1635 BANDS OFF/SPIN
62	57	3/8 WIRE		11237-8			
63		SBE 37	310	2011	1642		
64		VMCM	350	38	1647		1641 BANDS/SPIN
65	500	3/8 WIRE		11237-1			11237-1
66		SBE 39	400	3438	1649		
67		SBE 39	450	3439	1654		
68		VMCM	852	58	1707		1704 BANDS/SPIN
69	500	3/8 WIRE		11237-2			
70	200	3/8 WIRE		1024224			
71		VMCM	1555	68	1728		1720 BANDS OFF SPIN
72	450	3/8 WIRE		11237-4			
73		VMCM	2008	73	1756	17	1733 BANDS OFF SPIN 11237-6 IS THE ADDED 59M STR/
74	53 100	3/8 WIRE	ONE PIECE	10242-6A WRAPPED	1801 TEAM		59M WIRE ADDED RATED ON SITE DEPTH
75	200	7/8 NYLON			1805	1811	

REPORT DOCUMENTATION PAGE	1. REPORT NO. WHOI-2012-08	2.	3. Recipient's Accession No.
4. Title and Subtitle Stratus 12 Twelfth Setting of the Stratus Ocean Reference Station		5. Report Date October 2012	
7. Author(s) S. Bigorre, R.A. Weller, et. al.		6.	
9. Performing Organization Name and Address Woods Hole Oceanographic Institution Woods Hole, Massachusetts 02543		8. Performing Organization Rept. No.	
12. Sponsoring Organization Name and Address National Oceanic & Atmospheric Administration		10. Project/Task/Work Unit No.	
		11. Contract(C) or Grant(G) No. (C)NA09OAR4320129 (G)	
		13. Type of Report & Period Covered Technical Report	
15. Supplementary Notes This report should be cited as: Woods Hole Oceanographic Institution Tech Report, WHOI-2012-08.		14.	
16. Abstract (Limit: 200 words) The Ocean Reference Station at 20°S, 85°W under the stratus clouds west of northern Chile is being maintained to provide ongoing climate-quality records of surface meteorology, air-sea fluxes of heat, freshwater, and momentum, and of upper ocean temperature, salinity, and velocity variability. The Stratus Ocean Reference Station (ORS Stratus) is supported by the National Oceanic and Atmospheric Administration's (NOAA) Climate Observation Program. It is recovered and redeployed annually. A NOAA vessel was not available, so this cruise was conducted on the Melville, operated by the Scripps Institution of Oceanography. During the 2012 cruise on the Melville to the ORS Stratus site, the primary activities were the deployment of the Stratus 12 WHOI surface mooring, recovery of the previous (Stratus 11) WHOI surface mooring, in-situ calibration of the buoy meteorological sensors by comparison with instrumentation installed on the ship, and collection of underway and on station oceanographic data to continue to characterize the upper ocean in the stratus region. Underway CTD (UCTD) profiles were collected along the track. Surface drifters and subsurface floats were also launched along the track.			
17. Document Analysis a. Descriptors UOP - Upper Ocean Processes Group Cruise On Board RV Melville Chile/Ecuador b. Identifiers/Open-Ended Terms c. COSATI Field/Group			
18. Availability Statement Approved for public release; distribution unlimited.		19. Security Class (This Report) UNCLASSIFIED	21. No. of Pages 118
		20. Security Class (This Page)	22. Price