



DEMONSTRATION Report
Munitions Management Projects

ESTCP Project MR-200809

**ALLTEM Multi-Axis Electromagnetic
Induction System Demonstration and Validation**

***Aberdeen Proving Ground Standardized
UXO Technology Demonstration Site***

**Theodore H. Asch (*tasch@usgs.gov*)
U. S. Geological Survey**

**17 November 2011
Version 1.0**

Report Documentation Page

Form Approved
OMB No. 0704-0188

Public reporting burden for the collection of information is estimated to average 1 hour per response, including the time for reviewing instructions, searching existing data sources, gathering and maintaining the data needed, and completing and reviewing the collection of information. Send comments regarding this burden estimate or any other aspect of this collection of information, including suggestions for reducing this burden, to Washington Headquarters Services, Directorate for Information Operations and Reports, 1215 Jefferson Davis Highway, Suite 1204, Arlington VA 22202-4302. Respondents should be aware that notwithstanding any other provision of law, no person shall be subject to a penalty for failing to comply with a collection of information if it does not display a currently valid OMB control number.

1. REPORT DATE 17 NOV 2011	2. REPORT TYPE	3. DATES COVERED 00-00-2011 to 00-00-2011			
4. TITLE AND SUBTITLE ALLTEM Multi-Axis Electromagnetic Induction System Demonstration and Validation		5a. CONTRACT NUMBER			
		5b. GRANT NUMBER			
		5c. PROGRAM ELEMENT NUMBER			
6. AUTHOR(S)		5d. PROJECT NUMBER			
		5e. TASK NUMBER			
		5f. WORK UNIT NUMBER			
7. PERFORMING ORGANIZATION NAME(S) AND ADDRESS(ES) U. S. Geological Survey, Denver Federal Center, Bldg. 20, MS-964, Denver, CO, 80225		8. PERFORMING ORGANIZATION REPORT NUMBER			
9. SPONSORING/MONITORING AGENCY NAME(S) AND ADDRESS(ES)		10. SPONSOR/MONITOR'S ACRONYM(S)			
		11. SPONSOR/MONITOR'S REPORT NUMBER(S)			
12. DISTRIBUTION/AVAILABILITY STATEMENT Approved for public release; distribution unlimited					
13. SUPPLEMENTARY NOTES					
14. ABSTRACT					
15. SUBJECT TERMS					
16. SECURITY CLASSIFICATION OF:			17. LIMITATION OF ABSTRACT Same as Report (SAR)	18. NUMBER OF PAGES 292	19a. NAME OF RESPONSIBLE PERSON
a. REPORT unclassified	b. ABSTRACT unclassified	c. THIS PAGE unclassified			

Executive Summary

An advanced multi-axis electromagnetic induction system, ALLTEM, has been specifically designed for detection and discrimination of unexploded ordnance (UXO). This work has been funded by ESTCP (Project MM-0809). ALLTEM uses a continuous triangle-wave excitation that measures the target step response rather than the more common impulse response. Ferrous and non-ferrous metal objects have opposite polarities. The system multiplexes through all three orthogonal (H_x , H_y , and H_z axes) transmitting loops and records a total of 19 different transmitting (Tx) and receiving (Rx) loop combinations with a spatial data sampling interval of 15 cm to 20 cm. This report presents the results of a demonstration and validation survey at the Aberdeen Proving Ground in March 2010. The U.S. Geological Survey operated ALLTEM with a Leica 1200 GPS over the Army's UXO Calibration and Blind Test Grids, the Direct Fire Area, and most of the Indirect Fire Area. Routines specifically developed for the ALLTEM in Oasis Montaj were used to analyze the ALLTEM data. This includes importing survey data, gridding, noise analysis for threshold determination, automatic selection of targets, batch inversion of selected targets using prolate, oblate, and ellipsoidal spheroids, and automatic statistical classification of inverted targets into clutter and targets of interest. Ongoing data analyses indicate that the ALLTEM is able to detect anomalous features and to automatically classify targets as being items of interest or not and then to discriminate between munitions types.

CONTENTS

1.0	INTRODUCTION	1	
1.1	Background	1	
1.2	Objectives of the Demonstration	2	
2.0	TECHNOLOGY		2
2.1	ALLTEM TECHNOLOGY DESCRIPTION	2	
2.2	ADVANTAGES AND LIMITATIONS OF THE TECHNOLOGY.....	4	
2.2.1	Advantages of the ALLTEM	4	
2.2.2	Limitations of the ALLTEM.....	4	
3.0	PERFORMANCE OBJECTIVES	5	
3.1	OBJECTIVE: DETECTION OF ALL MUNITIONS OF INTEREST	5	
3.2	OBJECTIVE: CLASSIFICATION OF ANOMALIES.....	6	
3.3	OBJECTIVE: DISCRIMINATION OF MUNITIONS OF INTEREST AND CLUTTER	7	
3.4	OBJECTIVE: LOCATION ACCURACY	7	
3.5	OBJECTIVE: PRODUCTION RATES.....	8	
3.6	OBJECTIVE: HIGH QUALITY DATA	8	
3.7	OBJECTIVE: EASE OF USE	9	
4.0	ABDERDEEN PROVING GROUND STANDARDIZED TEST SITE	9	
4.1	SURVEY AREAS OF INTEREST	9	
5.0	TEST DESIGN FOR ALLTEM SURVEYS	11	
5.1	CONCEPTUAL EXPERIMENTAL DESIGN.....	11	
5.2	SITE PREPARATION.....	12	

5.3	SYSTEM SPECIFICATION	12	
5.4	ALLTEM CALIBRATION ACTIVITIES	14	
5.5	DATA COLLECTION PROCEDURES	14	
5.5.1	Survey Scale.....	14	
5.5.2	Navigation and Orientation.....	14	
5.5.3	Data Recording and Archiving	18	
5.5.4	Quality Control	18	
5.5.5	Validation.....	22	
6.0	DATA ANALYSIS PLAN	23	
6.1	PREPROCESSING.....	23	
6.2	TARGET SELECTION FOR DETECTION.....	23	
6.3	PARAMETER ESTIMATION	24	
6.4	TRAINING	29	
6.5	CLASSIFICATION	29	
6.6	DATA PRODUCT SPECIFICATION	29	
7.0	COST ASSESSMENT.....	31	
8.0	SCHEDULE OF ACTIVITIES.....	32	
9.0	MANAGEMENT AND STAFFING.....	32	
10.0	REFERENCES		33

APPENDICES

A.	Health and Safety Plan.....	34
B.	Points of Contact.....	42

FIGURES

1. The ALLTEM 1-m sensor cube.....	3
2. ALLTEM at the YPG Standardized UXO Test Area.	4
3. AHRS and GPS antenna on nose of new cart.	17

TABLES

1. Performance Objectives.....	6
2. APG Survey Schedule.....	11
3. Sample Background/Noise Thresholds.....	24
4. Sample final data product	30
5. Cost Model for the ALLTEM Demonstration Survey.....	31

1.0 INTRODUCTION

1.1 Background

Unexploded ordnance (UXO) is one of the most pressing problems facing the Department of Defense (DoD) and other government agencies that have lands that were once used for military training and are now closed or closing and being transferred to civilian or non-DoD government use. Cleanup of all UXO-contaminated lands using existing methods would be prohibitively expensive, so a great deal of effort is being directed to finding better ways to detect, locate and identify buried UXO. It is not sufficient to merely detect buried metal objects, because many of these objects are not UXO and pose no hazards. In many cases of range cleanup 70% or more of the cost consists of locating and removing harmless metal including soda cans, broken parts from agricultural equipment and fragments of ordnance that exploded as designed. Among the primary geophysical methods for detection and classification are various time and frequency domain electromagnetic induction (EMI) systems and magnetometers.

This project follows SERDP Project MM-1328. In that project one prototype magnetic system, the TMGS, and two prototype EMI instruments, VETEM and the High Frequency Sounder, were evaluated. Subsequent to the evaluations, it was decided that a new multi-axis EMI system using a triangle-wave excitation should be designed, built, and tested. Specifically, we recommended that we should:

1. Build a multiple component on-time, time domain electromagnetic induction system using a triangle current wave excitation and analyze the data by time-domain methods. This system is able to record at much later times than VETEM and the earth's electrical conductivity response has decayed to essentially zero at these later times. The new system is named "ALLTEM" because it is a time domain electromagnetic (TEM) system in which the transmitter current is on all the time.
2. Develop analytical methods for extracting as much target information as possible from ALLTEM with the aim of identifying the targets and discriminating between UXO and harmless metal scrap.

A preliminary demonstration of ALLTEM at the Yuma Proving Ground (YPG) over the Calibration Lanes only was done in 2005. After some improvements, ALLTEM was demonstrated again over both the Calibration Lanes and the Blind Test Grid at YPG in May, 2006. After data processing and inversion using our USGS-developed inversion algorithm, a target spreadsheet for the Blind Test Grid was submitted to the Institute for Defense Analyses (IDA) for scoring. The results were encouraging.

A third demonstration survey was conducted at YPG in February 2009 over the Calibration and Blind Test grids and 5 acres of the Open Field Area. These results have recently been submitted for scoring and analysis to ESTCP/IDA and AEC. Several new issues with the GPS and the system were encountered during this operation that have since been resolved. In addition, the inversion analysis software has been redesigned and is now fully implemented into the ALLTEM data analysis and processing stream.

1.2 OBJECTIVE OF THE DEMONSTRATION

The demonstration and validation described by this document employed the ALLTEM system, with further enhancements beyond the system used in 2006 and 2009, at a controlled test site, the Aberdeen Proving Ground Standardized UXO Test Site. The Calibration Lanes, the Blind Test Grid, and the Direct and Indirect Fire areas at APG were surveyed. This report includes analysis of our data and the IDA scoring results for the Blind Test Grid and the Direct and Indirect Fire areas.

In the APG demonstration work plan, we proposed to address the issue of added benefit when using the ALLTEM by trying to answer the following questions:

1. How well did ALLTEM detect the known targets?
2. How many false positives were produced?
3. How well did ALLTEM perform in locating each target?
4. How well can one distinguish between ferrous, non-ferrous, and mixed composition targets from ALLTEM data?
5. How well can one estimate target shape?
6. How well can one estimate target depth and orientation?
7. How well can one distinguish between MEC and clutter?
8. How efficient is ALLTEM in the field?

These questions will be addressed in turn in the analysis sections below.

2.0 TECHNOLOGY

This section presents an overview of the ALLTEM technology.

2.1 ALLTEM TECHNOLOGY DESCRIPTION

The ALLTEM system is an on-time time domain electromagnetic induction (EMI) system that generates and records data in multiple channels in multiple directions (Figure 1). The system is unusual in that the transmitting (Tx) loops are driven by a continuous triangle current waveform and the resulting electromagnetically induced target responses are treated in the time domain. The measured quantity is the voltage in receiving (Rx) induction loops. This is theoretically equivalent to an integration of the voltage measured by a conventional EMI system that relies on a rapid current turn-off in a Tx loop. Practically, the use of a triangle wave results in much smaller early-time voltages induced in the Rx loops, reducing dynamic range demands on the receiver analog electronics and the digitizer. Another useful consequence is that ferrous and non-ferrous targets show distinctly different waveforms (Wright et al., 2005 and 2006). The UTEM system developed at the University of Toronto some years ago was a pioneer in the use of a triangle waveform in EMI systems (West et al., 1984) and has a theoretical advantage of emphasizing highly conducting targets buried in a less conductive host (Smith and Annan, 1998). ALLTEM is intended to obtain the advantages of triangle wave excitation in a system whose dimensions, characteristics, and geometry are appropriate to UXO applications.

Beyond detection of metal objects, the ability to discriminate between UXO and non-UXO targets is a critically important goal, because in many cases more than 70 per cent of range clearance costs are attributed to digging up harmless scrap metal that could have been left in the ground. An ideal UXO EMI system would not only have a very high probability of detection, but also the ability to discriminate irregular or “plate-like” shapes from “rod-like” ferrous objects that likely are UXO. Some UXO items are composites of ferrous and non-ferrous parts, but, unlike landmines, there is little incentive to eliminate ferrous materials, thus the great majority of UXO items have significant ferrous metal content. As we have already mentioned, a very useful consequence of the triangle waveform is an ability to easily distinguish between ferrous and non-ferrous metals. As a further aid to discrimination, we have designed ALLTEM with a multi-axis capability. There are three orthogonal Tx loops, an array of five Rx loops on the top and bottom of a 1 m cube, and Rx loops on each of the four vertical sides of the cube as shown in Figure 1. Voltage outputs of loops on opposite sides of the cube are subtracted to remove the large primary field response.

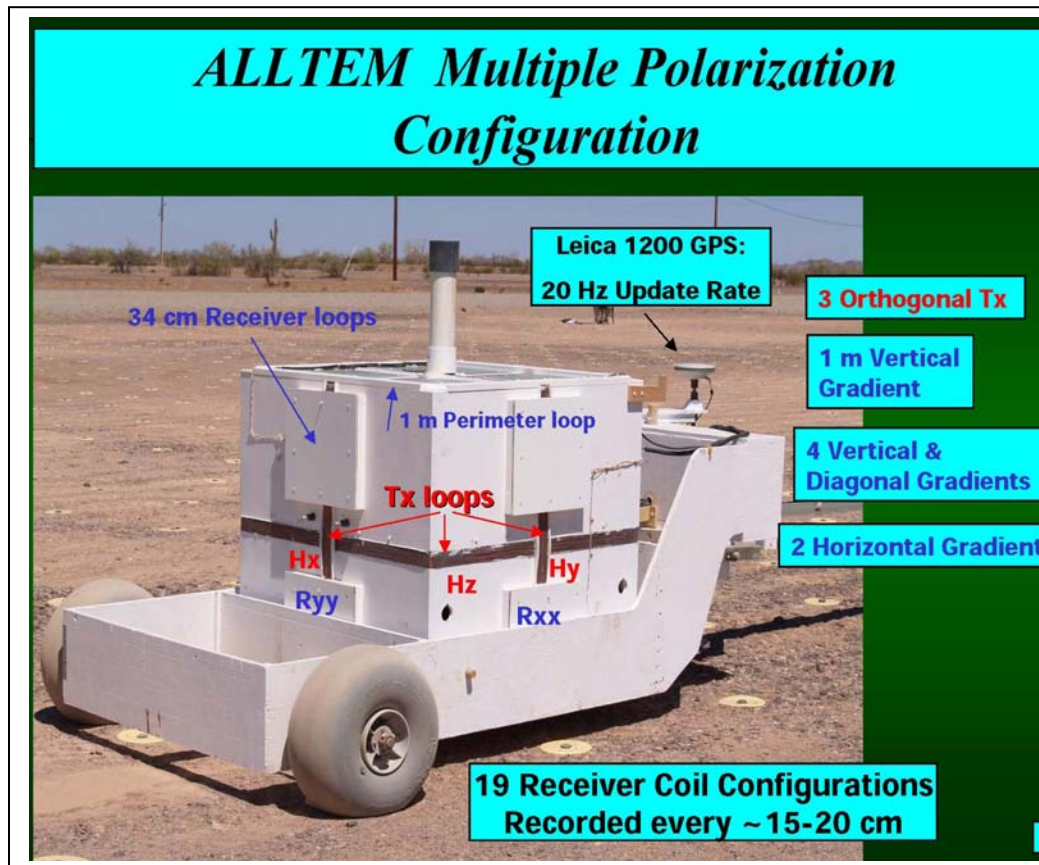

Figure 1: The ALLTEM 1-m sensor cube. The Tx loops produce orthogonal magnetic fields in three directions (H_x , H_y , H_z). The top and bottom faces contain a 1-m square Rx loop around the perimeter and four 34-cm printed circuit board Rx loops on 50 cm centers. Each vertical face has two 34-cm Rx loops to measure fields in the two horizontal directions (H_x and H_y). Because a transmitter is always on, opposite Rx loops are paired as gradiometers to cancel the primary field.

ALLTEM was tested at YPG in 2005 and 2006 (Figure 2) with good results.



Figure 2. ALLTEM at the YPG Standardized UXO Test Area.

2.2 ADVANTAGES AND LIMITATIONS OF THE TECHNOLOGY

2.2.1 Advantages of the ALLTEM

1. Data is acquired in dynamic mode at 1 m/sec which is faster than repeat surveys with cued mode.
2. As mentioned above, the triangle source wave reduces the required dynamic range of the electronics.
3. Ferrous and non-ferrous targets show distinctly different waveforms.
4. Attitude and heading system (AHRS) allows for better determination of transmitter and receiver coil locations and orientations.

2.2.2 Limitations of the ALLTEM:

1. Not man-portable. Must be pulled by a tractor.
2. Does not perform real-time inversion of targets during acquisition. Data must be processed using custom Oasis Montaj ALLTEM gx's. This is done fast and efficiently after acquisition but, currently, not during acquisition.
3. ALLTEM is not waterproof but works well under a plastic tarp.

3.0 PERFORMANCE OBJECTIVES

Performance objectives are a critical component of a demonstration plan. They provide the basis for evaluating the performance and costs of the technology. Performance objectives are the primary criteria established by the investigator for evaluating the innovative technology. Meeting these performance objectives is essential for successful demonstration and validation of the technology.

Performance objectives for this ALLTEM demonstration are summarized in Table 1.

3.1 OBJECTIVE: DETECTION OF ALL MUNITIONS OF INTEREST

The effectiveness of the technology for detection and discrimination of munitions is a function of the degree to which all munitions of interest are detected with high confidence.

3.1.1 Metric

Compare the number of targets detected to the number of actual targets present to determine the percent detected of seeded items. This will be accomplished by the USGS only for the Calibration Grid data as this is the only data set for which we know the locations of all the seeded items. This task will be left to others for the Blind Test Grid and the Direct and Indirect Fire Areas.

3.1.2 Data Requirements

The locations of the seeded items in the Calibration grid are required. "Locations" refers to easting, northing, depth, and orientation (azimuth and dip). Additional data requirements for the Blind Test grid and Open Field area will be a prioritized dig list.

3.1.3 Success Criteria

The objective will be considered to be met if more than 95% of the seeded targets are detected for each of the testing areas.

Table 1. Performance Objectives

Performance Objective	Metric	Data Required	Success Criteria
Quantitative Performance Objectives			
Detection of all munitions of interest	Percent detected of seeded items	<ul style="list-style-type: none"> • Location of seeded Items • Prioritized dig list 	$Pd \geq 0.95$
Classification of anomalies	Percent of munitions classified as munitions and percent of clutter classified as clutter	<ul style="list-style-type: none"> • Prioritized dig list with probabilities 	Percent of munitions and clutter classified correctly >95%
Discrimination by type of munitions of interest	Percent of targets correctly identified	<ul style="list-style-type: none"> • Prioritized dig list with a subset of probabilities that identifies type of target. 	Percent of munitions correctly identified >90%
Location accuracy	Average error in northing and easting for seed items	<ul style="list-style-type: none"> • Location of seed items Surveyed to accuracy of 2 cm • Estimated location from analysis of geophysics data 	ΔN and $\Delta E < 0.10$ m
Production rates	Number of acres of data collection per day Time required to analyze each target	<ul style="list-style-type: none"> • Log of field work and data analysis time accurate to 15 minutes 	Survey: ~1.5 to 2 acres per day depending on survey speed Analysis time: <15 minutes per target
Qualitative Performance Objectives			
High quality data	Low system noise and few GPS drop outs.	<ul style="list-style-type: none"> • Maps of gridded data. 	Maps of gridded data are "clean".
Ease of use	Efficient and effective acquisition of ALLTEM data	<ul style="list-style-type: none"> • Feedback from technician on usability of technology and time required 	Data is successfully acquired in specified time.

3.2 OBJECTIVE: CLASSIFICATION OF ANOMALIES

The effectiveness of the technology for detection and discrimination of munitions is a function of the degree to which responses that do not correspond to targets of interest can be eliminated with high confidence.

3.2.1 Metric

Determine the percent of actual munitions classified as munitions and the percent of actual clutter classified as clutter.

3.2.2 Data Requirements

A prioritized dig list with probabilities divided into groupings of clutter, munitions of interest, determination cannot be confidently made, and no determination can be made regarding the nature of the target.

3.2.3 Success Criteria

The objective will be considered to be met if the percent of munitions and clutter correctly classified exceeds 95%. Items noted as “Can’t Say” and “Can’t Analyze” will be treated as False Positives.

3.3 OBJECTIVE: DISCRIMINATION OF MUNITIONS OF INTEREST AND CLUTTER

The effectiveness of the technology for detection and discrimination of munitions is a function of the degree to which individual responses can be identified with high confidence by munition type.

3.3.1 Metric

Determine the percent of munitions identified correctly.

3.3.2 Data Requirements

A prioritized dig list with probabilities divided into groupings of clutter, labeled-munitions of interest, determination cannot be confidently made, and no determination can be made regarding the nature of the target.

3.3.3 Success Criteria

The objective will be considered to be met if the percent of munitions correctly identified exceeds 90%. This criterion is lower than the classification listed in section 3.2.3 because previous analysis results showed that when the signal to noise ratio is too low, accurate determination of munitions type is not always possible.

3.4 OBJECTIVE: LOCATION ACCURACY

The effectiveness of the technology for detection and discrimination of munitions is a function of the degree to which the anomalous responses are accurately located.

3.4.1 Metric

Determine the average error of the northing and easting for seed items.

3.4.2 Data Requirements

A prioritized dig list with locations of anomalies in easting and northing surveyed to an accuracy of 2 cm. The estimated locations will come from an analysis of the acquired ALLTEM data.

3.4.3 Success Criteria

The objective will be considered to be met if the easting and northing locations of the seeded items have an error of less than 0.10 m.

3.5 OBJECTIVE: PRODUCTION RATES

The effectiveness of the technology for detection and discrimination of munitions is a function of the how quickly and efficiently the area of interest can be surveyed and the data analyzed and interpreted.

3.5.1 Metric

The number of acres of data collection per day and the time required to analyze the data and determine the target properties.

3.5.2 Data Requirements

Field logs describing the data acquisition schedule and data analysis logs detailing individual times for each target.

3.5.3 Success Criteria

The objective will be considered to be met if approximately 1.5 to 2 acres are surveyed per day. This is a function of the survey speed (1.0 m/sec). The goal for analysis time is approximately less than 15 minutes on the average per target identified.

3.6 OBJECTIVE: HIGH QUALITY DATA

The effectiveness of the technology for detection and discrimination of munitions is a function of the quality of the data.

3.6.1 Metric

The measurement of high quality data is the degree to which systematic noise is present in the data and the GPS data is continuous.

3.6.2 Data Requirements

Maps of gridded data will indicate the quality of the data in terms of both system noise and GPS drop-outs.

3.6.3 Success Criteria

The objective will be considered to be met if approximately the gridded data maps show very little to no striping and no gaps in coverage indicating GPS drop-outs.

3.7 OBJECTIVE: EASE OF USE

The effectiveness of the technology for detection and discrimination of munitions is a function of how easy the ALLTEM system is to operate and the analysis software is to use.

3.7.1 Metric

The measurement of ease of use is that the ALLTEM operator is able to efficiently and effectively acquire the data the data analysis using Oasis Montaj goes smoothly.

3.7.2 Data Requirements

Feedback from the acquisition and analysis operators.

3.7.3 Success Criteria

The objective will be considered to be met if the data is successfully acquired in the specified estimated time.

4.0 ABERDEEN PROVING GROUND STANDARDIZED TEST SITE DESCRIPTION

The following description is copied from <http://aec.army.mil/usaec/technology/uxo01c02.html>.

The APG Standardized Test Site is located within a secured range area of the Aberdeen Proving Ground. The Aberdeen Area of APG is located approximately 30 miles northeast of Baltimore at the northern end of the Chesapeake Bay. The Standardized Test Site encompasses 17 acres of upland and lowland flats, woods and wetlands. The site layout is presented in Figure 3.

4.1 SURVEY AREAS OF INTEREST

4.1.1 Calibration Lanes (0.30 acres)

The calibration portion of the test site consists of at least nineteen (19) lanes. This area contains 14 standard munitions items (Table 2) buried in six positions, with representation of clutter, at various angles and depths to allow demonstrators to calibrate their equipment.

Table 2. Items in APG Calibration Grid.

Type	Description	Length (mm)	Width (mm)	Aspect Ratio	Weight (lbs)
20 MM	20 MM M55	25	20	1.25	0.25
40MM	40 MM MK II	179	40	4.48	1.55
40MM	40 MM M385	80	40	2.00	0.55
M42	SUBMUNITION	62	40	1.55	0.35
BLU-26	SUBMUNITION	66	66	1.00	0.95
BDU-28	SUBMUNITION	97	67	1.45	1.70
57MM	57MM M86	170	57	2.98	6.00
MK118	MK118 ROCKEYE	344	50	6.88	1.35
60MM	60 MM M49A3	243	60	4.05	2.90
81MM	81MM M374	480	81	5.93	8.75
M230	2.75" ROCKET	761	75	10.15	18.20
105MM	M456 HEAT RD	640	105	6.10	19.65
105MM	105MM M60	426	105	4.06	28.35
155MM	155MM M483A1	870	155	5.61	56.45

4.1.2 Blind Test Grid (0.50 acres)

The APG Blind Test Grid (BTG) consists of a 1600 square meter area that is located east of the open field range. The BTG is made up of the same type of munitions found in the Calibration Lanes and Open Field Site. Clutter items may include metal debris, rocks, vegetation roots, etc.

4.1.3 Open Field (10 acres)

The Open Field area is the largest of the test areas at APG Standardized UXO Technology Demonstration Site and measures approximately 200 by 350 meters (10 acres). The area provides the demonstrator with a variety of realistic scenarios essential for evaluating sensor system performance. The scenarios and challenges found on this Open Field area consist of a gravel road, wet areas, dips, ruts and trees. Vegetation height varies from 15 to 25 centimeters. Other challenges that may be found on an open field site include electrical lines, swales, stone pads/roads, and metallic fencing that test the capabilities of the platform systems

Recently the Open Field area was reconfigured to emulate typical impact area conditions. The Open Field area is now divided into four subareas: Legacy, Indirect fire, Direct fire, and Challenge. The Legacy and Challenge areas will not be surveyed.

- Open field (indirect fire)

The indirect fire subarea contains only three munition types that could be typically found at an impact area of an indirect fire weapons range. These are 81 mm and 60 mm mortars and 105

M60 projectiles. Munitions and clutter are placed in a pattern typical for a target area characteristic of these munitions.

- Open field (direct fire)

The direct fire subarea contains only three munition types that could be typically found at an impact area of a direct fire weapons range. These are 25 mm, 37 mm, and 105 HEAT projectiles. Munitions and clutter are placed in a pattern typical for a target representative of these munitions.

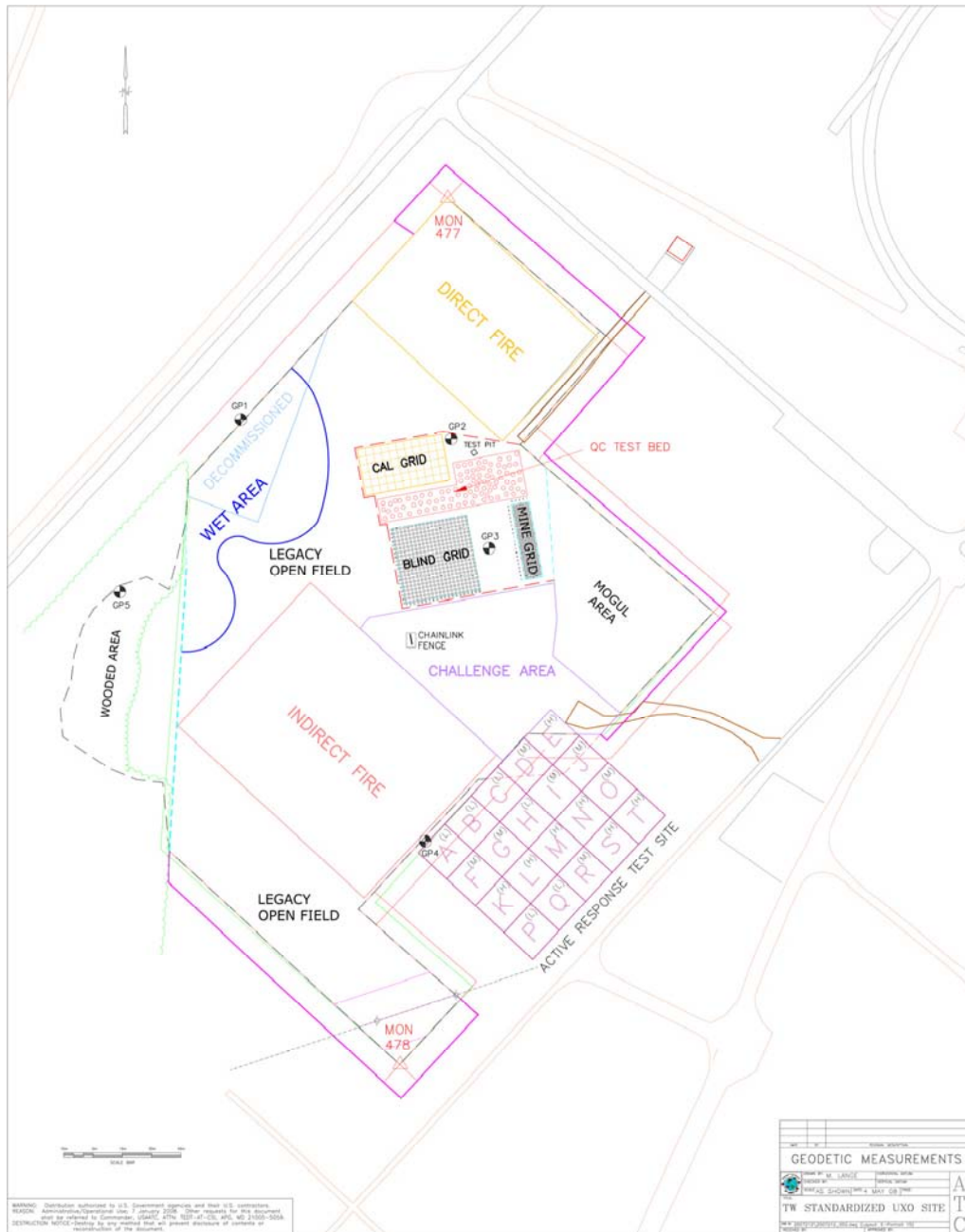

Figure 3. APG Standardized Test Site

5.0 TEST DESIGN FOR ALLTEM SURVEYS

This section provides a detailed description of the field test that will address the performance objectives described in Section 3.0.

5.1 CONCEPTUAL EXPERIMENTAL DESIGN

The overall design of this geophysics field investigation is to mobilize from Denver, Colorado to the Aberdeen Proving Ground in about 3 days, survey the Calibration and Blind Test grids on the first couple of full field days, and then survey either the Indirect or Direct Fire Areas during the remainder of the time available on the site. The data acquired over the Calibration grid will be analyzed and compared to previous ALLTEM Calibration grid survey results to verify system and analysis performance.

Key aspects of the overall approach for successful evaluation of the ALLTEM include all of the performance objectives listed in Table 1. These are good detection, classification, and discrimination results based on data that are accurately and precisely located and acquired and processed in a timely manner. The details of these aspects are discussed below in the following sections.

Table 3. APG Survey Schedule

Sunday	Monday	Tuesday	Wednesday	Thursday	Friday	Saturday
2/28 Mob to APG	3/1 Mob to APG	3/2 Arrive APG, Orient, Unpack, Setup	3/3 Survey Calibration Grid	3/4 Survey Blind Test Grid; Begin Survey of Indirect Fire Area	3/5 Continue Survey of Indirect Fire Area	3/6 No Access to Site, Process Calibration and Blind Test Grids
3/7 No Access to Site, Process Calibration and Blind Test Grids	3/8 Continue Survey of Indirect Fire Area	3/9 Finish Survey of Indirect Fire Area, Begin Survey of Direct Fire Area	3/10 Finish Survey of Direct Fire Area in morning, Pack up	3/11 Demob back to Denver	3/12 Demob back to Denver	3/13 Return to Denver

Table 3 lists the actual survey schedule as it played out. Mobilization and demobilization from the site required about 2.5 days each way. The following paragraphs present a listing of the survey activities by day.

Feb. 28 – Mar 2. Mobilized from Denver, CO to Aberdeen Proving Ground, MD.

Mar. 2. ALLTEM Team arrives, gets badges, drives to site, receives safety training, unpack and inspect equipment, site and clean up GPS base station location (it was under a foot of water and mud).

Mar. 3. Finish assembly and calibration of ALLTEM and survey the Calibration Grid. ALLTEM operated at a speed of 100 cm/s while multiplexing the TX coils and recording data in three axes. Nominal line spacing of 50 cm was for these surveys. To conserve time, lines were acquired in “moving race-track” fashion.

Mar. 4. Survey Blind Test Grid and begin survey of the Indirect Fire Area. Completed about 0.50 acres (2000 m²) of the IF area.

Mar. 5. Determined source of GPS dropout problem and then repaired bad GPS antenna cable (this reduced the production survey time). Continued survey of Indirect Fire Area. Completed about 0.72 acres (2915 m²).

Mar. 6 - 7. Did not have access to the field site. So processed data acquired thus far – Calibration Grid, Blind Test Grid and portion of Indirect Fire Area.

Mar. 8. Continue survey of Indirect Fire Area. Completed about 1.6 acres (6475 m²).

Mar. 9. Finish surveying Indirect Fire Area. Completed about 0.40 acres (1615 m²). Redo lines with poorer data. Start survey of the Direct Fire Area. Completed about 50% of area (0.90 acres, 3642 m²).

Mar. 10. Finish surveying Direct Fire Area. Completed about 0.9 acres (3640 m²). Provide copies of raw data. Disassemble ALLTEM and pack for trip back to Denver.

Mar. 11 - 13. Demobilized back to Denver from APG.

5.2 SITE PREPARATION

The APG UXO test site has been developed and prepared by the Army Environmental Center and APG personnel.

5.3 SYSTEM SPECIFICATION

As discussed above in Section 2.1, the ALLTEM system is an on-time time domain electromagnetic induction (EMI) system that generates and records data in multiple channels in multiple directions resulting in a total of nineteen (19) channels. The transmitting (Tx) loops are driven by a continuous triangle current waveform and the resulting electromagnetically induced target responses are treated in the time domain. The measured quantity is the voltage in receiving (Rx) induction loops.

The triangle waveform frequency can be varied under software control, but for several reasons we have settled on 90 Hz for field work. First, a half-period at 90 Hz is long enough to measure time decays for most UXO objects. Second, higher frequencies require higher driving voltages to maintain the same current amplitude. Third, while averaging waveforms over three cycles at 90 Hz greatly reduces 60 Hz interference, waveform data were averaged over only one cycle in order to increase our survey speed to 1.0 m/s. To minimize 60 Hz interference, the triangle wave frequency should be $(n+1/2) \cdot 60$ Hz where “n” is an integer, i.e. 30 Hz, 90 Hz, 150 Hz, etc. Finally, 90 Hz allows us to do some waveform averaging before recording, yet retain good spatial data density.

The Tx loops are each 66 turns and the current waveform that we apply to these loops is symmetric about zero amperes. In 2008 we replaced the CROWN power amplifier used to develop the system with a much more efficient Class D amplifier. This change enables us to increase the peak current to around 11 A while producing much less heat and without requiring as large a generator for power. The factor that determines the actual peak amperage is the ambient temperature of the transmitter coils. In the middle of December in Denver the temperatures could be around 10-20 deg F. This has been observed to cause clipping of the transmitted signal when running at 12 A and so we reduced the current output to 11 A. The peak Tx loop moment in this case is thus around $725 \text{ A} \cdot \text{m}^2$. Each Rx loop has 200 turns. A higher voltage gain is applied to the 34-cm Rx loop outputs than to the 1-m Rx loops so that the voltage inputs to the digitizer for the same target are comparable regardless of the Rx loop size.

The digitizer has eight simultaneous channels digitizing to 24 bits at a rate of 100 kilosamples/s. The 90 Hz triangle wave frequency is derived from the digitizer clock frequency to keep everything phase locked. A spatial data interval of 20 cm or less is used for each recorded channel along a line to ensure that each Rx gradiometer loop pair has more than one “look” at even the smallest and shallowest target it may pass over.

The names and receiver antenna geometries for each of the X, Y, and Z transmitter drives are:

X Drive on:

XZM X drive on, Z field measured, 1.00 m receiver antenna pair
 XZE X drive on, Z field measured, 0.35 m front right-back left receiver antenna pair
 XZF X drive on, Z field measured, 0.35 m front left-back right receiver antenna pair
 XZG X drive on, Z field measured, 0.35 m back left-front right receiver antenna pair
 XZH X drive on, Z field measured, 0.35 m back left-front right receiver antenna pair
 XX1 X drive on, X field measured, 0.35 m left-right side receiver antenna pair

Y Drive on:

- YZM Y drive on, Z field measured, 1.00 m receiver antenna pair
- YZE Y drive on, Z field measured, 0.35 m front right-back left receiver antenna pair
- YZF Y drive on, Z field measured, 0.35 front left-back right receiver antenna pair
- YZG Y drive on, Z field measured, 0.35 m back left-front right receiver antenna pair
- YZH Y drive on, Z field measured, 0.35 m back left-front right receiver antenna pair
- YY1 Y drive on, Y field measured, 0.35 m front-back side receiver antenna pair

Z Drive on:

- ZZM Z drive on, Z field measured, 1.00 m receiver antenna pair
- ZZE Z drive on, Z field measured, 0.35 m front right-back left receiver antenna pair
- ZZF Z drive on, Z field measured, 0.35 m front left-back right receiver antenna pair
- ZZG Z drive on, Z field measured, 0.35 m back left-front right receiver antenna pair
- ZZH Z drive on, Z field measured, 0.35 m back left to front right receiver antenna pair
- ZX1 Z drive on, X field measured, 0.35 m left-right side receiver antenna pair
- ZY1 Z drive on, Y field measured, 0.35 m front-back side receiver antenna pair

These designations are described graphically in Figure 4.

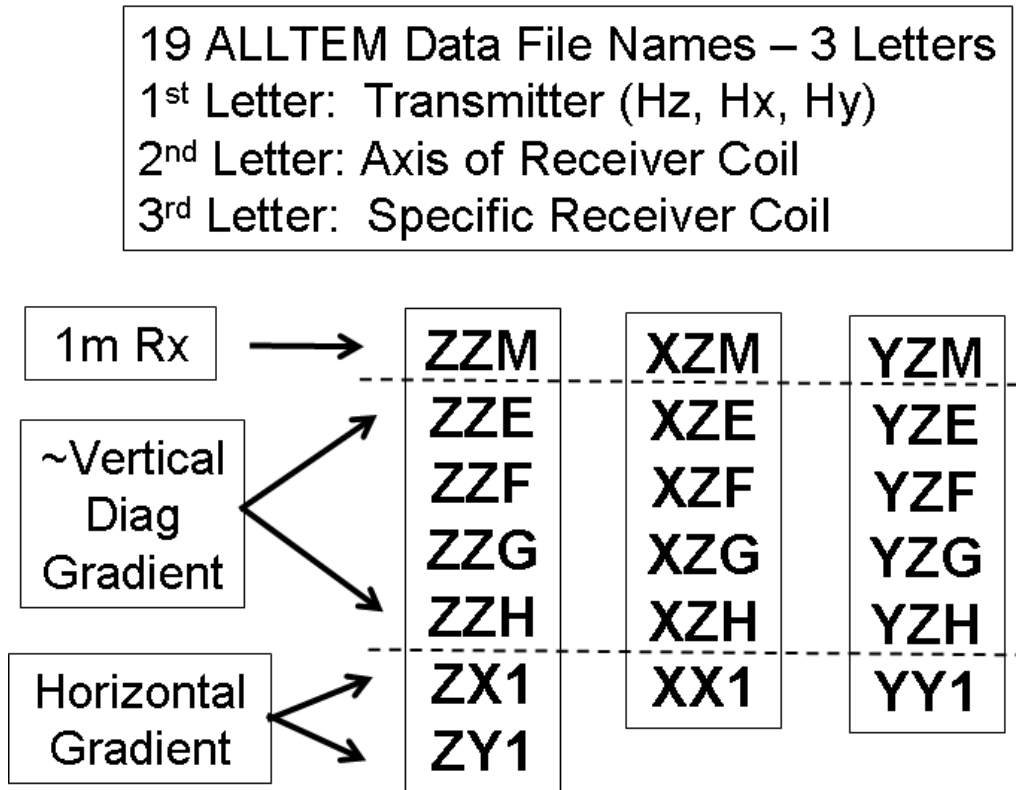

Figure 4. Naming convention for the ALLTEM transmitter and receiver combinations.

The data acquisition software, written using the National Instruments LabVIEW workbench, allows the operator to select the receiver channel/s to display in real time and view raw waveforms or a strip-chart style display of sums and differences between amplitudes near the

beginning and end of the waveforms. The latter style can be useful for ferrous/non-ferrous target discrimination. All viewing options are also available when playing back recorded data.

5.3.1 ALLTEM Data Density Along A Survey Traverse

Figure 5 shows the spatial and timing relationships of the polarity sequences for a section of a survey line when the ALLTEM system is moving at 1.0 m/sec with averaging of one group of three waveforms. Each polarity repeats its sequence every 400 ms (33.333 ms/group for 4 groups/polarity for 3 polarities).

ALLTEM data density when surveying at 1.0 m/sec with the transmitter sequence repeating every 400 ms is 0.20 m. Each transmitter is 'on' for 5 cm of the 20 cm and the approximate distance traversed between transmitter on-times (the time when all transmitters are turned off and the next turned on) is 0.017 m.

5.3.2 GPS Data Density

In the middle of figure 5 is an enlarged view of an excerpt of the time and spatial data for a waveform sequence. GPS data streams in from the Leica GPS 1200 rover asynchronously to the acquisition system and reports a location every 50 ms (Leica's 20-Hz update rate). The GPS values that are stored with the ALLTEM data are the positions that are closest to the middle of the waveform sampling period. The 0.20 m repeating transmitter sequences (when the three waveforms are averaged together and stored at the end of the sequence) results in the locations of the seven Hz transmitter-receiver combinations, six Hx transmitter-receiver combinations, and six Hy transmitter-receiver combinations being written to file every 0.20 m.

It is common for TEM systems to implement binning of one or several "time-gates" with digital or analog signal averaging to improve the SNR in each time gate. However, the ALLTEM records all the points along the waveforms at the full 10 μ s/sample rate. To improve SNR we may average waveform groups provided that we retain adequate spatial data density.

In order to most faithfully preserve waveform shapes it would be ideal to dispense with all analog hardware filters. However, in most environments that have noise no all filters can be removed. Three types of hardware filters may or may not be used depending on the noise at a particular field site. A high-pass filter with a cut-off at 1 Hz blocks amplifier DC offsets. A Bessel 2-pole low-pass filter, designed for little or no overshoot when a voltage step is applied, and whose cutoff frequency is selectable at 5, 7, 17, or 90 kHz limits high-frequency noise. We almost always use 5, 7, or 17 kHz to reduce radio (Very Low Frequency stations in the 20+ kHz range and other) interference. The digitizer we are using has a powerful 50 kHz low pass 8th order "brick wall" filter to prevent any possible aliasing.

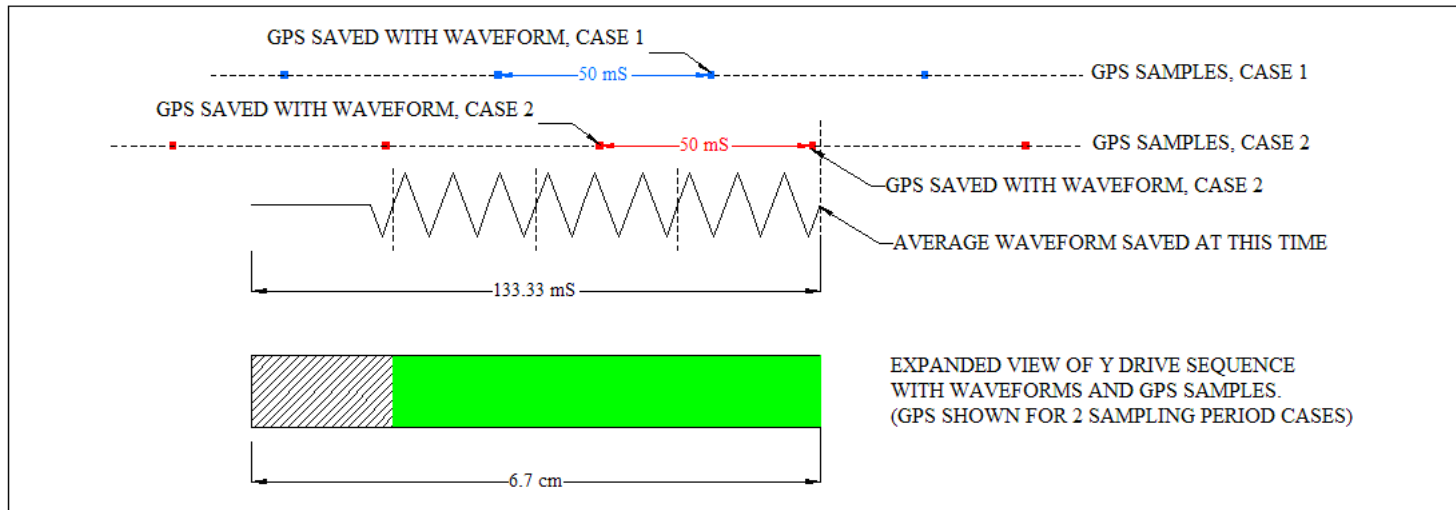
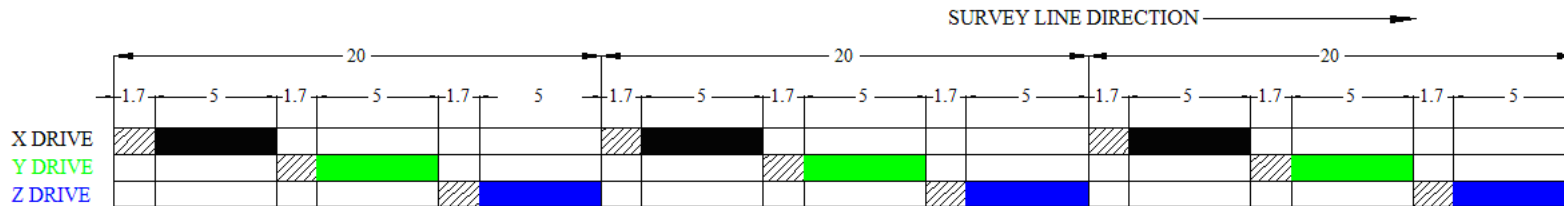

LEGEND:

- = DEADBAND PERIOD FOR RELAY SWITCHING
- = X COIL DRIVE ON
- = Y COIL DRIVE ON
- = Z COIL DRIVE ON

ALL LENGTH DIMENSIONS ARE IN CENTIMETERS
 LENGTHS SHOWN ARE FOR SURVEYING AT 0.5 M/SEC

Figure 5. Schematic describing ALLTEM spatial data density along a survey traverse. Illustrated are the distances over which each drive coil is transmitting and when the GPS locations are stored. Distances are in cm.

5.4 ALLTEM CALIBRATION ACTIVITIES

The methods used to confirm that the equipment was operating properly and that meaningful data were recorded included daily standardization checks of system functionality and system responses. All standardization checks were recorded in a field log book. The usual daily procedure included:

- Warm up 15-30 minutes - Allow the electronics and transmitter coils to stabilize.
- Static standardization test – Record background readings (500 samples) without a target.
- Static standardization test – Record with steel and brass balls (4-inch spheres) on top, sides of ALLTEM for about 500 samples each.
- Dynamic standardization test (first day) – Up and back, fast and slow traverses over surface-buried steel ball to check GPS positioning.

After the 15-30 minute warm up period that depended on the weather about 400-500 samples of data were acquired during each of the calibration tests. These data were later tabulated and a running average calculated. The ALLTEM calibration tests have been compiled into a graphical display of background with no target and with a stainless steel ball set on the top (Tx-Z), side (Tx-X), and rear (Tx-Y). These charts are presented in Appendix 1 with a pair of charts for each receiver configuration. The data were checked for consistency from morning to afternoon and from day to day. There were no variations more than 20 percent of the running average values for each polarization although the March 9 afternoon (PM) calibration data for several of the receiver polarizations (ZZE, ZZF, ZZH) displayed a greater spread than all the other days. The March 10 calibration data were ok for all polarizations.

5.5 DATA COLLECTION PROCEDURES

5.5.1 Survey Scale

The areas surveyed at the APG UXO test site were the Calibration grid (0.30 acres), the Blind Test grid (0.50 acres), the Direct Fire Area and the Indirect Fire Area (approximately 5 acres). 19 ALLTEM data and 19 signal strength maps (for each receiver polarization) for each survey area are included in Appendix 2. The maps on pages A2-2, A2-41, A2-80, and A2-120 are survey track plot maps for, respectively, the Calibration Grid, the Blind Test Grid, the Direct Fire Area, and the majority of the Indirect Fire Area that was surveyed. The signal-to-noise plots are the result of a windowed Student-T test over each of the data sets. A numbered anomaly patch for the Direct Fire Area is shown on page A2-81. Photos of the equipment in use at APG are presented in Appendix 3.

The survey procedure was to first mark and identify the corners of the survey areas as input to the survey planning and tracking software (supports metric Ease of Use (section 3.7)). Survey traverses were designed to have a 0.5 m separation. The data density along the traverses was approximately 0.15 to 0.20 m at a traverse speed of 1.0 m/sec. This survey speed and line spacing resulted in a production rate of approximately 1.5 acres per day (supports metric Production Rate (section 3.5)). Inversion analysis using this traverse data density has been shown to produce acceptable results (supports metric High Quality Data (section 3.6)).

5.5.2 Navigation and Orientation

5.5.2.1 Survey Planning and Tracking System (SPATS)

We have developed a survey planning and tracking system (SPATS) and plan to use this system during this demonstration. In tests at the Denver Federal Center an operator has been able to steer the system, independent of markers on the ground, to within about ± 5 cm of the programmed lines. The after-the-fact position recovery of the actual track, as opposed to the intended track, is, as we have stated above, generally within ± 2 cm.

5.5.2.2 Global Positioning System

To achieve high quality data (metric section 3.6) the ALLTEM uses a real-time kinematic (RTK) global positioning system (GPS) positioning. RTK-GPS provides consistent and georeferenced positioning. The USGS owns a Leica GPS1200 system. The Leica has a pulse-per-second (PPS) output and a fast (20 Hz) update rate that are used to advantage. To achieve high real-time position accuracy a GPS base station is used with a radio link to the rover unit mounted on the vehicle. For ALLTEM the GPS positions are part of the header in each data record. “RTK-Fixed” quality GPS data provide positions that are typically accurate to within ± 2 cm. The LabVIEW data acquisition software reads the status of the GPS data, provides a flashing visual flag to the operator if the status is not “fixed” and writes zeros for the position into the header data, so it is not possible to inadvertently record degraded GPS information. Data points are georeferenced at the time they are output by the acquisition system. That is, the most recent reporting of location by the GPS after the three waveforms are averaged is used as the location of the data point.

Because the GPS positions for fixed data quality are highly accurate, it is other factors such as latency, GPS antenna-to-geophysical sensor offset, and GPS antenna mast motion as the cart pitches and rolls with the topography that can degrade the actual accuracy. We have written software to handle the inherent latency issues in ALLTEM data. The Leica GPS1200 20 Hz update rate reduces latency issues and the remaining lag is compensated with software in post-processing. Quality control is discussed in more detail below (section 5.5.4). Possible position degradation from cart roll, pitch, and yaw are mitigated by sensor orientation hardware (the AHRS) and software development package described in the following section.

Loss of radio communication between the GPS base and rover stations such as occurred at YPG in February 2009 is mitigated by recording the raw GPS data at both the rover and base stations on memory cards included in each unit. The rover data, tied by time with the base station, are then post-processed to their correct locations.

5.5.2.3 Sensor Orientation

The 2006 YPG field tests, subsequent test stand studies, and data simulation tests indicate that it is possible, with a multi-axis system such as ALLTEM, to obtain sufficiently accurate position information so that good inversions, a key to discrimination, can be obtained in most cases from moving platform data. However, two issues remain, sensor orientation and closely tracking an

intended line without laying out physical grid lines. Staying on an intended line is not an issue for the Calibration Lanes and Blind Test Grid because dense surveyed position markers are provided, but such markers are not available for the much larger, and unmarked, open field areas, nor would they be available in an actual application.

Since the beginning of this ESTCP project, we evaluated several relatively new orientation devices. There were a number of issues involved:

1. How accurate does the orientation (roll, pitch, and heading) information have to be to avoid degrading inversion results?
2. Is there an instrument that can provide that accuracy while in motion?
3. How far from the ALLTEM cube must the unit be to avoid interference with ALLTEM data, i.e. how far away must it be to avoid being detected by ALLTEM as a “target?”
4. Will the ALLTEM primary field degrade the performance of the unit to the degree that it cannot meet our requirements?

5.5.2.3.1 Attitude and Heading Reference System (AHRS)

The Crossbow Technologies Attitude and Heading Reference System Model AHRS400CD-200 is a solid-state system that utilizes MicroElectroMechanical Systems (MEMS) sensing technology and combines angular rate, linear acceleration and magnetic field measurements to create an electronically stabilized system without the orientation range and warm-up limitations of traditional mechanical gyro systems. It uses proprietary Kalman Filter algorithms to determine stabilized roll, pitch, and heading angles in both static and dynamic conditions. The continuous Kalman Filtered gyro bias calibration output data are stabilized by long term gravity and magnetic north references.

5.5.2.3.2 ALLTEM Position and Attitude Recovery System (APARS)

APARS is a software module incorporated into Geosoft Oasis Montaj that integrates GPS and AHRS data streams to provide coil-corner locations of the ALLTEM cube, which are then used in the ALLTEM data inversion. The physical components of the system are: 1) the ALLTEM cube, 2) a Leica GPS1200 RTK differential GPS system with one roving antenna and a measured relative-position accuracy of about ± 2 cm horizontally and ± 1 cm vertically, sampled at 20 per second, 3) a Crossbow AHRS model AHRS400CD-200 having a specified dynamic accuracy of 2.5° rms in attitude and 4° rms in heading, and 4) a cart, to which the cube, GPS antenna, and AHRS units are all rigidly mounted. The GPS antenna and AHRS unit are on a nose extension of the cart as shown in Figure 6.



Figure 6. AHRS and GPS antenna on nose of new cart. This photograph shows the forward portion of the ALLTEM cart. The triangular cross-section “nose” extension is the platform for the AHRS, right, and GPS antenna. The AHRS is located far enough away that the electromagnetic interference between AHRS and ALLTEM is acceptably small.

The data streams from these physical components are first acquired by the LabView ALLTEM acquisition program. After pre-processing, also by a LabView program, the data are sent to an anomaly-patch delineation program, running in Oasis Montaj that synthesizes patch information, appending it to the data for input to the APARS program. The APARS software module is an executable file compiled from Fortran source code and is typically called by the patch identification program. However, it can also be executed as a standalone program if appropriate input files have been supplied in the command line.

The APARS module outputs a set of 19 ASCII files for each anomaly patch, into the subdirectory designated exclusively for that patch in the Oasis Montaj project directory. Each one of the 19 files contains all data in the patch pertaining to a specific combination of drive (Tx) and sense (Rx) coils. Since there are 19 Tx-Rx combinations used, there are 19 files. Each data record of each file contains the set of vectors necessary to calculate, using simple vector sums, the absolute locations in x, y, and z of all pertinent Tx- and Rx-coil corners, as well as the cart heading, the cube center position, and the ground surface position. The vector summations are completed in a subroutine called by the inversion program.

The critical functions of the APARS software are 1) removal of errors (spikes, gaps, noise, etc.) in the GPS and AHRS data streams, 2) adjustment and removal of timing-based systematic errors in the position and attitude data, 3) independent calculations of instantaneous heading and

attitude using GPS data and a “cart-path” algorithm, as an adjustment, check, and constraint on AHRS data, 4) interpolation for optimization of position and attitude data to ALLTEM data-collection time gates, 5) rotation and translation of coil corner positions from the moving frame into an absolute (fixed) reference frame, and 6) formatting and outputting of coil corner positions appropriately for input to and use by the ALLTEM inversion software.

5.5.3 Data Recording and Archiving

Data for ALLTEM are initially recorded on the acquisition system hard drive. The raw data format for ALLTEM is an ASCII header containing system setting information, time stamp, GPS and AHRS data followed by a fixed length of 24 bit summation averaged sensor data per record. Records for 19 Tx-Rx gradiometer channels (x, y, z, or diagonal, component of the magnetic field) are typically written at rates of 2.5 to 5 per second.

At the end of each line of acquisition, the data are automatically archived to a small LaCie external hard drive (160 Gb). Tests have shown that 10 minutes of acquired data (nineteen 16 Mb files or about 320 Mb total) takes about 20 seconds to copy to the LaCie drive. After a number of lines are written (probably 10 to 20) the external LaCie drive is swapped out with another LaCie drive and the data acquisition continues with minimal disruption. The data on the LaCie drives are then archived on a third larger backup drive that isn't used for anything else except as backup.

The principal media we use for data archiving, besides the backup hard drive, are DVD's. Backup copies of the acquired raw ALLTEM APG data were compiled for us and a set were left with the APG Project Office before we left. Since the ALLTEM records data in a distinct format, we provided an annotated example for use as a “key” to import and parse the data, as well as a description of file naming nomenclature.

5.5.4 ALLTEM Quality Control

The purpose of a quality management program is to define specific processes for ensuring that program and project objectives are properly defined and attained. The general objective of geophysical investigations is to efficiently detect, locate, and discriminate UXO for proper evaluation, recovery, and disposition.

Quality Control (QC) is an appropriate evaluation, performed by the provider of defined products, to assure that the work conducted fully meets the prescribed requirements and complies with applicable laws, regulations, and sound technical practices.

Quality Assurance (QA) is an appropriate management review of the overall effectiveness of the contractor's QC program, processes, and compliance of work by others. The QA procedures are the process by which the Government fulfills its responsibility of being certain that QC is functioning and that the work was conducted as specified in the project-specific or programmatic work plan.

This section on quality control describes the USGS QC program that was followed during the demonstration of the ALLTEM at the APG.

5.5.4.1 Components of Quality Control

5.5.4.1.1 Communication

Comprehensive and consistent communication is a key to a successful operation. Each individual must communicate completely what is occurring in the field during acquisition, processing, and interpretation. This is both a field management issue and a safety issue.

5.5.4.1.2 Data Management

Careful management of all acquired and developed data must be present from field acquisition through processing, interpretation, field QC and data entry into a GIS platform. Back-up copies of all raw data collected will be made on a daily basis.

5.5.4.1.3 Field observation

Field observation of all procedures must be part of the QC process. Correct use of tools and adherence to procedures can only be checked in the field.

5.5.4.2 Field Operations

The USGS APG quality control program will ensure that:

5.5.4.2.1 All of the Calibration Lanes, Blind Test Grid, and Direct Fire and Indirect Fire areas were surveyed.

5.5.4.2.2 There are no missing survey lines within any of the areas surveyed except where we were not able to survey due to standing water several feet deep.

5.5.4.2.3 There are no data “gaps” along survey lines.

5.5.4.2.4 There is no "bowing" out of survey lanes beyond 0.5 m, except in cases where obstacle avoidance or topography require such deviations. The ALLTEM surveys adhered to a 50 cm line spacing. This ensured that every target was covered by our antennas. Surveys were conducted along lines aligned with the Calibration Lanes and Blind Test Grid lanes for ease of navigation. The open field areas were surveyed with lines designed for maximum field efficiency. Data were evaluated each day to ensure that the data are good. Survey lines were run in a “moving race-track” fashion to minimize lost time at the ends of lines.

5.5.4.2.5 Data density along survey traverses remained well matched to the target MEC. ALLTEM data was recorded at a rate of between 4 and 5 times per second. The goal was an along-track spatial data density of 25 cm or better at speeds from 0.75 m/s to 1.0 cm/s depending on the terrain, water, and potholes at the site.

5.5.4.2.6 Instrument functionality checks

5.5.4.2.6.1 Check that system turns on.

5.5.4.2.6.2 As with all analog and time-based systems, drift will occur mainly due to component tolerances and temperature dependencies. This inherent system drift limits the absolute accuracy of the measurements that can be attained. The reference data are used primarily as a metric for overall accuracy. Abnormal drift, as might be caused by component degradation or failure, would trigger a system check and data review. The hardware problem would be corrected and field data acquisition would resume. Any previous data deemed degraded would be reacquired.

5.5.4.2.7 Surveyed locations and orientations were accurate and precise. Navigational accuracy was assisted by new LabView software that writes the RTK-GPS data into a data header for each ALLTEM record. Survey lines were set up using our new survey planning and tracking system (SPATS) as described in section 5.5.2 above. This system provided both real-time guidance for the ALLTEM operator and overlaid plots of the intended and actual surveyed lines to ensure that we held our lines to within the ± 0.50 m standard mentioned above. A few lines that did not meet this criterion for reasons other than obstacle or terrain avoidance were reacquired.

5.5.4.2.8 Static Response Check (System at rest). The system occupied a designated clean location next to the fiberglass test stand at APG at least twice each day: prior to and at the completion of regular data acquisition. Data were collected in the clean location both with and without a target of known response located with respect to the system by a calibration jig. This took place in the morning and afternoon, but in case of an extended pause in the middle of the day, an additional reference data set was acquired. This also tested the accuracy and repeatability of the navigation data.

5.5.4.2.9 Standardization Checks (Standard Responses in Static and Dynamic modes)

5.5.4.2.9.1 A continuously running log of standardization responses was maintained.

5.5.4.2.9.2 Warm-up. In order to minimize thermal drift problems with ALLTEM, data recording did not begin until the transmitter has been operating for at least 15 minutes, usually 30 minutes due to the cold temperatures in the mornings at APG.

5.5.4.2.9.3 Standardized Target. For the ALLTEM we used both the clean location with no target and 4 inch diameter steel and brass balls to provide a means of calibration. These were conducted at the intervals noted above. Both static and dynamic tests were run to check the effects of motion noise.

5.5.4.2.9.4 Six-line Test. The ALLTEM conducted a “six line” test on the first day of surveying after unpacking and setting up the system. This test provided a measure of system response and a determination of location lag and latency. A designated survey lane was traversed up and back at normal surveying speeds with no target, and then up and back over the standardized calibrated target (the steel ball). Finally, the systems surveyed up the traverse at a rate faster than normal and then returned at a speed slower than normal.

5.5.4.2.10 Latency Check, Instrument Positioning. The GPS base station was setup over a local geodetic marker for reference (Monument #477 near the Direct Fire Area). The LabView control software for ALLTEM monitors and records the status of the RTK-GPS. If this state is less than “fixed” a visual flashing flag and an irritating sound comes from a speaker next to the operator’s head. The bad position data in the header is replaced by zeros and the GPS data with degraded accuracy cannot be recorded without knowing it. When the fixed GPS status was attained, the GPS was providing data accurate to within 2 cm in horizontal location. The GPS rover antenna was located on a mast that has an offset to the center of the sensor antennas and moves as the cart rolls and pitches over uneven ground. Further, the location data have some latency as well. We have written software to compensate for offset and latency. In addition, we have the capability of correcting for sensor orientation and roll, pitch, and heading errors by means of the AHRS/APARS system described above.

5.5.4.2.11 Visual Instrument Response (Tool is Operational)

5.5.4.2.12 Visual Data Review on Field Recorder. ALLTEM has real-time visual displays for immediate examination of acquired data and to ensure that the transmitting/receiving functions are operating normally.

5.5.4.2.13 Field Data Download. During acquisition along a traverse the ALLTEM data is written to the main system hard drive. At the end of each line the data is automatically backed up to a small external drive (160 Gb). Tests have shown that 10 minutes of acquired data takes about 20 seconds to write to the external drive. All recorded data will be frequently downloaded. Complete data downloads and backups will be done at least every day.

5.5.4.3 ALLTEM Data Processing

ALLTEM data were preprocessed overnight or concurrent with data acquisition to visually ensure that there are no serious “glitches” or “tears” in the data. Any corrupted lines were repeated. In particular:

5.5.4.3.1 Unreasonable data spikes were removed from the data.

5.5.4.3.2 There were no data incongruities across surveyed lanes (data levels in one lane incompatible with data levels in neighboring lanes beyond expected small level shifts due to instrument thermal drift).

5.5.4.3.3 Heading and lag corrections were monitored and correctly applied.

5.5.4.3.4 Calibration and resurveyed data were repeatable.

5.5.4.3.5 Data were reasonable per geology, tool and site-specific conditions.

5.5.4.3.6 QC Review Checks

- 5.5.4.3.6.1** Reviewed Field Data and Log Forms (exist and complete)
- 5.5.4.3.6.2** Reviewed Static and Dynamic Instrument Standardization Response files
- 5.5.4.3.6.3** Reviewed Data Point Spacing (along traverse)
- 5.5.4.3.6.4** Reviewed Survey Line Separation (across traverse)
- 5.5.4.3.6.5** Reviewed data for “dropouts” and instrument malfunctions
- 5.5.4.3.6.6** Compared anomaly selections against known anomalies
- 5.5.4.3.6.7** Reviewed the geophysical database repeats, errors, and inconsistencies

5.5.5 VALIDATION

No targets were dug at APG for validation purposes as all targets are considered to be seeded targets. We will wait until the ground truth for this configuration of the site is released.

6.0 ALLTEM DATA ANALYSIS AND PRODUCTS

ALLTEM data analysis may be broadly divided into a pre-processing step using software developed in LabView that combines, filters, and finally exports particular time samples of data and then custom designed data processing within Geosoft's Oasis Montaj platform that maps, grids, statistically analyzes, auto picks targets, writes out selected anomaly data, inverts for target characteristics such as location, orientation, and length and radius, and then classifies the results as not targets of interest or as targets of interest. Each of these processes is discussed below.

6.1 PREPROCESSING

The ALLTEM acquisition software continuously produces 19 separate data files – one for each receiver. Pre-processing of the ALLTEM data involves running a LabView program that, operating in batch mode on all the data submitted up to a whole survey, removes the system response and background from the recorded waveforms, applies lowpass and bandpass filters, merges the GPS data (which is converted from latitude-longitude to UTM easting-northing) with the recorded waveform data, averages the bipolar waveform (1,111 samples are reduced to 555 samples), performs an integration of the area under the waveform to produce an indicator of composition (ferrous, non-ferrous, and mixed), and finally exports ASCII data ready for import to Oasis Montaj.

ASCII files are created for each receiver polarization. In each file are the line number, the record number, easting, northing, and then 15 waveform time picks (amplitude values in volts) ranging from the beginning of the waveform (sample 0) to just before filtering effects at the end of the waveform (sample 535 or 5.35 ms). Sample values exported (recorded every 10 μ s) include 0, 7, 22, 31, 45, 60, 75, 105, 135, 185, 250, 350, 450, 513, and 535. Originally sample 15 was also exported. This location in the data file is now occupied by a value indicating the amount of nonferrous material in the target.

6.1.1 Processing done during data acquisition

Section 5.3 presented a breakdown of the sequencing of drive cycles and stacking of recorded waveforms. Three waveforms are averaged and stored for each drive coil sequence. The waveforms are collected in three's because, after each of the three periods of 90 Hz is gathered by the A/D buffers, the individual periods can be stacked by adding them together, point by point, and then dividing by three. This has the effect that any 60 Hz component of noise on the received signal is significantly reduced.

6.1.2 Processing done after data acquisition

The first step in preprocessing ALLTEM data is to shift the waveforms 2.36 ms to the left so that the response to the triangle corner occurs near $t = 0$ (figure 7).

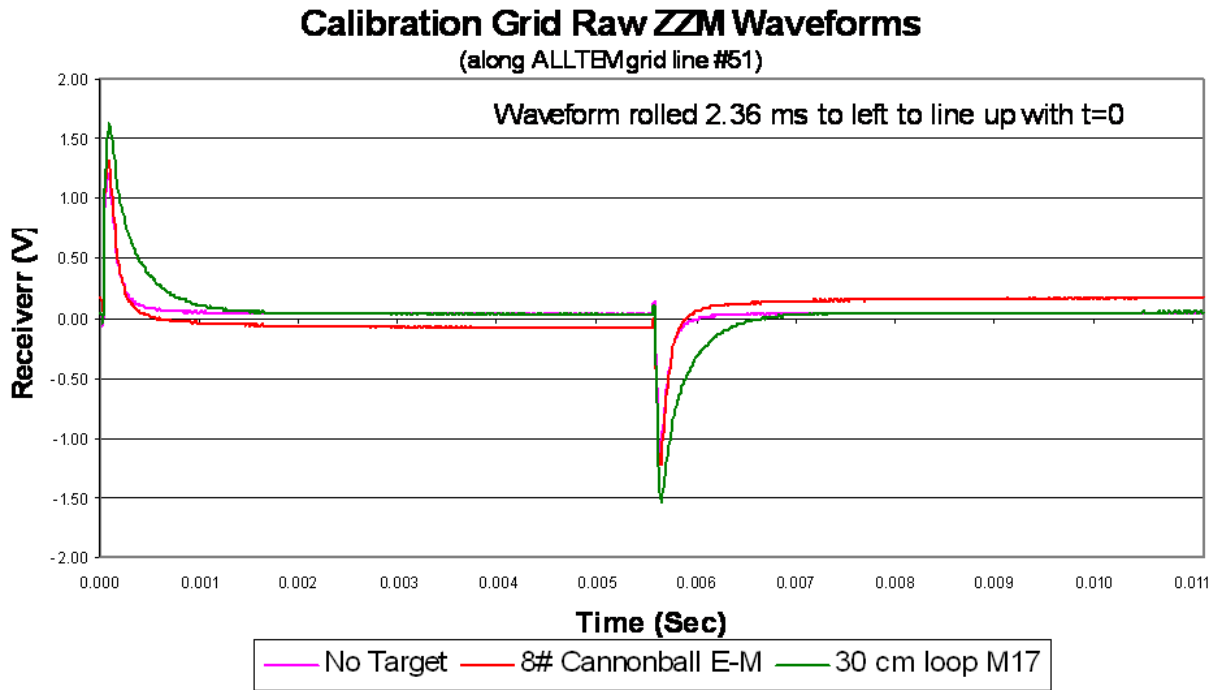

Figure 7. The raw waveforms are first shifted 2.36 ms earlier in time.

The next step is to apply software filters. The 2006 version of the post-processing software allowed the user to select a quiet area of waveforms along the line. An average of a number of waveforms near the quiet area were computed and then subtracted from every waveform along the line. Typically, for the Blind Test Grid and Calibration Grid at the YPG, the first three waveforms were used because the ALLTEM sensor was stationed off the grid (in a quiet area) at the beginning of a survey line. As the sensor moved along the line, and depending on the terrain, the distance to the underlying ground changes relative to the sensor. This distance variation causes small, varying amplitude square waves to be observed in the post-processed data. The edges of the square wave have a small exponential decay due to the system response of the hardware low-pass filters used. This effect forced the first pick point to be taken at approximately 275 μ s past the edge of the square wave so that this ground-effect would be excluded.

An improved background subtraction method was used for the Yuma 2009 and APG 2010 data sets. It was found that by using a rolling background subtraction, rather than just the waveforms at the start of a line, the amplitude of the small ground effect square wave could be reduced. This in turn lowered the noise of large ground-effect square waves from affecting the amplitude of the first-pick point. The rolling background subtraction works by examining each waveform on a line and determining how flat the top of any square wave is. If the flatness is below some threshold, then the waveform is deemed to have no response from any metallic target in it. If a number of these clean waveforms occur consecutively (the number being user selected), then the next waveform can use the average of the previous three as a background subtracted waveform. An example of a line from the Blind Test Grid (line 53, ZM polarity) is shown with the old

technique in Figure 8 of using the first three waveforms. An example of the new rolling background subtraction is presented in Figure 9.

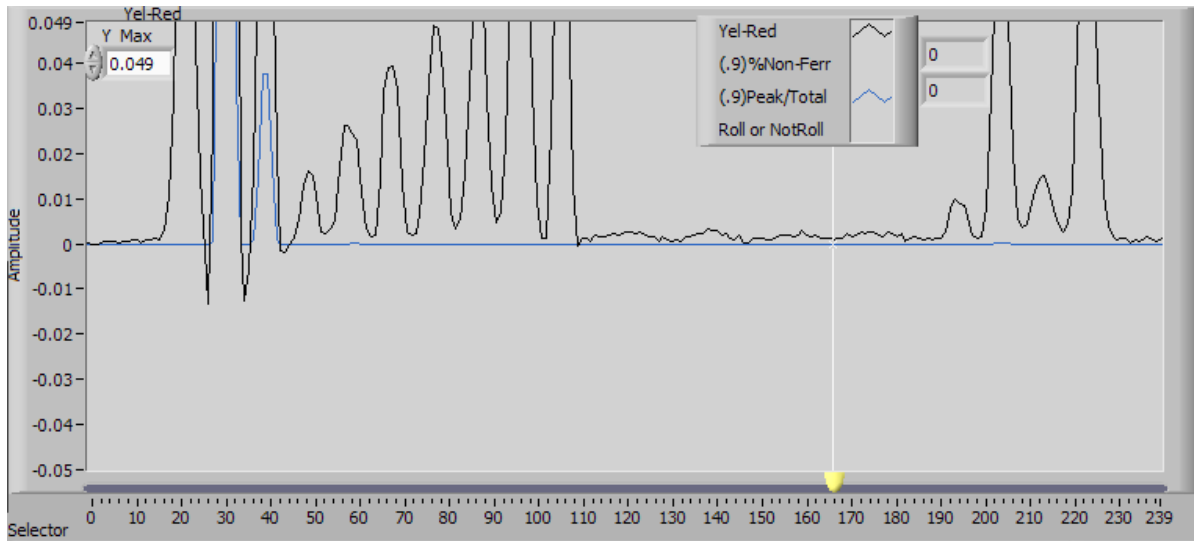

Figure 8. Calibration Grid, line 53, ZMZ with a background subtraction average of the first three waveforms on a line.

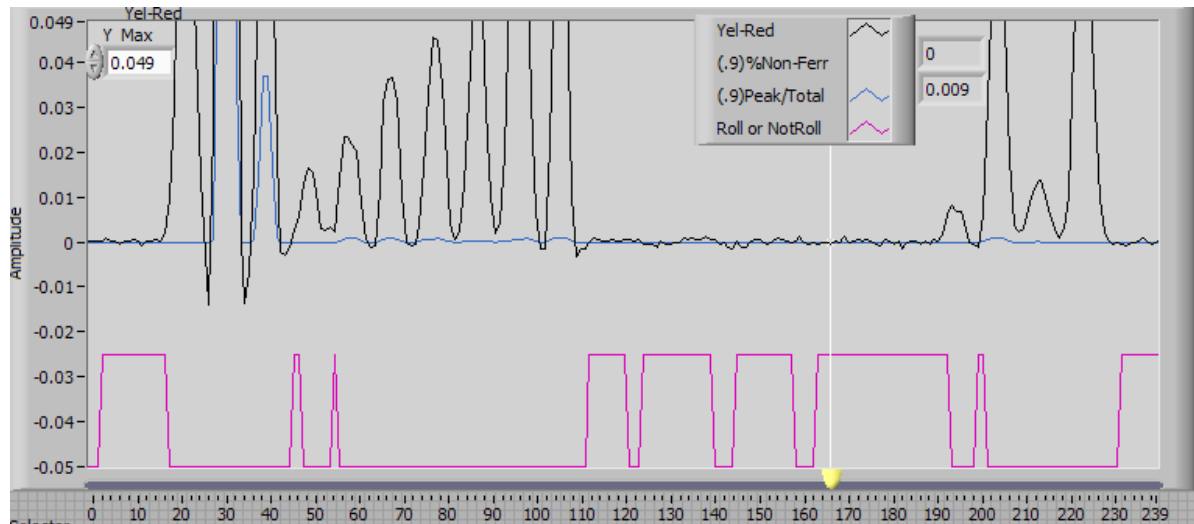

Figure 9. Calibration Grid, line 53, ZMZ showing how the rolling background subtraction scheme works. The red line graph at the bottom indicates where the rolling background value is applied.

In Figure 9 the red trace indicates where the rolling background is applied (the high values) and where the background from the previous last good rolling background value was used (the low values). Note in the area between samples 110 and 190 on the X-axis the level of the background noise is lower using the rolling background technique. Also note that the depth of the dip

between closely spaced targets (for example, around record 85), is closer to the base line with the rolling background technique.

After the rolling background technique is applied, the two halves of the bipolar waveform are averaged. The observed recorded waveforms from YPG had a component of 180 Hz, synchronous, system noise which was relatively small, but for small targets could reduce the signal-noise ratio appreciably. Each record of 1111 samples contains two complete, reciprocal, responses to the corners of the triangle wave used to drive the Tx coils. By splitting the 1111 samples in half and inverting the second half reciprocal response and then adding it to the first half and dividing the sum by two, the 180 Hz component could be reduced significantly. To reconstruct an entire 1111-sample waveform, the half-waveform produced by the averaging was inverted and added onto the end of the half-waveform. This filter significantly reduced this noise source. Non-synchronous noise is also attenuated by this technique. Figure 10 shows the effect of the Average Halves filter.

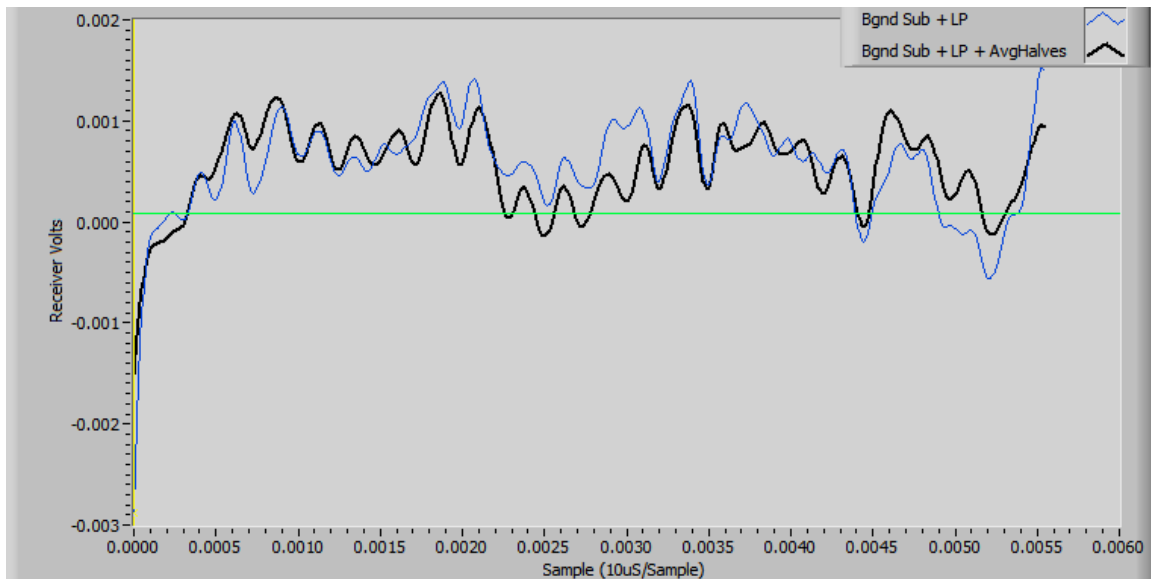

Figure 10. Application of the average-halves filter. The black line is produced after averaging the two halves of the bipolar waveform. The second half of the original blue waveform is not shown.

After background subtraction and averaging the two halves of the waveform, a LabVIEW, zero-phase, eighth-order, low-pass filter was applied to roll off any higher frequency noise that might be in the recorded data from VLF stations. For the Yuma 2009 data set, the filter was placed at 7.5 kHz, which was far enough from any frequencies of interest that any Gibbs effects were not significant. Figure 11 illustrates the reduction in noise gained from application of the 7.5 kHz low-pass filter.

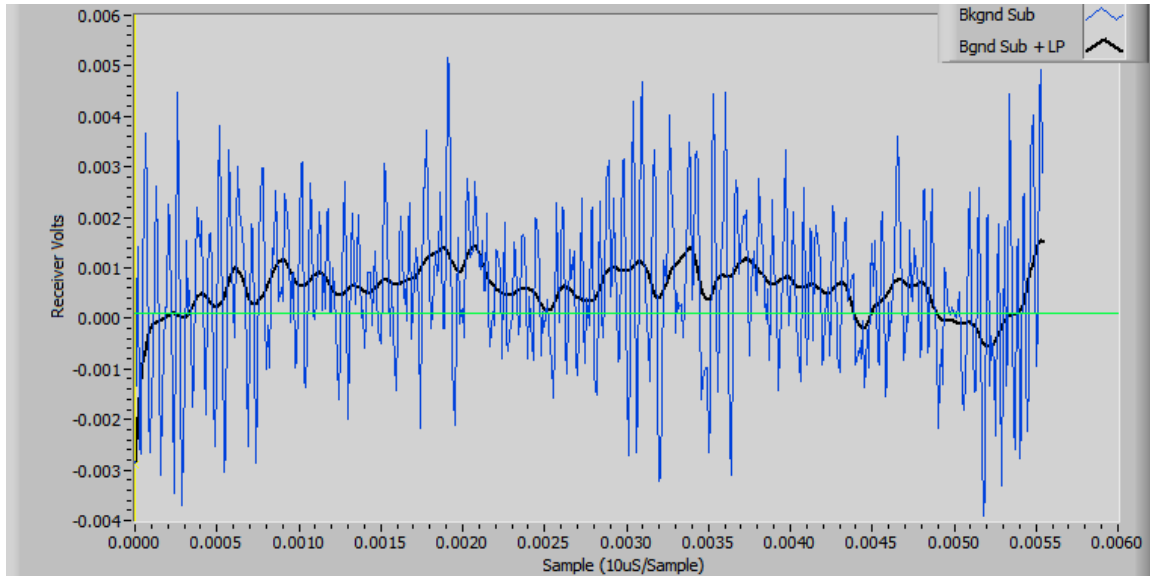

Figure 11. Effect of low-pass filter on noise reduction. The black line is the result after the 8 kHz filter has been applied to the blue line.

Finally, a modified running median filter was used on the waveforms. This had the effect of removing any single spikes in the data as well as performing some additional low pass filtering. The modified running median filter slides along the data and is performed by taking three samples on either side of the sample to be filtered. This subset of samples was sorted by value. The middle value of the sorted array was averaged with a sample on either side of the middle value. The averaged value became the output of the filter. Figure 12 shows the effects of the modified running median filter.

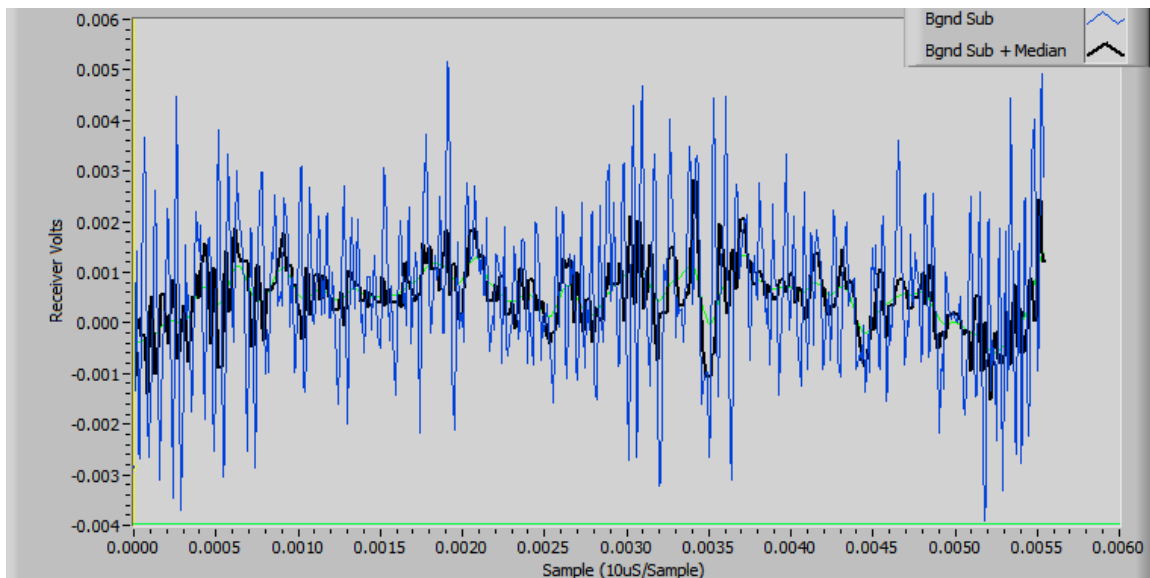

Figure 12. Application of the running median filter. The black line is the result of applying a three-value median filter on the blue line.

Figure 13 presents a summary effect of the filters and background subtraction on the ALLTEM data. The noise level is almost 4 mV peak to peak. After application of the low-pass, median and average-halves filters, the noise level is slightly less than 1 mV peak to peak. This is an approximate SNR improvement of about 12 dB.

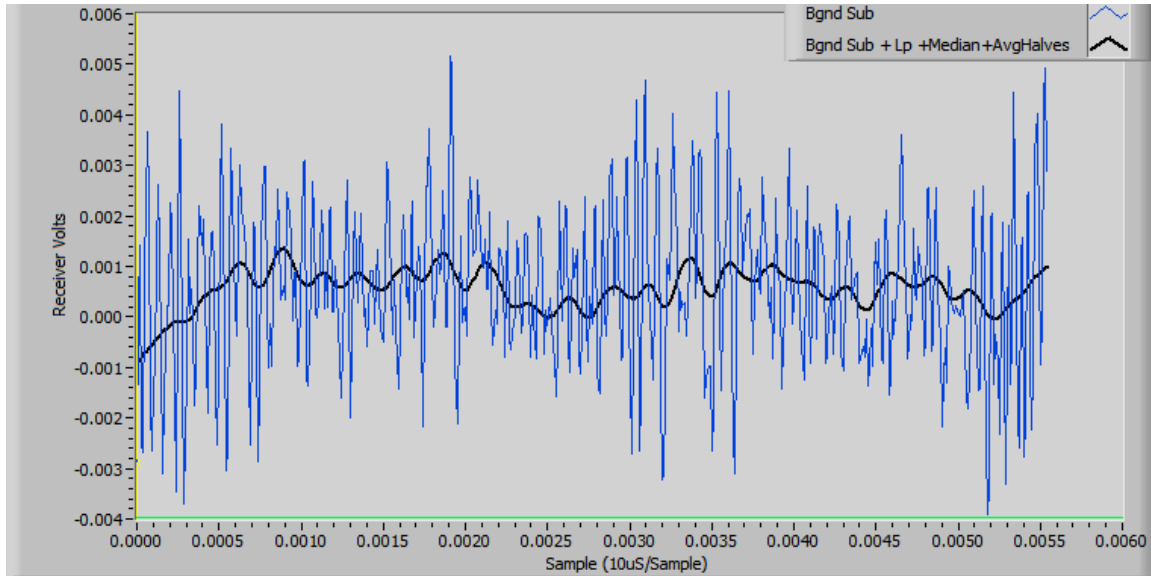

Figure 13. Example of noise reduction when all filters are applied. The blue line is the original data and the black line is the result after all filters have been applied.

6.2 TARGET SELECTION FOR DETECTION

For this APG demonstration the ALLTEM operated over the Calibration Lanes, the Blind Test grid, and open field areas including the Direct Fire Area and the Indirect Fire Area. Blind Test Grid, Direct Fire Area, and Indirect Fire Area results were submitted for scoring. An inversion algorithm for ALLTEM data has been developed at the USGS and is described in the SERDP project MM-1328 final report (Wright and others, 2008).

Since that report was written some improvements and additional capabilities have been added. A suite of additional preprocessing, processing, and analysis tools have been developed for the Oasis Montaj platform. The Oasis gx's import the LabView preprocessed data, apply dc offsets if necessary to the imported data, and then grid the data using Oasis routines. During gridding noise and signal statistics are developed based on a target free area within the data set. This statistical analysis is used to determine target locations and set target thresholds. The ALLTEM gx then applies some filters, if necessary, to sharpen the target location, and then automatically selects target locations within all nineteen receiver data sets. Target locations can be manually adjusted. Polygons are then created around each target location and the data within each target "patch" is selected and copied to a new subdirectory location for further analysis. The target patches can also be manually modified by the geophysicist analyzing the data. Once the target patches are finalized, the AHRS orientation corrections are applied to the data within each patch. The data are now ready to be processed by the inversion algorithms. The target maps for each of the survey areas for each polarization are presented in Appendix 2.

The ALLTEM data for the ZZM receiver for each of the four surveyed areas are presented in figures 14, 15, 16, and 17. That portion of the data that was considered to be target-free with low to background noise levels to calculate the noise statistics is indicated for each area with a black polygon.

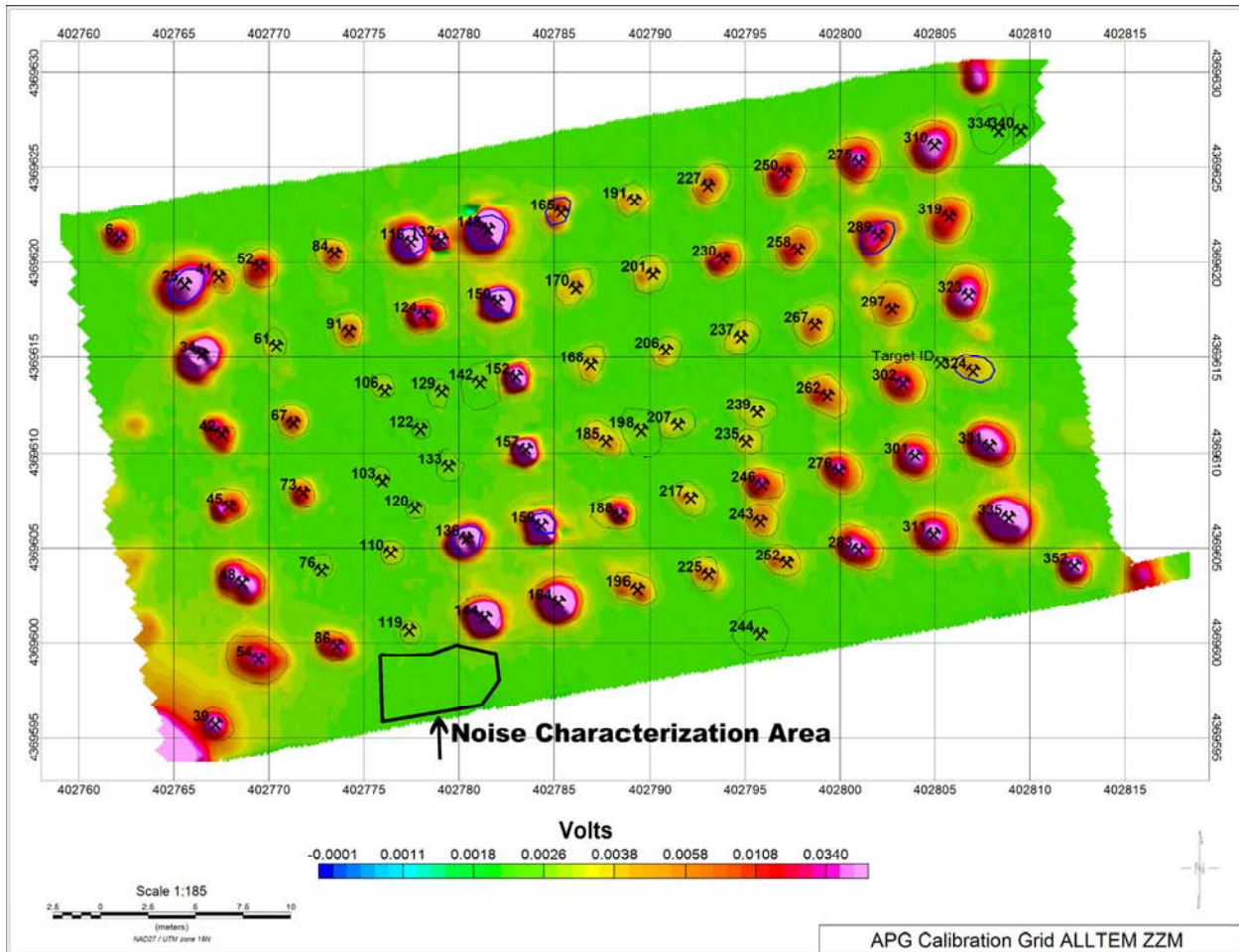

Figure 14. ALLTEM APG Calibration Grid data for the ZZM receiver polarization. The survey data used to characterize the noise is indicated by the black polygon.

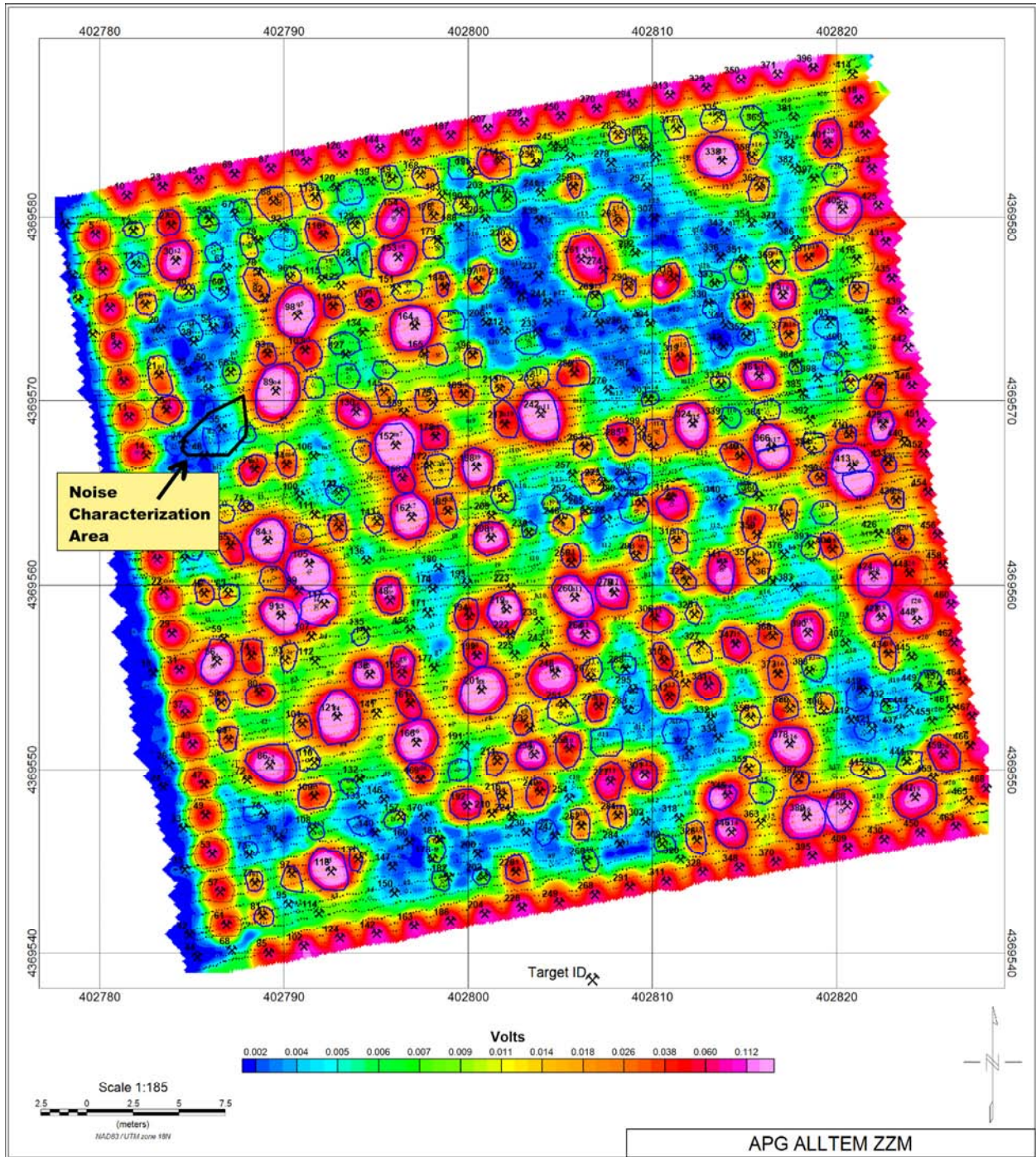

Figure 15. ALLTEM APG Blind Test Grid data for the ZM receiver polarization. The survey data used to characterize the noise is indicated by the black polygon.

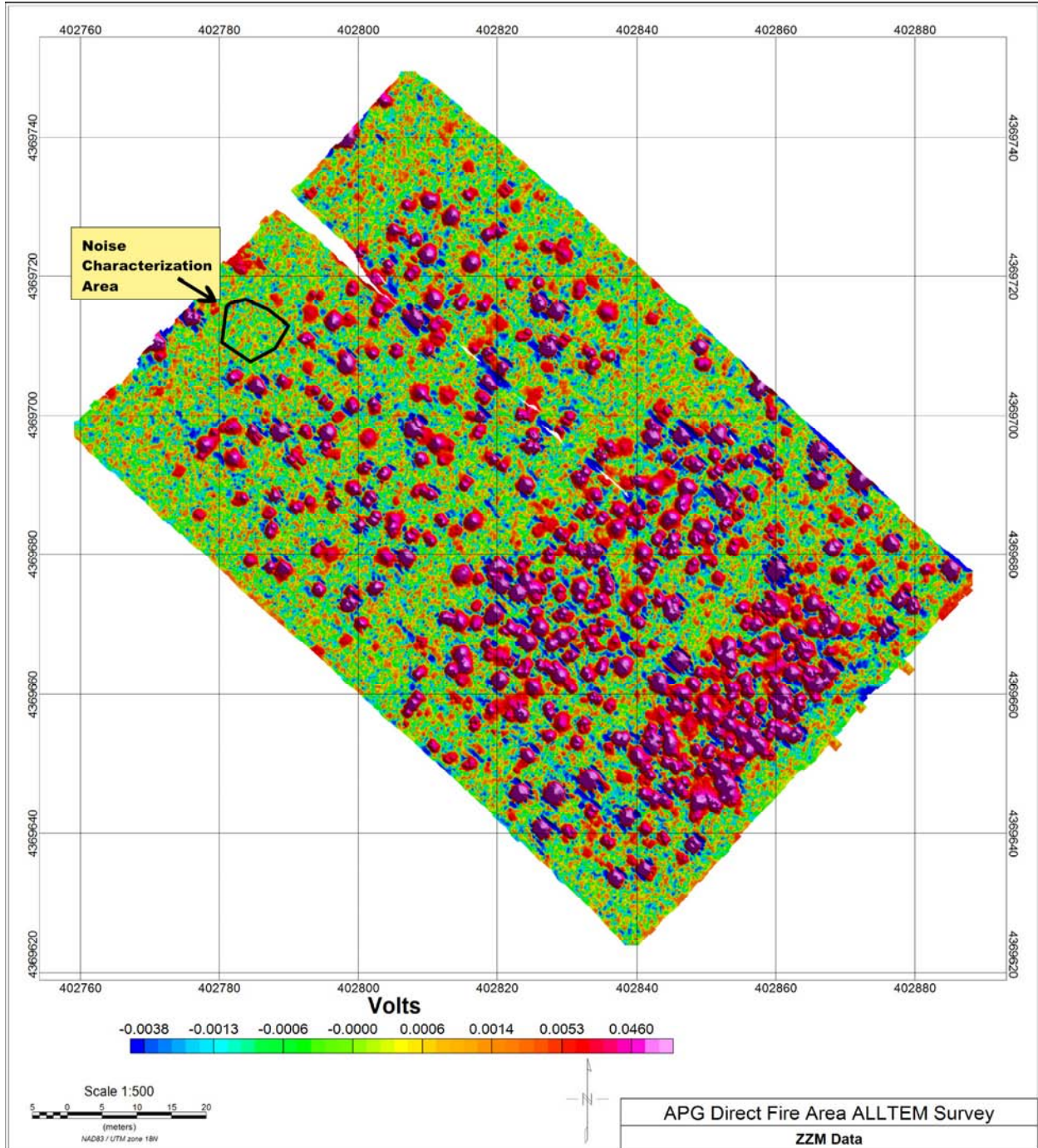

Figure 16. ALLTEM APG Direct Fire Area data for the ZMZ receiver polarization. The survey data used to characterize the noise is indicated by the black polygon.

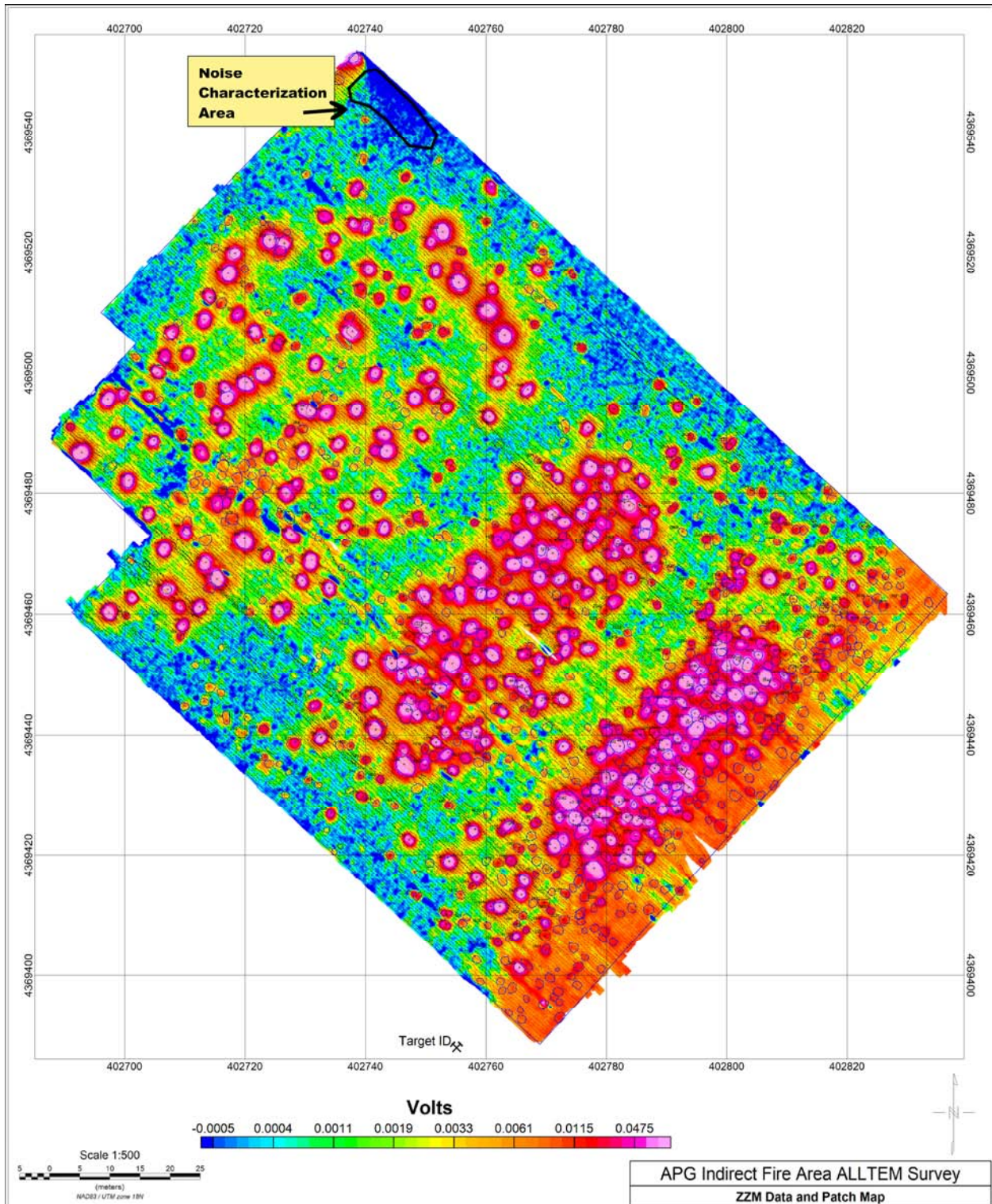

Figure 17. ALLTEM APG Indirect Fire Area data for the ZMZ receiver polarization. The survey data used to characterize the noise is indicated by the black polygon.

Anomaly selection uses thresholds that are calculated from background data identified in an apparent target-free zone in the survey area. Different thresholds are used for each receiver polarization based on its own noise characteristics. The thresholds are calculated as part of the data noise characterization process using the Shapiro-Wilkes test. The results are then stored in individual receiver polarization's data statistics file. The data stored are the Shapiro-Wilkes P-value (a form of confidence interval), the Shapiro-Wilkes W value, the mean and standard deviation for a Gaussian distribution, and the high and low values of the noise (in volts). The ranges of the background/noise are stored at each time pick as well as the difference in the time picks. Table 4 lists a excerpt sampling of the background/noise thresholds for time picks and amplitude differences.

Table 4. Example Data Statistics from Denver Federal Center testing.

Data	450	513	547	45M450	45M513	45M547
Shapiro Wilks p-val	0.46625	0.35984	0.35600	0.06382	0.12241	0.05487
Shapiro - Wilks W	0.96638	0.96161	0.96141	0.93249	0.94331	0.92996
Mean Gaussian	0.05232	0.04998	0.04903	0.06617	0.06850	0.06945
Sd Gaussian	0.01469	0.01480	0.01447	0.00221	0.00230	0.00217
T-low	-0.10608	-0.10413	-0.10197	-0.07427	-0.07692	-0.07740
T-High	0.00145	0.00417	0.00391	-0.05806	-0.06009	-0.06150

6.3 PARAMETER ESTIMATION

As discussed in the previous section, the data in the selected target patches are corrected for orientation using the AHRS data and then submitted to the inversion algorithms. The ALLTEM inversion uses the Biot-Savart Law to model both the primary magnetic fields from the transmitter coils and those secondary magnetic fields, using reciprocity, transmitted by the target materials in the ground. The target response is currently modeled by single dipoles from prolate and oblate spheroids with one length and two widths. Analysis of the YPG field work in 2006 was manually carried out by multiple iterations for each anomalous signal over fifteen time gates along the waveform decay curve. This was quite time consuming due to the Visual C++ GUI.

As of January 2010 the ALLTEM response is modeled using a conductive, magnetic, and optionally, a viscous magnetic earth. The integral expressions for the magnetic fields generated by infinitely small vertical magnetic dipoles (VMDs) and horizontal magnetic dipoles (HMDs) over a conductive magnetic half space are given by Ward and Hohmann (1988). These integrals are numerically evaluated using Anderson's (1979) fast Hankel transform to produce Green's functions for the magnetic field due to a dipole over a half-space. The ground response at a given receiver coil due to excitation by a given transmitter coil is calculated by numerically evaluating the following integrals,

$$V_{rx}(\omega) = -i\omega T(\omega) \int_{RXloop} \hat{n}_{rx} \cdot \int_{TXloop} \hat{n}_{tx} \cdot \vec{G}^-(\sigma, \mu, \vec{r}, \vec{r}') d\vec{r} d\vec{r}' \quad (1)$$

where $T(\omega)$ is the Fourier transform of the transmitter excitation (a triangle wave), $\vec{G}^-(\sigma, \mu, \vec{r}, \vec{r}')$ is the dyadic Green's function for the fields above the surface due to a dipole moment above the surface, σ is the ground conductivity, μ is magnetic permittivity (possibly

complex and frequency dependent), ω is radian frequency, V_{rx} is the voltage at the receiver coil, \hat{n}_{tx} and \hat{n}_{rx} are the normals to the planes containing the transmitting and receiving coils, and the integrals are over the area of the transmitting and receiving coils. This procedure is used to calculate the voltage at each receiving coil in the gradiometer, and the simulated result is the difference between these coil voltages. Finally, the frequency-domain coil voltage is converted into a time-domain signal using a numerical Fourier transform (FFT).

Modeling the response of a conductive permeable spheroid is slightly more involved. First, the magnetic field below the surface is calculated at the center of the target using (2). Here the dyadic Green's function is now for the fields below the surface due to a dipole moment above the surface.

$$\vec{H}_0(r, \omega) = T(\omega) \int_{TXloop} \hat{n}_{tx} \cdot \vec{G}^+(\sigma, \mu, \vec{r}, \vec{r}') d\vec{r}' \quad (2)$$

Next, the equivalent induced dipole moment $\vec{m}(t)$ for the target is calculated,

$$\vec{m}(\omega) = \vec{R}^T \cdot \vec{M}(\omega) \cdot \vec{R} \cdot \vec{H}_0(r, \omega) \quad (3)$$

where $\vec{M}(\omega)$ is the diagonal frequency-dependent magnetic-polarizability tensor. Calculations for specifying this tensor for conductive permeable prolate and oblate spheroids are given in Smith and Morrison (2006). \vec{R} is a rotation matrix that converts the magnetic field to target spheroid centric coordinates. Note that for a given incident field, only a single component of the polarizability tensor is excited. A fully polarimetric instrument switches through different coil configurations resulting in incident fields with components in all possible directions. The result is that all components of the polarizability tensor are excited, which provides more information about the target.

The final step is to calculate the fields at the receiver coils due to the induced dipole moments at the target. Using the reciprocity theorem, we find that the voltage induced in the receiver coil V_{rx} due to the induced target dipole moment \vec{m} is related to magnetic field \vec{H}_{uxo} at the target due to a current in the receiver coil I_{rx} .

$$V_{rx}(\omega) = -i\omega \frac{\mu \vec{H}_{uxo} \cdot \vec{m}(\omega)}{I_{rx}} \quad (4)$$

Equation 2 is used to calculate the magnetic field at the target, only now the integral is over the area of the receiver coil. As before, this procedure is used to calculate the voltage at each receiving coil in the gradiometer, and the simulated result is the difference between these coil voltages. Finally the frequency-domain coil voltage is converted into a time-domain signal using a numerical Fourier transform (FFT).

Using Equations 1-4 and Smith and Morrison's (2006) spheroid response, the ALLTEM response to the earth and the target are modeled separately, and then summed for the total response. Interactions between the target and surrounding medium are neglected (i.e. Born approximation). The magnetostatic response due to magnetization of a permeable target is manifest as a square wave response, with the decaying electro-dynamic response due to induced eddy currents superimposed. The square wave magnetostatic response is absent for the non-

permeable target. Note also that the electro-dynamic eddy current decay lasts longer for the permeable target.

When processing large amounts of data, it is desirable to have a fast inversion algorithm, which in turn requires a fast forward model. Calculating the Green's function in equations 1 and 4 is computationally expensive, and is not needed in most cases (i.e. when viscous magnetic soil is not present). A faster approach to calculating the magnetic fields is to use the static Biot-Savart Law for free space. This works especially well for the ALLTEM system since all coils have a square shape. The magnetic field at \vec{r} is the sum of the fields produced by the four straight wire segments, each with current \vec{I}_n , length $2L$, and centered at \vec{r}'_n (the midpoint of the wire segment):

$$\vec{H}(\vec{r}) = \sum_{n=1}^4 \frac{\vec{I}_n \times \hat{R}_n}{4\pi} \left[\frac{|\vec{P}_n|}{d_2(d_2 + L - |\vec{Z}_n|)} - \frac{|\vec{P}_n|}{d_1(d_1 + L - |\vec{Z}_n|)} \right], \quad (5)$$

$$d_1 = \sqrt{L^2 + 2L|\vec{Z}_n| + |\vec{P}_n|^2 + |\vec{Z}_n|^2}, \quad d_2 = \sqrt{L^2 - 2L|\vec{Z}_n| + |\vec{P}_n|^2 + |\vec{Z}_n|^2}, \quad (6-7)$$

$$\vec{R}_n = \vec{r} - \vec{r}'_n, \quad \vec{Z}_n = \vec{R}_n \cdot \hat{I}_n, \quad \vec{P}_n = \vec{R}_n - \vec{Z}_n. \quad (8-10)$$

Smith et al. (2004) presented a simple parametric form for estimating the time-domain B field response of a conductive permeable sphere due to a step function excitation. This is also the electro-dynamic ALLTEM response since its excitation is integral of the step (triangle wave), it uses dB/dt receivers, and the integral and derivative operations cancel each other. The form is a good approximation to the early-time, intermediate-time, and late-time portions of the response. The simple models for permeable and non-permeable spheres reduce to:

$$M_{sphere}(t, R) = \frac{4\pi R^3}{3} \frac{9\mu_r}{2(\mu_r + 2)} \left(1 + \sqrt{\frac{t}{\alpha}}\right)^{-\beta} e^{-t/\gamma}, \quad (11)$$

$$\alpha = 1.38\tau_1, \quad \beta = \frac{2\sqrt{\alpha}(\mu_r + 2)}{R\sqrt{\pi\sigma\mu_r\mu_0}}, \quad \gamma = \frac{\tau_0 + \sqrt{\alpha\tau_0/2}}{1 + \sqrt{\alpha/2\tau_0 - \beta/4}}, \quad (12-14)$$

$$\tau_0 = \sigma\mu_r\mu_0 R^2 / \delta_1^2, \quad \delta_1 = \pi + \arctan((\delta_1\mu_r - \delta_1)/(\mu_r - 1 + \delta_1^2)), \quad (15-16)$$

$$\tau_1^{\mu_r \approx 1} = \tau_0, \quad \tau_1^{\mu_r \gg 1} = \sigma\mu_r\mu_0 R^2 / ((\mu_r + 2)(\mu_r - 1)). \quad (17-18)$$

We combined this form with Smith and Morrison's (2006) approximation of the polarizability tensor for a prolate spheroid in terms of that of a sphere. For the n^{th} element along the diagonal, this yields,

$$M_n(t) = \frac{2a^2b}{9R_n^3} \frac{\mu_r + 2}{\mu_r} \left[\frac{1}{1 - A_n} + \frac{\mu_r - 1}{1 + A_n(\mu_r - 1)} \right] M_{sphere}(t, R_n). \quad (19)$$

$$R_1 = b \quad R_2 = a \quad (22-23)$$

where b is the half-length of the spheroid, a is the radius, and the demagnetization factors A_n are given in Smith and Morrison (2006, eqns. A-2 and A-3). The magnetostatic response is simply

$$M_n^{DC} = \left[\frac{\mu_r - 1}{1 + A_n(\mu_r - 1)} \right] \quad (20)$$

Combining both the electro-dynamic and the magneto-static responses, we obtain

$$M_n^{ALLTEM}(t) = 2M_n(t) - M_n(t = 5.55 \cdot 10^{-3}) - M_n^{DC}, \quad (21)$$

where the electro-dynamic response at 5.55 ms is subtracted to account for any eddy currents that have not decayed when the transmitted waveform changes slope. Finally, the time domain ALLTEM response is calculated from Equations 3, 4, and 21 where ω is replaced by t .

The inversion employs an iterative Gauss-Newton minimization combined with step-size optimization as follows,

$$\alpha \vec{J}^\dagger(\vec{x}_i) \cdot \vec{C}^{-1} \cdot (\vec{f}(\vec{x}_i) - \vec{f}_0) = \vec{x}_{i+1} - \vec{x}_i, \quad (22)$$

$$\vec{J}(\vec{x}_i) = \nabla \vec{f}(\vec{x}_i), \quad (23)$$

$$\vec{C} = \begin{bmatrix} \sigma_1 & \dots & 0 \\ \vdots & \ddots & \vdots \\ 0 & \dots & \sigma_n \end{bmatrix}, \quad (24)$$

$$\min_{\alpha \in (0,1]} \left\| \vec{f}(\vec{x}_{i+1}) - \vec{f}_0 \right\|^2, \quad (25)$$

where $\vec{J}^\dagger(\vec{x}_i)$ is the pseudo-inverse of $\vec{J}(\vec{x}_i)$, and $\vec{f}(\vec{x})$ is the forward model vector containing predicted data samples, \vec{f}_0 is the measured data, \vec{C} is a diagonal matrix containing the data standard deviations (it is assumed that the data are identically distributed and statistically independent), and \vec{x} contains the parameters. At each iteration, the step length is scaled by α which is varied in discrete steps over the interval (0,1] to find the step that results in the smallest least squares data misfit. Since the number of data (number of coil combinations times number of instrument locations times number of waveform points) far exceeds the number of parameters to be estimated, the pseudo-inverse of the Jacobian matrix is calculated by singular value decomposition. Instabilities due to poor conditioning are avoided by scaling the parameters so their ranges all lie within 1-2 orders of magnitude, and by only using singular values that have magnitudes of at least 10^{-3} times the dominant singular value. At each iteration, the target's orientation angles are constrained to be between $-\pi$ and π , and the spheroid diameters are constrained to be positive. Iteration stops when a local minimum is found, or the maximum allowable number of iterations is reached. This basic search algorithm is used with a state machine to estimate the target parameters as described below.

The first step in the parameter estimation problem is to choose an initial model. The x and y target locations are selected from the centroid of the anomaly, and the z location is estimated by finding the least squares minimum of

$$f_{depth}(z) = \sum_c \sum_n \left\| \ln \left[\frac{|f^c(\rho_n, z)| - |f^c(0, z)|}{|f_0^c(\rho_n, z)| - |f_0^c(0, z)|} \right] \right\|^2, \quad (26)$$

where f^c is the modeled data and f_0^c is the measured data for coil combination c at instrument location n . All data are from the same time-gate (usually $t = 5$ ms), and ρ_n is the horizontal distance from the centroid at instrument location n . This functional calculates the slopes of the logarithm of the fields versus distance from the target (i.e. slope is -3 for the fields of a static dipole decaying at r^{-3}), and compares the slopes of measured data and data modeled for a spheroid. To determine a representative permeability value, the late-time magnitudes are examined to determine if the target is ferrous or non-ferrous ($\mu_r = 1$). For ferrous targets, the demagnetization effect must be considered. For targets with relative permeabilities ranging from 50 to 1000, a nominal value of 100 is sufficient to model objects with aspect ratios less than about four, therefore the selected representative value of μ_r is held fixed during the inversion. An initial conductivity is chosen based values of typical metals used in UXO construction. The conductivity of aluminum alloys typically range from about $1.5 \cdot 10^7$ to $3.5 \cdot 10^7$ S/m, and steel alloys typically range from $0.2 \cdot 10^7$ to $0.9 \cdot 10^7$ S/m, which makes $1.0 \cdot 10^7$ S/m a reasonable starting value. Initial orientation angles (pitch and yaw) are zero.

With a representative permeability value, it is possible to determine the principle spheroid diameters using the response at time $t = 0^+$ (the instant the transmitter turns off). This however, requires a system with instantaneous turn off time and a receiver with infinite bandwidth. With some high-bandwidth systems, it may be possible to extrapolate back from earliest available time sample at a slope of $t^{1/2}$ to estimate the dimensions of the target.

In conducting trials with the minimization algorithm, it was observed that there is a basin of attraction associated with both prolate models and oblate models. Oftentimes, the evolving data misfit function would enter an incorrect basin of attraction only to find a local minimum. The solution to this problem is to minimize the misfit function using a prolate model, then using an oblate model, and then using an ellipsoidal model, and then choose the solution with the best fit. While minimizing these functions, data from 10 time gates representing the time-decay curve are used, and both initial models use a larger diameter of 0.26 m, and a smaller diameter of 0.1 m. Because most of the energy in the ALLTEM waveforms from ferrous targets at times greater than 1 ms is magnetostatic, the μ and σ are held fixed to reduce the degrees of freedom while searching for optimum prolate and oblate models. The final step is to polish the conductivity value using the best solution found thus far, using data from all time-gates selected for analysis and holding all other parameters fixed.

The mean squared error in the best-fit modeled data is assumed to be due to variations from a non-ideal systematic response. These variations include components of the instrument response not accounted for by the model (drift, non-linear response, etc.), components of target response not accounted for by the model, ambient EM noise, geologic noise, errors in instrument location, and attitude variations of the instrument. To estimate the uncertainty in the estimated parameters, each parameter is perturbed from its best-fit value until the mean squared error of the modeled data increases by the variance estimate of the data.

The number of data points is typically chosen to be less than ~1000 so that the inversion can be accomplished in a reasonable time frame (about a minute). When selecting a set of coil combinations to use in the analysis, the set that carries the most (orthogonal) information is

desirable. To select a subset of coil combinations from the recorded set of 19 coil combinations, selections are made in order of decreasing data variance until a single selection for each of the nine possible polarization combinations (i.e. (T_{x_x}, R_{x_x}) , (T_{x_x}, R_{x_y}) , etc.) has been made. Additional selections up to a user-defined total of 14 are made in order of decreasing data variance or high signal to noise characteristics.

An excerpt from an example inversion run log is presented in Figure 18. This is the run log for the ALLTEM data in cell A6 of the APG Calibration Grid. Cell A6 contains a 155 mm projectile buried at 1.08 m with an azimuth of 114.2 degrees and an inclination of 3.4 degrees. This type of projectile has a nominal diameter of 155 mm and thus a radius of 77.5 mm. The inverted radius from the ALLTEM data was 74 mm, the depth 0.91 m, azimuth 291.3 degrees, and inclination 0.6 degrees. These results are very close to the ground truth values for this target.

```

ModelNum: 1; Iteration: 14a; StepSize: 0.000000, ParamsErr: 0.003482, MSE: 0.161280.
100.000, 8500000.000, 0.649, -1.769, -0.911, 0.170, 0.074, 0.074, -0.000,
0.010, 0.561
ModelNum: 1; Iteration: 15a; StepSize: 0.000000, ParamsErr: 0.003482, MSE: 0.161280.
100.000, 8500000.000, 0.649, -1.769, -0.911, 0.170, 0.074, 0.074, -0.000,
0.010, 0.561
ModelNum: 1; Iteration: 16a; StepSize: 0.000000, ParamsErr: 0.003482, MSE: 0.161280.
100.000, 8500000.000, 0.649, -1.769, -0.911, 0.170, 0.074, 0.074, -0.000,
0.010, 0.561
Final Parameters:
---Mu--- ----Sigma-----X-----Y-----Z----- --Length- --width1- --width2- --Roll---
---Pitch-- ---Yaw---
100.000, 8500000.000, 402769.403, 4369599.164, -0.910, 0.169, 0.074, 0.074, 0.000,
0.010, 0.559
Target Azimuth: 291.337, Target Inclination: 0.599
Final MSE: 0.161278.

Calculating Uncertainties...

Final Parameter Uncertainties:
---Mu--- ----Sigma-----X-----Y-----Z----- --Length- --width1- --width2- --Roll---
---Pitch-- ---Yaw---
0.000, >20000000.000, >0000001.000, >0000001.000, >0001.00, 0.098, 0.090, 0.059, 0.000,
1.240, >0002.00
Target Azimuth Uncertainty: 71.047, Target Inclination Uncertainty: >0114.59

End inversion for target parameters...

Inversion used data StdDev/RMSData: 1.049114e+000, and RMSData: 2.798187e-001.

Inversion used 3780 data points, 14 coil combos, 9 time samples, and 30 spatial locations.
Operations Complete.

```

Figure 18. Excerpt of inversion run log for cell A6 (Patch 54) in the APG Calibration Grid. This is a 155mm projectile buried at 1.08 meters, azimuth of 114.2 degrees, and an inclination of 3.4 degrees. The inverted depth is 0.91 meters, azimuth of 291.3 degrees, and inclination of 0.6 degrees. The inverted depth is off by 0.17 m, azimuth by 177 degrees, and inclination by 2.8 degrees.

6.4 TRAINING

Training data for classification purposes came from the results of the analysis of the ALLTEM survey over the Calibration grids at both YPG and APG. There are approximately 4-6 targets per munitions type buried in each of the Calibration grids that provided useful information for the statistical classifier discussed in the next section. The known Calibration Grid targets provided statistics on the location accuracy and correct determinations of depths, azimuths, and inclinations as well as the inverted lengths and radii.

The numerical inversion results from the ALLTEM survey over the APG Calibration Grid and also data from ALLTEM data acquired over the Yuma Proving Ground Calibration Grid were used as the training data for the classification analysis of the Blind Test Grid, Direct Fire, and Indirect Fire areas. These data are summarized in Figure 19.

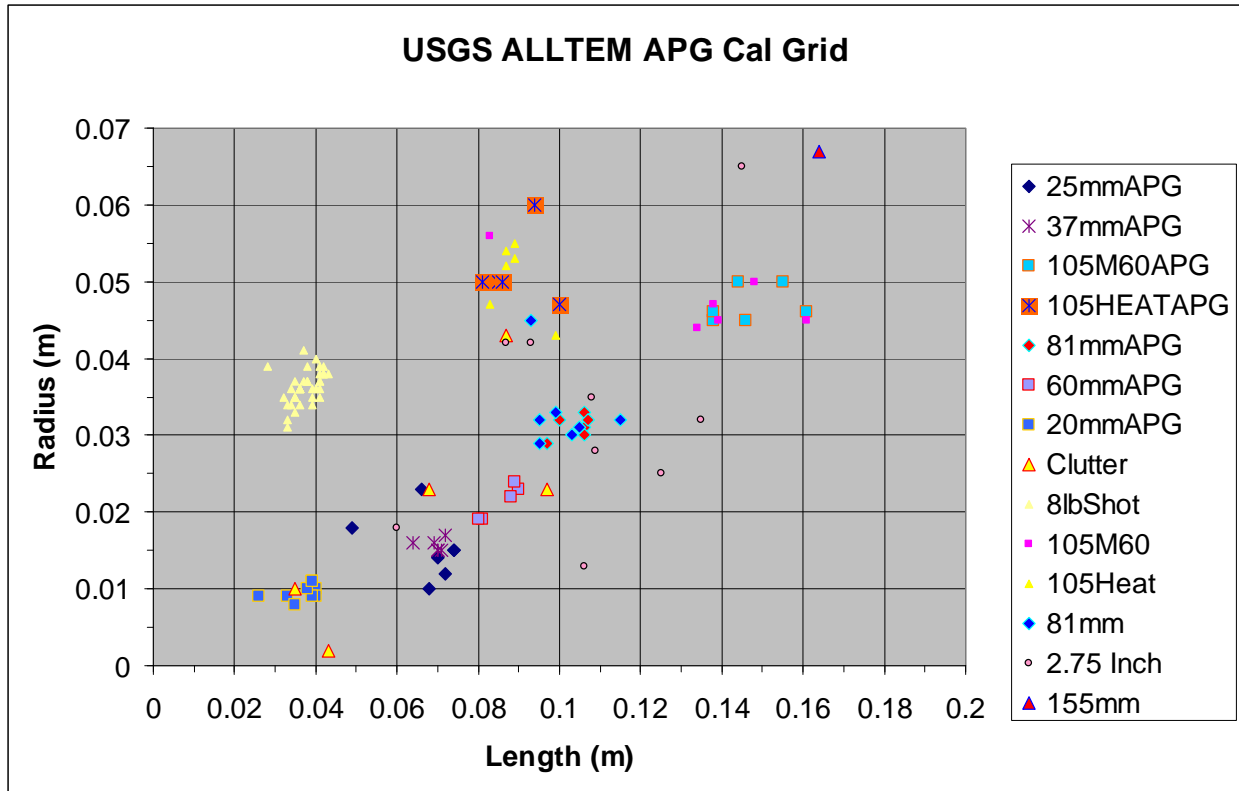

Figure 19. ALLTEM APG Calibration Grid numerical inversion results.

6.5 CLASSIFICATION

Classification of ALLTEM targets will be achieved by making a statistical comparison between information derived from known targets acquired over the training grids (in this case the Calibration grids at YPG and APG) to the signal and noise characteristics and inversion analysis results for the unknown materials. Unknown materials will be segregated into four main groups ranked by levels of confidence with an associated uncertainty that the anomalous material is not a target of interest (TOI). The four groupings will be “High Confidence Non-TOI”, “Can’t Make A Decision”, “High Confidence TOI”, and “Can’t Analyze” (which is usually due to low SNR for the ALLTEM). Signal and noise characteristics will be derived from both the preprocessing analysis (ferrous, nonferrous, or mixed composition) and processing (shape information from inversion, SNR, target size (area of target) statistics). Care will be given in deciding what classification thresholds are used in recognition of the significantly higher costs of false negatives as compared to false positives.

A multiple comparison Student’s T-test is made by creating the probability density distribution for the function shown in Figure 20.

$$f(x) = \frac{\Gamma((n+1)/2)}{(\sqrt{n\pi})\Gamma(n/2)} \left(1 + \frac{x^2}{n}\right)^{-\frac{(n+1)}{2}}$$

Figure 20. Probability density function used to create a distribution showing the relation of known targets to unknown targets. $\Gamma \rightarrow$ Gamma function, $n \rightarrow$ degrees of freedom.

For a given set of unknown parameters the intervals that the T-distribution will cover at a given confidence level (α) are computed. These intervals are expanded to account for the multiple comparisons using Bonferroni’s Method. This is accomplished by $\alpha = \alpha/m$ where m are the number of comparisons being made. The actual procedure is to simulate data around each set of known parameter values and perform a t-test on this simulated data. Unknown data are then compared to 100 simulations for each set of known ordnance parameters. Examples of the tables of known parameters are shown in Figure 21. An example of the Oasis menu item and classification results is shown in Figure 22 and additional classification results are presented in Appendix 4.

155 mm			105 mm M60			BDU28		
Len	Width	Tau	Len	Width	Tau	Len	Width	Tau
0.137	0.079	-6.57171	0.154	0.05	-6.3586	0.038	0.029	-6.8052
0.174	0.075	-8.06782	0.154	0.039	-5.1389	0.04	0.03	-7.0142
0.151	0.08	-6.35774	0.148	0.05	-9.4961	0.04	0.03	-6.7626
0.148	0.068	-8.92571	0.134	0.044	-9.1316	0.038	0.028	-8.504
0.169	0.074	-9.17839	0.161	0.045	-5.8998			

40 mm MK2 Projectile			BLU-26			81 mm Projectile		
Len	Width	Tau	Len	Width	Tau	Len	Width	Tau
0.078	0.018	-6.126	0.031	0.024	-21.3626	0.093	0.038	-8.496
0.085	0.017	-5.333	0.035	0.022	-18.0124	0.084	0.031	-7.267
0.067	0.018	-5.603	0.031	0.021	-22.4924	0.111	0.032	-6.825
0.07	0.02	-8.475				0.085	0.034	-6.881

60 mm Projectile			M42-1 Submunitions			40 mm Rifle Grenade		
Len	Width	Tau	Len	Width	Tau	Len	Width	Tau
0.077	0.027	-7.8028	0.029	0.015	-20.9203	0.027	0.024	-7.823
0.085	0.021	-7.8926	0.029	0.017	-15.5508	0.029	0.023	-7.467
0.088	0.024	-5.9094	0.021	0.013	-17.1652	0.036	0.027	-1.11361
0.083	0.021	-3.6281	0.022	0.013	-14.6351	0.032	0.027	-4.40274

Figure 21. Portions of tables of known parameters from targets in the APG Calibration Grid.

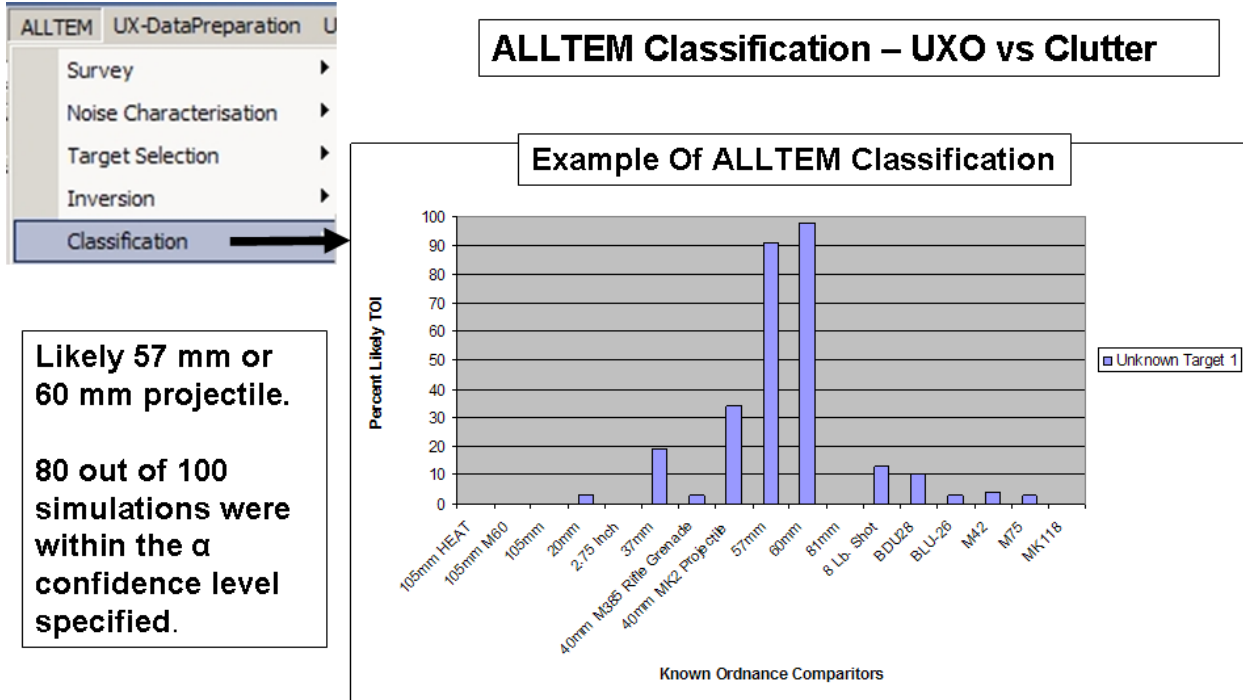

Figure 22. Classification example demonstrating the classification result.

6.6 DATA PRODUCT SPECIFICATION

Table 5 presents a portion of the final data product for the APG Blind Test Grid classification results. The full data products are contained in Appendix 4. Letters and numbers label the Blind Test grid cell locations and Eastings and Northings were used to label the Direct Fire Area and the Indirect Fire Area targets. As discussed in section 6.5 above, the rankings were sorted by the probability that an item is of Non-TOI character (clutter) and on down.

The information in this table were provided to the project reviewer in order to determine if the metrics listed in Table 1 in section 3 can be evaluated. The information in Appendix 4 will allow determination if all TOI were detected, items were correctly classified as Non-TOI, TOI, Can't Say, and Can't Analyze, and TOI that could be discriminated could be properly identified. As this table will also includes eastings and northings, the location accuracy metric (3.4) can also be assessed.

Table 5. Sample final data product

ALLTEM APG 2010 Blind Test Grid, ver.3														
Northing, UTM 18N, meters	Easting, UTM 18N, meters	Cell	Anomaly Number	Letter	Number	Disc. Stage/Rank 3 - Ord 2 - Clutter 1 - Blank	Class O - Ord C - Clutter B - Blank	Type	Depth (m)	Azimuth (Deg)	Inclination (Deg)	Length (m)	Radius (m)	MSE
4369542.1	402788.7	a1	81	A	1	2	C		-0.04	267.9	17.8	0.027	0.017	0.232
4369542.3	402790.8	a2		A	2	1	B							
4369542.7	402792.7	a3		A	3	1	B							
4369543.0	402794.7	a4		A	4	1	B							
4369543.4	402796.7	a5		A	5	1	B							
4369544.1	402798.4	a6	182	A	6	2	C		-0.03	198.0	-18.8	0.019	0.013	0.202
4369544.1	402800.6	a7	202	A	7	2	C		-0.06	54.2	132.4	0.018	0.008	0.616
4369544.5	402802.5	a8	226	A	8	3	O	25mm	-0.06	173.8	5.0	0.052	0.018	0.077
4369544.8	402804.5	a9		A	9	1	B							
4369545.0	402806.7	a10	266	A	10	2	C		-0.07	166.5	-4.8	0.025	0.011	0.513
4369545.9	402810.4	a11		A	11	1	B							
4369545.9	402810.4	a12	309	A	12	2	C		-0.08	188.8	-1.0	0.033	0.011	0.266
4369546.3	402812.4	a13	326	A	13	3	O	25mm	-0.10	171.3	-0.9	0.061	0.011	0.112
4369546.6	402814.2	a14	346	A	14	3	O	81mm	-0.31	117.3	-164.9	0.107	0.034	0.090
4369547.0	402816.3	a15		A	15	1	B							
4369547.4	402818.3	a16	389	A	16	3	O	105M60	-0.27	241.1	27.5	0.126	0.049	0.069
4369547.8	402820.3	a17	408	A	17	3	O	81mm	-0.17	43.2	20.3	0.115	0.028	0.128
4369548.1	402822.2	a18		A	18	1	B							
4369548.4	402824.3	a19	447	A	19	3	O	105M60	-0.40	240.0	9.4	0.123	0.044	0.075
4369548.8	402826.1	a20		A	20	1	B							
4369543.8	402788.4	b1	77	B	1	2	C		-0.09	182.9	-5.4	0.028	0.019	0.109
4369544.2	402790.4	b2	97	B	2	2	C		-0.06	189.2	11.1	0.054	0.010	0.091
4369544.5	402792.4	b3	118	B	3	3	O	81mm	-0.12	299.9	1.8	0.116	0.035	0.109
4369545.2	402793.7	b4	131	B	4	3	O	60mm	-0.32	319.1	-5.7	0.085	0.019	0.830

7.0 PERFORMANCE ASSESSMENT

Table 6 presents the scoring of the ALLTEM classification results by the Institute for Defense Analysis. These data are the substance of the email communications received regarding the scoring of the ALLTEM data from the three unknown areas, the Blind Test Grid, the Direct Fire Area, and the Indirect Fire Area.

7.1 OBJECTIVE: DETECTION OF ALL MUNITIONS OF INTEREST

The effectiveness of the technology for detection and discrimination of munitions is a function of the degree to which all munitions of interest are detected with high confidence. In the APG Blind Test Grid, as scored by the Institute for Defense Analysis (IDA) and rounded to the nearest 5%, the ALLTEM analysis resulted in a Pd (Probability of Detection) of UXO of 100% and a Probability of False Alarms (Pfa) of 25%. For the Direct Fire Area the ALLTEM analysis resulted in a Pd of ordnance detected of 95% and a Pfa of 45% which is not too good. For the Indirect Fire Area the analysis resulted in a Pd of UXO of 95%.

7.2 OBJECTIVE: CLASSIFICATION OF ANOMALIES

The effectiveness of the technology for detection and discrimination of munitions is a function of the degree to which responses that do not correspond to targets of interest can be eliminated with high confidence. In the APG Blind Test Grid, as scored by IDA, the ALLTEM analysis resulted in a Probability of Correct Classification (Pcc) of UXO of 95%. In the Direct Fire Area the ALLTEM analysis resulted in a Pcc of UXO of greater than 95% and in the Indirect Fire Area the analysis resulted in a Pcc of UXO of 95%.

7.3 OBJECTIVE: DISCRIMINATION OF MUNITIONS OF INTEREST AND CLUTTER

The scoring metrics we receive from IDA have never broken out the exact numbers and types of munitions and clutter in order to reduce the number of times the test site areas need to be reconfigured. Even so, as indicated in Table 6, we do have some scoring metrics for the surveyed areas. In the Blind Test Grid analysis, 25% of the detected clutter was called ordnance. In the Direct Fire Area analysis, 45% of the detected clutter was called ordnance. In the Indirect Fire Area analysis, 90% of the detected clutter was called clutter (i.e. only 10% of the clutter was called ordnance).

7.4 OBJECTIVE: LOCATION ACCURACY

The effectiveness of the technology for detection and discrimination of munitions is a function of the degree to which the anomalous responses are accurately located. The average errors in northing and easting locations for the APG Calibration Grid are -0.08 m and 0.20 m respectively. Note that data locations are recorded every 0.20 m. Since the scoring for the Blind Test Grid assumes use of the theoretical cell center positions and does not take into account the accuracy of the inverted positions and since the precise locations of the items in the Direct Fire and Indirect Fire areas are unknown, this criteria cannot be comprehensively evaluated for these areas.

Table 6. ALLTEM APG Detection and Classification Scoring Results

Area	Scoring Summary (rounded to 5%)
Blind Test Grid	Pd for UXO = 100%
	Pcc for UXO = 95%
	Pfa (blank squares called C or O) = 25%
	% false positives (detected C called O) = 25%
	False negatives showed no obvious trends re type of UXO or depth of burial.
Direct Fire Area	For the Response (detection) stage:
	Pd for UXO = 95%
	% false positives (detected C called O)= 45%
	Pd(Depth: 0-4xdiam.)= 95%
	Pd(4-8xdiam.)= 95%
	Pd(>8xdiam.)= 90%
	For the Classification stage (only includes items detected in the response stage):
	Pcc(detected O called O) = >95%
	Pcc(0-4xdiam.)= >95%
	Pcc(4-8xdiam.)= >95%
	Pcc(>8xdiam.)= 95%
No significant dependence on UXO type is observed	
Indirect Fire Area	Pd for UXO = 95%
	Pcc for UXO detected = 95%
	Pd for Clutter = 65%
	Pcc for Clutter detected = 90%
	For UXO detection, Pd for items buried 0D to 8D = 95%
	Pd for items buried >8D = 85%
	For UXO classification, Pcc for items buried 0D to 8D = 95%
	Pcc for items buried >8D = 75%

7.5 OBJECTIVE: PRODUCTION RATES

The effectiveness of the technology for detection and discrimination of munitions is a function of the how quickly and efficiently the area of interest can be surveyed and the data analyzed and interpreted. Table 7 presents a list of the APG test site areas surveyed and the actual times required for the ALLTEM to survey each area. These times include loss of production time due to waiting out loss of GPS RTK Fixed mode, being stuck in the mud /soup (Indirect Fire Area) and having to be dragged out to more solid ground, and avoiding the steep walls of a small creek running through the survey area (Direct Fire Area). Part way through surveying the Blind Test Grid we discovered a broken GPS antenna cable that had an intermittent connection when the cable swung as the tractor moved along. This caused some delays the first couple of days of surveying.

The last column in Table 7 indicates that, for an 8-hour day of surveying, the estimated production rates varied from 1.44 acres per day up to 1.92 acres per day. These rates are within the approximate bounds for achieving success for this survey objective.

Table 7. ALLTEM APG Survey Times.

Area Surveyed	Acres Surveyed	Actual Survey Time (hrs)	Survey Time without Delays (hrs)	Estimated Acres Surveyed/8 Hr Day
Calibration Grid	0.27	2	1.5	1.44
Blind Test Grid	0.5	3.5	2.5	1.60
Direct Fire Area	1.8	8	7.5	1.92
Indirect Fire Area	3.18	20	15	1.70
Total Acres Surveyed	5.75			

7.6 OBJECTIVE: HIGH QUALITY DATA

The effectiveness of the technology for detection and discrimination of munitions is a function of the quality of the data. Generally, the ALLTEM data collected at APG meet the specified criteria for achieving high quality data. As displayed in figures 14 through 17 and in the maps in Appendix 2, the acquired ALLTEM data show very little to no striping. However, as mentioned above in section 3.5.4, a broken GPS antenna cable created some dropouts during the first 1.5 days of surveying. These areas were resurveyed in order to provide a clean (no dropouts) data set for the analysis.

7.7 OBJECTIVE: EASE OF USE

The effectiveness of this technology for detection and discrimination of munitions is a function of how easy the ALLTEM system is to operate and the analysis software is to use. The ALLTEM data acquisition system and software had been streamlined prior to deployment to YPG in 2009 and further streamlined for this deployment to APG in 2010. The ALLTEM data acquisition software (in Labview) and the data analysis and processing software (customized for Geosoft

Oasis Montaj) performed as designed which resulted in an efficient investigation. Two operators traded off running the data acquisition during each field day and one operator handled the data analysis and processing in the evening and post survey operations. The system was very easy to use and operate as related by the operators in the cold and wet conditions as are typical in mid-March at APG.

8.0 COST ASSESSMENT

ESTCP projects are required to develop and validate, to the extent possible, the expected operational costs of the technology. The intent of this section is to identify the information that can be tracked or the data that can be obtained during the demonstration that will aid in establishing realistic costs for implementing the technology and comparing it to potential alternative technologies. This section of the Demonstration Plan must include a discussion of all relevant cost elements *unique to the technology* and related data that can be tracked and documented during the demonstration so that the operational costs of the technology can be estimated.

A simple cost model for the ALLTEM technology was developed. Focus was on cost elements that are unique to the technology. For each cost element, data that can be obtained during the demonstration that is relevant for estimating the cost of that element are identified. This table illustrates the cost elements that are relevant for the ALLTEM technology and identify what data were tracked in this project to validate the cost estimate.

8.1 COST MODEL

Table 8 presents a summary cost model for the ALLTEM APG survey. The instrument cost estimate is based on actual costs of components and time associated with developing, manufacturing, and building the various parts of the system. These costs could change as material costs vary with supply and demand.

The estimated mobilization and demobilization costs are based on the costs associated with this particular trip from Denver to APG and back.

The survey cost estimate is based on the time spent surveying the different areas at APG. It took about 28 hours to survey the 5.75 acres.

The preprocessing, detection, and discrimination costs are based on the time required to preprocess the data in Labview and then process the data in Oasis Montaj. As described above in section 6, using the ALLTEM Geosoft module required about 4 hours to import the data, invert the data, and classify the data for the Blind Test Grid and about 90 minutes for the Calibration Grid. The Direct Fire Area took about 8 hours and the Indirect Fire Area 12 hours to import, process, invert, and classify. Note that the BTG, Direct Fire, and Indirect Fire areas were each processed three times over the spring and summer of 2010 and resubmitted for scoring.

Table 8. Cost Model for the ALLTEM Demonstration Survey

Cost Element	Data to be Tracked	Estimated Costs
Instrument cost	Component costs and integration costs <ul style="list-style-type: none"> • Parts and Labor 	\$70,000 (including overhead)
Mobilization and demobilization	Cost to mobilize to site <ul style="list-style-type: none"> • Each way 	\$2,000 not including salaries
Site preparation	No unique requirements anticipated as the site is already set up.	
Instrument setup costs	Unit: \$ cost to unpack, set up, and calibrate Data requirements: Derived from demonstration costs <ul style="list-style-type: none"> • Hours required – 2 hours initial unpack\setup, 10 min to check Calib • Personnel required – 2 for setup, 1 for calibration • Frequency required – Daily QC checks – 1 ok, 2 better 	\$500(?) For unpack and set up
Survey costs	Unit: \$ cost per acre Data requirements: Derived from demonstration costs <ul style="list-style-type: none"> • Hours per acre – 4 hrs/acre for 5.75 acres Calibration, Blind Test, Direct Fire, Indirect Fire • Personnel required – 2 	\$2500 per acre
Detection data processing costs	Unit: \$ per hectare as function of anomaly density Data Requirements: Derived from demonstration costs <ul style="list-style-type: none"> • Pre-processing – 2-4 hrs • Detection Time required – 1-2 hrs/data set • Personnel required – 1 good 	\$50 / acre
Discrimination data processing	Unit: \$ per anomaly: Derived from demonstration costs <ul style="list-style-type: none"> • CPU time required - ~ 2 min/anomaly • Personnel required – 1 good 	\$20/anomaly

8.2 COST DRIVERS

Anticipated cost drivers include the time required to survey an area at 0.5 m line spacing with 0.20 m data density along the lines at 1.0 m/sec. Also, the time required to deal with problems such as GPS dropouts or mechanical breakdowns must be considered.

8.3 COST BENEFIT

The obvious benefit of a system such as the ALLTEM is the ability to reliably determine the nature of a buried target in the ground and then decide to dig it up or not dig it up. This is a very powerful tool because of the savings realized in reliably not digging a hole that would otherwise have had to be dug.

9.0 IMPLEMENTATION ISSUES

There were no issues deploying and operating the ALLTEM besides dealing with the freezing temperatures the first few days and then the water and mud the rest of the time. The ALLTEM demonstrated its ability to float across the 1 to 2 ft moats and still acquire good data. Problems occurred in the northwest corner of the Indirect Fire Area when the tractor towing the ALLTEM was not able to make any traction in the deep water that quickly became slick mud.

10.0 REFERENCES

- Anderson, W.L. 1979, Computer Program: Numerical Integration of Related Hankel Transforms of Orders 0 and 1 by Adaptive Digital Filtering, *Geophysics*, v. 44, p. 1287-1305.
- Smith, R., and Annan, P., 1998, The use of B-field measurements in an airborne time-domain system: Part I. Benefits of B-field versus dB/dt data: *Exploration Geophysics*, vol. 29, p. 24-29.
- Smith, J.T., and Morrison, H.F., 2006, Approximating Spheroid Inductive Responses Using Spheres: *Geophysics*, v. 71, n. 2, p. G21-G25.
- Smith, J. T., and Morrison, H. F., and Becker, A., 2004, Parametric Forms and the Inductive Response of a Permeable Conducting Sphere, *J. Environmental and Engineering Geophysics*, v. 9, p. 213-216.
- Ward, S.H., and Hohmann, G.W., 1988, Electromagnetic Theory for Geophysical Applications, *in* *Electromagnetic Methods in Applied Geophysics*, v. 1, ch. 4, M. N. Nabighian ed., Society of Exploration Geophysicists, Tulsa, OK.
- Wright, D.L., Moulton, C.W., Asch, T.H., Hutton, S.R., Brown, P.J., Nabighian, M.N., Li, Y., 2005, ALLTEM, A triangle wave on-time time-domain system for UXO applications, *in* *Proceedings of the Symposium on the Application of Geophysics to Engineering and Environmental Problems*, April 3-7, 2005, Atlanta, GA, p. 1357-1367.
- Wright, D.L., Moulton, C.W., Asch, T.H., Brown, P.J., Hutton, S.R., Nabighian, M.N., Li, Y., 2006, ALLTEM for UXO applications – first field tests, *in* *Proceedings of the Symposium on the Application of Geophysics to Engineering and Environmental Problems*, April 2-6, 2006, Seattle, WA p. 1761-1775.
- Wright, D.L., Smith, D.V., Asch, T.H., Moulton, C.W., Bracken, R.B., Irons, T.P., Li, Y., Nabighian, M.N., 2008, SERDP Project 1328 Final Report, 279 p.
- West, G.F., Macnae, J.C., and Lamontagne, Y., 1984, A time-domain electromagnetic system measuring the step response of the ground: *Geophysics*, vol. 49, p. 1010-1026.

Appendix 1

ALLTEM Calibration Data: Background and with Stainless Steel 4" Ball

Data are presented in the following order:

ZZM

ZZE

ZZF

ZZG

ZZH

ZY1

ZX1

YZM

YZE

YZF

YZG

YZH

YY1

XZM

XZE

XZF

XZG

XZH

XX1

Appendix 1 – ALLTEM Calibration Data

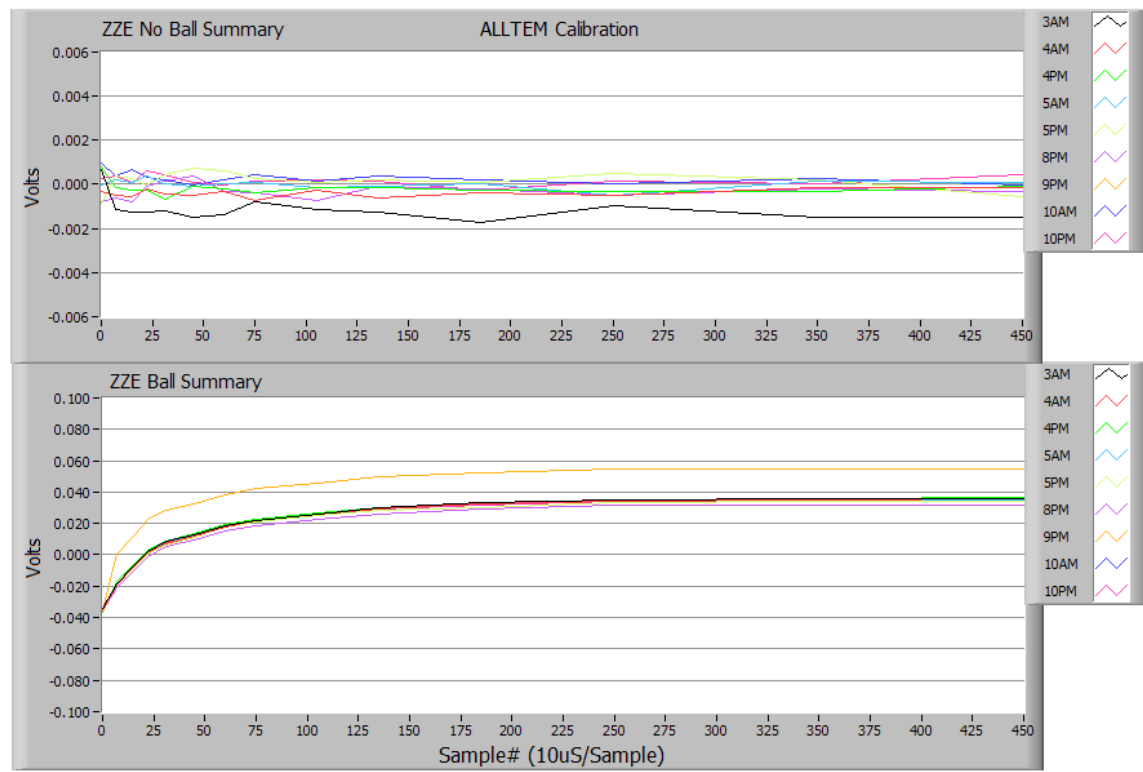
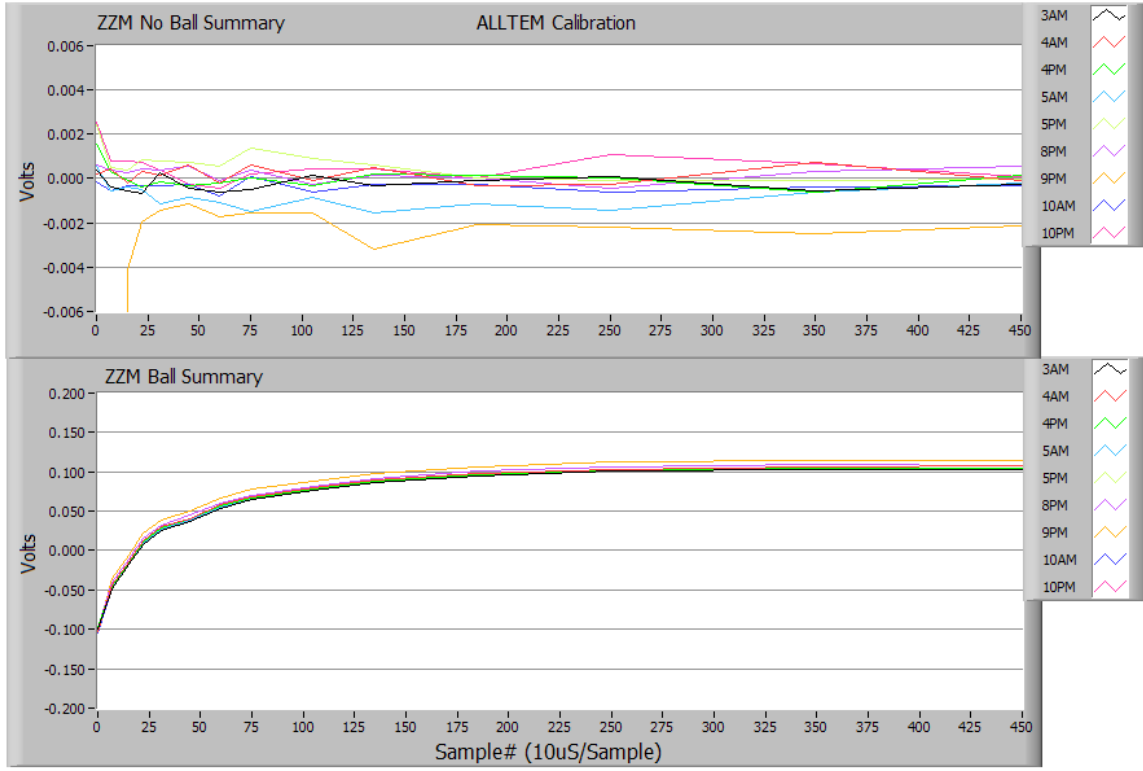

Appendix 1 – ALLTEM Calibration Data

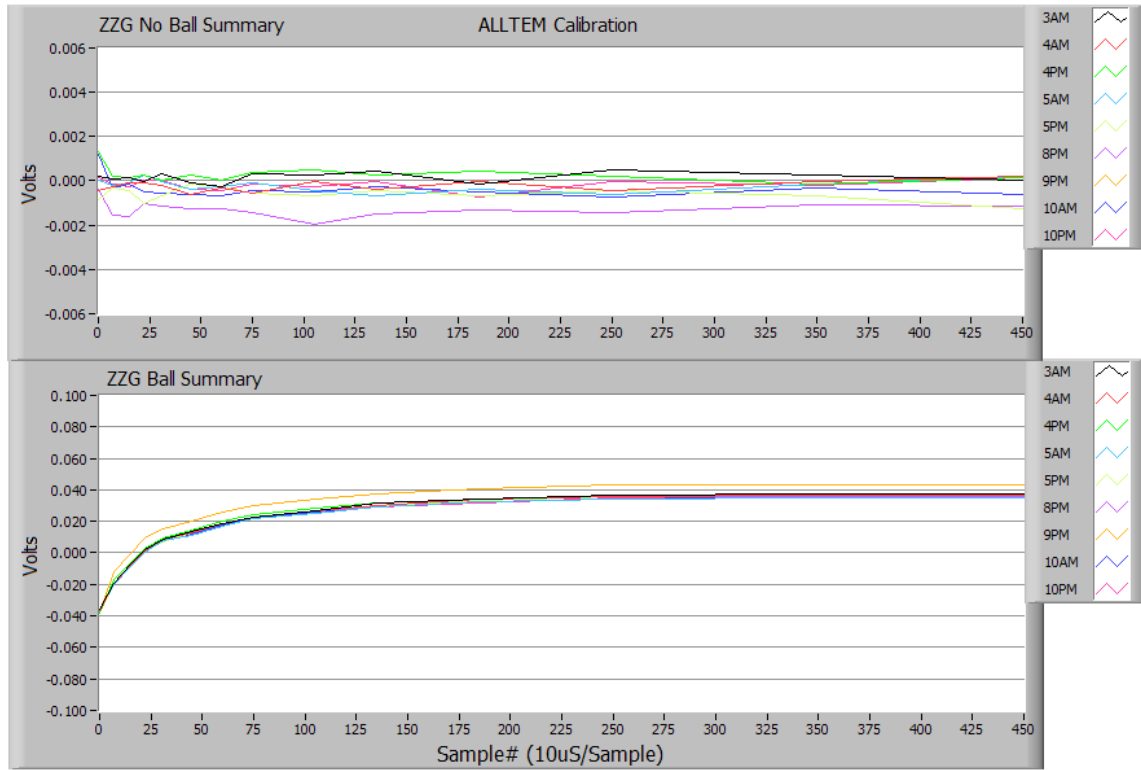
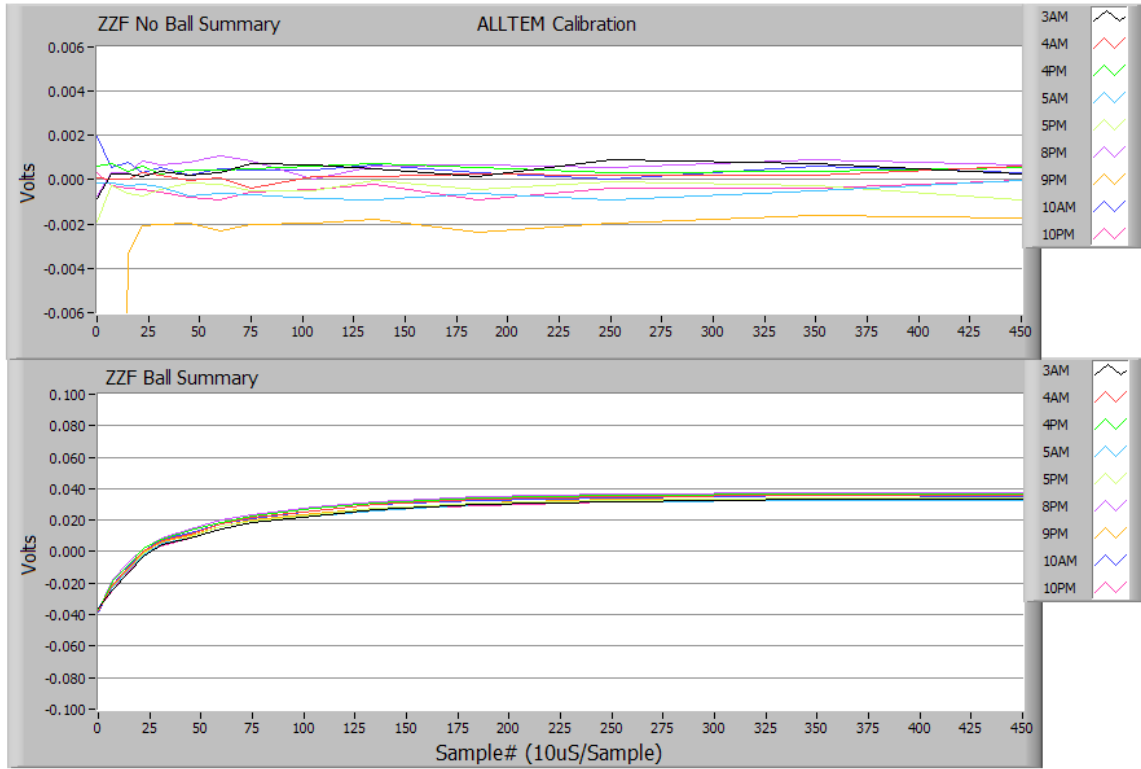

Appendix 1 – ALLTEM Calibration Data

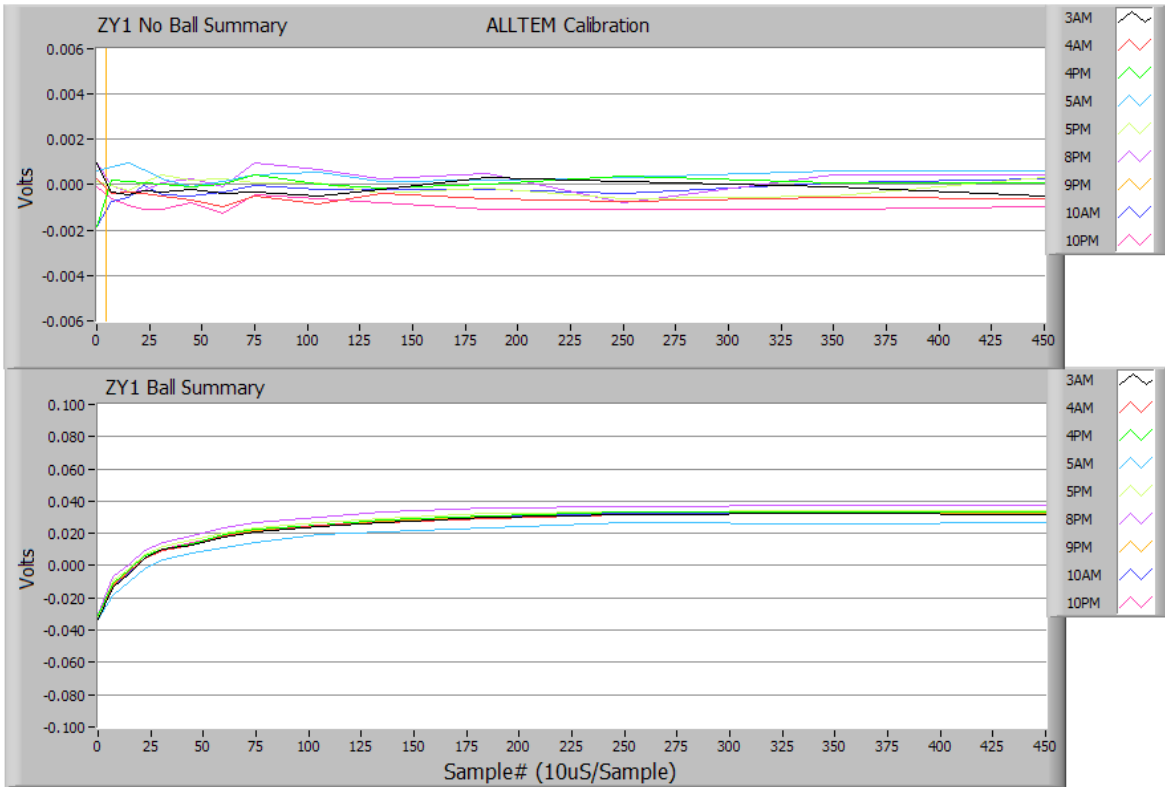
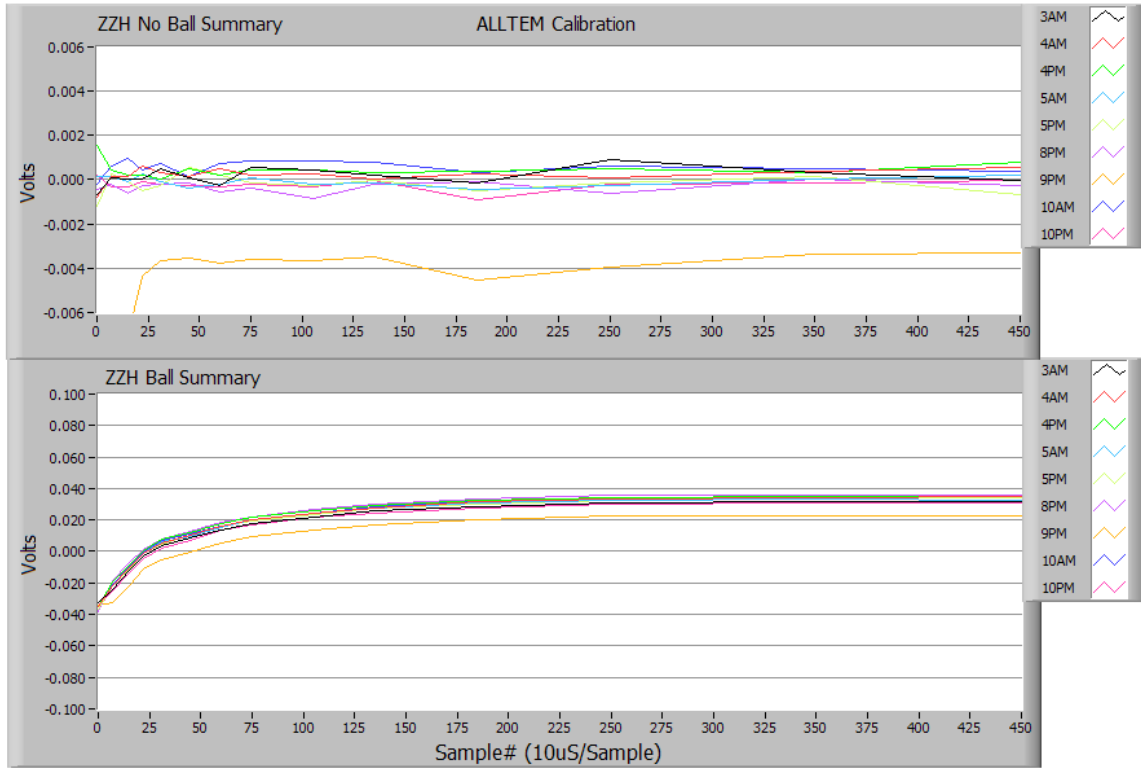

Appendix 1 – ALLTEM Calibration Data

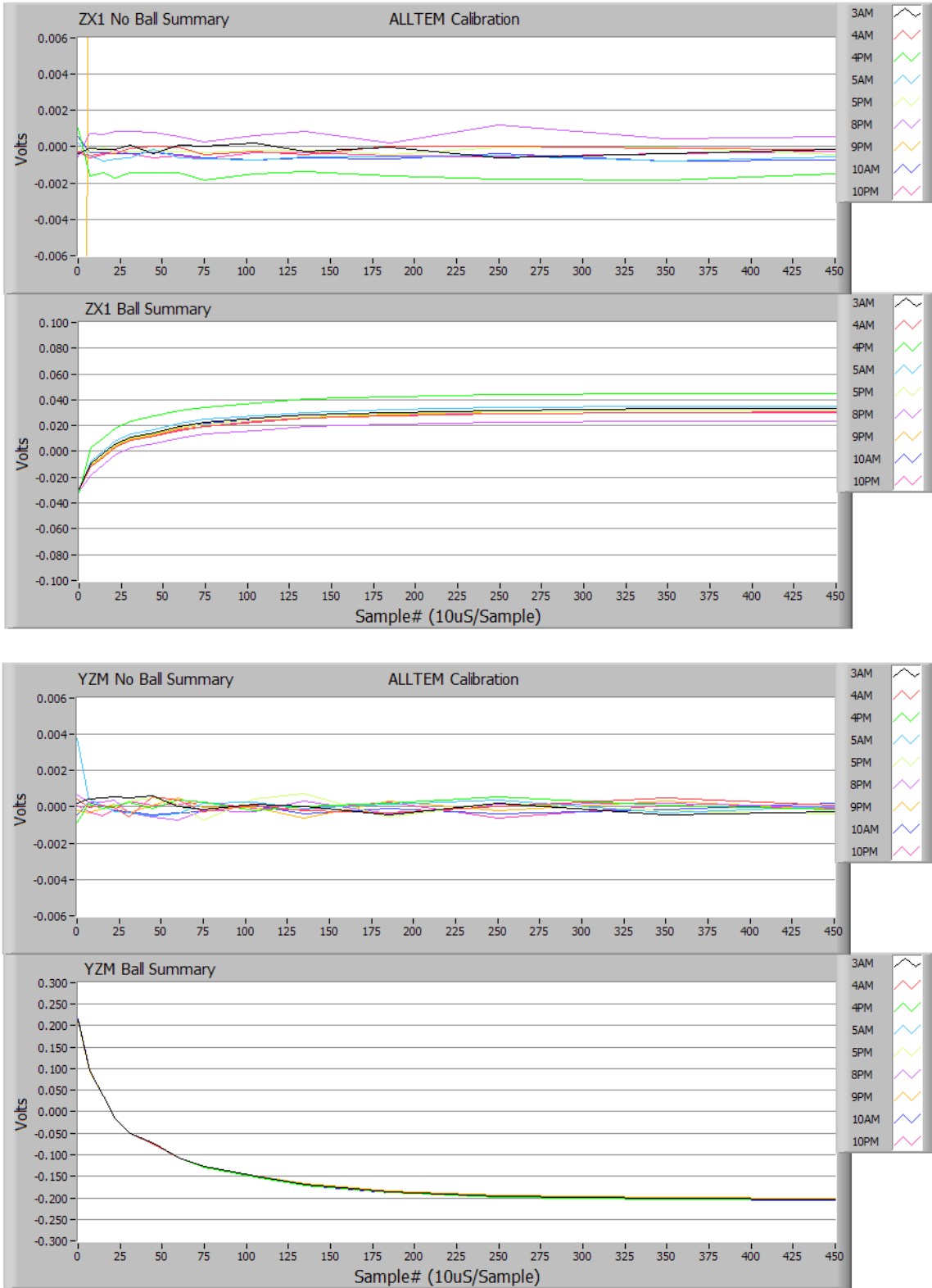

Appendix 1 – ALLTEM Calibration Data

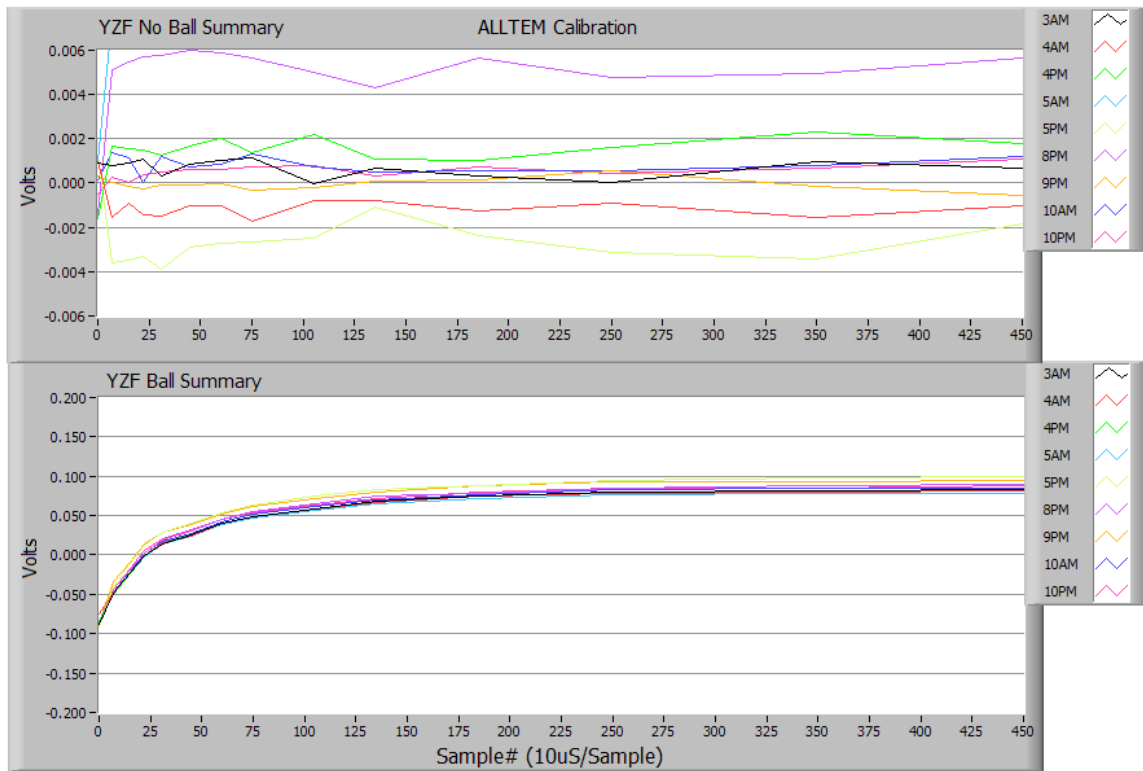
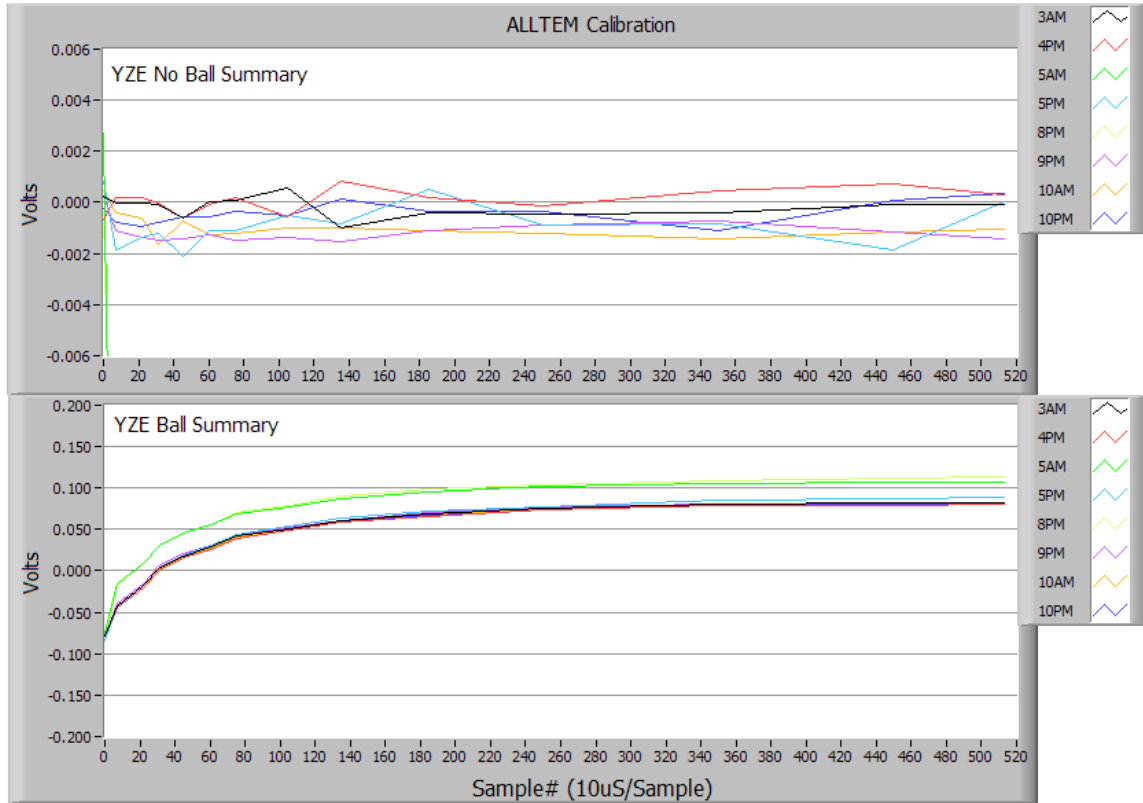

Appendix 1 – ALLTEM Calibration Data

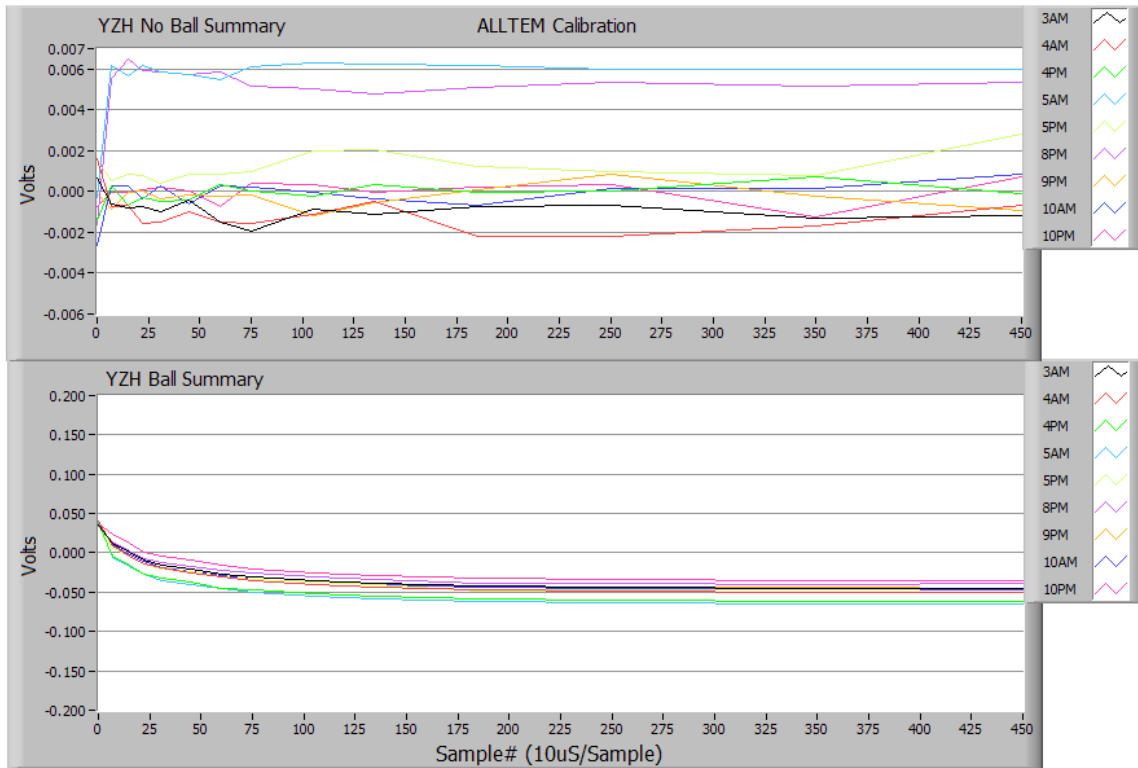
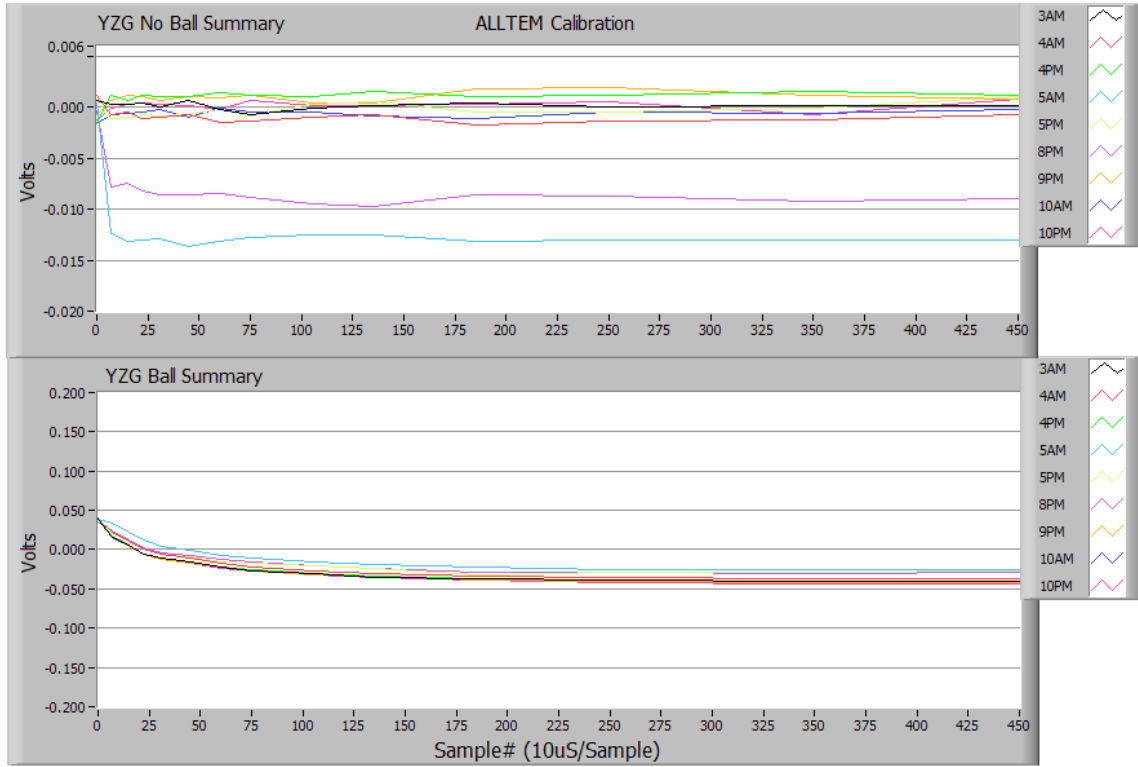

Appendix 1 – ALLTEM Calibration Data

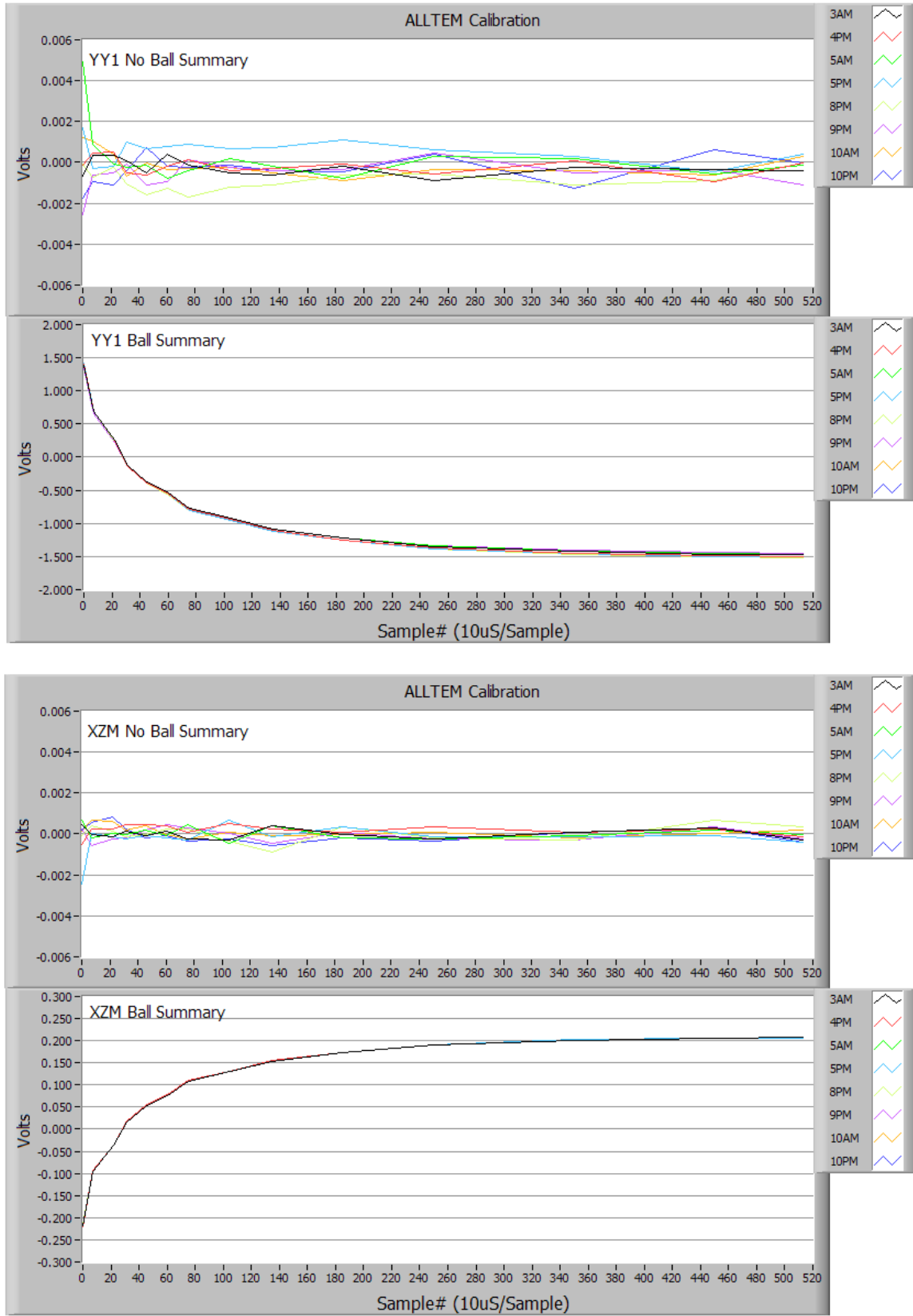

Appendix 1 – ALLTEM Calibration Data

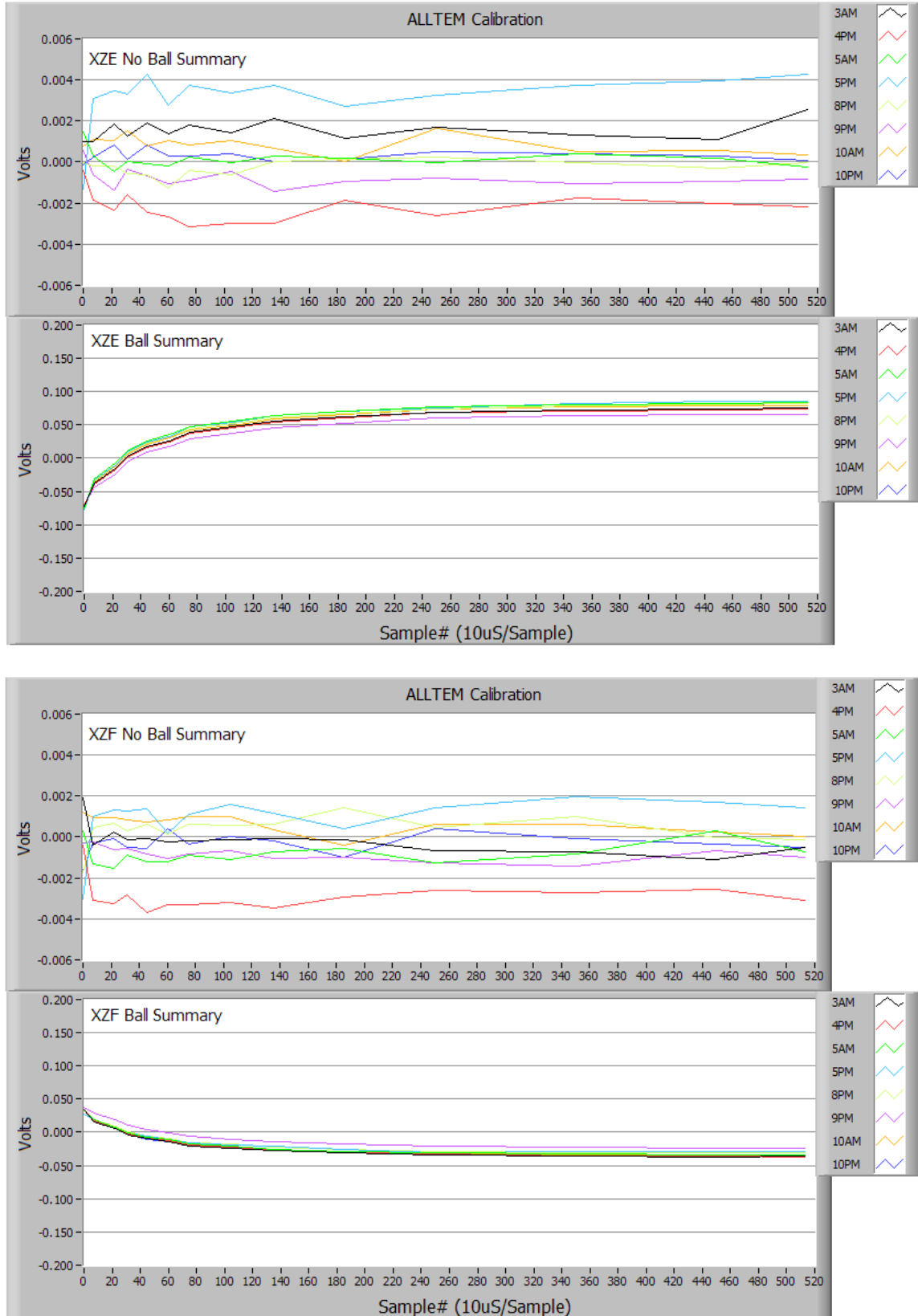

Appendix 1 – ALLTEM Calibration Data

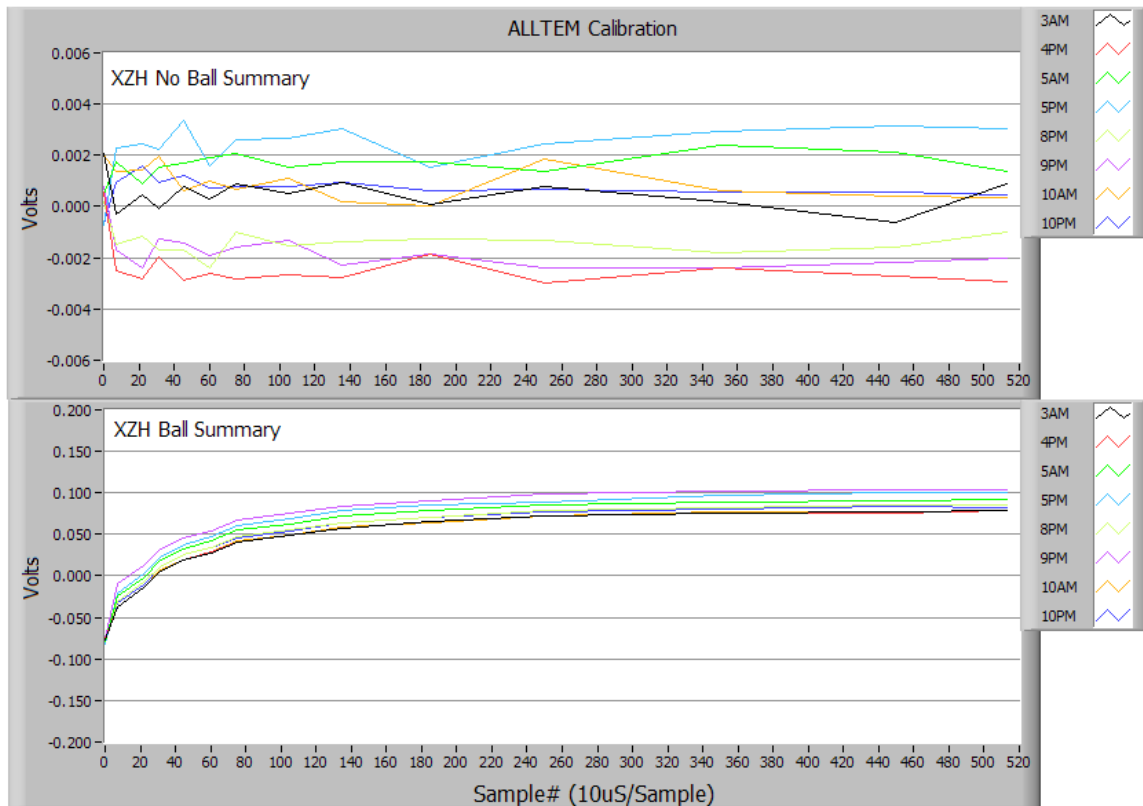
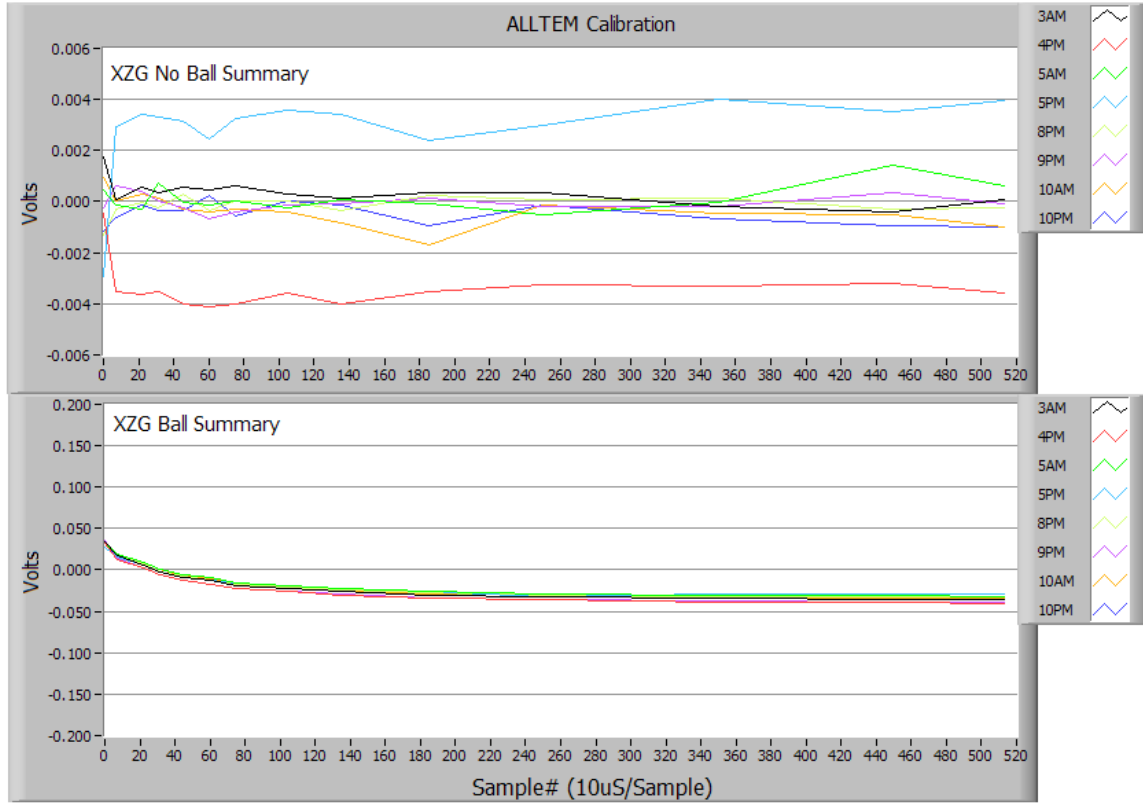

Appendix 1 – ALLTEM Calibration Data

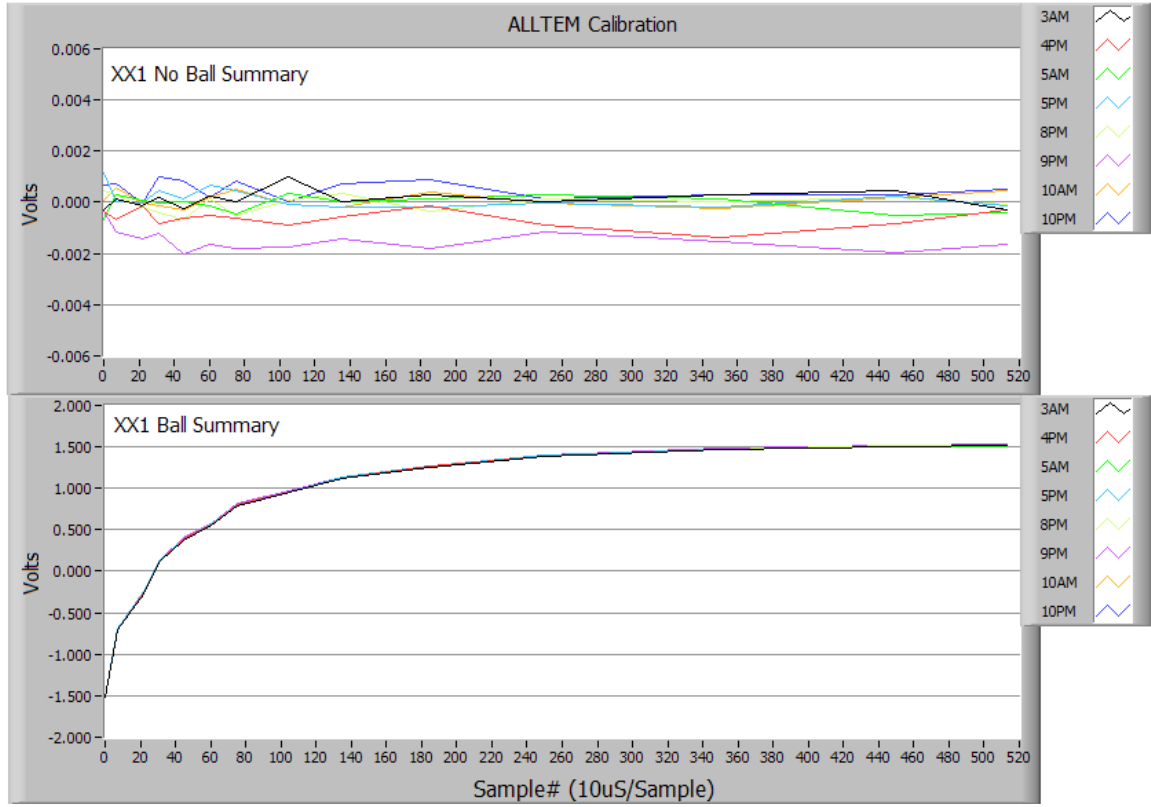

Appendix 2

ALLTEM Data Maps

APG ALLTEM Data maps and Signal to Noise maps are presented in the following order:

By Site:

- Calibration Grid
- Blind Test Grid
- Direct Fire Area
- Indirect Fire Area

By Receiver Configuration

- ZZM
- ZZE
- ZZF
- ZZG
- ZZH
- ZY1
- ZX1
- YZM
- YZE
- YZF
- YZG
- YZH
- YY1
- XZM
- XZE
- XZF
- XZG
- XZH
- XX1

Appendix 2 – ALLTEM Data and Signal to Noise Maps

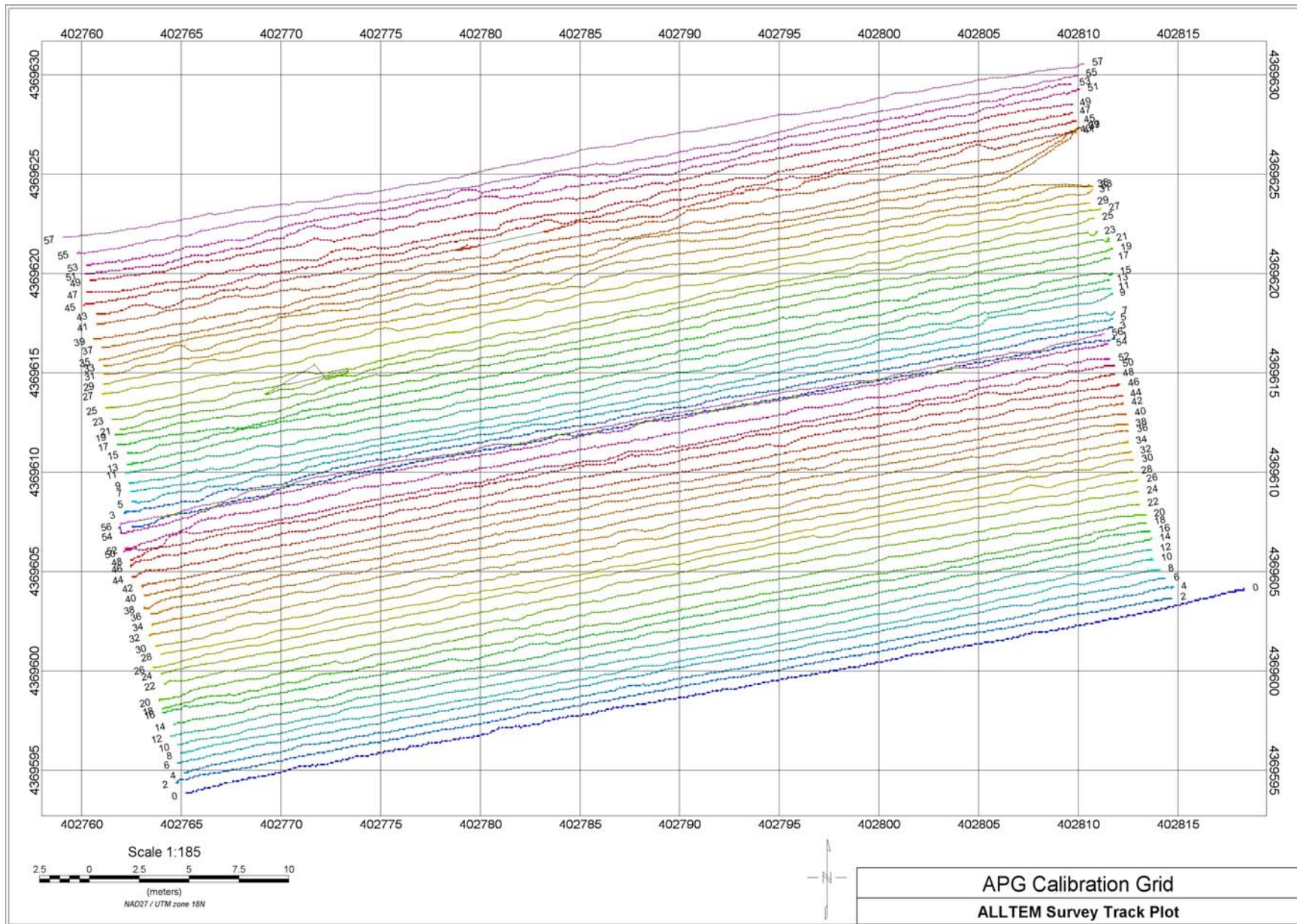

Appendix 2 – ALLTEM Data and Signal to Noise Maps

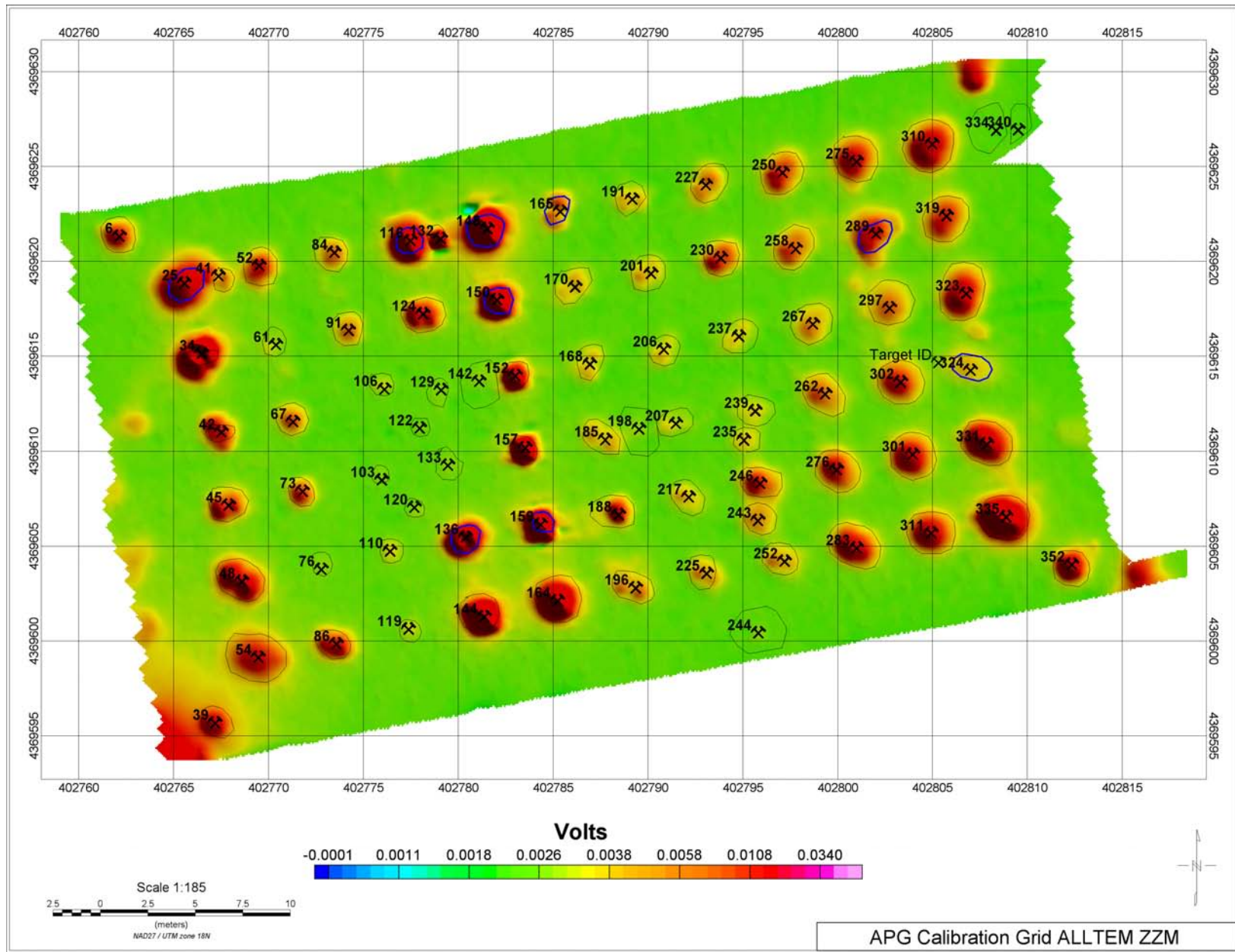

Appendix 2 – ALLTEM Data and Signal to Noise Maps

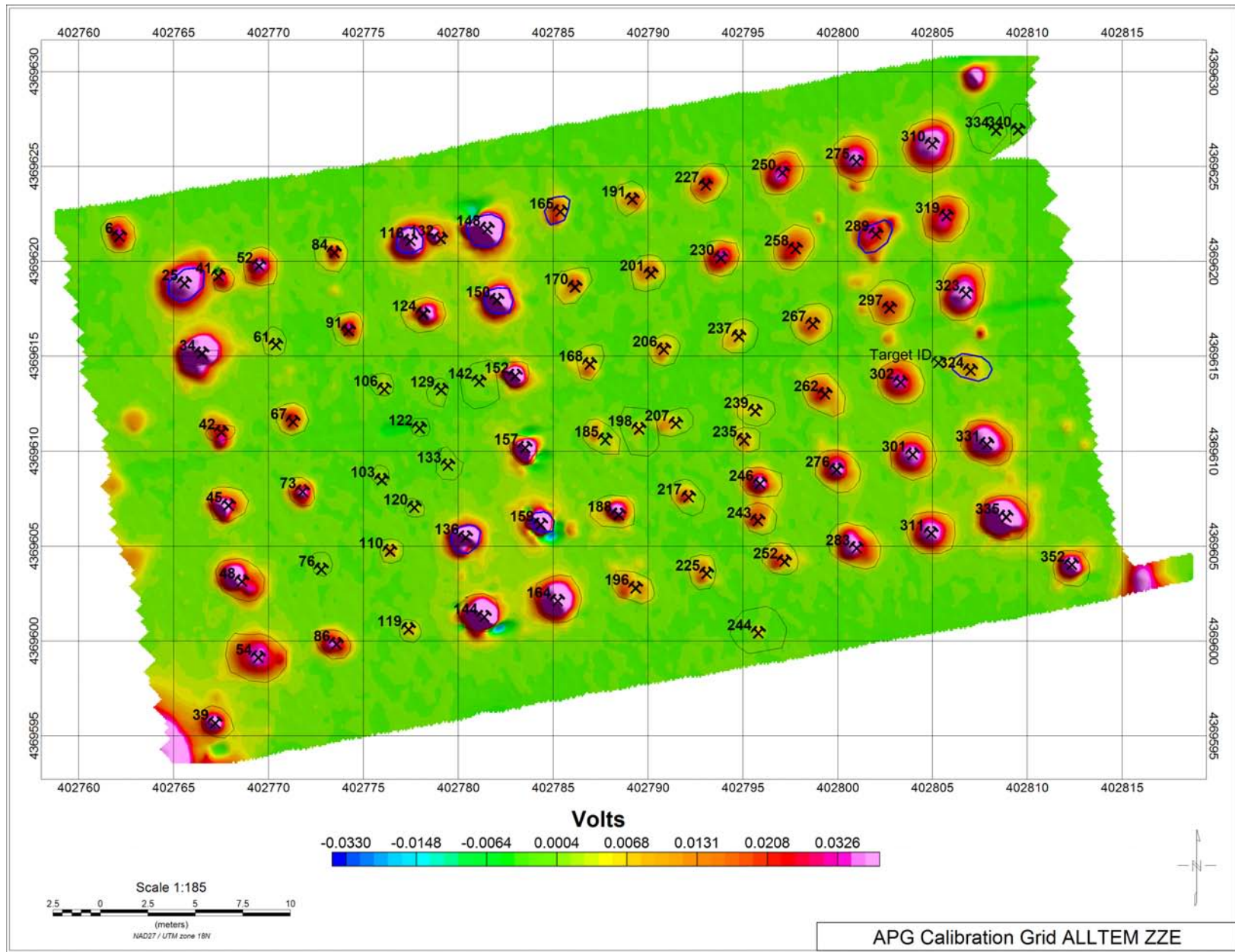

Appendix 2 – ALLTEM Data and Signal to Noise Maps

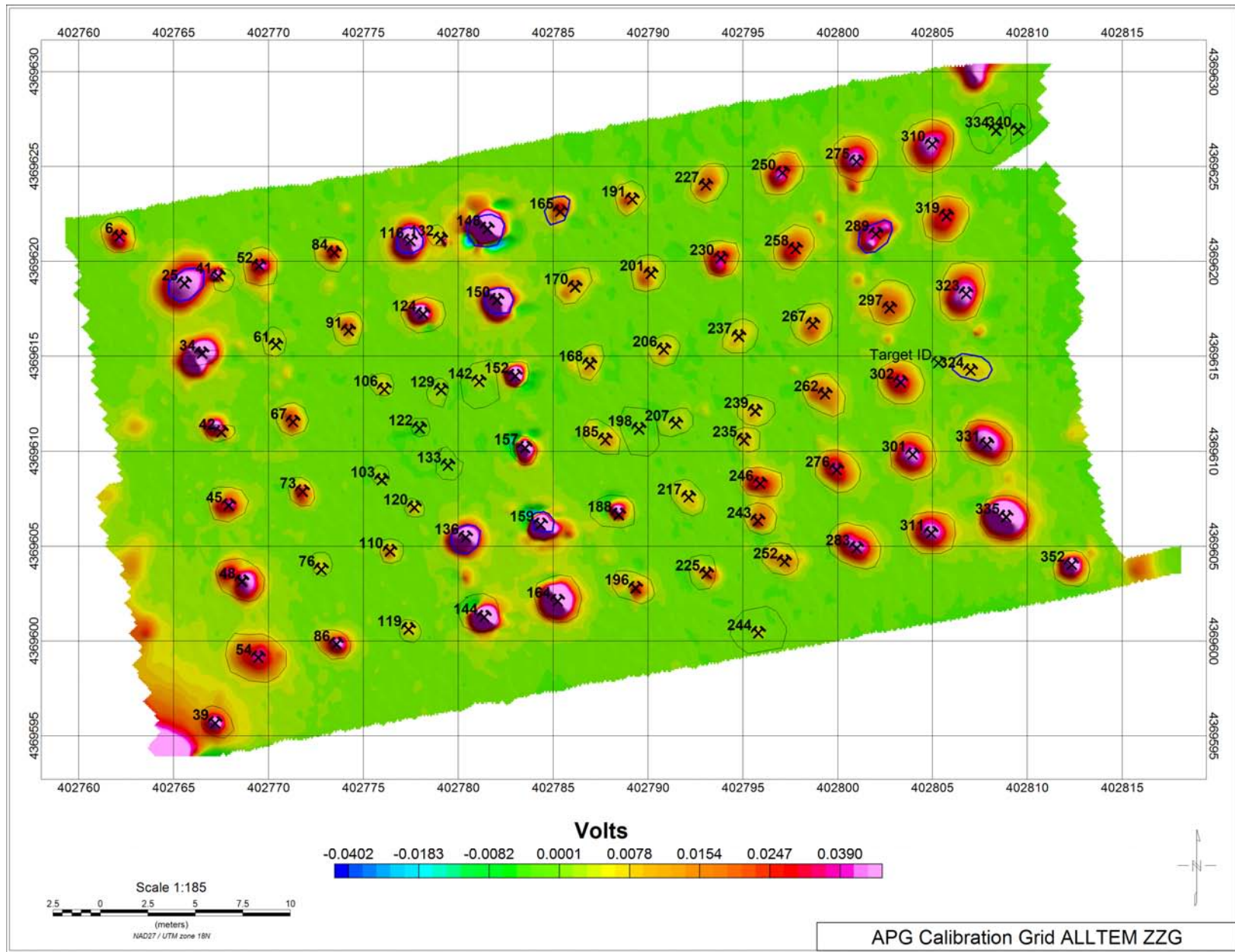

Appendix 2 – ALLTEM Data and Signal to Noise Maps

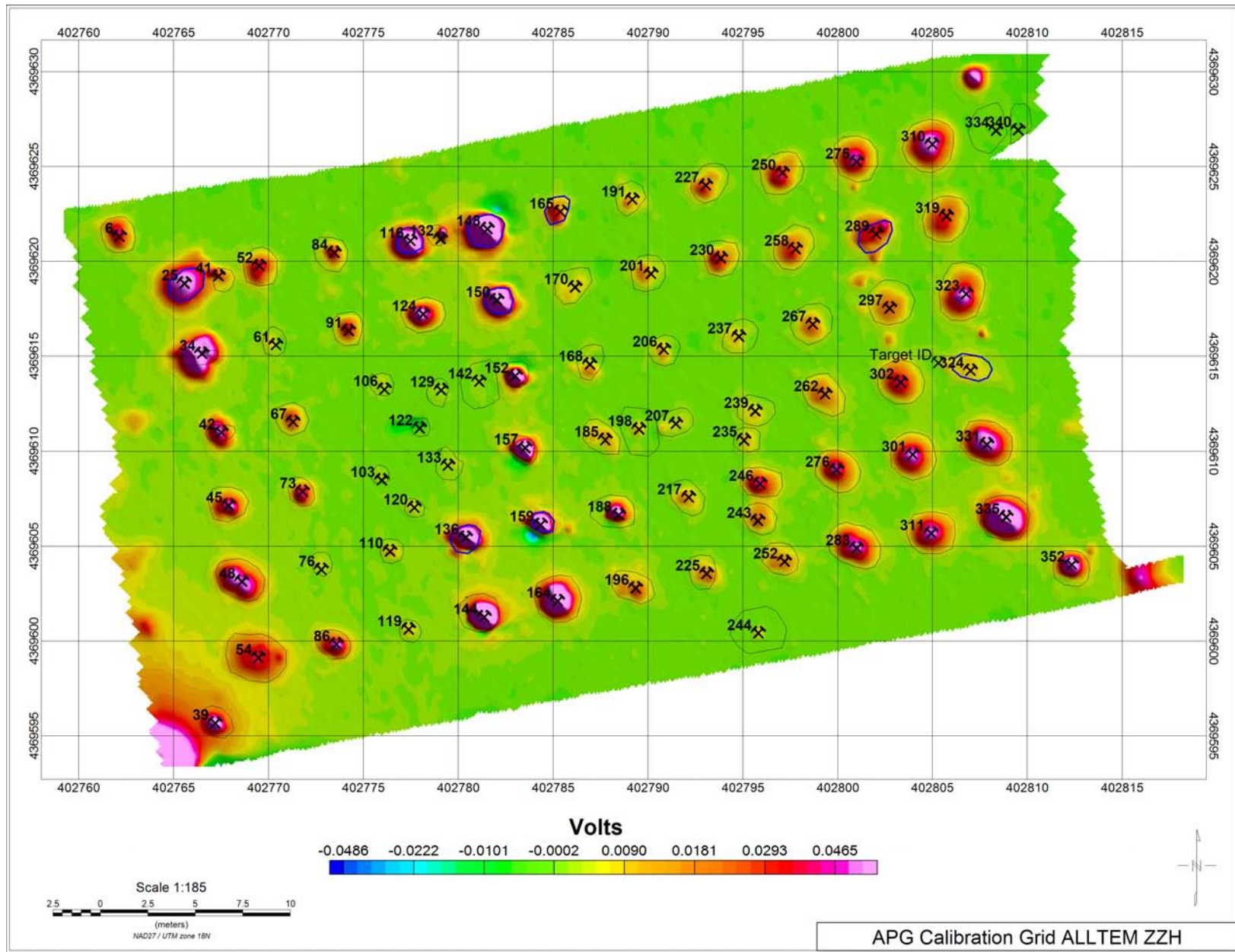

Appendix 2 – ALLTEM Data and Signal to Noise Maps

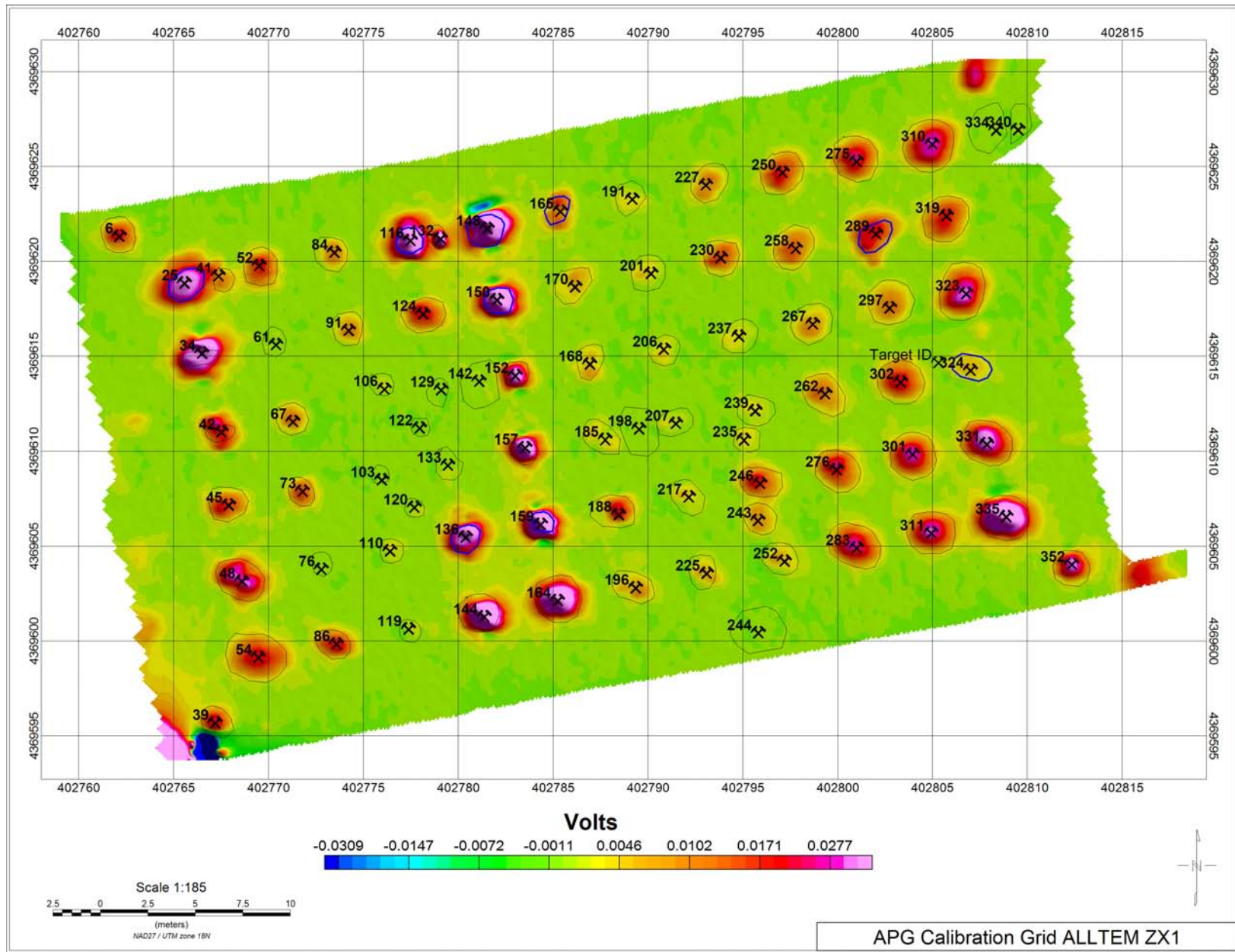

Appendix 2 – ALLTEM Data and Signal to Noise Maps

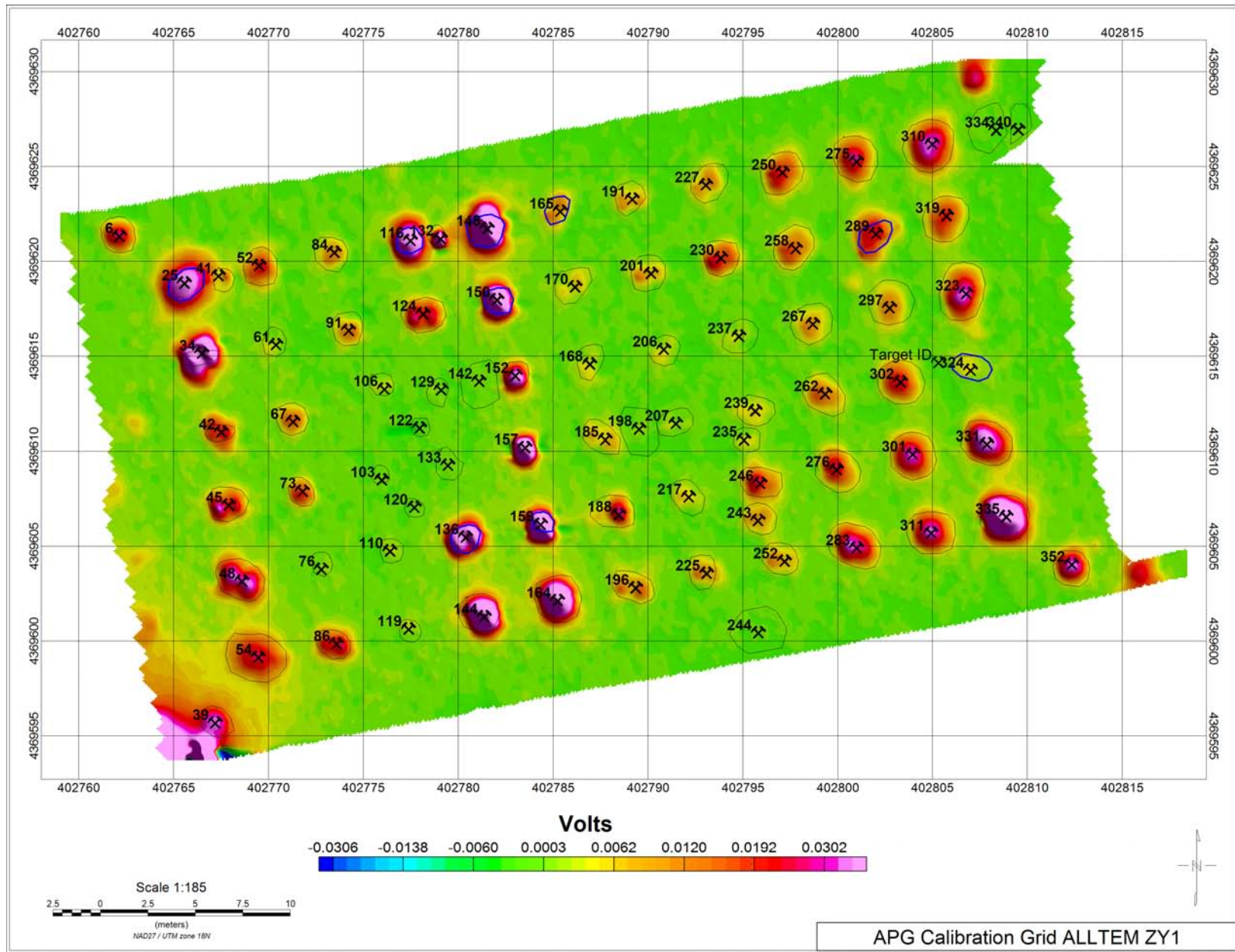

Appendix 2 – ALLTEM Data and Signal to Noise Maps

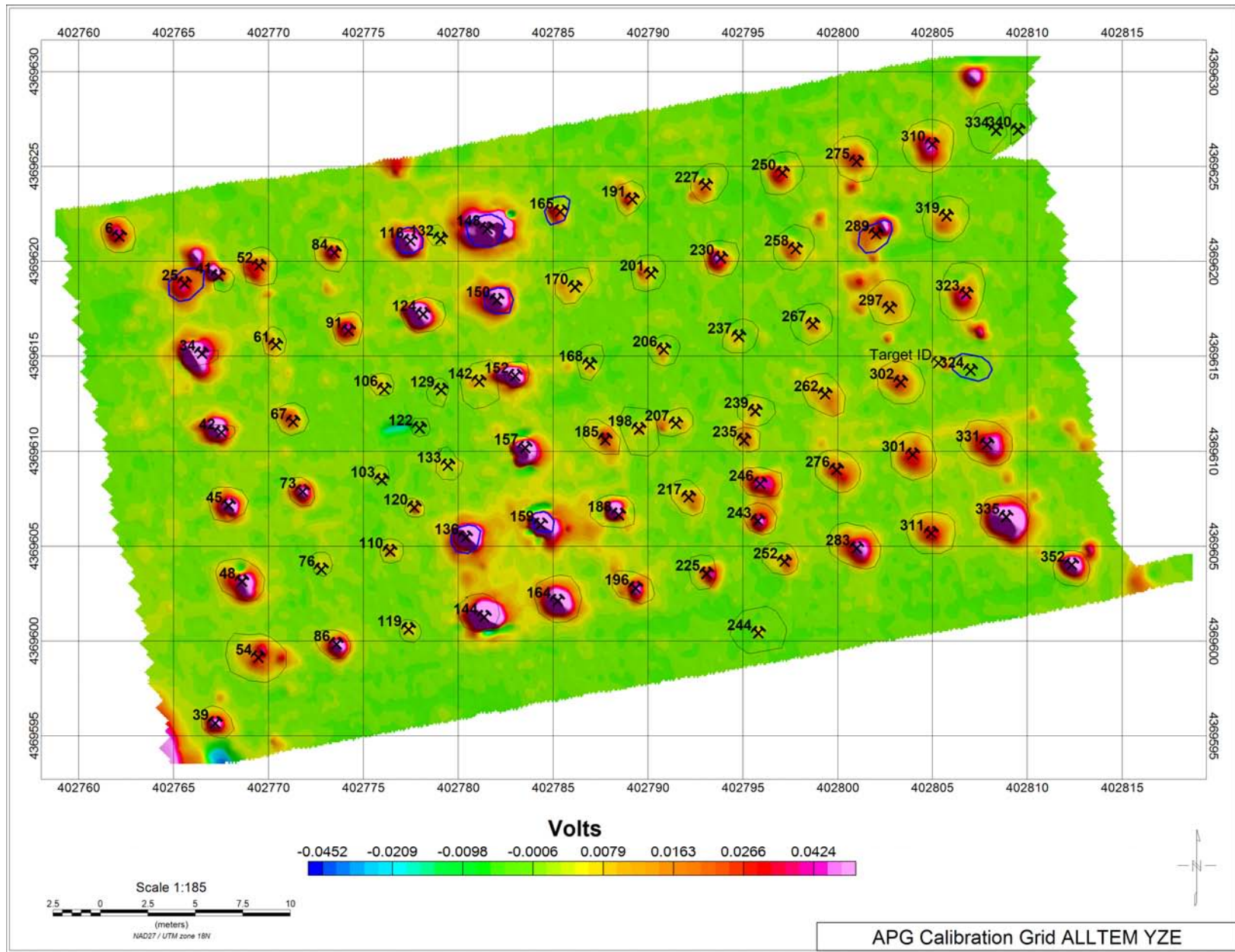

Appendix 2 – ALLTEM Data and Signal to Noise Maps

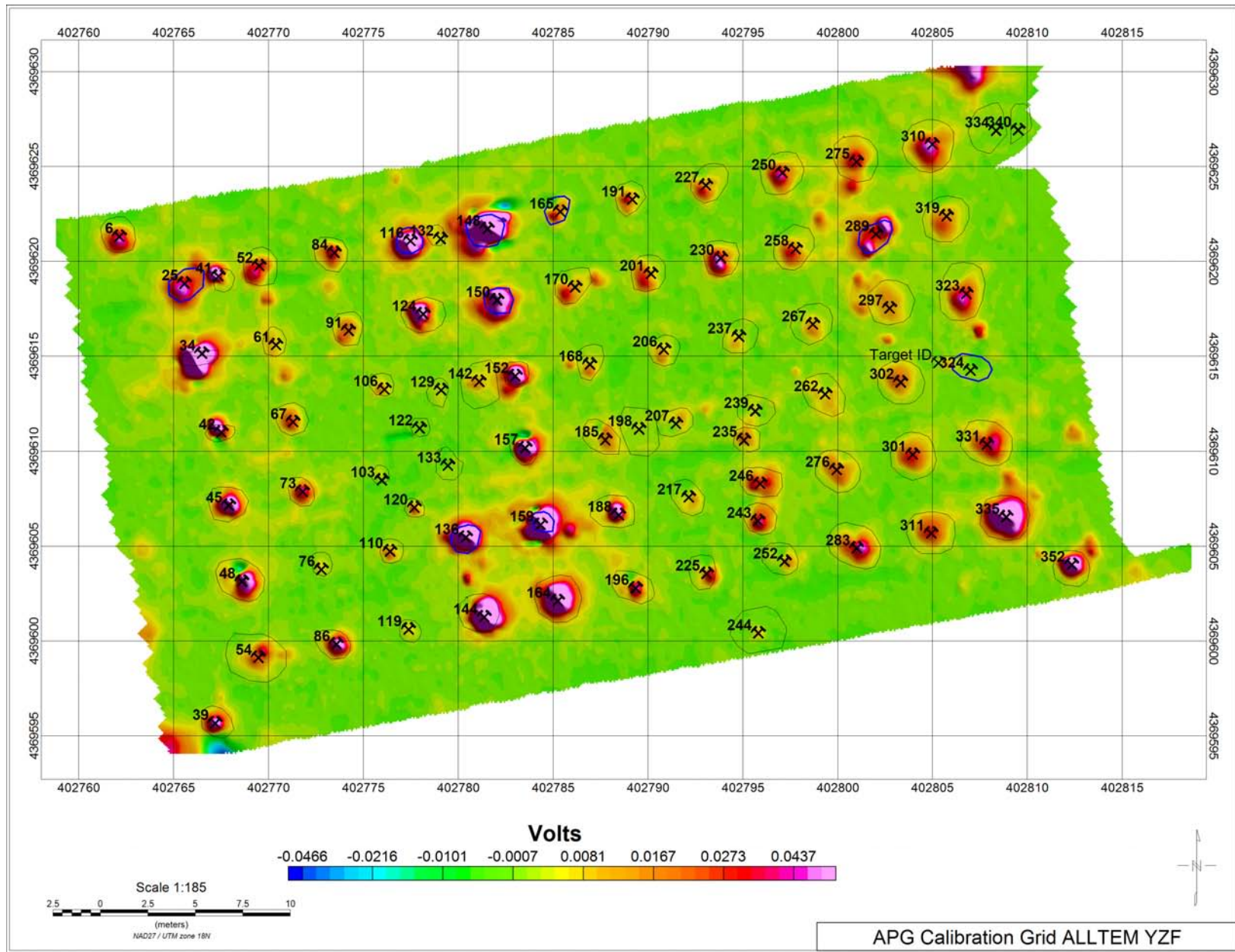

Appendix 2 – ALLTEM Data and Signal to Noise Maps

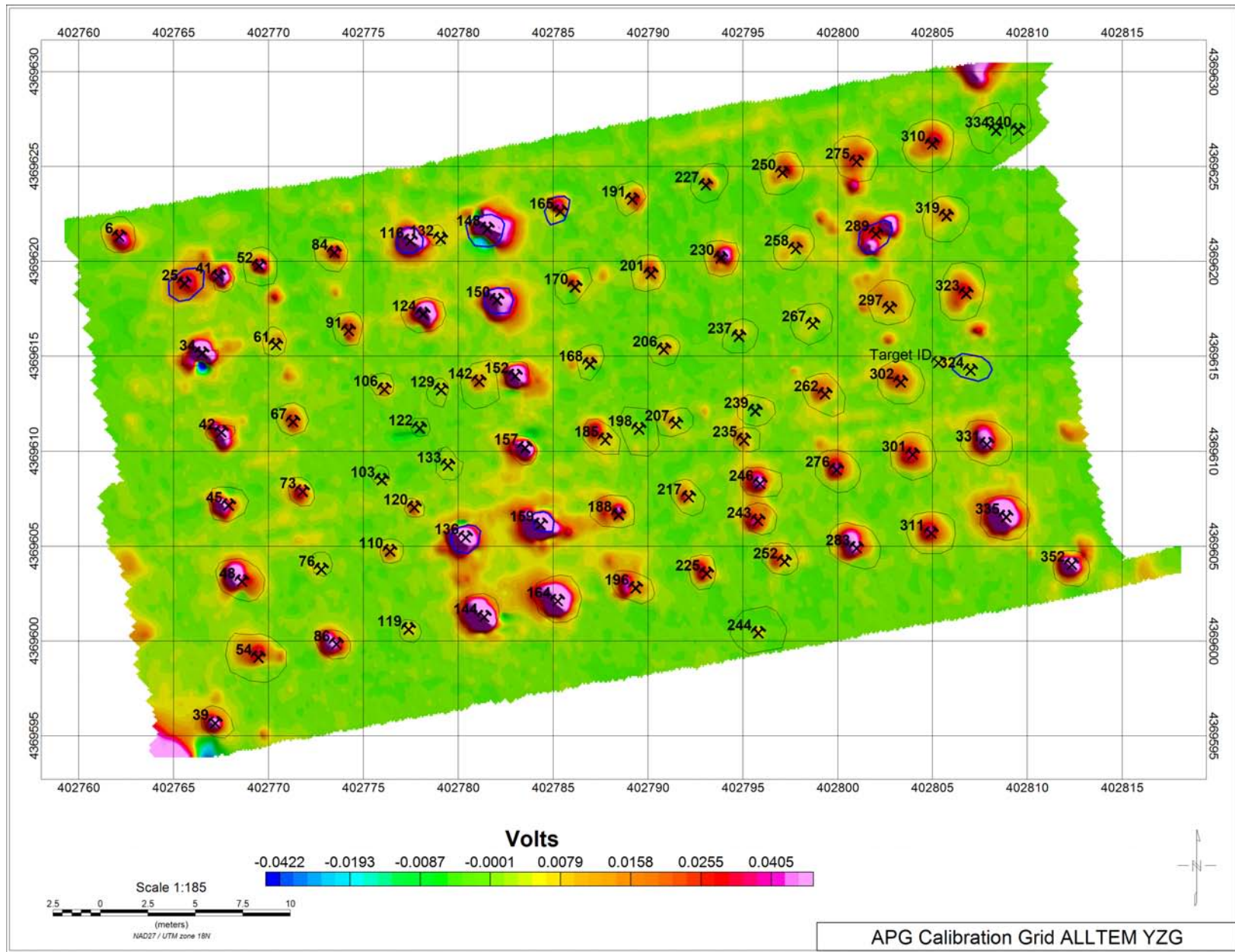

Appendix 2 – ALLTEM Data and Signal to Noise Maps

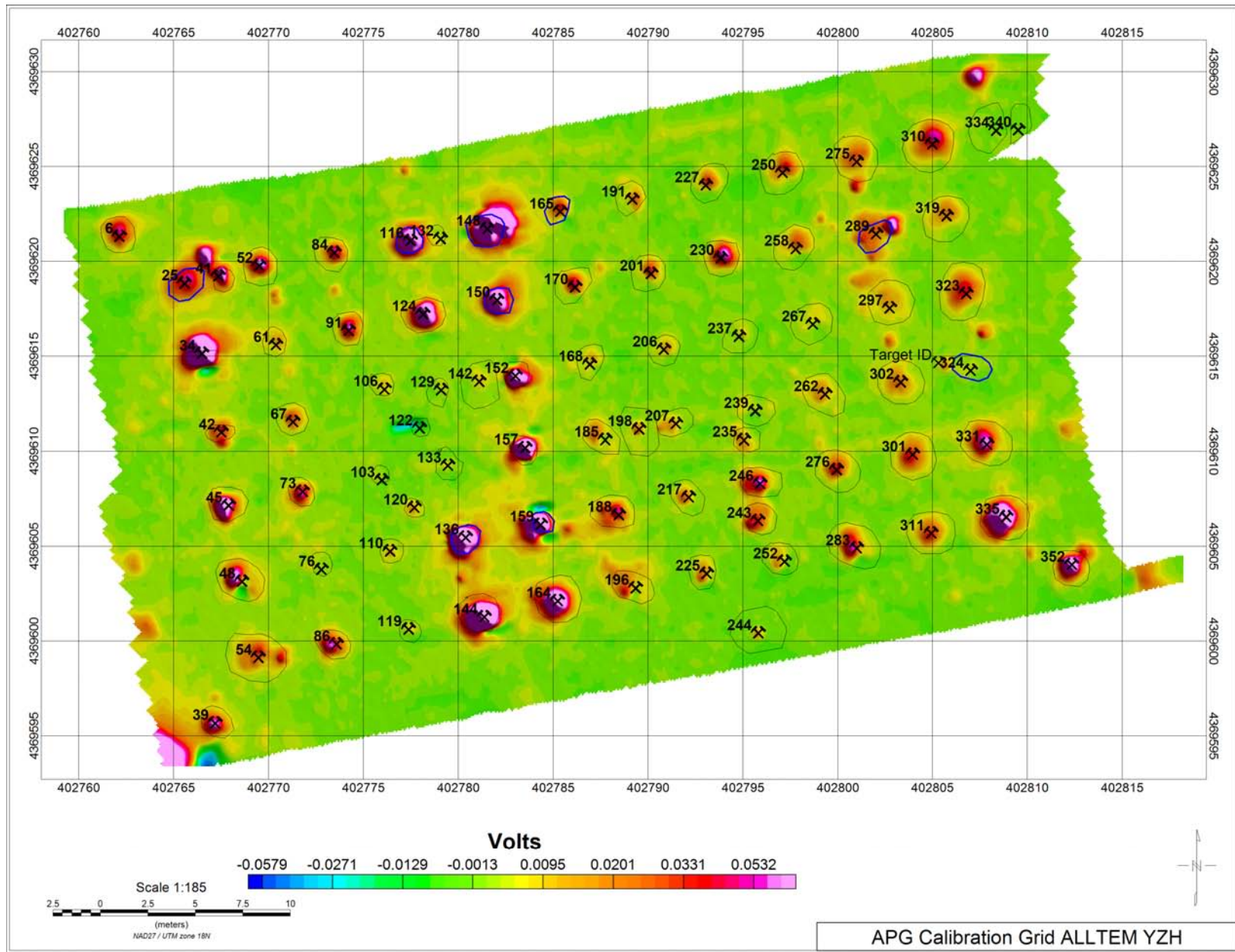

Appendix 2 – ALLTEM Data and Signal to Noise Maps

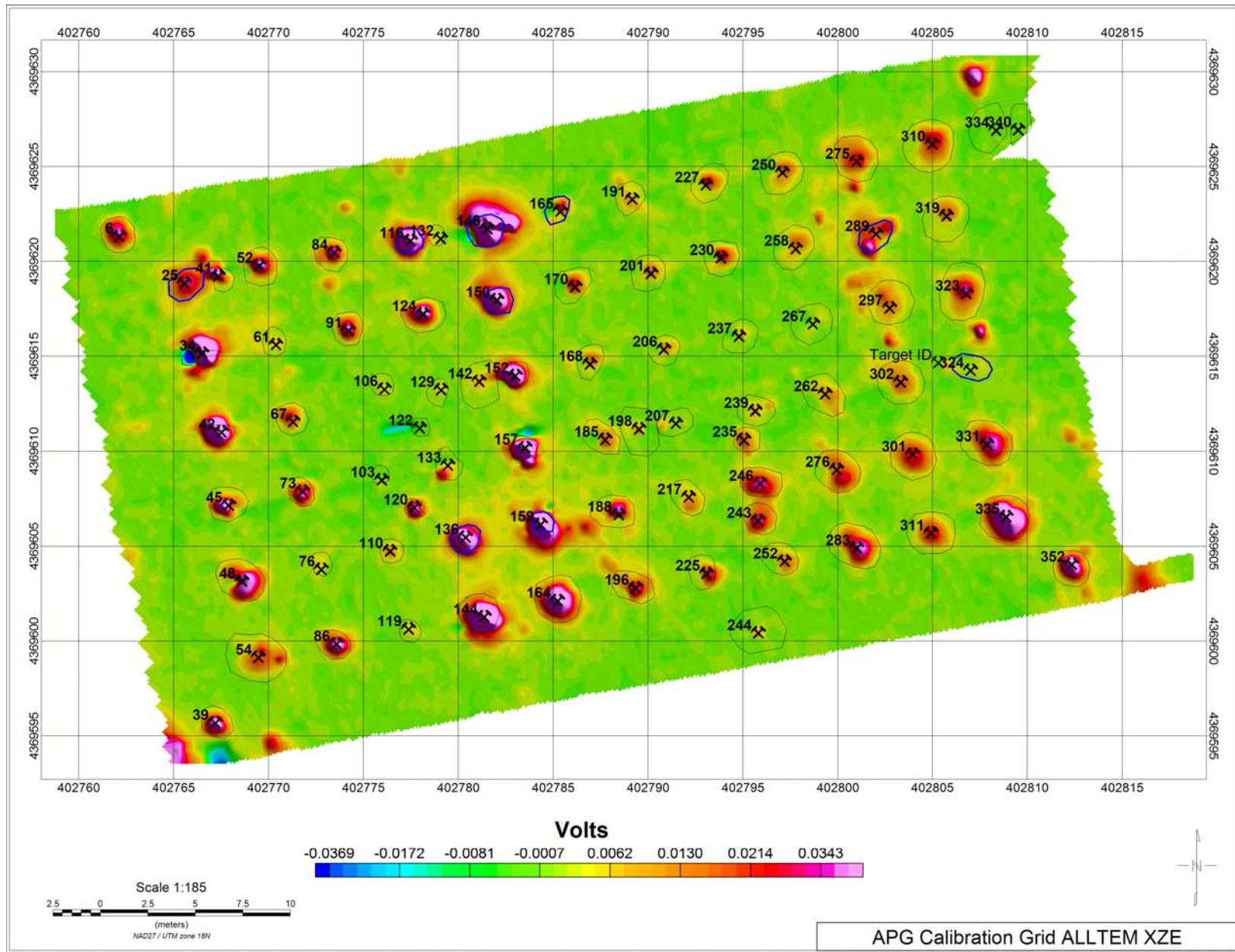

Appendix 2 – ALLTEM Data and Signal to Noise Maps

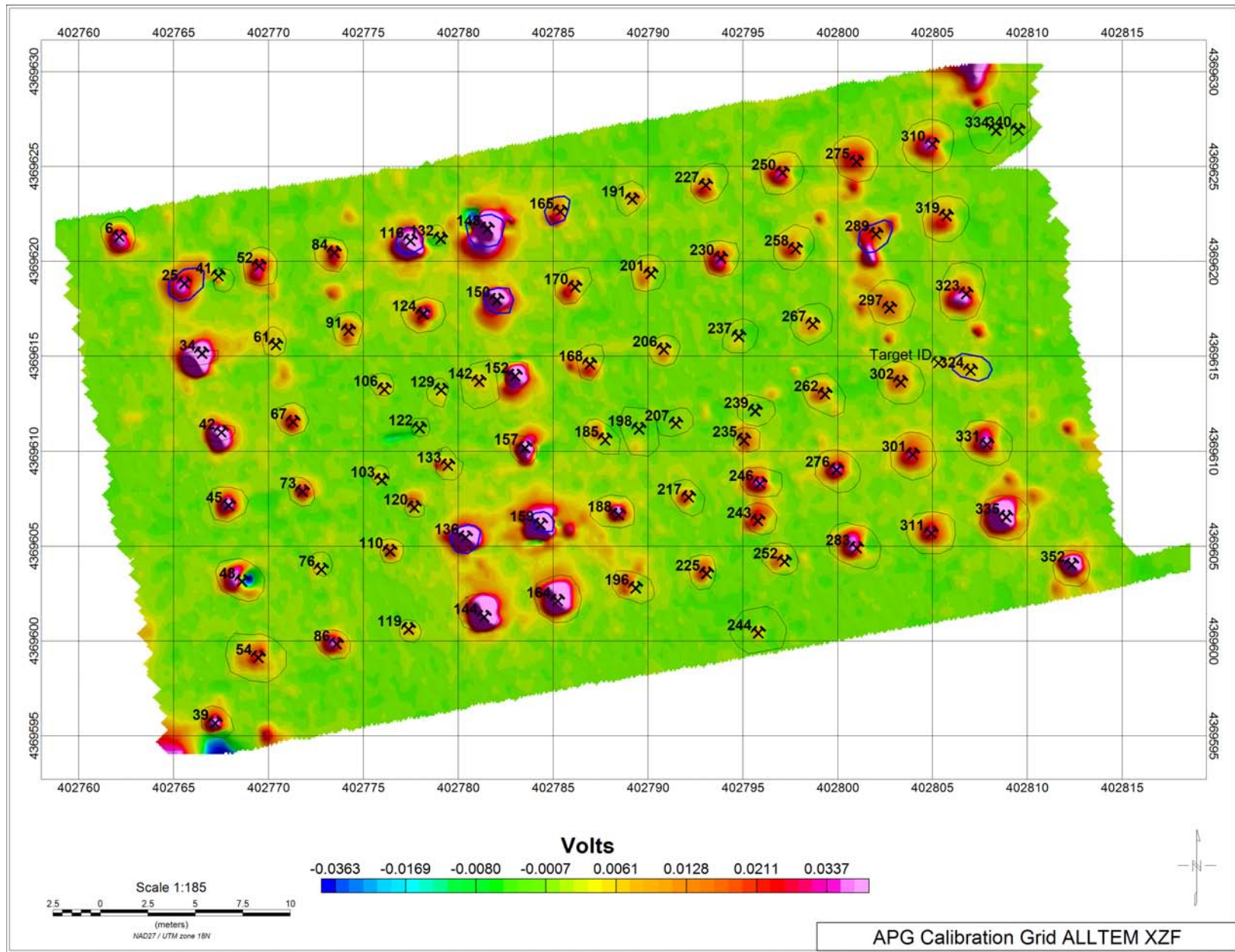

Appendix 2 – ALLTEM Data and Signal to Noise Maps

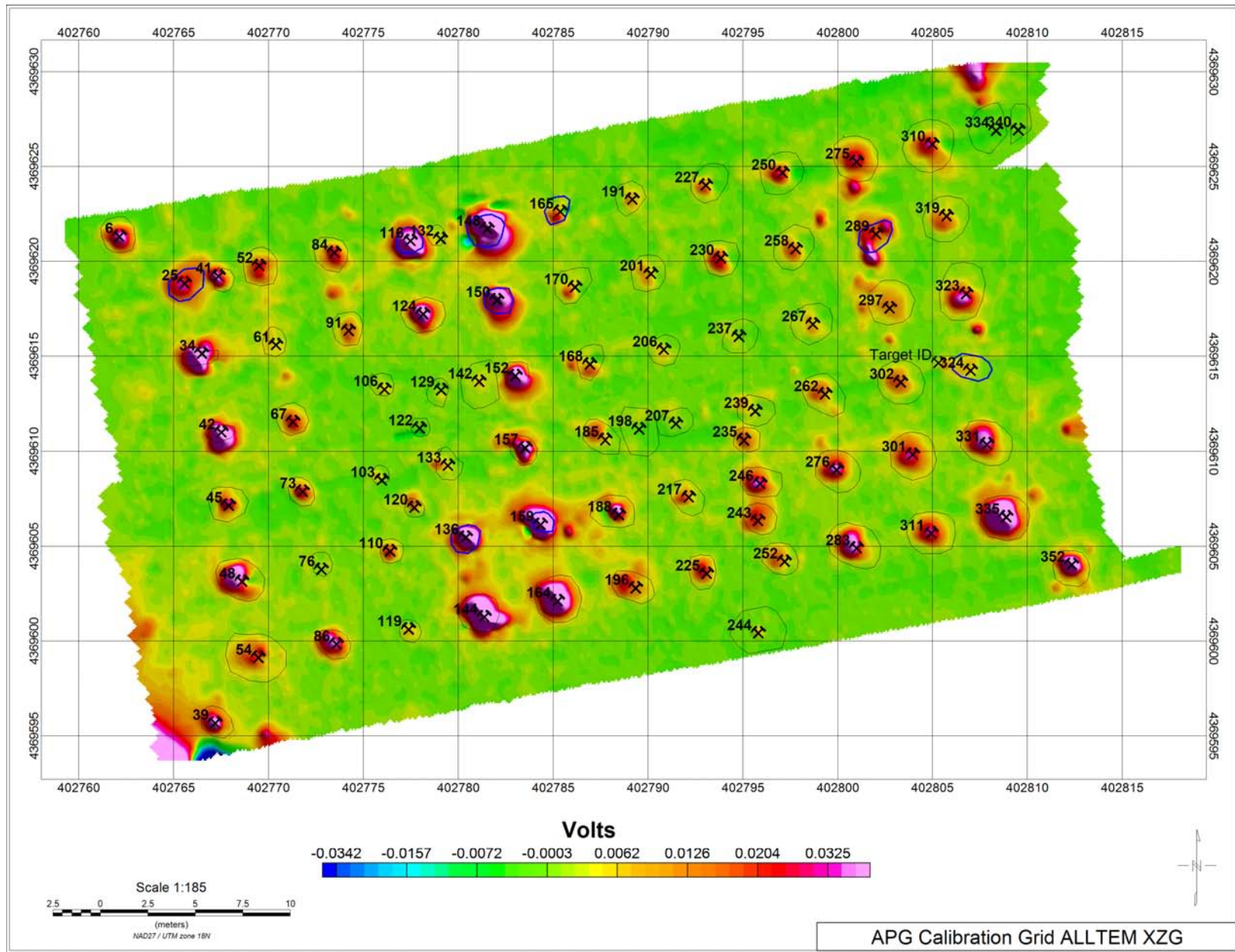

Appendix 2 – ALLTEM Data and Signal to Noise Maps

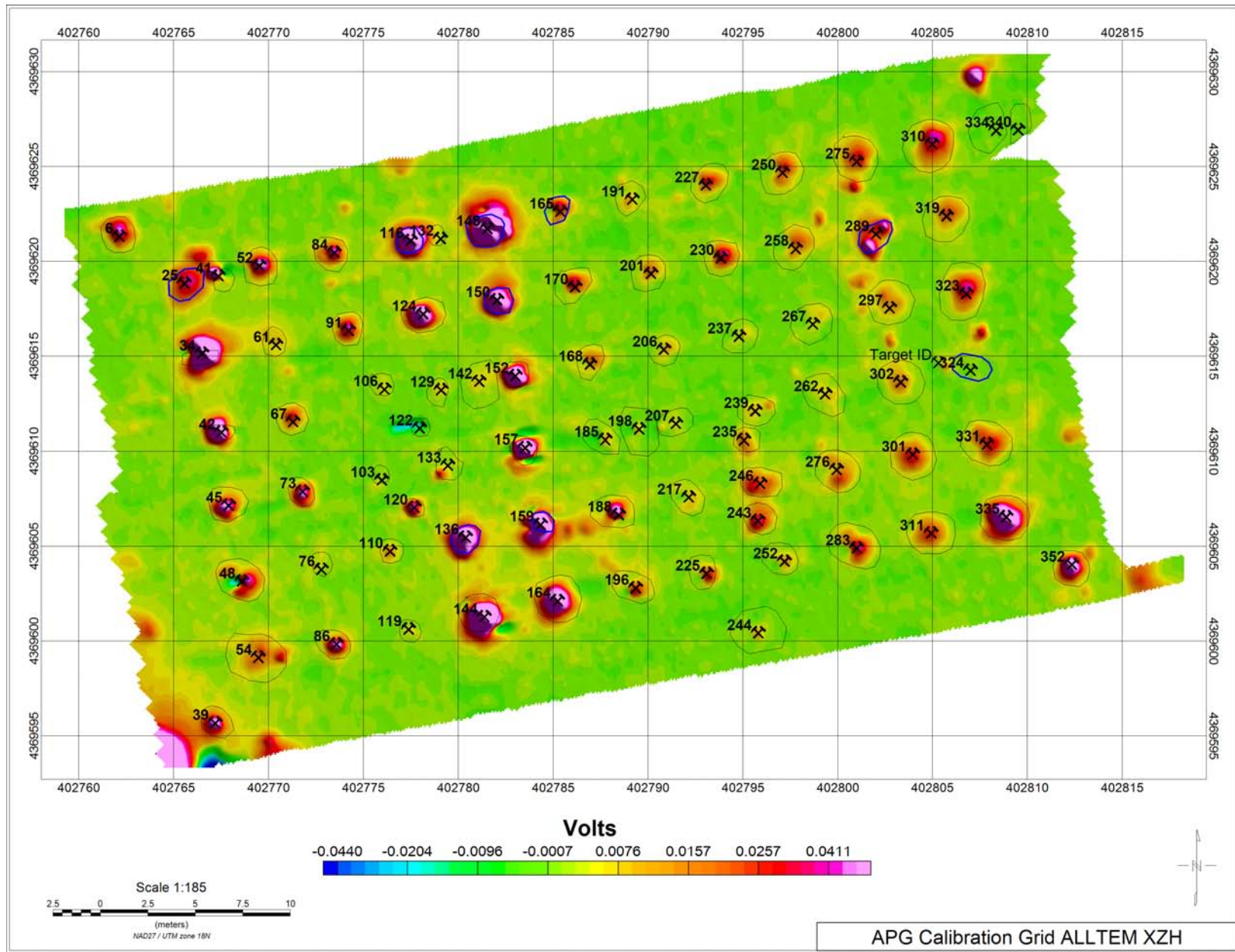

Appendix 2 – ALLTEM Data and Signal to Noise Maps

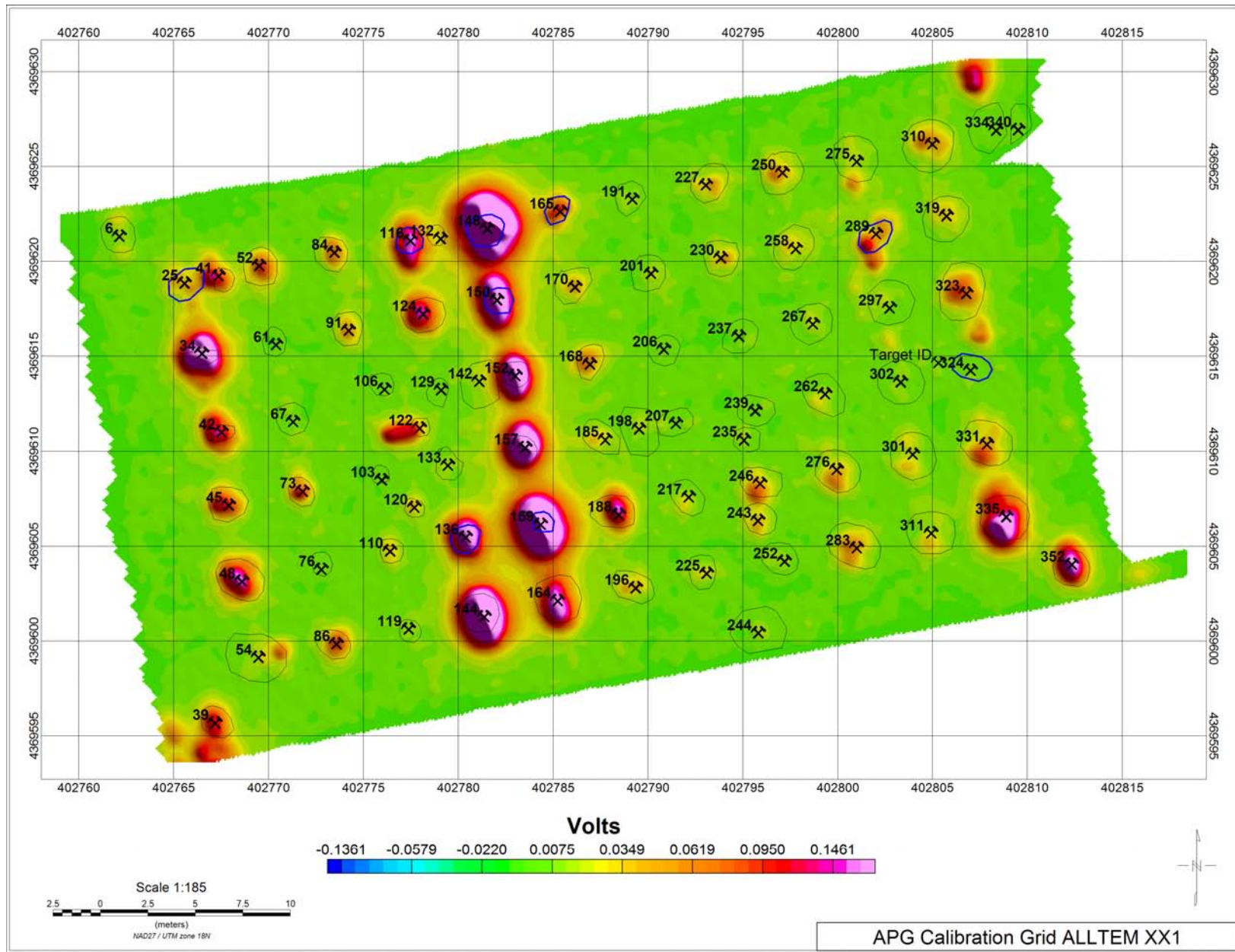

Appendix 2 – ALLTEM Data and Signal to Noise Maps

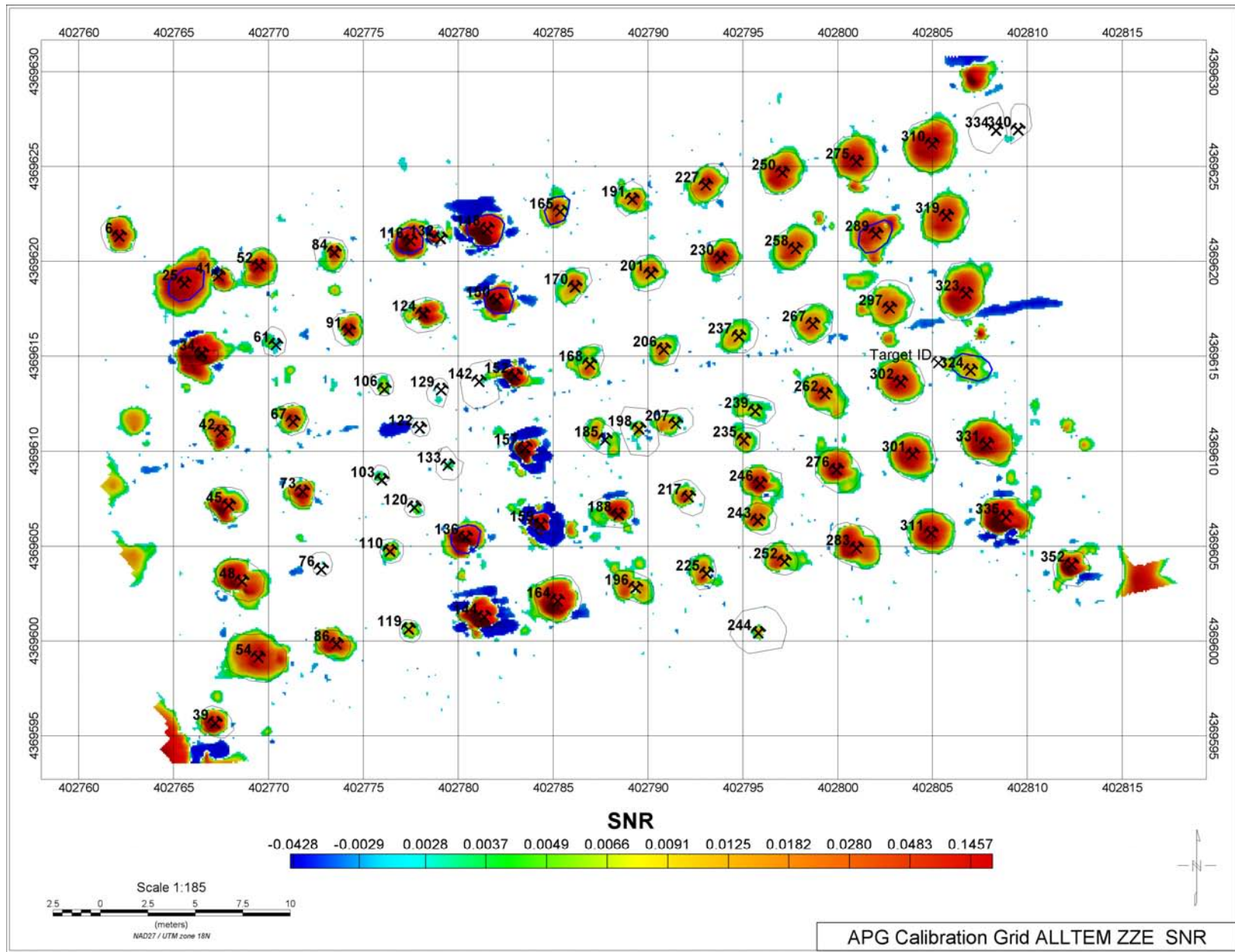

Appendix 2 – ALLTEM Data and Signal to Noise Maps

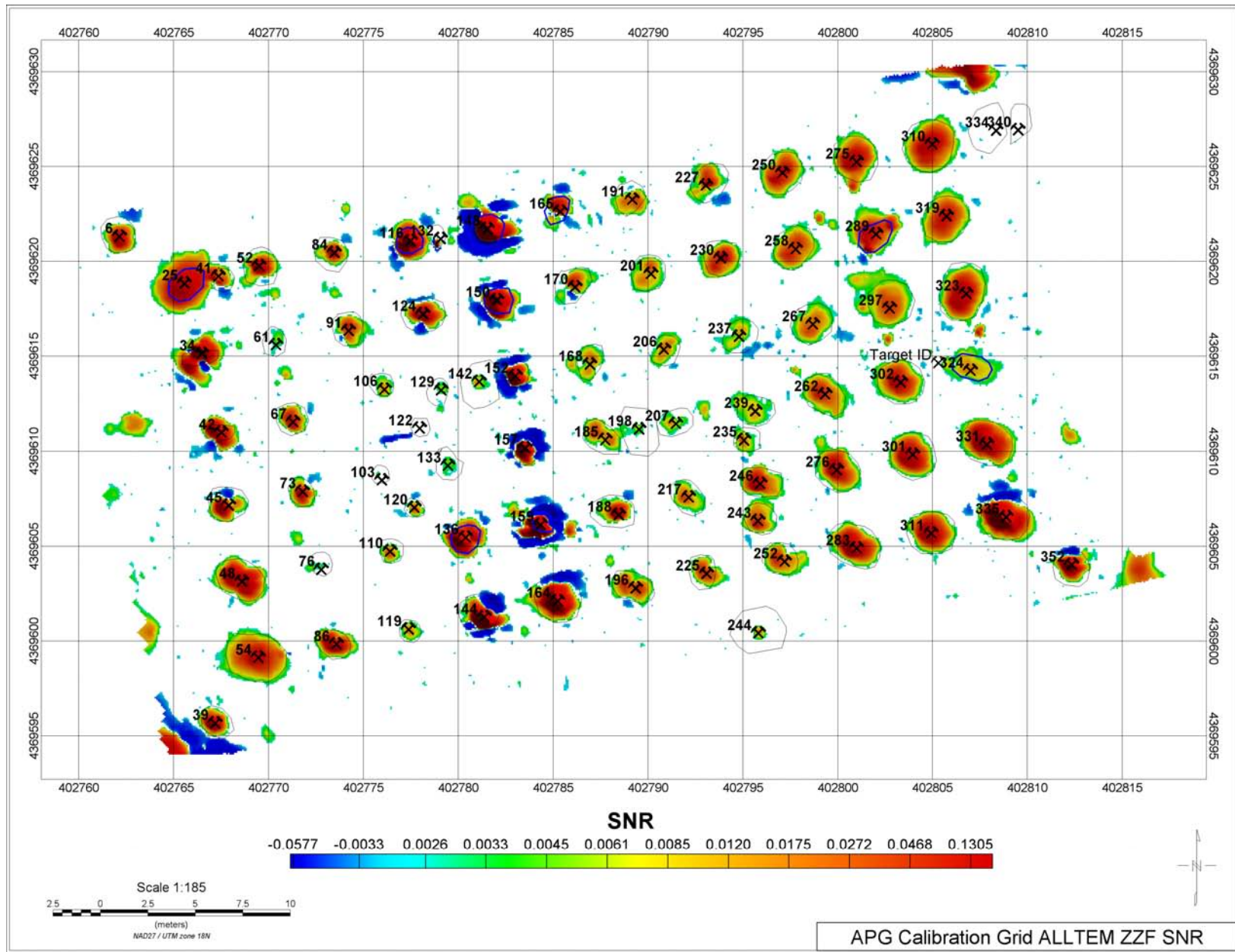

Appendix 2 – ALLTEM Data and Signal to Noise Maps

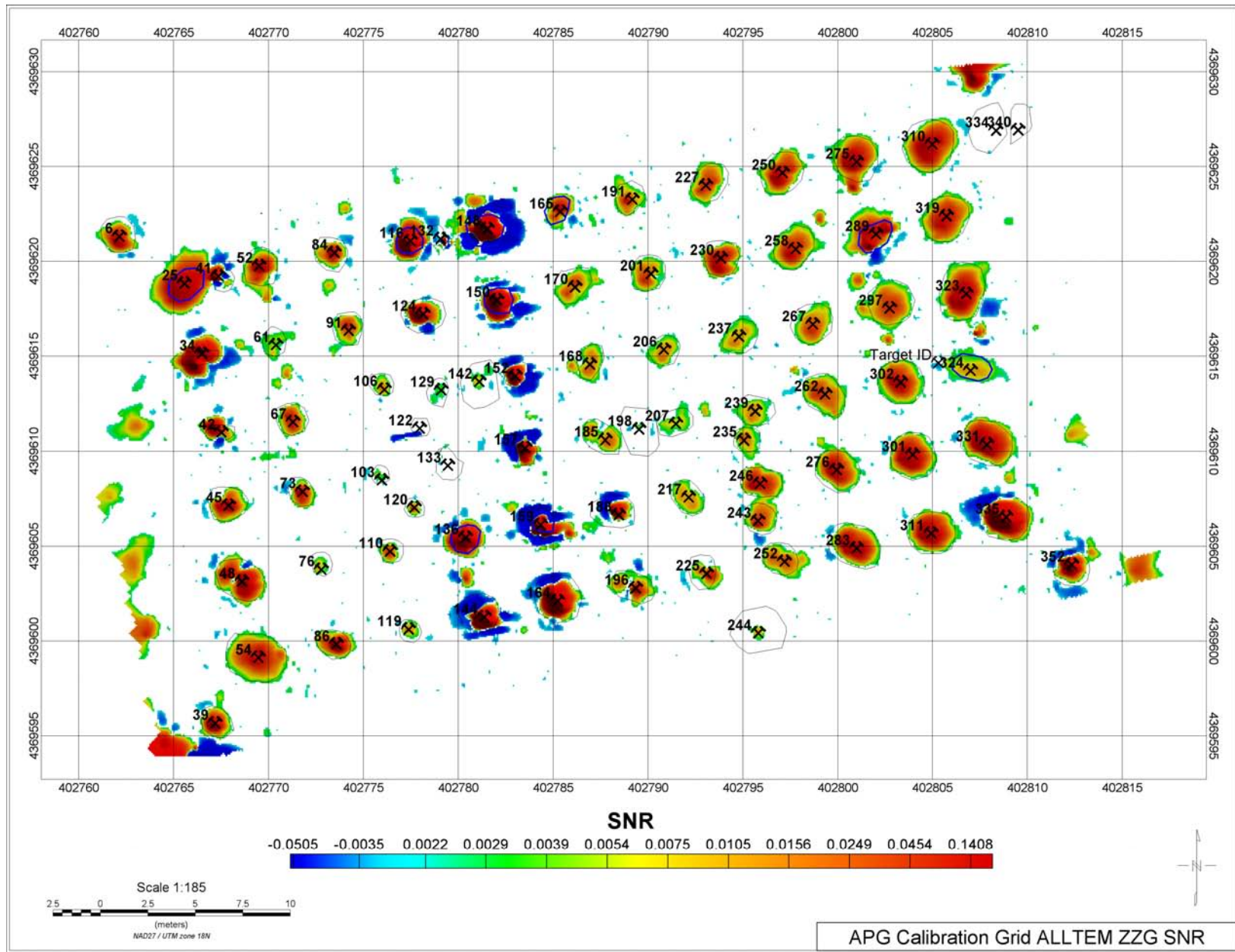

Appendix 2 – ALLTEM Data and Signal to Noise Maps

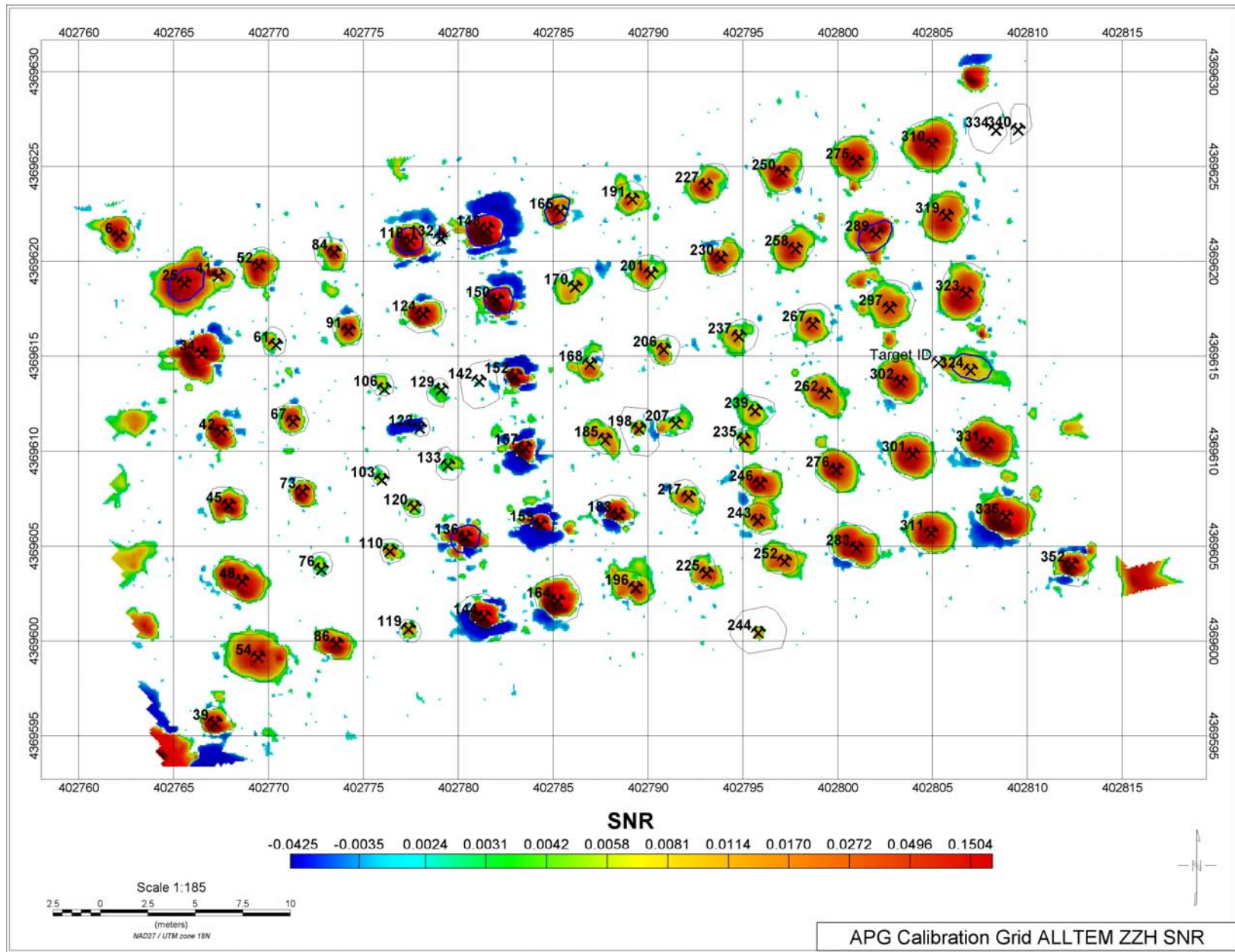

Appendix 2 – ALLTEM Data and Signal to Noise Maps

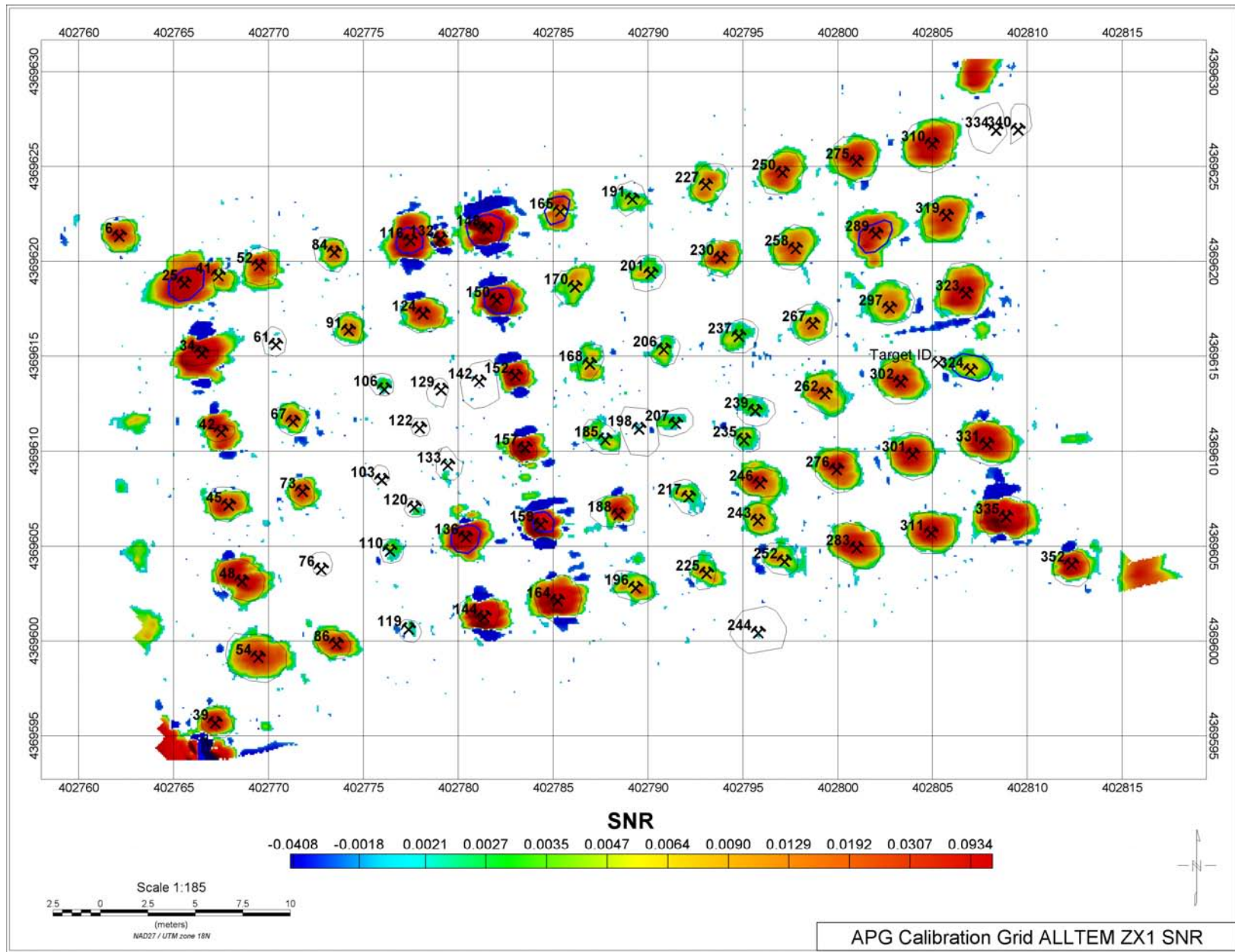

Appendix 2 – ALLTEM Data and Signal to Noise Maps

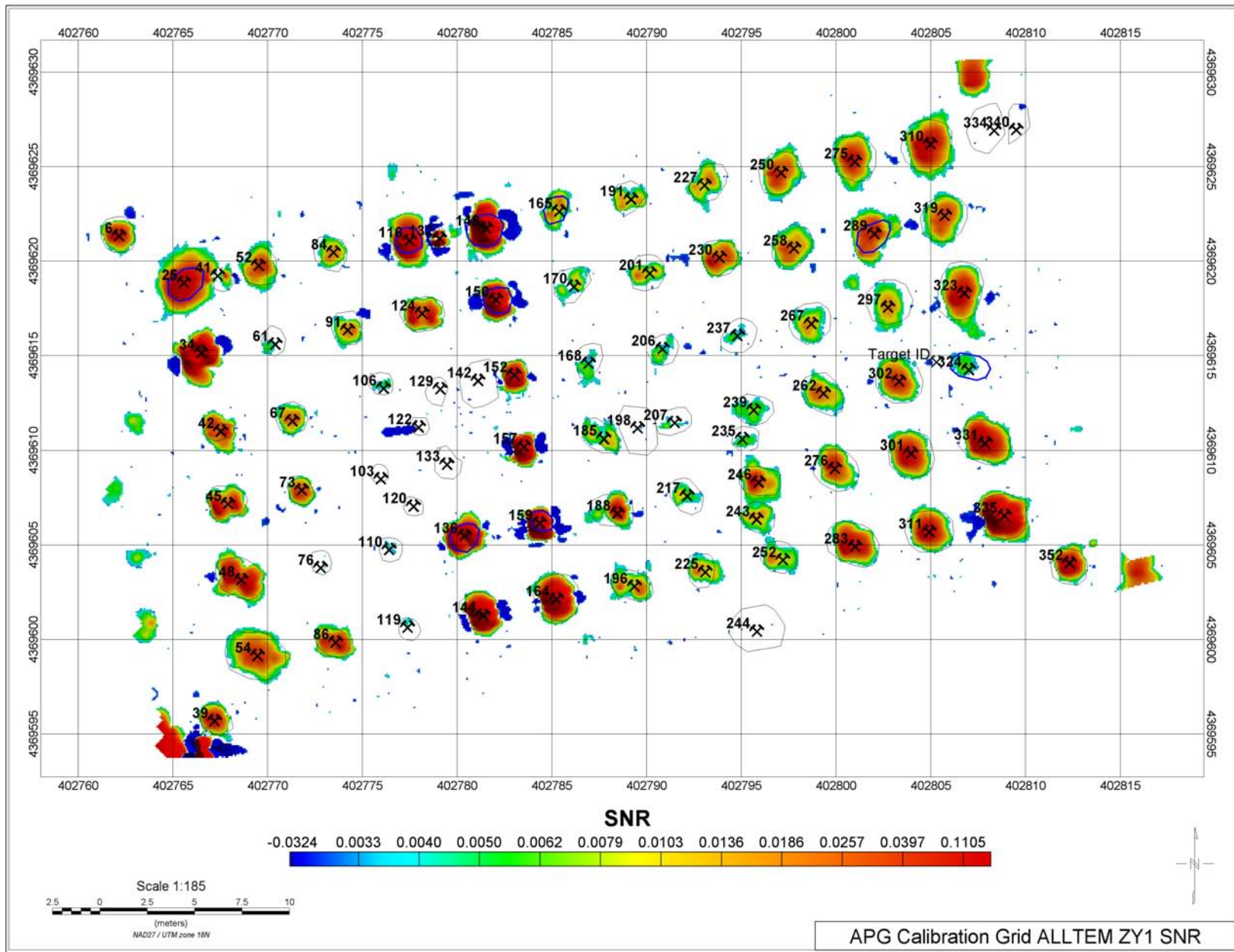

Appendix 2 – ALLTEM Data and Signal to Noise Maps

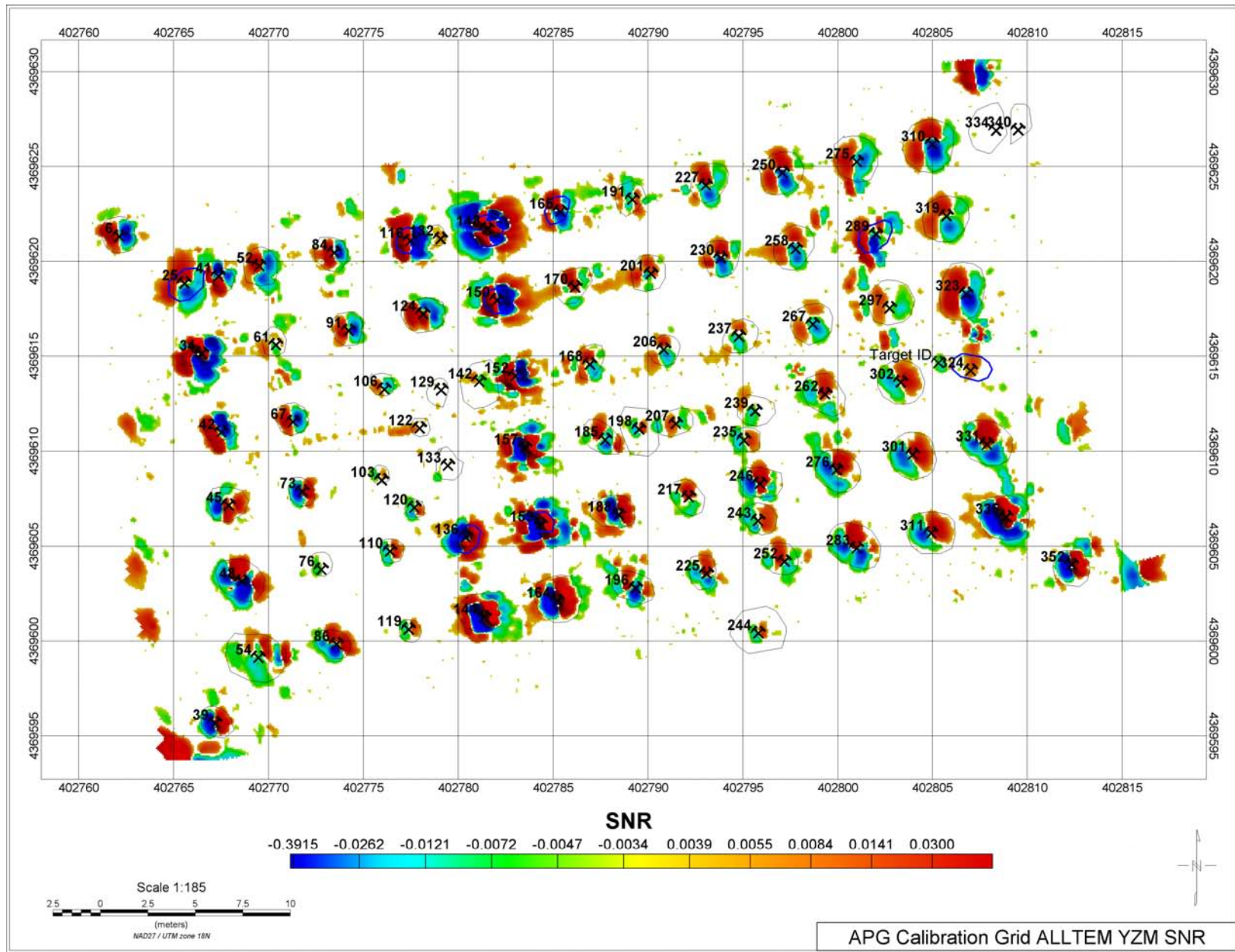

Appendix 2 – ALLTEM Data and Signal to Noise Maps

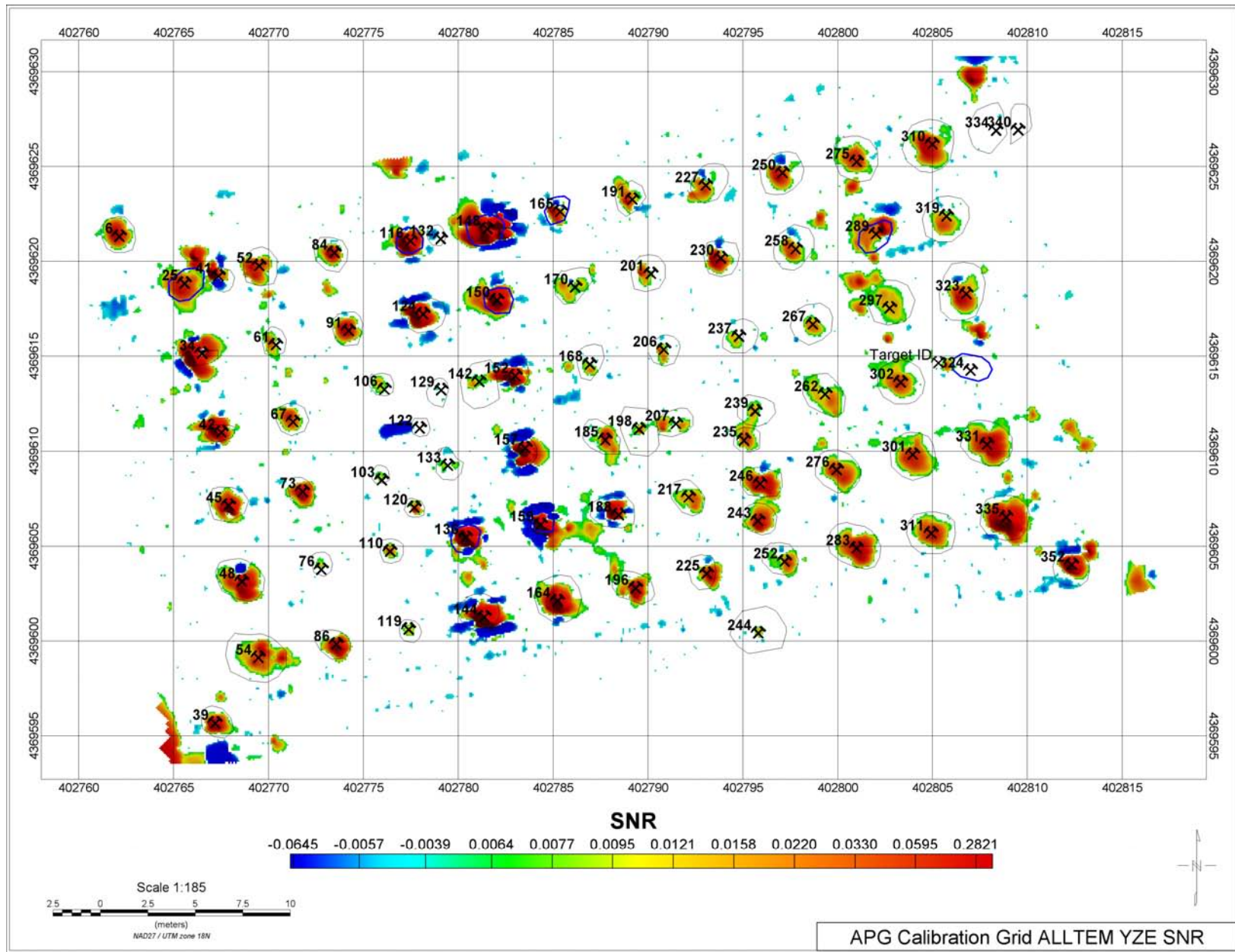

Appendix 2 – ALLTEM Data and Signal to Noise Maps

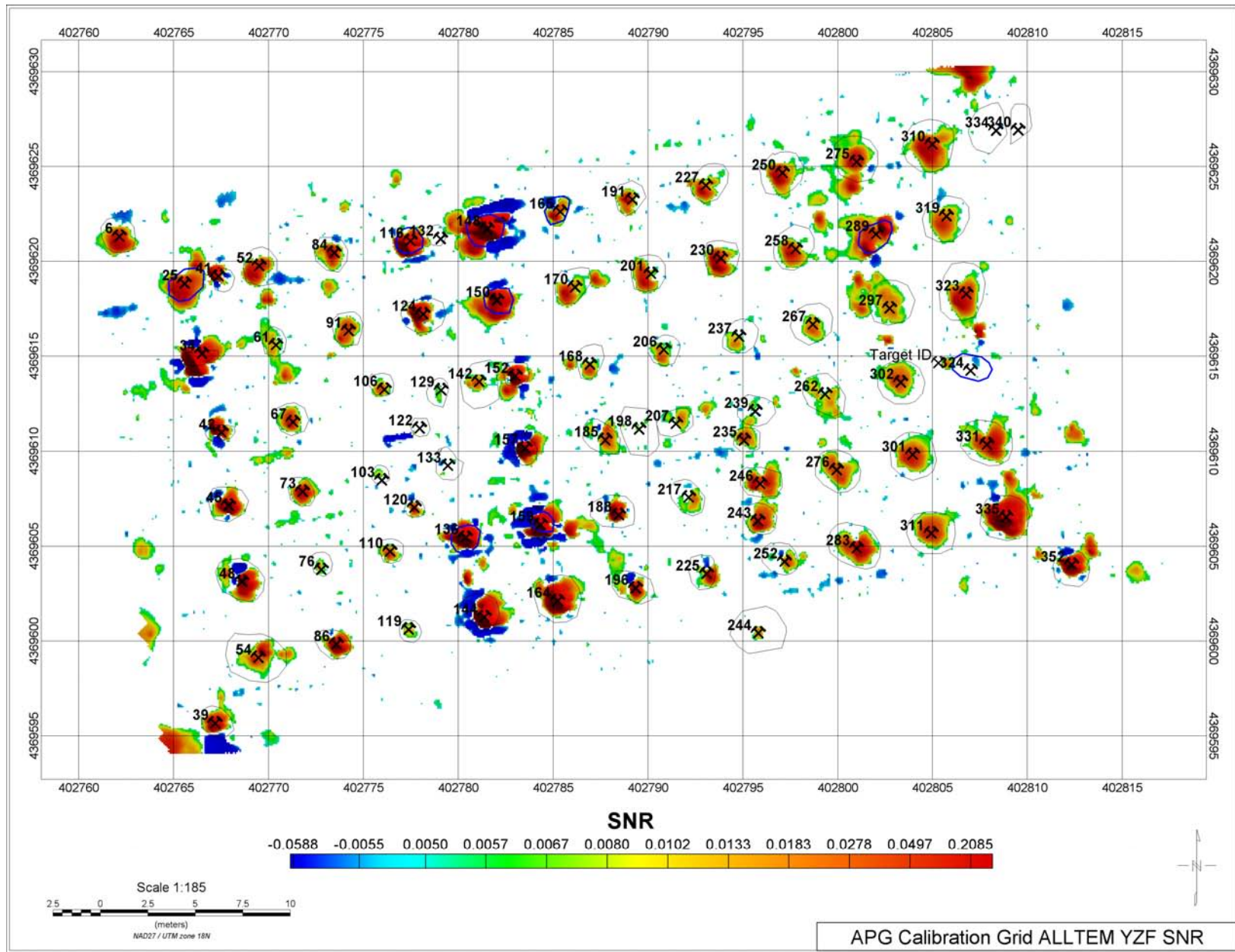

Appendix 2 – ALLTEM Data and Signal to Noise Maps

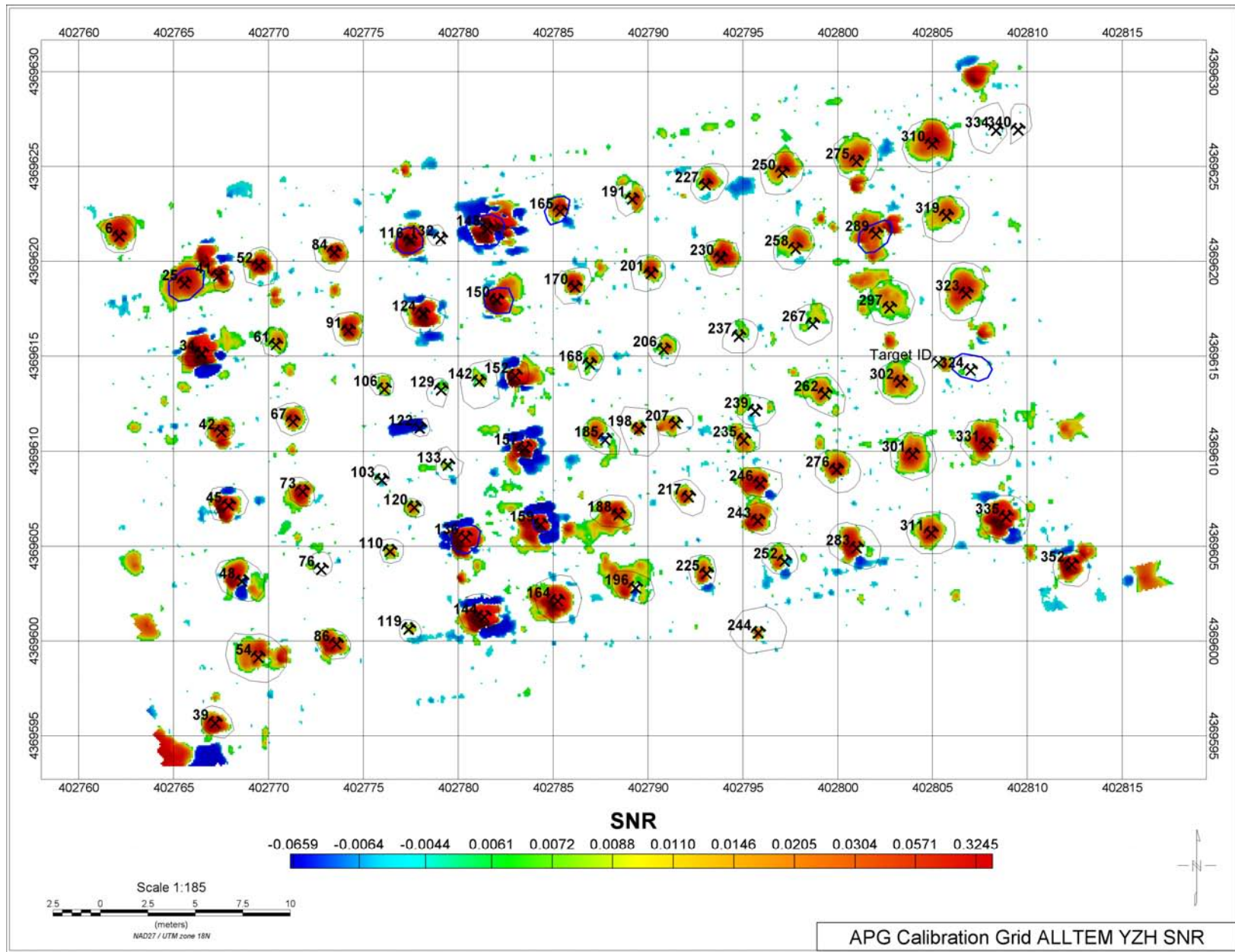

Appendix 2 – ALLTEM Data and Signal to Noise Maps

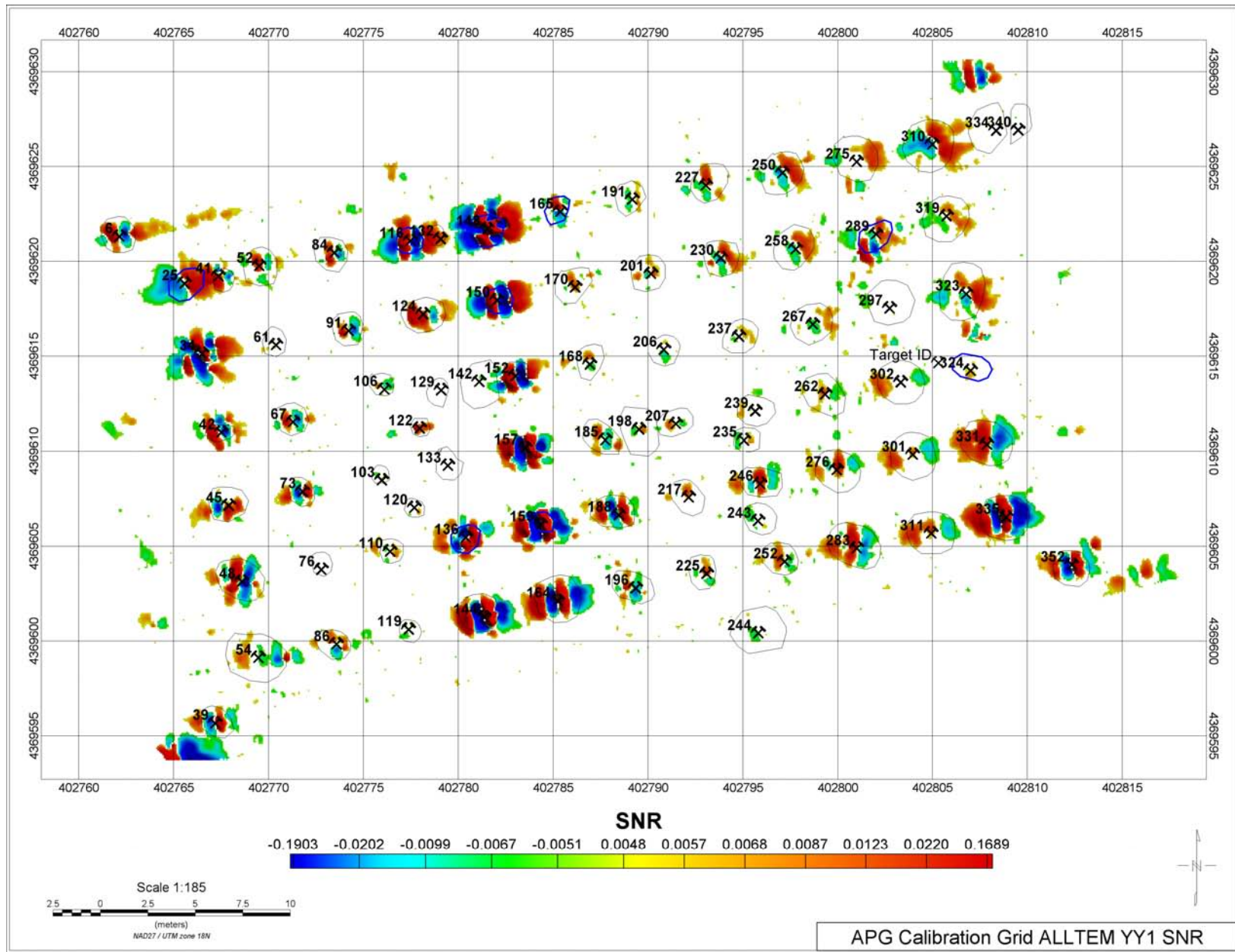

Appendix 2 – ALLTEM Data and Signal to Noise Maps

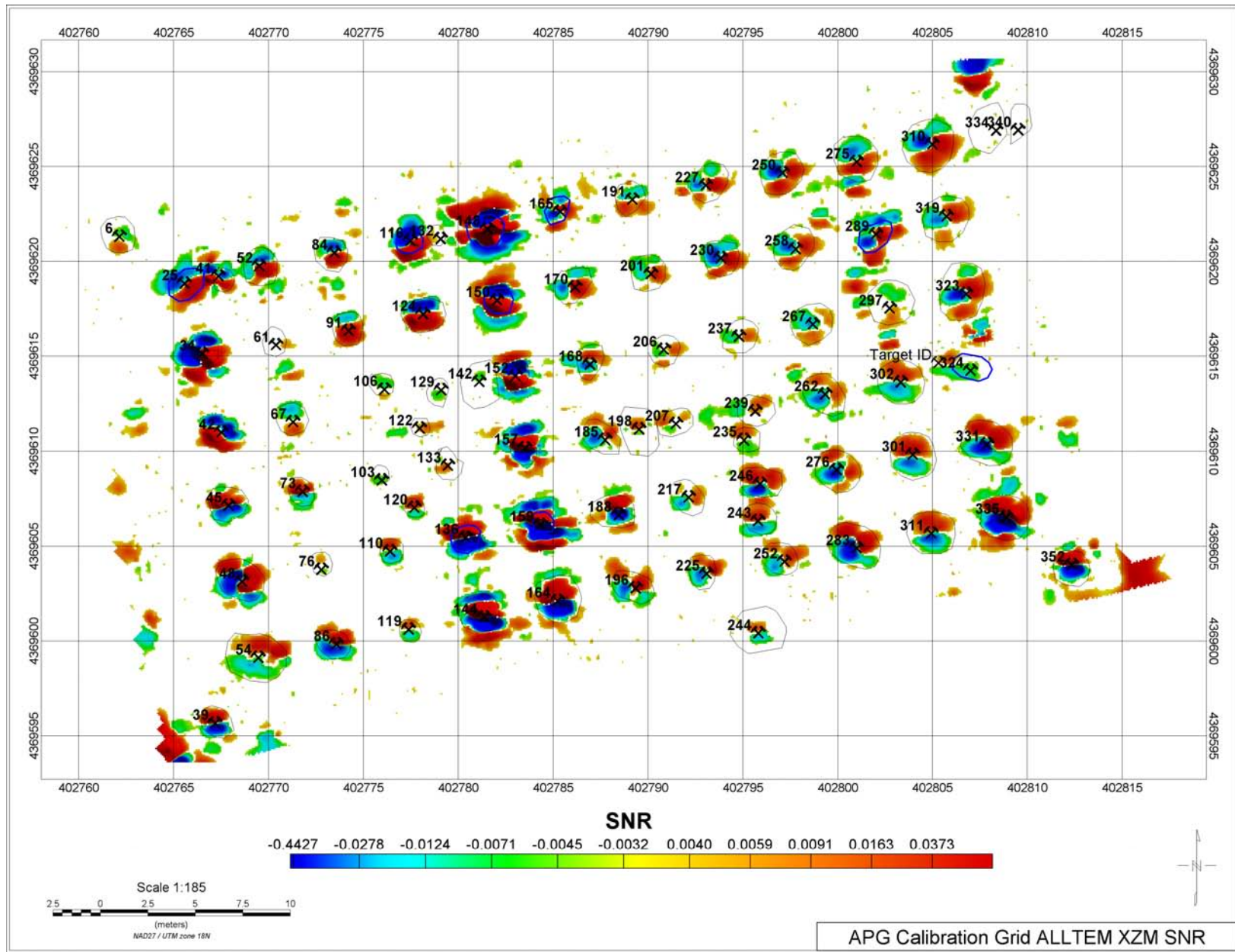

Appendix 2 – ALLTEM Data and Signal to Noise Maps

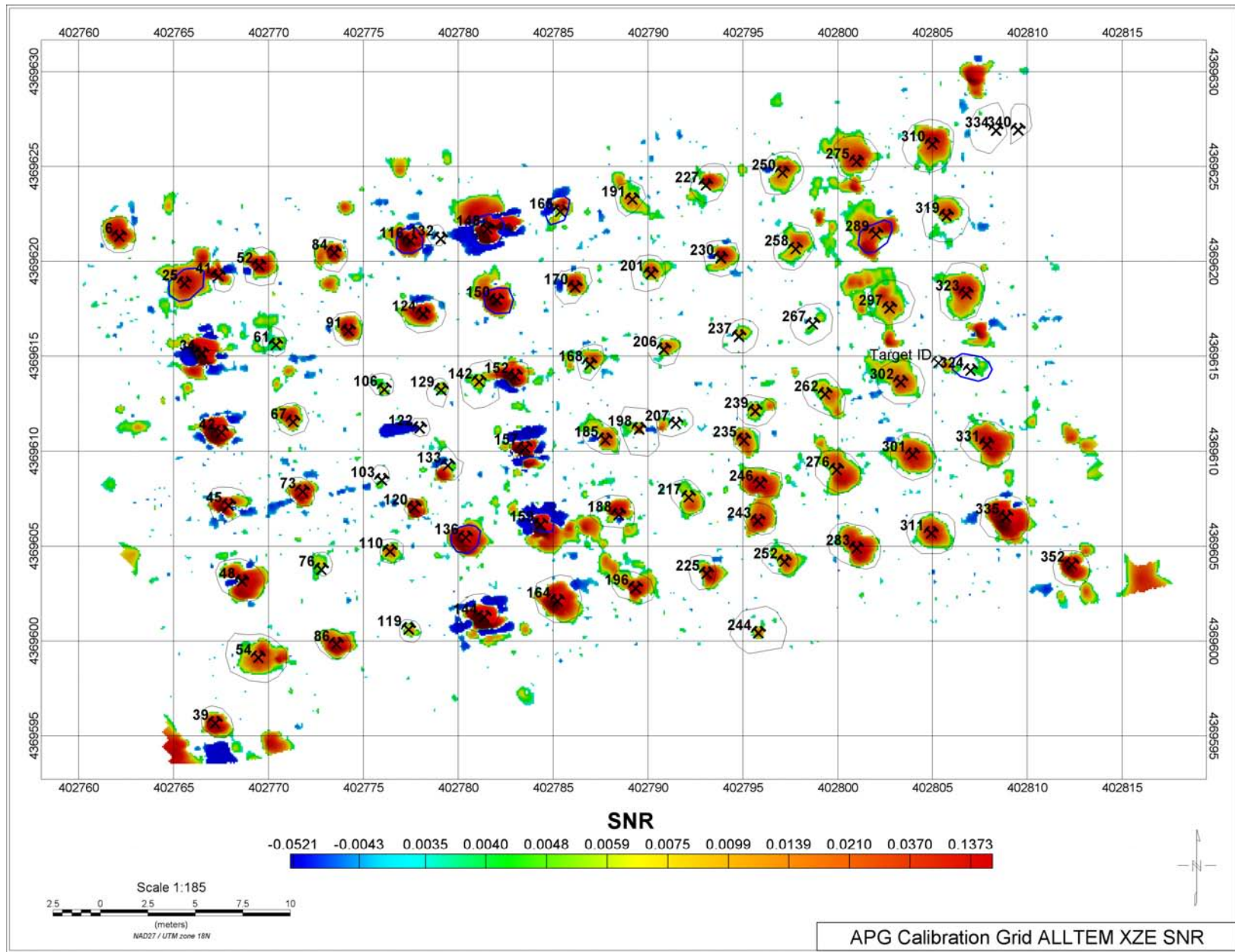

Appendix 2 – ALLTEM Data and Signal to Noise Maps

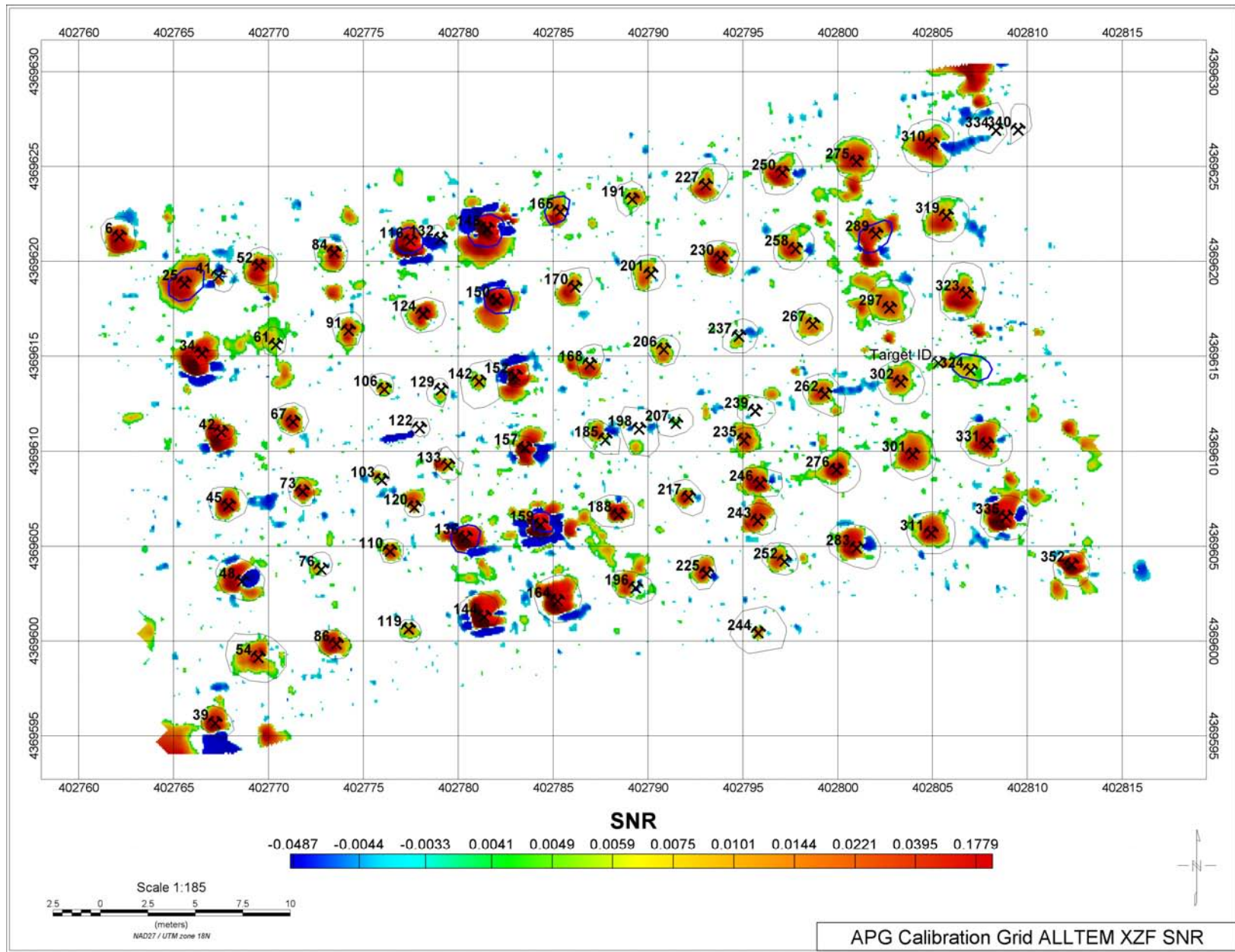

Appendix 2 – ALLTEM Data and Signal to Noise Maps

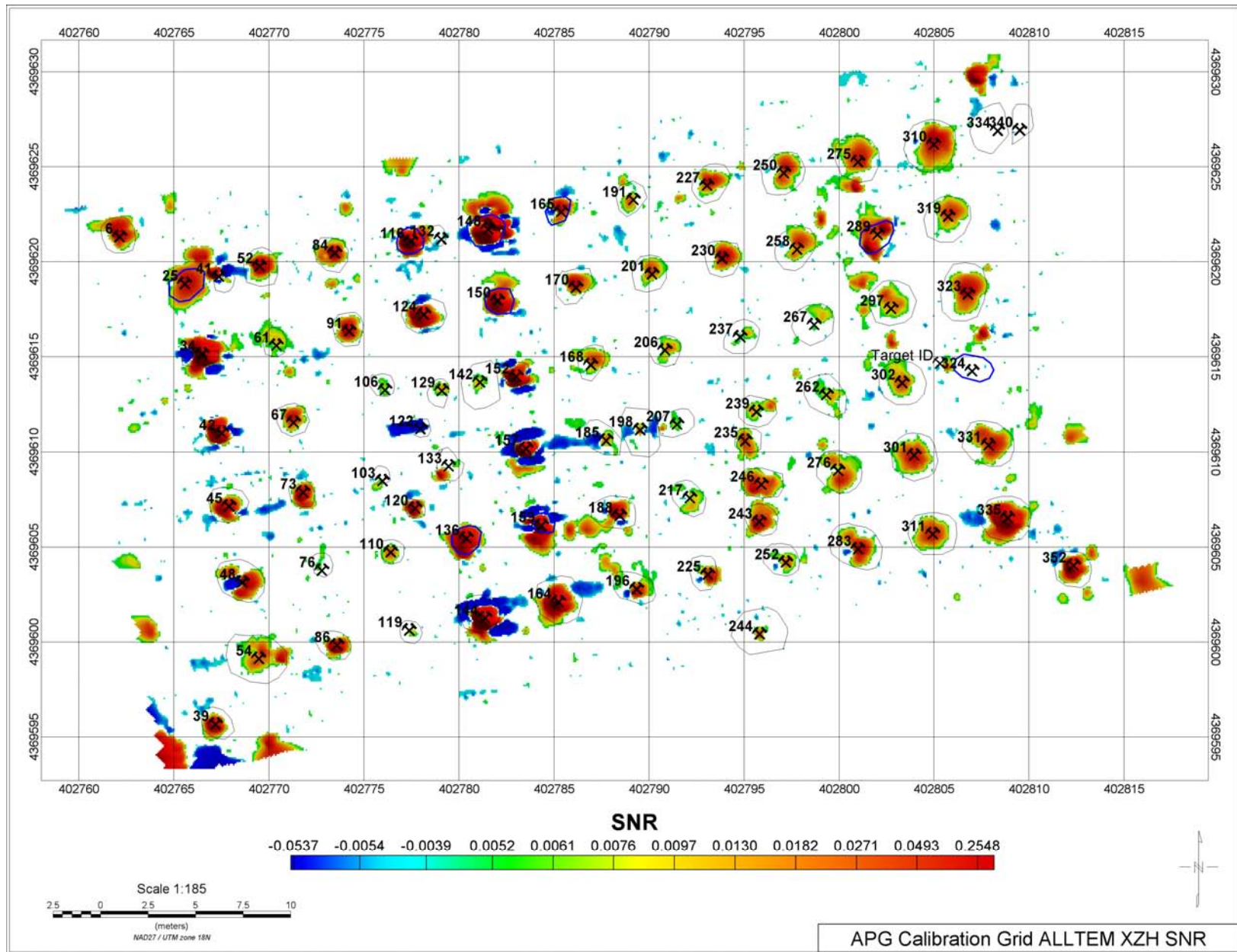

Appendix 2 – ALLTEM Data and Signal to Noise Maps

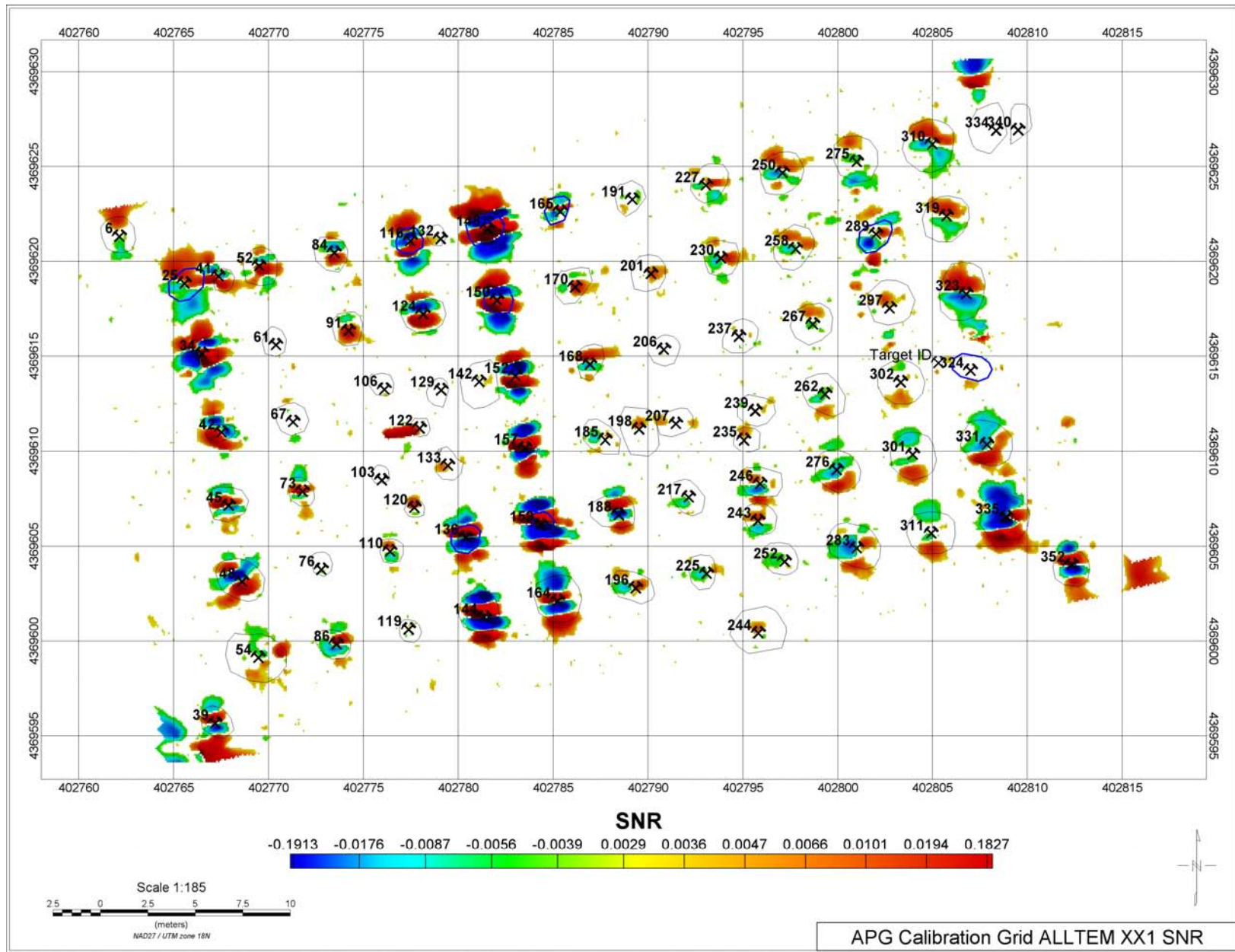

Appendix 2 – ALLTEM Data and Signal to Noise Maps

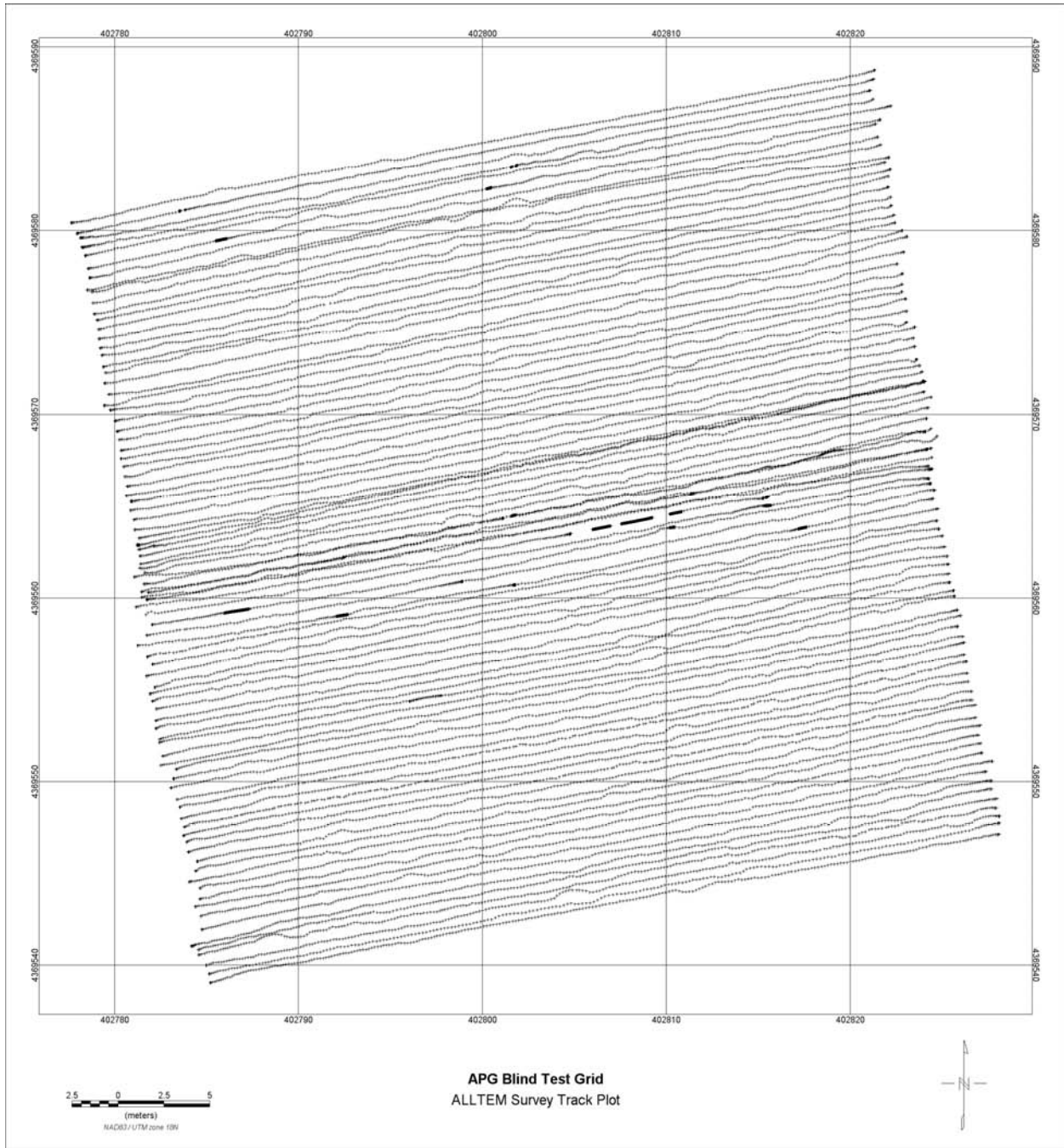

Appendix 2 – ALLTEM Data and Signal to Noise Maps

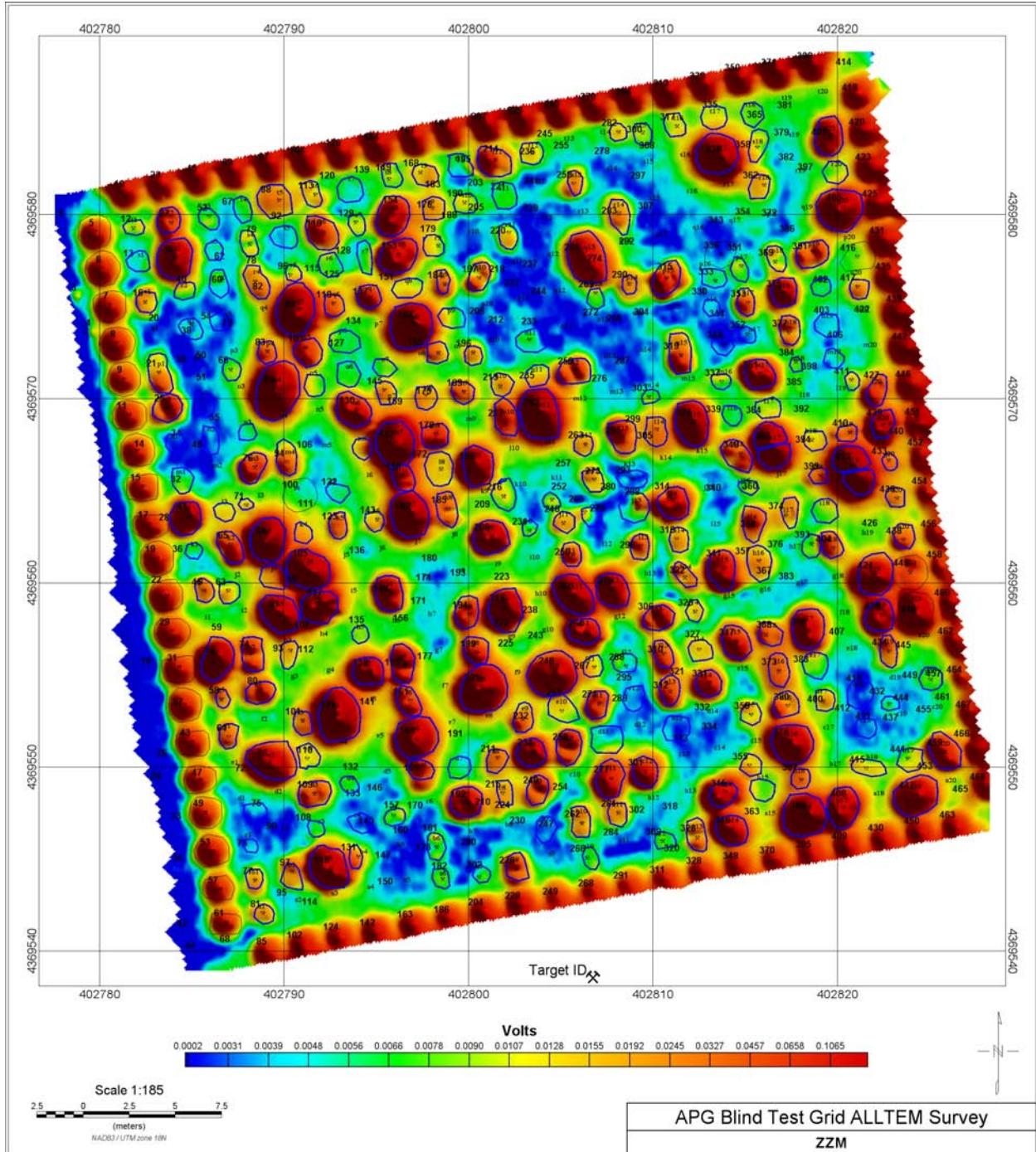

Appendix 2 – ALLTEM Data and Signal to Noise Maps

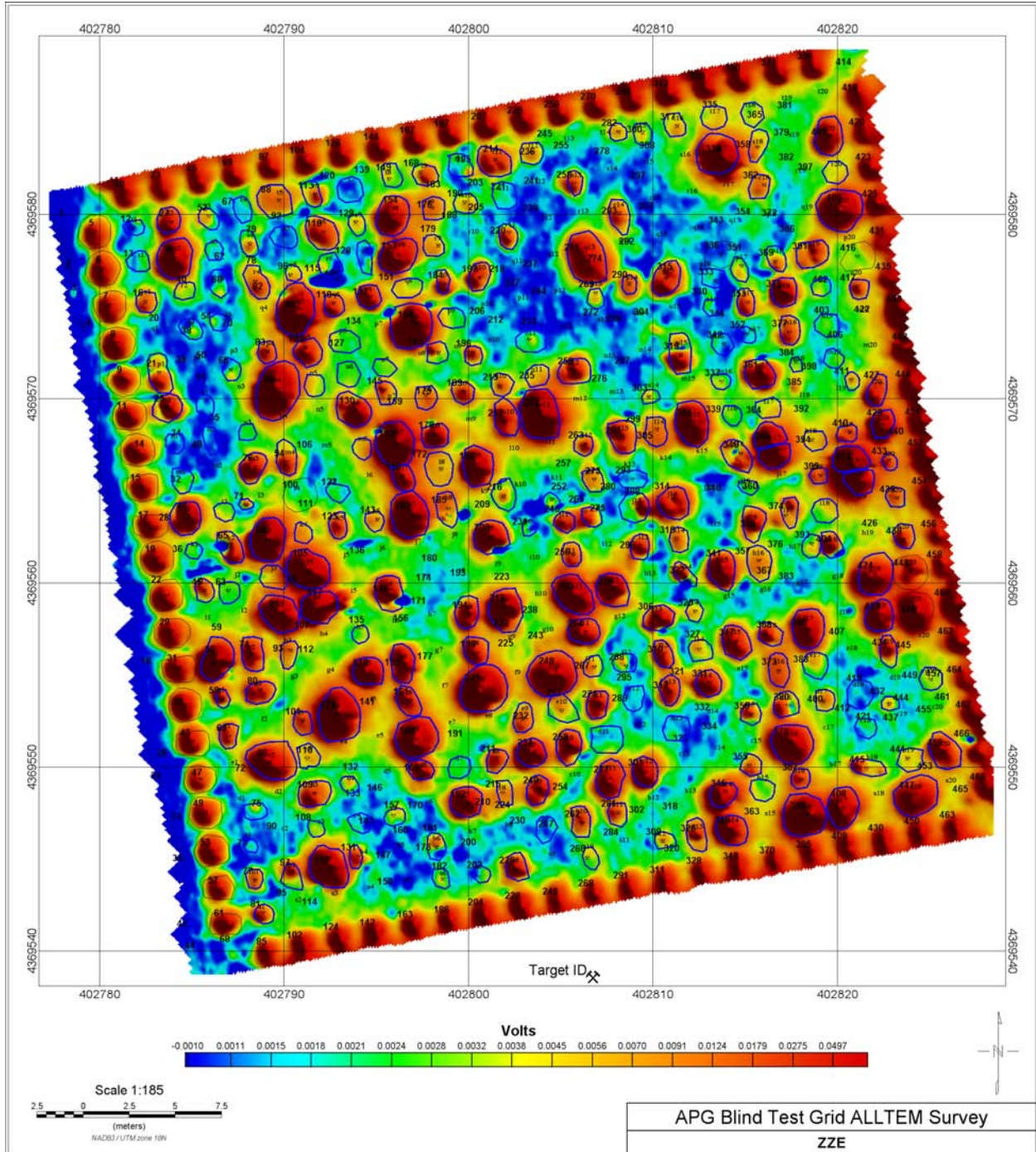

Appendix 2 – ALLTEM Data and Signal to Noise Maps

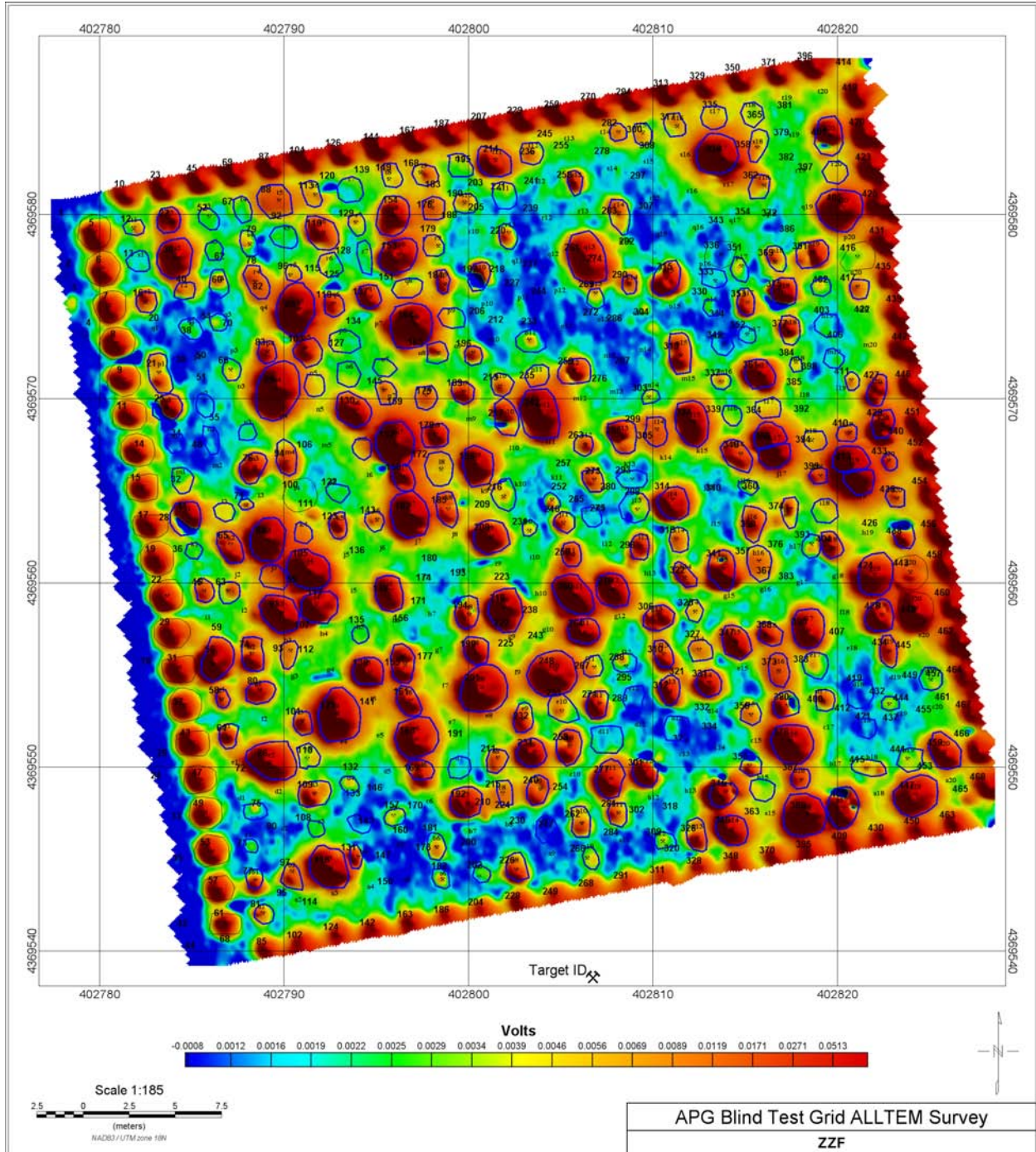

Appendix 2 – ALLTEM Data and Signal to Noise Maps

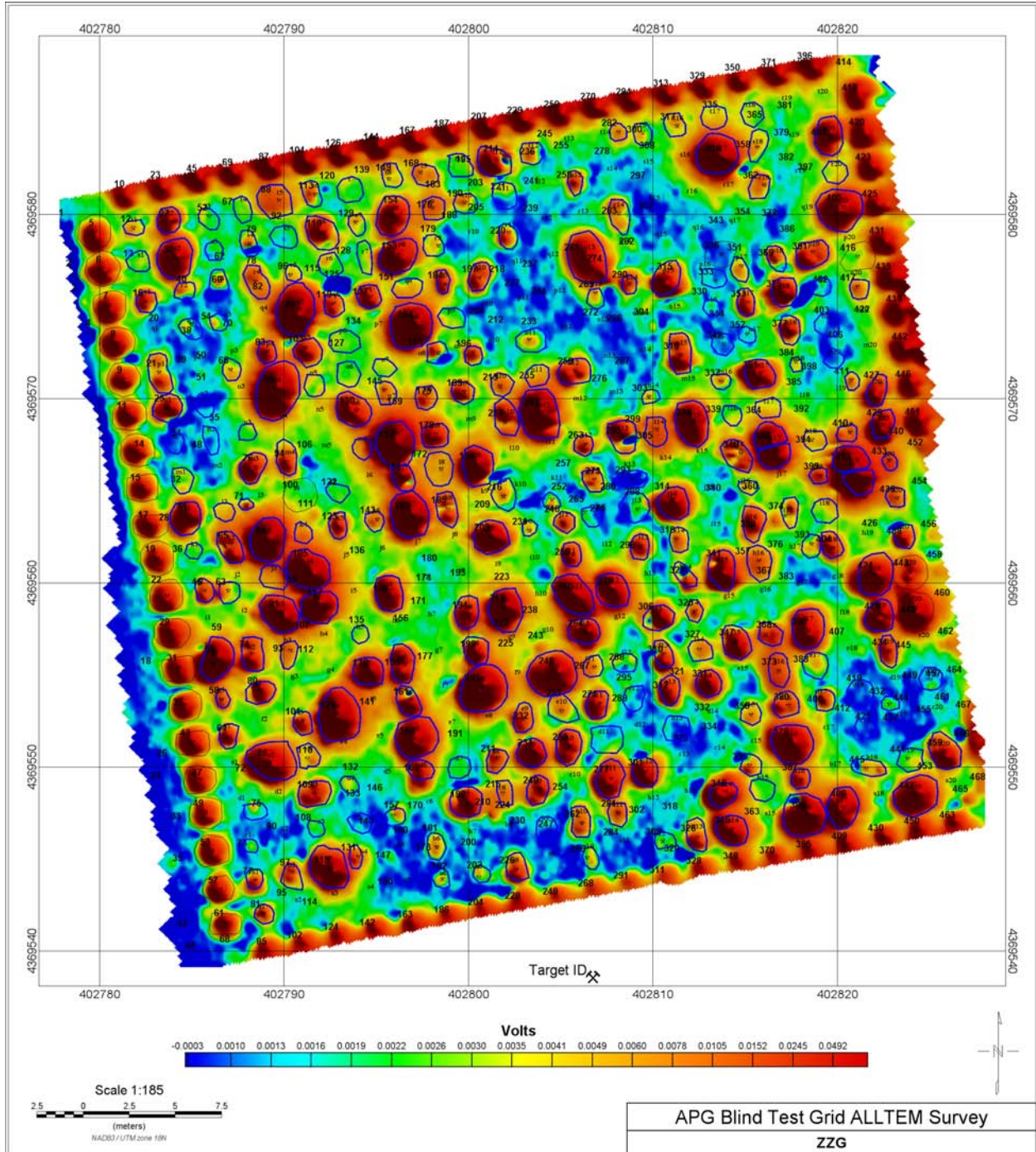

Appendix 2 – ALLTEM Data and Signal to Noise Maps

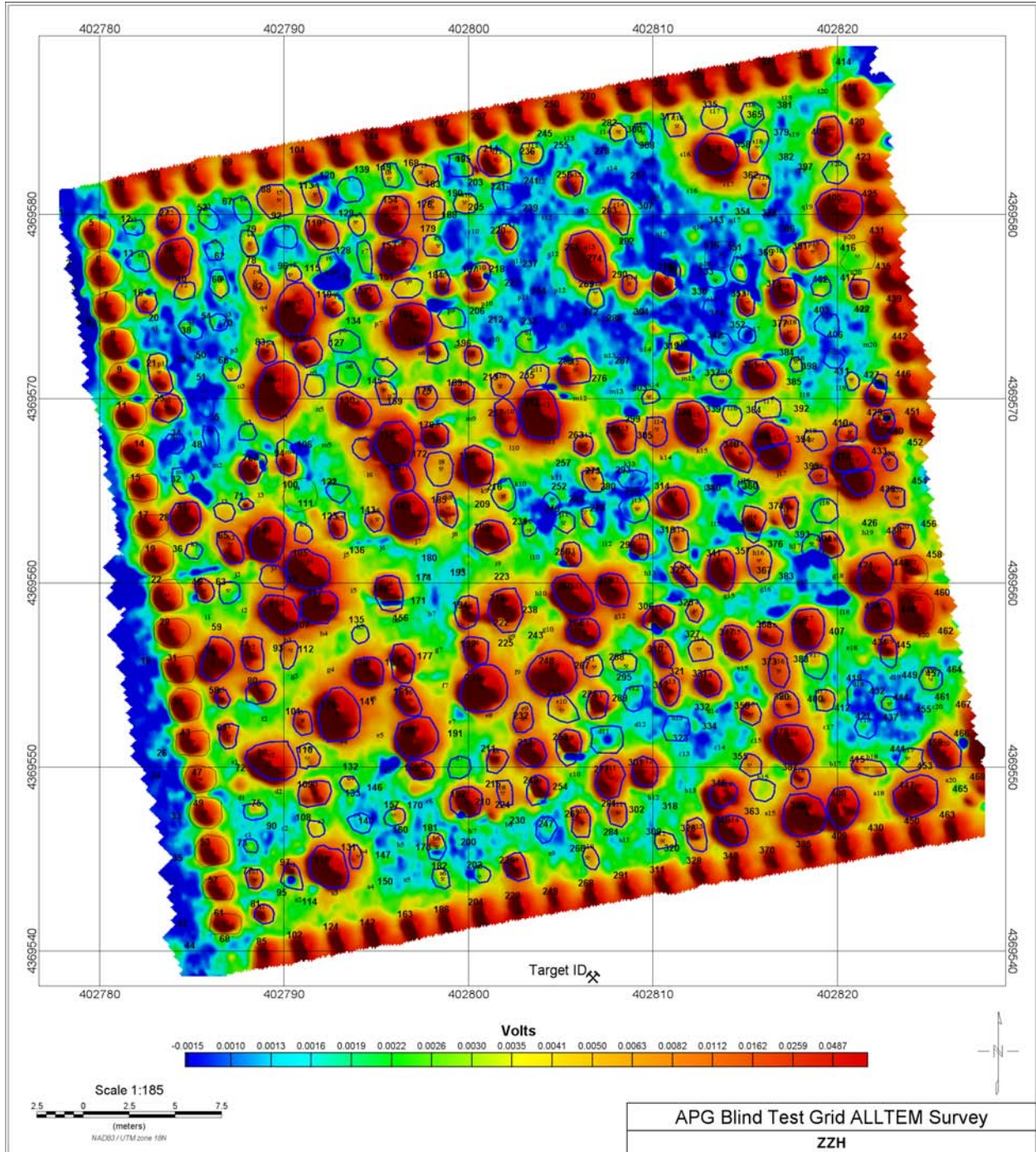

Appendix 2 – ALLTEM Data and Signal to Noise Maps

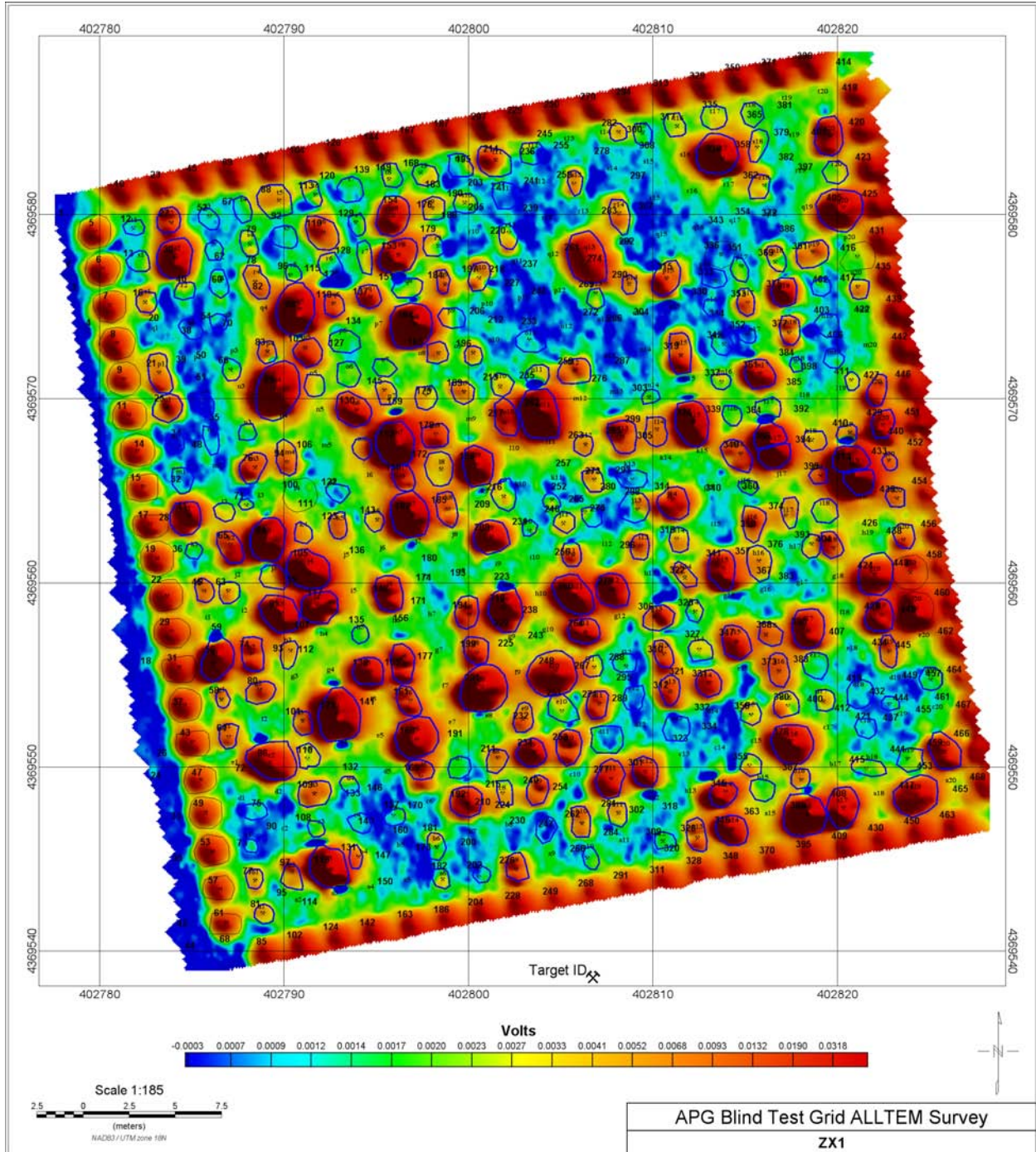

Appendix 2 – ALLTEM Data and Signal to Noise Maps

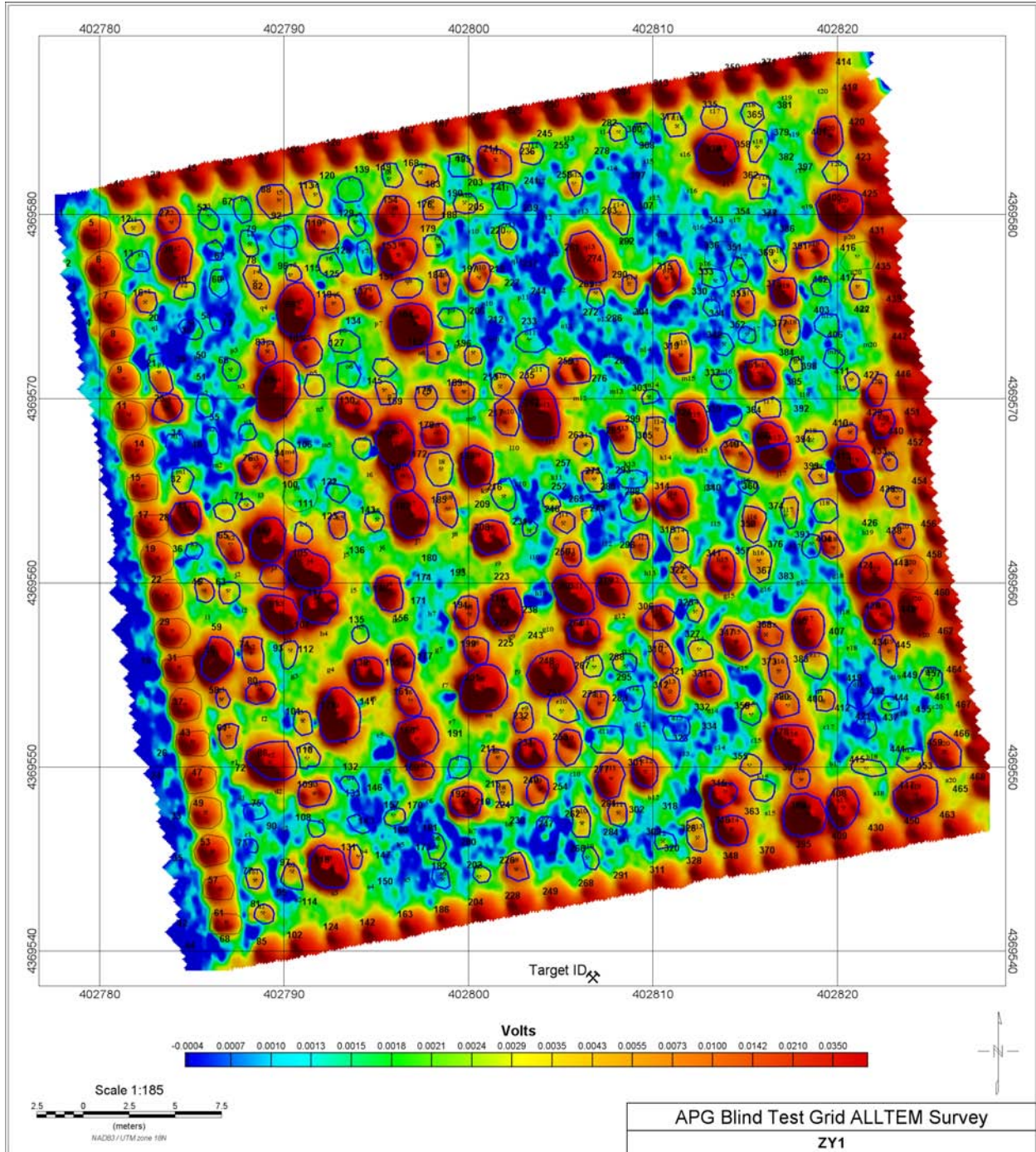

Appendix 2 – ALLTEM Data and Signal to Noise Maps

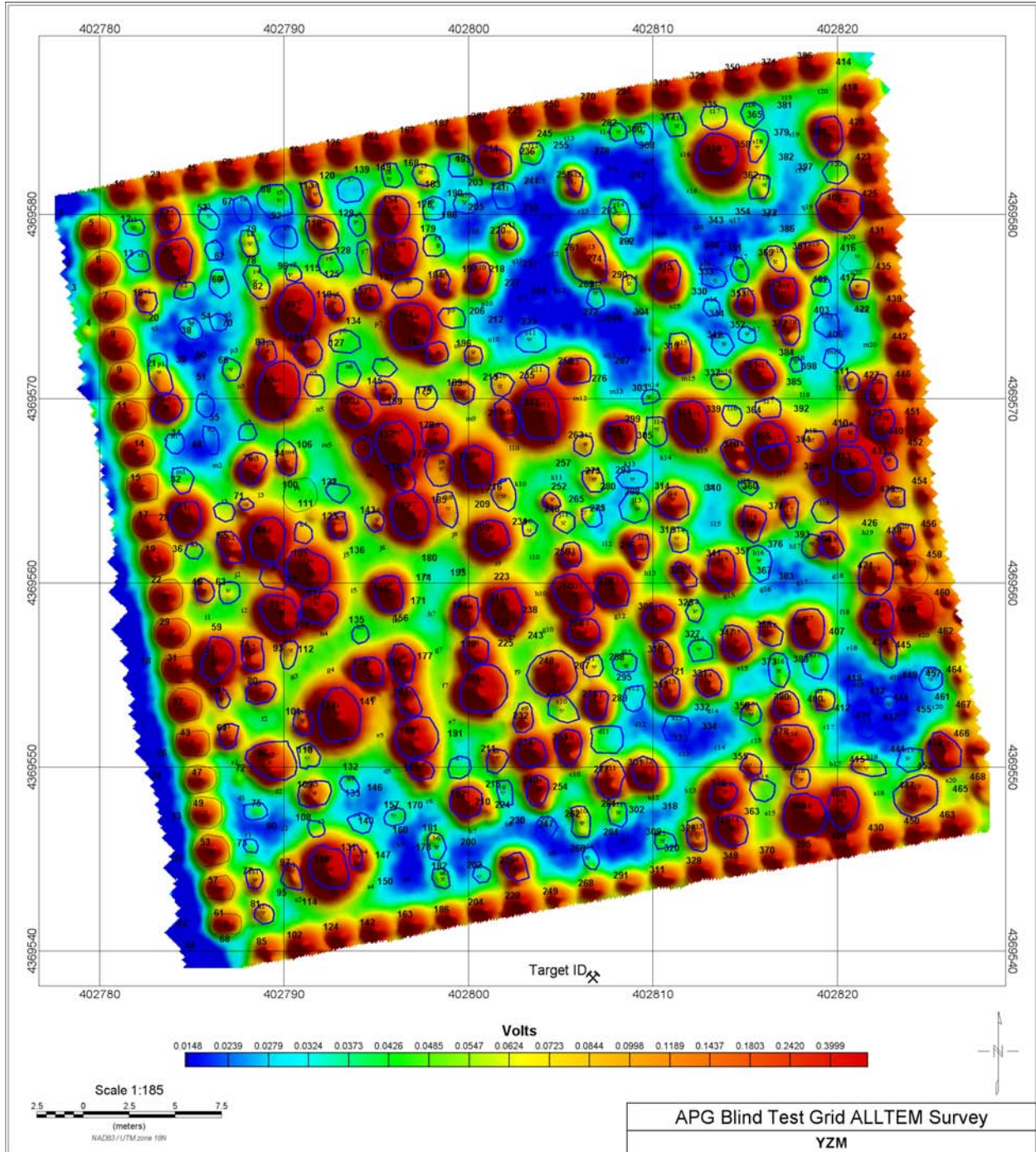

Appendix 2 – ALLTEM Data and Signal to Noise Maps

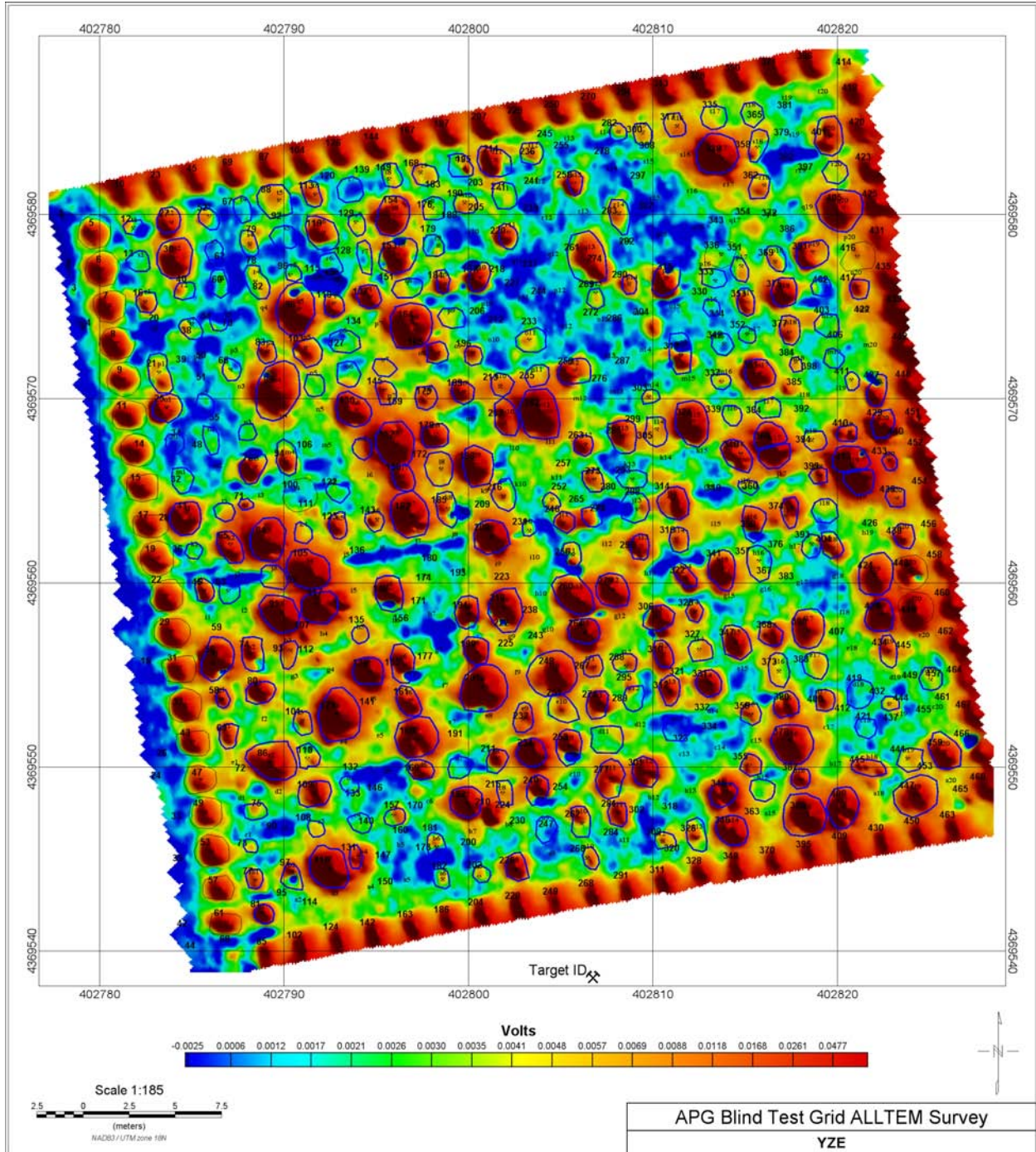

Appendix 2 – ALLTEM Data and Signal to Noise Maps

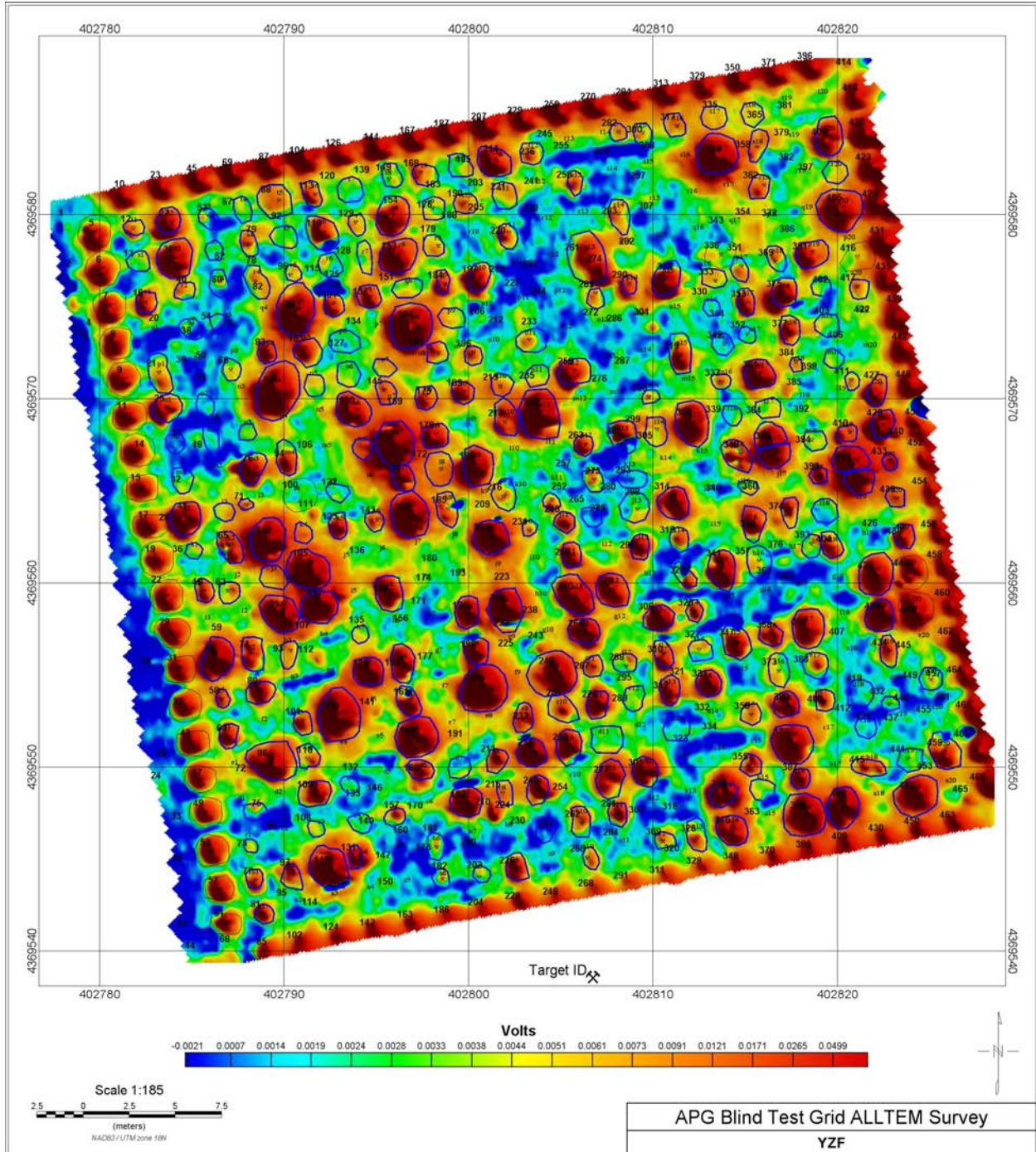

Appendix 2 – ALLTEM Data and Signal to Noise Maps

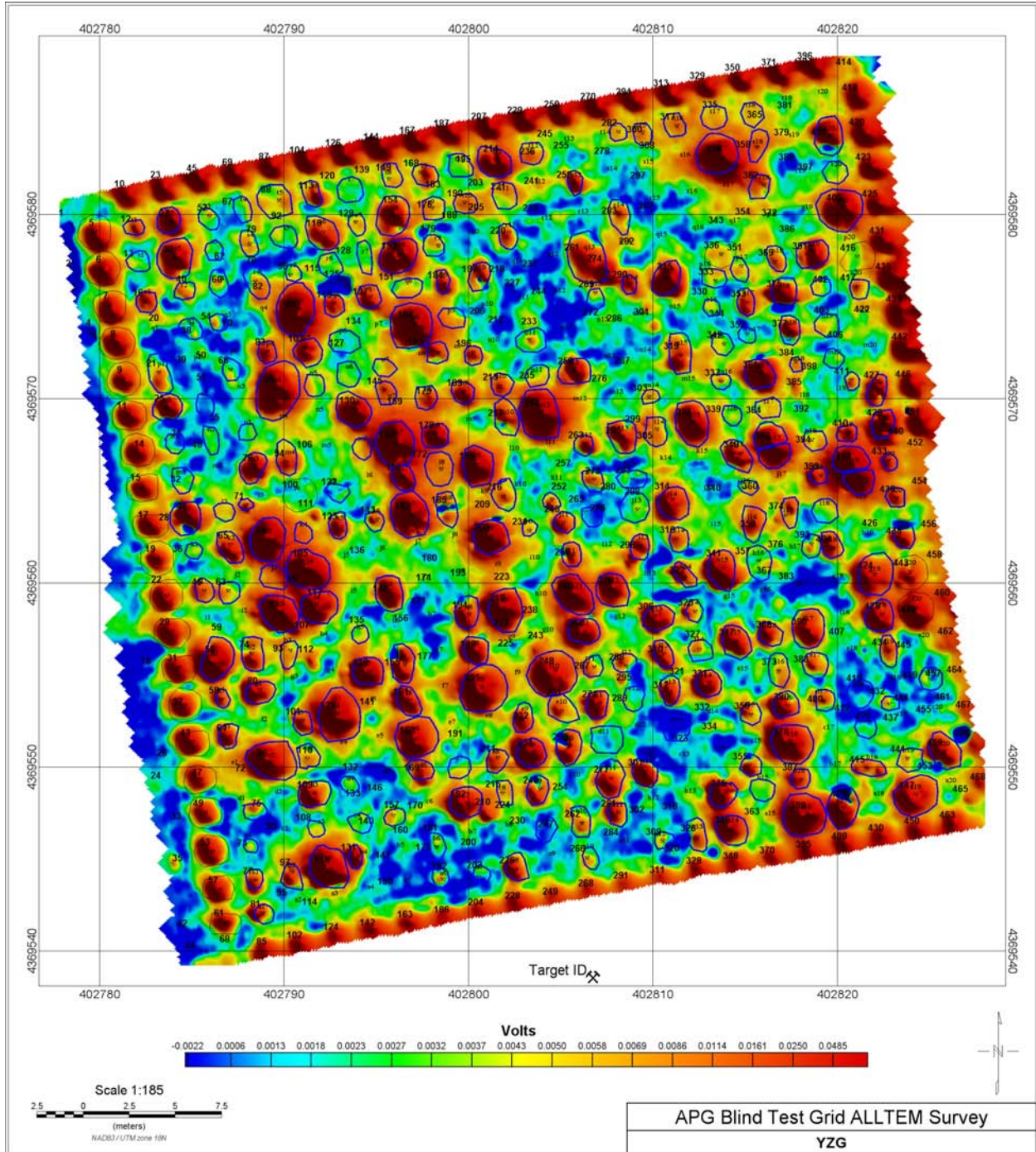

Appendix 2 – ALLTEM Data and Signal to Noise Maps

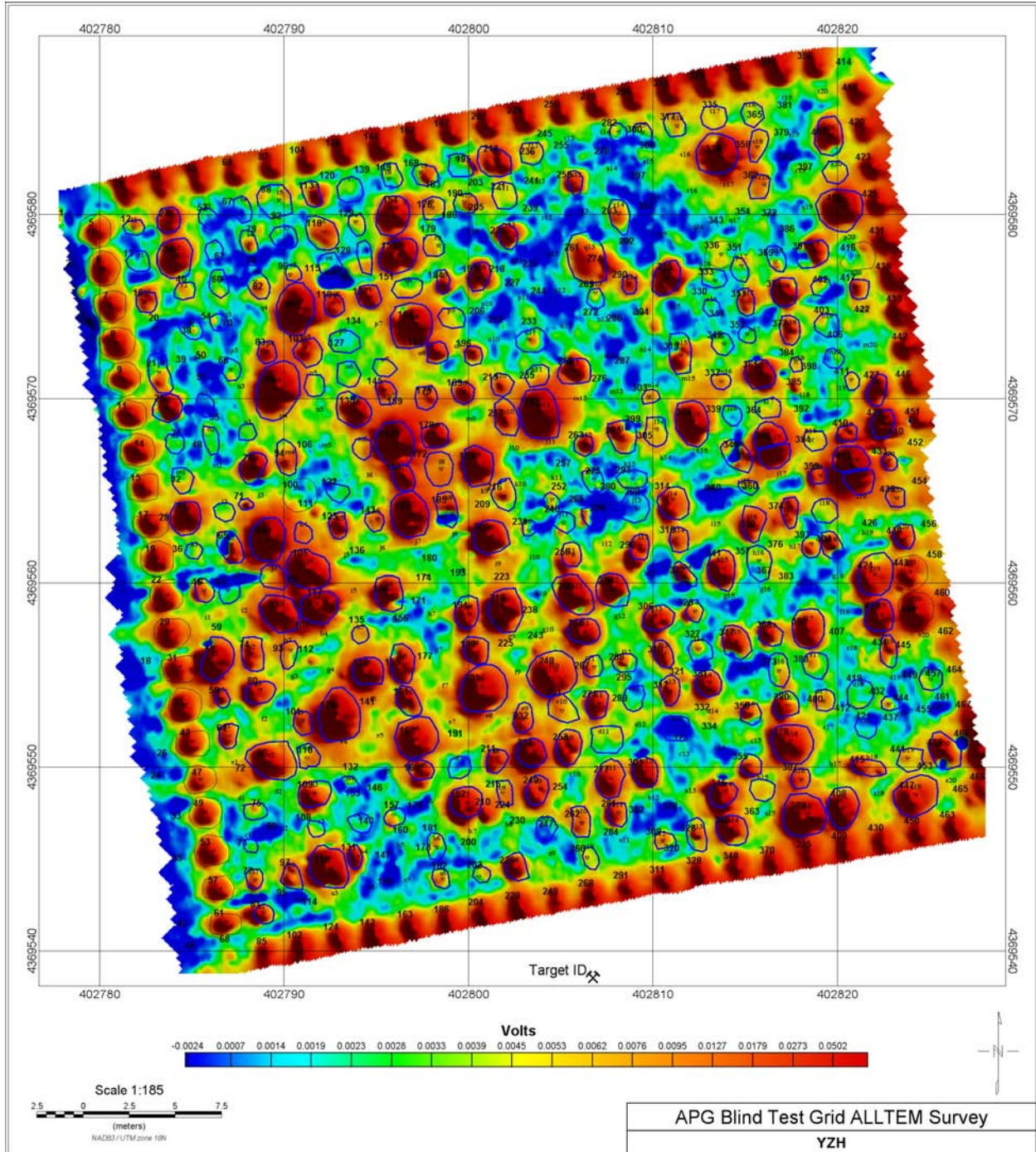

Appendix 2 – ALLTEM Data and Signal to Noise Maps

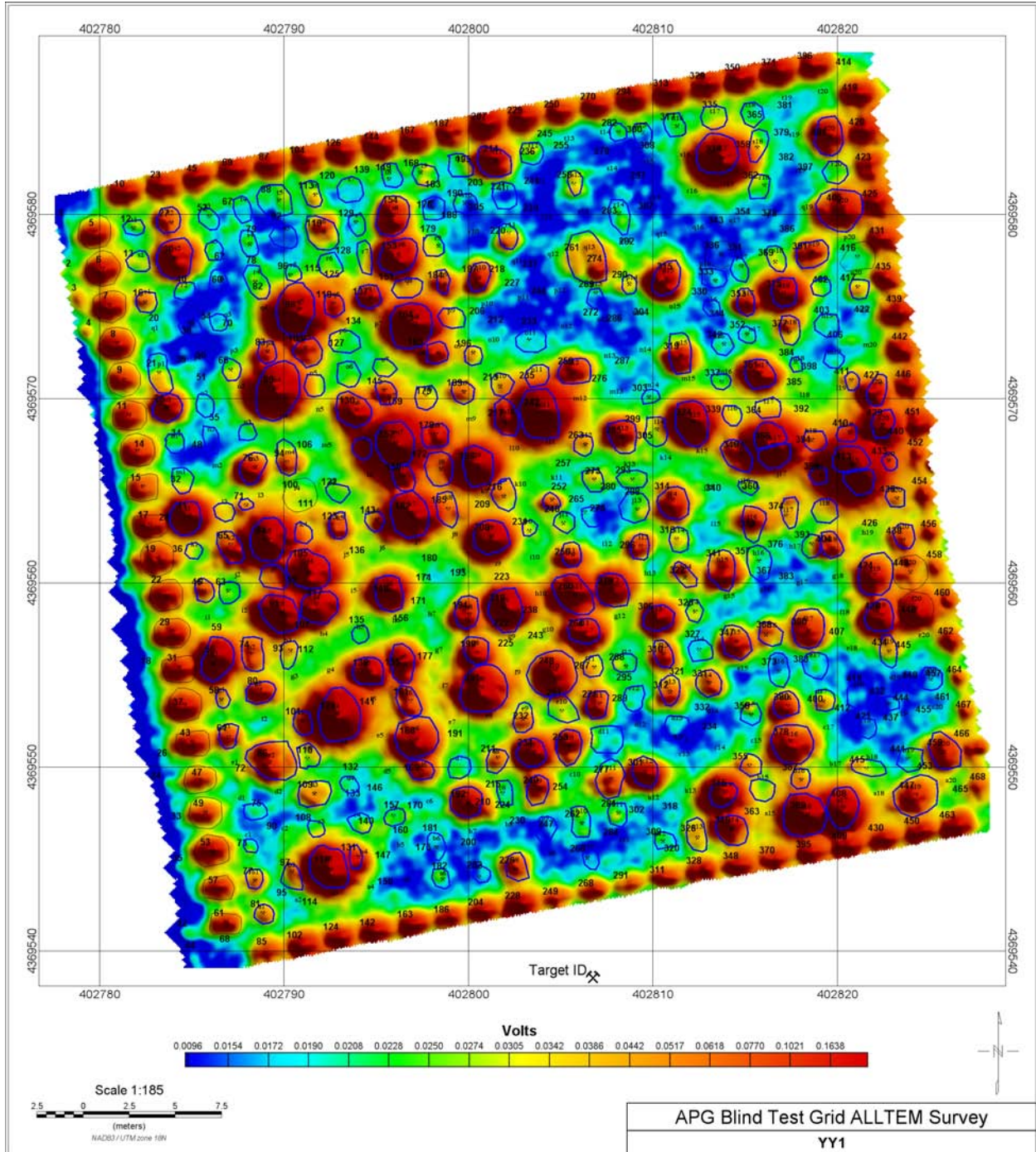

Appendix 2 – ALLTEM Data and Signal to Noise Maps

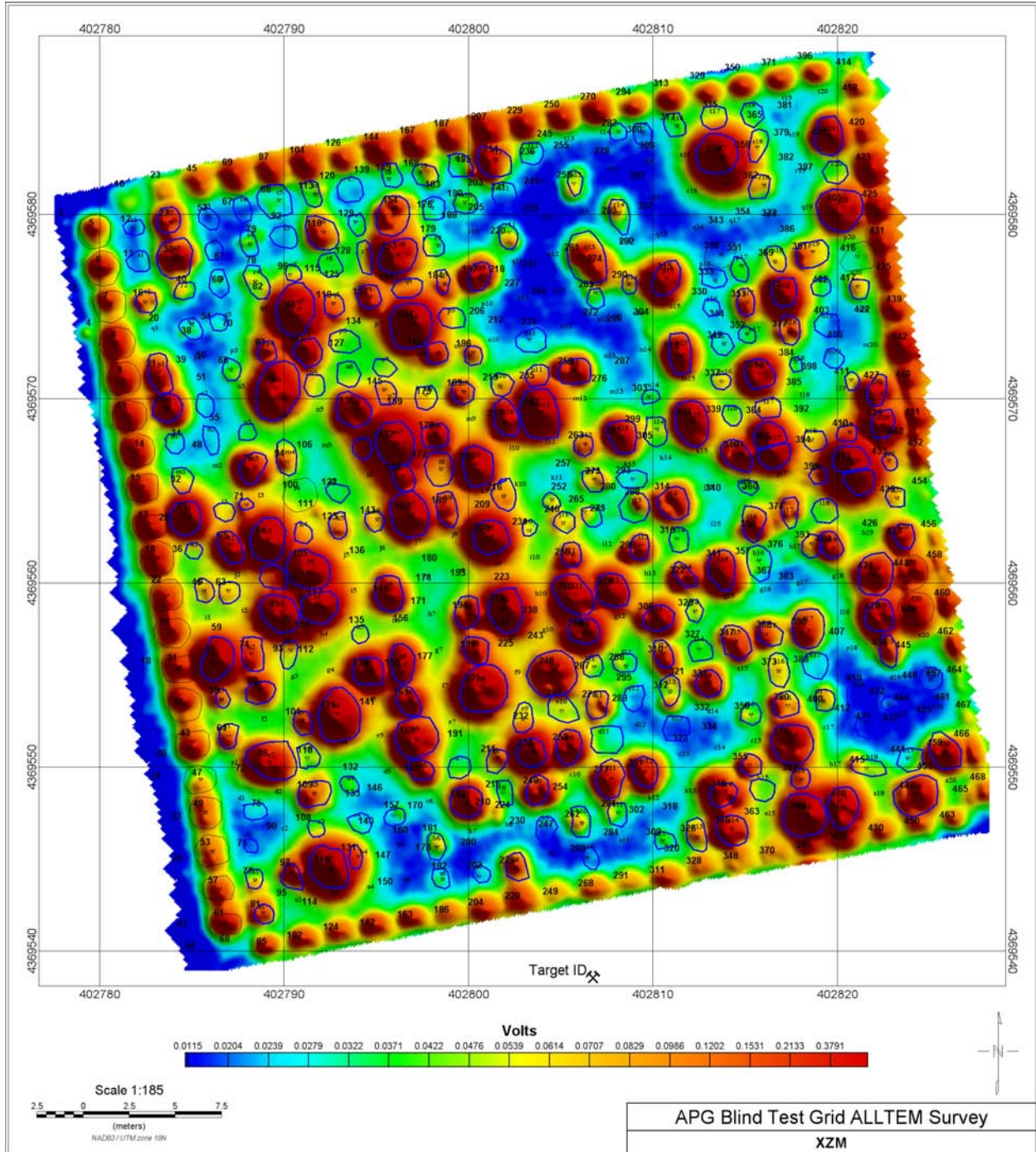

Appendix 2 – ALLTEM Data and Signal to Noise Maps

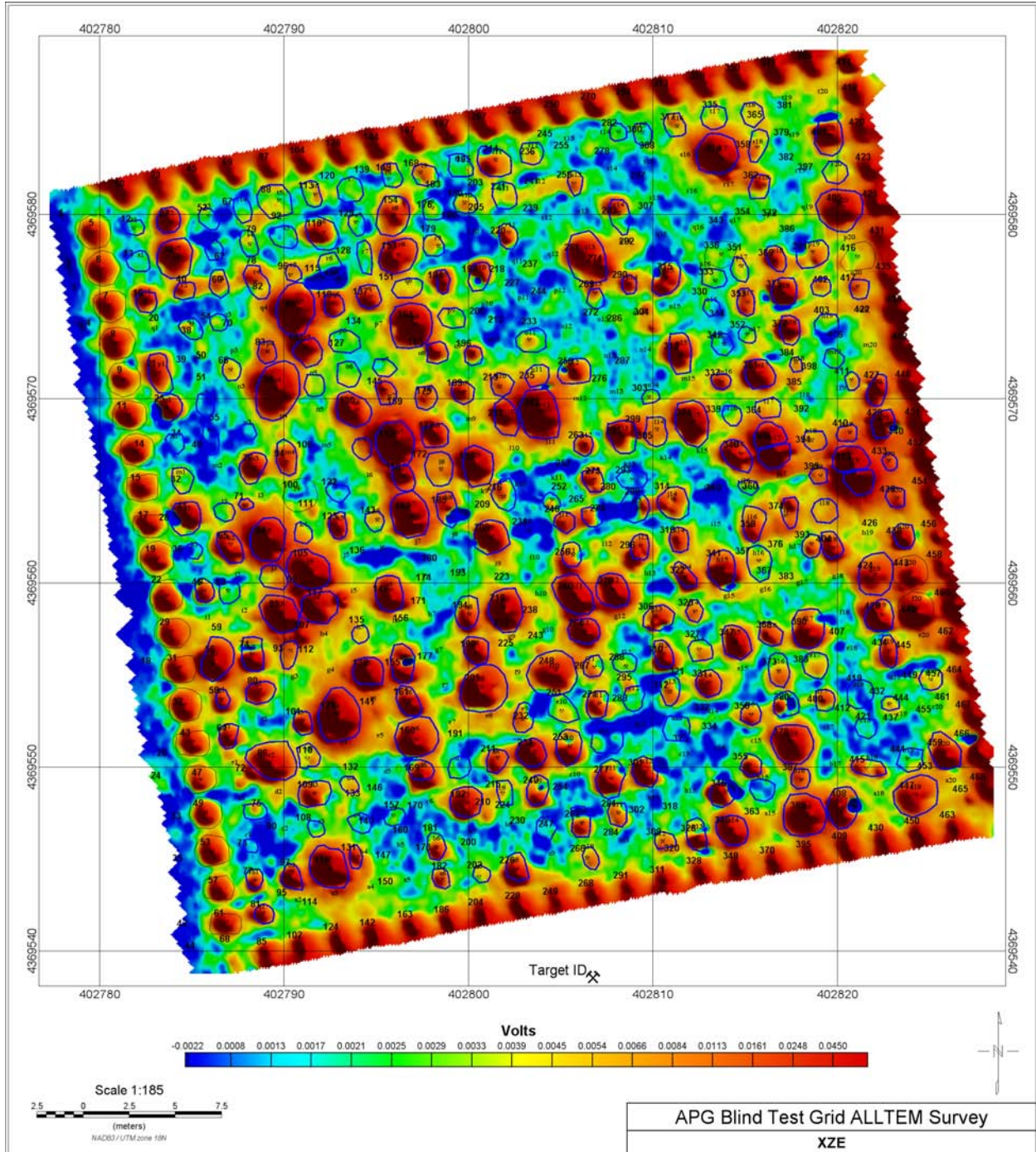

Appendix 2 – ALLTEM Data and Signal to Noise Maps

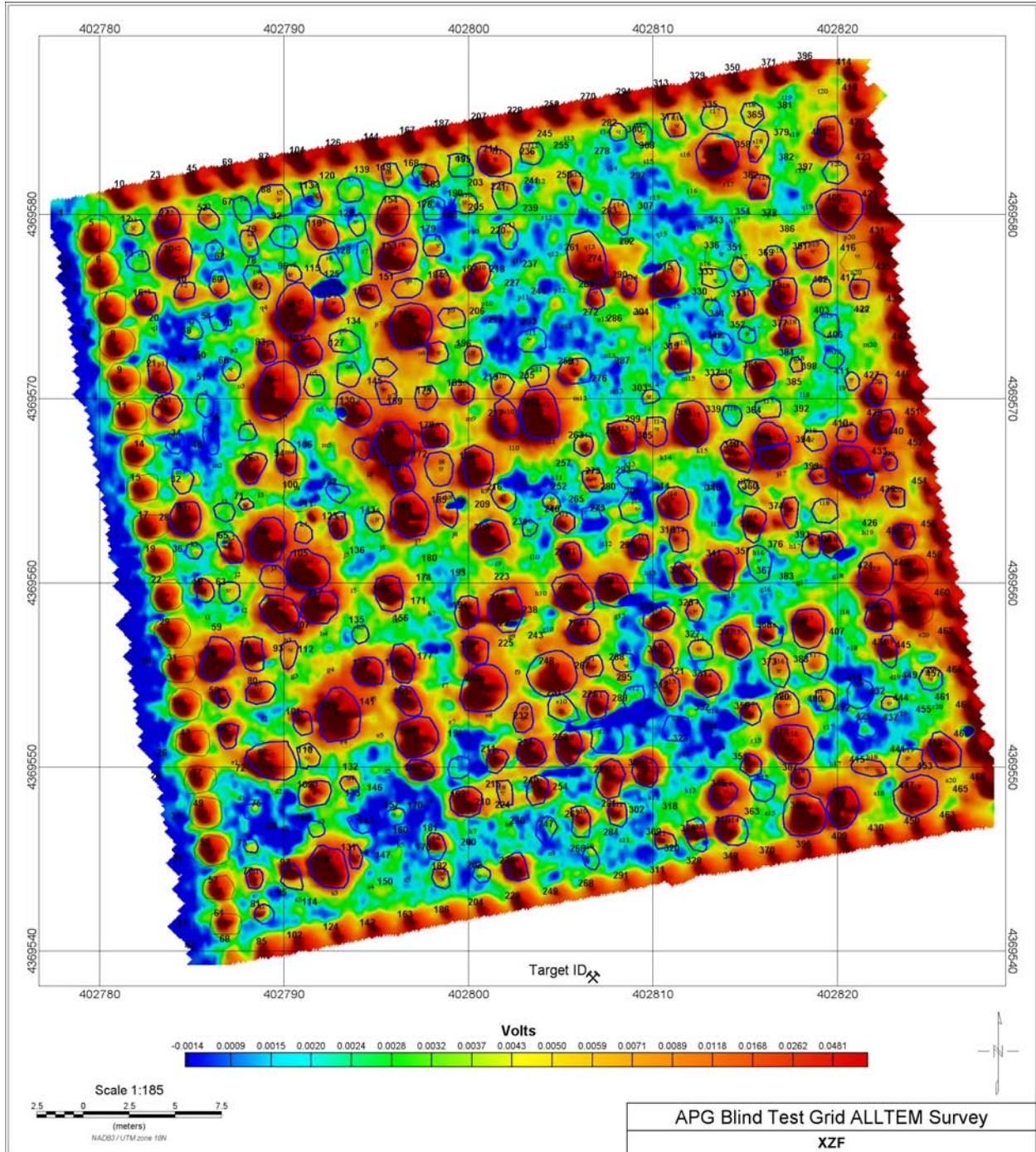

Appendix 2 – ALLTEM Data and Signal to Noise Maps

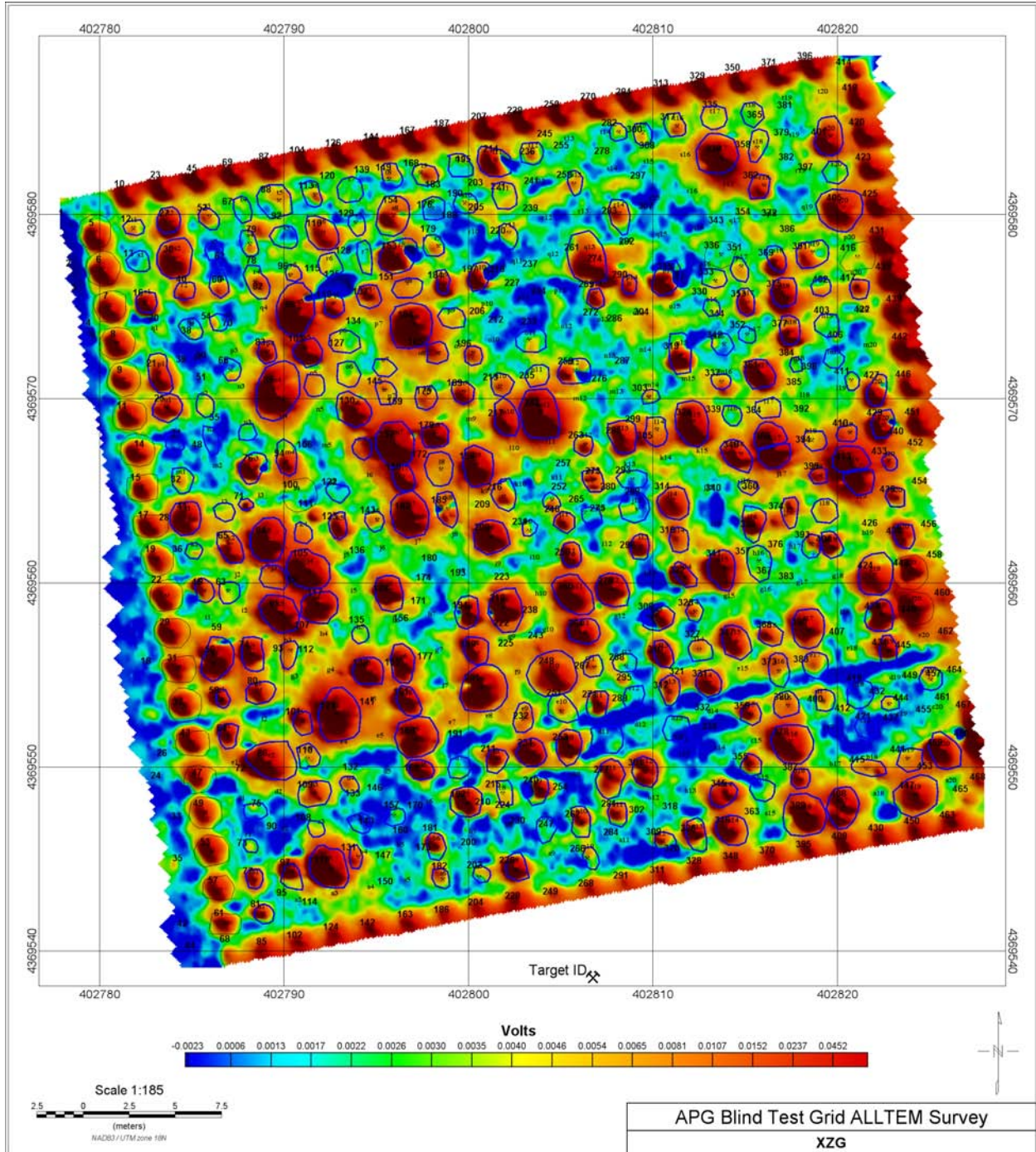

Appendix 2 – ALLTEM Data and Signal to Noise Maps

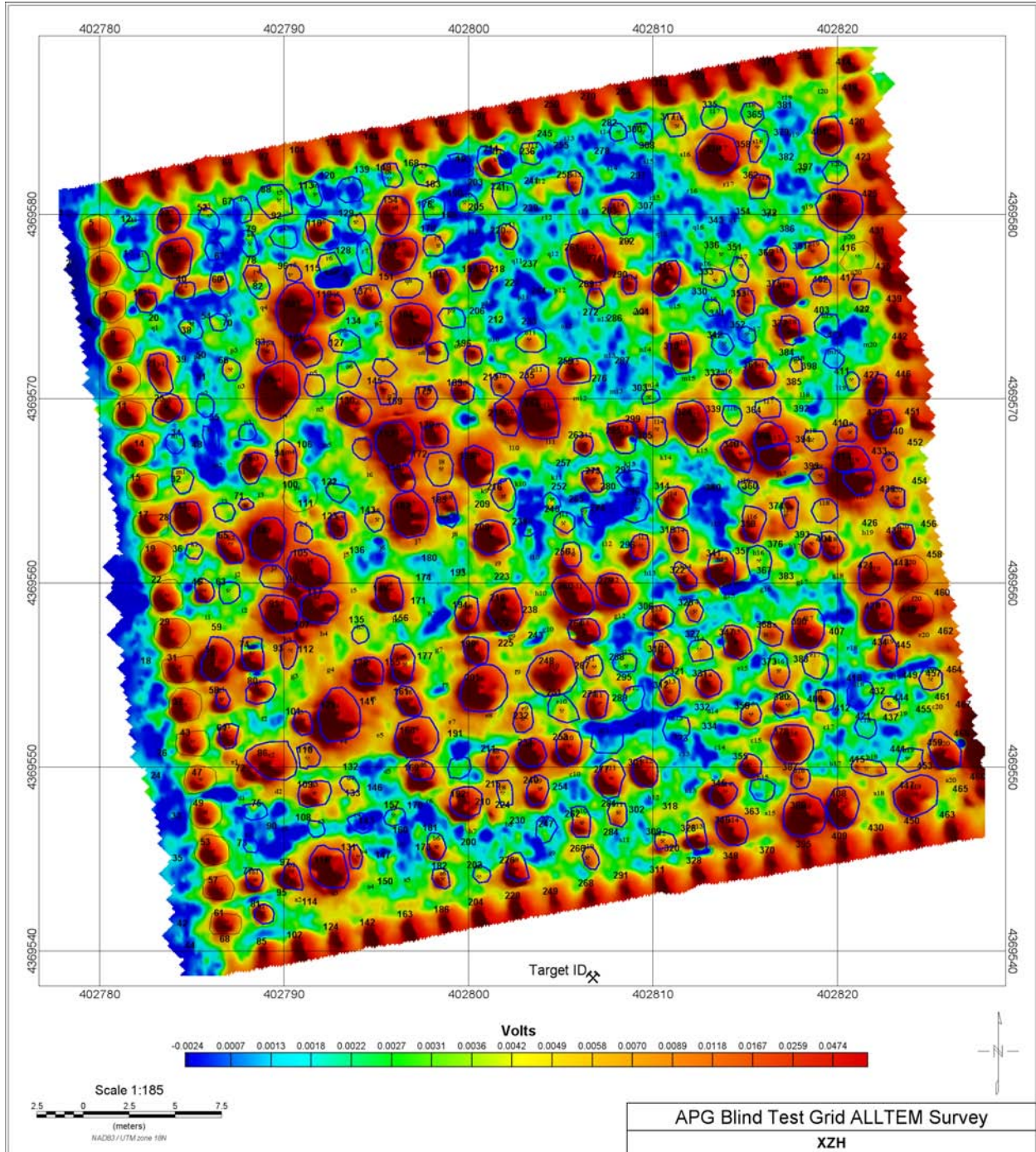

Appendix 2 – ALLTEM Data and Signal to Noise Maps

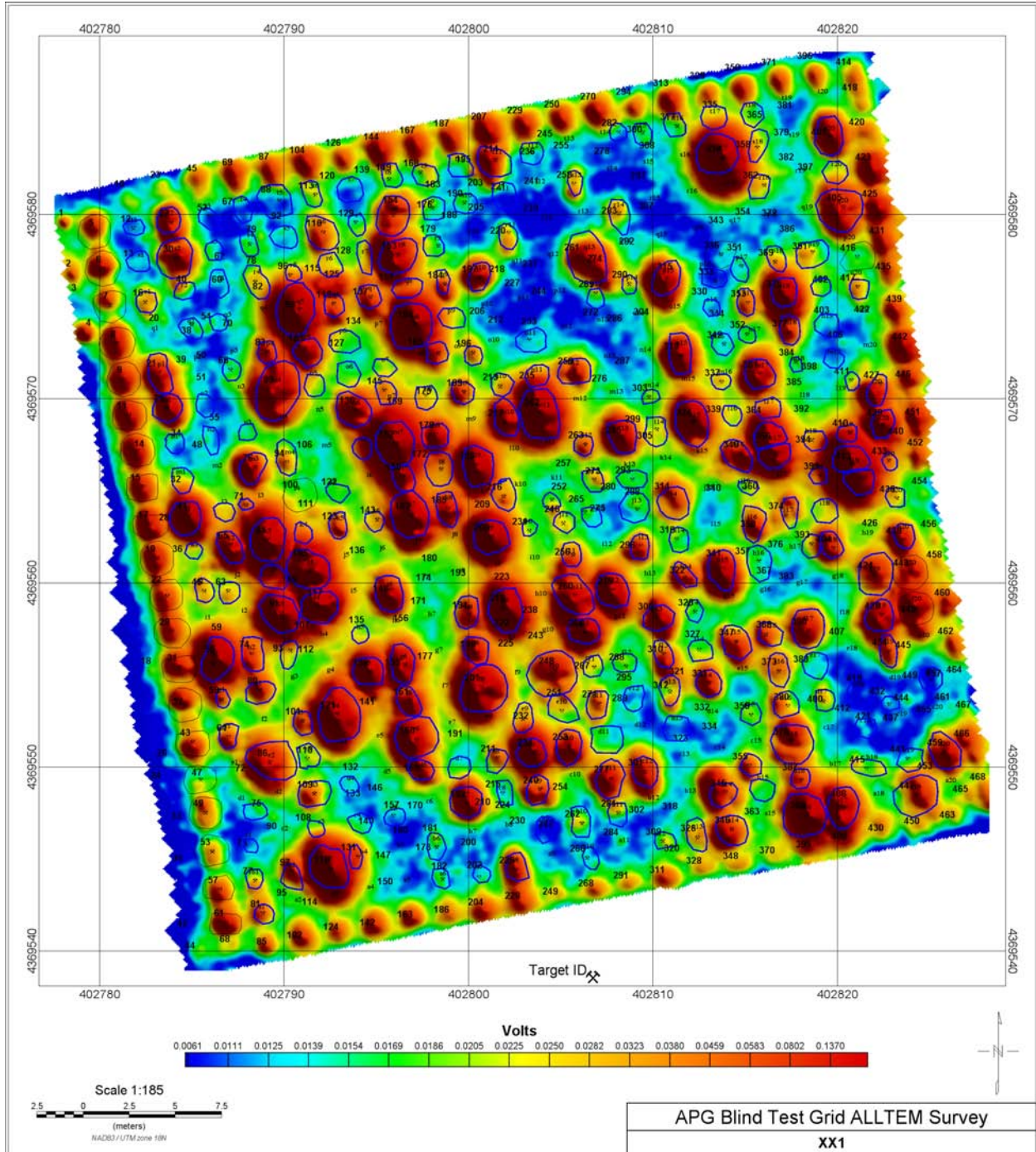

Appendix 2 – ALLTEM Data and Signal to Noise Maps

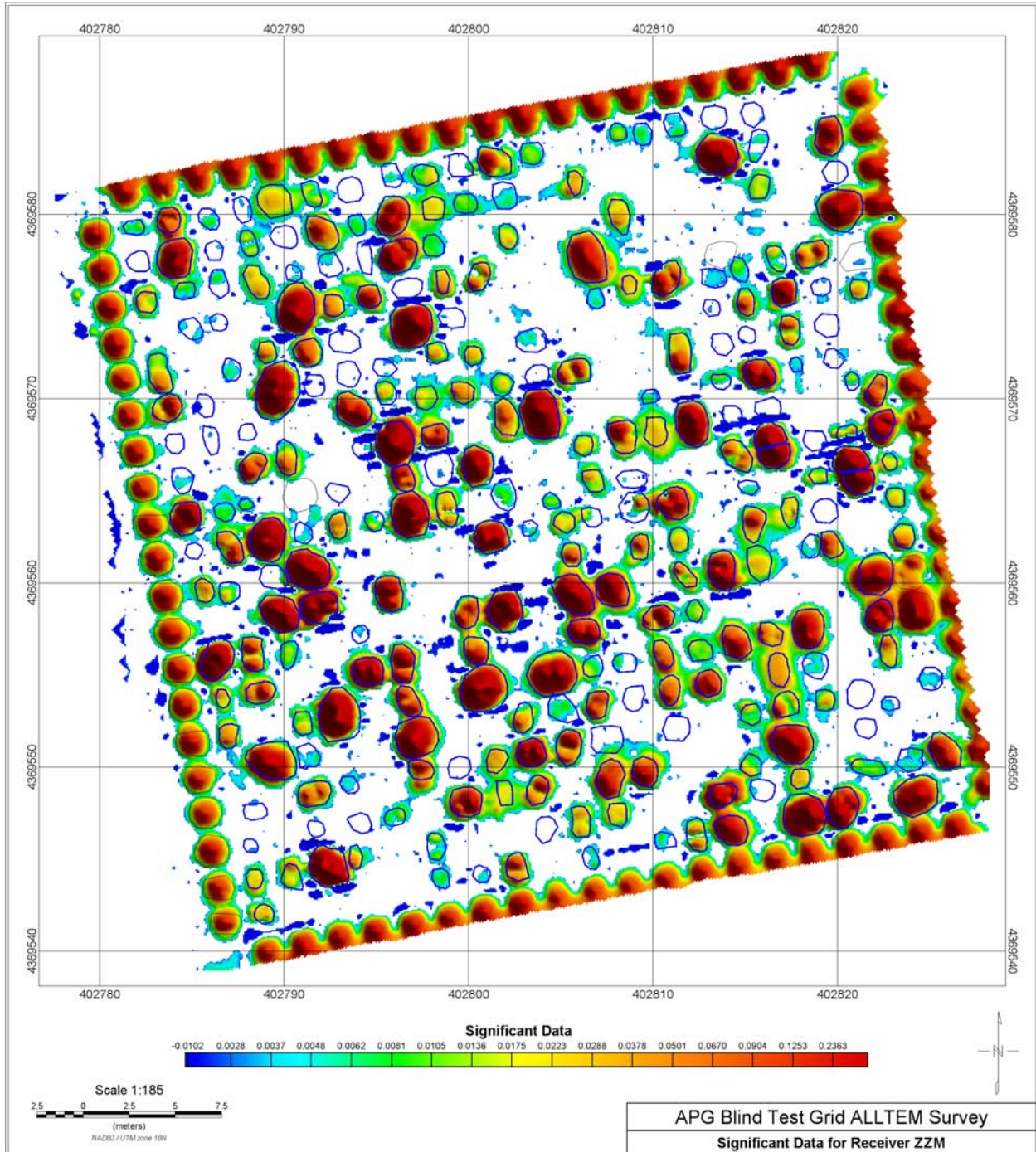

Appendix 2 – ALLTEM Data and Signal to Noise Maps

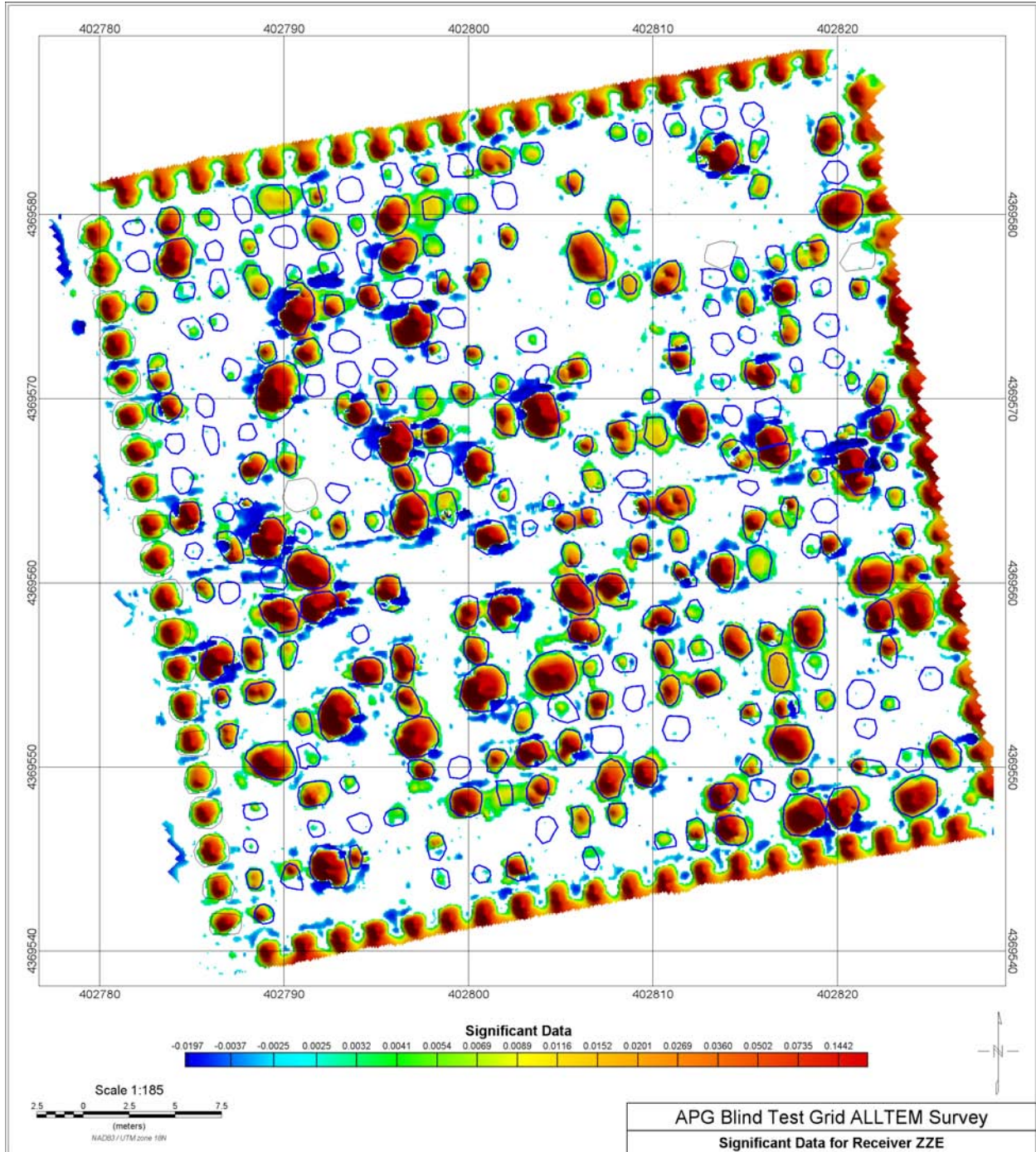

Appendix 2 – ALLTEM Data and Signal to Noise Maps

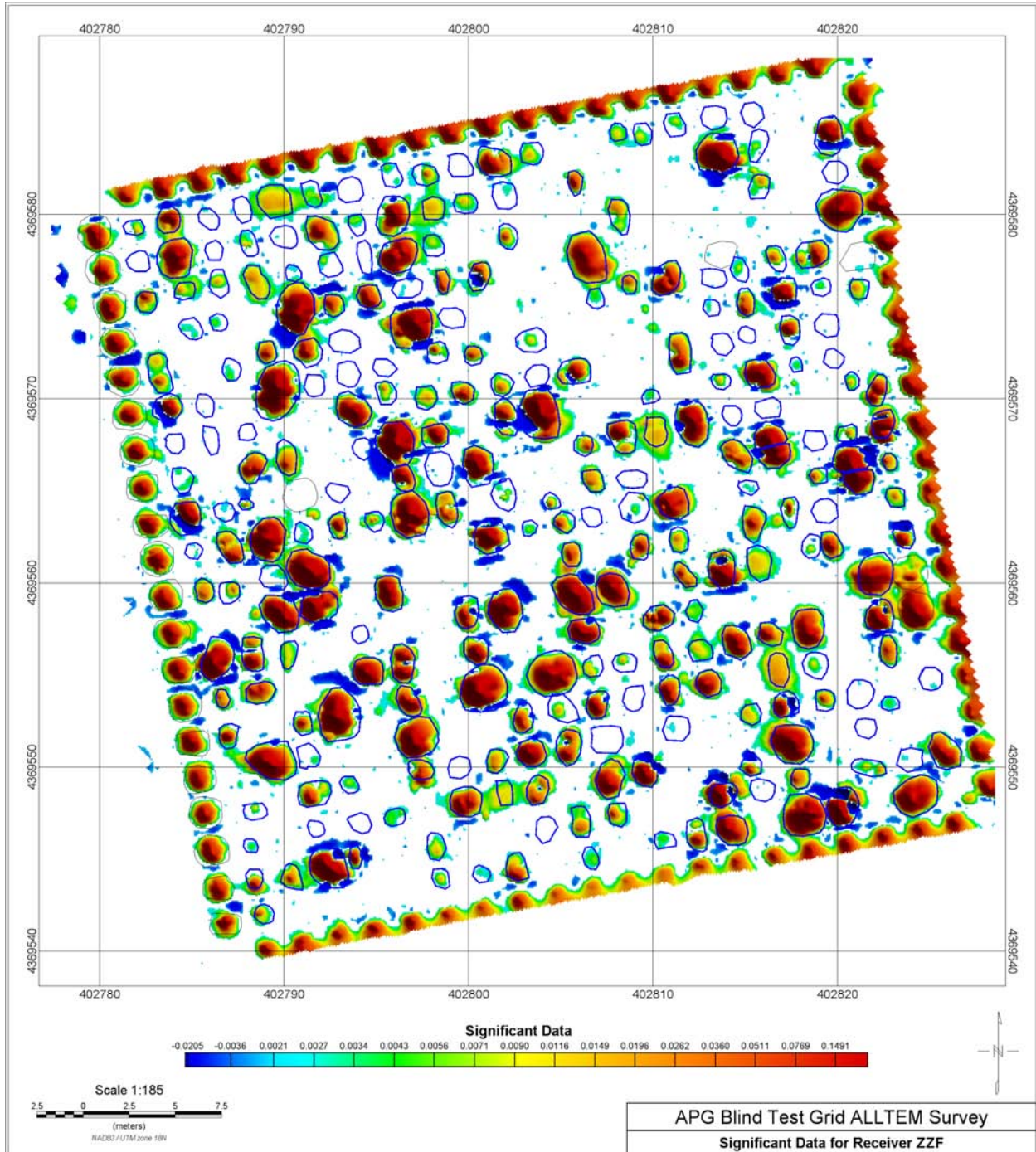

Appendix 2 – ALLTEM Data and Signal to Noise Maps

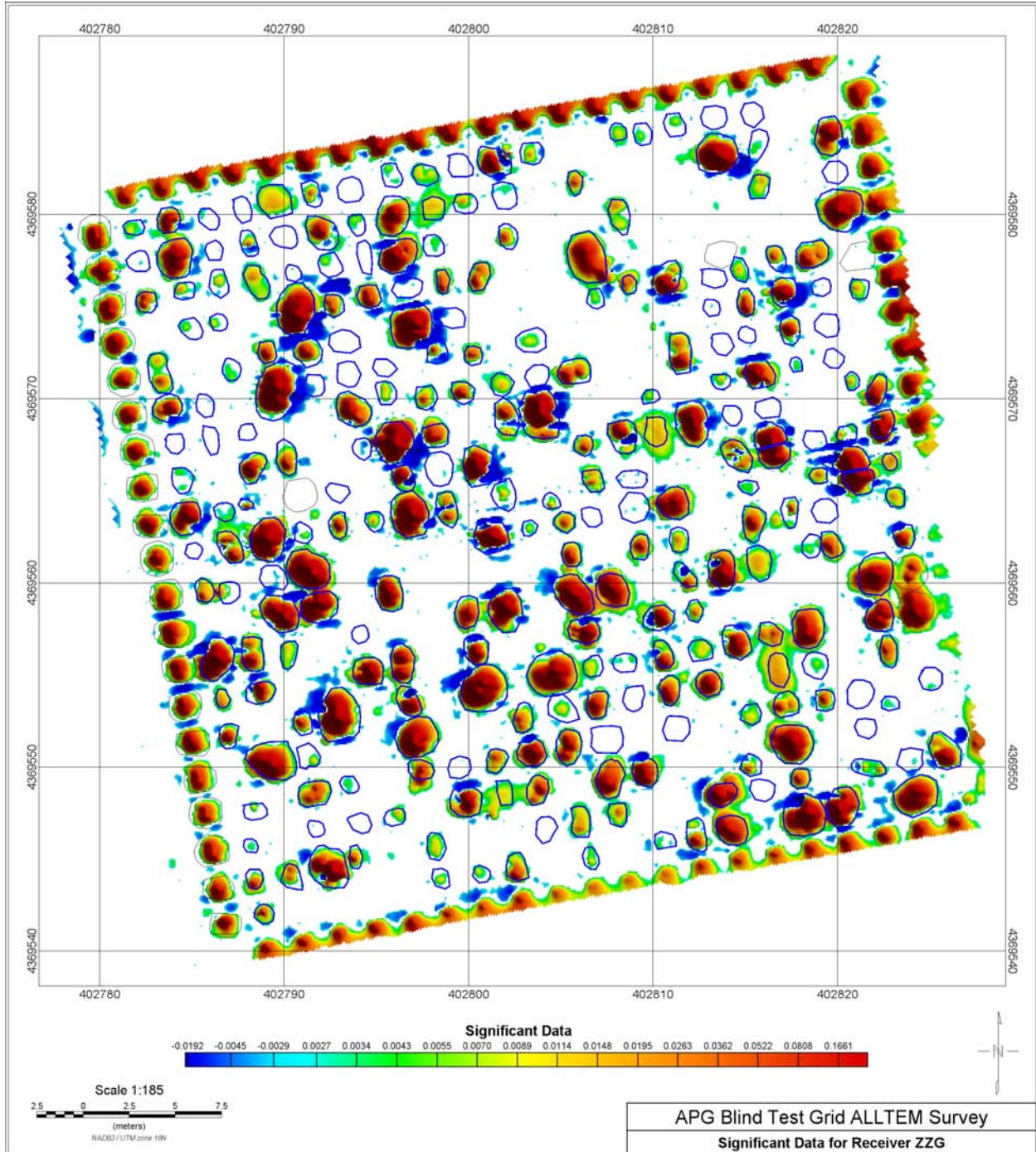

Appendix 2 – ALLTEM Data and Signal to Noise Maps

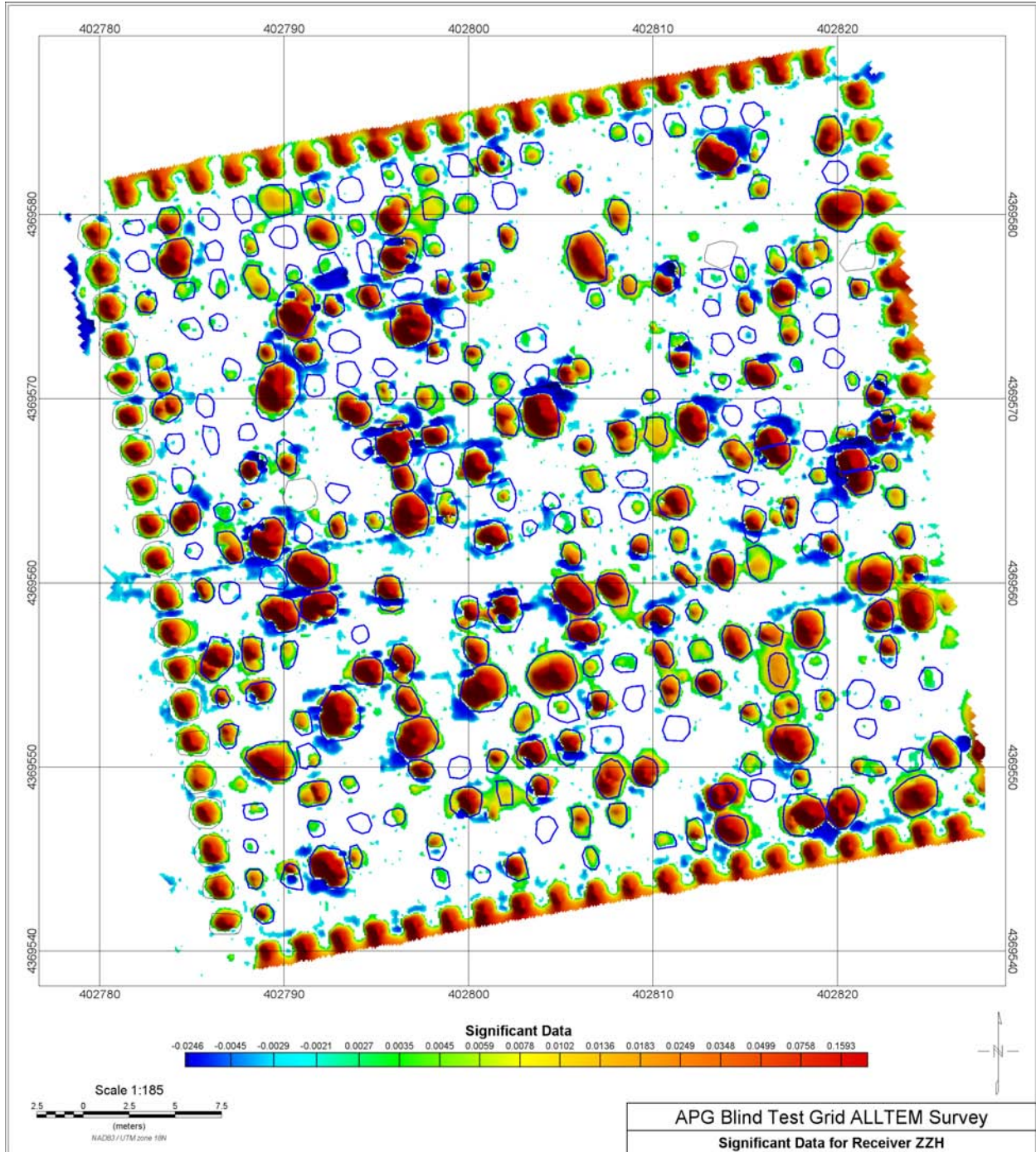

Appendix 2 – ALLTEM Data and Signal to Noise Maps

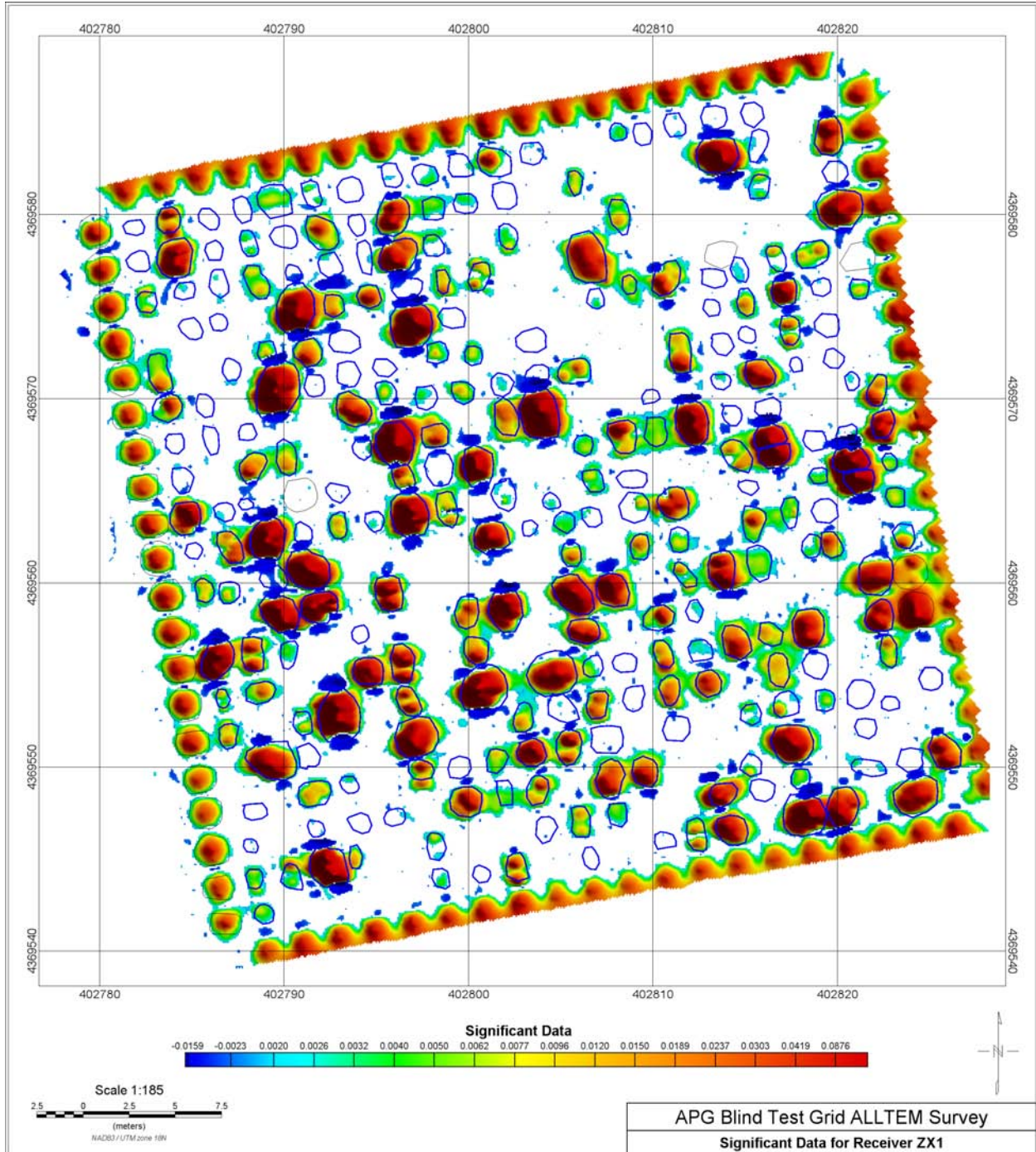

Appendix 2 – ALLTEM Data and Signal to Noise Maps

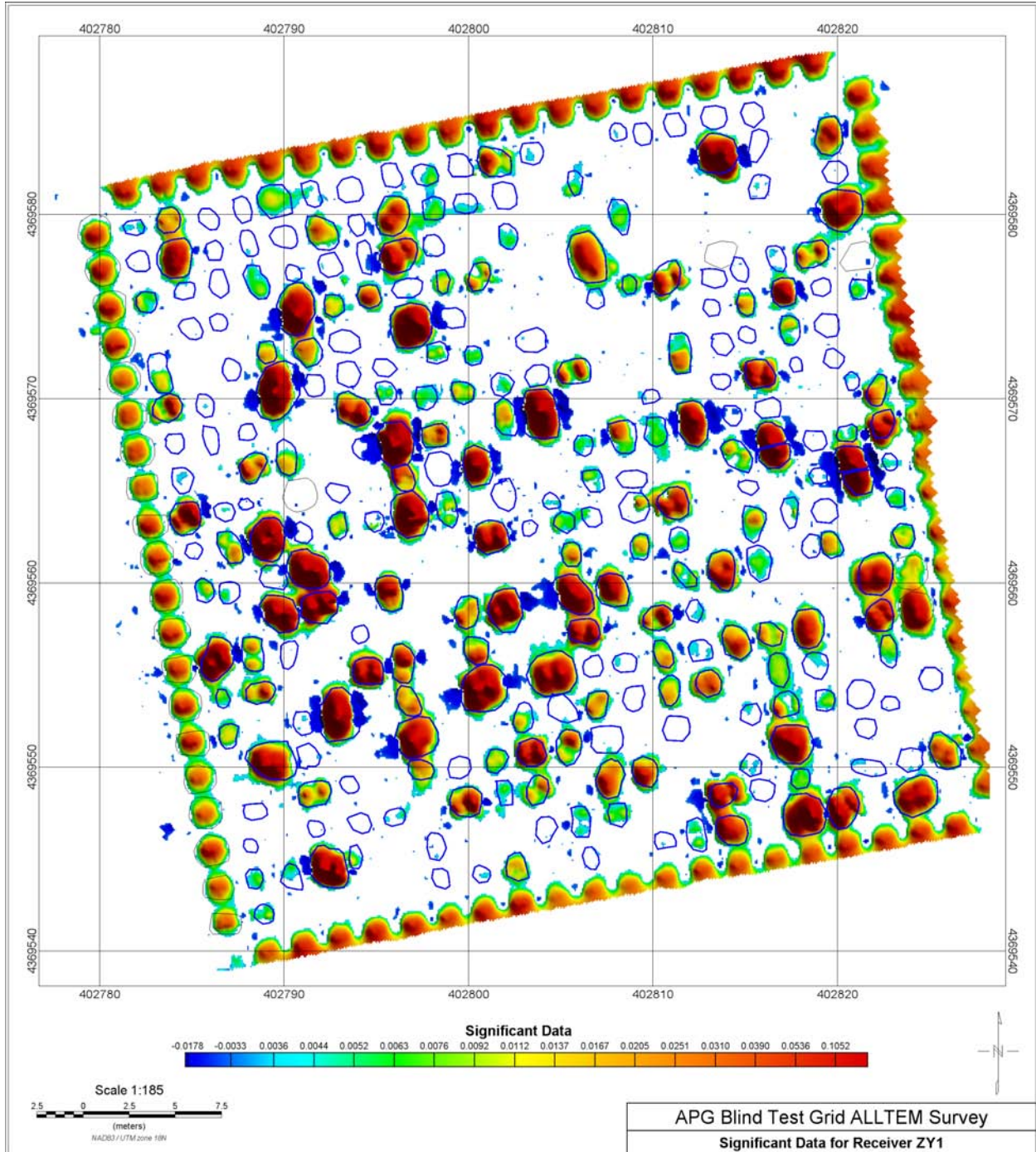

Appendix 2 – ALLTEM Data and Signal to Noise Maps

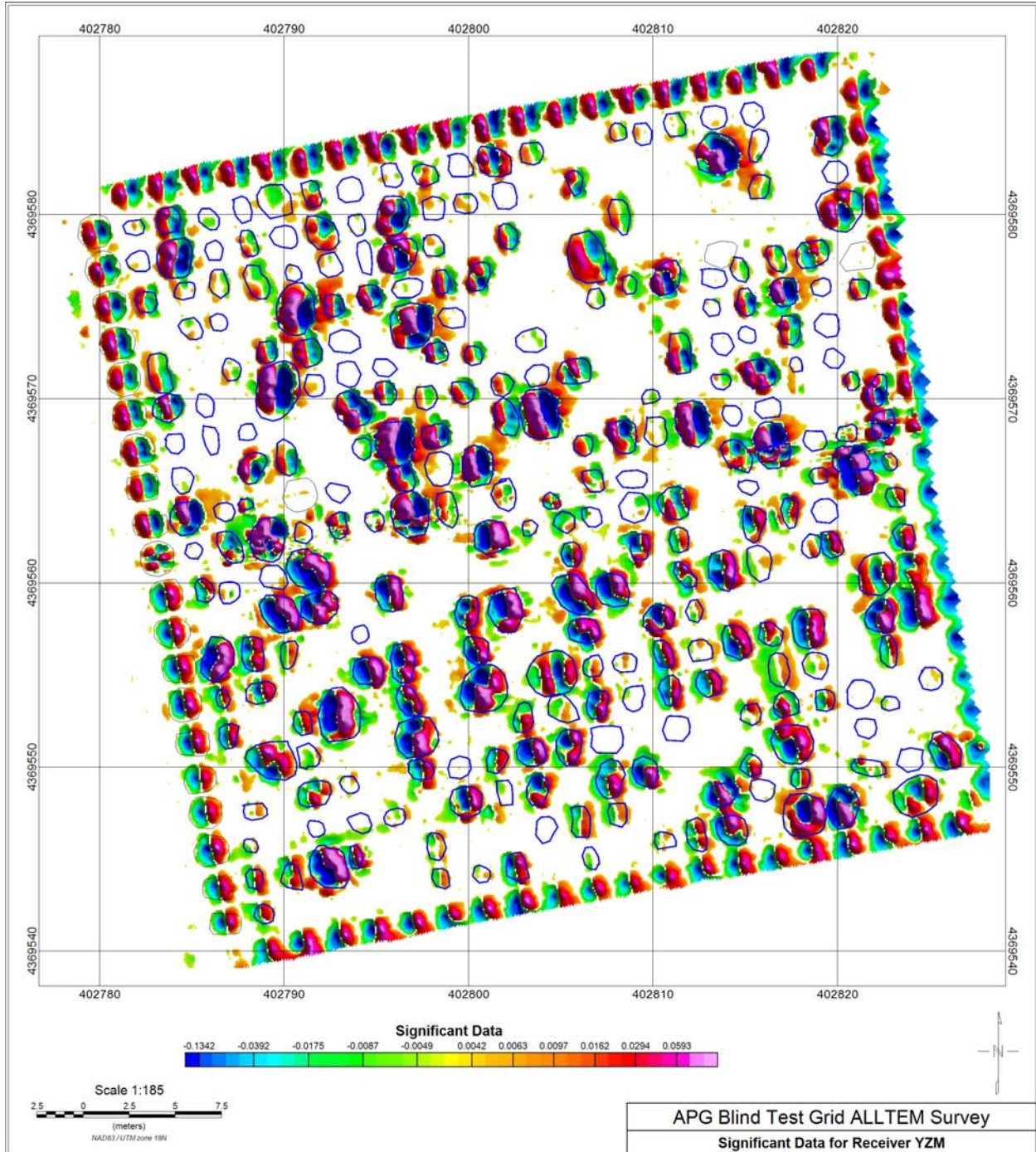

Appendix 2 – ALLTEM Data and Signal to Noise Maps

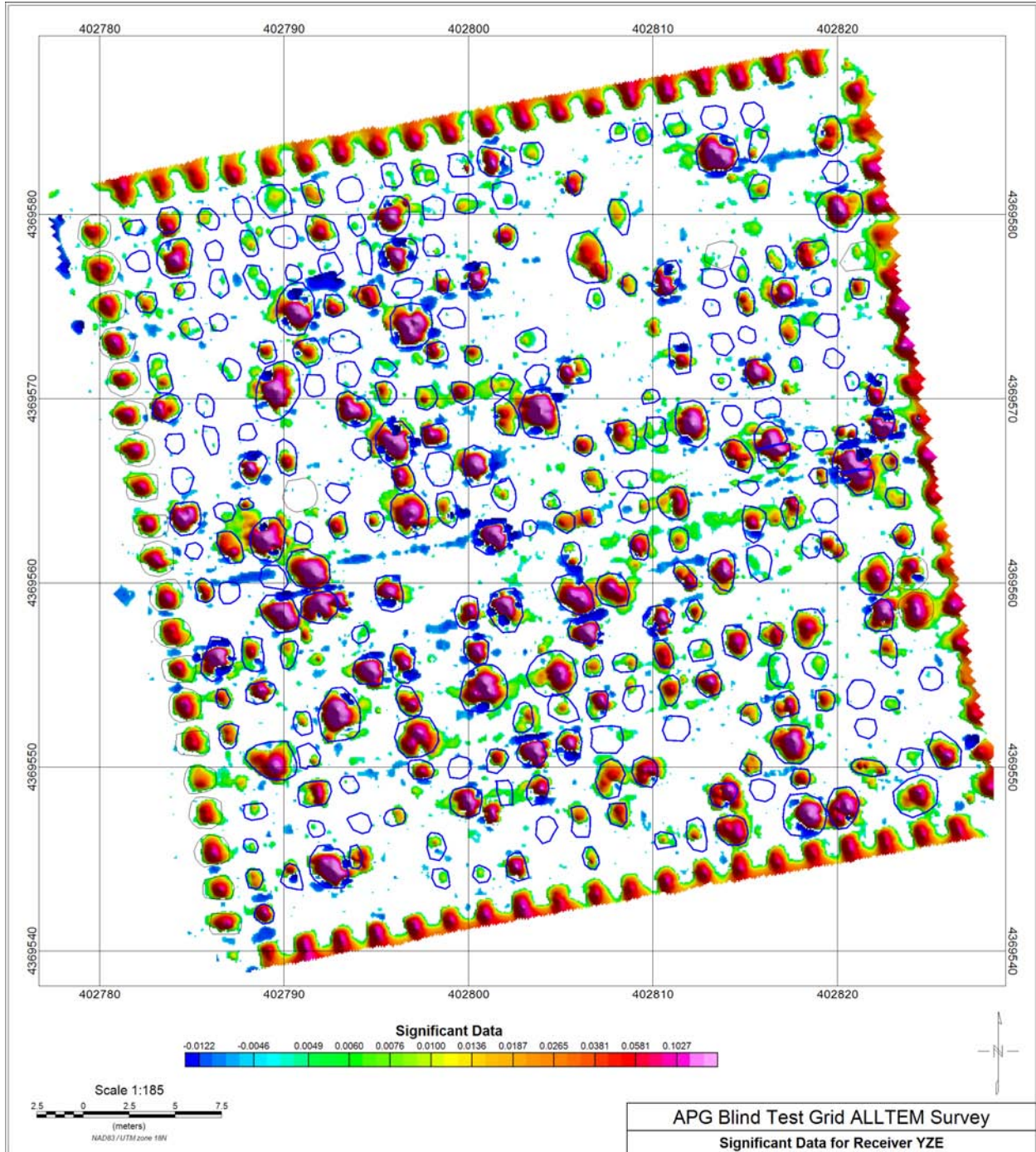

Appendix 2 – ALLTEM Data and Signal to Noise Maps

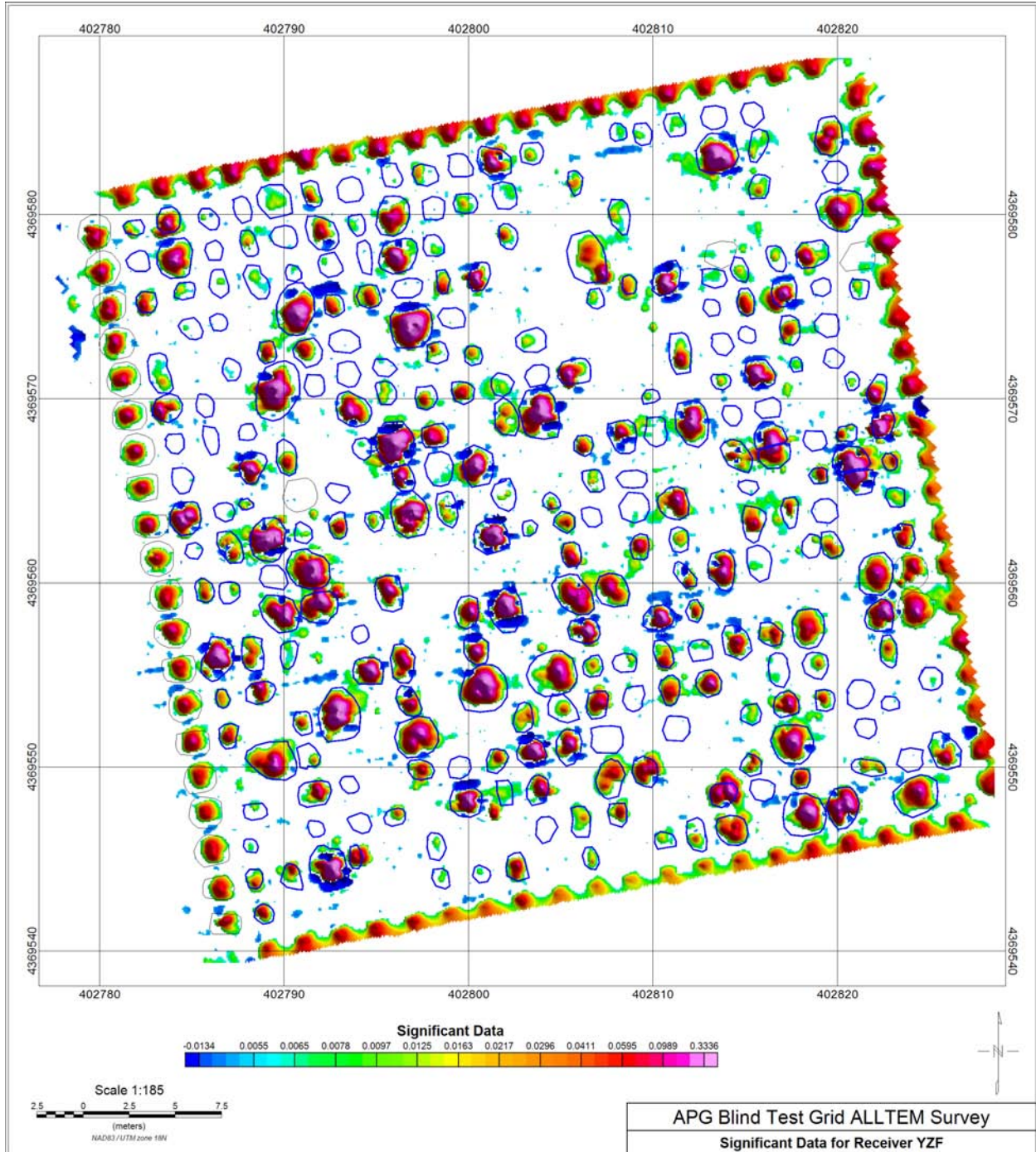

Appendix 2 – ALLTEM Data and Signal to Noise Maps

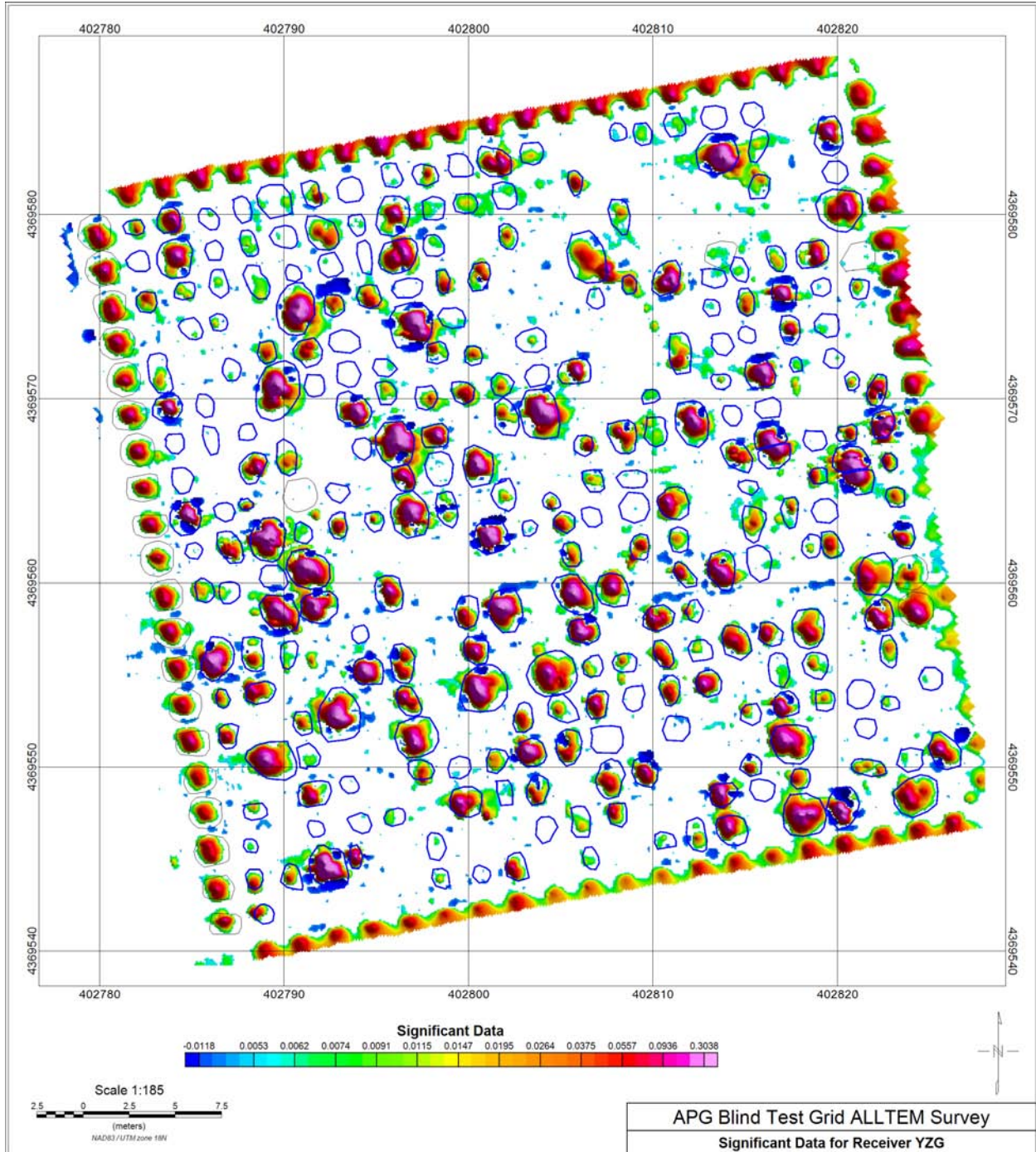

Appendix 2 – ALLTEM Data and Signal to Noise Maps

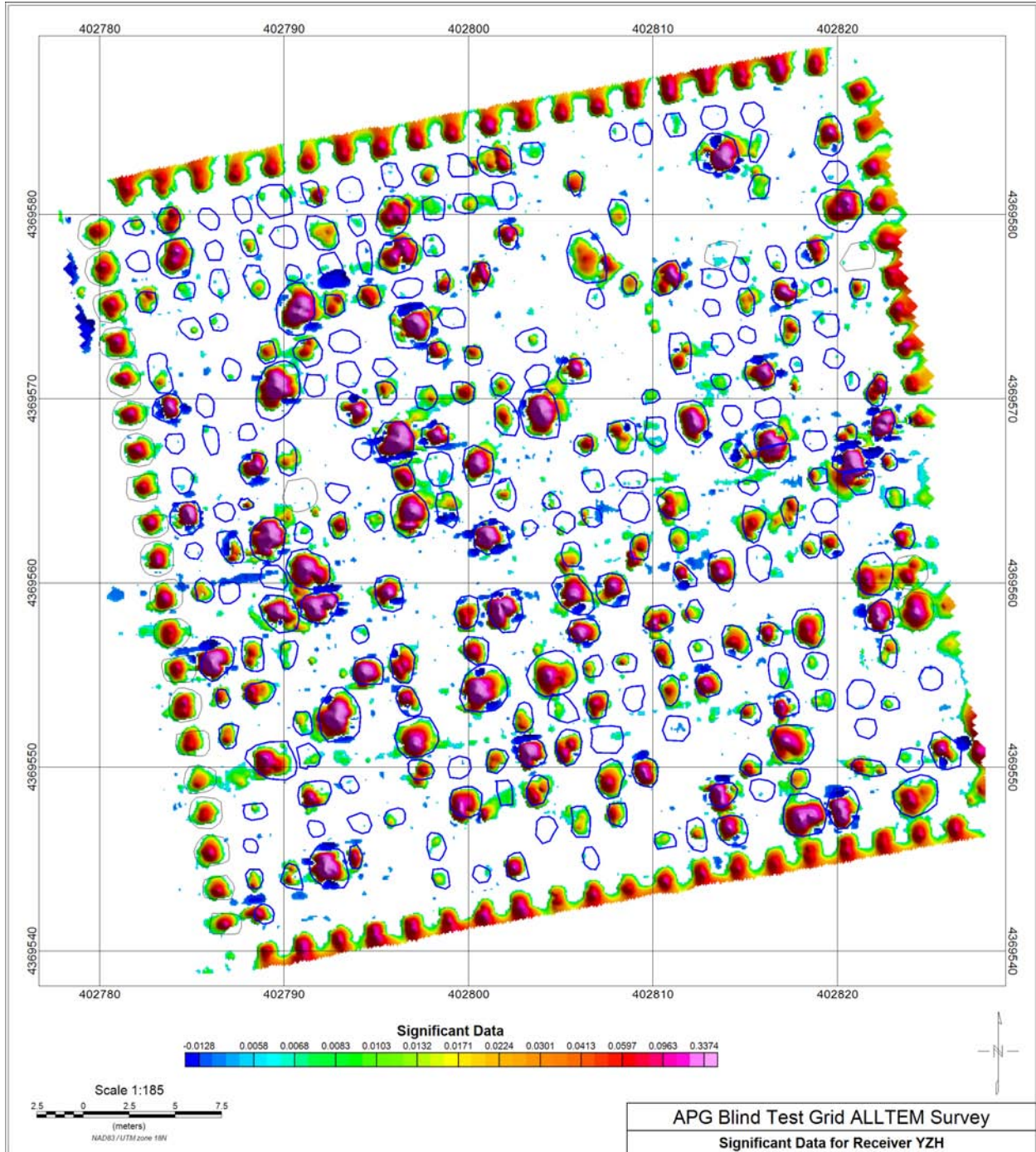

Appendix 2 – ALLTEM Data and Signal to Noise Maps

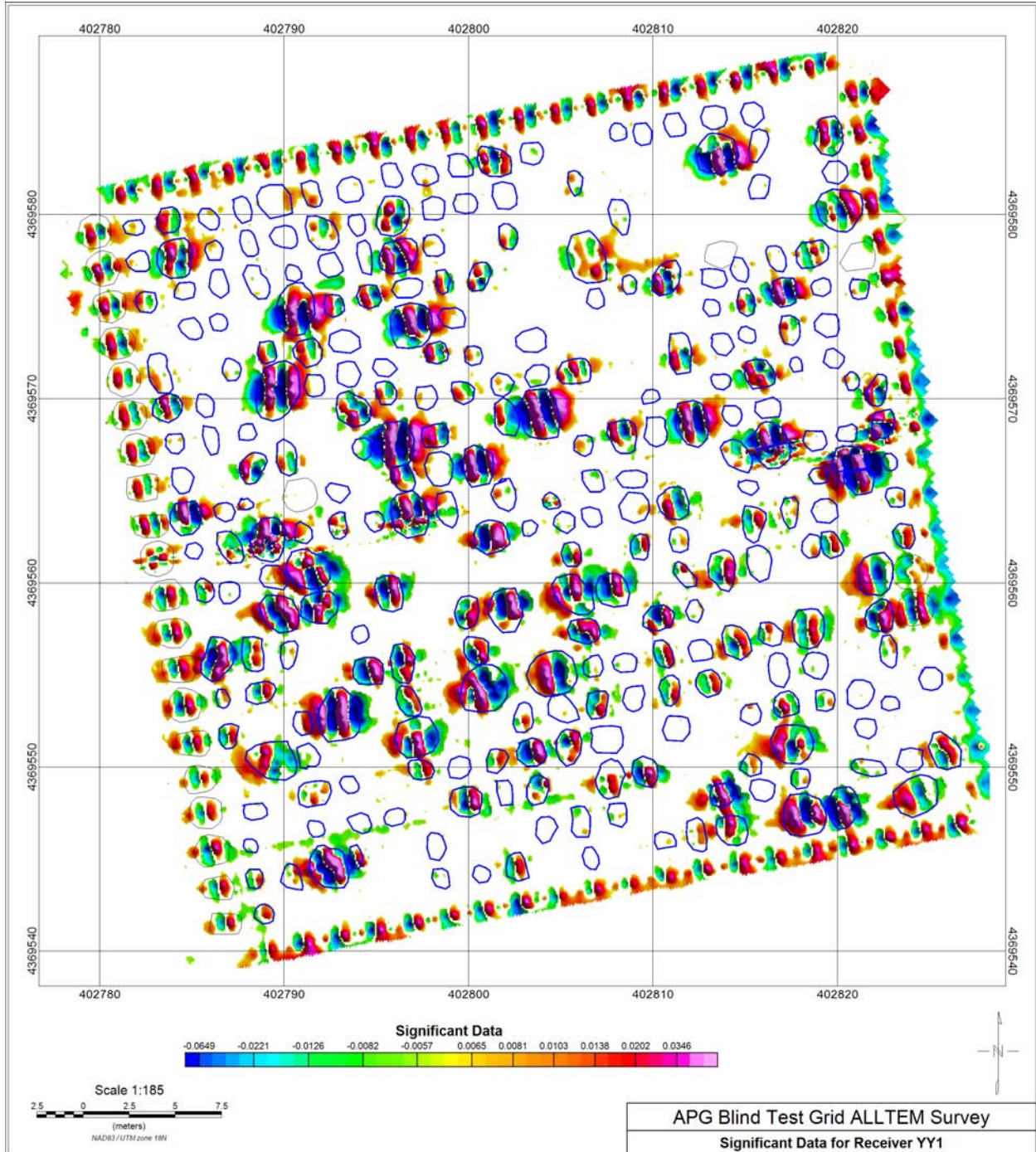

Appendix 2 – ALLTEM Data and Signal to Noise Maps

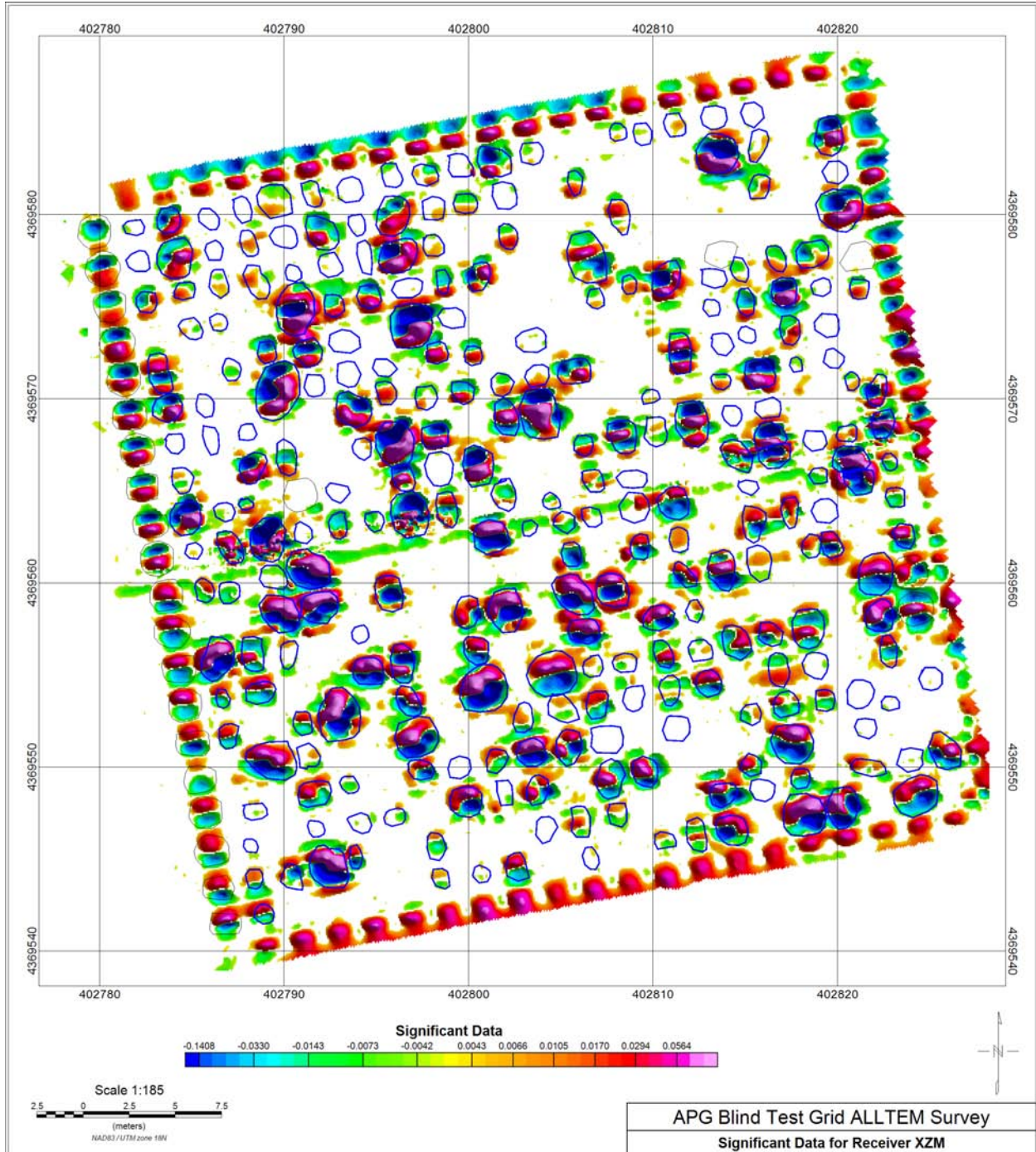

Appendix 2 – ALLTEM Data and Signal to Noise Maps

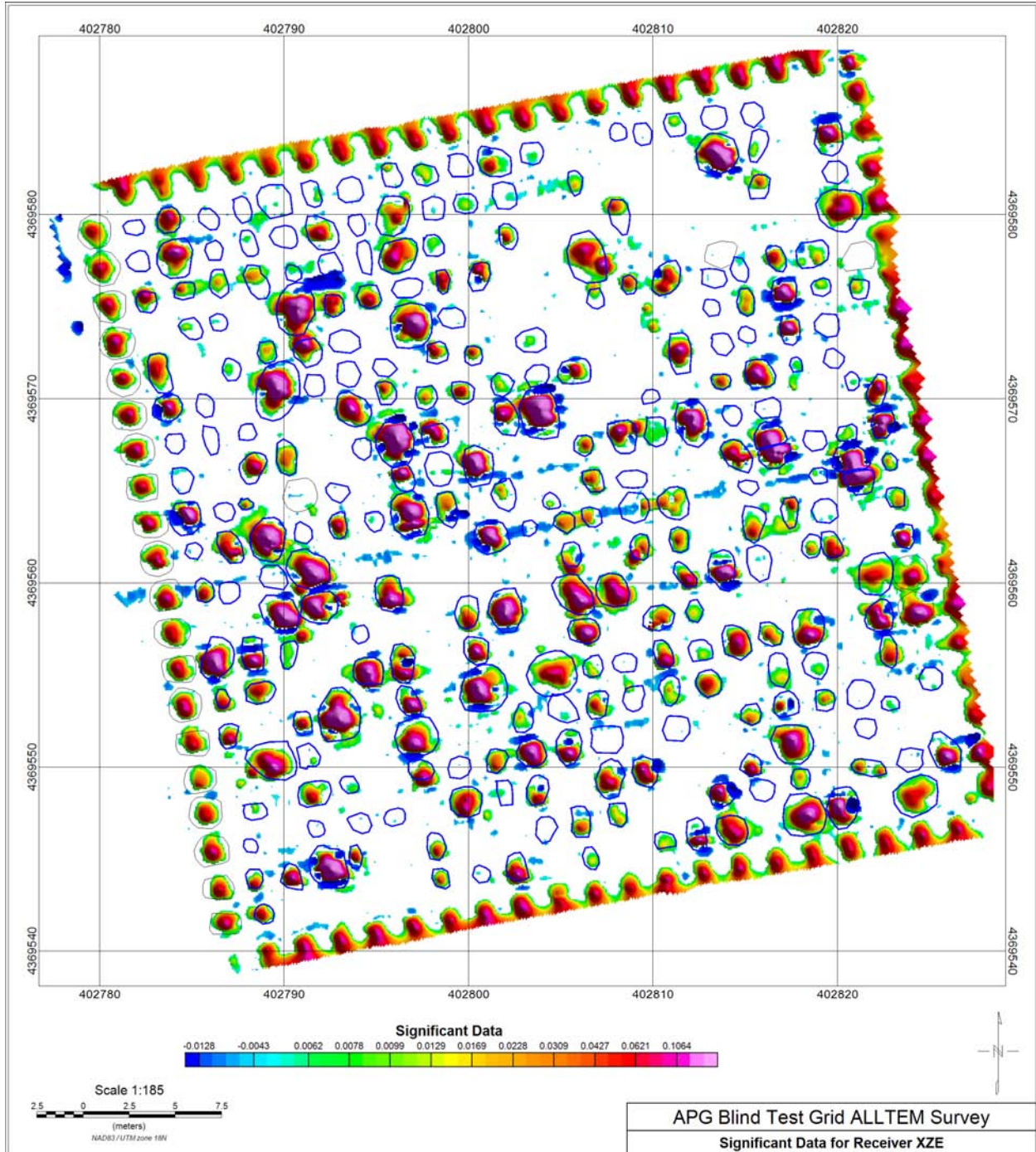

Appendix 2 – ALLTEM Data and Signal to Noise Maps

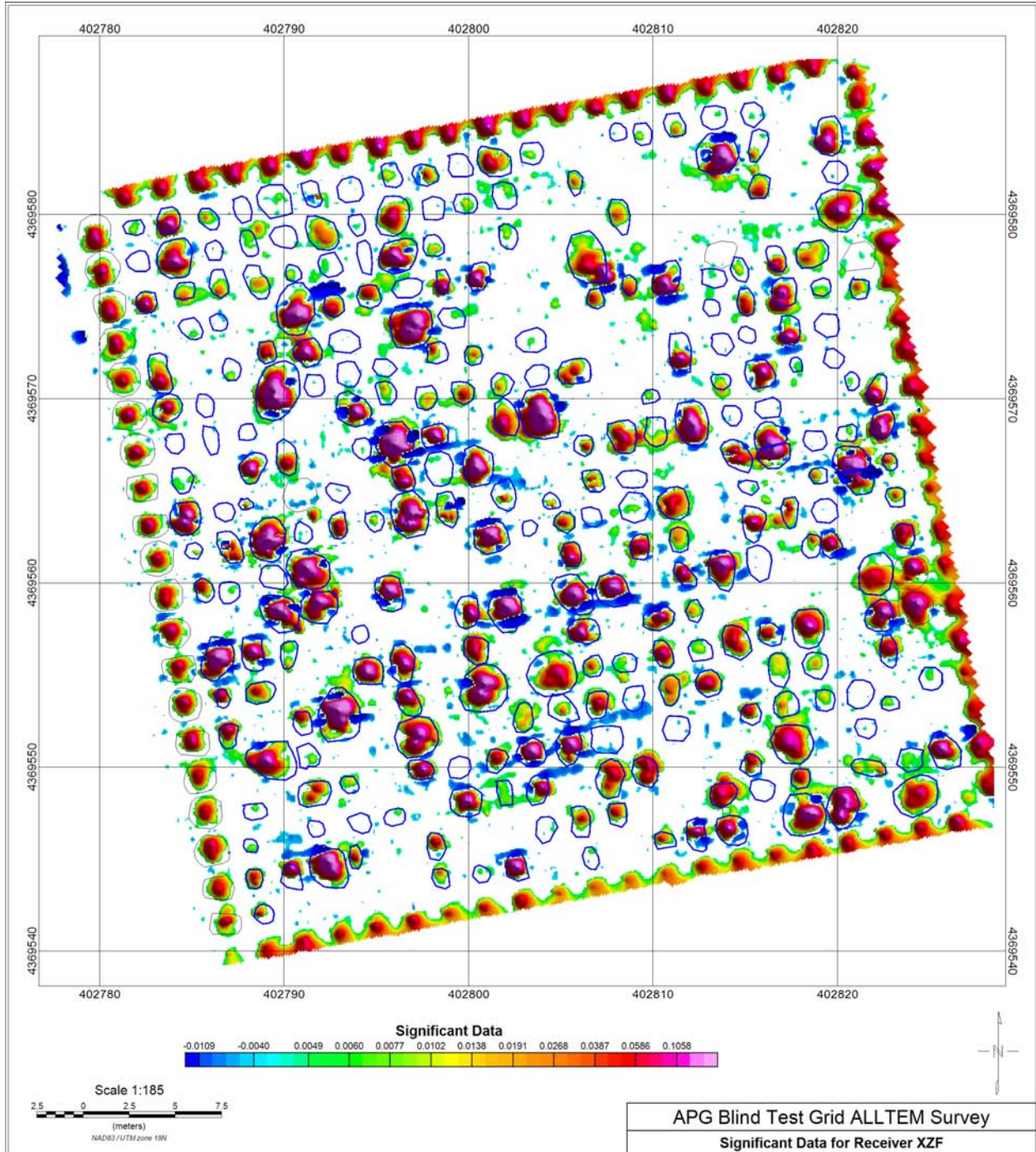

Appendix 2 – ALLTEM Data and Signal to Noise Maps

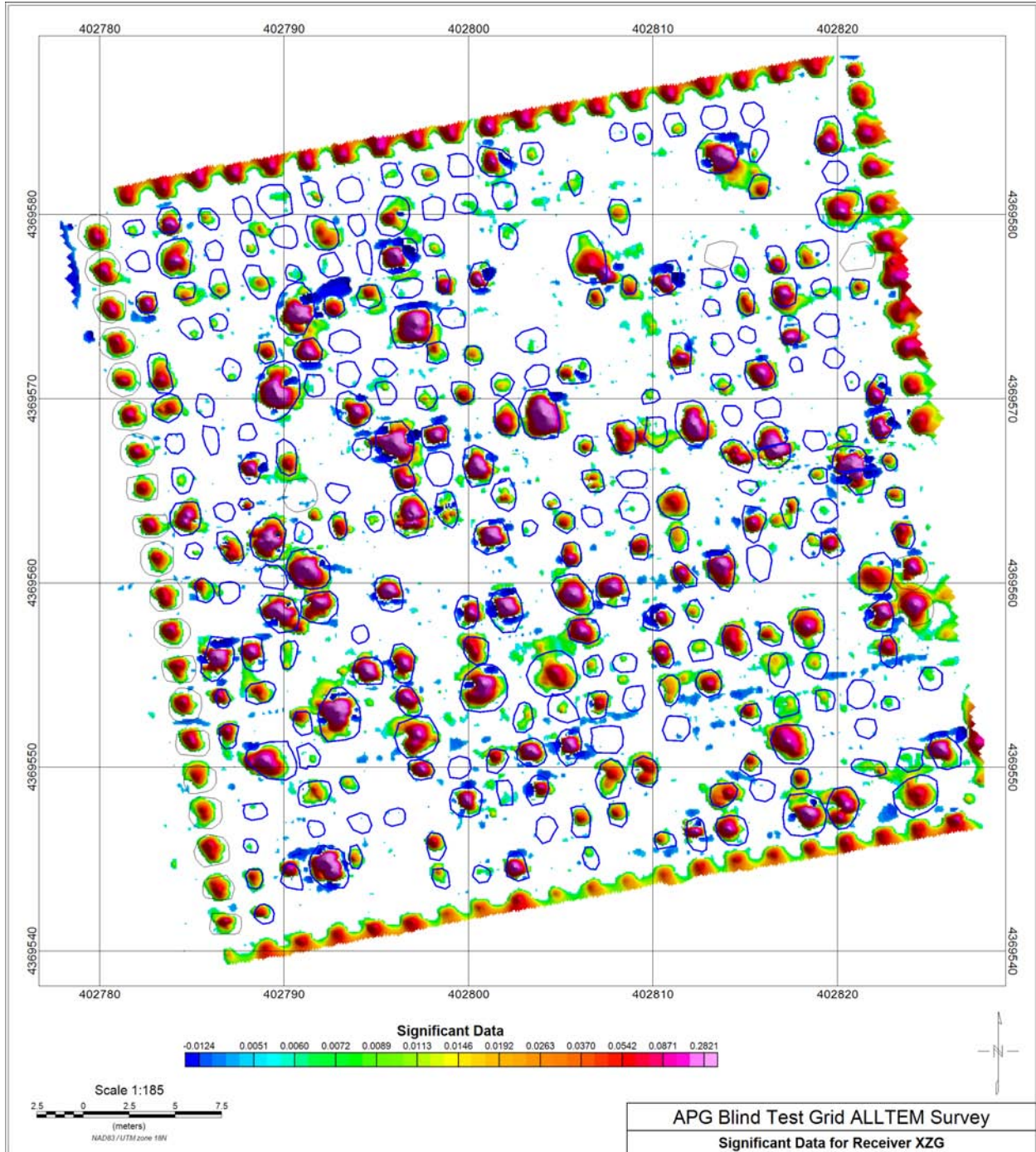

Appendix 2 – ALLTEM Data and Signal to Noise Maps

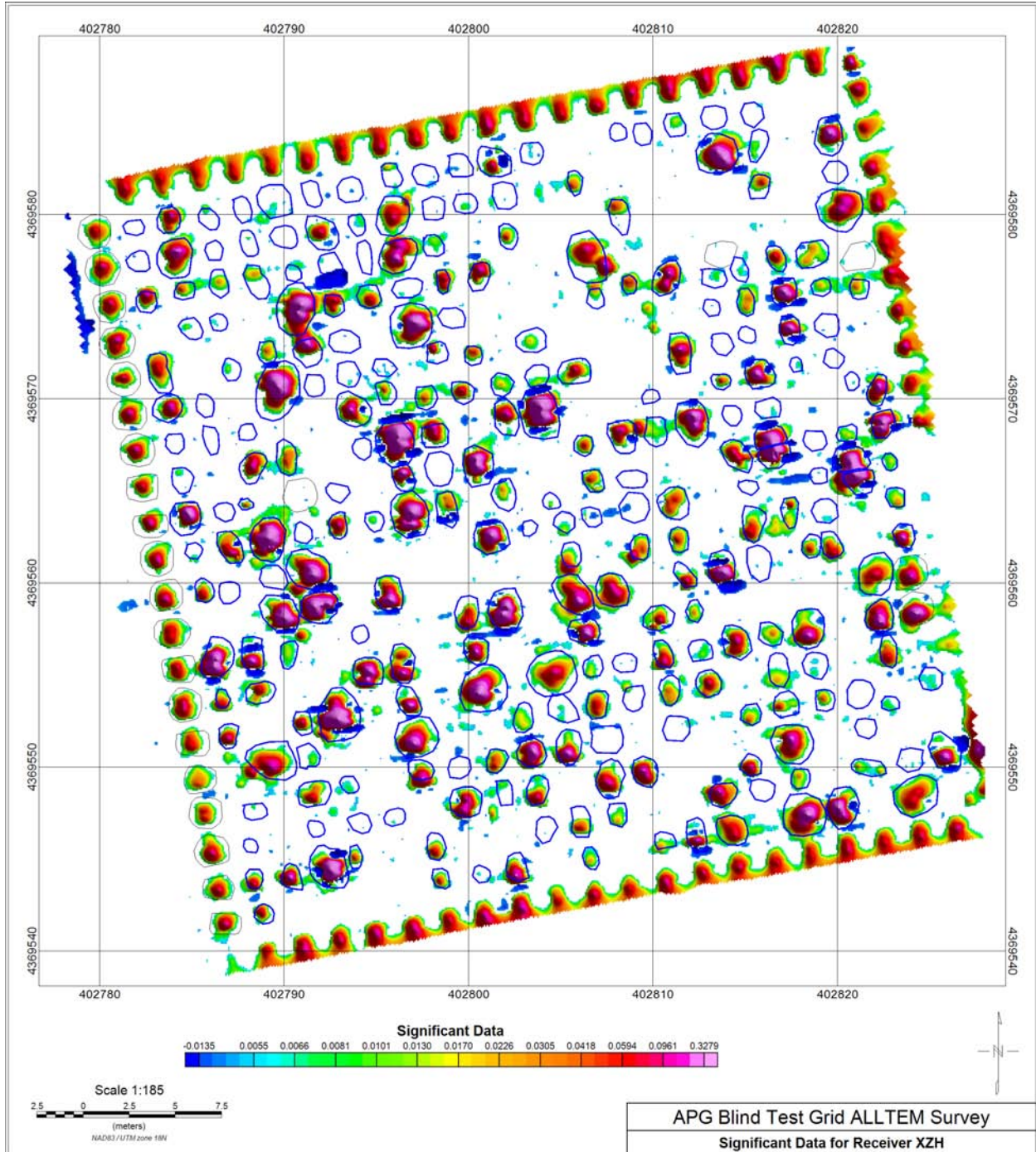

Appendix 2 – ALLTEM Data and Signal to Noise Maps

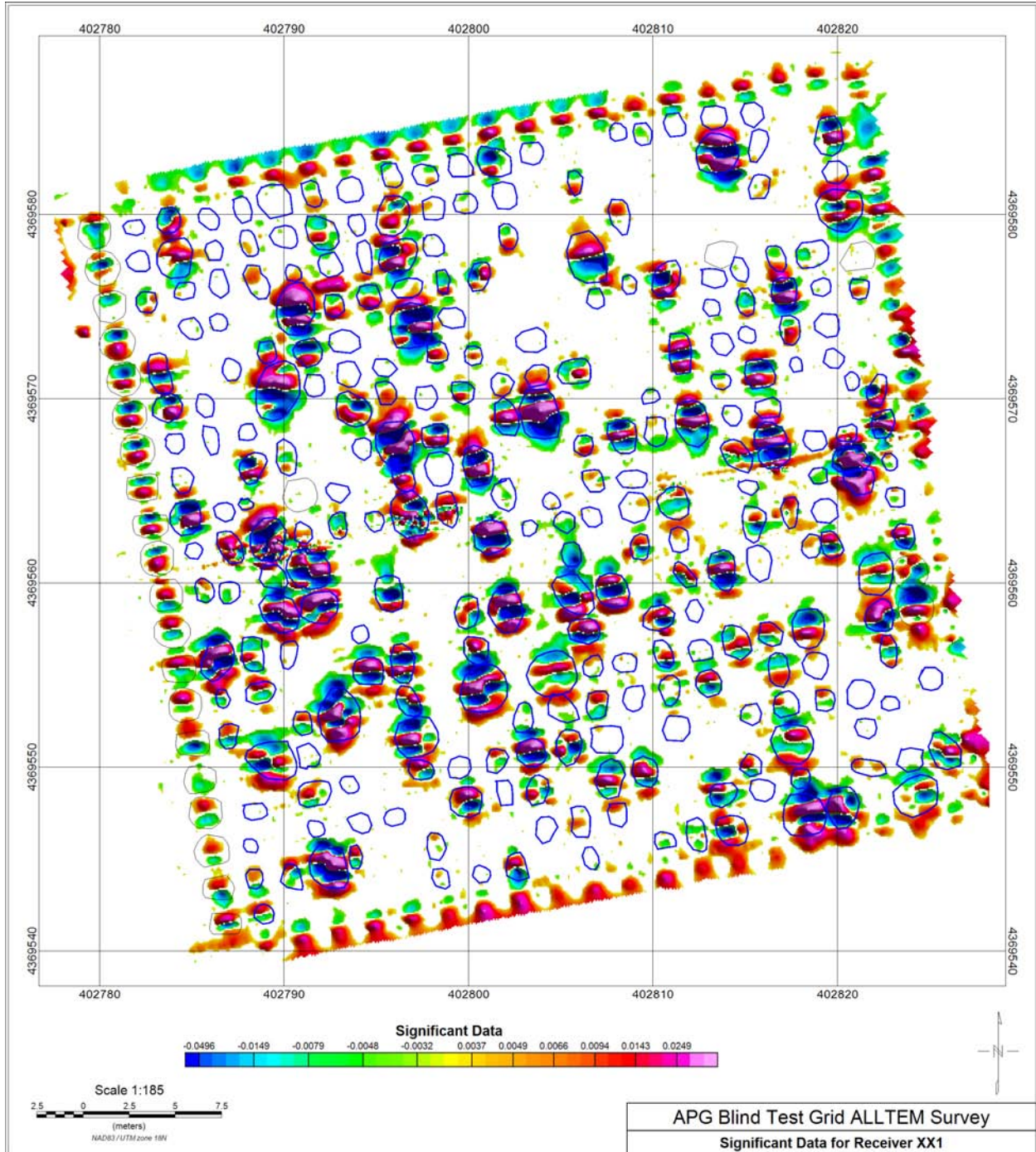

Appendix 2 – ALLTEM Data and Signal to Noise Maps

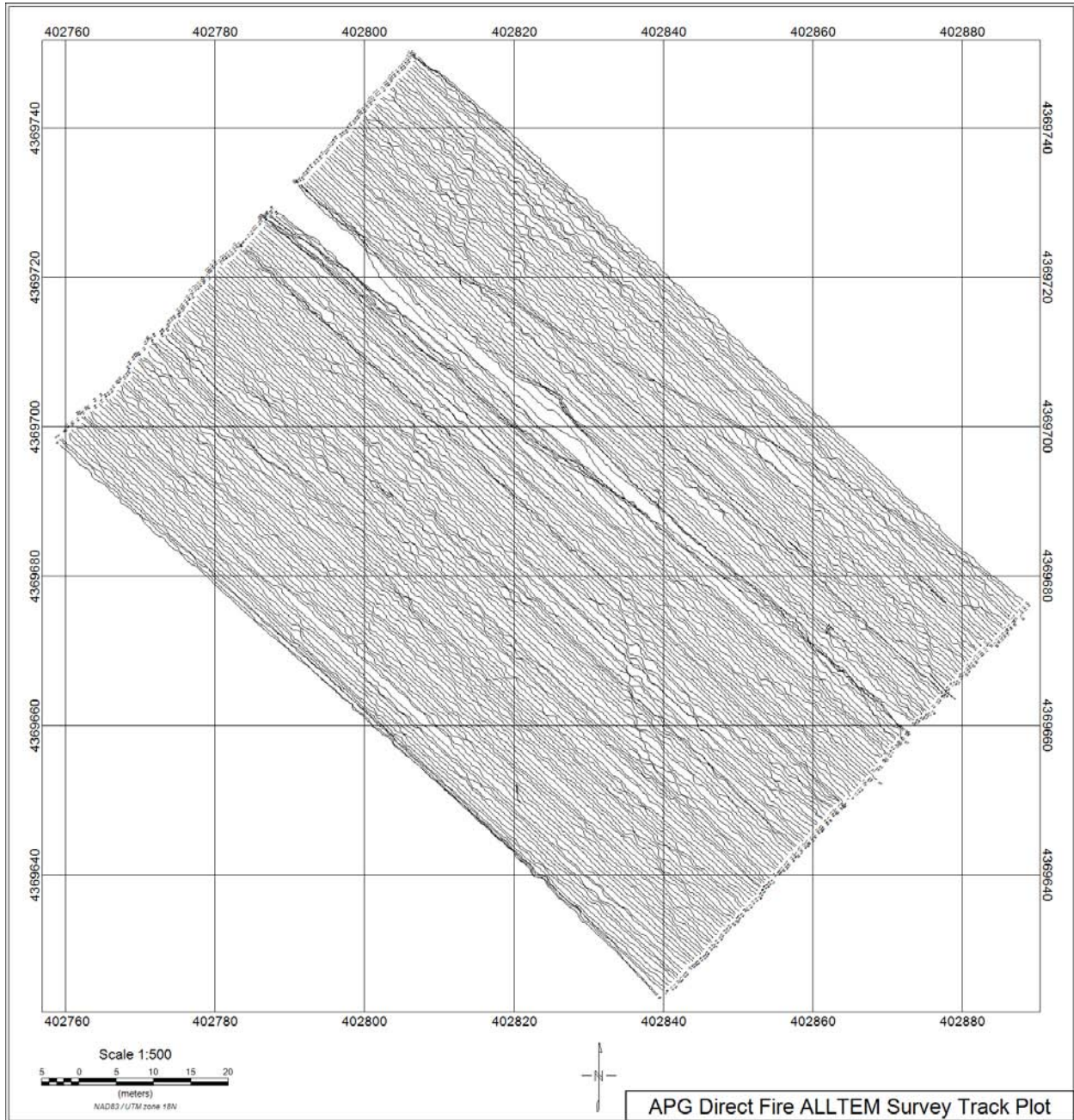

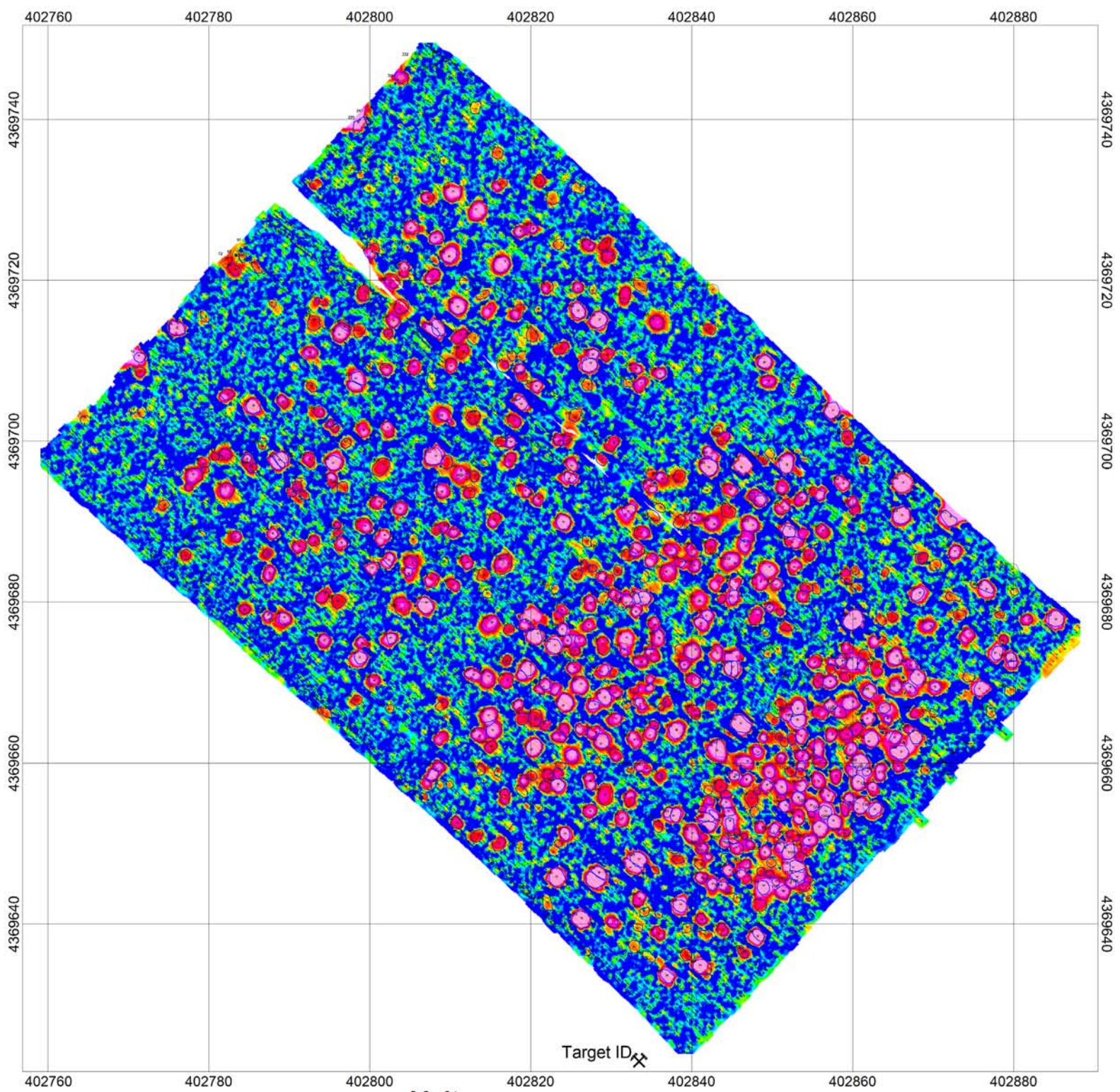

Volts

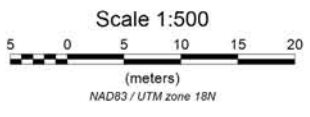
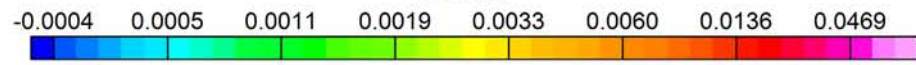

APG Direct Fire Area ALLTEM Survey
ZZM Receiver Numbered Patch Map

Appendix 2 – ALLTEM Data and Signal to Noise Maps

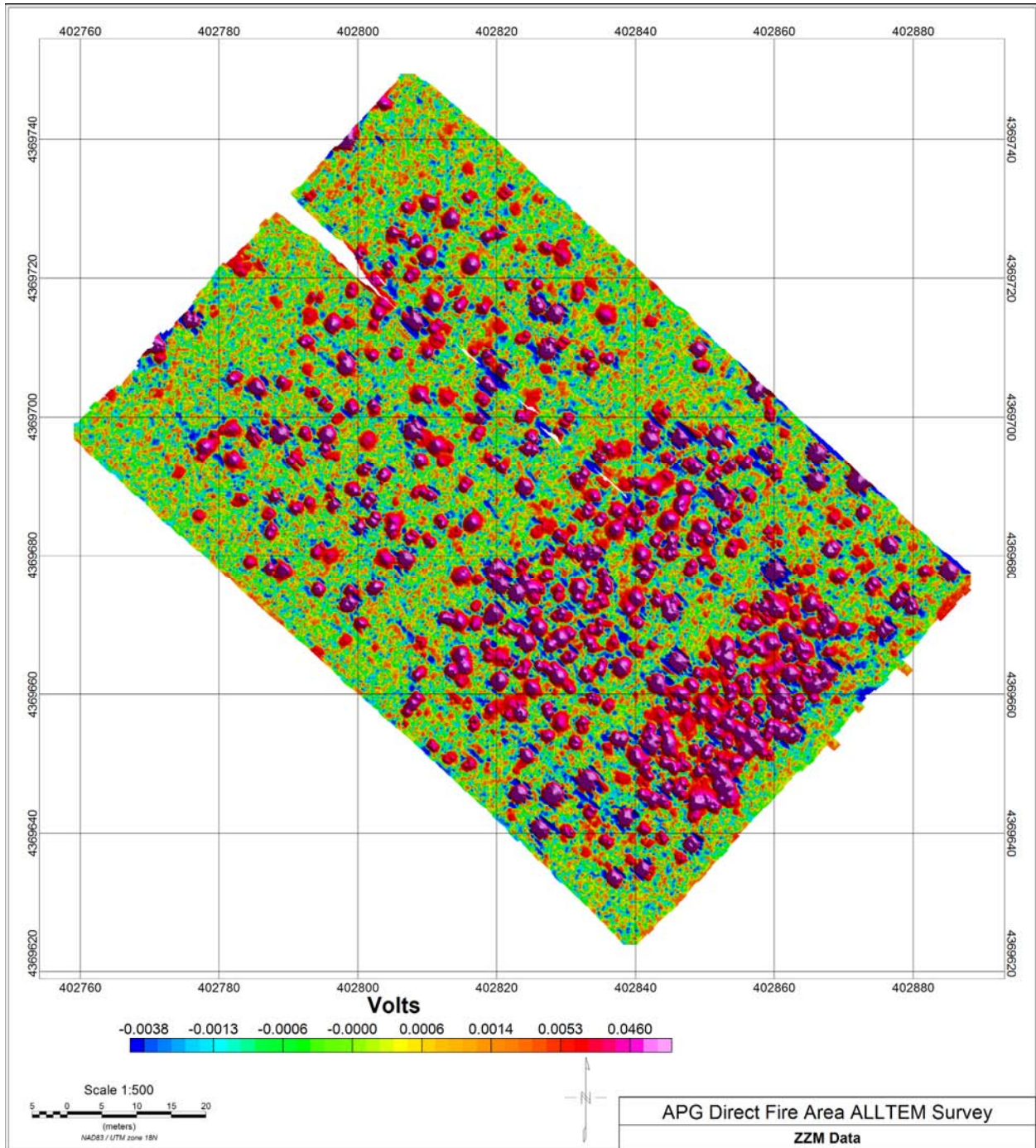

Appendix 2 – ALLTEM Data and Signal to Noise Maps

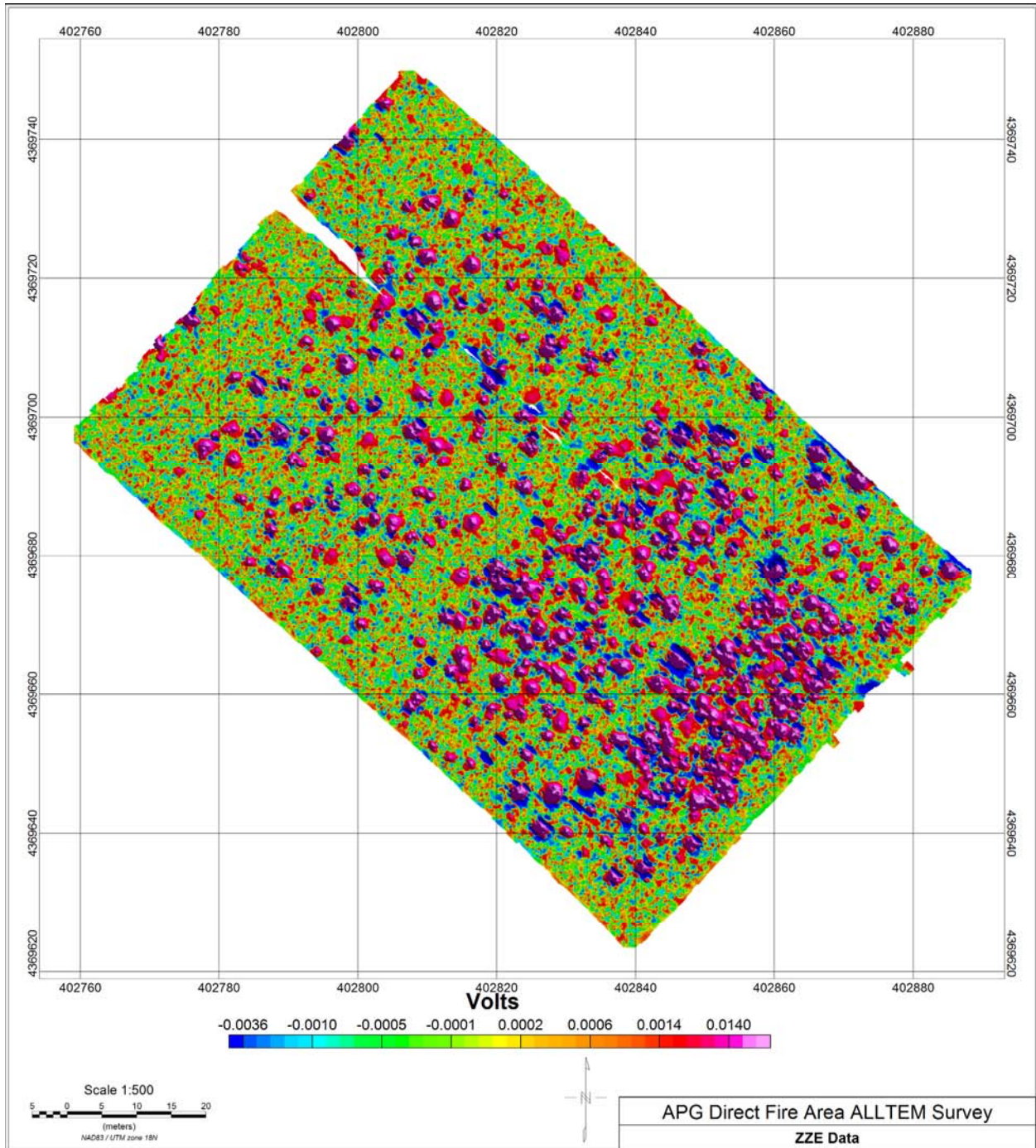

Appendix 2 – ALLTEM Data and Signal to Noise Maps

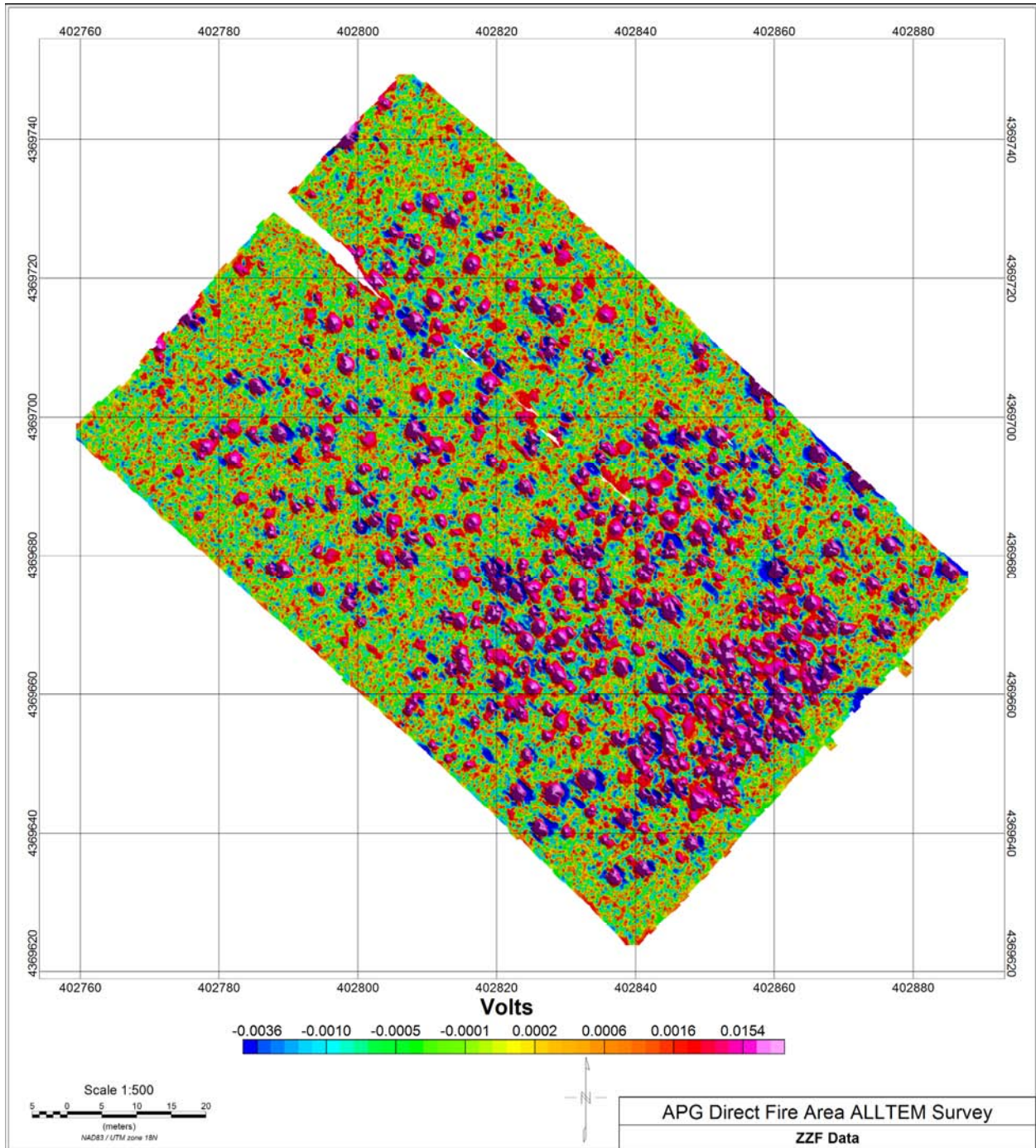

Appendix 2 – ALLTEM Data and Signal to Noise Maps

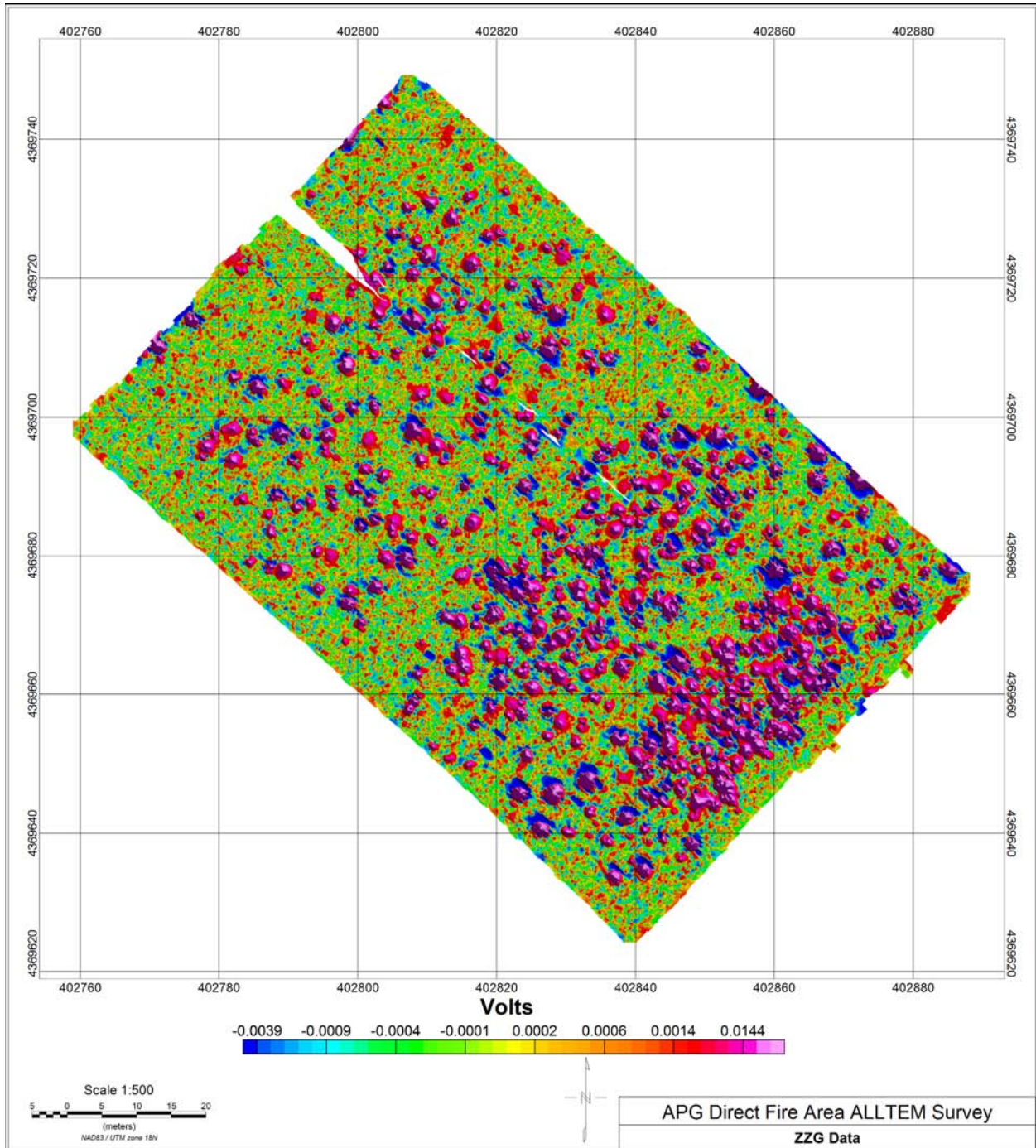

Appendix 2 – ALLTEM Data and Signal to Noise Maps

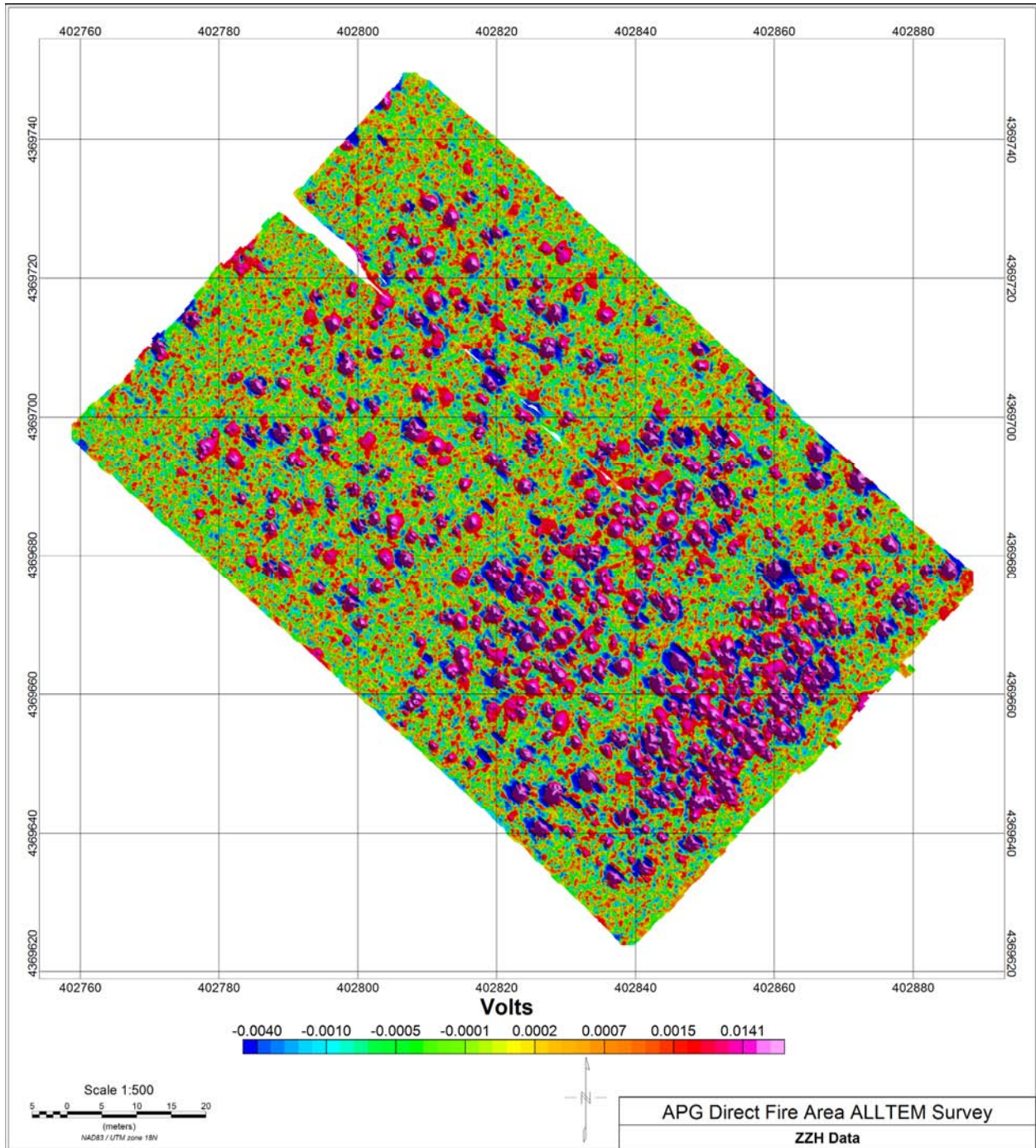

Appendix 2 – ALLTEM Data and Signal to Noise Maps

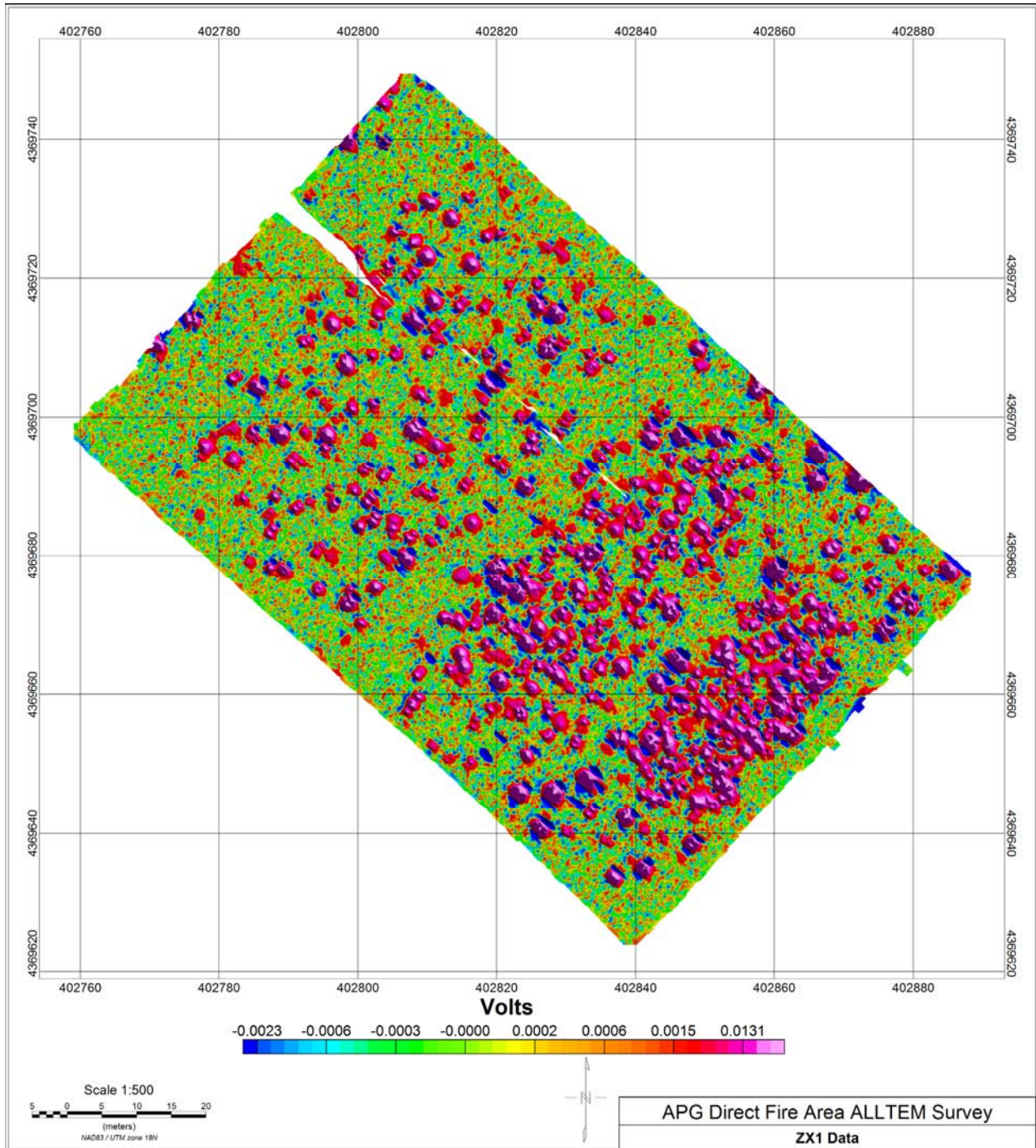

Appendix 2 – ALLTEM Data and Signal to Noise Maps

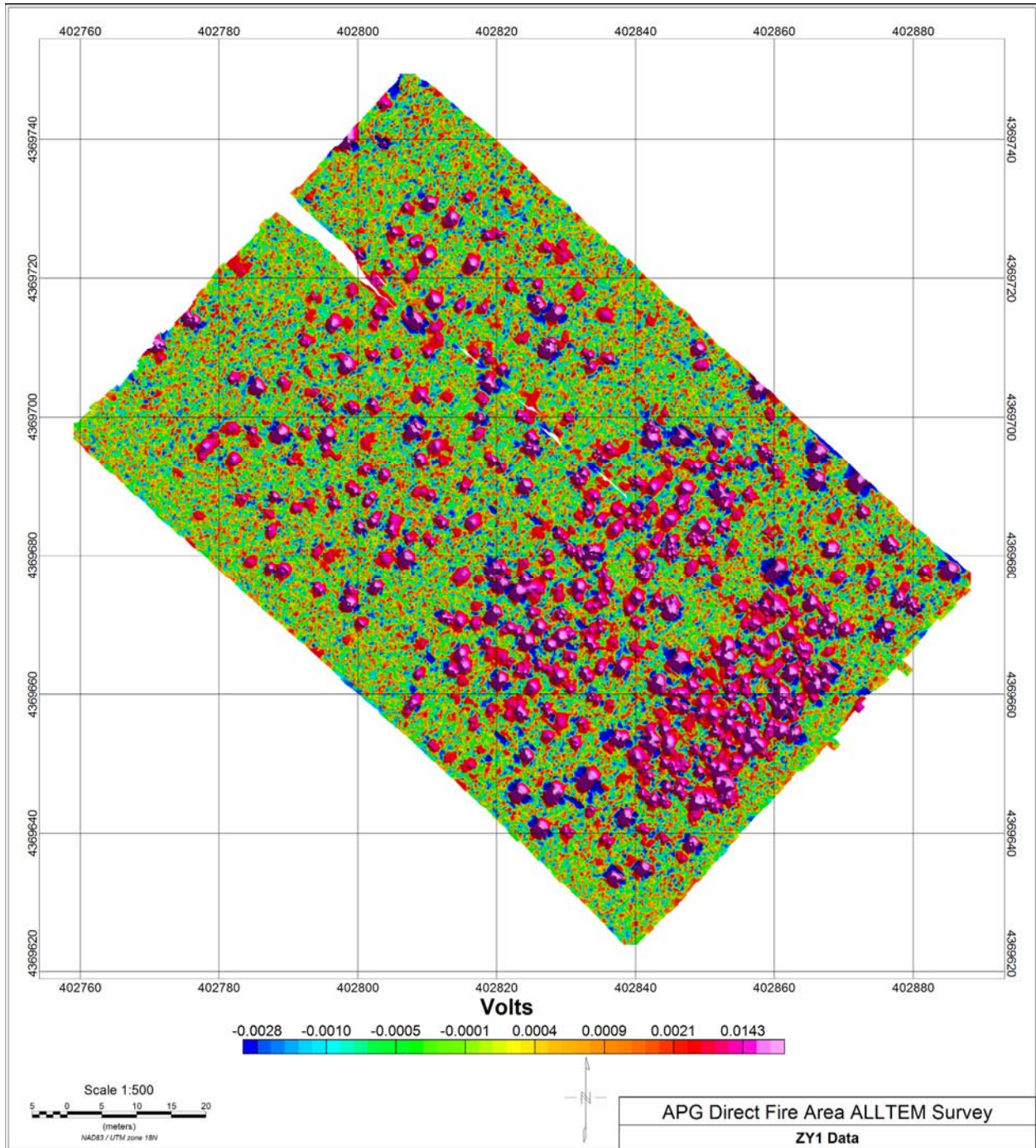

Appendix 2 – ALLTEM Data and Signal to Noise Maps

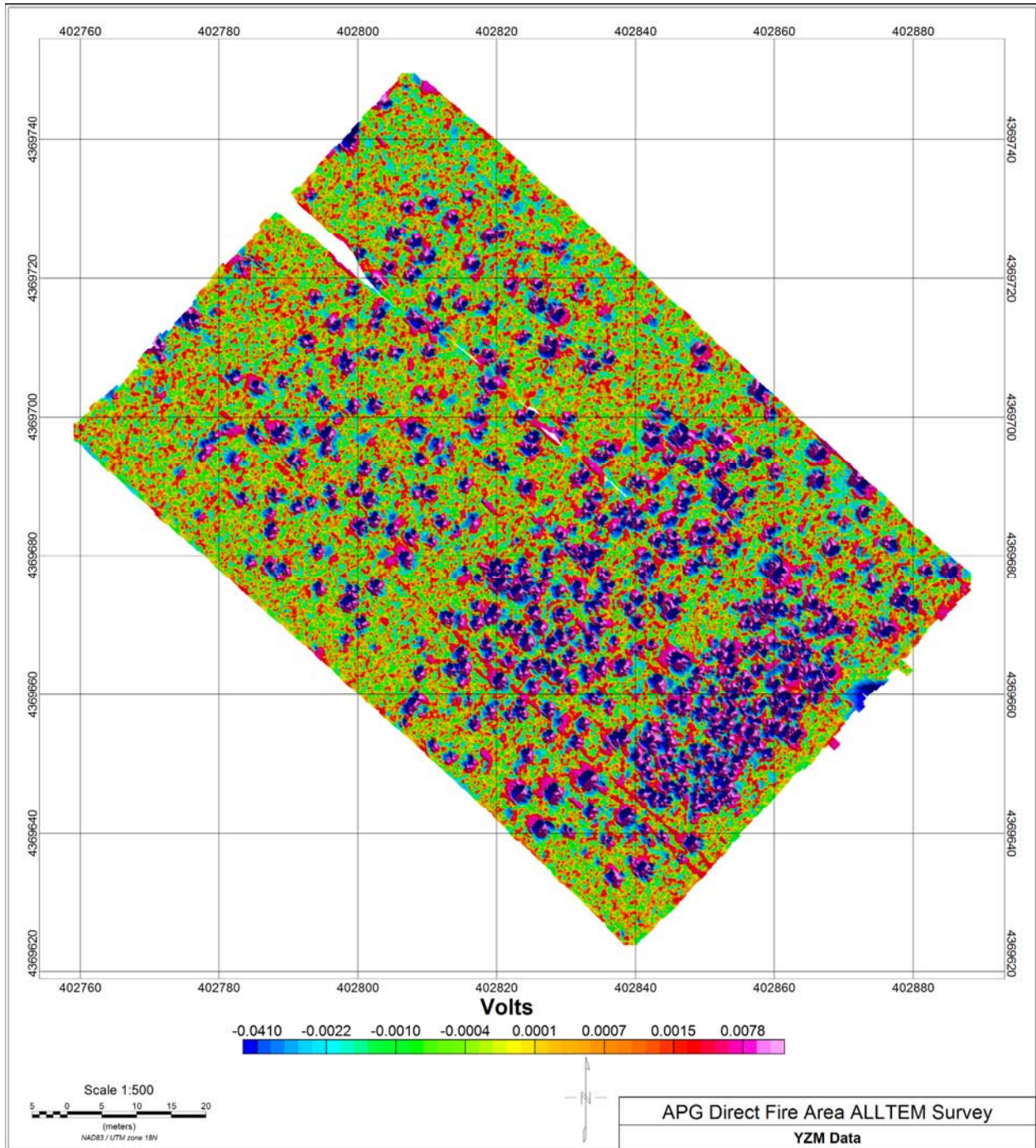

Appendix 2 – ALLTEM Data and Signal to Noise Maps

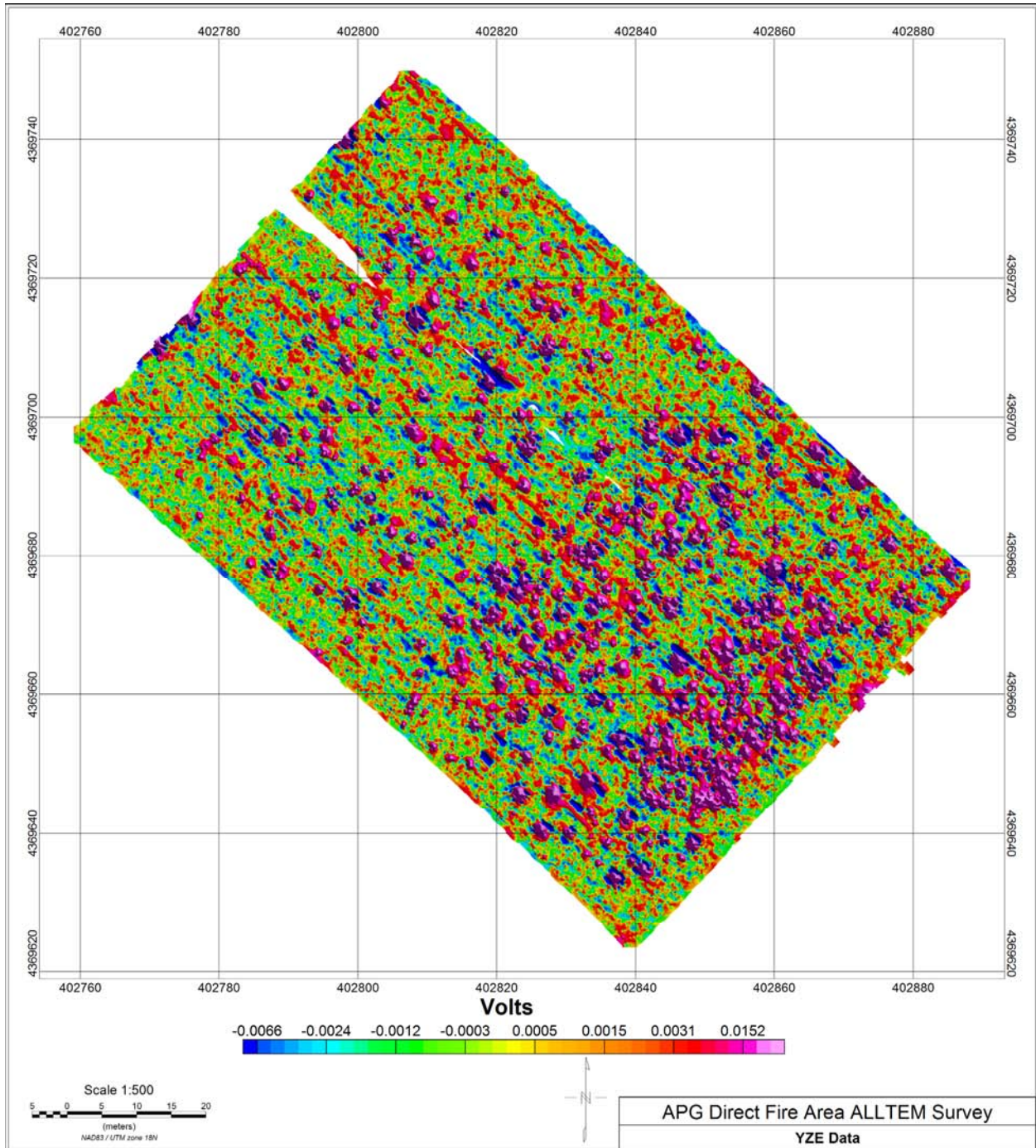

Appendix 2 – ALLTEM Data and Signal to Noise Maps

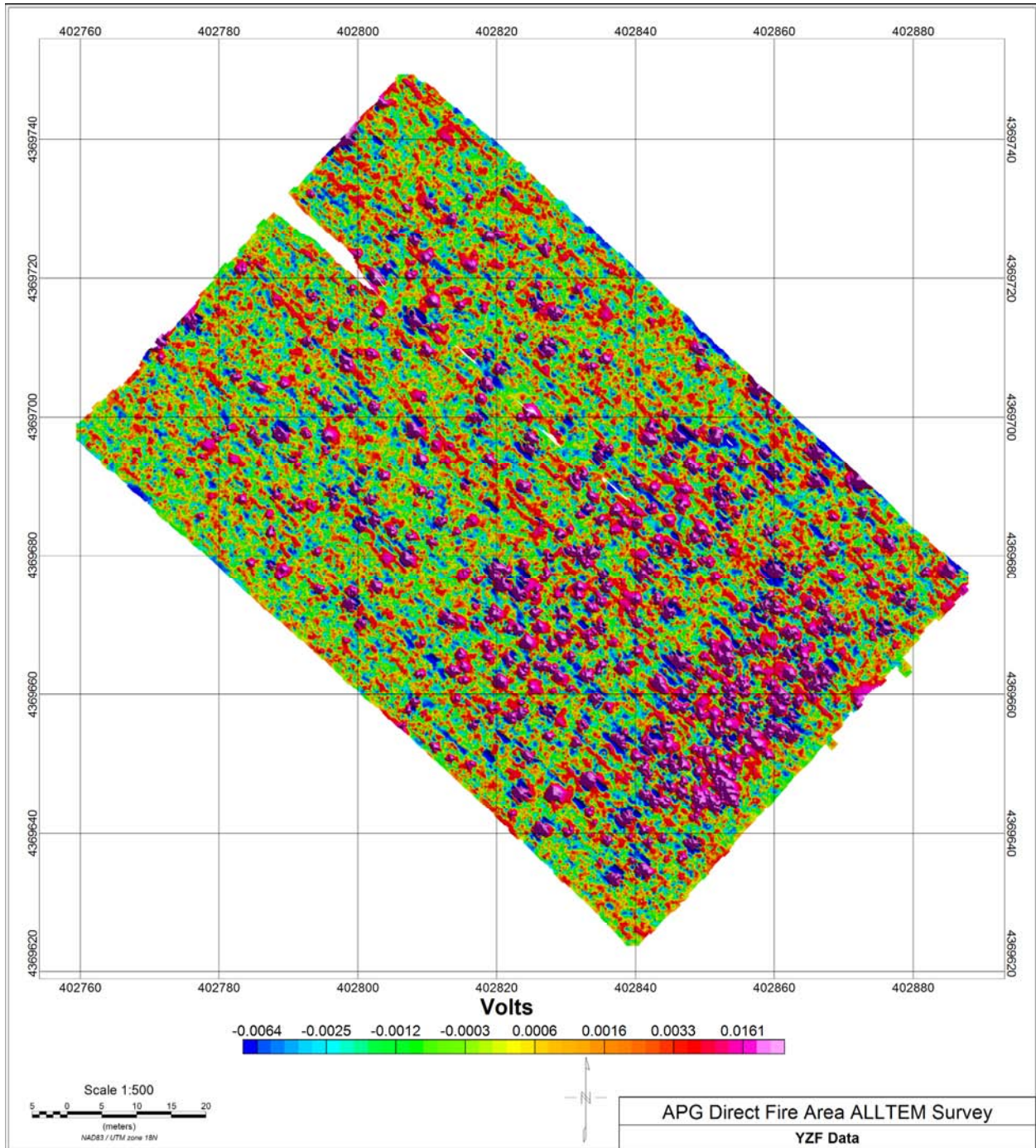

Appendix 2 – ALLTEM Data and Signal to Noise Maps

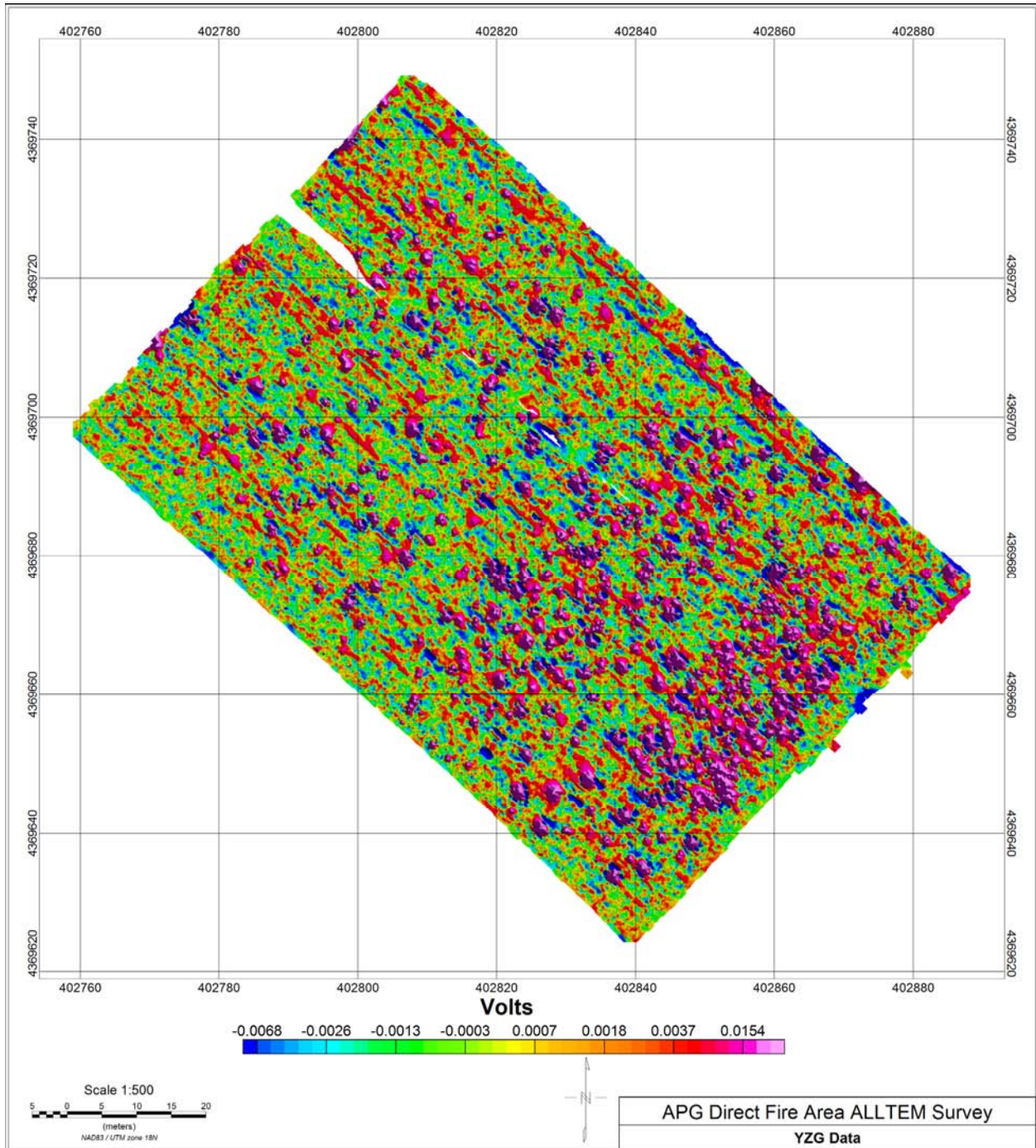

Appendix 2 – ALLTEM Data and Signal to Noise Maps

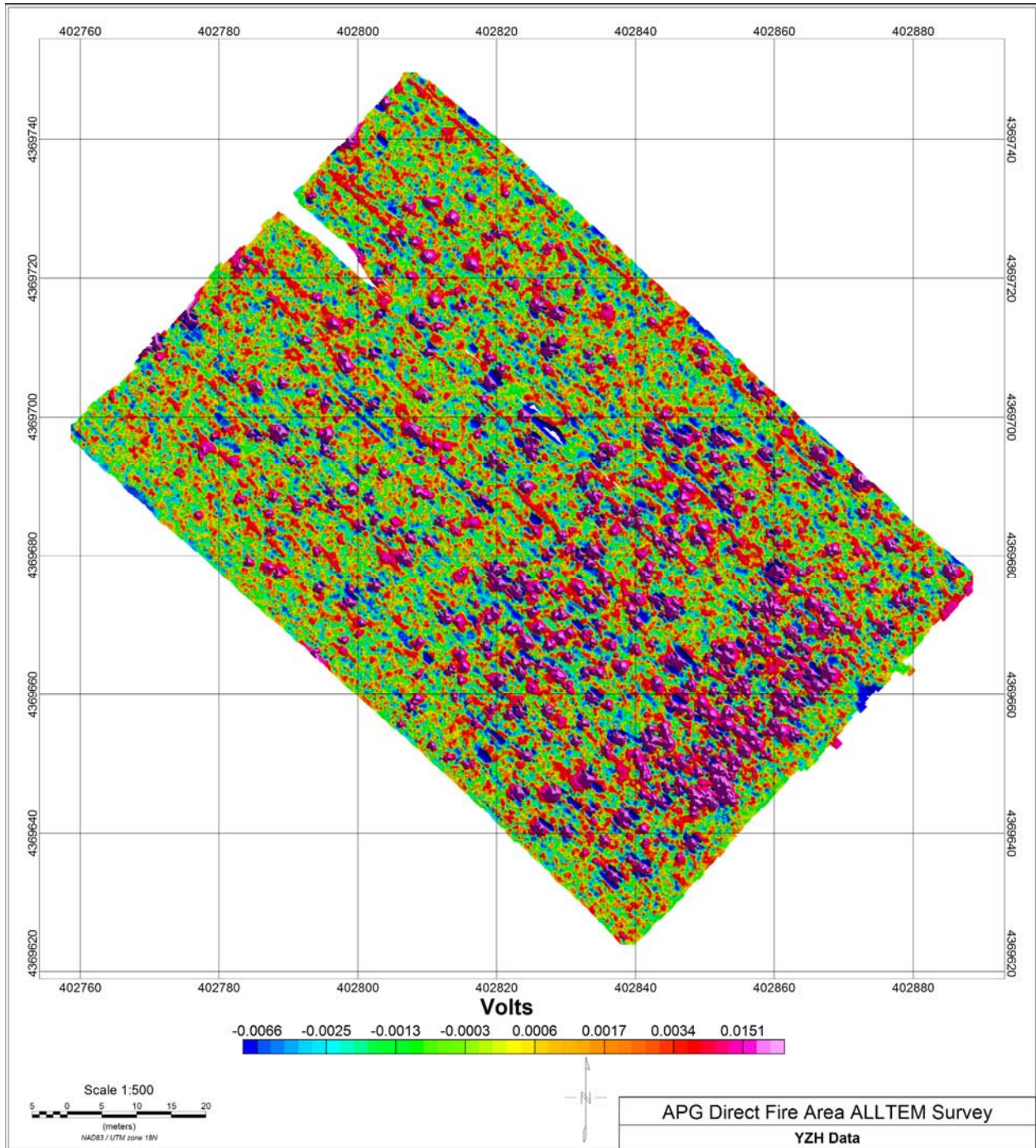

Appendix 2 – ALLTEM Data and Signal to Noise Maps

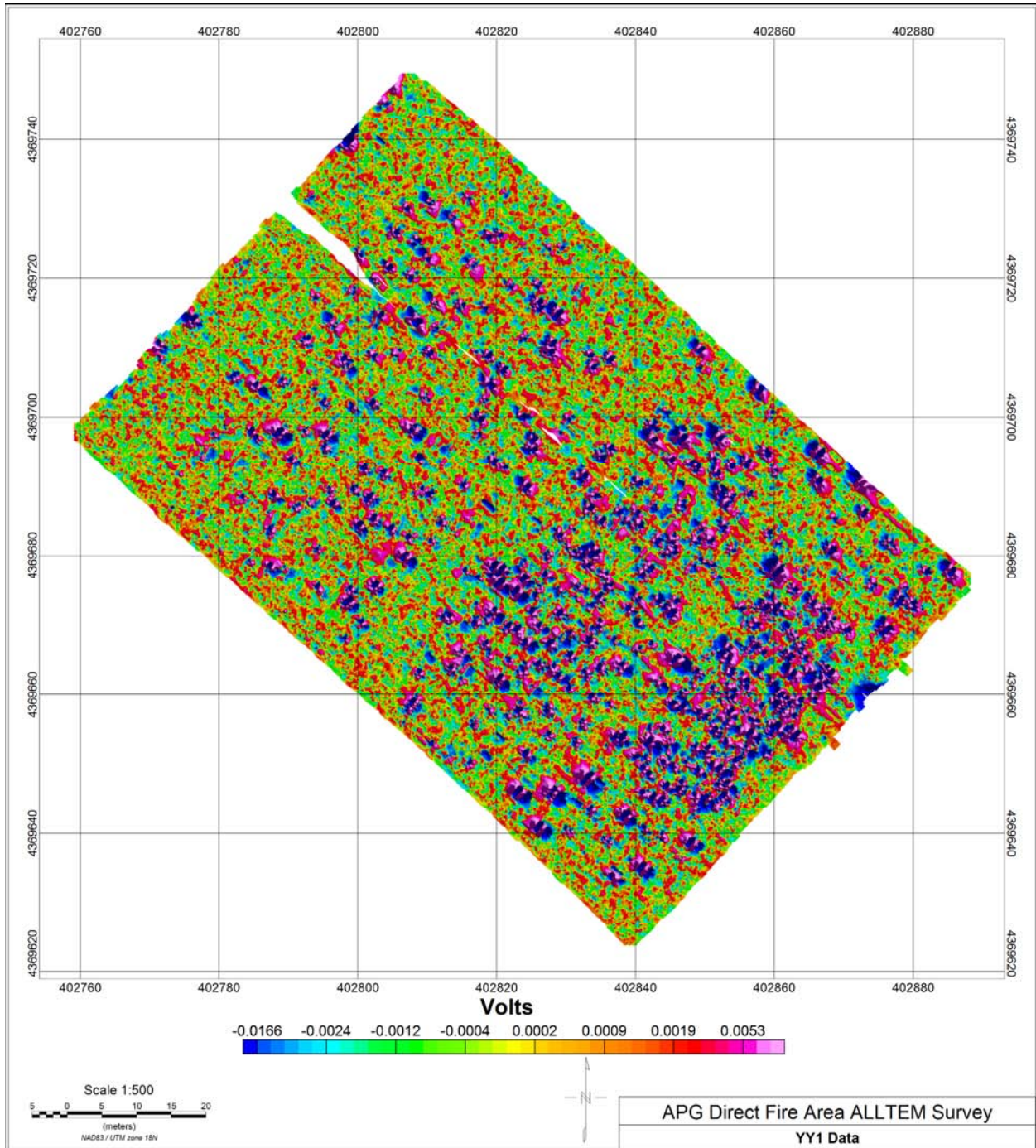

Appendix 2 – ALLTEM Data and Signal to Noise Maps

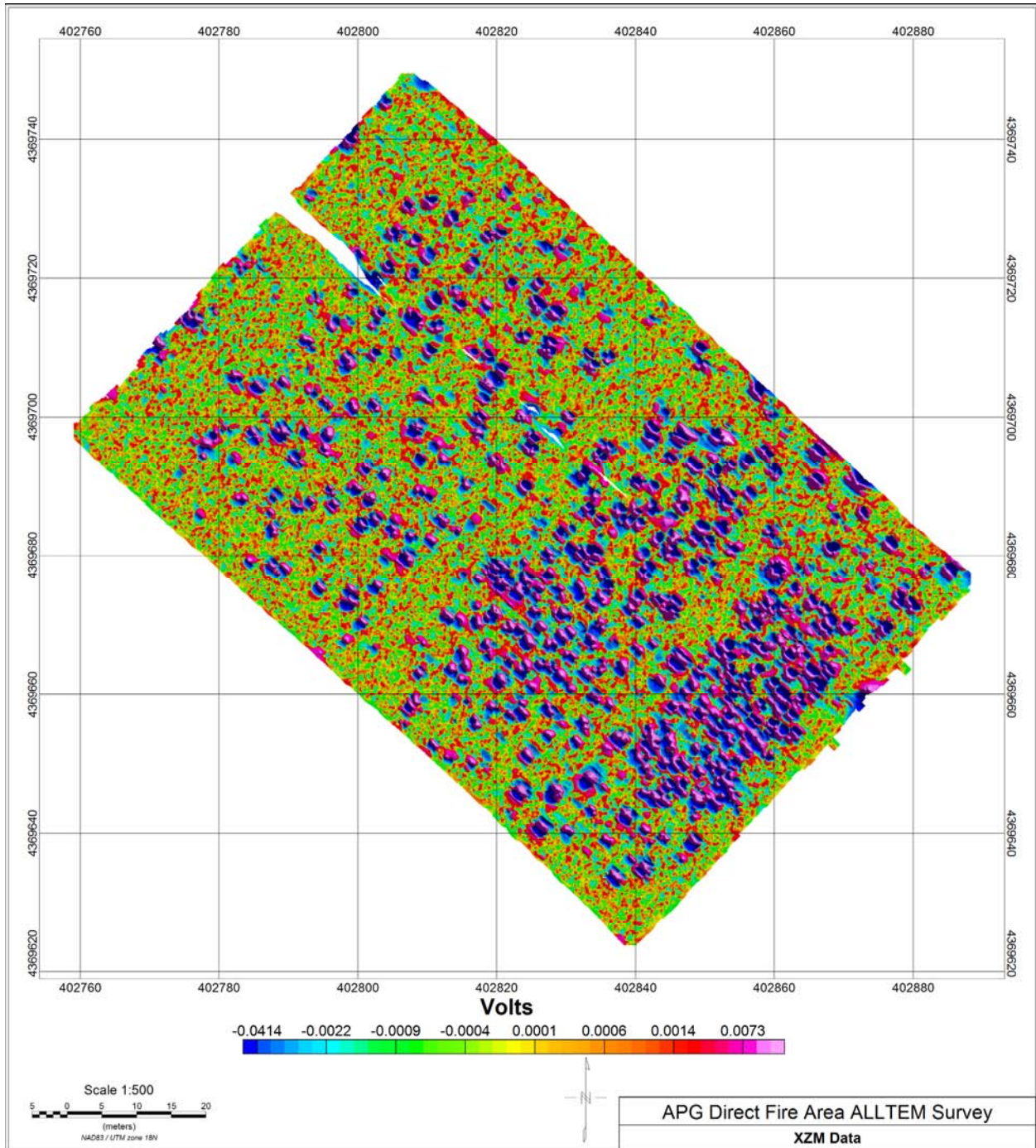

Appendix 2 – ALLTEM Data and Signal to Noise Maps

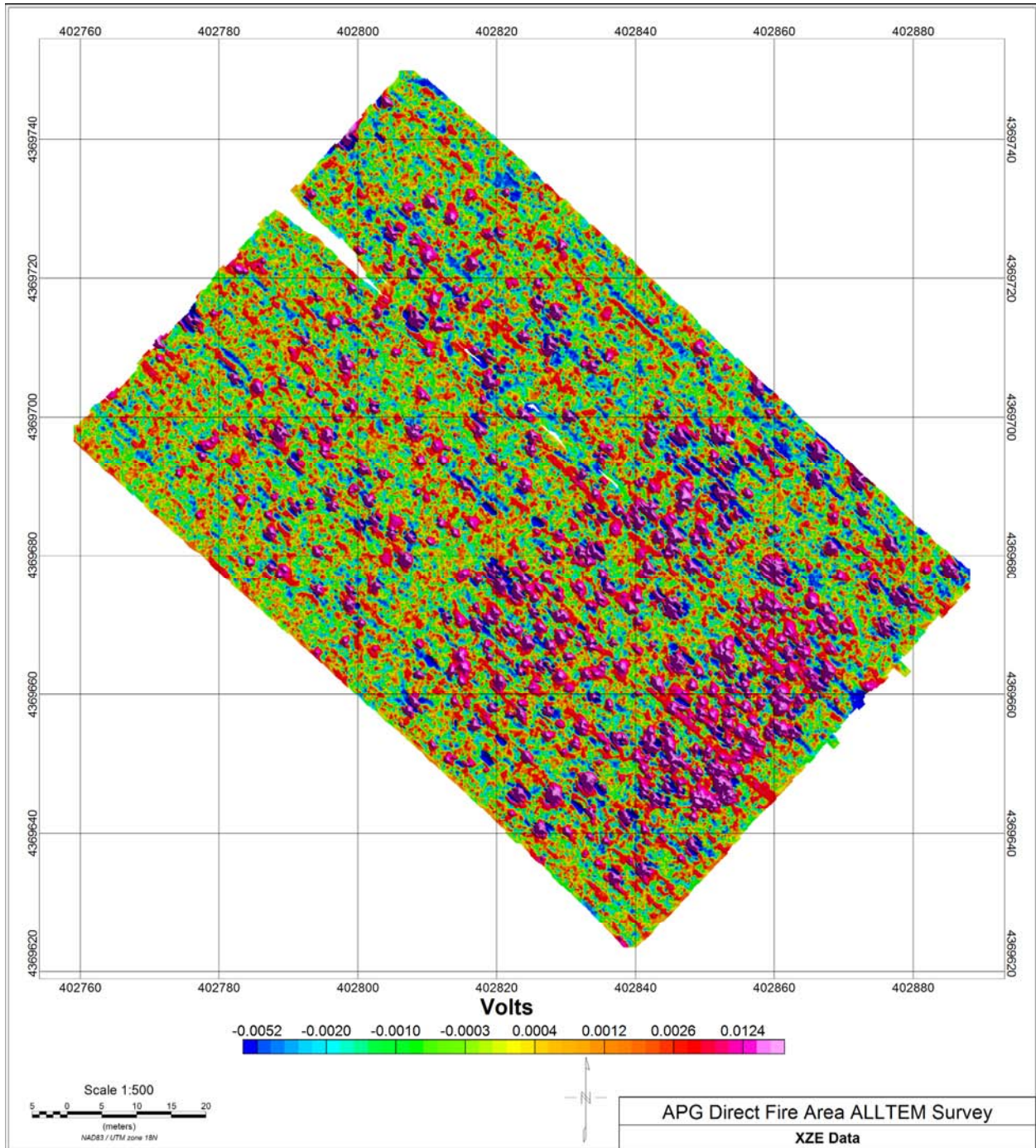

Appendix 2 – ALLTEM Data and Signal to Noise Maps

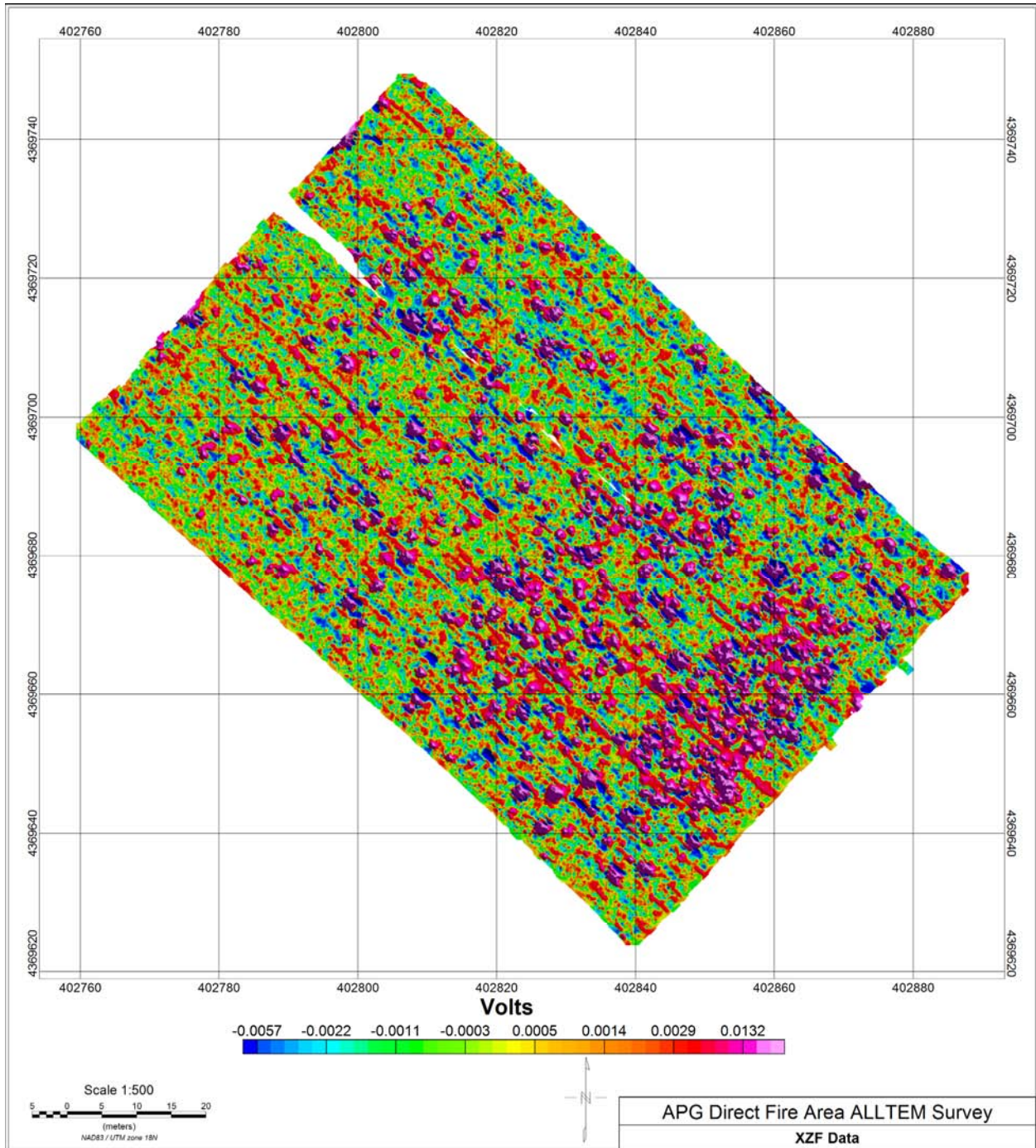

Appendix 2 – ALLTEM Data and Signal to Noise Maps

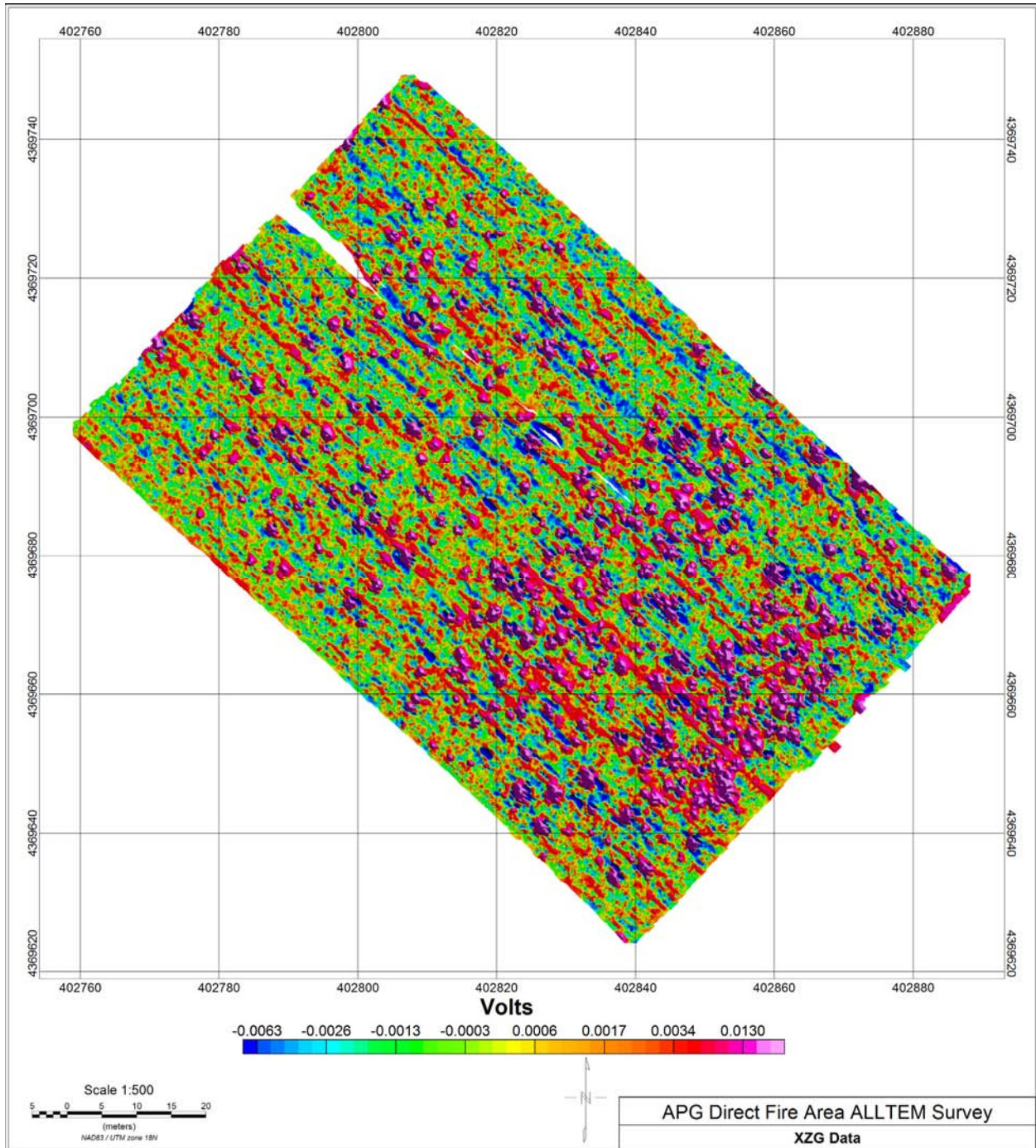

Appendix 2 – ALLTEM Data and Signal to Noise Maps

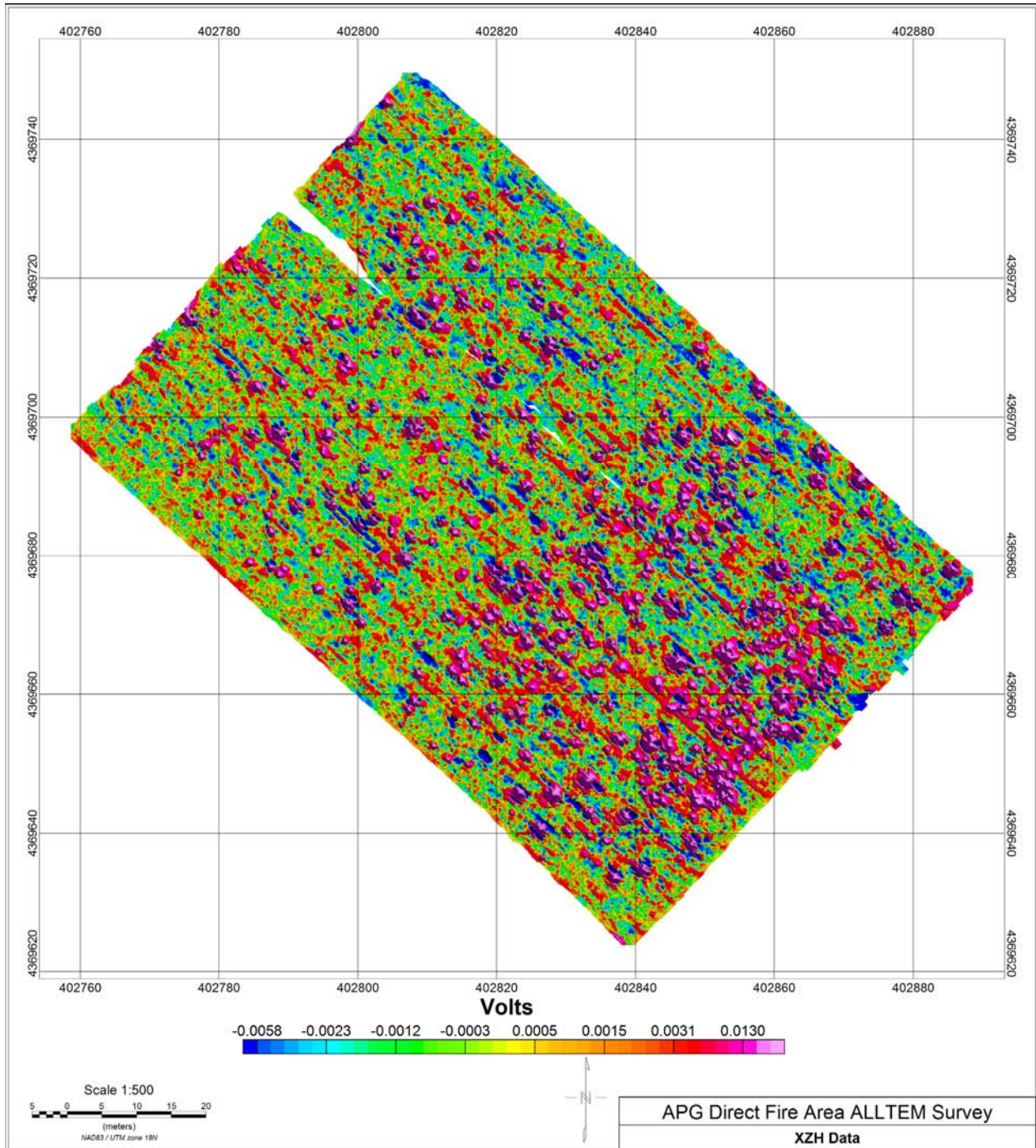

Appendix 2 – ALLTEM Data and Signal to Noise Maps

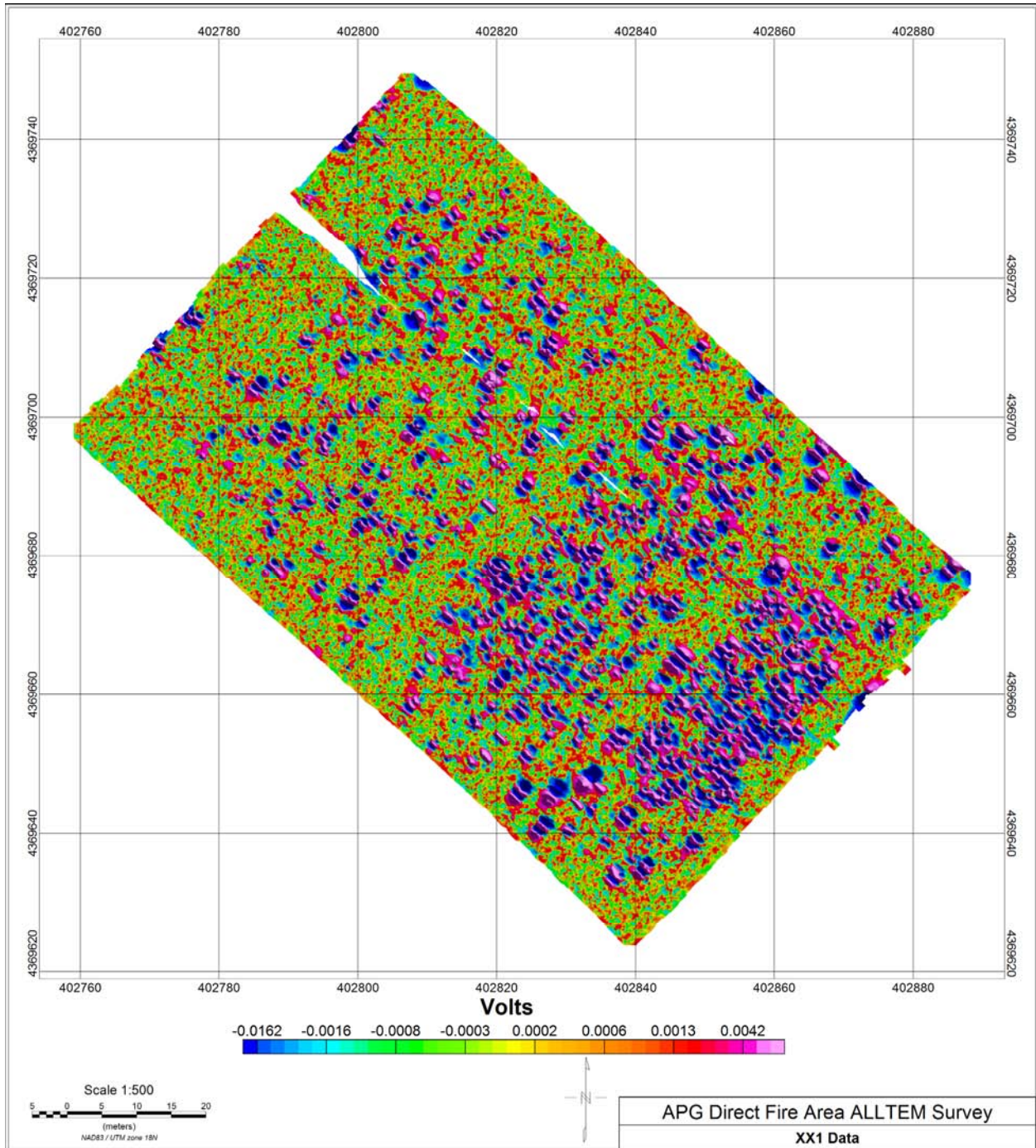

Appendix 2 – ALLTEM Data and Signal to Noise Maps

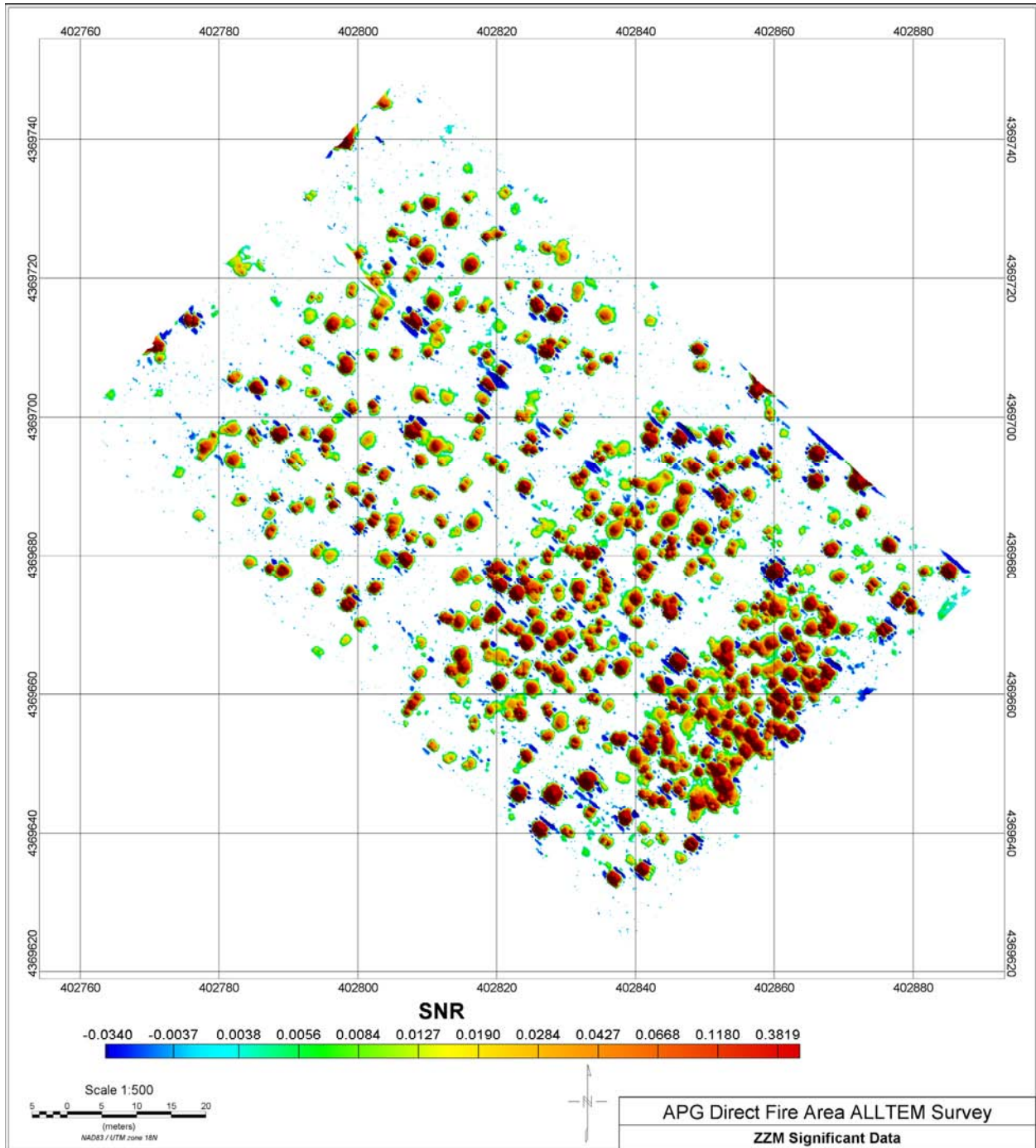

Appendix 2 – ALLTEM Data and Signal to Noise Maps

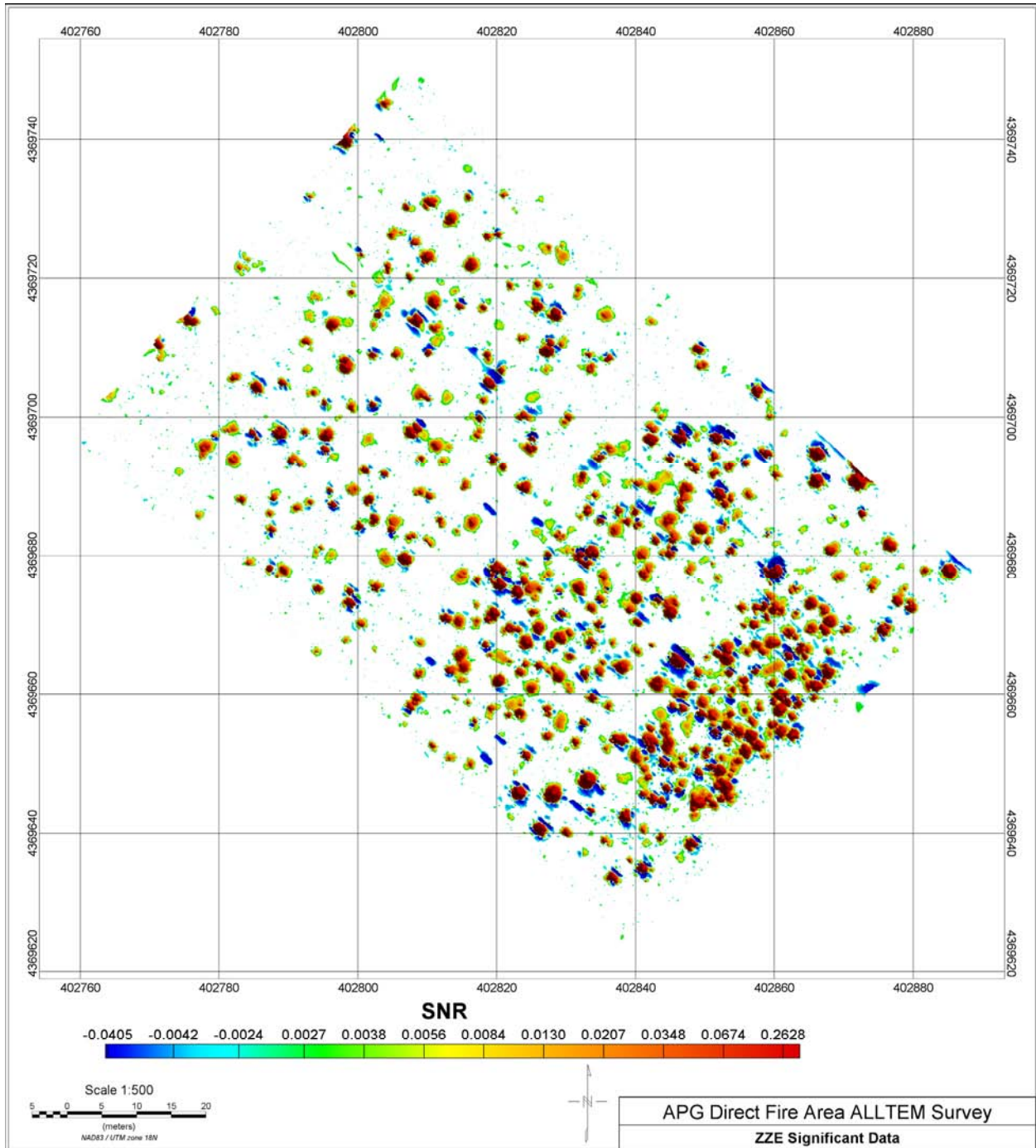

Appendix 2 – ALLTEM Data and Signal to Noise Maps

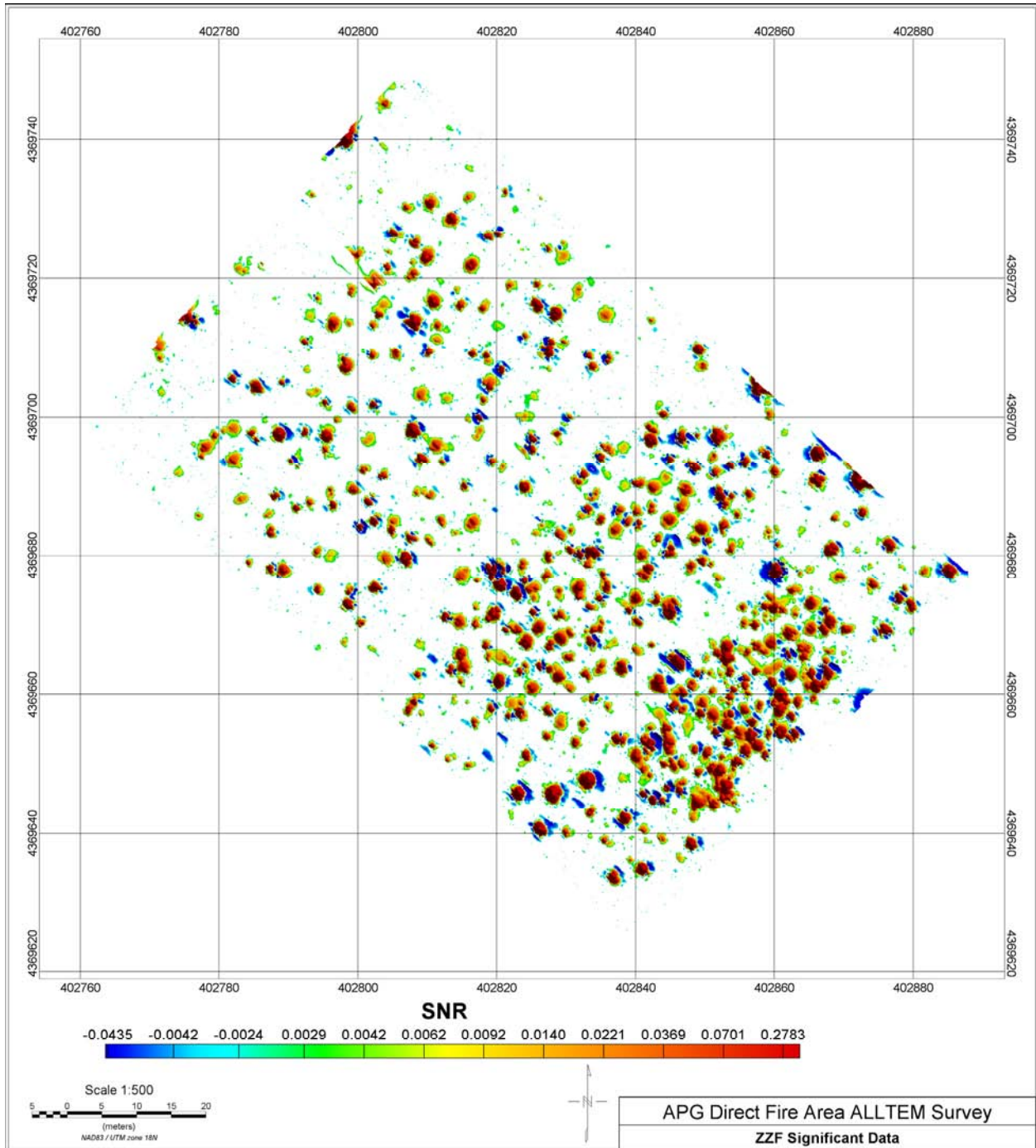

Appendix 2 – ALLTEM Data and Signal to Noise Maps

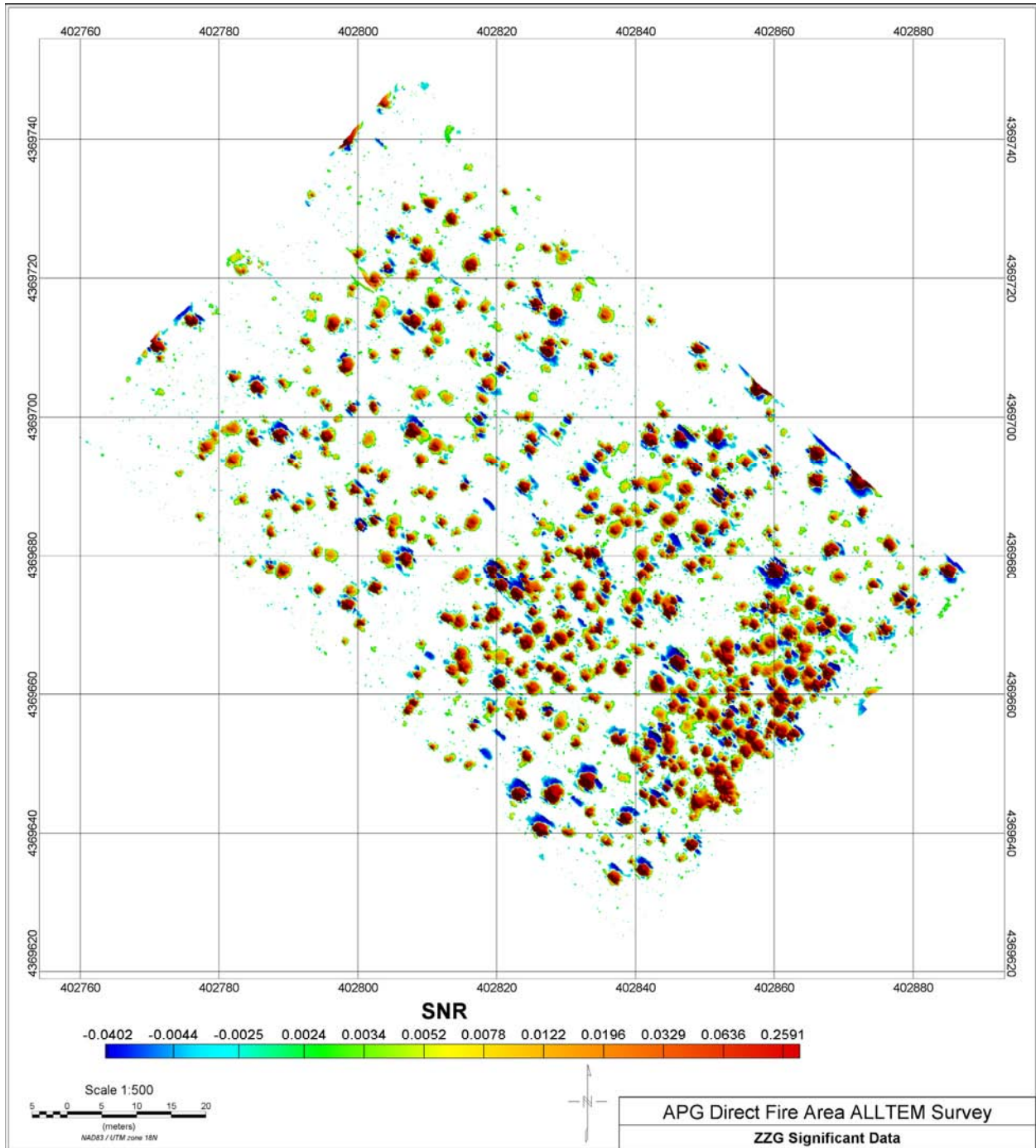

Appendix 2 – ALLTEM Data and Signal to Noise Maps

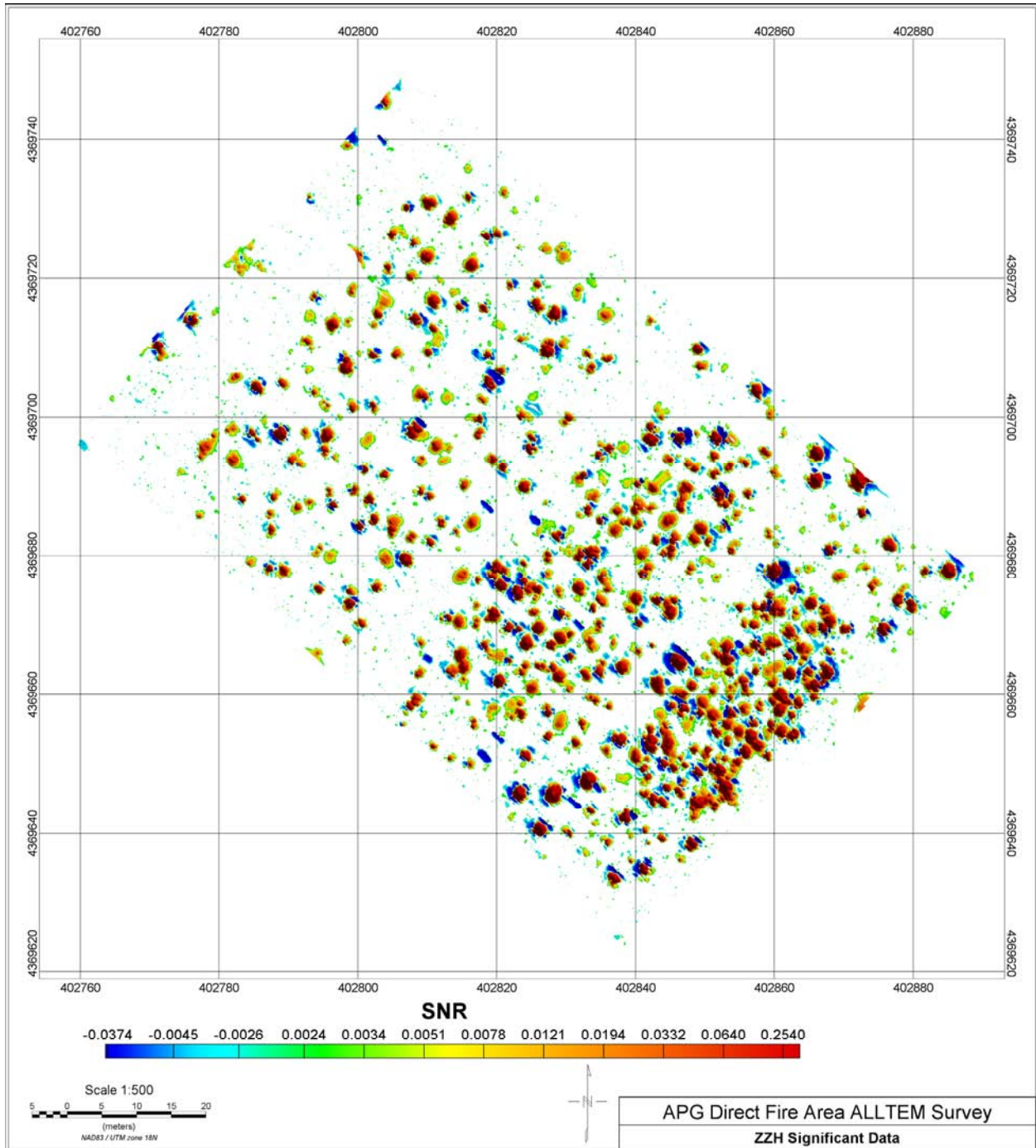

Appendix 2 – ALLTEM Data and Signal to Noise Maps

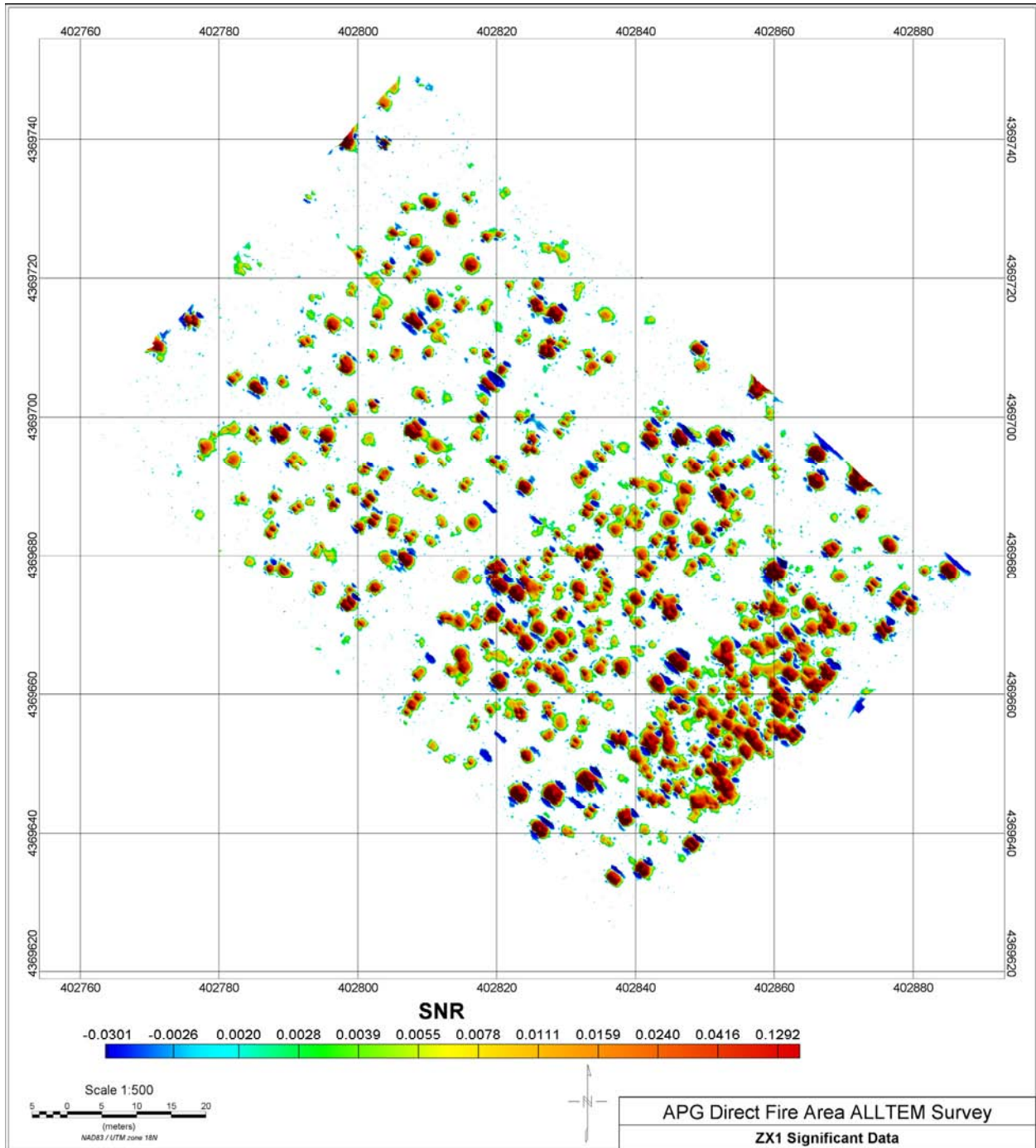

Appendix 2 – ALLTEM Data and Signal to Noise Maps

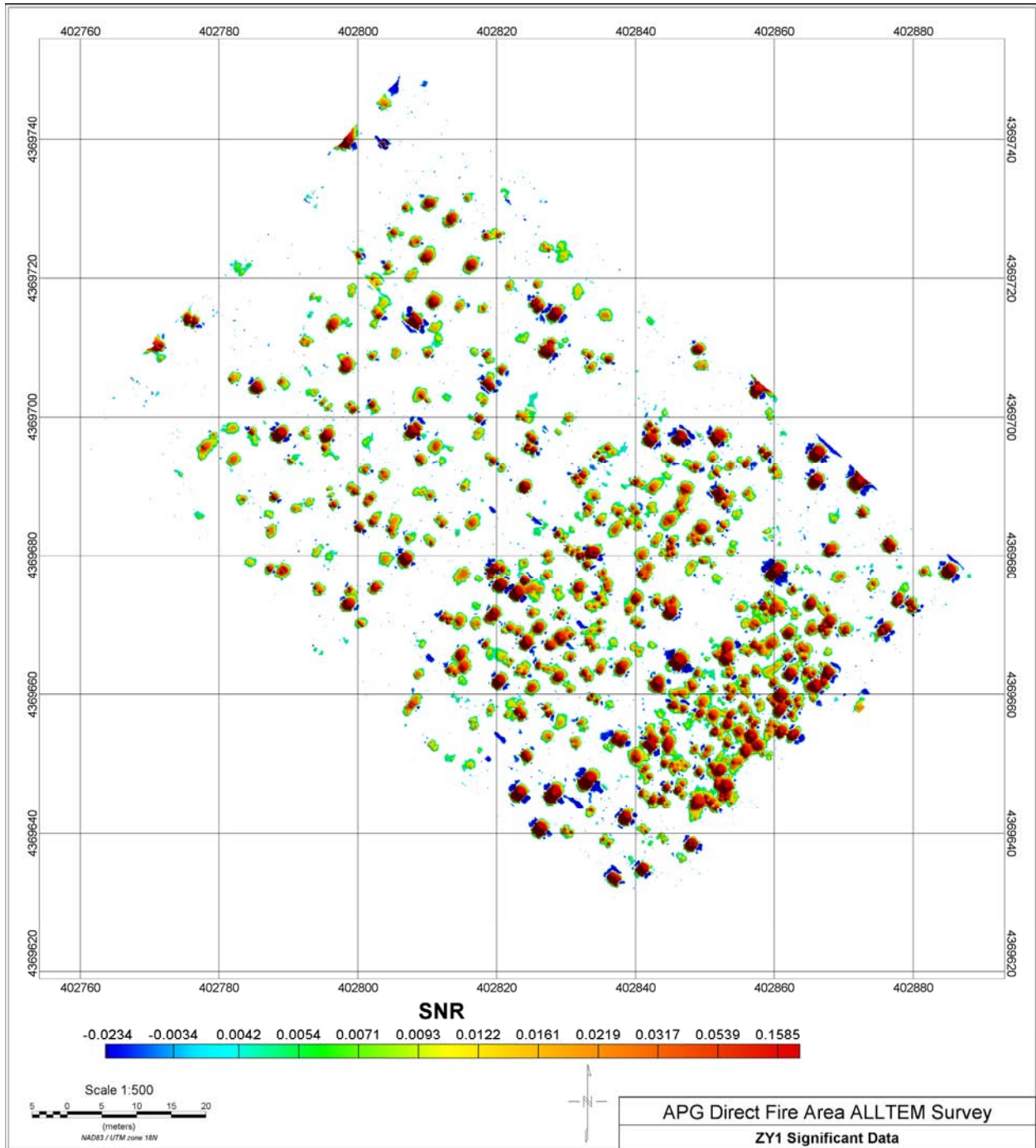

Appendix 2 – ALLTEM Data and Signal to Noise Maps

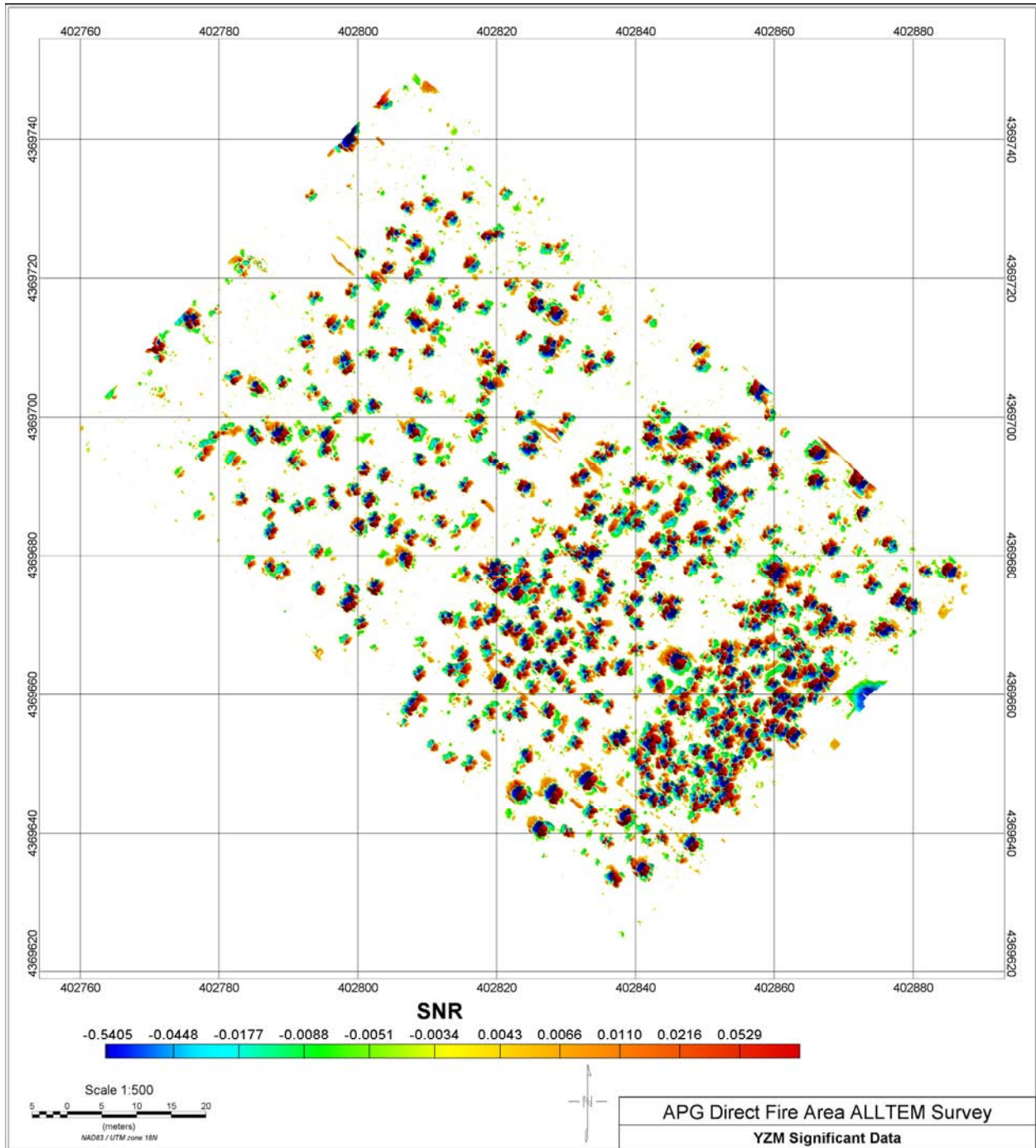

Appendix 2 – ALLTEM Data and Signal to Noise Maps

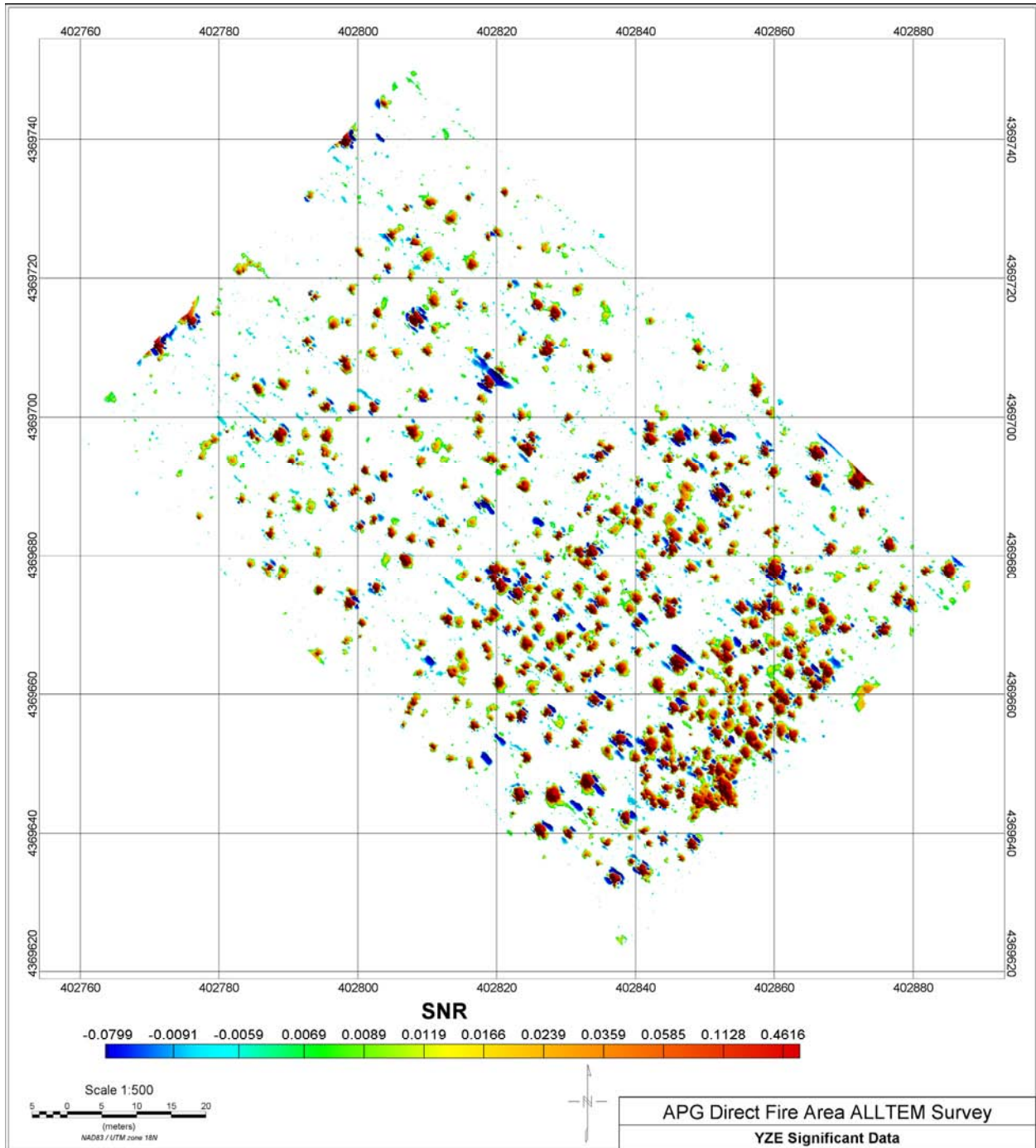

Appendix 2 – ALLTEM Data and Signal to Noise Maps

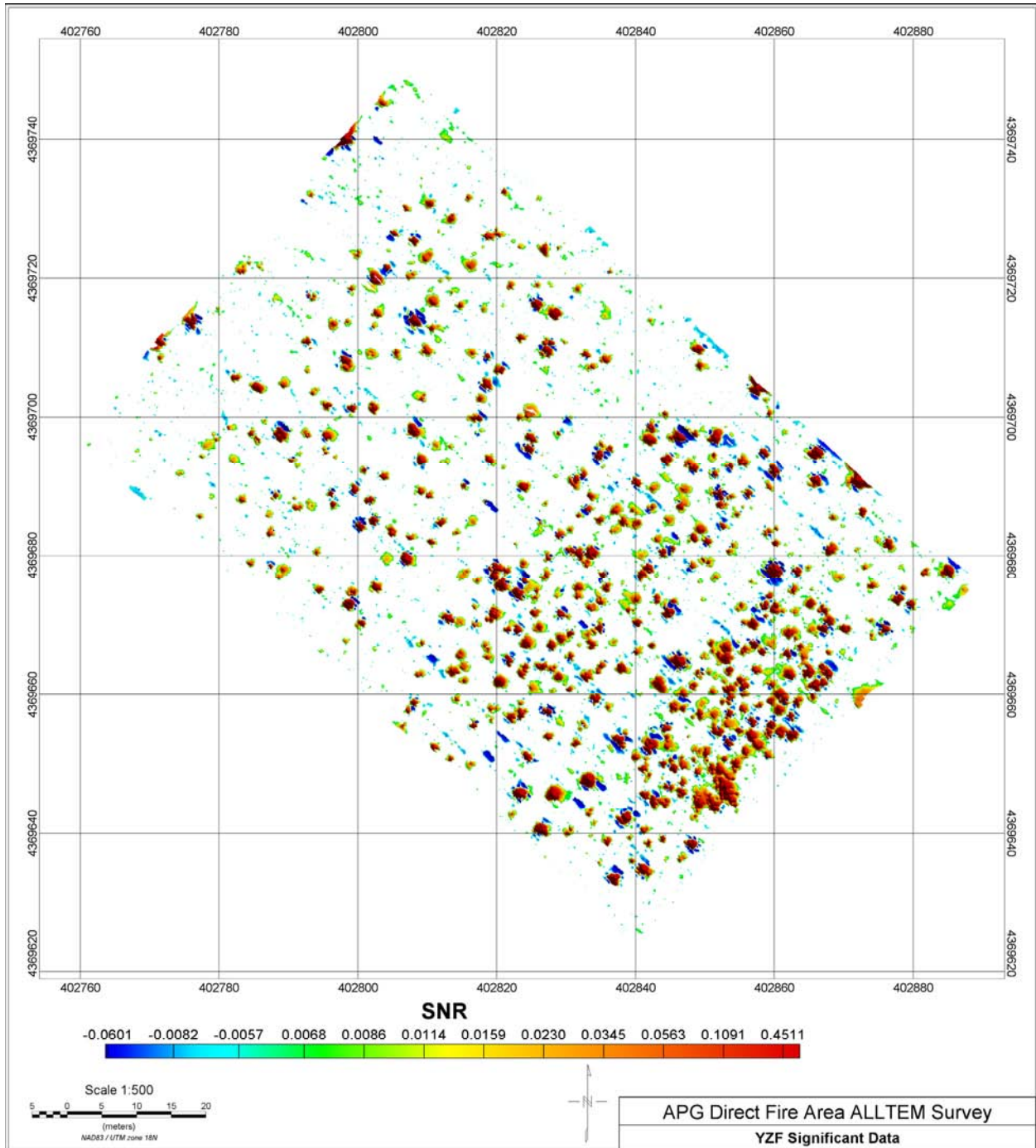

Appendix 2 – ALLTEM Data and Signal to Noise Maps

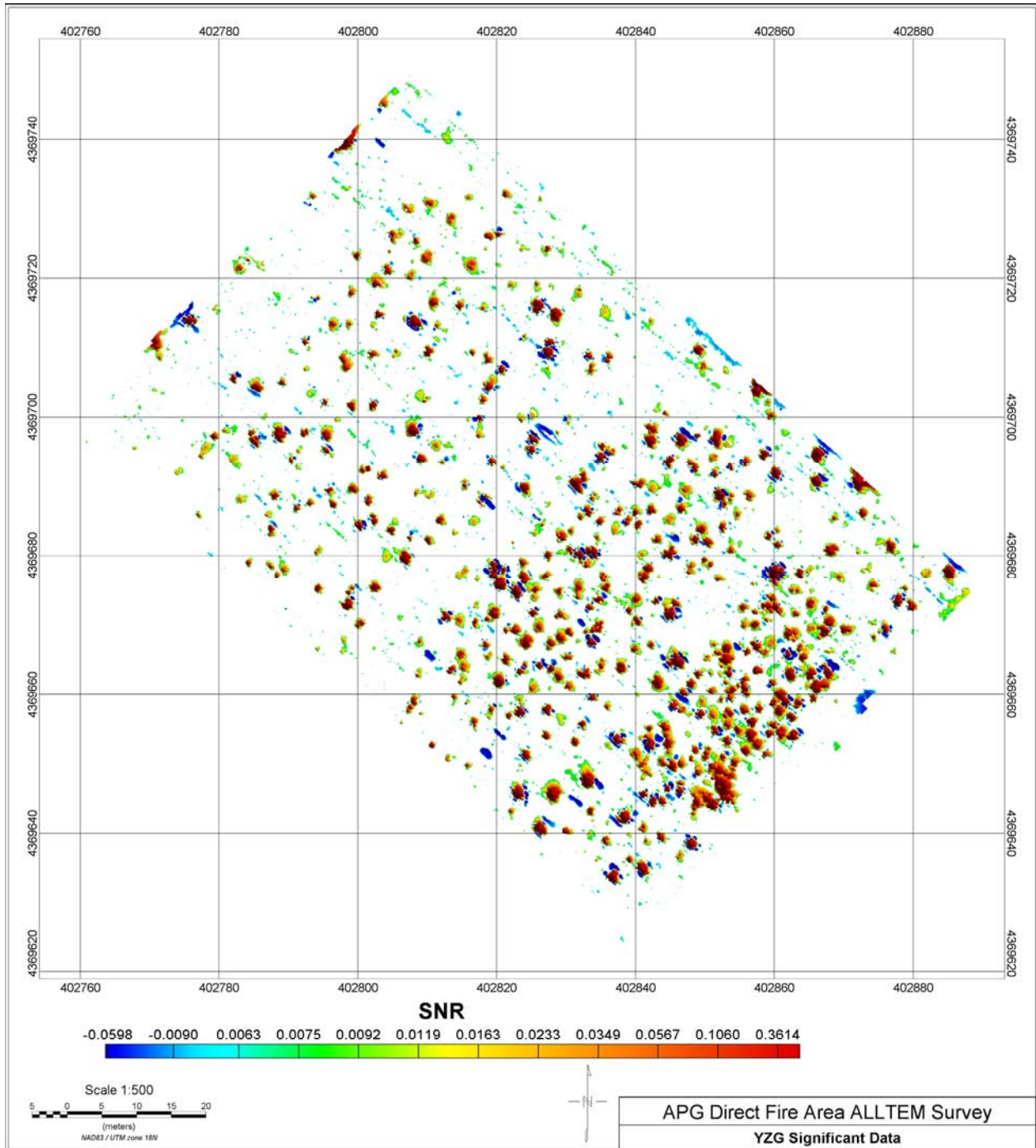

Appendix 2 – ALLTEM Data and Signal to Noise Maps

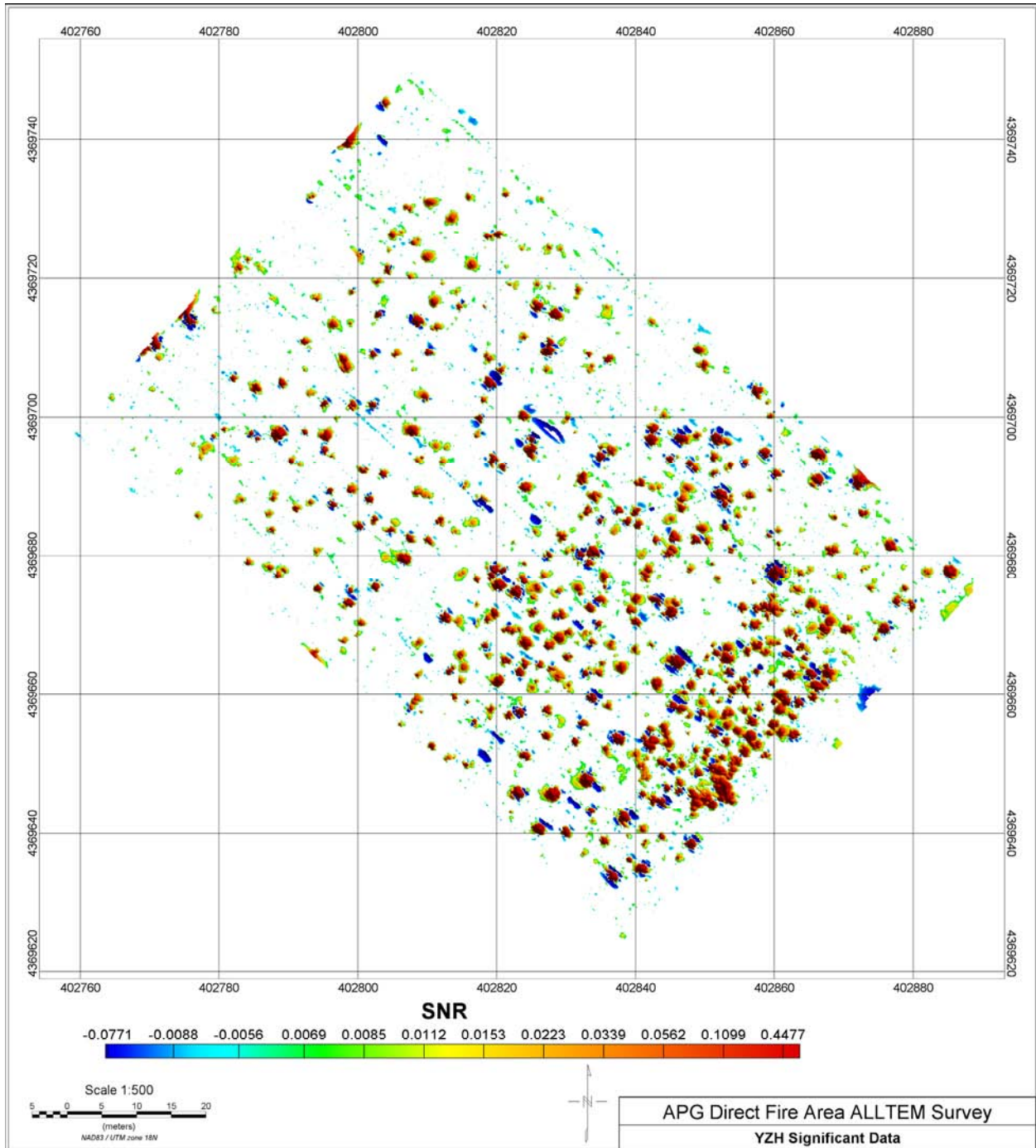

Appendix 2 – ALLTEM Data and Signal to Noise Maps

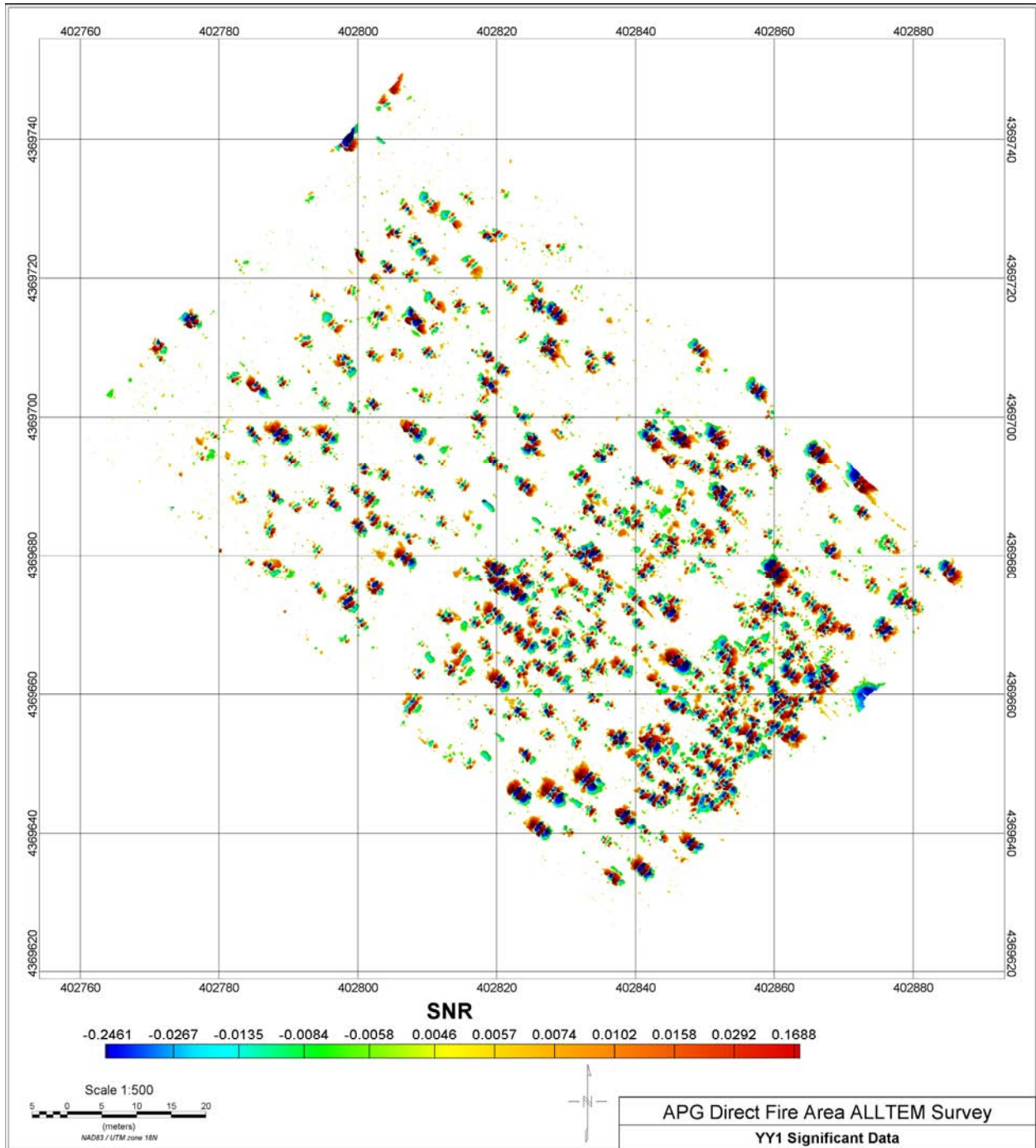

Appendix 2 – ALLTEM Data and Signal to Noise Maps

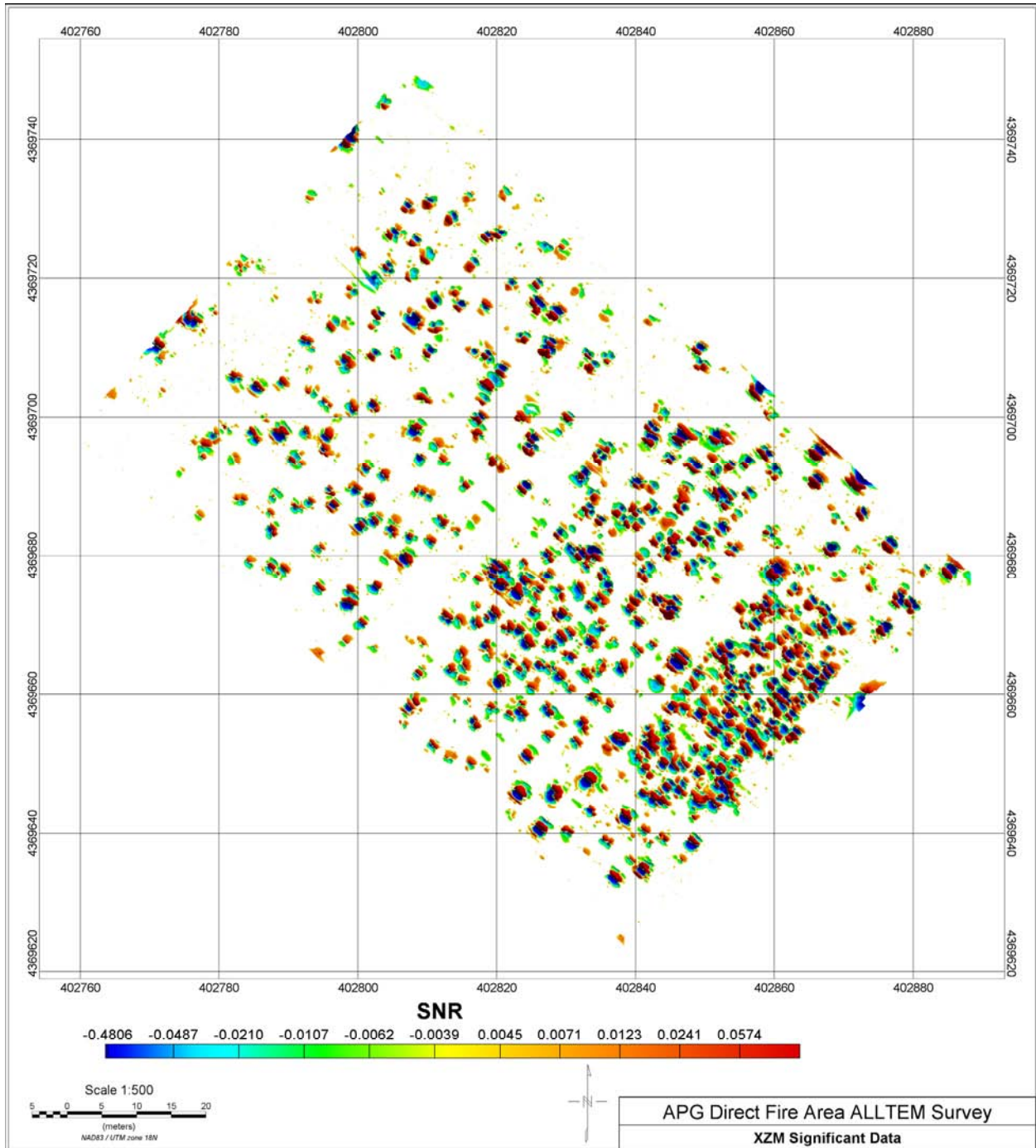

Appendix 2 – ALLTEM Data and Signal to Noise Maps

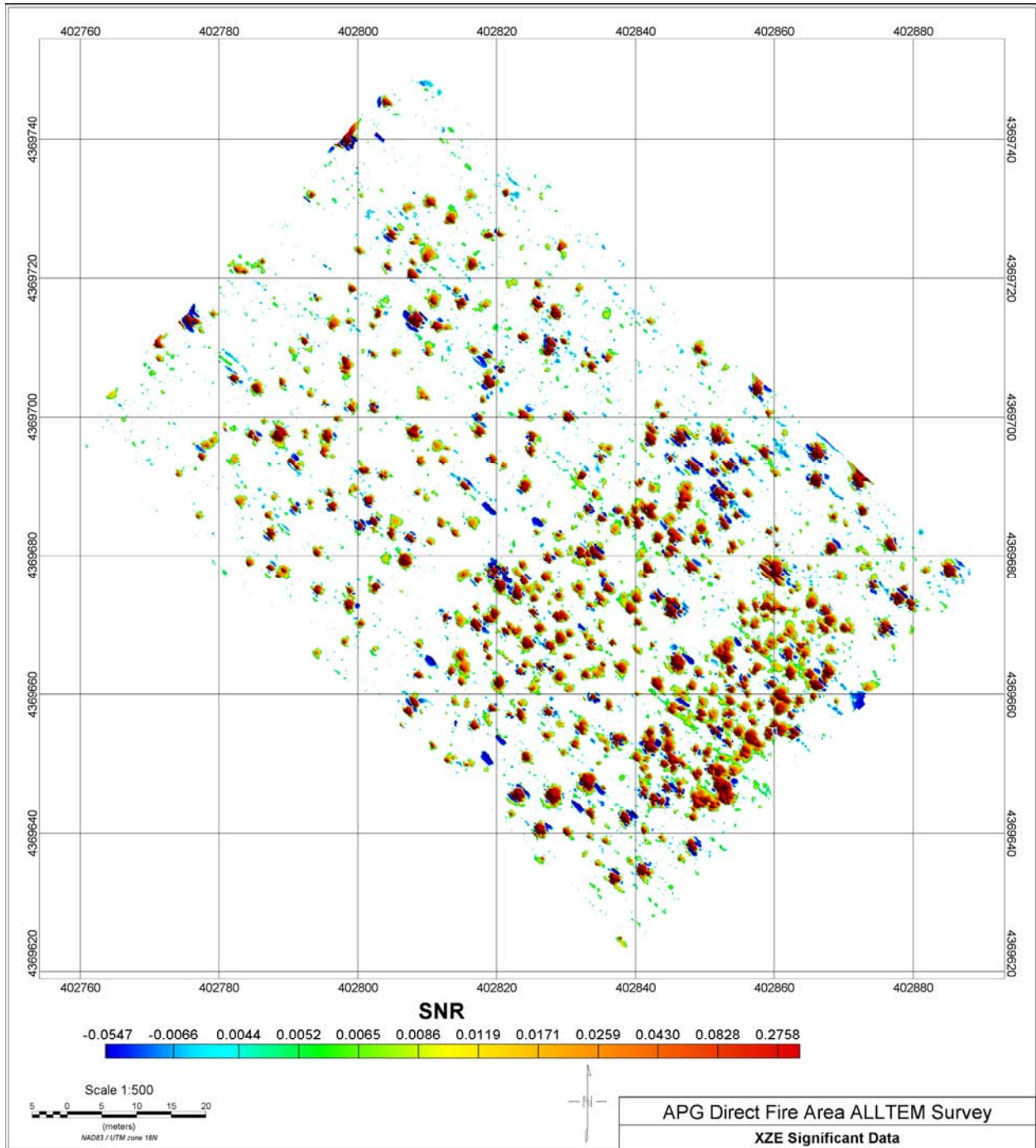

Appendix 2 – ALLTEM Data and Signal to Noise Maps

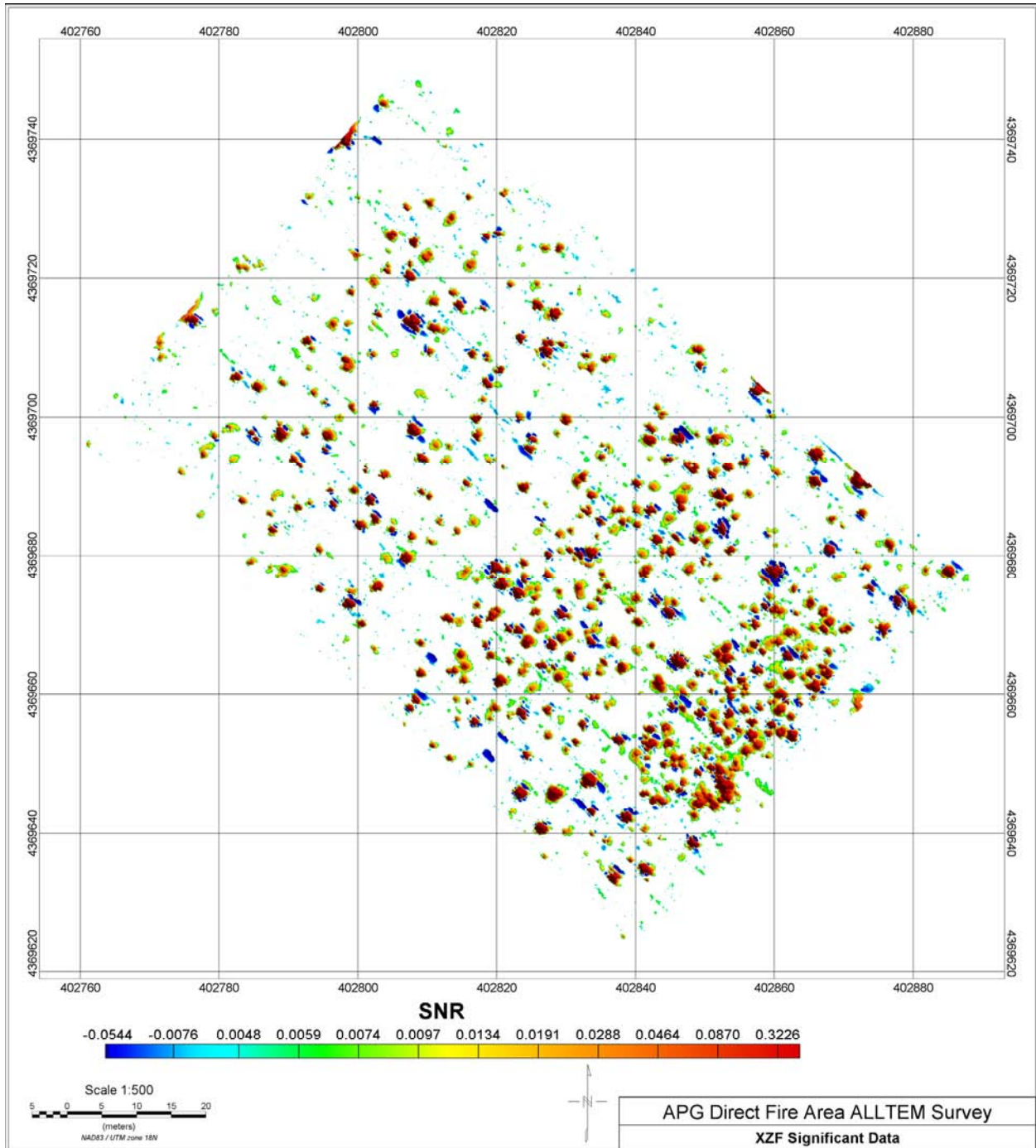

Appendix 2 – ALLTEM Data and Signal to Noise Maps

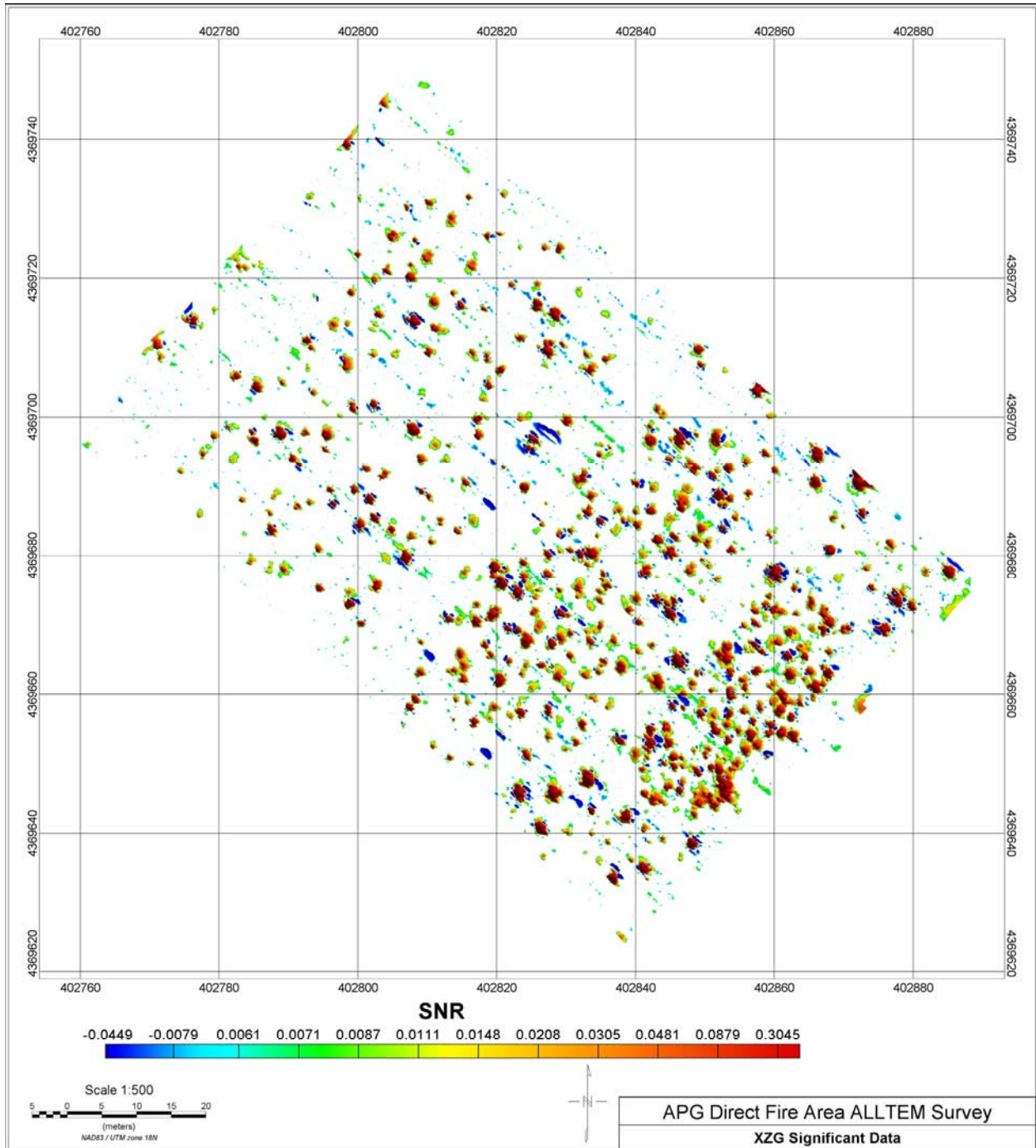

Appendix 2 – ALLTEM Data and Signal to Noise Maps

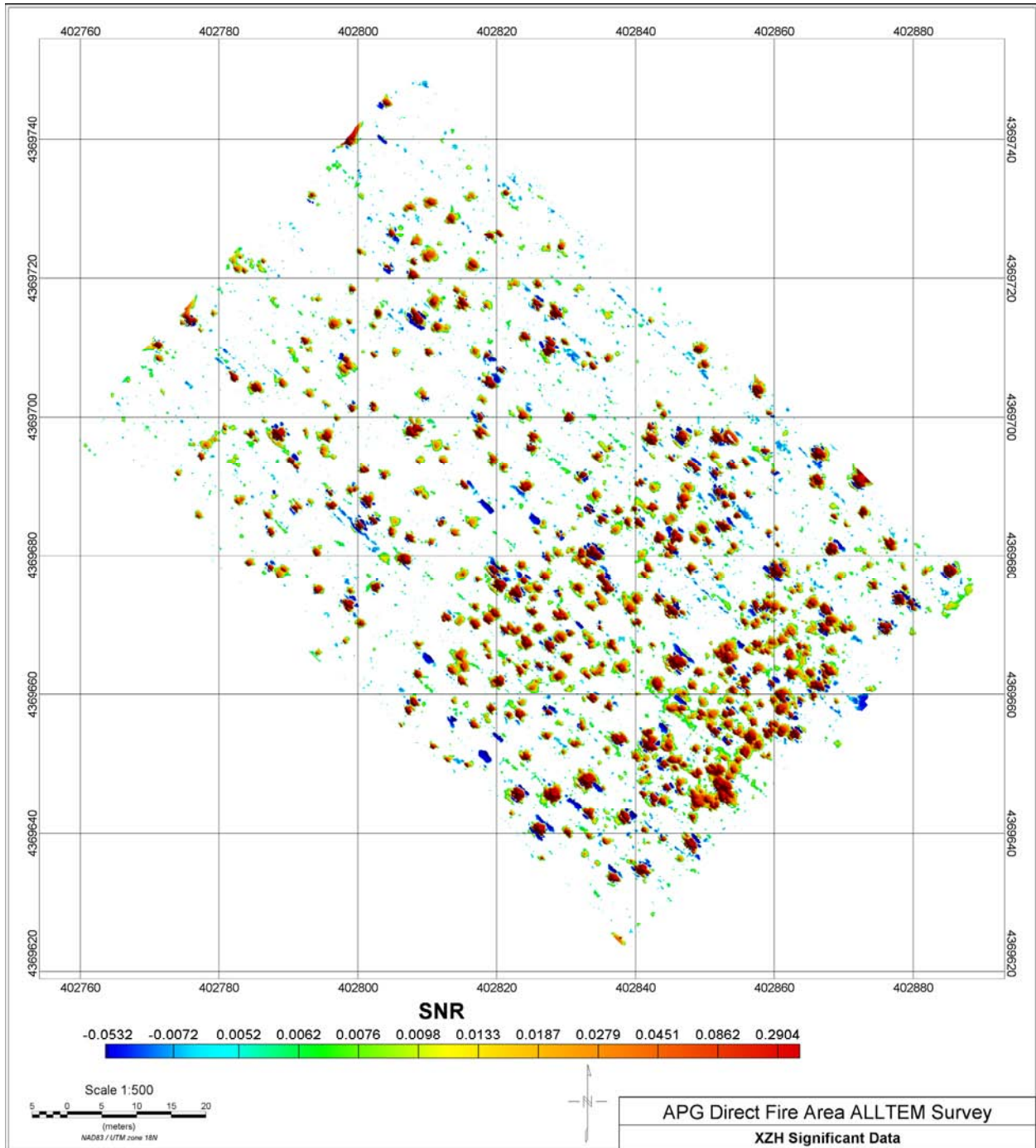

Appendix 2 – ALLTEM Data and Signal to Noise Maps

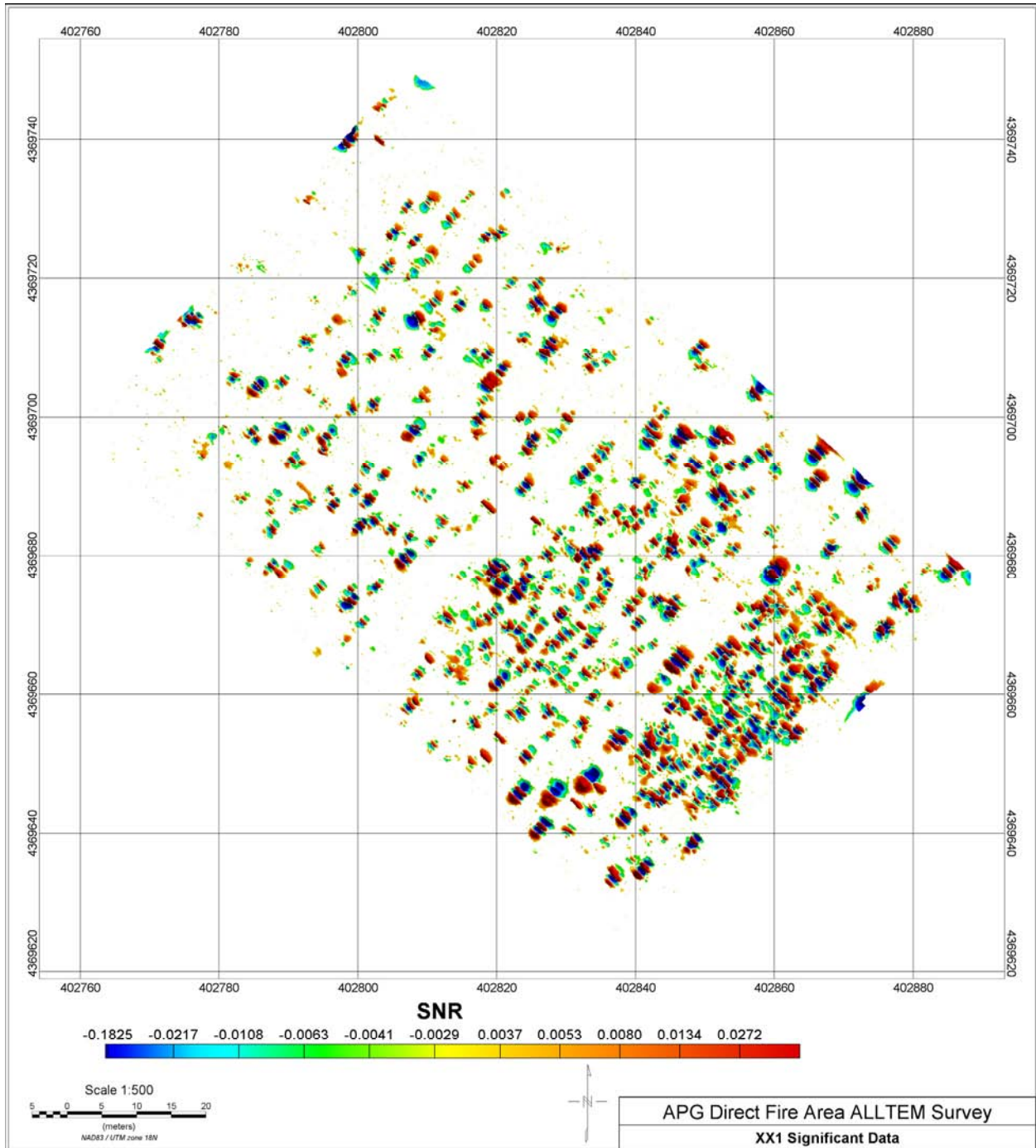

Appendix 2 – ALLTEM Data and Signal to Noise Maps

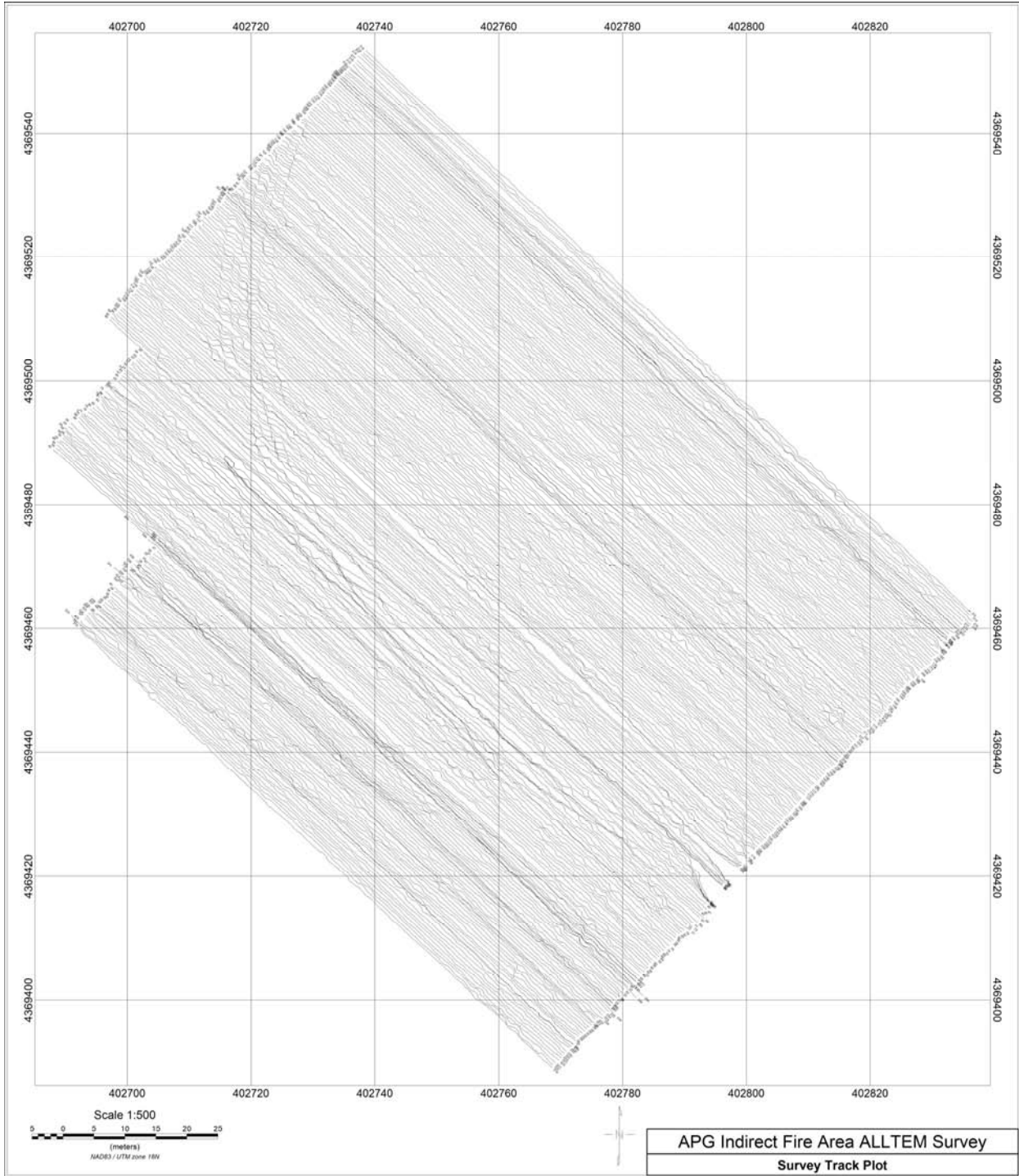

Appendix 2 – ALLTEM Data and Signal to Noise Maps

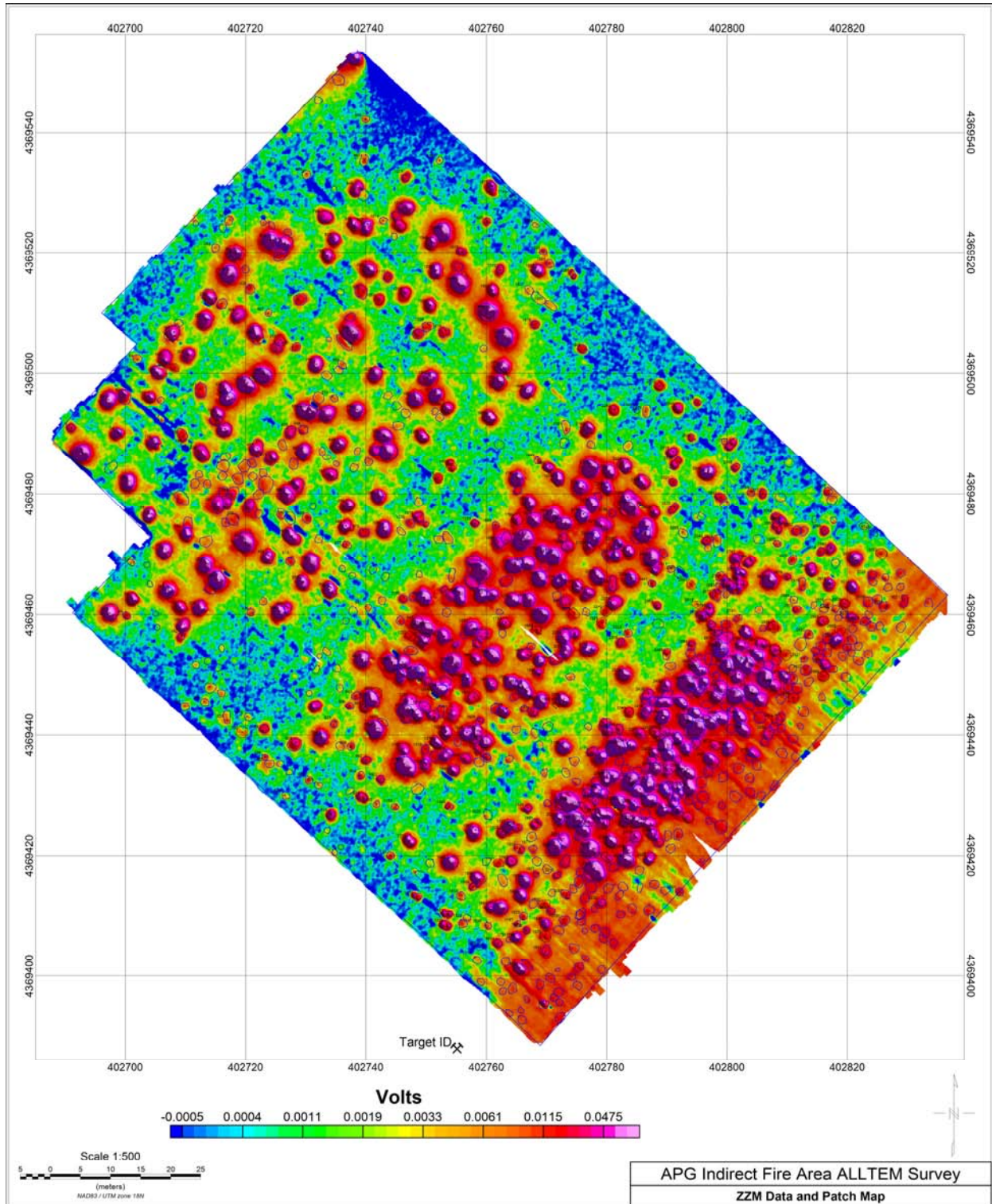

Appendix 2 – ALLTEM Data and Signal to Noise Maps

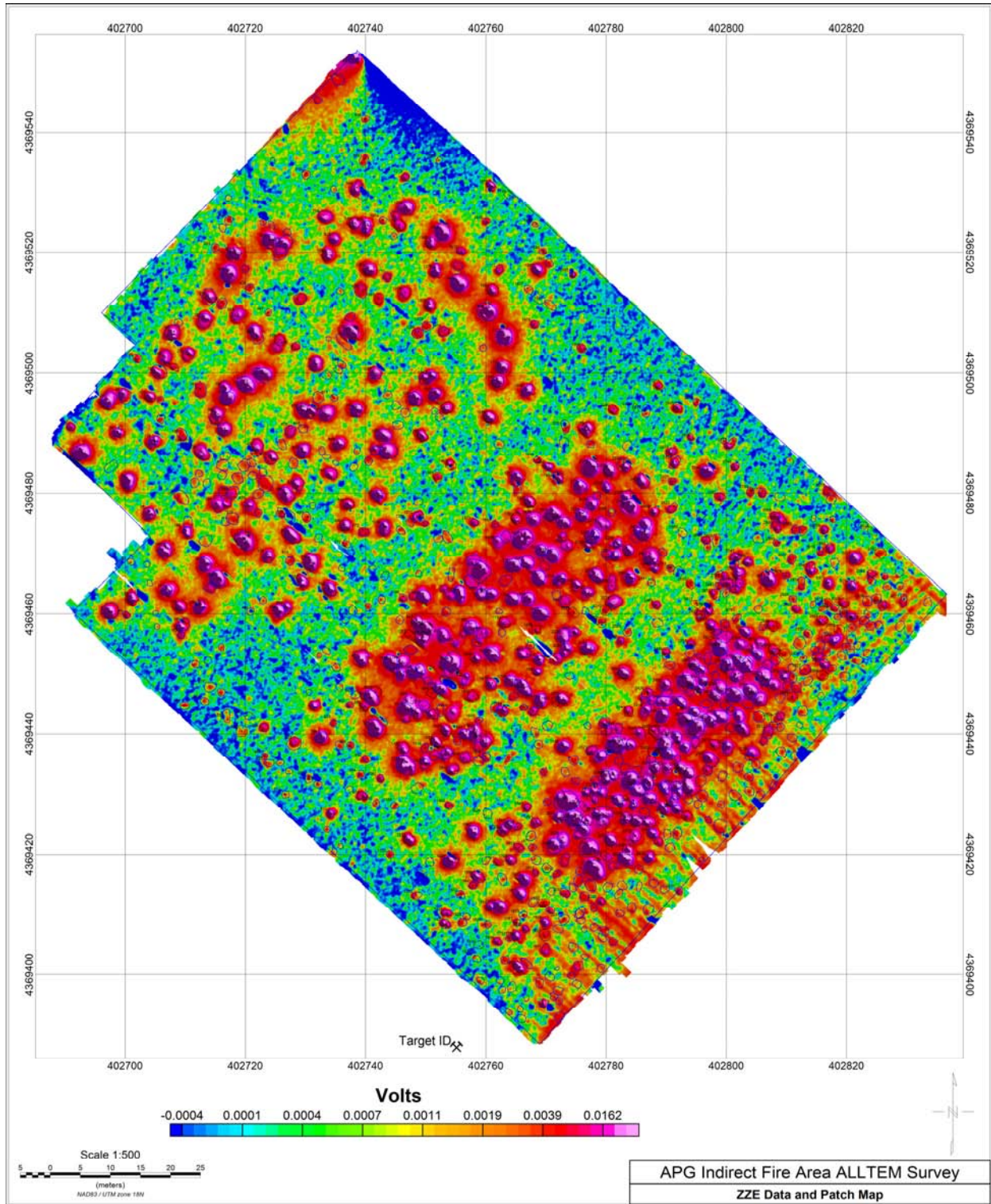

Appendix 2 – ALLTEM Data and Signal to Noise Maps

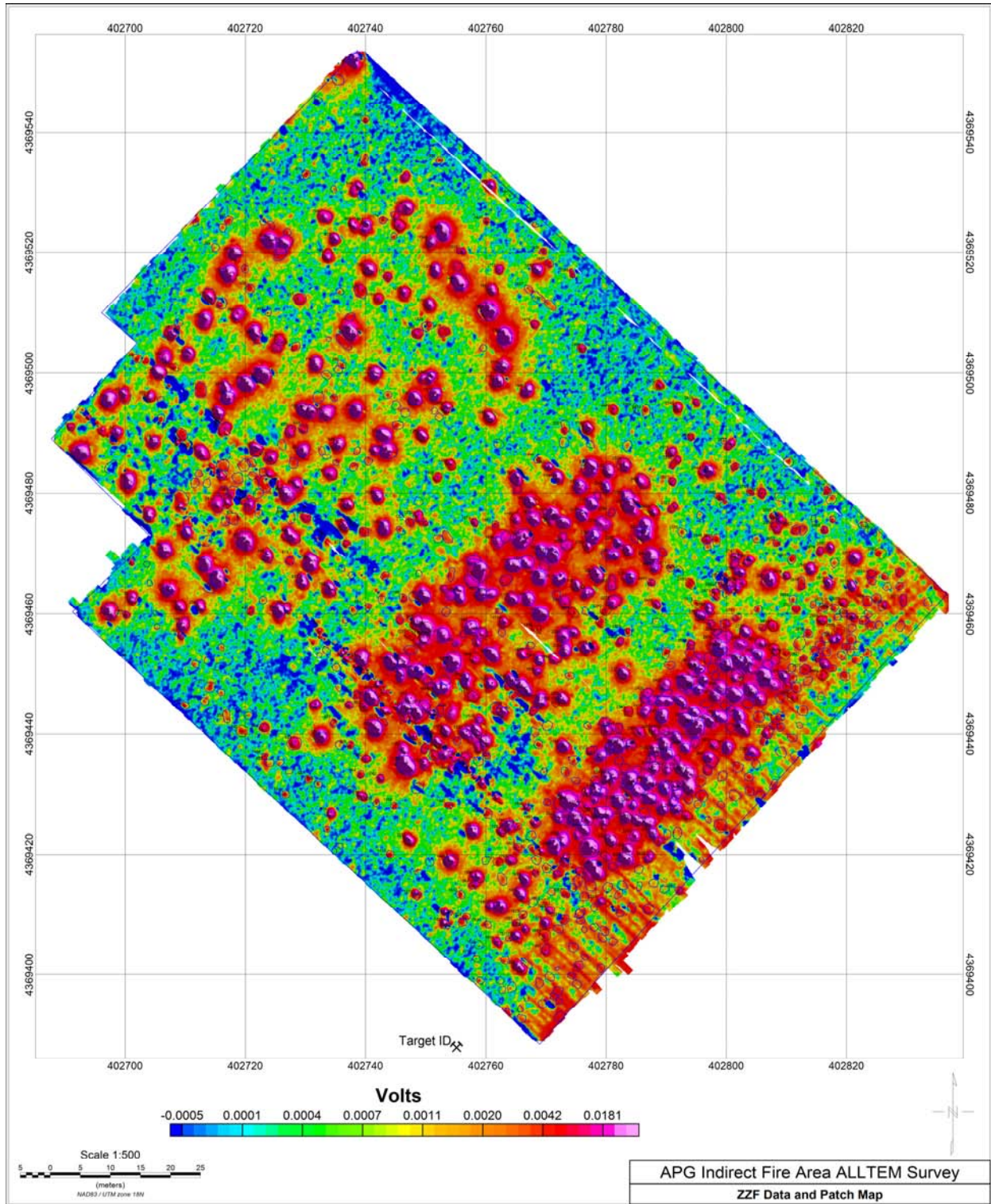

Appendix 2 – ALLTEM Data and Signal to Noise Maps

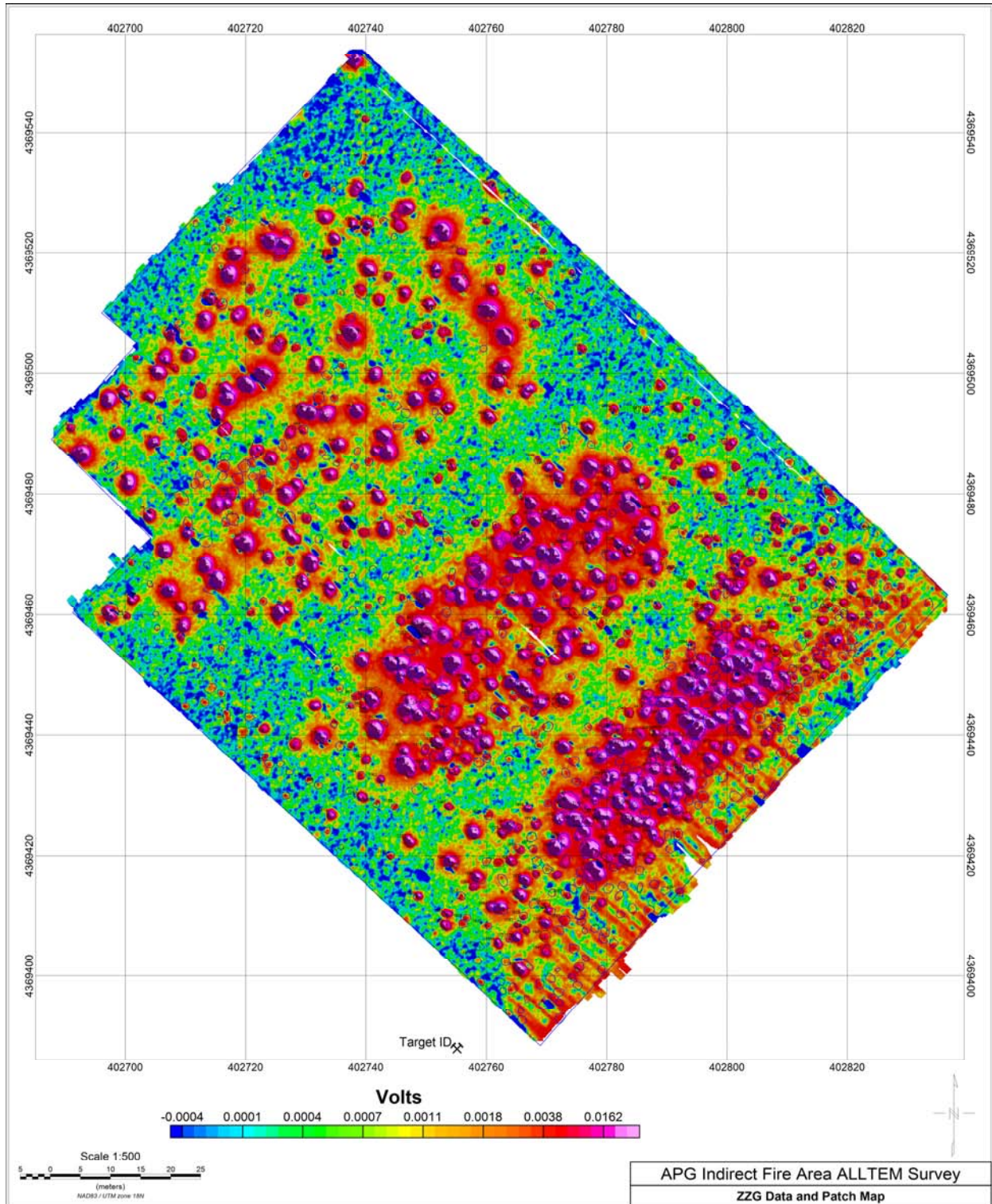

Appendix 2 – ALLTEM Data and Signal to Noise Maps

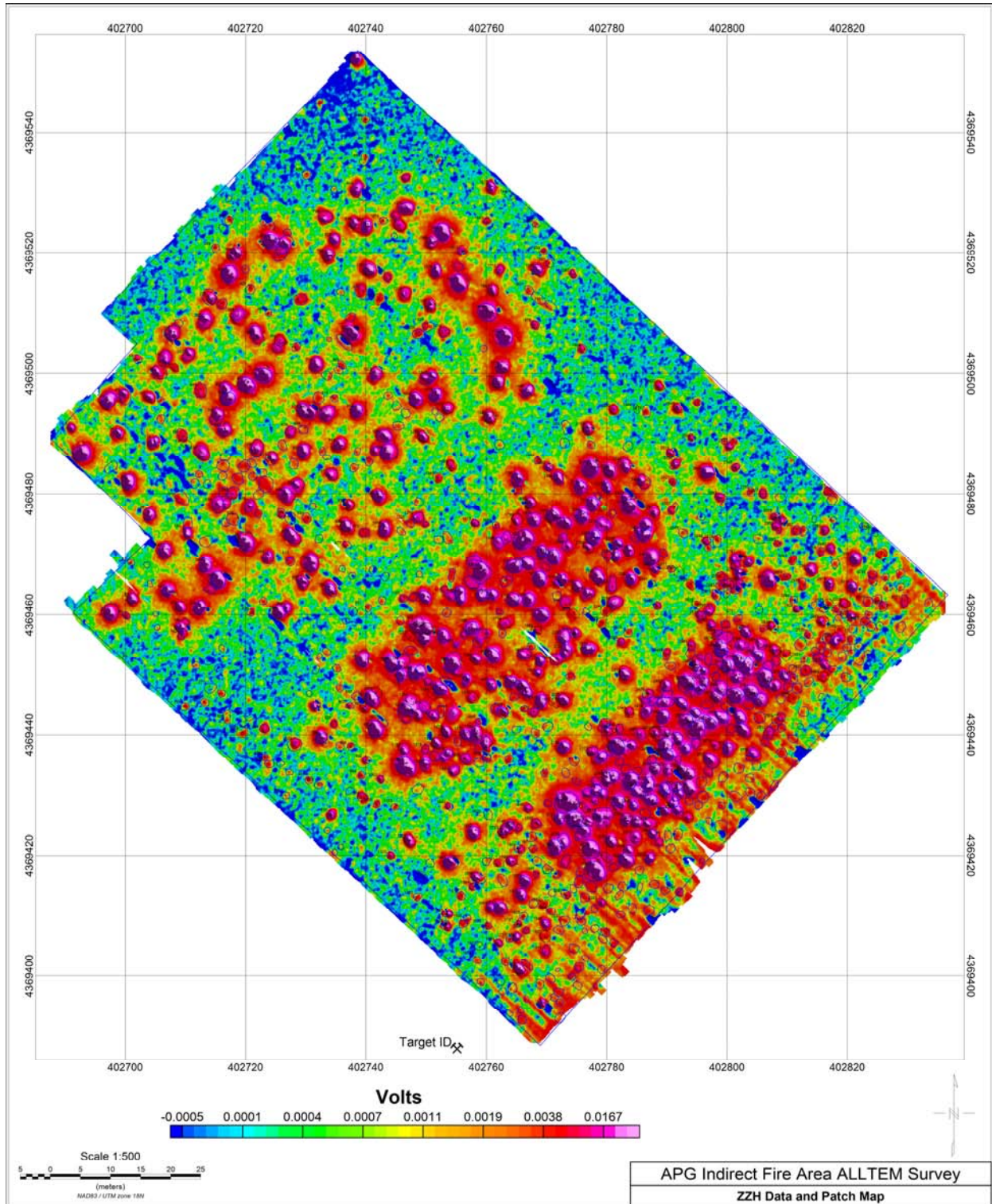

Appendix 2 – ALLTEM Data and Signal to Noise Maps

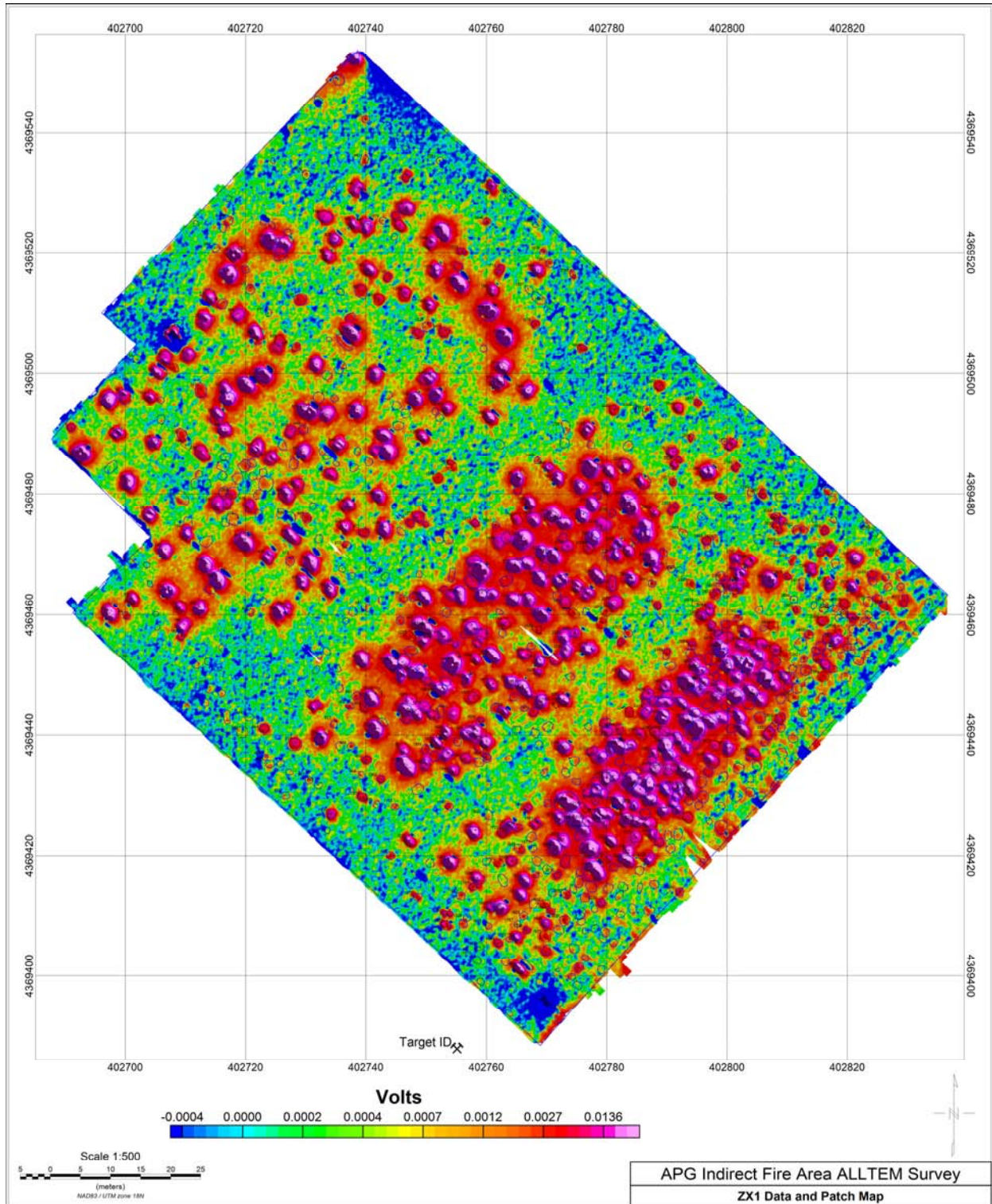

Appendix 2 – ALLTEM Data and Signal to Noise Maps

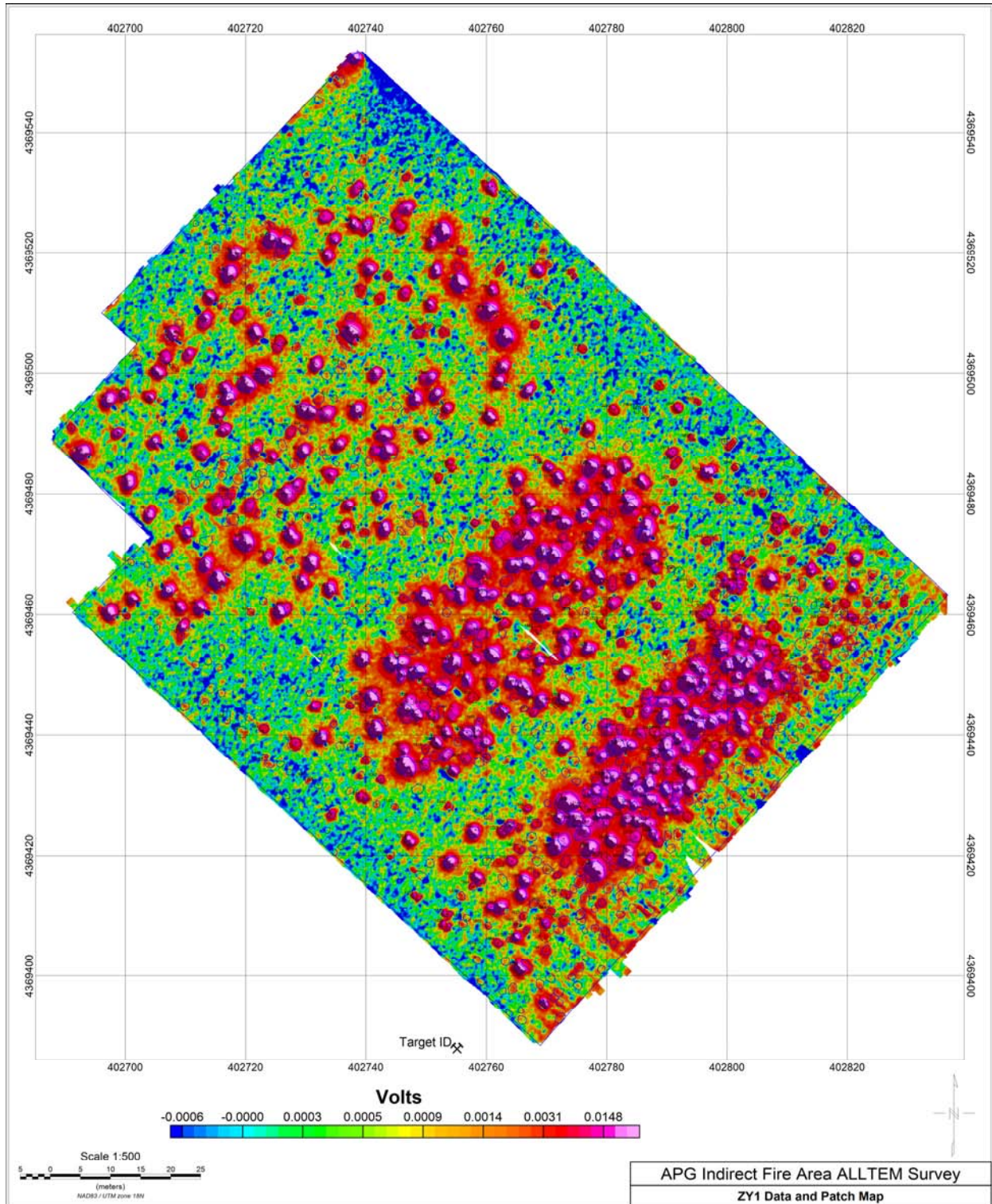

Appendix 2 – ALLTEM Data and Signal to Noise Maps

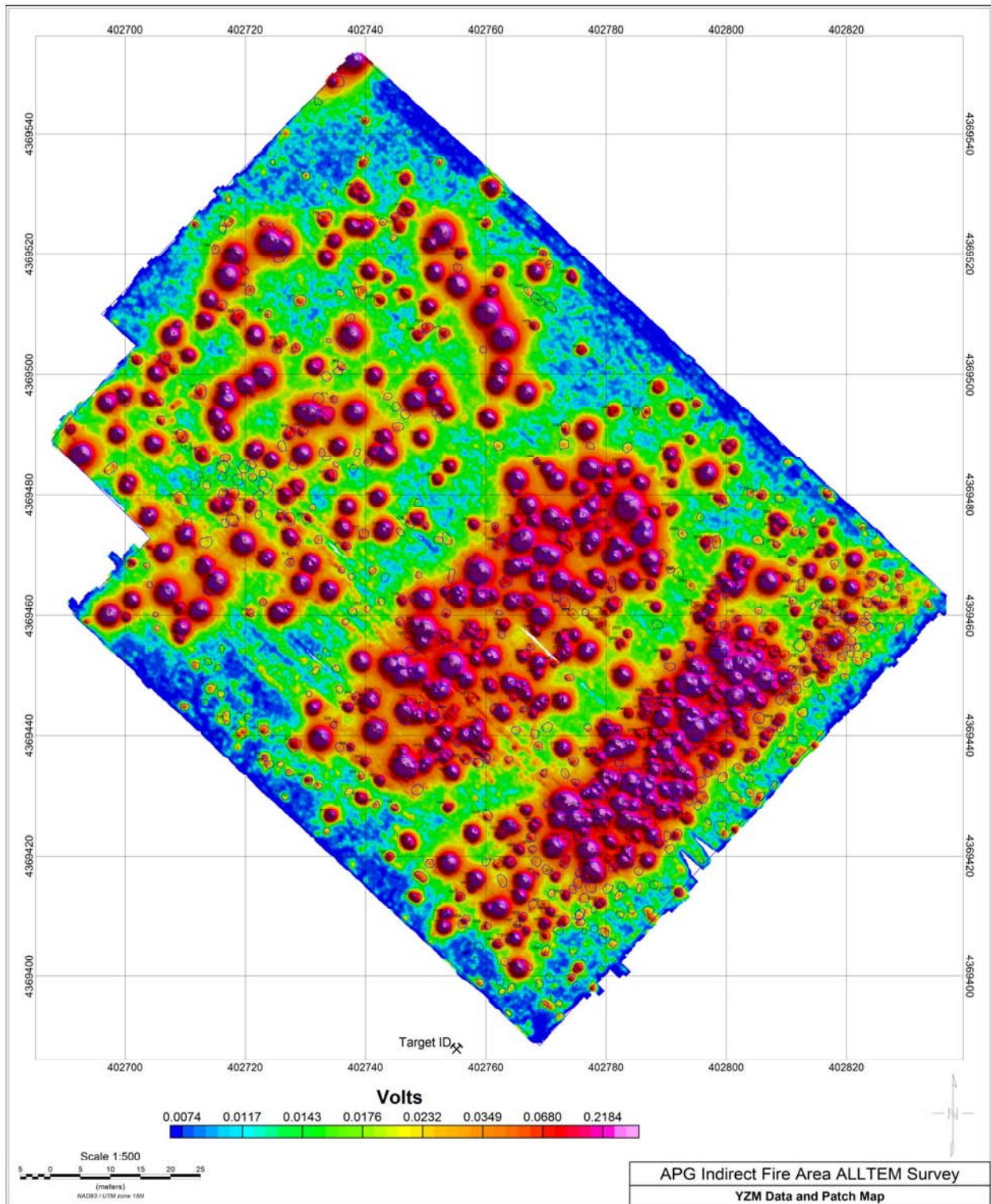

Appendix 2 – ALLTEM Data and Signal to Noise Maps

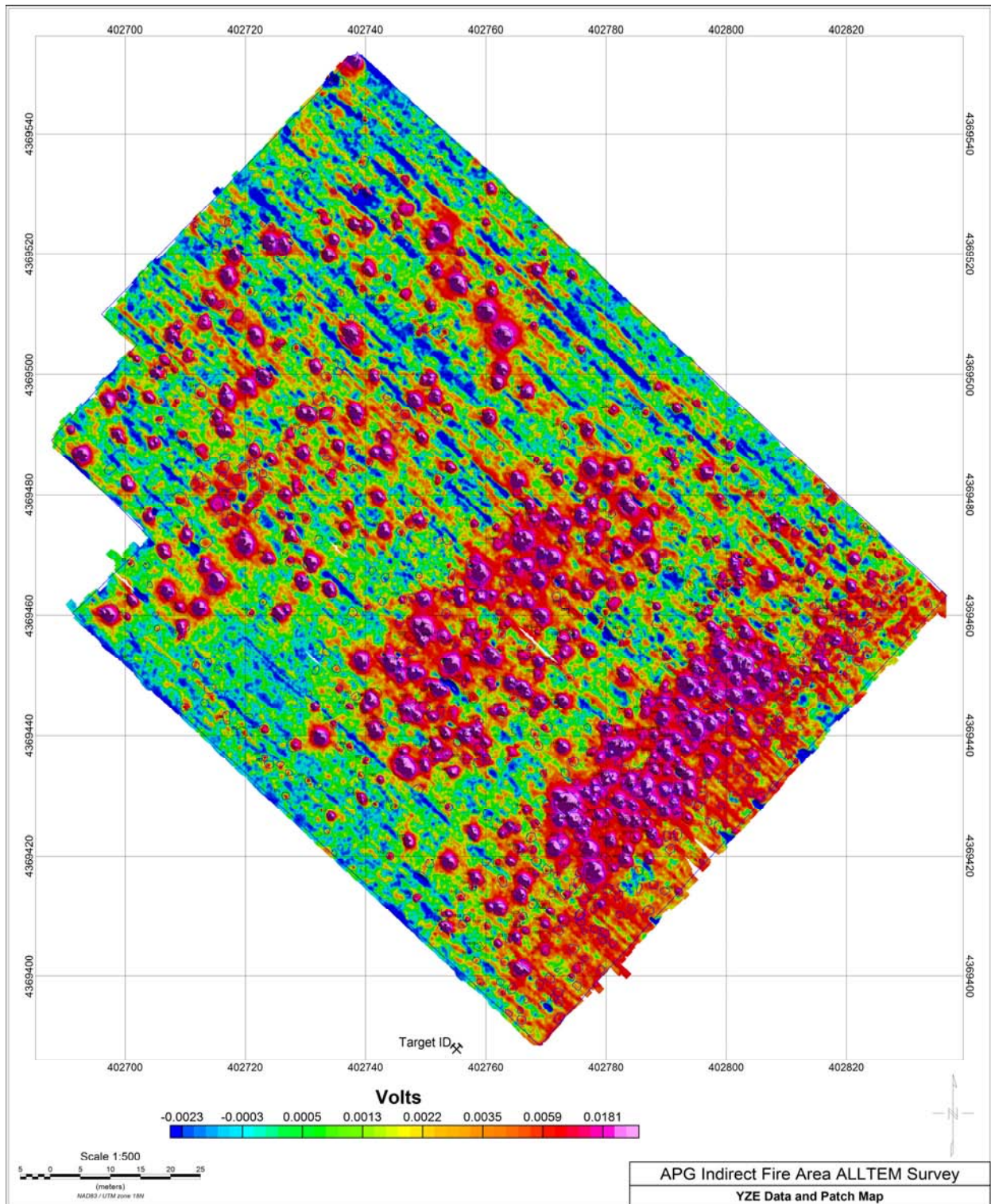

Appendix 2 – ALLTEM Data and Signal to Noise Maps

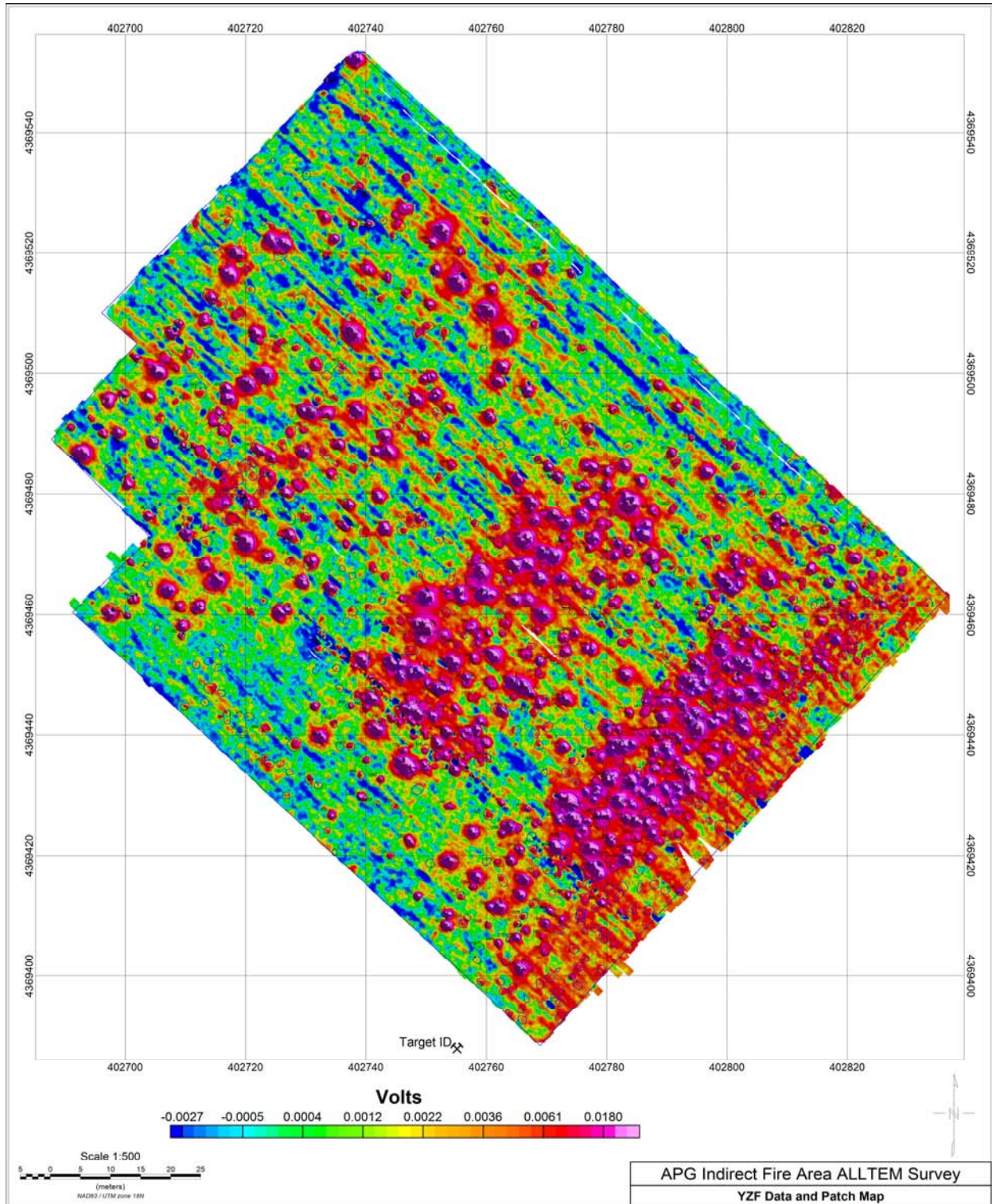

Appendix 2 – ALLTEM Data and Signal to Noise Maps

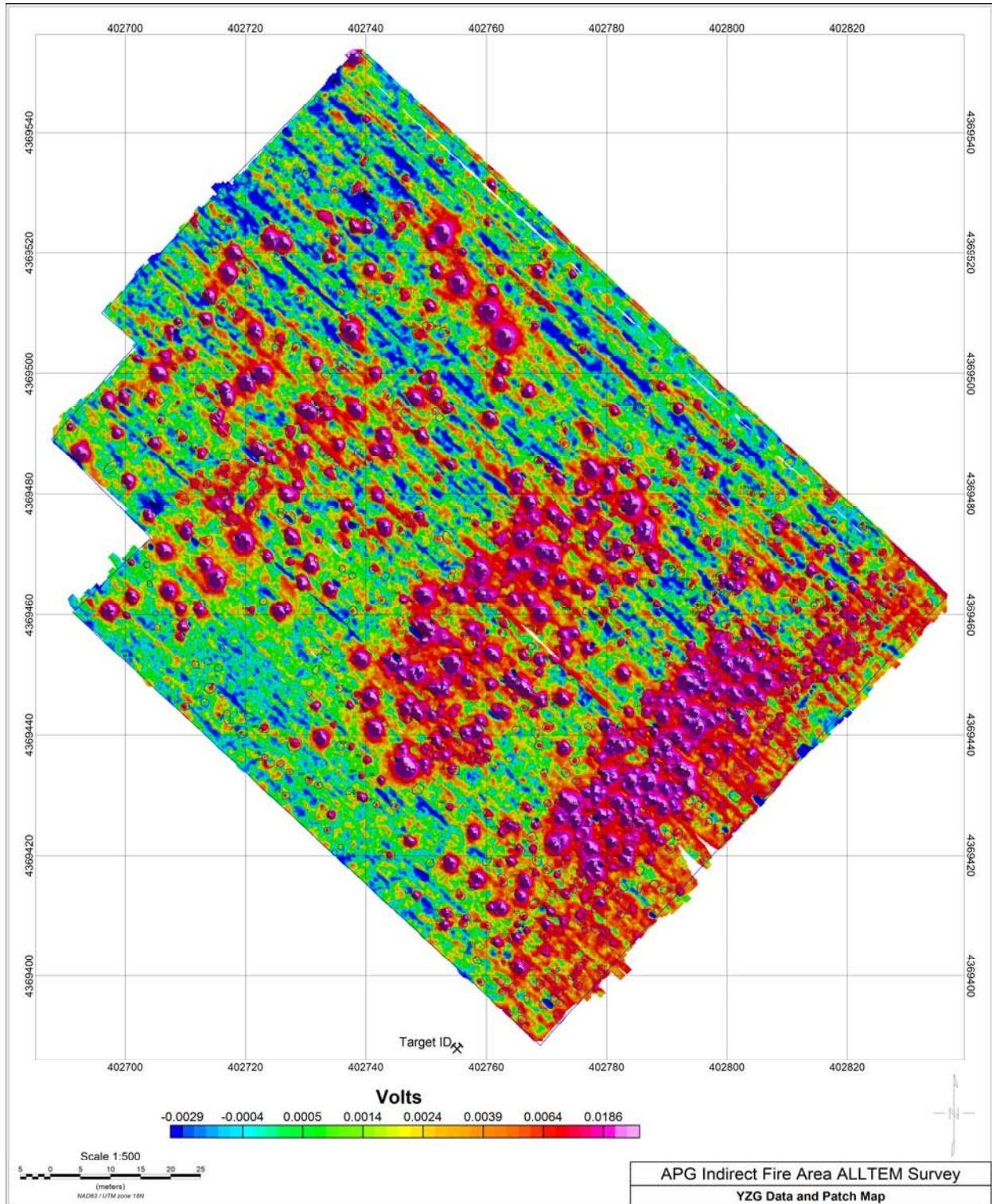

Appendix 2 – ALLTEM Data and Signal to Noise Maps

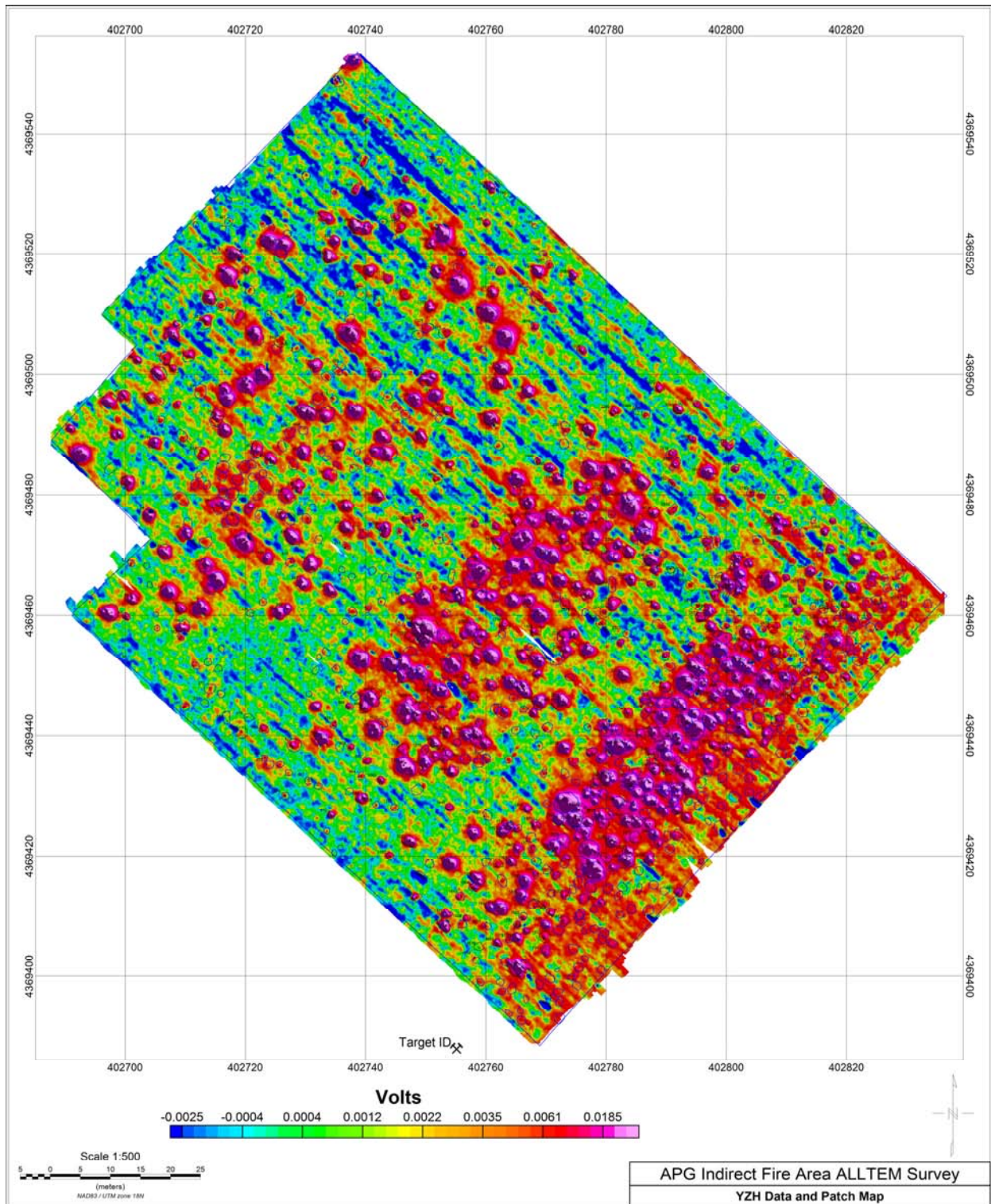

Appendix 2 – ALLTEM Data and Signal to Noise Maps

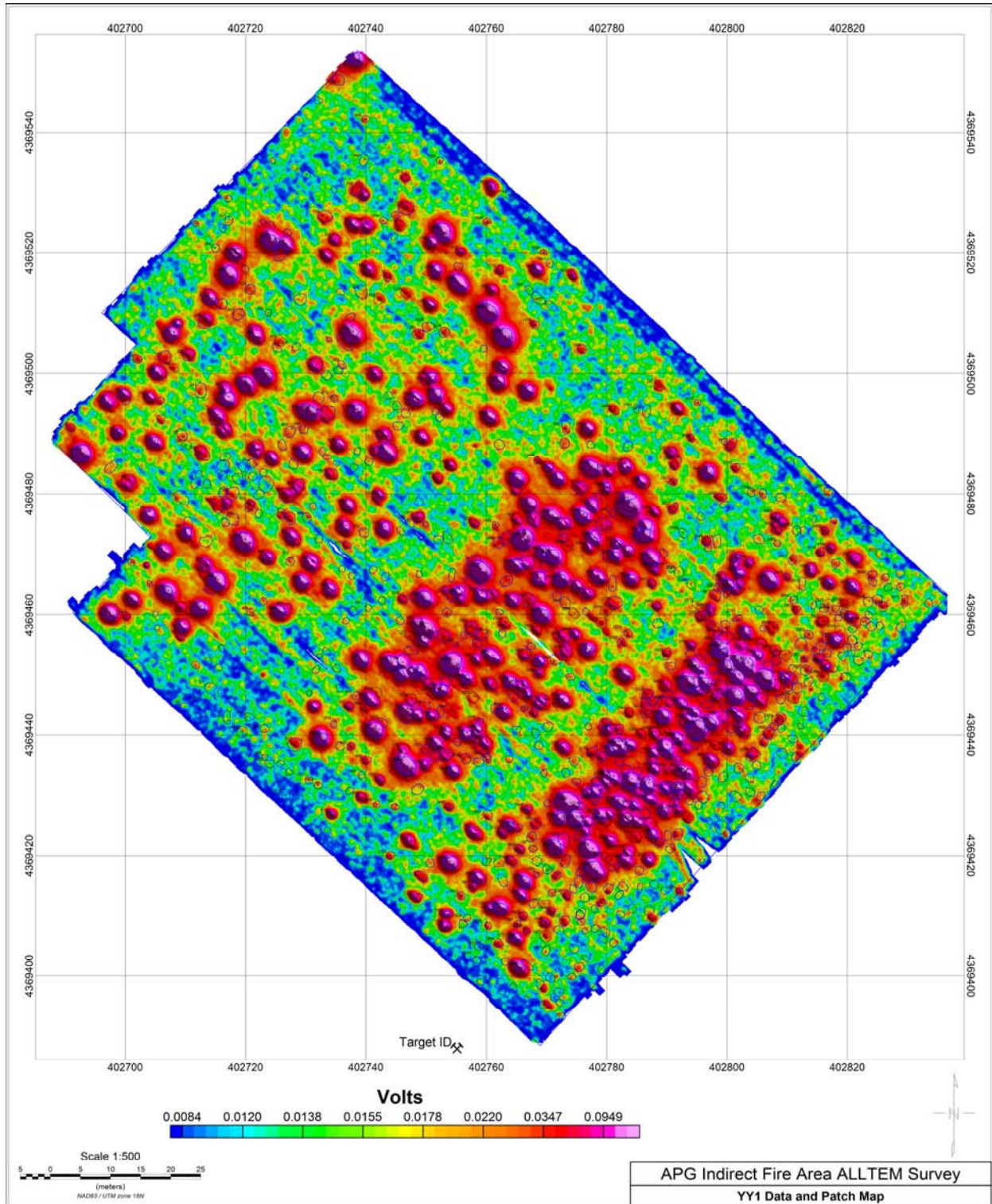

Appendix 2 – ALLTEM Data and Signal to Noise Maps

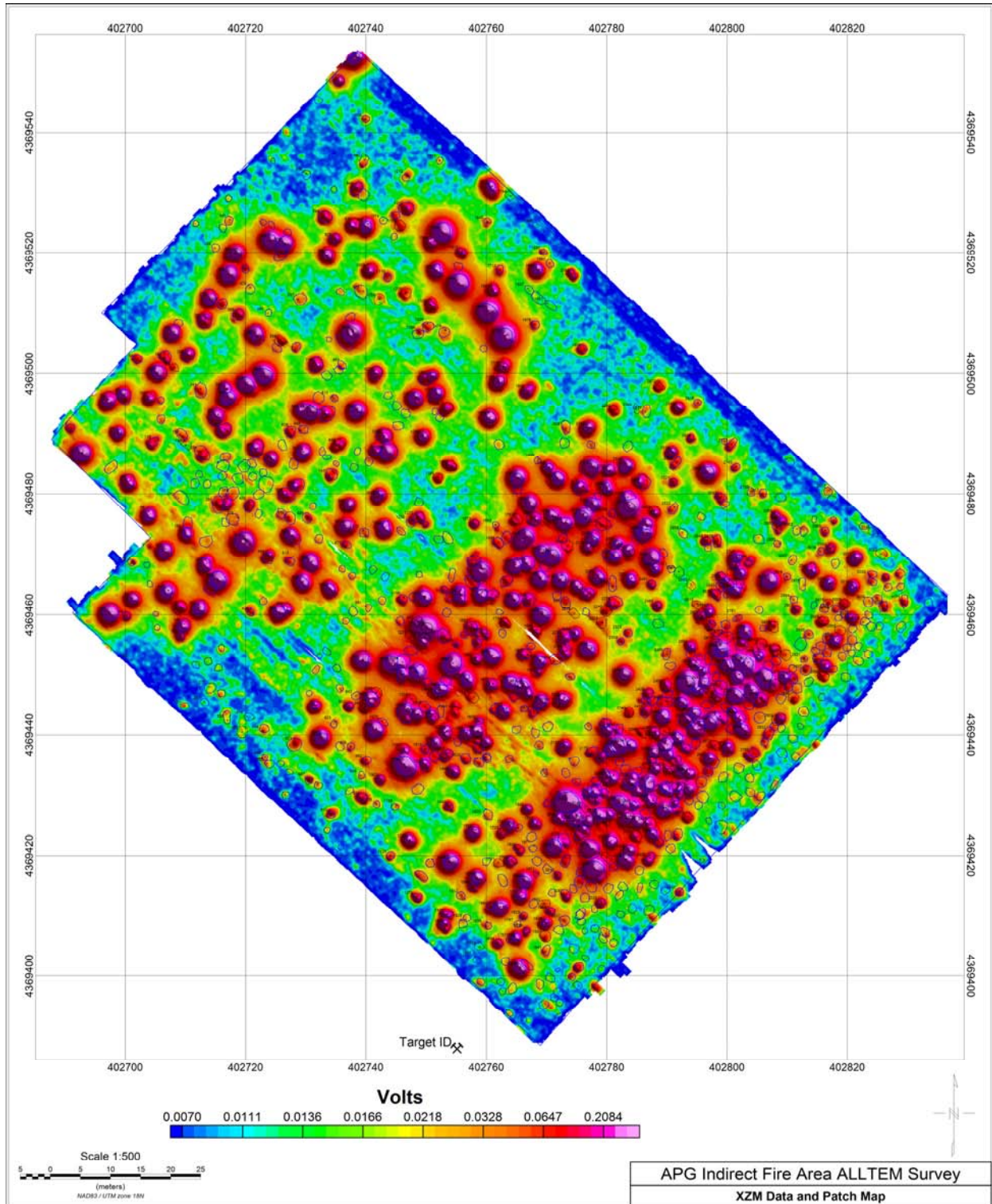

Appendix 2 – ALLTEM Data and Signal to Noise Maps

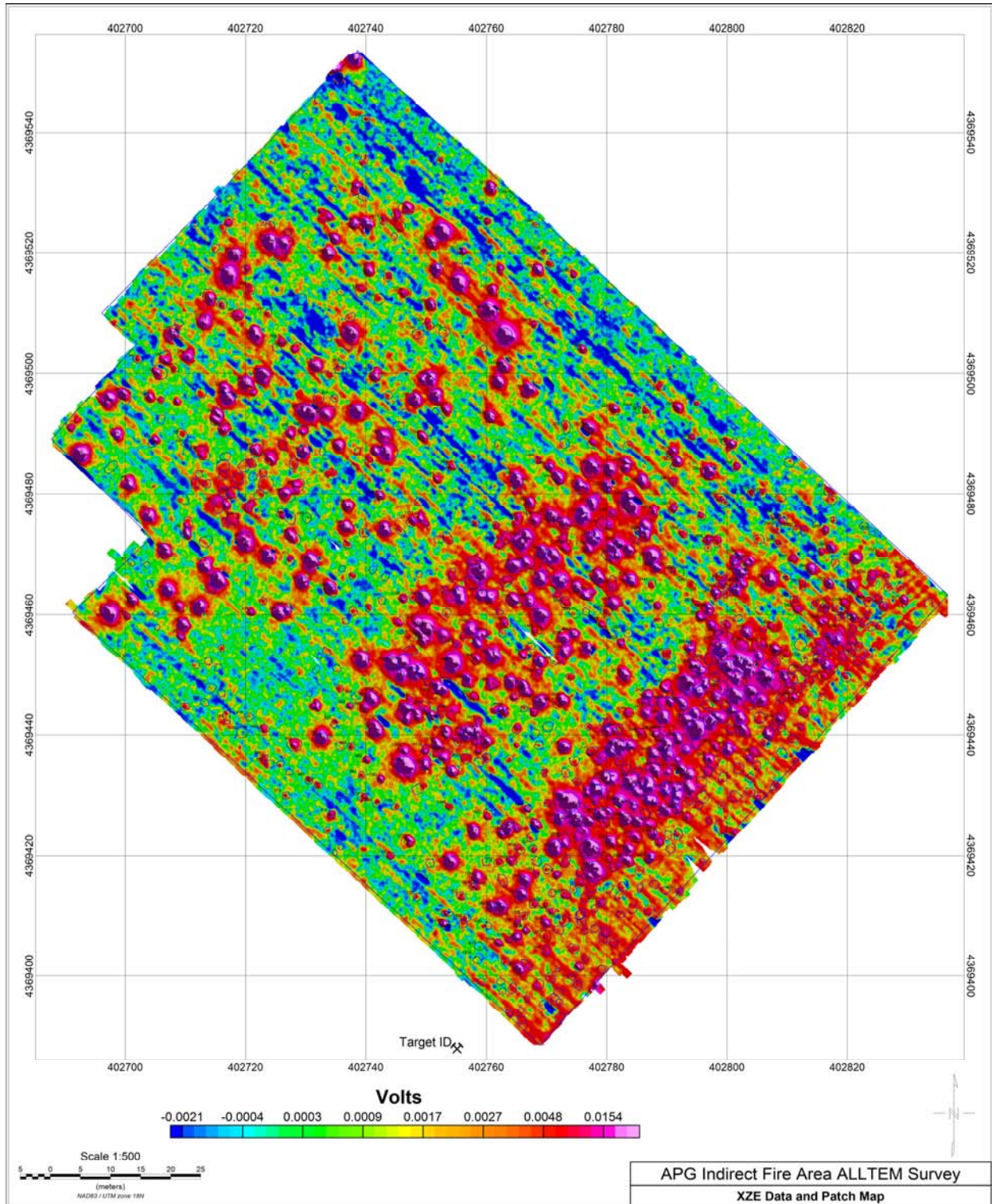

Appendix 2 – ALLTEM Data and Signal to Noise Maps

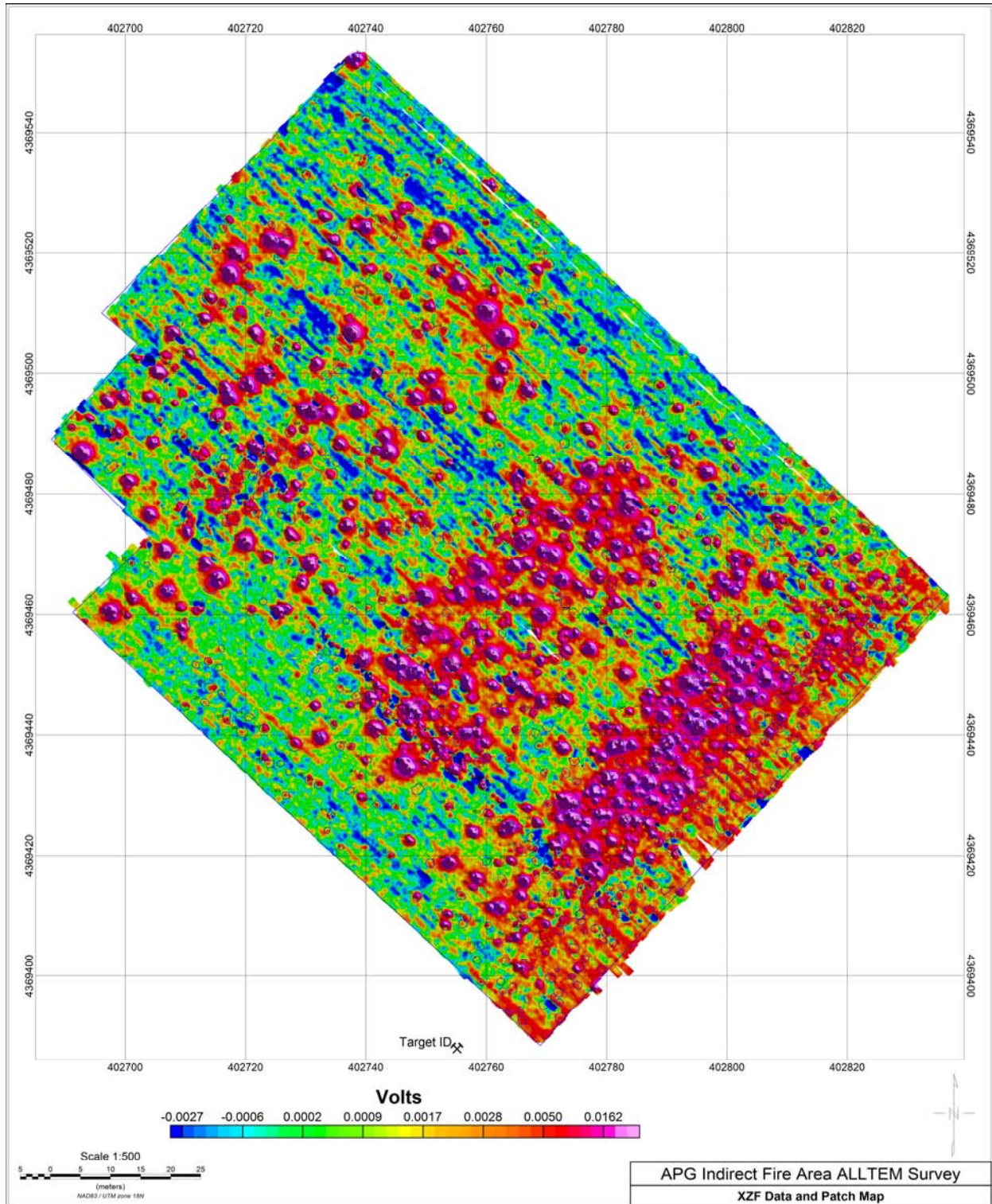

Appendix 2 – ALLTEM Data and Signal to Noise Maps

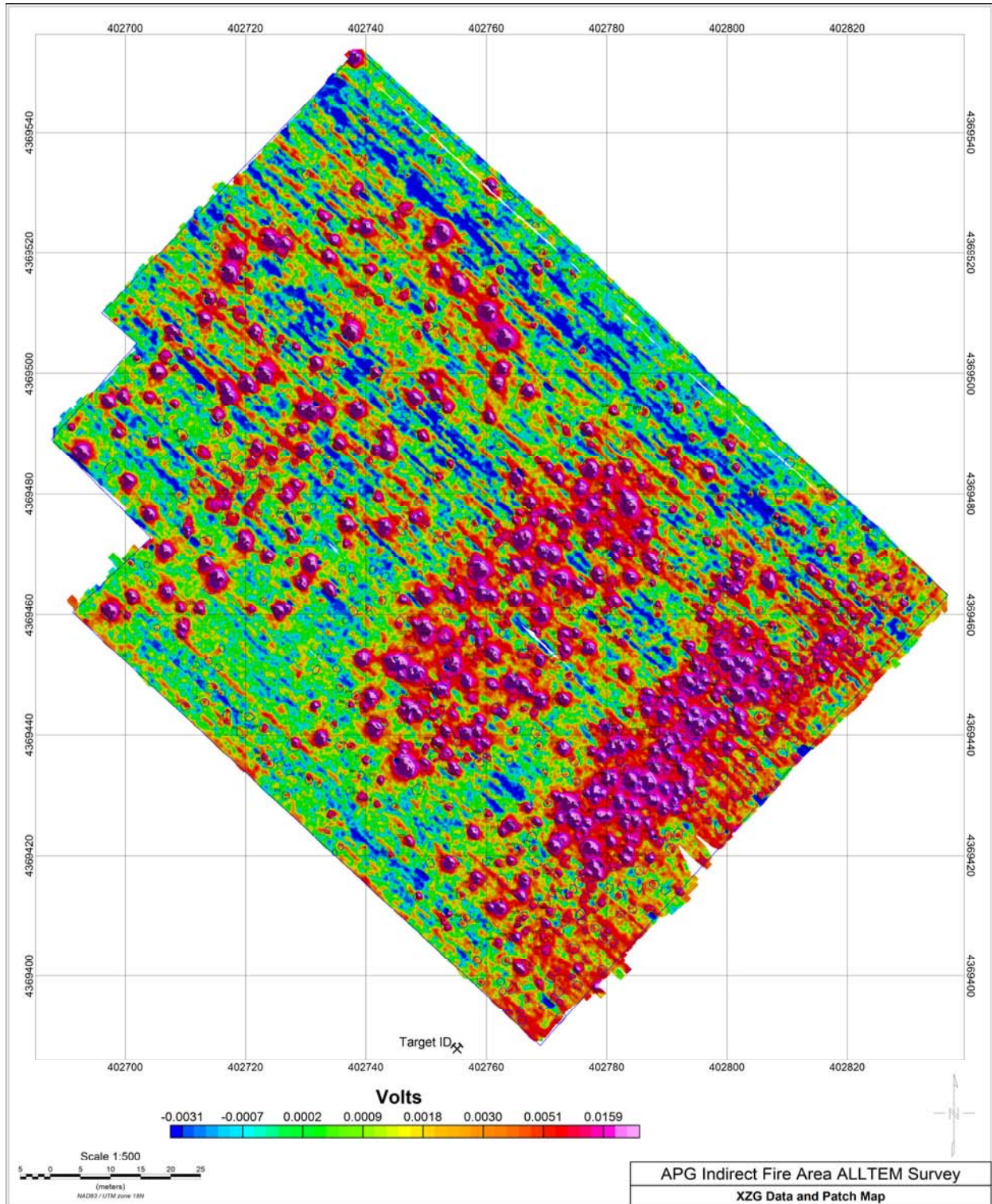

Appendix 2 – ALLTEM Data and Signal to Noise Maps

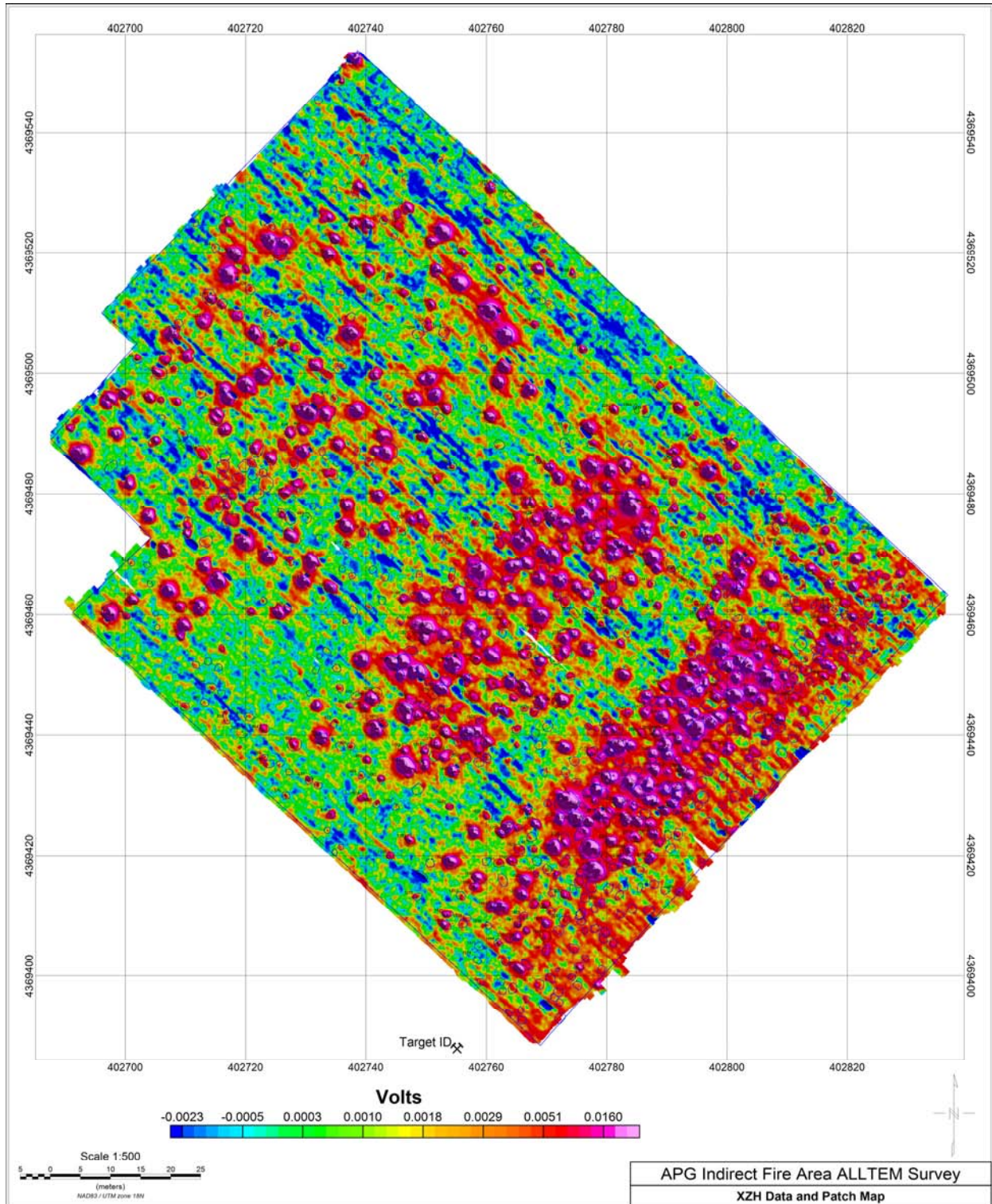

Appendix 2 – ALLTEM Data and Signal to Noise Maps

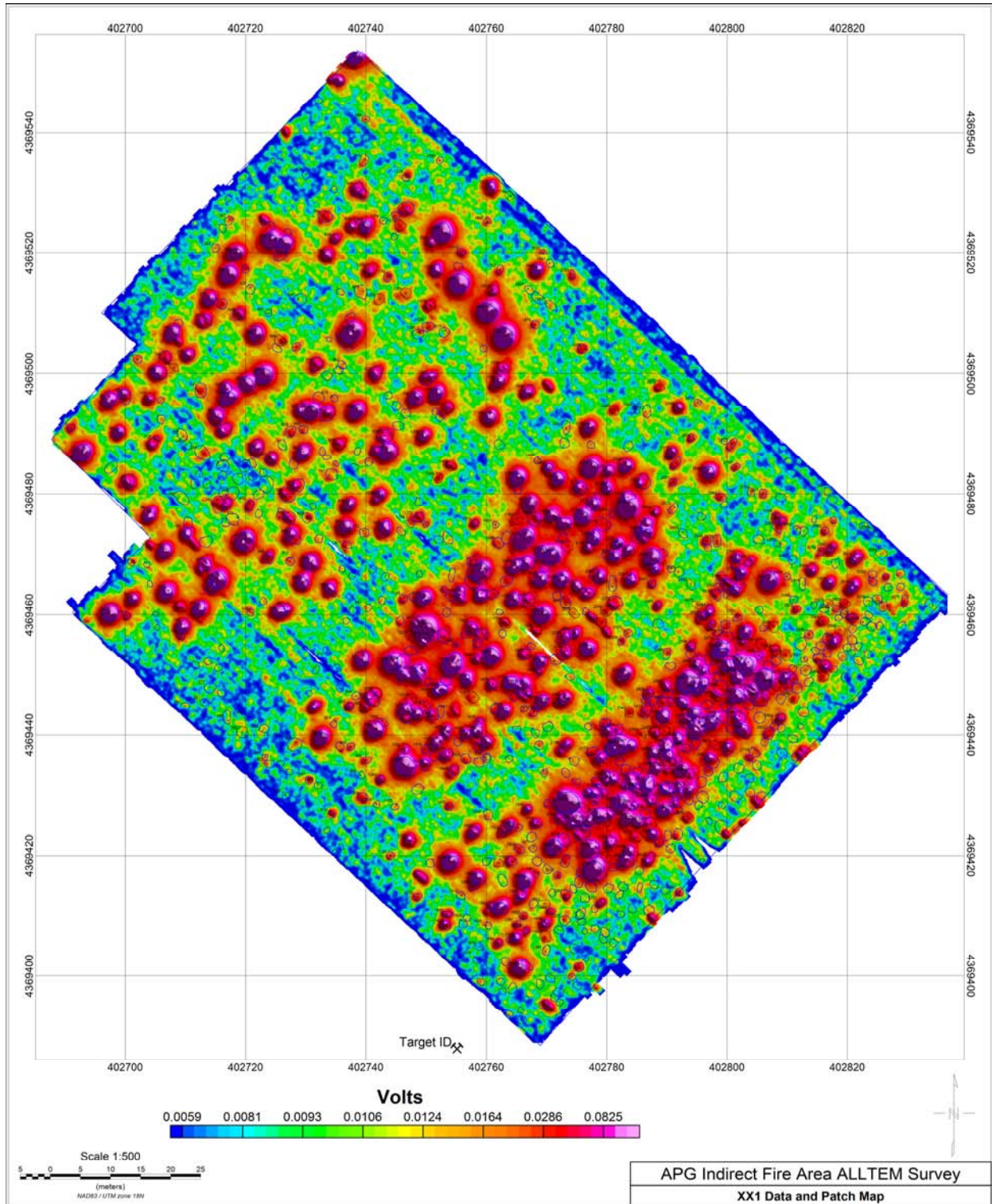

Appendix 2 – ALLTEM Data and Signal to Noise Maps

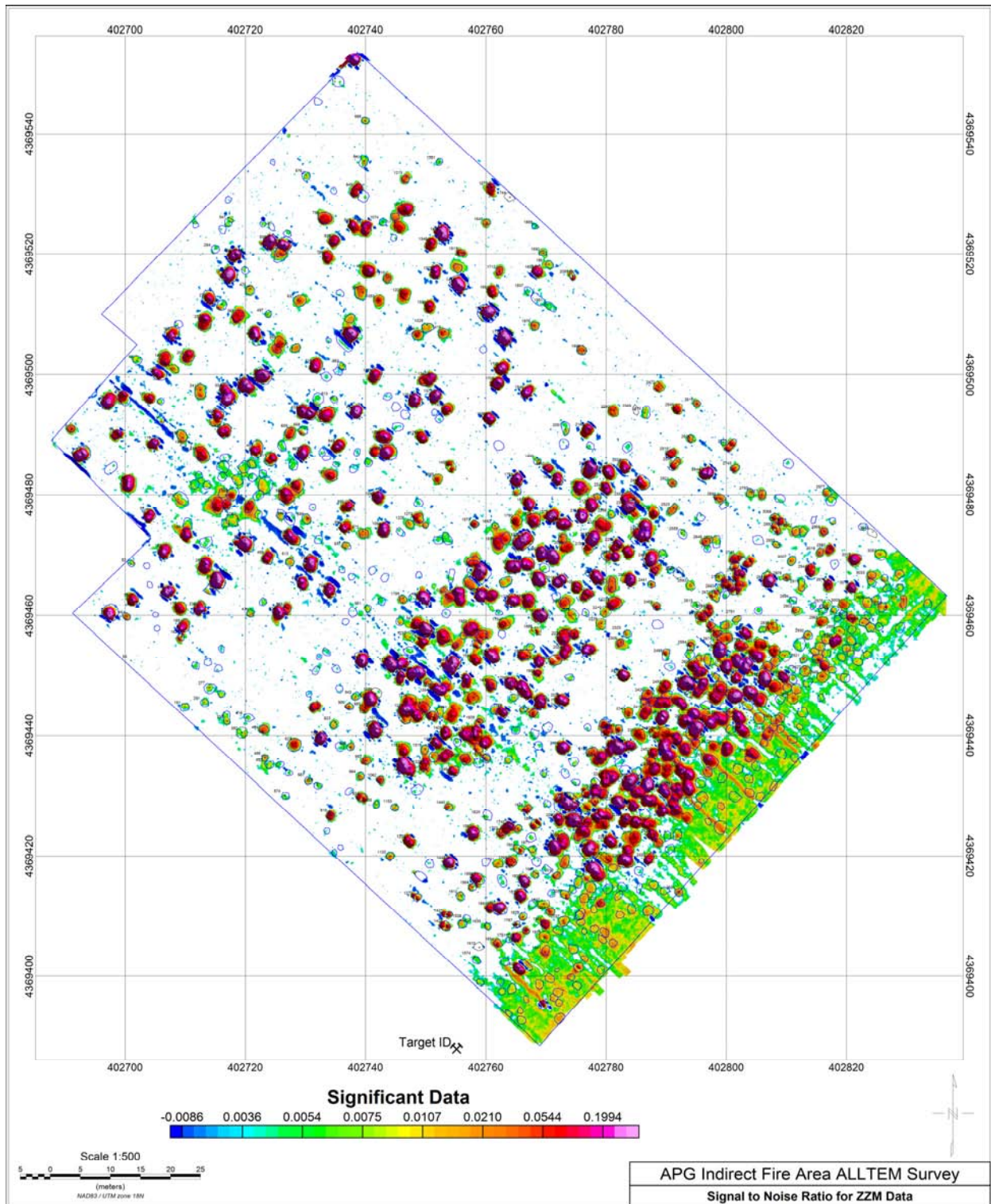

Appendix 2 – ALLTEM Data and Signal to Noise Maps

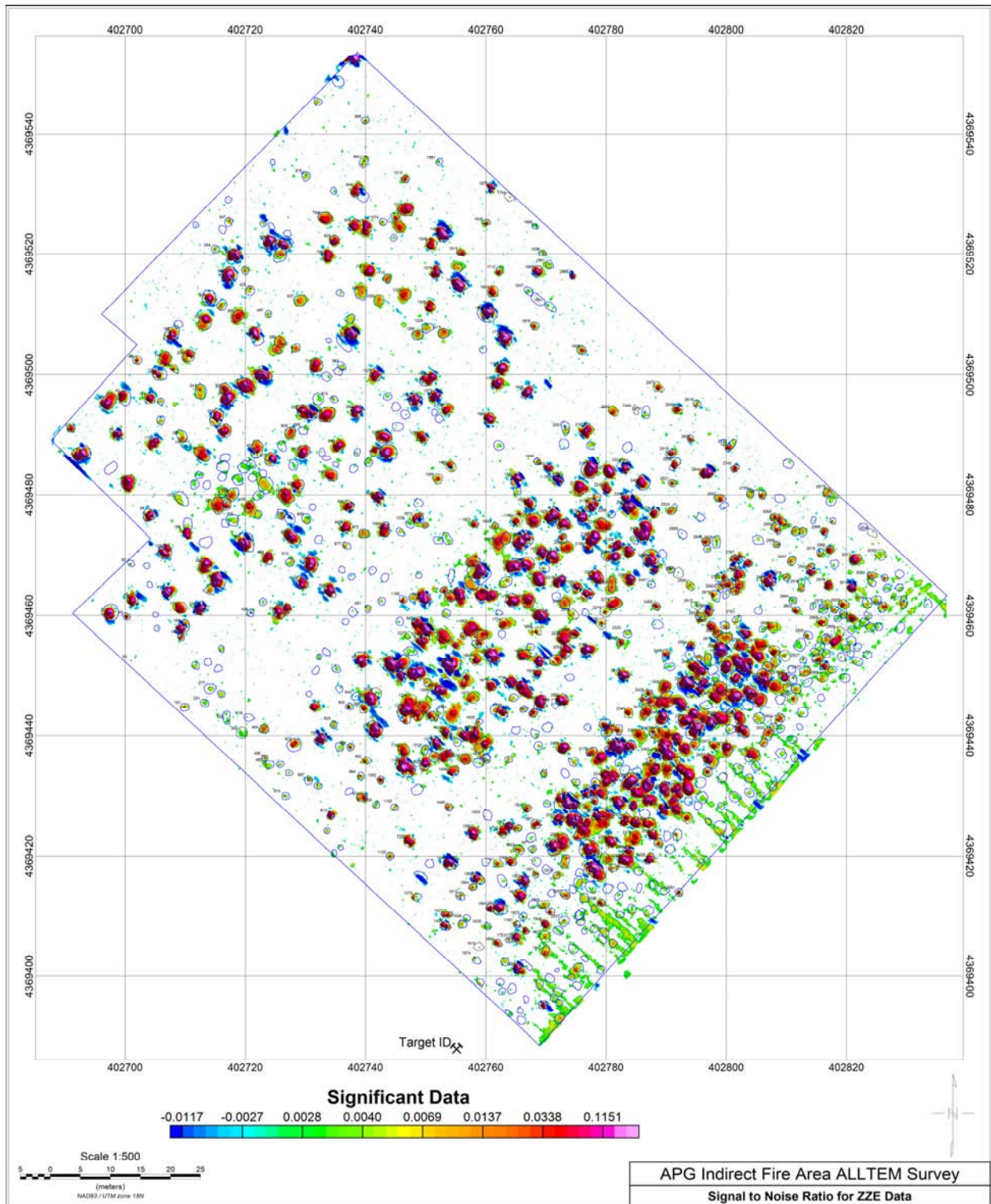

Appendix 2 – ALLTEM Data and Signal to Noise Maps

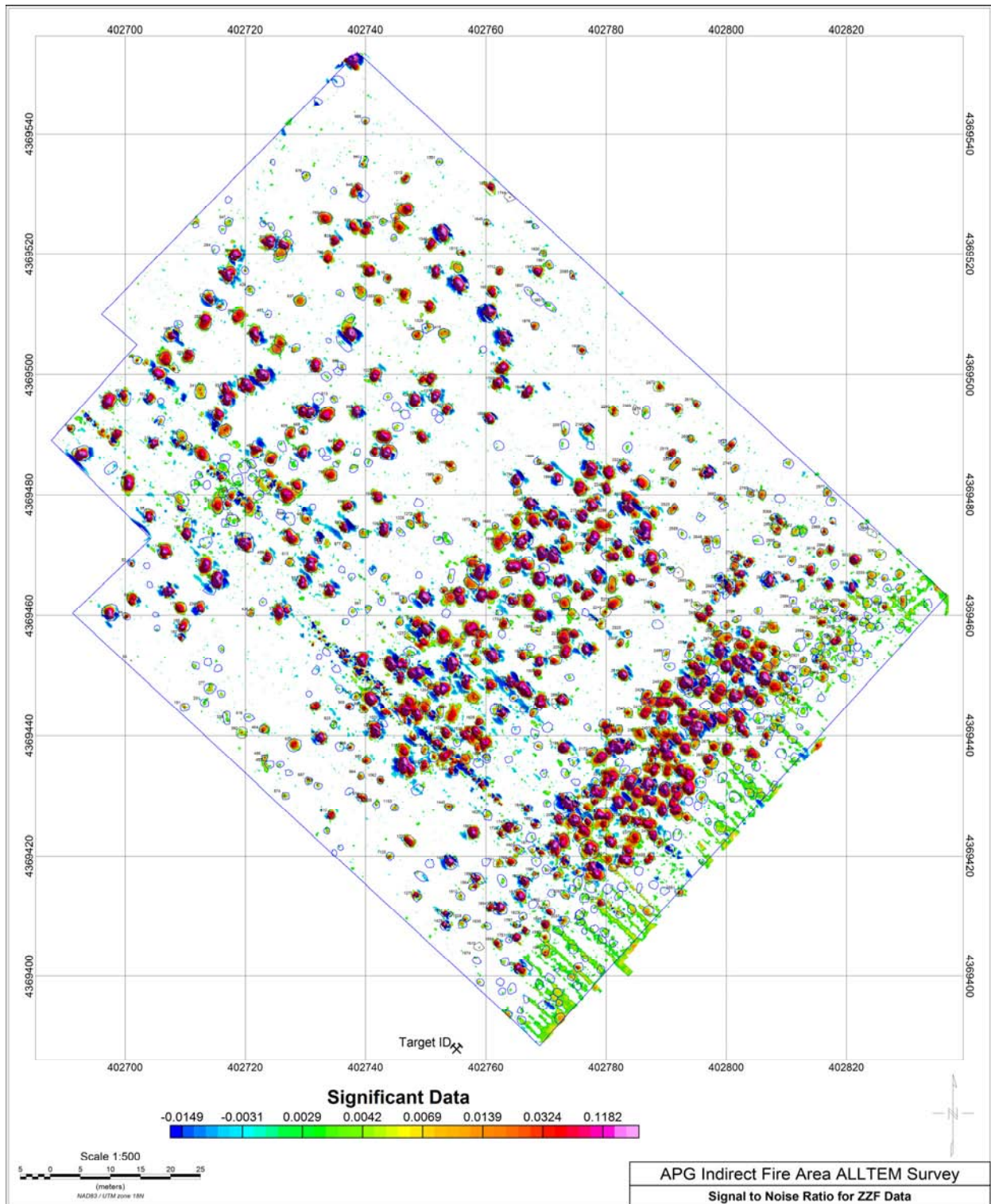

Appendix 2 – ALLTEM Data and Signal to Noise Maps

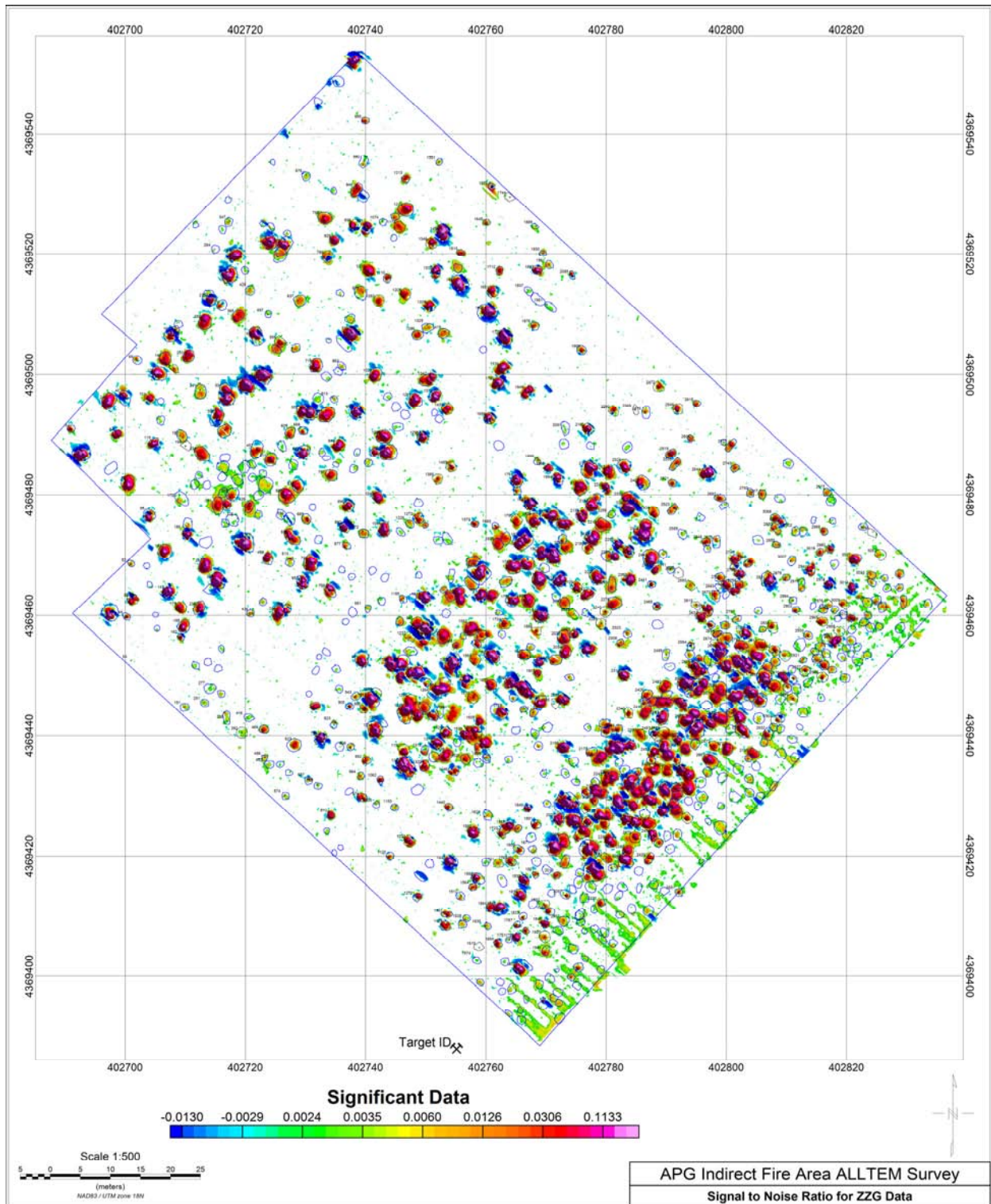

Appendix 2 – ALLTEM Data and Signal to Noise Maps

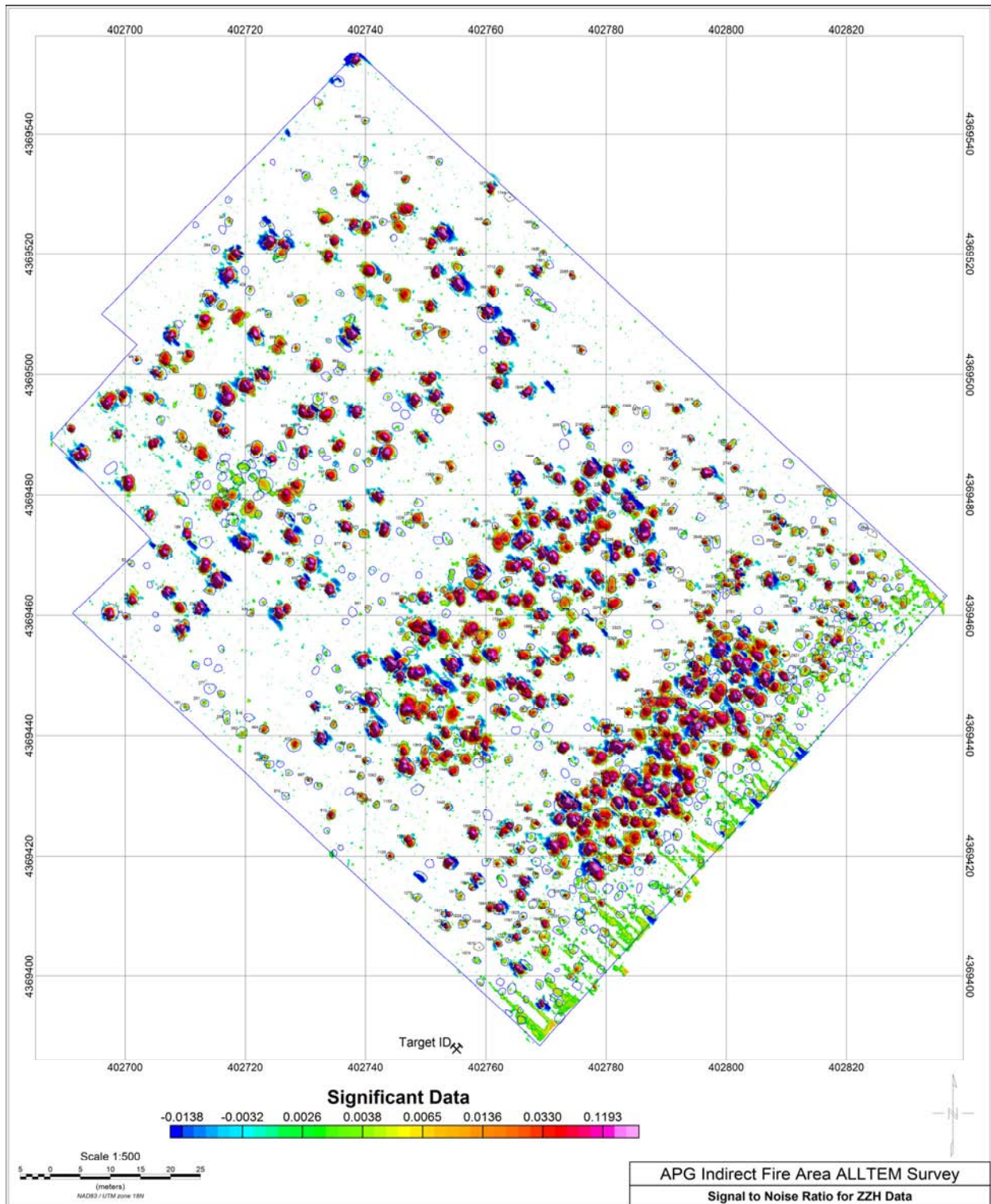

Appendix 2 – ALLTEM Data and Signal to Noise Maps

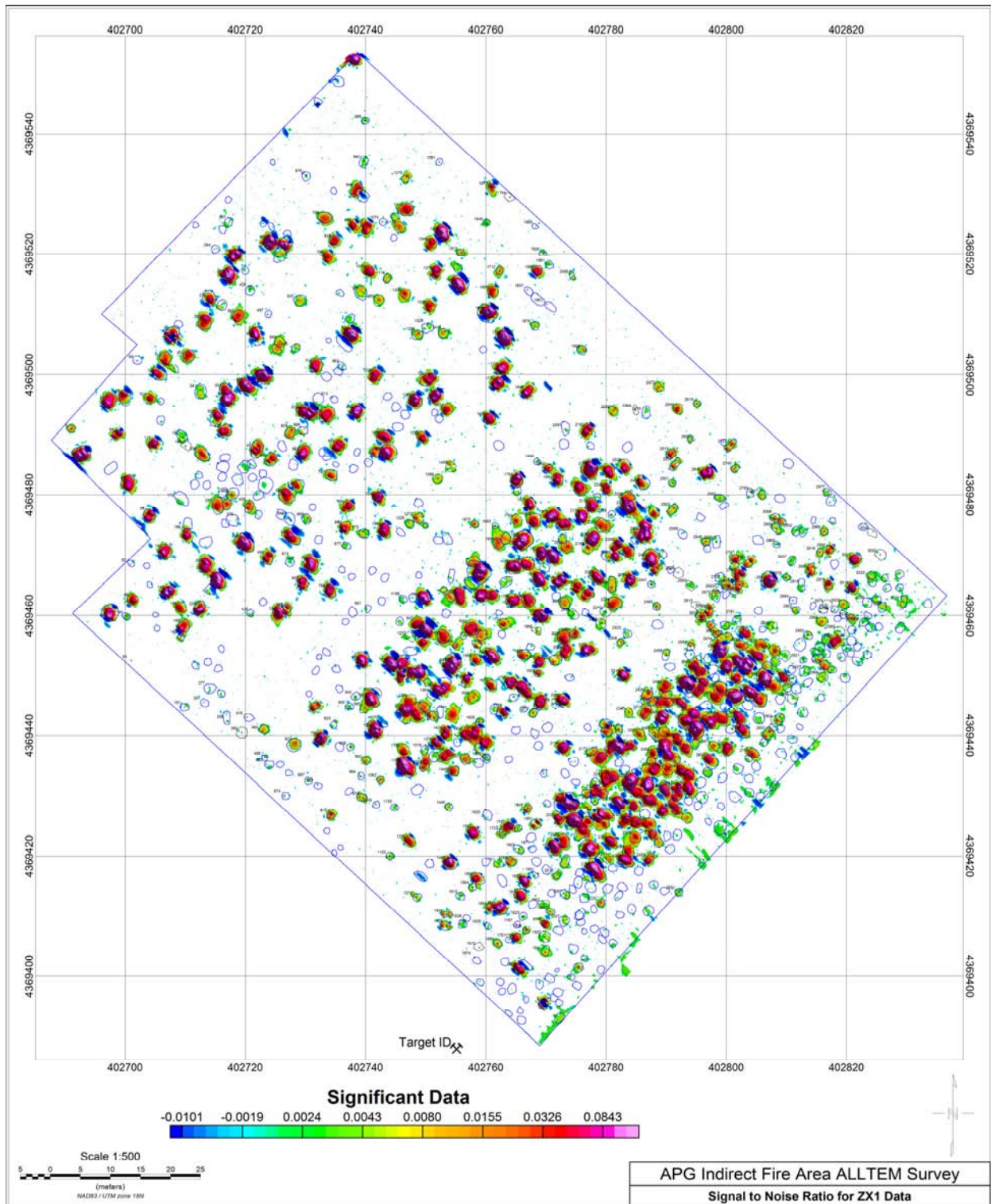

Appendix 2 – ALLTEM Data and Signal to Noise Maps

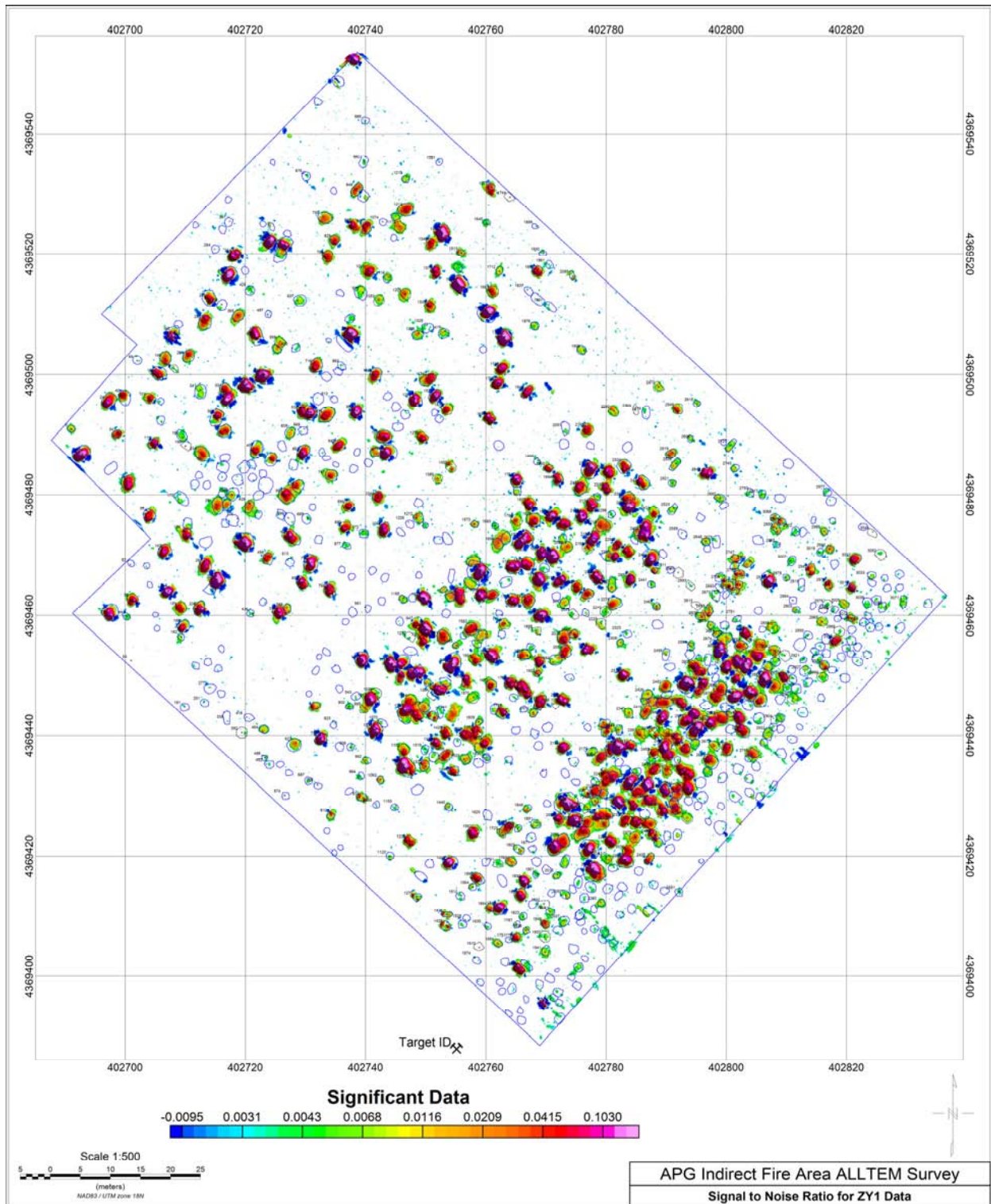

Appendix 2 – ALLTEM Data and Signal to Noise Maps

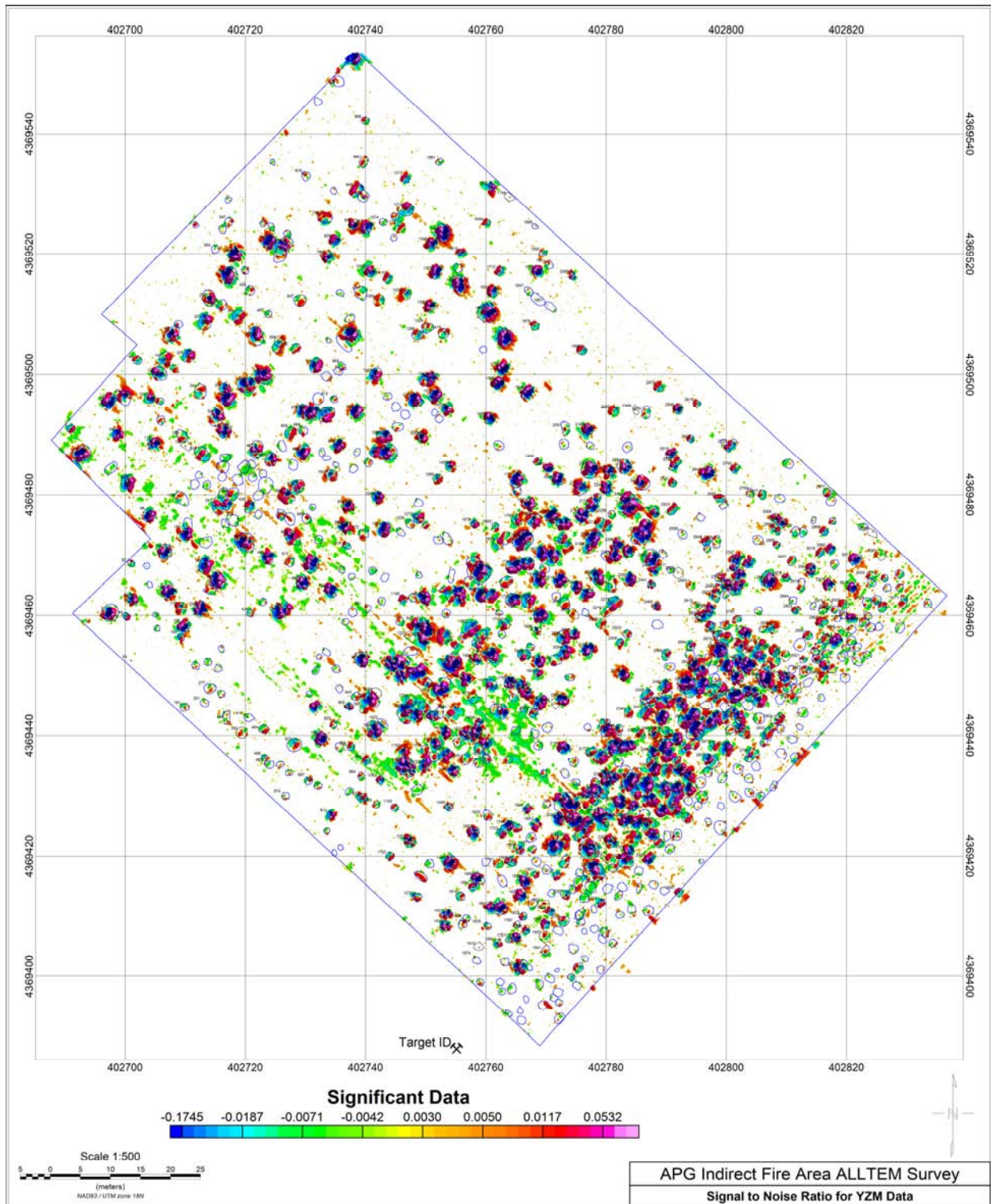

Appendix 2 – ALLTEM Data and Signal to Noise Maps

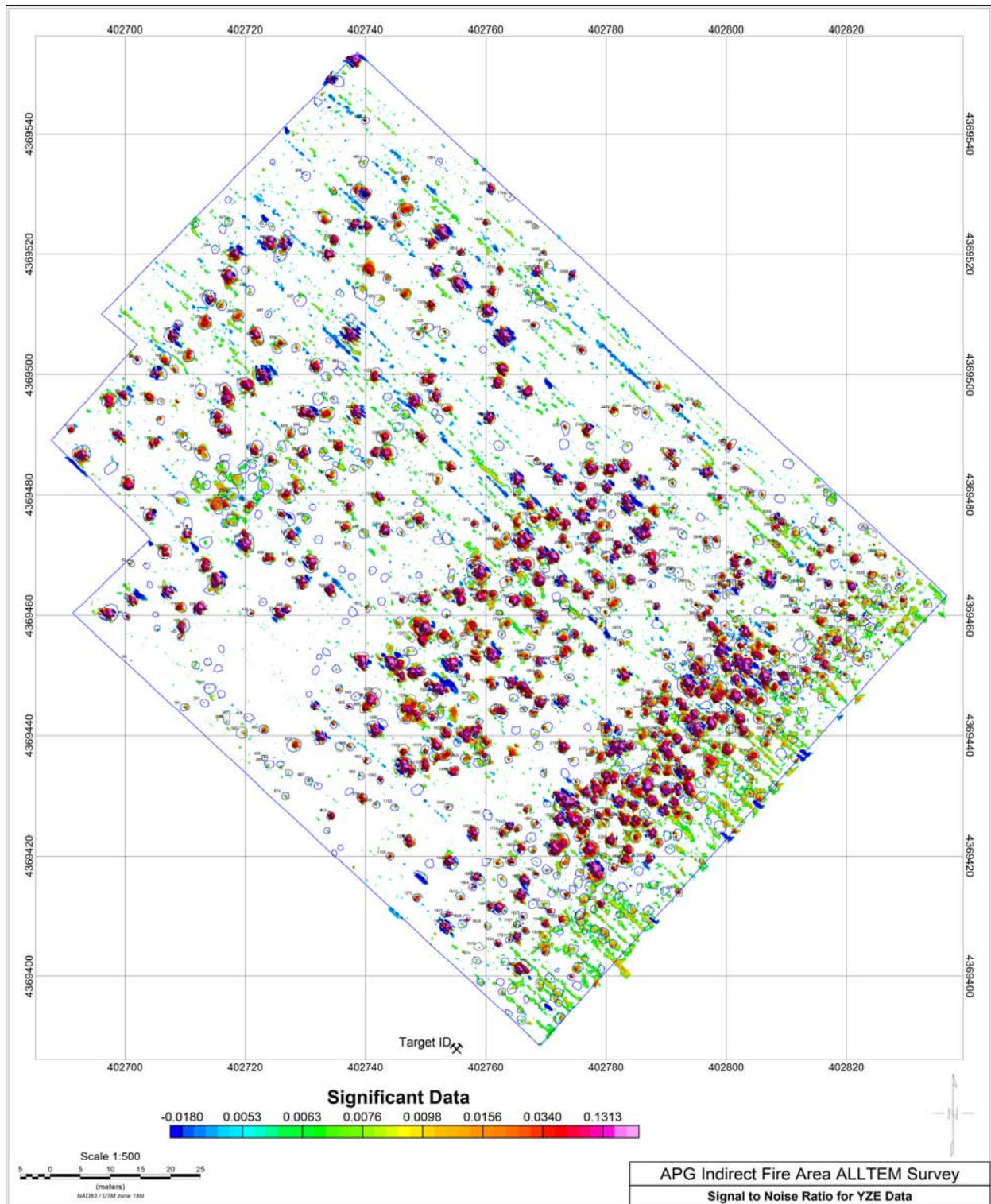

Appendix 2 – ALLTEM Data and Signal to Noise Maps

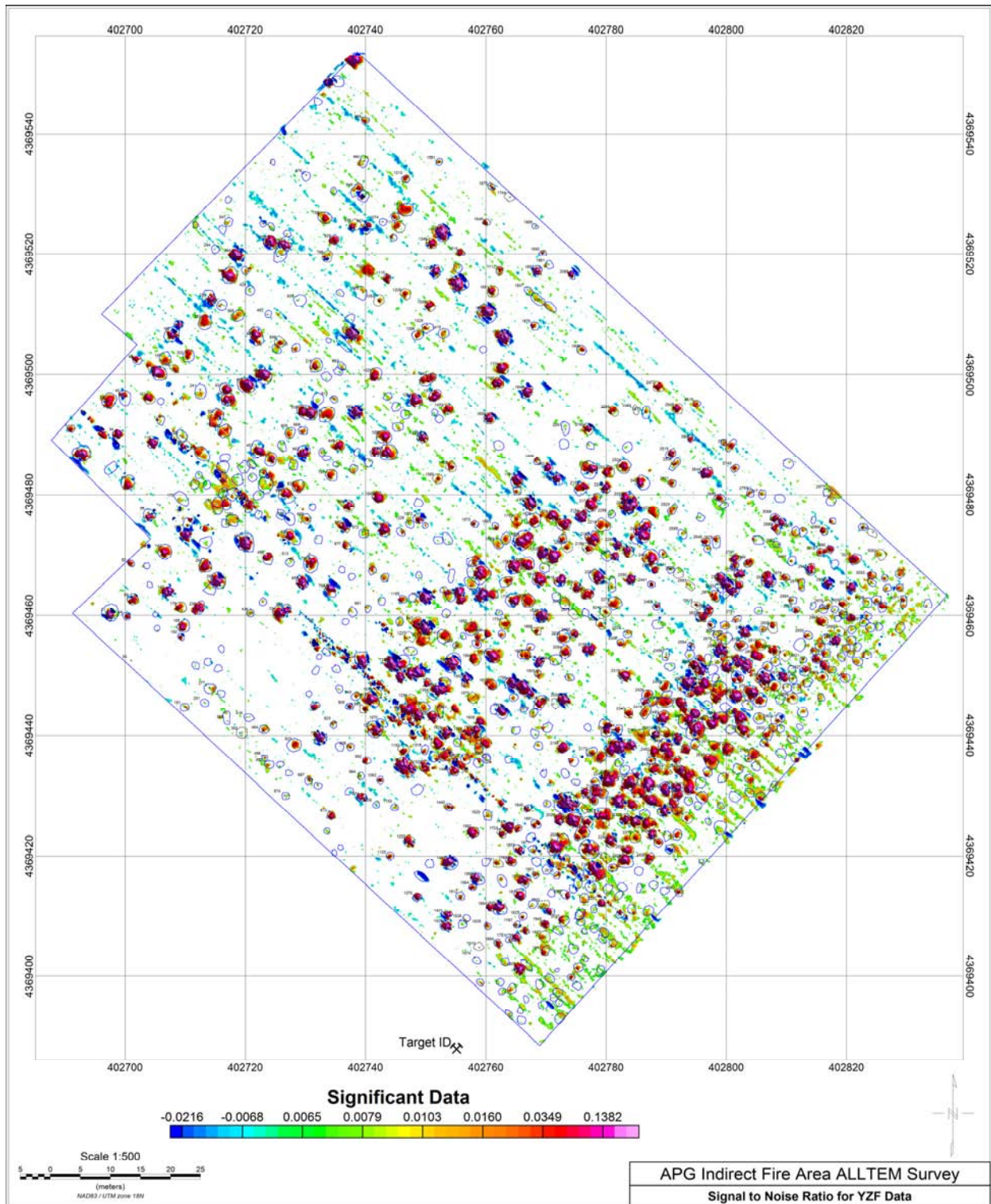

Appendix 2 – ALLTEM Data and Signal to Noise Maps

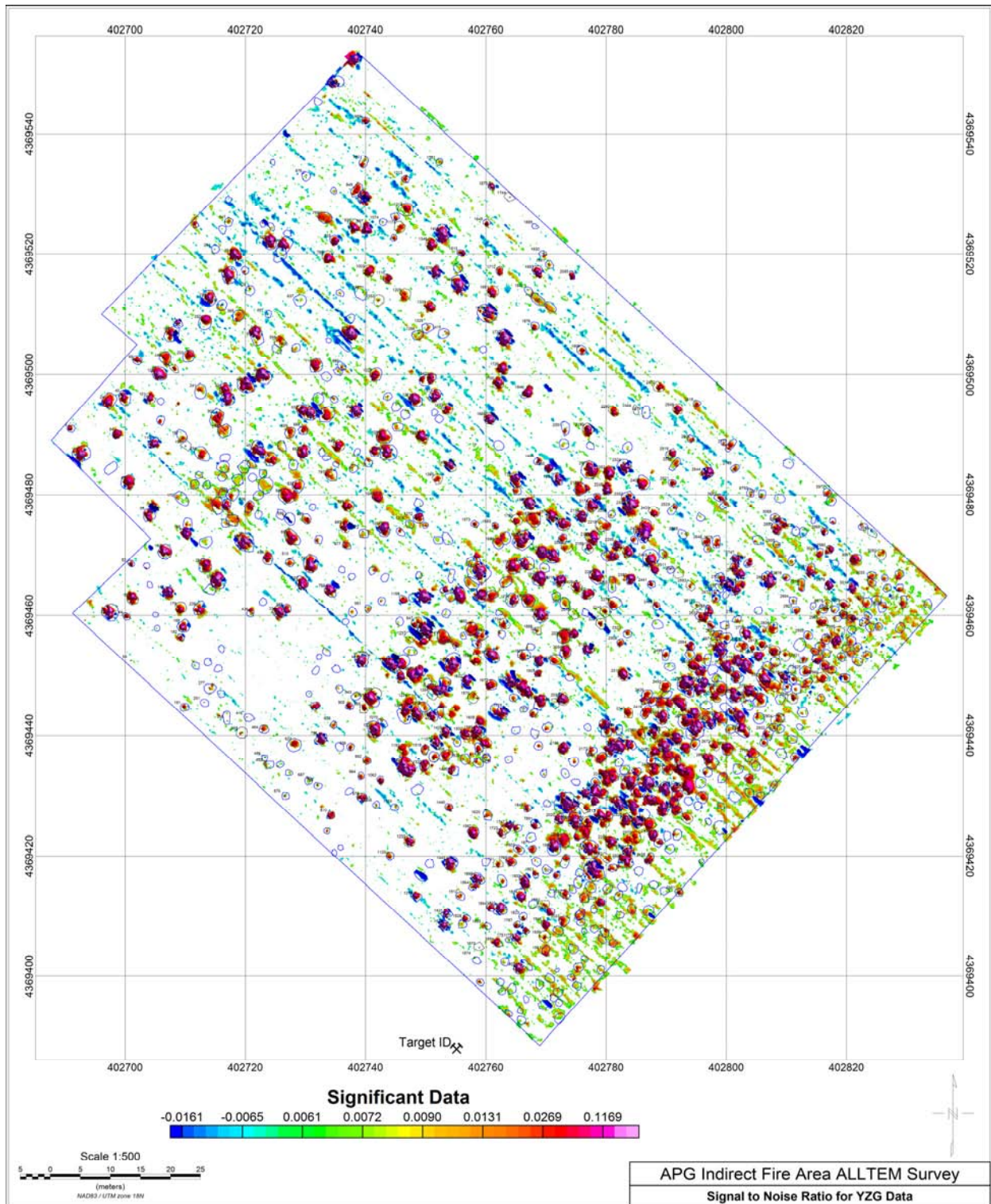

Appendix 2 – ALLTEM Data and Signal to Noise Maps

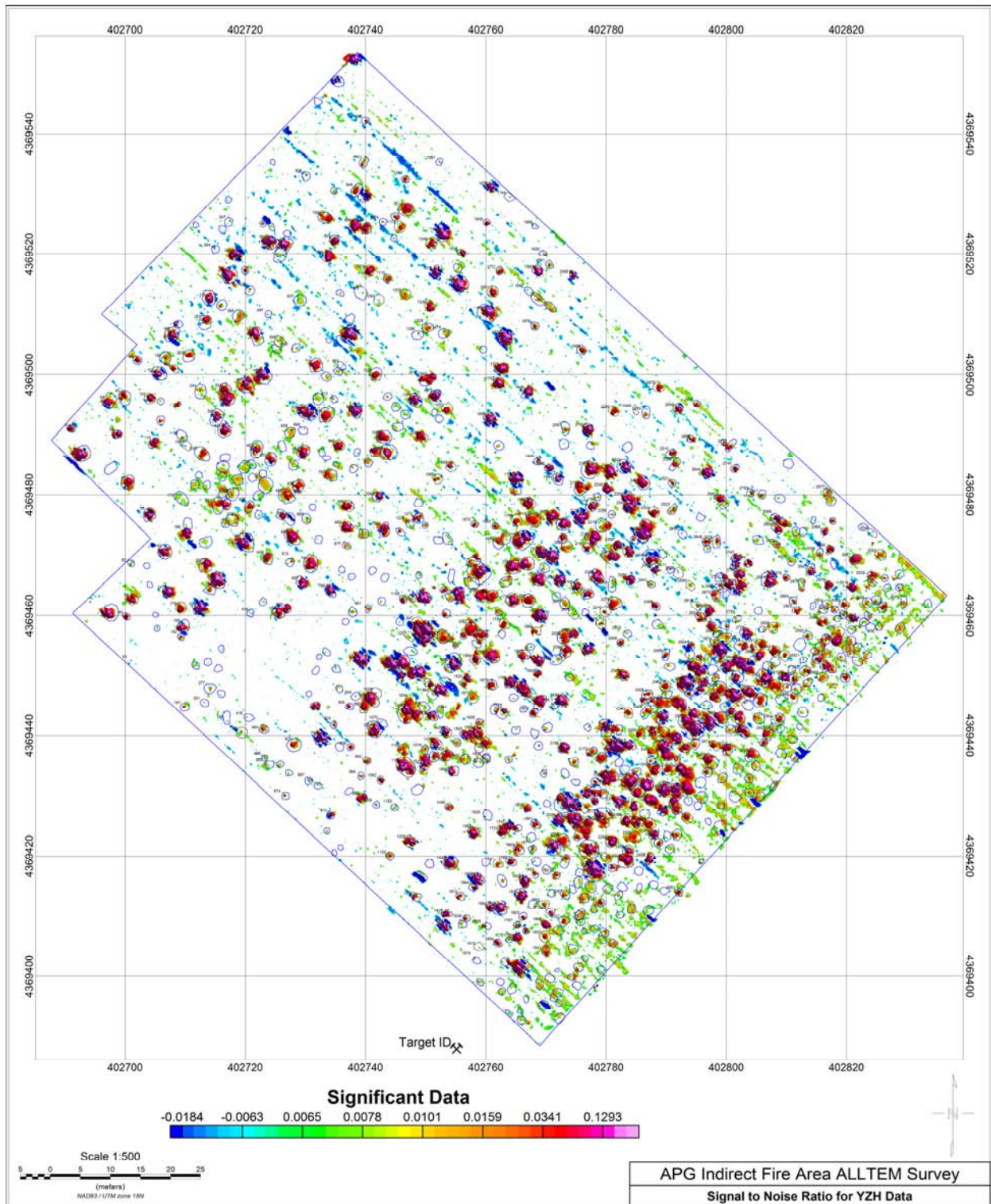

Appendix 2 – ALLTEM Data and Signal to Noise Maps

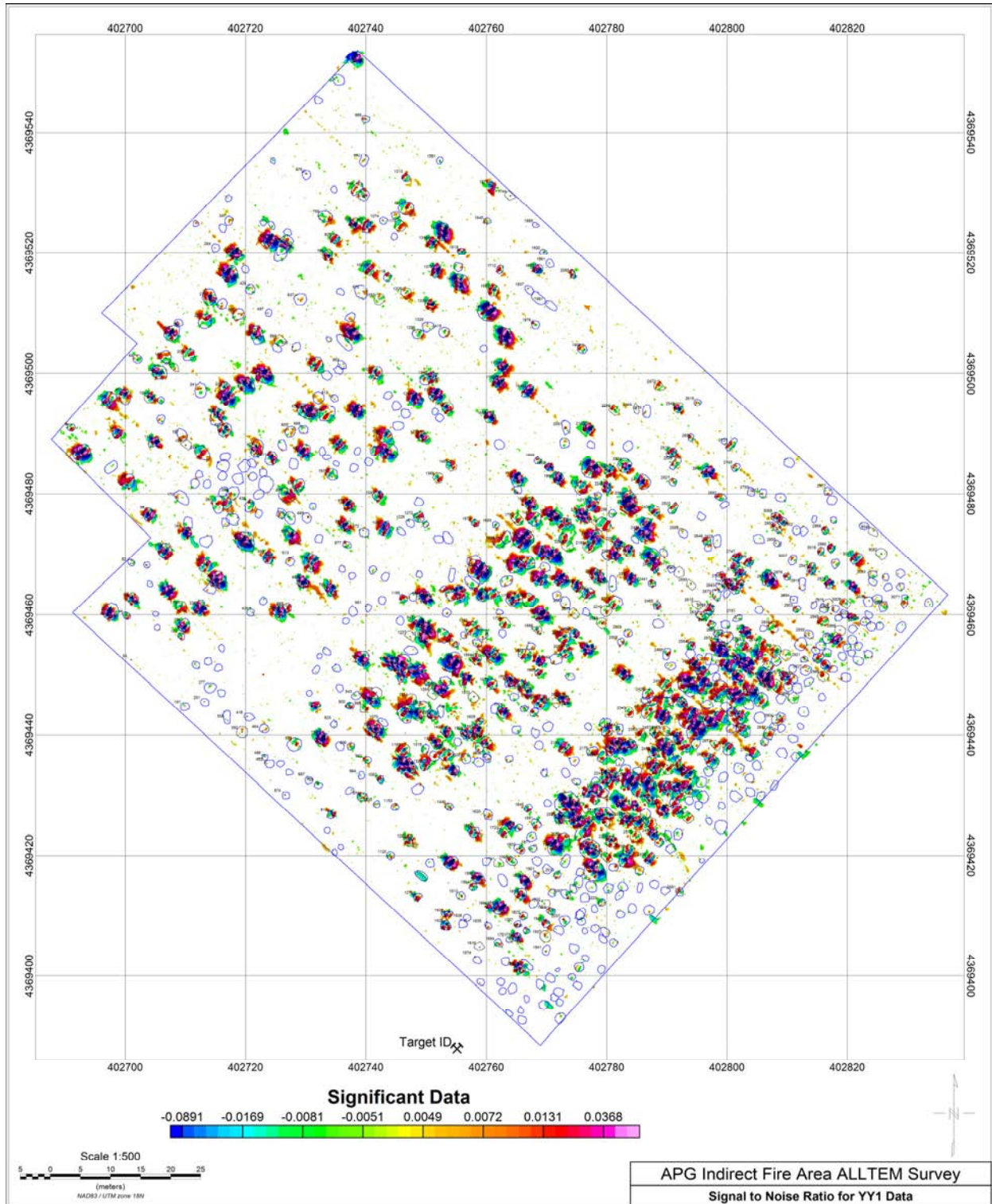

Appendix 2 – ALLTEM Data and Signal to Noise Maps

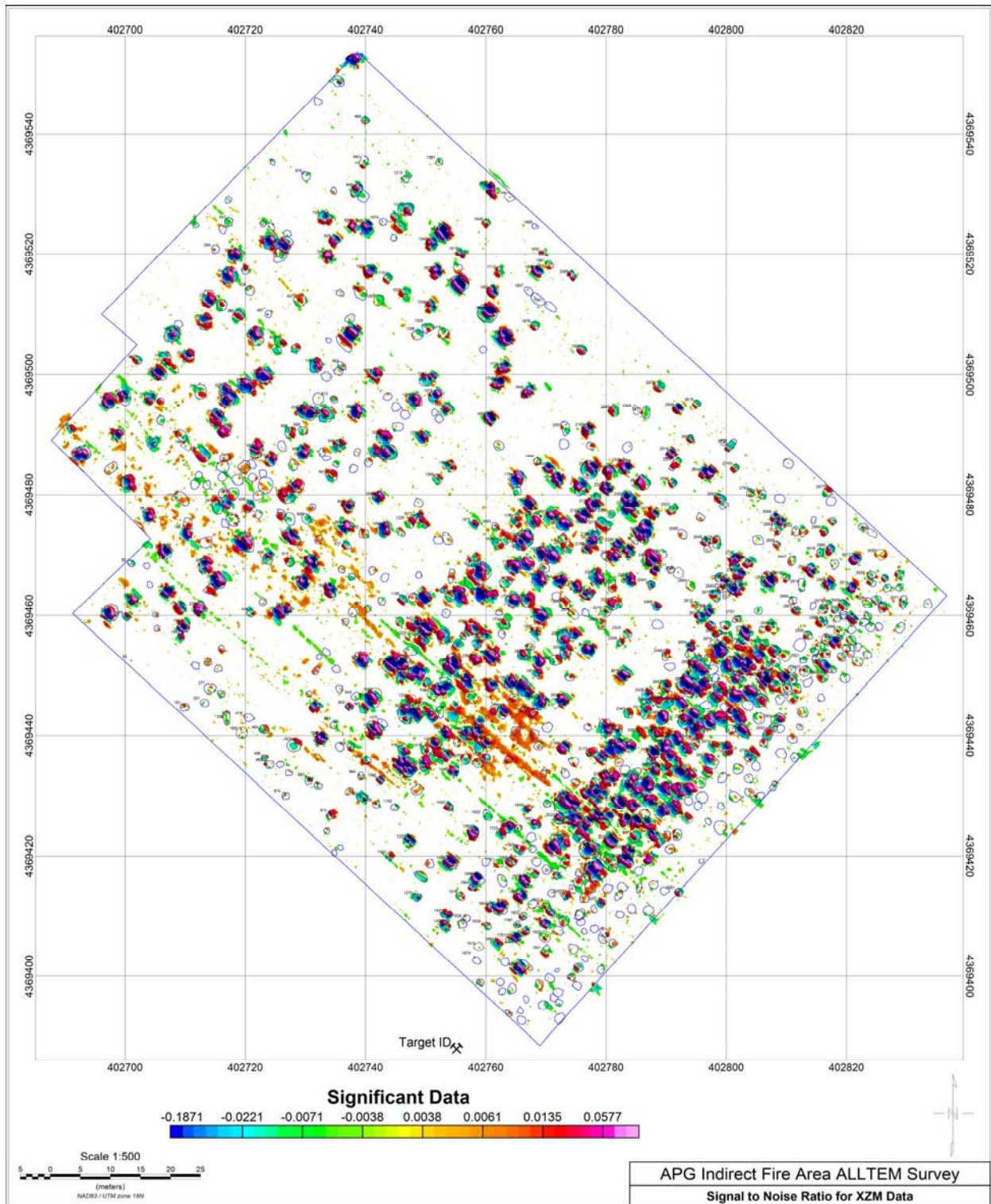

Appendix 2 – ALLTEM Data and Signal to Noise Maps

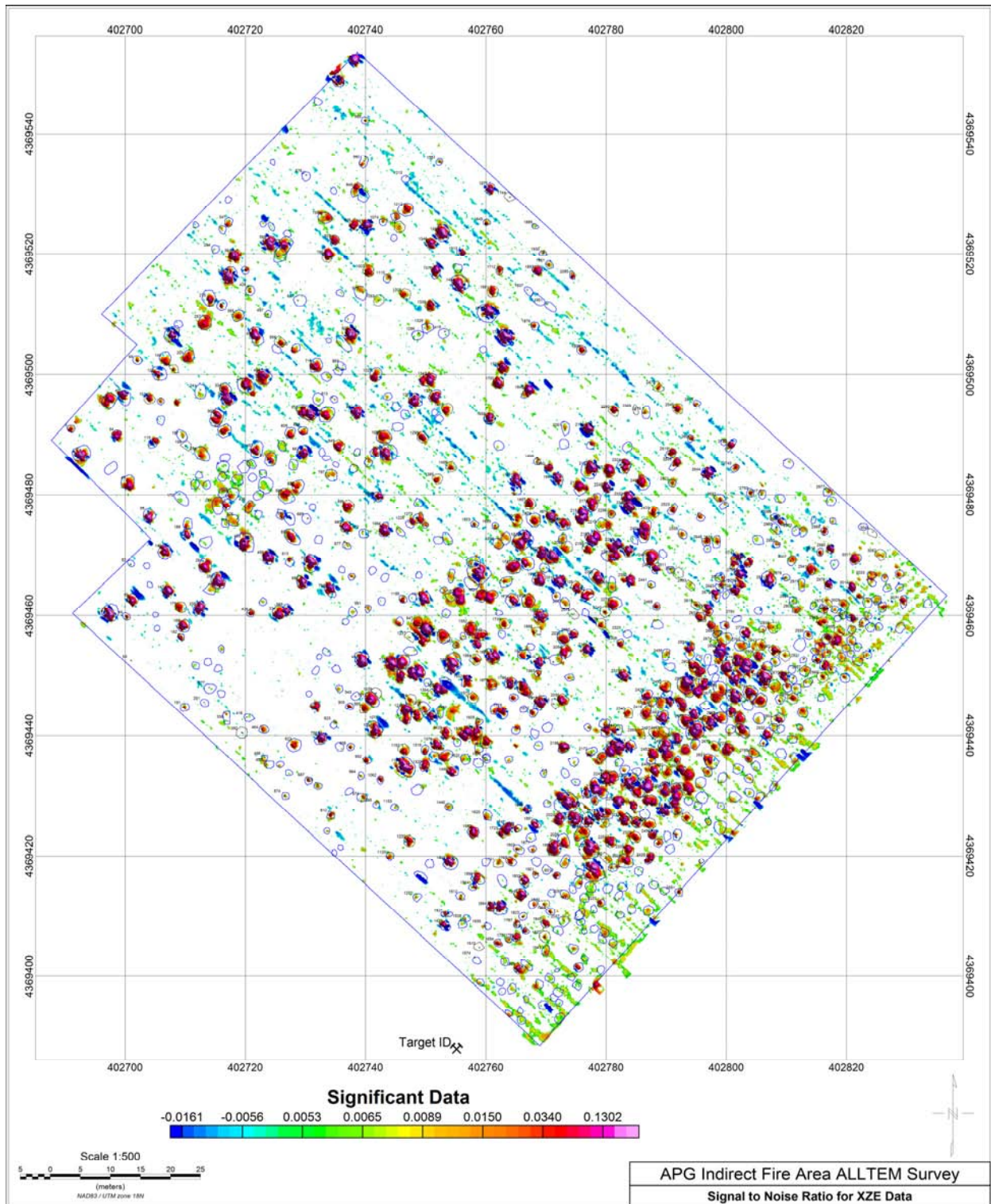

Appendix 2 – ALLTEM Data and Signal to Noise Maps

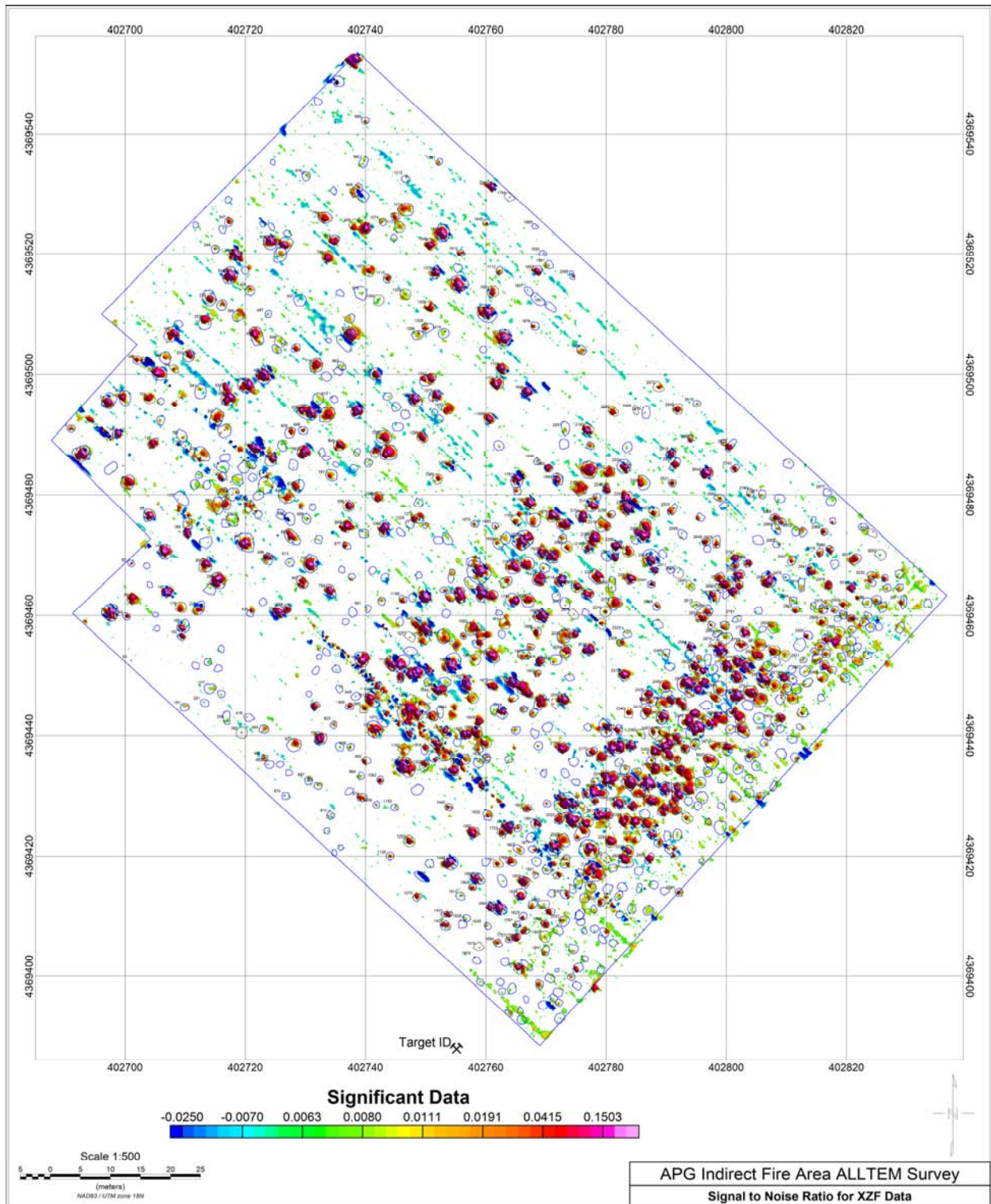

Appendix 2 – ALLTEM Data and Signal to Noise Maps

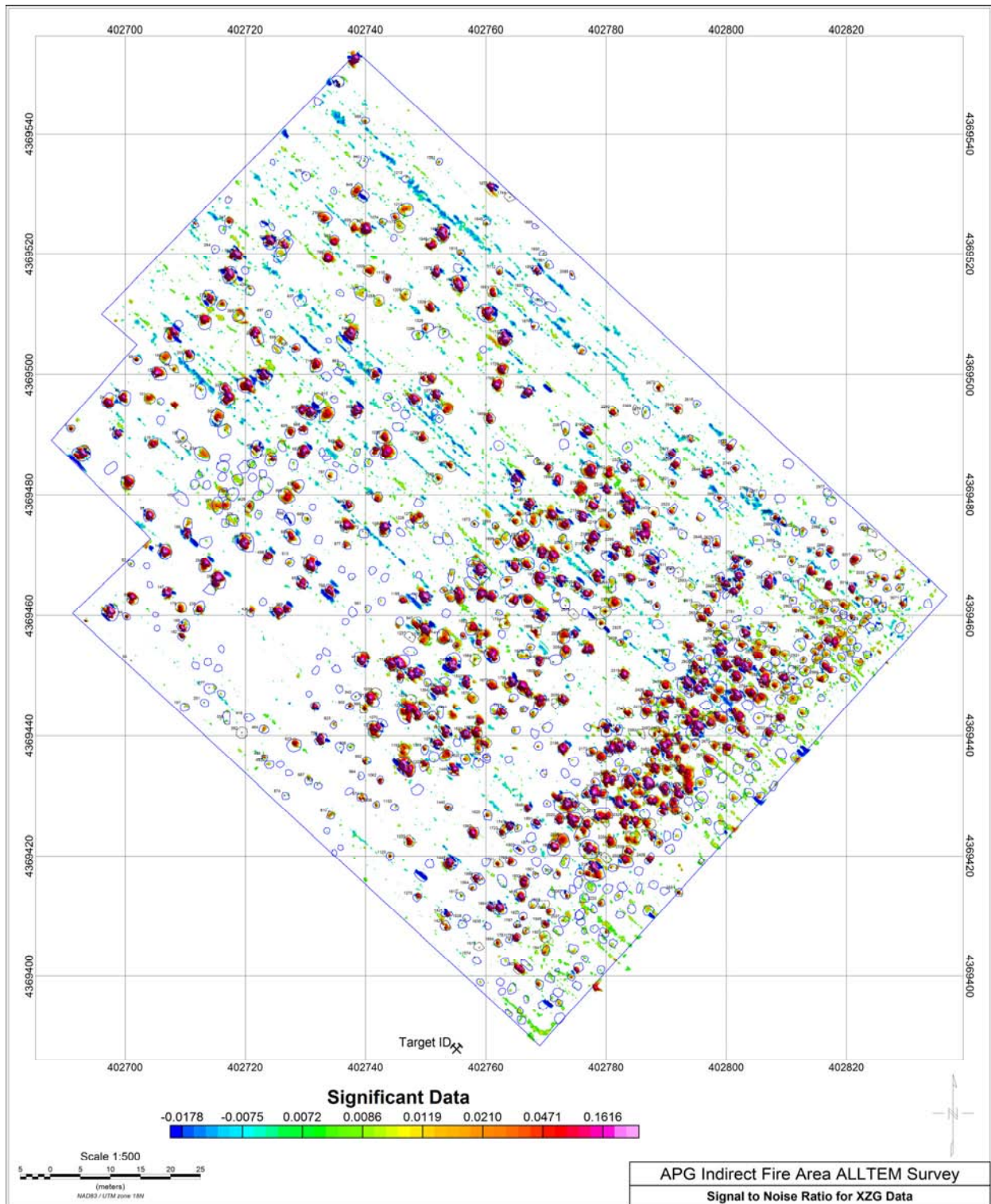

Appendix 2 – ALLTEM Data and Signal to Noise Maps

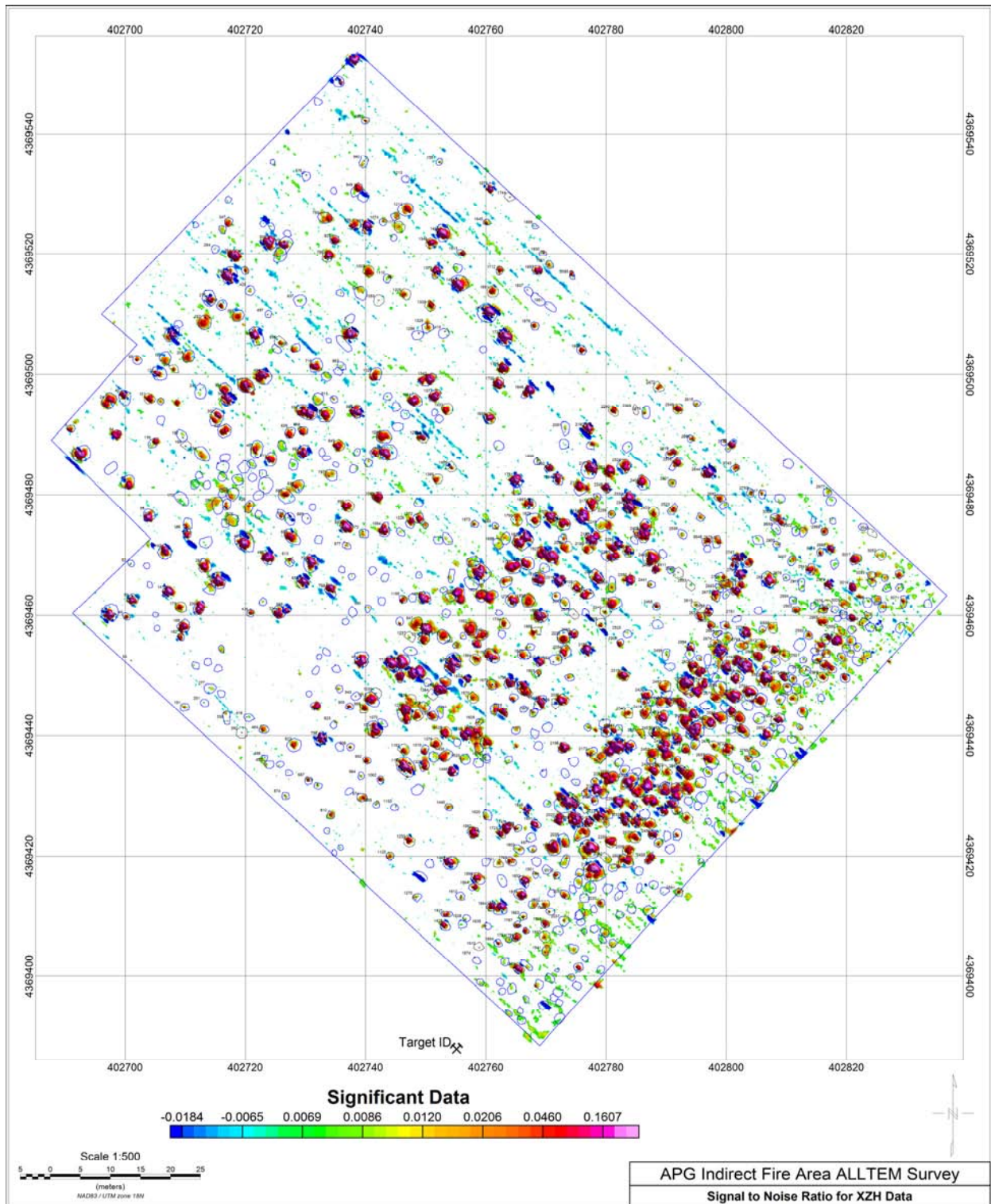

Appendix 2 – ALLTEM Data and Signal to Noise Maps

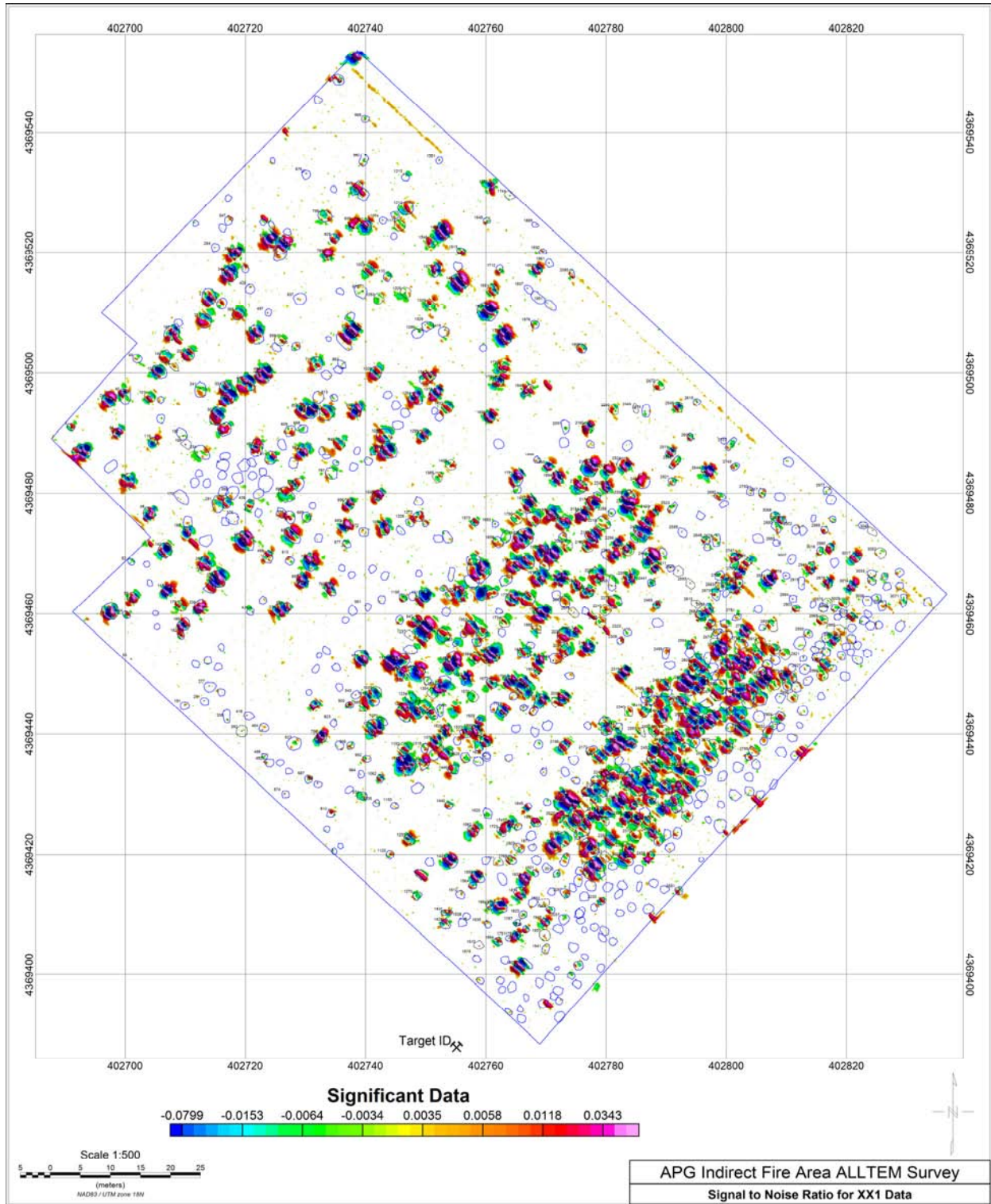

Appendix 3

Photos of the ALLTEM at the APG Standardized UXO Test Site



Figure 1. The ALLTEM at the Aberdeen Proving Ground Standardized Test Site

Appendix 3 – ALLTEM Calibration Data



Figure 2. The Kubota tractor used to tow the ALLTEM.



Figure 3. The Kubota tractor used to tow the ALLTEM.

Appendix 3 – ALLTEM Calibration Data



Figure 4. The ALLTEM surveying the APG Calibration Grid.



Figure 5. The ALLTEM surveying the APG Calibration Grid.

Appendix 3 – ALLTEM Calibration Data



Figure 6. The ALLTEM surveying the APG Calibration Grid.



Figure 6. The ALLTEM surveying the APG Blind Test Grid.

Appendix 3 – ALLTEM Calibration Data



Figure 7. The ALLTEM surveying the APG Direct Fire Area.



Figure 8. The ALLTEM surveying the APG Direct Fire Area.

Appendix 3 – ALLTEM Calibration Data



Figure 9. The ALLTEM surveying the APG Indirect Fire Area.



Figure 10. The ALLTEM surveying the APG Indirect Fire Area.

Appendix 3 – ALLTEM Calibration Data



Figure 11. The Leica GPS 1200 base station at APG (marker #477). The monument was typically under a foot of water.

Appendix 4

ALLTEM APG Classification Results

Data are presented in the following order:

Blind Test Grid – 11 pages

Direct Fire Area – 19 pages

Indirect Fire Area – 26 pages

APG Blind Test Grid

ALLTEM APG 2010 Blind Test Grid, ver.3															
Northing, UTM 18N, meters	Easting, UTM 18N, meters	Cell	Anomaly Number	Letter	Number	Disc. Stage/Rank 3 - Ord 2 - Clutter 1 - Blank	Class O - Ord C - Clutter B - Blank	Type	Depth (m)	Azimuth (Deg)	Inclinatio n (Deg)	Length (m)	Radius (m)	MSE	
4369542.1	402788.7	a1	81	A	1	2	C		-0.04	267.9	17.8	0.027	0.017	0.232	
4369542.3	402790.8	a2		A	2	1	B								
4369542.7	402792.7	a3		A	3	1	B								
4369543.0	402794.7	a4		A	4	1	B								
4369543.4	402796.7	a5		A	5	1	B								
4369544.1	402798.4	a6	182	A	6	2	C		-0.03	198.0	-18.8	0.019	0.013	0.202	
4369544.1	402800.6	a7	202	A	7	2	C		-0.06	54.2	132.4	0.018	0.008	0.616	
4369544.5	402802.5	a8	226	A	8	3	O	25mm	-0.06	173.8	5.0	0.052	0.018	0.077	
4369544.8	402804.5	a9		A	9	1	B								
4369545.0	402806.7	a10	266	A	10	2	C		-0.07	166.5	-4.8	0.025	0.011	0.513	
4369545.9	402810.4	a11		A	11	1	B								
4369545.9	402810.4	a12	309	A	12	2	C		-0.08	188.8	-1.0	0.033	0.011	0.266	
4369546.3	402812.4	a13	326	A	13	3	O	25mm	-0.10	171.3	-0.9	0.061	0.011	0.112	
4369546.6	402814.2	a14	346	A	14	3	O	81mm	-0.31	117.3	-164.9	0.107	0.034	0.090	
4369547.0	402816.3	a15		A	15	1	B								
4369547.4	402818.3	a16	389	A	16	3	O	105M60	-0.27	241.1	27.5	0.126	0.049	0.069	
4369547.8	402820.3	a17	408	A	17	3	O	81mm	-0.17	43.2	20.3	0.115	0.028	0.128	
4369548.1	402822.2	a18		A	18	1	B								
4369548.4	402824.3	a19	447	A	19	3	O	105M60	-0.40	240.0	9.4	0.123	0.044	0.075	
4369548.8	402826.1	a20		A	20	1	B								
4369543.8	402788.4	b1	77	B	1	2	C		-0.09	182.9	-5.4	0.028	0.019	0.109	
4369544.2	402790.4	b2	97	B	2	2	C		-0.06	189.2	11.1	0.054	0.010	0.091	
4369544.5	402792.4	b3	118	B	3	3	O	81mm	-0.12	299.9	1.8	0.116	0.035	0.109	
4369545.2	402793.7	b4	131	B	4	3	O	60mm	-0.32	319.1	-5.7	0.085	0.019	0.830	
4369545.3	402796.3	b5		B	5	1	B								
4369545.7	402798.2	b6	181	B	6	2	C		-0.07	179.2	13.2	0.042	0.006	0.107	
4369546.0	402800.2	b7		B	7	1	B								
4369546.4	402802.2	b8		B	8	1	B								
4369546.2	402804.6	b9	247	B	9	3	O	105Heat	-1.58	61.7	113.2	0.108	0.051	1.187	
4369547.2	402806.1	b10	262	B	10	3	O	37mm	-0.19	186.5	-0.4	0.067	0.014	0.094	
4369547.4	402808.1	b11	281	B	11	2	C		-0.07	263.5	-4.1	0.037	0.015	0.152	
4369547.9	402810.0	b12		B	12	1	B								
4369548.2	402812.0	b13		B	13	1	B								
4369548.6	402813.8	b14	345	B	14	2	C		-0.25	59.1	15.5	0.122	0.024	0.149	
4369548.1	402815.5	b15	363	B	15	2	C		-0.83	320.9	171.5	0.095	0.012	0.897	
4369549.4	402817.9	b16	387	B	16	2	C		-0.11	229.1	15.9	0.032	0.020	0.079	

APG Blind Test Grid

Northing, UTM 18N, meters	Easting, UTM 18N, meters	Cell	Anomaly Number	Letter	Number	Disc. Stage/Rank 3 - Ord 2 - Clutter 1 - Blank	Class O - Ord C - Clutter B - Blank	Type	Depth (m)	Azimuth (Deg)	Inclination (Deg)	Length (m)	Radius (m)	MSE
4369549.7	402819.9	b17		B	17	1	B							
4369550.0	402821.2	b18	415	B	18	2	C		0.00	320.2	-16.8	0.031	0.010	0.442
4369550.2	402824.2	b19	441	B	19	3	O	25mm	-0.46	156.2	-1.3	0.047	0.018	0.759
4369550.8	402825.7	b20	459	B	20	3	O	60mm	-0.16	137.3	-183.4	0.086	0.022	0.089
4369545.8	402788.0	c1	73	C	1	2	C		-0.07	259.0	17.1	0.027	0.005	0.624
4369546.2	402790.0	c2		C	2	1	B							
4369546.6	402791.4	c3	108	C	3	2	C		0.00	272.6	35.2	0.014	0.006	0.851
4369546.4	402793.6	c4	140	C	4	1	B		-0.56	202.3	-20.2	0.985	0.009	0.923
4369547.3	402796.0	c5	157	C	5	2	C		-0.20	247.4	9.9	0.044	0.012	0.184
4369547.7	402797.9	c6		C	6	1	B							
4369548.0	402799.8	c7	192	C	7	3	O	60mm	-0.14	243.7	18.6	0.075	0.024	0.090
4369548.4	402801.8	c8	215	C	8	2	C		-0.65	243.8	8.5	0.072	0.034	0.139
4369548.7	402803.8	c9	240	C	9	3	O	25mm	-0.17	219.2	6.8	0.077	0.013	0.157
4369549.1	402805.8	c10		C	10	1	B							
4369549.4	402807.7	c11	277	C	11	3	O	81mm	-0.39	204.7	-15.4	0.115	0.033	0.081
4369549.8	402809.6	c12	301	C	12	3	O	60mm	-0.21	210.7	-24.3	0.089	0.024	0.126
4369550.2	402811.7	c13		C	13	1	B							
4369550.6	402813.6	c14		C	14	1	B							
4369550.2	402815.3	c15	355	C	15	2	C		-0.01	213.2	-20.8	0.036	0.008	0.193
4369551.4	402817.4	c16	378	C	16	3	O	105M60	-0.37	292.0	10.8	0.132	0.051	0.101
4369551.7	402819.5	c17		C	17	1	B							
4369552.1	402821.5	c18		C	18	1	B							
4369552.4	402823.5	c19		C	19	1	B							
4369552.8	402825.4	c20		C	20	1	B							
4369547.6	402788.6	d1	75	D	1	2	C		-0.24	263.9	155.3	0.032	0.008	0.777
4369548.2	402789.7	d2		D	2	1	B							
4369548.5	402791.6	d3	109	D	3	3	O	37mm	-0.18	240.7	-2.8	0.071	0.019	0.093
4369549.0	402793.5	d4	132	D	4	2	C		-0.14	163.3	22.9	0.034	0.006	0.345
4369549.3	402795.6	d5		D	5	1	B							
4369549.7	402797.5	d6	169	D	6	3	O	37mm	-0.14	182.0	14.7	0.064	0.018	0.038
4369549.5	402799.6	d7	191	D	7	2	C		-0.29	89.0	0.8	0.032	0.011	0.963
4369550.4	402801.5	d8	211	D	8	2	C		-0.12	206.9	0.6	0.036	0.020	0.091
4369550.8	402803.4	d9	234	D	9	2	C		-0.07	266.7	8.2	0.064	0.028	0.110
4369551.1	402805.4	d10	253	D	10	3	O	25mm	-0.13	205.8	10.0	0.083	0.014	0.141
4369551.5	402807.3	d11	254	D	11	3	O	81mm	-1.26	264.9	60.1	0.091	0.039	0.902
4369551.8	402809.3	d12		D	12	1	B							
4369552.2	402811.3	d13		D	13	1	B							
4369552.6	402813.2	d14		D	14	1	B							

APG Blind Test Grid

Northing, UTM 18N, meters	Easting, UTM 18N, meters	Cell	Anomaly Number	Letter	Number	Disc. Stage/Rank 3 - Ord 2 - Clutter 1 - Blank	Class O - Ord C - Clutter B - Blank	Type	Depth (m)	Azimuth (Deg)	Inclination (Deg)	Length (m)	Radius (m)	MSE
4369553.0	402815.2	d15	356	D	15	2	C		-0.13	149.9	10.2	0.046	0.011	0.154
4369553.3	402817.1	d16	380	D	16	3	O	25mm	-0.10	247.7	-18.7	0.070	0.011	0.067
4369553.7	402819.2	d17	400	D	17	2	C		-0.15	295.2	37.1	0.039	0.012	0.149
4369554.0	402821.1	d18		D	18	1	B							
4369554.4	402823.1	d19		D	19	1	B							
4369554.6	402825.1	d20	449	D	20	2	C		-0.15	218.4	61.5	0.015	0.014	0.804
4369549.8	402787.3	e1		E	1	1	B							
4369550.2	402789.2	e2	86	E	2	3	O	105M60	-0.31	290.2	-4.4	0.126	0.042	0.073
4369550.5	402791.5	e3	110	E	3	2	C		-0.10	262.5	31.3	0.025	0.011	0.372
4369550.9	402793.2	e4		E	4	1	B							
4369551.3	402795.2	e5		E	5	1	B							
4369551.5	402797.1	e6	166	E	6	3	O	105M60	-0.29	34.0	16.2	0.125	0.042	0.074
4369552.0	402799.1	e7		E	7	1	B							
4369552.3	402801.1	e8		E	8	1	B							
4369552.7	402803.0	e9	232	E	9	3	O	37mm	-0.20	37.5	18.6	0.067	0.014	0.087
4369553.1	402805.0	e10	251	E	10	2	C		-0.06	215.2	-2.6	0.027	0.012	0.438
4369553.5	402807.0	e11	271	E	11	3	O	37mm	-0.09	203.7	-0.8	0.067	0.018	0.130
4369553.8	402808.9	e12		E	12	1	B							
4369554.2	402810.9	e13	312	E	13	3	O	37mm	-0.13	178.4	173.4	0.074	0.017	0.071
4369554.5	402812.9	e14	331	E	14	2	C		-0.15	242.0	9.8	0.057	0.027	0.075
4369554.9	402814.9	e15		E	15	1	B							
4369555.2	402816.8	e16	373	E	16	3	O	105M60	-0.85	169.9	-2.7	0.164	0.041	0.098
4369555.5	402818.8	e17	388	E	17	2	C		-0.01	259.2	-2.2	0.023	0.011	0.382
4369556.0	402820.8	e18		E	18	1	B							
4369556.3	402822.8	e19	434	E	19	3	O	37mm	-0.20	168.9	22.4	0.061	0.016	0.042
4369556.7	402824.7	e20		E	20	1	B							
4369551.8	402787.0	f1	64	F	1	2	C		-0.08	179.8	-17.6	0.038	0.019	0.070
4369552.1	402788.9	f2		F	2	1	B							
4369552.6	402790.9	f3	101	F	3	2	C		-0.07	155.5	-22.2	0.033	0.013	0.104
4369552.8	402792.9	f4	121	F	4	3	O	105M60	-0.22	189.3	-2.8	0.159	0.052	0.088
4369553.2	402794.8	f5		F	5	1	B							
4369553.6	402796.7	f6	161	F	6	3	O	37mm	-0.14	138.8	-4.3	0.074	0.018	0.102
4369553.9	402798.7	f7		F	7	1	B							
4369554.3	402800.7	f8	201	F	8	3	O	105M60	-0.32	230.3	-6.9	0.172	0.049	0.119
4369554.7	402802.7	f9		F	9	1	B							
4369555.0	402804.6	f10	248	F	10	3	O	105M60	-0.44	255.4	4.8	0.157	0.047	0.092
4369555.4	402806.6	f11	267	F	11	2	C		-0.04	236.6	-19.4	0.023	0.012	0.354
4369555.8	402808.6	f12	288	F	12	2	C		-0.11	275.0	-12.2	0.035	0.008	0.333

APG Blind Test Grid

Northing, UTM 18N, meters	Easting, UTM 18N, meters	Cell	Anomaly Number	Letter	Number	Disc. Stage/Rank 3 - Ord 2 - Clutter 1 - Blank	Class O - Ord C - Clutter B - Blank	Type	Depth (m)	Azimuth (Deg)	Inclination (Deg)	Length (m)	Radius (m)	MSE
4369556.1	402810.6	f13	310	F	13	3	O	37mm	-0.16	339.1	8.2	0.073	0.019	0.077
4369556.5	402812.5	f14	327	F	14	3	O	25mm	-0.36	135.1	4.3	0.054	0.019	0.306
4369556.8	402814.5	f15	347	F	15	3	O	81mm	-0.26	324.5	8.6	0.092	0.028	0.129
4369557.2	402816.4	f16	368	F	16	3	O	37mm	-0.20	284.9	-10.9	0.069	0.019	0.071
4369557.6	402818.4	f17	390	F	17	3	O	81mm	-0.29	358.3	0.2	0.113	0.032	0.080
4369558.0	402820.4	f18		F	18	1	B							
4369558.3	402822.4	f19	428	F	19	3	O	60mm	-0.13	38.4	-174.3	0.092	0.023	0.107
4369558.6	402824.2	f20	448	F	20	3	O	105M60	-0.39	171.0	-8.4	0.138	0.051	0.082
4369553.7	402786.6	g1	58	G	1	2	C		-0.12	159.6	14.4	0.042	0.016	0.064
4369554.1	402788.5	g2	80	G	2	3	O	37mm	-0.16	266.5	17.2	0.069	0.018	0.062
4369554.5	402790.5	g3		G	3	1	B							
4369554.8	402792.5	g4		G	4	1	B							
4369555.1	402794.5	g5	138	G	5	2	C		-0.10	273.0	10.4	0.072	0.029	0.110
4369555.6	402796.4	g6	155	G	6	2	C		-0.15	187.6	9.7	0.123	0.014	0.180
4369555.9	402798.4	g7		G	7	1	B							
4369556.3	402800.3	g8	199	G	8	3	O	37mm	-0.06	329.0	17.4	0.061	0.018	0.085
4369556.6	402802.3	g9		G	9	1	B							
4369557.0	402804.3	g10		G	10	1	B							
4369557.3	402806.2	g11	264	G	11	3	O	60mm	-0.12	285.7	3.5	0.087	0.025	0.093
4369557.7	402808.2	g12		G	12	1	B							
4369558.0	402810.2	g13	306	G	13	3	O	25mm	-0.10	252.1	17.7	0.080	0.013	0.227
4369558.4	402812.1	g14	325	G	14	2	C		-0.13	274.1	10.0	0.036	0.013	0.243
4369558.8	402814.1	g15		G	15	1	B							
4369559.2	402816.1	g16		G	16	1	B							
4369559.6	402818.1	g17		G	17	1	B							
4369559.9	402820.0	g18		G	18		B							
4369560.4	402821.9	g19	424	G	19	3	O	105M60	-0.44	77.6	-9.8	0.139	0.047	0.064
4369560.7	402824.0	g20	443	G	20	3	O	37mm	-0.15	205.2	3.9	0.074	0.017	0.139
4369555.8	402786.2	h1	56	H	1	3	O	81mm	-0.17	219.4	9.5	0.113	0.037	0.084
4369556.1	402788.2	h2	74	H	2	3	O	25mm	-0.17	181.1	-0.2	0.084	0.014	0.160
4369556.2	402790.1	h3	93	H	3	2	C		-0.08	177.2	17.1	0.034	0.011	0.303
4369556.8	402792.1	h4		H	4	1	B							
4369557.1	402794.1	h5	135	H	5	2	C		-0.33	290.1	-8.4	0.030	0.016	0.772
4369557.5	402796.1	h6		H	6	1	B							
4369557.9	402798.0	h7		H	7	1	B							
4369558.3	402800.0	h8	194	H	8	3	O	37mm	-0.09	210.1	-6.5	0.072	0.017	0.061
4369558.6	402801.9	h9	219	H	9	3	O	81mm	-0.13	41.9	-21.1	0.099	0.033	0.063
4369559.0	402803.9	h10		H	10	1	B							

APG Blind Test Grid

Northing, UTM 18N, meters	Easting, UTM 18N, meters	Cell	Anomaly Number	Letter	Number	Disc. Stage/Rank 3 - Ord 2 - Clutter 1 - Blank	Class O - Ord C - Clutter B - Blank	Type	Depth (m)	Azimuth (Deg)	Inclination (Deg)	Length (m)	Radius (m)	MSE
4369559.3	402805.8	h11	260	H	11	3	O	105M60	-0.30	306.9	166.1	0.143	0.045	0.081
4369559.7	402807.9	h12	279	H	12	3	O	81mm	-0.28	141.4	29.9	0.107	0.034	0.079
4369560.1	402809.8	h13		H	13	1	B							
4369560.4	402811.7	h14	322	H	14	3	O	25mm	-0.11	122.1	2.2	0.069	0.011	0.120
4369560.8	402813.8	h15	341	H	15	3	O	60mm	-0.14	168.9	-17.3	0.082	0.026	0.087
4369561.1	402815.6	h16	357	H	16	3	O	81mm	-0.75	338.8	17.8	0.103	0.035	0.142
4369561.5	402817.7	h17		H	17	1	B							
4369561.9	402819.7	h18	404	H	18	3	O	37mm	-0.17	142.9	28.9	0.069	0.016	0.062
4369562.3	402821.6	h19		H	19	1	B							
4369562.6	402823.6	h20	438	H	20	2	C		-0.08	28.7	32.0	0.046	0.014	0.097
4369557.7	402785.9	i1		I	1	1	B							
4369558.0	402787.8	i2		I	2	1	B							
4369558.4	402789.8	i3	91	I	3	3	O	81mm	-0.16	304.0	-2.2	0.113	0.035	0.109
4369558.8	402791.9	i4	117	I	4	3	O	105M60	-0.28	246.0	2.2	0.129	0.046	0.297
4369559.1	402793.8	i5		I	5	1	B							
4369559.4	402795.7	i6	148	I	6	3	O	60mm	-0.16	175.7	22.3	0.088	0.025	0.121
4369559.8	402797.6	i7		I	7	1	B							
4369560.2	402799.6	i8		I	8	1	B							
4369560.6	402801.6	i9		I	9	1	B							
4369560.9	402803.6	i10		I	10	1	B							
4369561.3	402805.5	i11	256	I	11	3	O	25mm	-0.16	198.7	26.6	0.069	0.014	0.094
4369561.7	402807.5	i12		I	12	1	B							
4369561.8	402809.1	i13	296	I	13	3	O	25mm	-0.15	214.4	10.0	0.073	0.011	0.172
4369562.4	402811.3	i14	316	I	14	3	O	25mm	-0.18	166.8	-15.5	0.045	0.018	0.110
4369562.8	402813.4	i15		I	15	1	B							
4369563.2	402815.4	i16	359	I	16	3	O	37mm	-0.18	206.8	26.2	0.069	0.018	0.052
4369563.8	402817.4	i17	374	I	17	2	C		-0.17	325.2	84.0	0.029	0.020	0.623
4369563.8	402819.3	i18		I	18	1	B							
4369564.2	402821.3	i19		I	19	1	B							
4369564.6	402823.2	i20	436	I	20	2	C		-0.10	230.9	103.4	0.024	0.019	0.127
4369559.7	402785.5	j1	46	J	1	2	C		-0.08	307.7	16.0	0.034	0.017	0.269
4369559.7	402786.7	j2	63	J	2	3	O	25mm	-0.50	262.8	-16.3	0.064	0.022	0.425
4369560.4	402789.5	j3		J	3	1	B							
4369560.6	402791.4	j4	105	J	4	3	O	105M60	-0.28	299.6	5.1	0.159	0.049	0.081
4369561.1	402793.4	j5		J	5	1	B							
4369561.4	402795.3	j6		J	6	1	B							
4369561.8	402797.3	j7		J	7	1	B							
4369562.2	402799.3	j8		J	8	1	B							

APG Blind Test Grid

Northing, UTM 18N, meters	Easting, UTM 18N, meters	Cell	Anomaly Number	Letter	Number	Disc. Stage/Rank 3 - Ord 2 - Clutter 1 - Blank	Class O - Ord C - Clutter B - Blank	Type	Depth (m)	Azimuth (Deg)	Inclination (Deg)	Length (m)	Radius (m)	MSE
4369562.5	402801.2	j9	208	J	9	2	C		-0.02	254.1	-8.6	0.062	0.029	0.093
4369562.8	402803.6	j10	231	J	10	2	C		-0.36	69.9	12.7	0.047	0.014	0.868
4369563.3	402805.1	j11	246	J	11	2	C		-0.08	209.0	1.8	0.037	0.016	0.152
4369563.6	402806.5	j12	265	J	12	2	C		-0.03	169.4	19.7	0.076	0.010	0.780
4369564.6	402809.5	j13	298	J	13	3	O	105M60	-0.63	156.4	-18.2	0.119	0.040	0.789
4369564.3	402811.2	j14	314	J	14	3	O	81mm	-0.30	251.0	188.2	0.094	0.029	0.353
4369564.7	402813.0	j15		J	15	1	B							
4369565.0	402815.3	j16	360	J	16	2	C		-0.40	356.5	121.4	0.024	0.020	0.701
4369564.8	402815.7	j17		J	17	1	B							
4369565.4	402817.0	j18	399	J	18	2	C		-0.05	266.1	-3.3	0.034	0.013	0.166
4369566.1	402820.9	j19	412	J	19	3	O	105M60	-0.13	343.3	-13.5	0.175	0.045	0.097
4369566.6	402822.9	j20	433	J	20	2	C		-0.12	278.6	-5.7	0.036	0.016	0.196
4369561.6	402785.1	k1		K	1	1	B							
4369561.8	402787.0	k2	65	K	2	3	O	60mm	-0.28	323.2	14.7	0.078	0.021	0.252
4369562.4	402789.1	k3	84	K	3	3	O	105M60	-0.27	39.4	1.3	0.144	0.054	0.458
4369562.4	402790.9	k4	111	K	4	2	C		-0.33	78.4	6.6	0.037	0.016	0.772
4369563.1	402792.9	k5	123	K	5	2	C		-0.19	37.4	162.9	0.045	0.022	0.520
4369563.2	402795.1	k6	143	K	6	2	C		-0.23	269.2	180.7	0.045	0.013	0.755
4369563.7	402796.9	k7	162	K	7	3	O	105M60	-0.34	11.4	-12.0	0.133	0.058	0.364
4369564.1	402798.8	k8	185	K	8	2	C		-0.14	177.2	176.3	0.075	0.008	0.605
4369564.5	402800.9	k9		K	9	1	B							
4369564.8	402801.8	k10	216	K	10	2	C		-0.01	174.5	168.3	0.027	0.005	0.843
4369564.4	402804.5	k11	252	K	11	2	C		-0.11	84.9	-2.1	0.035	0.012	0.794
4369565.6	402806.7	k12	273	K	12	3	O	37mm	-0.34	161.1	11.9	0.066	0.021	0.394
4369566.0	402808.7	k13		K	13	1	B							
4369566.3	402810.7	k14		K	14	1	B							
4369566.7	402812.7	k15		K	15	1	B							
4369567.0	402814.6	k16	349	K	16	3	O	37mm	-0.20	344.7	15.1	0.056	0.019	0.482
4369567.6	402816.4	k17	365	K	17	3	O	105Heat	-0.27	334.8	135.1	0.095	0.056	0.126
4369567.8	402818.6	k18		K	18	1	B							
4369568.3	402820.4	k19	410	K	19	2	C		-0.12	77.7	0.9	0.043	0.011	0.378
4369568.5	402822.5	k20	429	K	20	3	O	81mm	-0.22	26.9	4.2	0.107	0.032	0.577
4369563.6	402784.7	l1	41	L	1	3	O	60mm	-0.10	43.1	-26.5	0.087	0.021	0.082
4369563.8	402786.9	l2	72	L	2	3	O	25mm	-0.57	12.6	19.0	0.059	0.022	0.488
4369564.2	402787.9	l3	71	L	3	2	C		-0.04	27.0	108.3	0.018	0.010	0.588
4369564.6	402790.7	l4		L	4	1	B							
4369565.0	402792.7	l5		L	5	1	B							
4369565.4	402794.6	l6		L	6	1	B							

APG Blind Test Grid

Northing, UTM 18N, meters	Easting, UTM 18N, meters	Cell	Anomaly Number	Letter	Number	Disc. Stage/Rank 3 - Ord 2 - Clutter 1 - Blank	Class O - Ord C - Clutter B - Blank	Type	Depth (m)	Azimuth (Deg)	Inclination (Deg)	Length (m)	Radius (m)	MSE
4369565.7	402796.5	l7	158	L	7	3	O	37mm	-0.11	139.3	19.7	0.062	0.020	0.072
4369566.1	402798.5	l8		L	8	1	B							
4369566.4	402800.4	l9	198	L	9	2	C		-0.14	234.0	74.5	0.054	0.042	0.231
4369566.8	402802.5	l10		L	10	1	B							
4369567.2	402804.4	l11		L	11	1	B							
4369567.5	402806.4	l12	263	L	12	2	C		-0.09	84.8	1.2	0.032	0.017	0.114
4369568.0	402808.3	l13	285	L	13	3	O	37mm	-0.15	144.4	30.4	0.067	0.017	0.152
4369568.1	402810.2	l14	299	L	14	3	O	81mm	-0.69	346.1	5.2	0.098	0.038	0.160
4369568.7	402812.1	l15	324	L	15	3	O	81mm	-0.17	174.5	10.8	0.113	0.033	0.113
4369569.0	402814.3	l16		L	16	1	B							
4369569.3	402816.4	l17	385	L	17	2	C		-0.01	214.4	11.4	0.034	0.020	0.207
4369569.7	402818.2	l18		L	18	1	B							
4369570.1	402820.2	l19		L	19	1	B							
4369570.4	402822.1	l20	427	L	20	3	O	37mm	-0.12	34.3	15.2	0.075	0.017	0.128
4369565.5	402784.3	m1	32	M	1	2	C		-0.12	343.4	8.3	0.052	0.004	0.649
4369565.9	402786.4	m2		M	2	1	B							
4369566.3	402788.3	m3	76	M	3	3	O	37mm	-0.09	48.5	15.5	0.068	0.018	0.086
4369566.6	402790.2	m4	94	M	4	2	C		-0.22	25.4	27.2	0.048	0.023	0.125
4369567.0	402792.3	m5		M	5	1	B							
4369567.5	402794.1	m6	150	M	6	2	C		-0.44	181.5	1.1	0.040	0.019	0.886
4369567.6	402796.1	m7	152	M	7	3	O	105M60	-0.16	24.2	9.0	0.154	0.054	0.091
4369568.1	402798.1	m8	178	M	8	3	O	25mm	-0.08	122.4	164.8	0.051	0.022	0.095
4369568.4	402800.1	m9		M	9	1	B							
4369568.8	402802.0	m10	217	M	10	3	O	37mm	-0.17	2.4	-13.6	0.066	0.018	0.163
4369569.2	402803.9	m11	242	M	11	3	O	105M60	-0.20	159.8	19.7	0.167	0.050	0.096
4369569.5	402806.0	m12		M	12	1	B							
4369569.9	402808.0	m13		M	13	1	B							
4369570.1	402809.8	m14	303	M	14	2	C		-0.15	208.0	147.4	0.027	0.011	0.364
4369570.6	402811.9	m15		M	15	1	B							
4369570.8	402813.7	m16	337	M	16	2	C		-0.04	166.9	21.4	0.038	0.013	0.236
4369571.3	402815.8	m17	361	M	17	3	O	60mm	-0.14	101.8	1.4	0.088	0.025	0.111
4369571.6	402817.7	m18	384	M	18	2	C		-0.18	162.1	58.9	0.023	0.019	0.546
4369572.2	402819.8	m19	406	M	19	2	C		-0.21	73.2	-17.4	0.039	0.003	0.764
4369572.4	402821.7	m20		M	20	1	B							
4369567.5	402784.0	n1		N	1	1	B							
4369567.9	402786.4	n2	48	N	2	2	C		-0.53	125.0	1.9	0.050	0.011	0.932
4369568.0	402788.0	n3	55	N	3	3	O	81mm	-1.33	44.6	21.2	0.118	0.031	1.047
4369568.6	402790.0	n4		N	4	1	B							

APG Blind Test Grid

Northing, UTM 18N, meters	Easting, UTM 18N, meters	Cell	Anomaly Number	Letter	Number	Disc. Stage/Rank 3 - Ord 2 - Clutter 1 - Blank	Class O - Ord C - Clutter B - Blank	Type	Depth (m)	Azimuth (Deg)	Inclinatio n (Deg)	Length (m)	Radius (m)	MSE
4369569.0	402791.9	n5		N	5	1	B							
4369569.3	402793.7	n6	130	N	6	3	O	60mm	-0.16	124.0	-7.9	0.093	0.024	0.121
4369570.3	402795.4	n7	159	N	7	2	C		-0.03	110.6	87.6	0.029	0.009	0.308
4369570.0	402797.7	n8	175	N	8	2	C		-0.18	115.5	9.4	0.038	0.016	0.274
4369570.3	402799.7	n9	189	N	9	2	C		-0.13	118.5	9.6	0.041	0.022	0.082
4369570.8	402801.7	n10	213	N	10	2	C		-0.20	256.1	35.6	0.033	0.016	0.223
4369571.4	402804.3	n11	235	N	11	3	O	25mm	-0.28	128.0	20.3	0.059	0.013	0.948
4369571.4	402805.6	n12	259	N	12	3	O	37mm	-0.15	65.5	-4.1	0.071	0.015	0.096
4369571.9	402807.6	n13		N	13	1	B							
4369572.2	402809.6	n14		N	14	1	B							
4369572.4	402811.4	n15	319	N	15	3	O	37mm	-0.18	352.9	27.5	0.063	0.018	0.100
4369572.9	402813.5	n16		N	16	1	B							
4369573.3	402815.5	n17		N	17	1	B							
4369573.7	402817.3	n18	377	N	18	3	O	25mm	-0.06	0.3	-6.8	0.055	0.012	0.092
4369573.9	402818.9	n19	403	N	19	2	C		-0.01	85.6	180.8	0.022	0.006	0.875
4369574.0	402819.4	n20		N	20	1	B							
4369569.5	402783.6	o1	25	O	1	3	O	25mm	-0.14	63.5	-22.8	0.077	0.014	0.141
4369569.8	402785.7	o2		O	2	1	B							
4369570.2	402787.6	o3		O	3	1	B							
4369570.5	402789.5	o4	89	O	4	3	O	105M60	-0.26	11.6	0.9	0.154	0.046	0.071
4369570.9	402791.6	o5		O	5	1	B							
4369571.6	402792.9	o6	126	O	6	3	O	105M60	-1.75	39.4	14.1	0.161	0.044	0.955
4369571.7	402795.7	o7	145	O	7	2	C		-0.16	39.3	1.3	0.025	0.011	0.756
4369572.6	402798.1	o8	165	O	8	2	C		-0.02	338.0	26.9	0.039	0.019	0.294
4369572.5	402800.2	o9	196	O	9	2	C		-0.15	99.2	93.9	0.041	0.023	0.054
4369572.7	402801.4	o10		O	10	1	B							
4369573.1	402803.3	o11	233	O	11	2	C		-0.05	127.4	-9.0	0.029	0.015	0.618
4369573.5	402805.3	o12		O	12	1	B							
4369573.8	402807.3	o13		O	13	1	B							
4369574.2	402809.2	o14		O	14	1	B							
4369574.6	402811.2	o15		O	15	1	B							
4369574.9	402813.2	o16	330	O	16	2	C		-0.09	279.8	97.8	0.014	0.011	0.663
4369575.3	402815.1	o17	353	O	17	3	O	25mm	-0.12	12.3	41.2	0.051	0.015	0.115
4369575.7	402817.0	o18	375	O	18	3	O	60mm	-0.15	214.5	55.6	0.079	0.021	0.093
4369576.0	402819.1	o19	402	O	19	2	C		-0.11	4.8	180.8	0.033	0.006	0.504
4369575.9	402821.1	o20	417	O	20	2	C		-0.14	68.1	81.6	0.036	0.012	0.127
4369571.3	402783.2	p1	21	P	1	3	O	37mm	-0.30	347.8	8.6	0.070	0.017	0.154
4369571.8	402785.3	p2		P	2	1	B							

APG Blind Test Grid

Northing, UTM 18N, meters	Easting, UTM 18N, meters	Cell	Anomaly Number	Letter	Number	Disc. Stage/Rank 3 - Ord 2 - Clutter 1 - Blank	Class O - Ord C - Clutter B - Blank	Type	Depth (m)	Azimuth (Deg)	Inclination (Deg)	Length (m)	Radius (m)	MSE
4369571.4	402787.0	p3	66	P	3	2	C		-0.02	145.3	139.0	0.023	0.007	0.372
4369572.5	402789.1	p4	83	P	4	2	C		-0.14	41.2	64.9	0.037	0.017	0.068
4369572.9	402791.1	p5	103	P	5	3	O	25mm	-0.15	351.9	8.1	0.084	0.015	0.242
4369573.2	402793.2	p6		P	6	1	B							
4369573.6	402795.1	p7		P	7	1	B							
4369573.9	402797.0	p8	164	P	8	3	O	105M60	-0.20	50.9	-19.1	0.124	0.046	0.084
4369574.3	402799.0	p9		P	9	1	B							
4369574.7	402801.0	p10		P	10	1	B							
4369575.0	402803.0	p11		P	11	1	B							
4369575.4	402805.0	p12		P	12	1	B							
4369575.8	402806.8	p13	269	P	13	2	C		-0.07	5.9	15.4	0.028	0.011	0.167
4369576.2	402808.6	p14	290	P	14	2	C		-0.16	43.6	4.6	0.036	0.022	0.113
4369576.5	402810.7	p15	315	P	15	3	O	25mm	-0.06	55.3	-160.0	0.080	0.015	0.115
4369576.7	402813.1	p16	333	P	16	2	C		-0.31	8.6	1.0	0.031	0.017	0.724
4369577.1	402814.8	p17	351	P	17	2	C		-0.17	54.9	37.2	0.029	0.013	0.372
4369577.5	402816.6	p18	369	P	18	2	C		0.00	342.0	-2.0	0.042	0.014	0.156
4369577.9	402818.6	p19	391	P	19	2	C		-0.22	68.0	-2.5	0.089	0.014	0.171
4369578.0	402821.6	p20	416	P	20	2	C		-0.29	29.4	-24.6	0.034	0.013	0.830
4369573.4	402783.0	q1		Q	1	1	B							
4369573.7	402784.9	q2		Q	2	1	B							
4369574.1	402786.1	q3	54	Q	3	2	C		-0.04	35.6	143.7	0.020	0.012	0.805
4369574.5	402788.9	q4		Q	4	1	B							
4369574.7	402790.8	q5	98	Q	5	3	O	105M60	-0.23	21.3	26.3	0.144	0.049	0.070
4369575.1	402792.6	q6	119	Q	6	2	C		-0.11	356.2	17.0	0.039	0.021	0.185
4369575.5	402794.6	q7	137	Q	7	2	C		-0.23	92.4	89.1	0.057	0.024	0.087
4369575.9	402796.7	q8		Q	8	1	B							
4369576.2	402798.7	q9	184	Q	9	2	C		-0.06	353.1	13.0	0.030	0.021	0.073
4369576.6	402800.6	q10	197	Q	10	2	C		-0.05	33.5	-0.3	0.086	0.008	0.106
4369577.0	402802.6	q11		Q	11	1	B							
4369577.4	402804.6	q12		Q	12	1	B							
4369577.7	402806.5	q13	261	Q	13	3	O	105M60	-0.56	159.3	3.8	0.165	0.047	0.227
4369578.1	402808.5	q14		Q	14	1	B							
4369578.5	402810.5	q15		Q	15	1	B							
4369578.8	402812.5	q16		Q	16	1	B							
4369579.2	402814.4	q17		Q	17	1	B							
4369579.6	402816.4	q18		Q	18	1	B							
4369579.9	402818.3	q19		Q	19	1	B							
4369580.4	402820.2	q20	405	Q	20	3	O	105M60	-0.34	56.9	7.1	0.126	0.047	0.074

APG Blind Test Grid

Northing, UTM 18N, meters	Easting, UTM 18N, meters	Cell	Anomaly Number	Letter	Number	Disc. Stage/Rank 3 - Ord 2 - Clutter 1 - Blank	Class O - Ord C - Clutter B - Blank	Type	Depth (m)	Azimuth (Deg)	Inclination (Deg)	Length (m)	Radius (m)	MSE
4369575.4	402782.5	r1	16	R	1	2	C		-0.04	25.2	10.0	0.037	0.015	0.097
4369575.8	402784.5	r2	40	R	2	2	C		-0.12	324.4	169.6	0.039	0.010	0.221
4369576.5	402786.4	r3	60	R	3	2	C		-0.11	73.8	99.9	0.035	0.012	0.550
4369576.4	402788.5	r4	78	R	4	3	O	60mm	-0.41	326.7	4.5	0.087	0.020	0.113
4369576.9	402790.7	r5	96	R	5	3	O	25mm	-0.39	359.8	5.8	0.057	0.014	0.572
4369577.5	402792.2	r6	115	R	6	2	C		-0.22	22.1	29.2	0.022	0.020	0.739
4369577.5	402794.4	r7		R	7	1	B							
4369577.8	402796.2	r8	153	R	8	2	C		-0.22	226.8	158.3	0.120	0.025	0.137
4369578.3	402798.1	r9	179	R	9	2	C		-0.17	5.1	-2.8	0.035	0.014	0.368
4369578.6	402800.3	r10		R	10	1	B							
4369578.8	402802.1	r11	220	R	11	2	C		-0.01	15.3	44.0	0.021	0.015	0.251
4369579.4	402804.2	r12		R	12	1	B							
4369579.7	402806.2	r13		R	13	1	B							
4369580.1	402808.0	r14	283	R	14	3	O	37mm	-0.23	344.8	-2.7	0.072	0.014	0.126
4369580.4	402810.1	r15		R	15	1	B							
4369580.8	402812.1	r16		R	16	1	B							
4369581.2	402814.1	r17		R	17	1	B							
4369581.6	402815.8	r18	362	R	18	2	C		-0.15	24.8	-4.5	0.039	0.016	0.202
4369581.9	402818.0	r19		R	19	1	B							
4369582.3	402819.9	r20		R	20	1	B							
4369577.3	402782.2	s1		S	1	1	B							
4369577.6	402784.1	s2	30	S	2	3	O	81mm	-0.24	11.3	-5.1	0.109	0.034	0.092
4369578.1	402786.2	s3		S	3	1	B							
4369578.3	402788.1	s4	79	S	4	2	C		-0.06	160.8	1.2	0.048	0.006	0.325
4369578.8	402790.1	s5		S	5	1	B							
4369579.0	402792.1	s6	116	S	6	3	O	60mm	-0.28	121.6	18.6	0.080	0.024	0.073
4369579.4	402793.8	s7	129	S	7	3	O	37mm	-0.21	145.0	-2.6	0.061	0.016	0.550
4369579.9	402795.9	s8	154	S	8	3	O	60mm	-0.13	24.1	4.8	0.090	0.021	0.093
4369580.1	402797.9	s9	176	S	9	3	O	105Heat	-0.77	40.3	-9.1	0.096	0.041	0.138
4369580.6	402799.8	s10	190	S	10	2	C		-0.17	92.8	5.5	0.031	0.018	0.226
4369581.2	402802.1	s11	221	S	11	2	C		-0.14	156.0	-16.4	0.025	0.013	0.675
4369581.3	402803.9	s12		S	12	1	B							
4369581.7	402805.7	s13	258	S	13	2	C		-0.07	25.6	6.1	0.047	0.014	0.080
4369582.0	402807.8	s14		S	14	1	B							
4369582.4	402809.7	s15		S	15	1	B							
4369582.8	402811.7	s16		S	16	1	B							
4369583.2	402813.6	s17	338	S	17	3	O	105M60	-0.17	292.3	22.1	0.127	0.046	0.087
4369583.5	402815.5	s18	358	S	18	2	C		0.00	35.8	12.9	0.022	0.006	0.596

APG Blind Test Grid

Northing, UTM 18N, meters	Easting, UTM 18N, meters	Cell	Anomaly Number	Letter	Number	Disc. Stage/Rank 3 - Ord 2 - Clutter 1 - Blank	Class O - Ord C - Clutter B - Blank	Type	Depth (m)	Azimuth (Deg)	Inclination (Deg)	Length (m)	Radius (m)	MSE
4369583.9	402817.6	s19		S	19	1	B							
4369584.2	402819.5	s20	401	S	20	3	O	60mm	-0.18	24.7	-16.7	0.085	0.023	0.082
4369579.3	402781.8	t1	12	T	1	2	C		-0.14	74.6	-4.7	0.040	0.013	0.188
4369579.7	402783.8	t2	27	T	2	3	O	25mm	-0.10	33.8	3.1	0.053	0.022	0.173
4369579.9	402785.6	t3	52	T	3	2	C		-0.16	17.1	-2.7	0.037	0.015	0.286
4369580.5	402787.8	t4	67	T	4	2	C		-0.33	70.7	1.9	0.105	0.013	0.880
4369580.7	402789.7	t5	88	T	5	3	O	105M60	-0.79	94.8	10.1	0.118	0.041	0.120
4369581.0	402791.6	t6	113	T	6	2	C		-0.11	127.5	-11.5	0.048	0.010	0.334
4369580.9	402793.1	t7	120	T	7	2	C		-1.48	34.7	7.3	0.145	0.029	0.989
4369582.3	402795.6	t8	149	T	8	2	C		-0.13	349.9	3.6	0.033	0.007	0.510
4369582.1	402797.9	t9	168	T	9	3	O	25mm	-0.23	107.5	-15.6	0.061	0.012	0.169
4369582.6	402799.5	t10		T	10	1	B							
4369582.9	402801.4	t11	214	T	11	3	O	37mm	-0.11	86.8	29.7	0.072	0.014	0.276
4369583.2	402803.3	t12	236	T	12	2	C		-0.13	336.4	-3.2	0.029	0.015	0.344
4369583.7	402805.4	t13		T	13	1	B							
4369584.3	402808.0	t14	282	T	14	2	C		-0.29	54.5	108.3	0.039	0.011	0.147
4369584.3	402809.4	t15	300	T	15	2	C		-0.07	342.9	-21.3	0.022	0.011	0.434
4369584.7	402811.2	t16	317	T	16	2	C		-0.16	359.1	-2.9	0.035	0.011	0.570
4369584.7	402814.0	t17	335	T	17	2	C		-0.28	97.7	-26.2	0.042	0.012	0.964
4369585.7	402815.8	t18	364	T	18	2	C		0.00	135.4	-24.6	0.018	0.006	0.802
4369585.9	402817.2	t19		T	19	1	B							
4369586.2	402819.2	t20		T	20	1	B							

Extra - Could not clearly identify which cell these belong to									
Northing	Easting	Patch	Type	Depth	Azimuth	Inclination	MSE	Length	Width
4369571.1	402820.7	411	Clutter	-0.06	154.7	92.6	0.198	0.028	0.007
4369553.4	402822.9	432	Clutter	-0.04	110.3	9.8	0.417	0.018	0.010

APG Direct Fire Area

ALLTEM APG 2010 Direct Fire Area, ver.3												
Northing, UTM 18N, meters	Easting, UTM 18N, meters	Anomaly Number	Disc. Stage/Rank 3 - Ord 2 - Clutter	Class O - Ord C - Clutter	Type	Depth (m)	Azimuth (Deg)	Inclination (Deg)	Length (m)	Radius (m)	MSE	
4369682.0	402874.9	1400	2	C	Clutter	0.00	31.3	63.6	0.012	0.011	0.593	
4369643.3	402854.4	1200	2	C	Clutter	-0.05	119.4	191.8	0.014	0.014	0.594	
4369688.4	402778.6	49	2	C	Clutter	0.00	280.3	-10.4	0.015	0.007	0.826	
4369673.2	402827.5	725	2	C	Clutter	0.00	0.2	58.5	0.015	0.006	0.577	
4369666.7	402802.5	281	2	C	Clutter	-0.01	269.4	94.3	0.016	0.010	0.351	
4369667.1	402831.6	801	2	C	Clutter	-0.04	249.7	0.6	0.016	0.013	0.606	
4369641.1	402835.7	866	2	C	Clutter	-0.11	251.1	5.9	0.016	0.016	0.624	
4369732.6	402803.4	302	2	C	Clutter	-0.10	320.3	92.0	0.018	0.008	0.656	
4369676.2	402849.4	1094	2	C	Clutter	-0.02	104.0	7.6	0.020	0.008	0.521	
4369697.4	402848.7	1097	2	C	Clutter	-0.02	309.3	107.8	0.020	0.020	0.539	
4369658.8	402815.8	527	2	C	Clutter	-0.04	75.6	68.6	0.021	0.013	0.340	
4369648.9	402822.6	645	2	C	Clutter	-0.09	97.3	94.2	0.021	0.012	0.556	
4369683.9	402860.4	1272	2	C	Clutter	-0.01	331.1	156.2	0.021	0.008	0.568	
4369666.1	402869.9	1365	2	C	Clutter	-0.05	142.1	-5.1	0.021	0.012	0.443	
4369707.1	402807.7	372	2	C	Clutter	-0.01	40.6	8.9	0.022	0.006	0.859	
4369652.0	402829.8	768	2	C	Clutter	0.00	214.9	0.8	0.022	0.009	0.238	
4369636.9	402832.6	815	2	C	Clutter	-0.02	307.3	4.8	0.022	0.011	0.409	
4369639.7	402839.1	937	2	C	Clutter	0.00	321.2	9.4	0.023	0.007	0.464	
4369694.1	402842.1	983	2	C	Clutter	-0.06	19.3	0.4	0.023	0.008	0.648	
4369654.3	402847.6	1081	2	C	Clutter	0.00	341.9	14.5	0.023	0.007	0.476	
4369664.4	402863.8	1313	2	C	Clutter	-0.15	47.2	10.1	0.023	0.023	0.427	
4369667.8	402798.2	223	2	C	Clutter	-0.02	128.6	166.5	0.024	0.015	0.284	
4369731.8	402800.3	259	2	C	Clutter	-0.03	66.5	4.4	0.024	0.008	0.570	
4369663.3	402850.8	1133	2	C	Clutter	-0.20	67.1	-15.8	0.024	0.023	0.542	
4369733.2	402798.6	233	2	C	Clutter	-0.09	322.5	44.1	0.025	0.007	0.479	
4369658.9	402868.7	1362	2	C	Clutter	-0.09	243.1	28.9	0.025	0.012	0.220	
4369717.2	402787.9	123	2	C	Clutter	-0.11	349.7	37.4	0.026	0.011	0.374	
4369650.1	402823.6	664	2	C	Clutter	-0.12	123.9	-51.1	0.026	0.013	0.195	
4369697.7	402861.4	1283	2	C	Clutter	-0.19	123.5	29.6	0.026	0.019	0.432	
4369691.8	402774.2	30	2	C	Clutter	-0.06	217.9	10.6	0.027	0.020	0.226	
4369697.1	402814.1	495	2	C	Clutter	-0.02	182.6	40.5	0.027	0.009	0.865	
4369643.2	402845.6	1050	2	C	Clutter	-0.02	228.4	4.9	0.027	0.008	0.395	

APG Direct Fire Area

Northing, UTM 18N, meters	Easting, UTM 18N, meters	Anomaly Number	Disc. Stage/Rank 3 - Ord 2 - Clutter	Class O - Ord C - Clutter	Type	Depth (m)	Azimuth (Deg)	Inclination (Deg)	Length (m)	Radius (m)	MSE
4369689.3	402861.6	1284	2	C	Clutter	-0.12	76.9	32.2	0.027	0.006	0.874
4369741.6	402813.1	478	2	C	Clutter	-0.23	144.9	-0.8	0.028	0.016	0.665
4369636.6	402826.7	735	2	C	Clutter	-0.02	231.7	-3.9	0.028	0.008	0.378
4369713.9	402842.1	985	2	C	Clutter	-0.13	130.3	19.1	0.028	0.020	0.126
4369706.8	402852.7	1173	2	C	Clutter	-0.03	158.2	19.9	0.028	0.007	0.577
4369702.9	402764.5	3	2	C	Clutter	-0.06	273.4	119.3	0.029	0.015	0.348
4369696.8	402785.4	104	2	C	Clutter	-0.04	123.9	-56.6	0.029	0.012	0.525
4369732.0	402793.3	170	2	C	Clutter	-0.01	66.8	9.4	0.029	0.014	0.248
4369654.2	402820.5	605	2	C	Clutter	-0.13	225.4	15.7	0.029	0.009	0.683
4369731.6	402826.1	708	2	C	Clutter	-0.05	123.6	-5.1	0.029	0.009	0.445
4369633.3	402841.3	974	2	C	Clutter	-0.06	242.2	17.4	0.029	0.012	0.478
4369667.2	402842.3	991	2	C	Clutter	-0.02	339.1	78.9	0.029	0.021	0.071
4369646.5	402848.7	1093	2	C	Clutter	-0.16	221.8	91.0	0.029	0.017	0.315
4369676.6	402817.2	555	2	C	Clutter	-0.05	356.3	118.9	0.030	0.024	0.161
4369706.9	402827.0	722	2	C	Clutter	-0.10	125.4	-9.9	0.030	0.012	0.551
4369639.7	402833.4	821	2	C	Clutter	-0.03	200.2	3.8	0.030	0.009	0.230
4369658.3	402836.1	874	2	C	Clutter	-0.07	78.0	163.7	0.030	0.023	0.063
4369661.9	402852.8	1171	2	C	Clutter	-0.10	152.0	-16.0	0.030	0.013	0.325
4369709.3	402800.4	250	2	C	Clutter	-0.09	92.1	8.0	0.031	0.006	0.690
4369732.3	402821.1	624	2	C	Clutter	0.00	325.1	176.2	0.031	0.012	0.276
4369635.8	402834.5	841	2	C	Clutter	0.00	327.8	18.4	0.031	0.008	0.387
4369678.4	402878.3	1415	2	C	Clutter	-0.11	86.3	19.6	0.031	0.014	0.252
4369694.7	402791.5	158	2	C	Clutter	-0.08	173.2	-4.3	0.032	0.009	0.500
4369706.7	402792.5	169	2	C	Clutter	-0.12	114.5	171.3	0.032	0.014	0.480
4369659.1	402832.5	814	2	C	Clutter	-0.17	122.1	60.9	0.032	0.007	0.586
4369650.9	402841.5	975	2	C	Clutter	-0.13	59.5	4.7	0.032	0.020	0.364
4369673.6	402849.8	1112	2	C	Clutter	-0.04	80.7	10.7	0.032	0.005	0.307
4369676.9	402851.7	1154	2	C	Clutter	-0.09	129.0	8.2	0.032	0.019	0.191
4369708.5	402771.4	18	2	C	Clutter	-0.15	132.7	128.9	0.033	0.021	0.146
4369657.4	402809.4	402	2	C	Clutter	-0.10	275.3	13.6	0.033	0.005	0.451
4369724.4	402823.4	667	2	C	Clutter	-0.05	100.2	2.2	0.033	0.009	0.268
4369718.9	402827.4	732	2	C	Clutter	-0.10	308.8	16.4	0.033	0.005	0.463
4369685.5	402868.4	1357	2	C	Clutter	-0.06	126.1	-12.7	0.033	0.018	0.181

APG Direct Fire Area

Northing, UTM 18N, meters	Easting, UTM 18N, meters	Anomaly Number	Disc. Stage/Rank 3 - Ord 2 - Clutter	Class O - Ord C - Clutter	Type	Depth (m)	Azimuth (Deg)	Inclination (Deg)	Length (m)	Radius (m)	<i>MSE</i>
4369680.8	402871.9	1381	2	C	Clutter	-0.10	168.1	12.4	0.033	0.012	0.442
4369670.5	402874.1	1394	2	C	Clutter	-0.07	304.4	175.8	0.033	0.010	0.440
4369685.6	402777.0	40	2	C	Clutter	-0.16	299.0	3.7	0.034	0.020	0.165
4369670.3	402800.5	260	2	C	Clutter	-0.12	128.8	158.5	0.034	0.027	0.387
4369707.3	402832.2	809	2	C	Clutter	-0.07	63.9	7.1	0.034	0.006	0.347
4369678.1	402864.8	1360	2	C	Clutter	-0.12	155.4	-5.9	0.034	0.018	0.159
4369685.5	402868.4	1367	2	C	Clutter	-0.07	135.6	-13.2	0.034	0.019	0.187
4369723.9	402804.5	318	2	C	Clutter	-0.03	35.0	76.6	0.035	0.001	0.592
4369673.9	402825.4	697	2	C	Clutter	-0.11	322.7	9.3	0.035	0.021	0.144
4369641.6	402833.9	836	2	C	Clutter	-0.09	301.1	14.4	0.035	0.007	0.301
4369631.6	402835.5	840	2	C	Clutter	-0.17	270.3	4.9	0.035	0.007	0.760
4369683.0	402834.4	845	2	C	Clutter	0.00	356.3	0.1	0.035	0.006	0.391
4369636.1	402839.3	938	2	C	Clutter	-0.01	320.2	4.7	0.035	0.013	0.149
4369638.6	402841.6	976	2	C	Clutter	0.00	288.5	6.7	0.035	0.007	0.330
4369702.3	402858.9	1255	2	C	Clutter	-0.11	170.9	167.9	0.035	0.010	0.375
4369677.8	402863.5	1371	2	C	Clutter	0.00	121.0	-4.3	0.035	0.009	0.732
4369735.6	402815.7	537	2	C	Clutter	-0.25	333.4	167.1	0.036	0.017	0.516
4369652.4	402835.9	862	2	C	Clutter	-0.05	135.5	-0.4	0.036	0.016	0.440
4369666.9	402836.3	869	2	C	Clutter	-0.29	127.7	10.5	0.036	0.021	0.111
4369672.5	402855.2	1207	2	C	Clutter	0.00	289.1	-29.9	0.036	0.020	0.165
4369722.4	402807.9	380	2	C	Clutter	-0.22	272.5	58.2	0.037	0.010	0.282
4369665.6	402818.9	584	2	C	Clutter	-0.09	208.7	-2.4	0.037	0.019	0.143
4369681.7	402822.5	643	2	C	Clutter	0.00	87.2	189.9	0.037	0.007	0.258
4369684.5	402826.5	720	2	C	Clutter	-0.17	300.9	5.1	0.037	0.018	0.513
4369658.9	402852.3	1163	2	C	Clutter	-0.07	137.4	171.4	0.037	0.013	0.443
4369668.8	402879.7	1419	2	C	Clutter	-0.15	149.2	39.1	0.037	0.006	0.472
4369745.5	402804.4	337	2	C	Clutter	-0.35	70.7	51.9	0.038	0.023	0.571
4369715.9	402820.9	617	2	C	Clutter	-0.08	164.9	10.6	0.038	0.003	0.674
4369683.8	402830.7	784	2	C	Clutter	-0.08	161.9	117.3	0.038	0.020	0.102
4369647.1	402849.9	1123	2	C	Clutter	-0.11	153.1	4.1	0.038	0.011	0.458
4369666.2	402794.1	184	2	C	Clutter	-0.06	152.1	1.9	0.039	0.011	0.208
4369699.8	402797.0	213	2	C	Clutter	-0.09	248.2	-5.6	0.039	0.012	0.224
4369712.9	402812.5	475	2	C	Clutter	-0.07	237.5	-10.1	0.039	0.016	0.499

APG Direct Fire Area

Northing, UTM 18N, meters	Easting, UTM 18N, meters	Anomaly Number	Disc. Stage/Rank 3 - Ord 2 - Clutter	Class O - Ord C - Clutter	Type	Depth (m)	Azimuth (Deg)	Inclination (Deg)	Length (m)	Radius (m)	<i>MSE</i>
4369671.3	402830.1	751	2	C	Clutter	-0.04	250.8	13.9	0.039	0.017	0.244
4369674.0	402838.3	919	2	C	Clutter	-0.18	24.4	3.0	0.039	0.015	0.419
4369713.7	402798.6	230	2	C	Clutter	-0.11	152.0	8.0	0.040	0.015	0.188
4369691.5	402803.7	304	2	C	Clutter	-0.07	256.5	2.4	0.040	0.026	0.157
4369650.8	402813.0	485	2	C	Clutter	-0.08	259.8	-0.5	0.040	0.015	0.141
4369672.8	402817.1	548	2	C	Clutter	-0.10	209.3	-14.2	0.040	0.017	0.132
4369680.5	402828.9	753	2	C	Clutter	-0.18	217.7	13.7	0.040	0.014	0.269
4369693.2	402847.6	1079	2	C	Clutter	-0.04	98.1	-20.2	0.040	0.019	0.142
4369679.0	402784.4	96	2	C	Clutter	-0.13	288.8	-7.9	0.041	0.022	0.091
4369699.7	402786.5	114	2	C	Clutter	-0.12	176.0	-7.2	0.041	0.008	0.315
4369685.9	402787.1	119	2	C	Clutter	-0.11	49.0	162.0	0.041	0.017	0.103
4369694.3	402796.5	206	2	C	Clutter	-0.11	116.4	170.9	0.041	0.011	0.326
4369695.6	402812.9	477	2	C	Clutter	-0.16	294.6	10.0	0.041	0.018	0.284
4369681.3	402814.3	507	2	C	Clutter	-0.13	152.2	-13.5	0.041	0.004	0.731
4369718.6	402842.6	988	2	C	Clutter	-0.12	114.2	35.0	0.041	0.011	0.838
4369650.8	402846.5	1068	2	C	Clutter	-0.12	225.2	183.5	0.041	0.020	0.363
4369650.4	402850.0	1120	2	C	Clutter	-0.04	332.1	-9.4	0.041	0.013	0.292
4369685.8	402854.5	1203	2	C	Clutter	-0.03	51.0	-5.3	0.041	0.016	0.153
4369684.4	402870.0	1370	2	C	Clutter	-0.13	67.6	-0.5	0.041	0.009	0.241
4369666.7	402877.1	1411	2	C	Clutter	-0.07	352.1	3.5	0.041	0.004	0.347
4369655.7	402806.4	354	2	C	Clutter	-0.03	90.5	168.5	0.042	0.005	0.236
4369667.4	402808.9	401	2	C	Clutter	-0.08	296.0	9.8	0.042	0.015	0.272
4369675.6	402835.9	868	2	C	Clutter	-0.09	115.4	18.4	0.042	0.026	0.752
4369667.4	402851.1	1136	2	C	Clutter	-0.11	152.1	5.0	0.042	0.013	0.224
4369681.7	402860.3	1274	2	C	Clutter	0.00	284.7	179.9	0.042	0.008	0.367
4369678.4	402873.4	1385	2	C	Clutter	-0.17	88.0	0.0	0.042	0.017	0.615
4369694.4	402777.4	38	2	C	Clutter	-0.13	206.9	-9.7	0.043	0.020	0.110
4369687.4	402805.3	335	2	C	Clutter	-0.50	194.3	16.5	0.043	0.020	0.742
4369710.5	402818.5	568	2	C	Clutter	-0.26	267.0	33.1	0.043	0.006	0.598
4369643.0	402822.0	636	2	C	Clutter	-0.08	177.9	196.1	0.043	0.010	0.412
4369647.6	402840.9	964	2	C	Clutter	-0.18	146.4	-6.1	0.043	0.016	0.306
4369648.2	402853.4	1183	2	C	Clutter	-0.18	347.4	8.9	0.043	0.025	0.572
4369698.1	402780.9	63	2	C	Clutter	-0.17	269.6	8.7	0.044	0.018	0.673

APG Direct Fire Area

Northing, UTM 18N, meters	Easting, UTM 18N, meters	Anomaly Number	Disc. Stage/Rank 3 - Ord 2 - Clutter	Class O - Ord C - Clutter	Type	Depth (m)	Azimuth (Deg)	Inclination (Deg)	Length (m)	Radius (m)	MSE
4369745.1	402803.8	300	2	C	Clutter	-0.17	79.9	-4.8	0.044	0.029	0.153
4369649.5	402818.4	573	2	C	Clutter	-0.16	188.2	-8.9	0.044	0.006	0.499
4369656.5	402819.0	582	2	C	Clutter	-0.16	156.7	1.6	0.044	0.013	0.439
4369659.6	402865.5	1331	2	C	Clutter	-0.06	1.1	200.5	0.044	0.021	0.113
4369640.5	402841.1	970	2	C	Clutter	-0.08	316.7	17.5	0.045	0.019	0.126
4369715.2	402779.2	54	2	C	Clutter	-0.08	160.4	-10.3	0.046	0.006	0.305
4369718.4	402831.7	794	2	C	Clutter	-0.16	180.9	-1.6	0.046	0.021	0.373
4369661.6	402854.8	1202	2	C	Clutter	-0.08	105.6	-8.7	0.046	0.012	0.529
4369701.4	402843.1	1006	2	C	Clutter	-0.16	34.4	3.0	0.046	0.011	0.171
4369683.4	402814.0	499	2	C	Clutter	-0.12	73.4	166.1	0.046	0.014	0.211
4369700.3	402843.9	1022	2	C	Clutter	-0.04	41.4	170.1	0.046	0.013	0.219
4369636.5	402846.4	1065	2	C	Clutter	-0.11	140.2	169.8	0.047	0.013	0.210
4369697.7	402784.7	99	2	C	Clutter	-0.10	160.9	53.8	0.048	0.024	0.325
4369687.5	402827.3	721	2	C	Clutter	-0.12	271.1	169.8	0.048	0.006	0.188
4369645.9	402849.8	1122	2	C	Clutter	-0.23	136.5	-1.1	0.048	0.025	0.339
4369719.4	402811.9	454	2	C	Clutter	-0.11	149.0	6.5	0.049	0.005	0.396
4369691.7	402835.9	871	2	C	Clutter	-0.59	143.9	51.7	0.050	0.027	0.653
4369686.2	402872.7	1386	2	C	Clutter	-0.07	184.7	-31.1	0.050	0.029	0.117
4369684.5	402840.3	951	2	C	Clutter	-0.11	20.0	5.7	0.050	0.026	0.239
4369665.5	402850.0	1119	2	C	Clutter	-0.11	131.3	-23.6	0.052	0.008	0.205
4369651.2	402824.2	676	2	C	Clutter	-0.09	330.5	-9.2	0.054	0.031	0.235
4369703.6	402772.0	19	2	C	Clutter	-0.27	262.8	155.3	0.056	0.006	0.403
4369693.2	402791.6	156	2	C	Clutter	-0.05	46.2	177.7	0.057	0.007	0.133
4369747.9	402808.7	405	2	C	Clutter	-0.12	20.5	40.3	0.057	0.010	0.864
4369718.0	402813.8	498	2	C	Clutter	-0.10	254.3	192.7	0.060	0.007	0.173
4369684.3	402827.6	719	2	C	Clutter	-0.57	133.5	42.1	0.061	0.034	0.146
4369703.1	402825.5	698	2	C	Clutter	-0.75	21.3	34.4	0.062	0.037	0.516
4369654.8	402854.7	1205	2	C	Clutter	-0.15	347.3	14.2	0.062	0.032	0.295
4369710.4	402771.1	16	2	C	Clutter	-0.03	298.3	8.4	0.063	0.031	0.187
4369660.7	402827.8	740	2	C	Clutter	-0.18	299.7	3.7	0.063	0.004	0.375
4369648.3	402843.8	1014	2	C	Clutter	-0.04	9.5	2.9	0.064	0.009	0.606
4369660.2	402846.8	1073	2	C	Clutter	-0.21	255.2	-0.7	0.064	0.033	0.137
4369717.3	402793.8	181	2	C	Clutter	-0.05	92.9	8.2	0.066	0.008	0.151

APG Direct Fire Area

Northing, UTM 18N, meters	Easting, UTM 18N, meters	Anomaly Number	Disc. Stage/Rank 3 - Ord 2 - Clutter	Class O - Ord C - Clutter	Type	Depth (m)	Azimuth (Deg)	Inclination (Deg)	Length (m)	Radius (m)	<i>MSE</i>
4369667.1	402827.7	737	2	C	Clutter	-0.18	247.3	-2.2	0.066	0.034	0.255
4369680.2	402844.1	1011	2	C	Clutter	-0.09	97.3	8.7	0.076	0.007	0.252
4369673.1	402798.6	232	2	C	Clutter	-0.09	265.6	6.8	0.079	0.036	0.137
4369654.2	402862.7	1300	2	C	Clutter	-0.06	55.1	-0.3	0.082	0.034	0.090
4369655.8	402816.7	544	2	C	Clutter	-0.07	3.9	-2.6	0.083	0.009	0.121
4369701.8	402795.3	197	2	C	Clutter	-0.08	318.5	-5.4	0.087	0.008	0.157
4369659.4	402853.3	1185	2	C	Clutter	-0.28	40.9	11.9	0.087	0.038	0.454
4369680.8	402868.0	1356	2	C	Clutter	-0.15	65.1	12.8	0.088	0.036	0.168
4369661.7	402855.6	1204	2	C	Clutter	-0.30	4.9	6.3	0.091	0.037	0.601
4369657.0	402809.0	400	2	C	Clutter	-0.20	126.9	14.9	0.092	0.012	0.665
4369638.4	402848.1	1086	2	C	Clutter	-0.09	48.2	-6.9	0.092	0.038	0.134
4369673.7	402877.8	1429	2	C	Clutter	-0.08	25.0	4.4	0.092	0.027	0.182
4369689.2	402795.9	203	2	C	Clutter	-0.10	355.9	176.1	0.093	0.007	0.139
4369695.4	402824.8	677	2	C	Clutter	-0.06	104.3	1.0	0.093	0.017	0.229
4369667.3	402833.5	830	2	C	Clutter	-0.10	329.8	-18.6	0.096	0.015	0.142
4369722.1	402786.2	111	2	C	Clutter	-0.91	59.4	-20.1	0.097	0.040	0.820
4369672.5	402860.0	1276	2	C	Clutter	-0.12	30.8	-2.5	0.098	0.025	0.153
4369633.6	402836.8	889	2	C	Clutter	-0.10	321.0	-1.5	0.101	0.029	0.106
4369681.6	402876.5	1409	2	C	Clutter	-0.17	135.4	0.6	0.101	0.032	0.162
4369673.0	402879.6	1418	2	C	Clutter	-0.13	166.6	8.5	0.101	0.022	0.101
4369704.8	402818.8	579	2	C	Clutter	-0.06	128.4	6.6	0.103	0.028	0.104
4369716.2	402825.8	706	2	C	Clutter	-0.10	152.8	7.2	0.105	0.022	0.278
4369691.9	402860.0	1266	2	C	Clutter	-0.09	346.1	163.2	0.106	0.011	0.243
4369700.1	402816.4	522	2	C	Clutter	-0.75	162.2	191.7	0.107	0.037	0.484
4369688.8	402852.0	1159	2	C	Clutter	-0.04	166.7	14.8	0.109	0.032	0.211
4369709.6	402827.3	731	2	C	Clutter	-0.09	124.1	-7.0	0.111	0.036	0.236
4369659.2	402861.5	1290	2	C	Clutter	-0.11	135.3	12.1	0.122	0.021	0.252
4369672.0	402879.8	1422	2	C	Clutter	-0.23	356.5	1.5	0.123	0.024	0.127
4369680.5	402833.7	834	2	C	Clutter	-0.08	264.5	-5.8	0.126	0.033	0.130
4369714.0	402776.0	34	2	C	Clutter	-0.03	97.8	-1.6	0.136	0.018	0.093
4369653.5	402837.5	901	2	C	Clutter	-0.08	278.6	1.5	0.142	0.024	0.213
4369679.2	402849.2	1125	2	C	Clutter	-0.57	102.9	25.6	0.151	0.046	0.581
4369659.6	402840.3	942	2	C	Clutter	-0.75	113.5	201.9	0.312	0.002	0.913

APG Direct Fire Area

Northing, UTM 18N, meters	Easting, UTM 18N, meters	Anomaly Number	Disc. Stage/Rank 3 - Ord 2 - Clutter	Class O - Ord C - Clutter	Type	Depth (m)	Azimuth (Deg)	Inclination (Deg)	Length (m)	Radius (m)	MSE
4369646.7	402835.5	861	2	C	Clutter	-0.57	228.8	139.1	0.395	0.003	0.440
4369697.4	402853.8	1170	2	C	Clutter	-0.36	86.0	40.9	0.556	0.001	0.562
4369695.6	402838.2	913	3	O	105HEAT	-0.67	77.6	5.2	0.052	0.048	0.187
4369723.2	402829.6	773	3	O	105HEAT	-0.60	82.7	-0.7	0.055	0.050	0.103
4369716.3	402803.6	303	3	O	105HEAT	-0.61	26.4	6.6	0.057	0.051	0.054
4369711.1	402811.4	449	3	O	105HEAT	-0.57	175.9	26.0	0.059	0.044	0.116
4369713.4	402820.3	607	3	O	105HEAT	-0.95	52.8	8.4	0.061	0.053	0.288
4369709.8	402849.0	1101	3	O	105HEAT	-0.26	183.1	86.9	0.061	0.052	0.110
4369678.1	402789.3	136	3	O	105HEAT	-0.41	304.9	19.1	0.062	0.056	0.117
4369689.9	402824.0	673	3	O	105HEAT	-0.19	283.0	80.7	0.064	0.050	0.099
4369673.8	402840.1	957	3	O	105HEAT	-0.34	60.6	-4.7	0.064	0.058	0.079
4369658.7	402822.2	637	3	O	105HEAT	-0.62	271.2	-4.6	0.065	0.045	0.074
4369702.8	402812.9	459	3	O	105HEAT	-0.77	82.4	14.3	0.068	0.050	0.181
4369661.1	402825.0	421	3	O	105HEAT	-0.44	241.9	3.7	0.069	0.055	0.101
4369669.5	402865.4	1330	3	O	105HEAT	-0.47	2.2	28.4	0.069	0.050	0.064
4369689.8	402842.5	1000	3	O	105HEAT	-0.45	239.6	150.4	0.070	0.049	0.073
4369698.4	402781.9	78	3	O	105HEAT	-0.55	239.5	4.0	0.071	0.045	0.070
4369663.0	402862.2	1292	3	O	105HEAT	-0.27	78.9	24.8	0.071	0.068	0.096
4369669.5	402875.8	1417	3	O	105HEAT	-0.02	140.3	18.9	0.071	0.047	0.457
4369691.1	402844.2	1029	3	O	105HEAT	-0.63	45.6	17.5	0.074	0.054	0.186
4369673.1	402865.2	1328	3	O	105HEAT	-0.32	30.6	17.3	0.074	0.059	0.066
4369655.7	402853.2	1179	3	O	105HEAT	-0.37	309.2	-45.1	0.076	0.052	0.062
4369664.2	402860.5	1273	3	O	105HEAT	-0.58	70.6	13.3	0.076	0.045	0.106
4369690.1	402838.6	910	3	O	105HEAT	-0.85	47.3	13.4	0.077	0.046	0.224
4369697.7	402788.9	135	3	O	105HEAT	-0.20	218.7	41.5	0.078	0.048	0.108
4369675.2	402824.6	684	3	O	105HEAT	-0.52	221.8	-3.0	0.078	0.052	0.065
4369675.5	402831.8	802	3	O	105HEAT	-0.36	188.3	-27.8	0.078	0.055	0.089
4369739.6	402798.4	229	3	O	105HEAT	-0.10	126.6	17.4	0.079	0.056	0.334
4369696.7	402801.4	272	3	O	105HEAT	-0.71	220.5	-3.4	0.079	0.049	0.141
4369634.9	402841.0	963	3	O	105HEAT	-0.09	198.1	18.4	0.079	0.051	0.096
4369657.1	402843.5	1009	3	O	105HEAT	-0.80	298.1	16.0	0.079	0.054	0.120
4369658.8	402849.6	1113	3	O	105HEAT	-0.47	331.2	-6.0	0.079	0.050	0.067
4369649.2	402852.0	1144	3	O	105HEAT	-0.30	227.9	35.1	0.079	0.064	0.072

APG Direct Fire Area

Northing, UTM 18N, meters	Easting, UTM 18N, meters	Anomaly Number	Disc. Stage/Rank 3 - Ord 2 - Clutter	Class O - Ord C - Clutter	Type	Depth (m)	Azimuth (Deg)	Inclination (Deg)	Length (m)	Radius (m)	MSE
4369731.0	402810.3	424	3	O	105HEAT	-0.31	77.4	15.0	0.080	0.047	0.108
4369655.6	402847.4	1076	3	O	105HEAT	-0.81	170.3	10.5	0.080	0.053	0.170
4369677.0	402869.3	1363	3	O	105HEAT	-0.42	64.0	-6.8	0.080	0.040	0.126
4369673.2	402860.9	1268	3	O	105HEAT	-0.80	68.0	9.3	0.081	0.052	0.240
4369680.2	402840.9	961	3	O	105HEAT	-0.54	7.7	14.5	0.082	0.055	0.078
4369679.6	402804.0	306	3	O	105HEAT	-0.58	312.6	0.5	0.083	0.051	0.089
4369728.6	402813.4	465	3	O	105HEAT	-0.37	207.2	13.9	0.083	0.053	0.070
4369714.7	402835.7	855	3	O	105HEAT	-0.61	97.7	5.9	0.083	0.051	0.064
4369654.6	402860.9	1275	3	O	105HEAT	-0.34	29.8	37.8	0.084	0.058	0.105
4369669.6	402826.0	709	3	O	105HEAT	-0.35	201.4	-22.7	0.085	0.053	0.064
4369683.8	402837.0	887	3	O	105HEAT	-0.51	37.6	-11.1	0.085	0.050	0.064
4369697.3	402795.5	198	3	O	105HEAT	-0.28	34.5	16.0	0.086	0.057	0.087
4369684.9	402805.1	331	3	O	105HEAT	-0.70	160.3	11.7	0.086	0.057	0.125
4369696.0	402811.3	442	3	O	105HEAT	-0.49	194.2	10.7	0.086	0.050	0.076
4369713.6	402796.4	211	3	O	105HEAT	-0.44	248.4	-6.7	0.087	0.054	0.102
4369670.5	402814.5	508	3	O	105HEAT	-0.51	168.5	5.2	0.087	0.053	0.070
4369674.6	402822.9	652	3	O	105HEAT	-0.08	320.8	0.7	0.087	0.055	0.120
4369693.8	402782.0	64	3	O	105HEAT	-0.50	199.7	7.3	0.088	0.048	0.068
4369668.2	402829.1	754	3	O	105HEAT	-0.33	318.9	4.6	0.088	0.053	0.071
4369689.6	402847.2	1078	3	O	105HEAT	-0.49	131.3	-10.8	0.088	0.058	0.123
4369695.7	402778.1	43	3	O	105HEAT	-0.50	258.1	-12.0	0.089	0.051	0.114
4369680.0	402795.8	202	3	O	105HEAT	-0.77	231.6	11.1	0.089	0.046	0.139
4369640.7	402826.2	710	3	O	105HEAT	-0.12	314.2	-5.8	0.089	0.059	0.118
4369662.7	402828.8	746	3	O	105HEAT	-0.40	339.7	33.3	0.089	0.057	0.084
4369703.9	402857.4	1238	3	O	105HEAT	-0.13	173.5	-18.7	0.089	0.043	0.098
4369667.4	402859.5	1264	3	O	105HEAT	-0.48	92.2	-9.4	0.089	0.057	0.096
4369677.8	402885.2	1432	3	O	105HEAT	-0.25	191.1	2.7	0.089	0.072	0.133
4369713.5	402796.4	204	3	O	105HEAT	-0.39	34.2	9.9	0.091	0.052	0.085
4369716.8	402810.9	434	3	O	105HEAT	-0.39	161.8	-17.9	0.091	0.056	0.058
4369663.6	402859.3	1263	3	O	105HEAT	-0.62	72.7	-0.9	0.091	0.045	0.093
4369642.3	402838.5	922	3	O	105HEAT	-0.08	290.8	-12.3	0.092	0.041	0.239
4369665.8	402814.8	509	3	O	105HEAT	-0.41	206.0	7.6	0.093	0.055	0.058
4369664.1	402815.2	517	3	O	105HEAT	-0.49	213.5	-1.7	0.093	0.058	0.074

APG Direct Fire Area

Northing, UTM 18N, meters	Easting, UTM 18N, meters	Anomaly Number	Disc. Stage/Rank 3 - Ord 2 - Clutter	Class O - Ord C - Clutter	Type	Depth (m)	Azimuth (Deg)	Inclination (Deg)	Length (m)	Radius (m)	MSE
4369652.7	402857.5	1242	3	O	105HEAT	-0.34	310.8	-7.0	0.093	0.054	0.087
4369697.3	402788.5	133	3	O	105HEAT	-0.25	131.9	-3.0	0.094	0.059	0.161
4369721.9	402816.3	545	3	O	105HEAT	-0.43	49.1	-13.6	0.094	0.058	0.065
4369684.8	402816.5	552	3	O	105HEAT	-0.56	222.6	2.3	0.094	0.054	0.069
4369661.3	402865.8	1332	3	O	105HEAT	-0.12	181.8	16.2	0.094	0.042	0.231
4369651.8	402845.6	1041	3	O	105HEAT	-0.72	158.5	17.7	0.095	0.043	0.123
4369683.9	402849.4	1107	3	O	105HEAT	-0.39	90.8	-2.9	0.095	0.055	0.077
4369657.0	402851.1	1139	3	O	105HEAT	-0.48	287.9	5.4	0.095	0.055	0.065
4369662.0	402820.3	603	3	O	105HEAT	-0.25	31.5	9.2	0.096	0.062	0.101
4369719.1	402833.5	827	3	O	105HEAT	-1.16	172.6	11.7	0.096	0.053	0.553
4369664.0	402837.9	914	3	O	105HEAT	-0.35	13.4	8.3	0.096	0.060	0.095
4369654.0	402844.5	1026	3	O	105HEAT	-0.55	354.2	23.7	0.096	0.044	0.117
4369670.5	402867.9	1354	3	O	105HEAT	-0.36	11.6	11.1	0.096	0.059	0.060
4369704.3	402785.5	107	3	O	105HEAT	-0.30	314.9	-22.0	0.097	0.055	0.096
4369698.0	402807.9	387	3	O	105HEAT	-0.28	230.8	28.5	0.097	0.067	0.202
4369671.6	402819.5	599	3	O	105HEAT	-0.28	199.1	6.5	0.097	0.052	0.084
4369714.9	402828.4	744	3	O	105HEAT	-0.23	37.1	-7.7	0.097	0.061	0.083
4369661.7	402843.2	993	3	O	105HEAT	-0.33	277.8	-5.3	0.097	0.060	0.132
4369651.9	402855.8	1217	3	O	105HEAT	-0.37	349.2	-6.9	0.097	0.058	0.128
4369707.2	402798.3	219	3	O	105HEAT	-0.38	236.8	7.6	0.098	0.053	0.072
4369665.4	402853.1	1176	3	O	105HEAT	-0.25	165.8	-2.6	0.098	0.054	0.104
4369668.9	402862.0	1299	3	O	105HEAT	-0.45	139.7	-26.2	0.098	0.060	0.165
4369664.1	402867.2	1348	3	O	105HEAT	-0.26	191.3	-0.2	0.098	0.059	0.283
4369697.1	402846.4	1057	3	O	105HEAT	-0.10	83.3	-20.4	0.099	0.058	0.083
4369667.5	402824.2	672	3	O	105HEAT	-0.32	3.8	4.2	0.100	0.061	0.076
4369713.9	402808.2	390	3	O	105HEAT	-0.09	133.5	8.2	0.101	0.048	0.204
4369654.7	402860.9	1286	3	O	105HEAT	-0.34	31.7	16.7	0.101	0.058	0.108
4369690.8	402866.1	1334	3	O	105HEAT	-0.24	116.5	0.1	0.101	0.061	0.215
4369685.2	402844.8	1032	3	O	105HEAT	-0.51	68.9	-1.8	0.102	0.054	0.081
4369666.8	402853.1	1178	3	O	105HEAT	-0.37	190.5	-15.7	0.102	0.061	0.140
4369661.8	402843.1	1010	3	O	105HEAT	-0.25	335.7	-17.4	0.103	0.049	0.074
4369645.8	402823.1	656	3	O	105HEAT	-0.13	283.1	2.5	0.104	0.066	0.095
4369696.9	402851.6	1150	3	O	105HEAT	-0.28	82.6	-17.1	0.104	0.073	0.187

APG Direct Fire Area

Northing, UTM 18N, meters	Easting, UTM 18N, meters	Anomaly Number	Disc. Stage/Rank 3 - Ord 2 - Clutter	Class O - Ord C - Clutter	Type	Depth (m)	Azimuth (Deg)	Inclination (Deg)	Length (m)	Radius (m)	MSE
4369654.0	402856.5	1226	3	O	105HEAT	-0.24	2.2	-10.7	0.104	0.060	0.085
4369694.8	402866.2	1336	3	O	105HEAT	-0.18	125.6	3.4	0.104	0.067	0.129
4369707.9	402798.3	220	3	O	105HEAT	-0.31	332.4	-14.8	0.105	0.045	0.378
4369657.8	402860.7	1277	3	O	105HEAT	-0.31	31.0	-2.0	0.105	0.052	0.058
4369675.8	402820.5	616	3	O	105HEAT	-0.18	268.4	16.2	0.107	0.060	0.113
4369696.8	402842.1	984	3	O	105HEAT	-0.28	108.1	-10.0	0.107	0.061	0.095
4369677.3	402815.1	515	3	O	105HEAT	-0.57	236.0	7.8	0.108	0.048	0.176
4369713.9	402808.2	363	3	O	105HEAT	-0.08	133.0	5.1	0.111	0.042	0.231
4369665.5	402820.6	612	3	O	105HEAT	-0.86	300.5	5.9	0.111	0.056	0.199
4369646.9	402853.0	1158	3	O	105HEAT	-0.30	269.9	4.7	0.111	0.063	0.246
4369679.6	402806.8	367	3	O	105HEAT	-0.25	346.3	-15.1	0.112	0.060	0.114
4369651.2	402840.0	944	3	O	105HEAT	-0.41	348.1	13.0	0.112	0.043	0.077
4369663.2	402867.7	1349	3	O	105HEAT	-0.33	207.7	13.9	0.112	0.063	0.380
4369656.1	402829.1	757	3	O	105HEAT	-0.64	191.0	-7.6	0.113	0.044	0.092
4369652.7	402842.0	982	3	O	105HEAT	-0.14	346.4	-16.5	0.122	0.048	0.181
4369652.7	402841.9	972	3	O	105HEAT	-0.21	7.1	-8.1	0.123	0.063	0.286
4369666.8	402864.0	1311	3	O	105HEAT	-0.52	98.7	14.4	0.123	0.049	0.565
4369646.3	402853.1	1174	3	O	105HEAT	-0.30	339.0	-12.8	0.128	0.048	0.256
4369714.8	402793.0	172	3	O	105HEAT	-1.24	95.4	1.1	0.129	0.064	0.362
4369644.5	402848.9	1098	3	O	105HEAT	-0.39	289.4	-6.2	0.135	0.049	0.138
4369652.8	402844.7	1030	3	O	105HEAT	-0.45	4.5	-1.8	0.142	0.053	0.116
4369647.6	402833.0	810	3	O	105HEAT	-0.32	244.1	5.7	0.148	0.087	0.082
4369697.6	402808.7	383	3	O	105HEAT	-0.86	111.6	195.4	0.155	0.048	0.269
4369647.7	402833.1	828	3	O	105HEAT	-0.29	220.2	6.7	0.160	0.089	0.102
4369659.8	402860.9	1280	3	O	105HEAT	-0.46	138.3	4.8	0.162	0.074	0.192
4369690.7	402872.1	1383	3	O	105HEAT	-0.27	142.6	-4.9	0.173	0.069	0.130
4369677.8	402860.1	1271	3	O	105HEAT	-0.10	218.6	-13.8	0.179	0.076	0.124
4369645.8	402828.1	739	3	O	105HEAT	-0.42	208.5	3.4	0.189	0.088	0.118
4369664.8	402846.0	1056	3	O	105HEAT	-0.20	305.0	-7.2	0.190	0.074	0.135
4369722.8	402809.9	416	3	O	105HEAT	-0.73	347.7	1.4	0.191	0.073	0.315
4369709.4	402816.5	541	3	O	25mm	-0.07	188.4	141.1	0.045	0.015	0.054
4369675.3	402878.6	1416	3	O	25mm	-0.08	64.8	-9.5	0.045	0.017	0.106
4369677.1	402788.7	132	3	O	25mm	-0.14	309.8	-9.2	0.047	0.016	0.286

APG Direct Fire Area

Northing, UTM 18N, meters	Easting, UTM 18N, meters	Anomaly Number	Disc. Stage/Rank 3 - Ord 2 - Clutter	Class O - Ord C - Clutter	Type	Depth (m)	Azimuth (Deg)	Inclination (Deg)	Length (m)	Radius (m)	MSE
4369654.5	402859.1	1260	3	O	25mm	0.00	8.2	-15.7	0.048	0.015	0.477
4369690.4	402834.7	852	3	O	25mm	-0.29	168.1	-24.3	0.048	0.018	0.473
4369662.1	402815.0	514	3	O	25mm	-0.10	257.6	-5.7	0.048	0.018	0.136
4369725.2	402808.1	386	3	O	25mm	0.00	35.9	11.4	0.049	0.020	0.344
4369678.8	402823.8	670	3	O	25mm	-0.12	36.5	161.4	0.049	0.020	0.158
4369696.0	402835.1	854	3	O	25mm	-0.12	123.3	-11.1	0.050	0.015	0.204
4369652.6	402810.8	433	3	O	25mm	-0.06	317.7	-7.4	0.050	0.019	0.089
4369683.7	402863.6	1308	3	O	25mm	-0.33	291.2	29.2	0.050	0.014	0.271
4369661.1	402873.4	1390	3	O	25mm	-0.02	80.1	27.0	0.050	0.014	0.783
4369675.2	402794.3	187	3	O	25mm	-0.10	322.7	-4.1	0.052	0.024	0.137
4369659.4	402814.0	487	3	O	25mm	-0.01	322.8	-8.7	0.052	0.015	0.282
4369675.2	402825.9	707	3	O	25mm	-0.07	264.4	6.3	0.052	0.019	0.299
4369654.0	402827.3	728	3	O	25mm	-0.08	262.8	10.4	0.052	0.021	0.117
4369656.9	402842.3	962	3	O	25mm	-0.51	213.5	8.5	0.052	0.024	0.478
4369656.8	402847.9	1084	3	O	25mm	-0.18	135.4	168.5	0.052	0.014	0.174
4369722.7	402782.4	72	3	O	25mm	-0.31	217.1	7.7	0.053	0.021	0.483
4369678.3	402787.2	120	3	O	25mm	-0.14	61.0	89.6	0.053	0.022	0.153
4369693.7	402790.4	149	3	O	25mm	-0.11	209.4	146.8	0.053	0.016	0.325
4369682.7	402807.5	376	3	O	25mm	-0.06	243.8	-23.3	0.053	0.018	0.190
4369696.7	402779.3	51	3	O	25mm	-0.35	174.7	-12.5	0.054	0.019	0.457
4369650.1	402843.7	1019	3	O	25mm	-0.01	281.7	38.1	0.054	0.015	0.216
4369675.5	402802.5	286	3	O	25mm	-0.04	225.3	-1.3	0.055	0.025	0.218
4369650.9	402852.6	1162	3	O	25mm	-0.09	298.1	3.1	0.055	0.014	0.106
4369713.2	402802.3	279	3	O	25mm	-0.28	360.0	139.2	0.056	0.016	0.169
4369693.8	402809.0	398	3	O	25mm	-0.09	336.8	-15.9	0.056	0.023	0.252
4369649.9	402815.9	535	3	O	25mm	-0.12	69.8	171.0	0.057	0.015	0.186
4369669.1	402832.9	817	3	O	25mm	-0.29	156.1	228.8	0.057	0.025	0.325
4369692.4	402800.8	266	3	O	25mm	-0.12	247.2	26.3	0.058	0.023	0.376
4369650.1	402847.2	1067	3	O	25mm	-0.14	138.3	-18.5	0.058	0.021	0.172
4369669.3	402821.4	629	3	O	25mm	-0.02	240.5	1.9	0.059	0.013	0.138
4369729.9	402822.5	642	3	O	25mm	-0.55	4.0	-0.4	0.059	0.023	0.593
4369653.1	402831.3	795	3	O	25mm	-0.11	358.0	-4.1	0.059	0.024	0.136
4369653.5	402841.4	967	3	O	25mm	-0.14	195.9	11.3	0.059	0.015	0.191

APG Direct Fire Area

Northing, UTM 18N, meters	Easting, UTM 18N, meters	Anomaly Number	Disc. Stage/Rank 3 - Ord 2 - Clutter	Class O - Ord C - Clutter	Type	Depth (m)	Azimuth (Deg)	Inclination (Deg)	Length (m)	Radius (m)	<i>MSE</i>
4369678.9	402850.6	1134	3	O	25mm	-0.10	311.9	5.0	0.059	0.012	0.220
4369694.2	402790.6	147	3	O	25mm	-0.35	242.2	20.6	0.060	0.024	0.270
4369661.4	402848.0	1088	3	O	25mm	-0.18	324.0	5.9	0.060	0.027	0.177
4369730.2	402807.1	369	3	O	25mm	-0.13	92.6	32.2	0.061	0.015	0.159
4369649.7	402851.0	1140	3	O	25mm	-0.09	313.5	102.9	0.062	0.023	0.256
4369663.6	402857.3	1237	3	O	25mm	-0.10	7.5	20.0	0.062	0.023	0.196
4369672.1	402860.9	1269	3	O	25mm	-0.22	64.9	109.6	0.062	0.021	0.136
4369700.3	402824.5	688	3	O	25mm	-0.27	120.9	44.9	0.063	0.012	0.425
4369687.9	402846.5	1059	3	O	25mm	-0.17	45.9	-21.8	0.063	0.025	0.089
4369658.9	402823.3	659	3	O	25mm	-0.30	172.7	152.7	0.064	0.020	0.155
4369657.9	402855.6	1216	3	O	25mm	-0.17	144.3	1.8	0.064	0.024	0.479
4369665.6	402864.2	1317	3	O	25mm	-0.15	332.5	20.8	0.064	0.024	0.215
4369687.4	402793.0	173	3	O	25mm	-0.23	341.1	150.4	0.065	0.015	0.131
4369709.1	402802.0	276	3	O	25mm	-0.17	323.3	37.4	0.065	0.015	0.226
4369639.3	402843.8	1017	3	O	25mm	-0.03	331.7	1.4	0.065	0.011	0.181
4369700.4	402859.3	1261	3	O	25mm	-0.12	174.0	2.3	0.065	0.012	0.145
4369680.6	402794.1	188	3	O	25mm	-0.20	28.7	170.8	0.066	0.021	0.249
4369734.6	402809.4	412	3	O	25mm	-0.12	97.5	14.8	0.066	0.011	0.720
4369718.9	402822.0	638	3	O	25mm	-0.20	93.2	29.6	0.066	0.014	0.153
4369669.5	402870.1	1368	3	O	25mm	-0.10	115.4	-5.0	0.066	0.025	0.357
4369703.5	402793.5	180	3	O	25mm	-0.21	77.2	160.7	0.067	0.015	0.214
4369715.0	402802.8	290	3	O	25mm	-0.11	153.8	-16.3	0.067	0.021	0.146
4369672.2	402867.0	1345	3	O	25mm	-0.06	59.7	-17.7	0.067	0.021	0.210
4369677.1	402827.0	723	3	O	25mm	-0.15	53.8	157.5	0.068	0.022	0.327
4369686.5	402833.1	825	3	O	25mm	-0.02	172.0	16.4	0.068	0.014	0.322
4369645.0	402850.4	1128	3	O	25mm	-0.16	302.9	-14.8	0.069	0.028	0.321
4369645.3	402852.7	1160	3	O	25mm	-0.10	67.6	0.9	0.069	0.027	0.089
4369722.3	402784.0	95	3	O	25mm	-0.03	135.5	19.3	0.070	0.011	0.712
4369659.0	402859.7	1257	3	O	25mm	-0.12	151.7	-16.6	0.070	0.021	0.218
4369680.6	402830.4	781	3	O	25mm	-0.11	129.8	-0.2	0.071	0.020	0.388
4369648.8	402848.9	1102	3	O	25mm	-0.16	48.8	133.0	0.071	0.023	0.141
4369651.3	402858.8	1254	3	O	25mm	-0.02	102.5	-0.3	0.071	0.013	0.263
4369663.2	402865.0	1324	3	O	25mm	-0.02	108.1	5.9	0.071	0.021	0.160

APG Direct Fire Area

Northing, UTM 18N, meters	Easting, UTM 18N, meters	Anomaly Number	Disc. Stage/Rank 3 - Ord 2 - Clutter	Class O - Ord C - Clutter	Type	Depth (m)	Azimuth (Deg)	Inclination (Deg)	Length (m)	Radius (m)	MSE
4369706.8	402820.5	613	3	O	25mm	-0.14	288.4	50.3	0.072	0.020	0.147
4369711.5	402823.6	668	3	O	25mm	-0.07	85.1	-5.1	0.072	0.011	0.161
4369678.2	402841.7	978	3	O	25mm	-0.10	222.3	3.4	0.072	0.025	0.080
4369719.5	402802.3	285	3	O	25mm	-0.05	151.2	1.1	0.073	0.011	0.143
4369684.9	402811.9	457	3	O	25mm	-0.14	324.2	5.9	0.073	0.016	0.212
4369644.9	402842.6	997	3	O	25mm	-0.16	118.1	56.3	0.073	0.023	0.142
4369666.9	402818.4	576	3	O	25mm	-0.16	341.1	144.9	0.074	0.015	0.137
4369679.0	402833.1	819	3	O	25mm	-0.05	26.0	25.4	0.074	0.014	0.178
4369671.1	402858.7	1258	3	O	25mm	-0.14	349.6	179.4	0.074	0.013	0.435
4369675.6	402874.0	1393	3	O	25mm	-0.13	38.7	-6.6	0.074	0.02	0.097
4369688.1	402801.6	274	3	O	25mm	-0.06	230.0	0.9	0.075	0.023	0.133
4369708.7	402818.7	581	3	O	25mm	-0.14	155.3	30.5	0.075	0.016	0.138
4369673.8	402831.5	798	3	O	25mm	-0.19	209.8	-6.0	0.075	0.013	0.183
4369687.0	402846.5	1058	3	O	25mm	-0.18	166.2	6.2	0.075	0.023	0.287
4369684.2	402852.5	1168	3	O	25mm	-0.11	37.9	29.1	0.075	0.028	0.417
4369638.8	402835.7	867	3	O	25mm	-0.13	305.6	0.6	0.076	0.014	0.138
4369656.2	402844.1	1021	3	O	25mm	-0.16	171.7	169.8	0.076	0.015	0.237
4369689.4	402799.2	241	3	O	25mm	-0.16	294.8	21.9	0.077	0.020	0.111
4369659.1	402808.1	385	3	O	25mm	-0.14	39.3	193.3	0.077	0.024	0.124
4369665.0	402821.5	631	3	O	25mm	-0.07	293.2	13.0	0.077	0.010	0.074
4369664.2	402826.3	717	3	O	25mm	-0.09	278.0	159.8	0.077	0.014	0.140
4369679.8	402827.3	729	3	O	25mm	-0.10	173.2	5.9	0.077	0.015	0.173
4369663.1	402849.1	1109	3	O	25mm	-0.18	101.3	37.3	0.077	0.014	0.126
4369695.1	402795.1	194	3	O	25mm	-0.16	191.0	21.5	0.078	0.014	0.277
4369701.5	402802.2	278	3	O	25mm	-0.10	345.7	153.1	0.078	0.017	0.150
4369721.4	402804.3	316	3	O	25mm	-0.10	178.4	28.9	0.078	0.014	0.214
4369669.5	402821.7	628	3	O	25mm	-0.08	243.8	11.6	0.078	0.019	0.346
4369682.3	402845.3	1044	3	O	25mm	-0.08	50.2	32.9	0.078	0.015	0.245
4369671.0	402812.7	470	3	O	25mm	-0.05	288.9	1.1	0.079	0.016	0.156
4369656.9	402821.9	635	3	O	25mm	-0.10	294.0	-11.1	0.079	0.010	0.274
4369682.9	402829.1	759	3	O	25mm	-0.16	134.6	14.0	0.079	0.016	0.341
4369699.7	402830.1	775	3	O	25mm	-0.12	213.9	25.3	0.079	0.014	0.176
4369688.6	402833.8	833	3	O	25mm	-0.19	89.8	-18.3	0.079	0.020	0.143

APG Direct Fire Area

Northing, UTM 18N, meters	Easting, UTM 18N, meters	Anomaly Number	Disc. Stage/Rank 3 - Ord 2 - Clutter	Class O - Ord C - Clutter	Type	Depth (m)	Azimuth (Deg)	Inclination (Deg)	Length (m)	Radius (m)	MSE
4369663.4	402834.5	847	3	O	25mm	-0.20	63.3	153.7	0.079	0.021	0.307
4369648.0	402838.2	930	3	O	25mm	-0.59	100.0	8.0	0.079	0.025	0.353
4369658.9	402808.1	384	3	O	25mm	-0.18	39.8	17.1	0.080	0.025	0.223
4369671.4	402829.0	748	3	O	25mm	-0.14	244.0	36.6	0.080	0.023	0.167
4369669.3	402834.9	839	3	O	25mm	-0.16	8.4	14.5	0.080	0.014	0.484
4369650.7	402845.2	1040	3	O	25mm	-0.14	201.8	-5.6	0.080	0.013	0.296
4369665.8	402861.9	1289	3	O	25mm	-0.11	186.3	128.2	0.080	0.022	0.139
4369661.0	402830.3	779	3	O	25mm	-0.25	329.7	13.4	0.080	0.018	0.184
4369702.7	402809.5	415	3	O	25mm	-0.07	144.5	9.1	0.081	0.013	0.153
4369659.1	402823.7	646	3	O	25mm	-0.43	349.1	19.1	0.081	0.019	0.443
4369676.5	402823.9	671	3	O	25mm	-0.12	344.5	58.1	0.081	0.021	0.154
4369683.4	402825.7	699	3	O	25mm	-0.12	81.7	-0.1	0.081	0.016	0.440
4369686.6	402842.1	990	3	O	25mm	-0.11	190.8	-3.7	0.081	0.015	0.135
4369691.7	402851.2	1142	3	O	25mm	-0.13	52.6	-15.7	0.081	0.020	0.288
4369663.8	402827.9	741	3	O	25mm	-0.13	65.5	182.8	0.082	0.018	0.295
4369680.3	402832.0	796	3	O	25mm	-0.07	163.2	-32.2	0.082	0.018	0.149
4369662.9	402832.8	816	3	O	25mm	-0.06	322.7	-8.5	0.082	0.016	0.239
4369655.3	402844.2	1023	3	O	25mm	-0.08	174.6	-15.4	0.082	0.016	0.182
4369652.0	402848.7	1096	3	O	25mm	-0.27	101.7	44.7	0.082	0.017	0.173
4369681.1	402853.8	1191	3	O	25mm	-0.24	20.1	15.6	0.082	0.019	0.253
4369675.1	402863.0	1306	3	O	25mm	-0.24	308.2	157.2	0.082	0.022	0.341
4369685.2	402802.3	282	3	O	25mm	-0.13	214.6	-14.3	0.083	0.024	0.149
4369657.3	402823.4	662	3	O	25mm	-0.06	317.1	-2.6	0.083	0.026	0.304
4369694.4	402834.8	849	3	O	25mm	-0.01	130.5	-1.7	0.083	0.013	0.224
4369695.3	402836.3	878	3	O	25mm	-0.17	140.5	18.3	0.083	0.013	0.157
4369666.5	402840.1	950	3	O	25mm	-0.19	305.0	12.3	0.083	0.012	0.167
4369644.6	402844.0	1018	3	O	25mm	-0.07	312.1	-25.6	0.083	0.015	0.136
4369654.6	402851.6	1147	3	O	25mm	-0.08	287.0	-37.4	0.083	0.019	0.155
4369693.4	402855.6	1211	3	O	25mm	-0.17	116.4	-30.2	0.083	0.016	0.124
4369677.3	402841.1	965	3	O	25mm	-0.15	119.8	11.3	0.084	0.020	0.326
4369658.2	402845.4	1039	3	O	25mm	-0.11	168.2	41.1	0.084	0.019	0.144
4369674.7	402828.9	750	3	O	25mm	-0.20	356.7	-2.0	0.085	0.014	0.196
4369680.7	402845.1	1024	3	O	25mm	-0.06	182.1	-3.1	0.085	0.017	0.214

APG Direct Fire Area

Northing, UTM 18N, meters	Easting, UTM 18N, meters	Anomaly Number	Disc. Stage/Rank 3 - Ord 2 - Clutter	Class O - Ord C - Clutter	Type	Depth (m)	Azimuth (Deg)	Inclination (Deg)	Length (m)	Radius (m)	MSE
4369650.4	402854.6	1201	3	O	25mm	-0.11	271.7	-7.9	0.085	0.020	0.272
4369672.6	402858.8	1236	3	O	25mm	-0.09	115.2	27.3	0.085	0.020	0.290
4369673.4	402834.8	850	3	O	25mm	-0.12	335.4	173.0	0.085	0.015	0.299
4369669.3	402867.1	1344	3	O	25mm	-0.05	136.4	25.2	0.085	0.018	0.149
4369657.9	402807.2	370	3	O	25mm	-0.15	207.0	15.5	0.086	0.017	0.184
4369693.9	402819.2	591	3	O	25mm	-0.18	116.9	-30.4	0.086	0.015	0.349
4369677.0	402835.4	860	3	O	25mm	-0.11	154.2	14.3	0.086	0.015	0.349
4369682.5	402848.4	1092	3	O	25mm	-0.11	137.0	-11.9	0.086	0.019	0.119
4369651.8	402850.2	1121	3	O	25mm	-0.10	209.2	2.1	0.086	0.018	0.116
4369655.5	402832.3	812	3	O	25mm	-0.10	171.8	7.7	0.087	0.011	0.105
4369672.6	402858.8	1251	3	O	25mm	-0.11	115.4	28.4	0.087	0.020	0.411
4369663.5	402813.5	489	3	O	25mm	-0.16	299.3	163.7	0.088	0.019	0.178
4369710.8	402827.5	733	3	O	25mm	-0.14	93.7	-29.0	0.088	0.017	0.172
4369687.3	402852.5	1164	3	O	25mm	-0.17	274.3	26.7	0.088	0.015	0.237
4369694.9	402858.6	1252	3	O	25mm	-0.05	145.3	-1.6	0.088	0.016	0.131
4369716.0	402818.2	574	3	O	25mm	-0.27	38.7	24.1	0.088	0.018	0.261
4369681.5	402832.0	800	3	O	25mm	-0.15	163.8	155.8	0.089	0.019	0.551
4369710.6	402818.0	566	3	O	25mm	-0.61	78.6	0.9	0.089	0.015	0.513
4369666.0	402852.0	1155	3	O	25mm	-0.26	242.5	-34.3	0.089	0.021	0.204
4369658.8	402863.3	1307	3	O	25mm	-0.11	1.9	4.8	0.090	0.017	0.214
4369659.4	402834.0	843	3	O	25mm	-0.08	296.8	-8.7	0.091	0.014	0.183
4369690.4	402840.4	954	3	O	25mm	-0.16	103.5	22.6	0.091	0.016	0.156
4369646.0	402846.4	1063	3	O	25mm	-0.10	322.1	-23.4	0.091	0.015	0.137
4369662.8	402851.9	1151	3	O	25mm	-0.39	76.1	-6.8	0.091	0.016	0.216
4369698.4	402842.2	992	3	O	25mm	-0.06	134.1	5.1	0.092	0.014	0.180
4369691.9	402859.9	1270	3	O	25mm	-0.01	166.7	-6.7	0.092	0.011	0.086
4369684.9	402838.5	925	3	O	25mm	-0.18	99.3	15.9	0.093	0.014	0.169
4369662.9	402852.5	1152	3	O	25mm	-0.47	254.6	2.0	0.093	0.017	0.335
4369645.8	402854.2	1188	3	O	37mm	-0.19	291.2	0.3	0.050	0.019	0.433
4369648.4	402841.8	980	3	O	37mm	-0.15	154.6	-57.9	0.052	0.020	0.122
4369642.5	402848.3	1090	3	O	37mm	-0.15	191.4	168.3	0.052	0.019	0.208
4369694.2	402851.1	1141	3	O	37mm	-0.05	18.2	19.0	0.054	0.018	0.100
4369700.1	402823.5	665	3	O	37mm	-0.06	96.7	1.9	0.056	0.019	0.222

APG Direct Fire Area

Northing, UTM 18N, meters	Easting, UTM 18N, meters	Anomaly Number	Disc. Stage/Rank 3 - Ord 2 - Clutter	Class O - Ord C - Clutter	Type	Depth (m)	Azimuth (Deg)	Inclination (Deg)	Length (m)	Radius (m)	MSE
4369649.2	402854.1	1198	3	O	37mm	-0.18	171.9	4.0	0.057	0.020	0.226
4369692.8	402820.9	618	3	O	37mm	-0.18	41.4	33.5	0.058	0.020	0.354
4369719.1	402825.7	705	3	O	37mm	-0.19	35.2	-55.4	0.059	0.016	0.141
4369724.4	402829.1	760	3	O	37mm	-0.12	51.6	174.5	0.059	0.016	0.308
4369709.0	402833.0	820	3	O	37mm	-0.07	114.8	-25.6	0.059	0.017	0.214
4369655.6	402851.0	1138	3	O	37mm	-0.12	236.8	-5.3	0.059	0.017	0.206
4369670.0	402857.1	1235	3	O	37mm	-0.04	99.9	-0.3	0.059	0.022	0.183
4369656.9	402862.4	1298	3	O	37mm	-0.05	175.9	34.3	0.059	0.017	0.098
4369731.8	402816.0	534	3	O	37mm	-0.16	56.7	31.1	0.060	0.017	0.131
4369667.5	402836.7	886	3	O	37mm	-0.19	231.4	1.8	0.060	0.020	0.322
4369688.4	402853.5	1048	3	O	37mm	-0.13	42.5	157.3	0.060	0.019	0.091
4369644.2	402851.2	1143	3	O	37mm	0.00	320.4	6.7	0.060	0.019	0.355
4369697.6	402784.7	110	3	O	37mm	-0.10	355.2	-37.0	0.061	0.021	0.321
4369726.3	402804.9	327	3	O	37mm	-0.05	189.3	20.2	0.061	0.018	0.171
4369682.1	402810.3	427	3	O	37mm	-0.14	317.6	18.2	0.061	0.018	0.161
4369693.6	402812.3	463	3	O	37mm	-0.23	258.8	-15.9	0.061	0.015	0.127
4369685.2	402834.9	857	3	O	37mm	-0.04	34.7	20.1	0.061	0.018	0.072
4369689.2	402808.7	396	3	O	37mm	-0.16	258.4	0.7	0.062	0.015	0.290
4369678.6	402823.6	653	3	O	37mm	-0.17	212.1	188.9	0.062	0.020	0.179
4369710.8	402829.5	763	3	O	37mm	-0.18	37.6	-2.3	0.062	0.016	0.187
4369670.2	402816.9	550	3	O	37mm	-0.06	195.3	2.1	0.063	0.019	0.195
4369677.0	402819.5	593	3	O	37mm	-0.02	104.8	9.7	0.063	0.019	0.264
4369726.5	402820.1	606	3	O	37mm	-0.13	308.0	33.8	0.063	0.018	0.113
4369656.3	402856.9	1232	3	O	37mm	-0.04	135.1	-3.4	0.063	0.019	0.543
4369655.6	402859.7	1262	3	O	37mm	-0.03	105.7	4.3	0.063	0.019	0.093
4369704.9	402789.1	134	3	O	37mm	-0.13	324.9	-28.9	0.064	0.017	0.079
4369663.1	402808.8	393	3	O	37mm	-0.17	49.5	23.2	0.064	0.021	0.139
4369688.7	402810.1	417	3	O	37mm	-0.19	289.4	32.0	0.064	0.019	0.189
4369726.1	402818.7	577	3	O	37mm	-0.14	74.8	35.7	0.064	0.021	0.168
4369697.6	402828.8	749	3	O	37mm	-0.26	1.8	143.6	0.064	0.016	0.091
4369672.2	402839.2	929	3	O	37mm	-0.16	78.2	47.1	0.064	0.019	0.076
4369682.1	402850.4	1127	3	O	37mm	-0.12	195.9	50.9	0.064	0.016	0.156
4369692.8	402853.4	1187	3	O	37mm	-0.07	46.0	-21.2	0.064	0.017	0.086

APG Direct Fire Area

Northing, UTM 18N, meters	Easting, UTM 18N, meters	Anomaly Number	Disc. Stage/Rank 3 - Ord 2 - Clutter	Class O - Ord C - Clutter	Type	Depth (m)	Azimuth (Deg)	Inclination (Deg)	Length (m)	Radius (m)	MSE
4369666.3	402867.9	1351	3	O	37mm	-0.21	77.6	27.2	0.064	0.016	0.111
4369686.9	402791.2	154	3	O	37mm	-0.10	247.2	-6.8	0.065	0.018	0.098
4369689.3	402808.8	395	3	O	37mm	-0.17	284.4	9.6	0.065	0.017	0.195
4369665.5	402830.3	782	3	O	37mm	-0.10	260.8	19.0	0.065	0.017	0.160
4369672.6	402833.5	832	3	O	37mm	-0.08	90.4	176.0	0.065	0.019	0.085
4369664.4	402835.2	858	3	O	37mm	-0.14	203.7	-14.0	0.065	0.020	0.177
4369683.4	402859.6	1259	3	O	37mm	-0.10	177.3	17.8	0.065	0.015	0.575
4369721.3	402783.0	83	3	O	37mm	-0.24	338.2	2.3	0.066	0.018	0.517
4369699.9	402817.4	557	3	O	37mm	-0.13	282.4	61.8	0.066	0.017	0.152
4369691.5	402832.4	804	3	O	37mm	-0.10	185.8	44.7	0.066	0.022	0.167
4369686.5	402839.9	949	3	O	37mm	-0.08	329.2	182.1	0.066	0.018	0.160
4369670.4	402840.2	952	3	O	37mm	-0.09	300.5	22.4	0.066	0.019	0.074
4369663.3	402853.5	1184	3	O	37mm	-0.04	10.6	5.7	0.066	0.020	0.094
4369688.4	402787.9	126	3	O	37mm	-0.10	199.6	128.4	0.067	0.016	0.178
4369684.2	402800.2	255	3	O	37mm	-0.04	36.9	62.7	0.067	0.018	0.118
4369673.2	402845.6	1049	3	O	37mm	-0.14	342.6	160.5	0.067	0.022	0.096
4369660.5	402851.0	1135	3	O	37mm	-0.12	190.8	14.0	0.067	0.018	0.130
4369716.3	402814.8	510	3	O	37mm	-0.10	215.8	156.6	0.068	0.019	0.051
4369657.9	402819.3	592	3	O	37mm	-0.18	73.1	20.1	0.068	0.017	0.145
4369671.8	402825.3	694	3	O	37mm	-0.09	261.6	-18.4	0.068	0.019	0.088
4369670.2	402855.7	1214	3	O	37mm	-0.18	17.0	0.6	0.068	0.019	0.124
4369688.7	402856.3	1222	3	O	37mm	-0.14	144.4	21.3	0.068	0.017	0.089
4369661.5	402859.5	1267	3	O	37mm	-0.17	231.9	50.7	0.068	0.019	0.118
4369709.2	402805.4	338	3	O	37mm	-0.14	198.6	180.4	0.069	0.018	0.109
4369724.3	402827.1	724	3	O	37mm	-0.13	298.7	186.1	0.069	0.017	0.110
4369668.9	402830.4	780	3	O	37mm	-0.13	330.1	16.6	0.069	0.020	0.094
4369686.0	402832.7	806	3	O	37mm	-0.19	65.0	-37.6	0.069	0.017	0.303
4369640.2	402830.2	807	3	O	37mm	-0.08	118.1	175.1	0.069	0.018	0.171
4369693.9	402844.7	1031	3	O	37mm	-0.06	121.1	157.9	0.069	0.016	0.089
4369671.9	402844.9	1038	3	O	37mm	-0.07	121.1	157.9	0.069	0.016	0.089
4369687.1	402796.3	208	3	O	37mm	-0.08	211.7	34.5	0.070	0.016	0.086
4369701.4	402799.1	239	3	O	37mm	-0.09	340.8	14.4	0.070	0.018	0.078
4369669.2	402822.8	608	3	O	37mm	-0.08	268.8	22.8	0.070	0.019	0.081

APG Direct Fire Area

Northing, UTM 18N, meters	Easting, UTM 18N, meters	Anomaly Number	Disc. Stage/Rank 3 - Ord 2 - Clutter	Class O - Ord C - Clutter	Type	Depth (m)	Azimuth (Deg)	Inclination (Deg)	Length (m)	Radius (m)	MSE
4369682.4	402843.1	1007	3	O	37mm	-0.10	36.8	9.2	0.070	0.019	0.060
4369649.6	402845.4	1046	3	O	37mm	-0.07	159.2	2.8	0.070	0.019	0.142
4369672.3	402857.3	1240	3	O	37mm	-0.14	182.2	16.6	0.070	0.015	0.149
4369677.7	402881.8	1427	3	O	37mm	-0.16	110.2	27.3	0.070	0.014	0.183
4369697.6	402792.5	166	3	O	37mm	-0.19	150.3	25.8	0.071	0.017	0.124
4369690.1	402815.3	519	3	O	37mm	-0.17	27.8	18.8	0.071	0.018	0.121
4369702.6	402817.9	561	3	O	37mm	-0.21	130.2	-17.3	0.071	0.019	0.082
4369664.2	402824.0	666	3	O	37mm	-0.09	276.2	-0.1	0.071	0.016	0.454
4369643.2	402833.5	829	3	O	37mm	-0.08	21.9	164.1	0.071	0.015	0.134
4369645.7	402841.2	969	3	O	37mm	-0.09	284.0	-17.6	0.071	0.021	0.163
4369692.5	402848.4	1095	3	O	37mm	-0.06	244.1	33.0	0.071	0.017	0.053
4369697.0	402779.2	52	3	O	37mm	-0.23	179.0	6.4	0.072	0.015	0.344
4369683.6	402787.4	121	3	O	37mm	-0.11	196.5	4.8	0.072	0.019	0.107
4369674.8	402799.0	237	3	O	37mm	-0.15	310.4	-22.5	0.072	0.017	0.179
4369709.4	402810.0	420	3	O	37mm	-0.13	143.6	-36.5	0.072	0.016	0.088
4369663.3	402823.5	663	3	O	37mm	-0.11	272.1	-0.1	0.072	0.017	0.178
4369696.9	402825.0	689	3	O	37mm	-0.03	345.3	41.4	0.072	0.015	0.223
4369654.9	402842.0	987	3	O	37mm	-0.12	3.7	183.6	0.072	0.020	0.104
4369657.9	402846.6	1071	3	O	37mm	-0.06	73.0	158.2	0.072	0.016	0.068
4369660.8	402853.7	1190	3	O	37mm	-0.08	281.2	181.3	0.072	0.018	0.084
4369723.4	402799.9	254	3	O	37mm	-0.09	241.0	1.8	0.073	0.016	0.463
4369673.7	402843.0	1004	3	O	37mm	-0.06	189.5	150.2	0.073	0.018	0.220
4369666.4	402855.9	1215	3	O	37mm	-0.19	125.0	-7.9	0.073	0.018	0.172
4369705.7	402782.3	75	3	O	37mm	-0.12	72.8	10.3	0.074	0.019	0.066
4369718.2	402799.1	242	3	O	37mm	-0.22	191.1	-3.2	0.074	0.019	0.183
4369683.6	402804.8	323	3	O	37mm	-0.10	351.8	159.5	0.074	0.018	0.064
4369697.6	402817.3	554	3	O	37mm	-0.13	22.3	-9.8	0.074	0.016	0.156
4369707.0	402833.5	831	3	O	37mm	-0.12	29.7	157.4	0.074	0.017	0.081
4369692.6	402848.4	1025	3	O	37mm	-0.08	257.4	35.3	0.074	0.018	0.163
4369647.3	402846.5	1070	3	O	37mm	-0.17	84.4	156.7	0.074	0.018	0.112
4369644.9	402853.6	1189	3	O	37mm	-0.10	332.4	-7.0	0.074	0.015	0.204
4369681.3	402854.1	1199	3	O	37mm	-0.34	181.3	11.8	0.074	0.020	0.317
4369660.1	402855.8	1219	3	O	37mm	-0.21	276.1	12.3	0.074	0.018	0.121

APG Direct Fire Area

Northing, UTM 18N, meters	Easting, UTM 18N, meters	Anomaly Number	Disc. Stage/Rank 3 - Ord 2 - Clutter	Class O - Ord C - Clutter	Type	Depth (m)	Azimuth (Deg)	Inclination (Deg)	Length (m)	Radius (m)	MSE
4369674.1	402859.4	1265	3	O	37mm	-0.18	130.7	13.7	0.074	0.018	0.126
4369688.1	402783.0	81	3	O	37mm	-0.13	82.9	174.2	0.075	0.016	0.074
4369711.1	402792.5	167	3	O	37mm	-0.13	85.9	182.9	0.075	0.020	0.096
4369720.3	402807.5	379	3	O	37mm	-0.12	41.1	0.6	0.075	0.020	0.087
4369713.0	402811.1	441	3	O	37mm	-0.15	248.1	182.6	0.075	0.019	0.103
4369686.4	402837.3	897	3	O	37mm	-0.15	117.2	-21.3	0.075	0.021	0.105
4369678.4	402848.2	1087	3	O	37mm	-0.15	18.6	72.2	0.075	0.018	0.123
4369707.4	402849.5	1114	3	O	37mm	-0.19	82.2	0.7	0.075	0.019	0.328
4369681.7	402854.8	1218	3	O	37mm	-0.44	249.8	0.6	0.075	0.018	0.284
4369666.3	402858.4	1247	3	O	37mm	-0.17	96.7	15.8	0.075	0.020	0.089
4369671.9	402863.0	1303	3	O	37mm	-0.30	178.0	-9.0	0.075	0.023	0.382
4369657.6	402827.2	727	3	O	37mm	-0.05	331.1	15.7	0.076	0.016	0.218
4369646.7	402844.6	1028	3	O	37mm	-0.11	76.6	53.8	0.076	0.016	0.155
4369657.1	402849.3	1111	3	O	37mm	-0.15	343.7	128.6	0.076	0.020	0.121
4369708.3	402835.8	870	3	O	37mm	-0.10	95.4	-34.3	0.077	0.018	0.151
4369653.2	402853.2	1180	3	O	37mm	-0.07	1.7	21.3	0.077	0.017	0.175
4369667.2	402857.4	1239	3	O	37mm	-0.06	101.0	19.4	0.077	0.017	0.119
4369658.3	402857.8	1245	3	O	37mm	-0.16	359.8	-8.6	0.077	0.017	0.094
4369670.1	402834.9	842	3	O	37mm	-0.15	158.7	9.5	0.078	0.016	0.268
4369649.7	402841.0	966	3	O	37mm	-0.20	323.0	23.6	0.078	0.017	0.165
4369657.2	402853.4	1181	3	O	37mm	-0.11	295.2	44.2	0.079	0.016	0.152

APG Indirect Fire Area

ALLTEM APG 2010 Inirect Fire Area, ver.2											
Northing, UTM 18N, meters	Easting, UTM 18N, meters	Anomaly Number	Disc. Stage/Rank 3 - Ord 2 - Clutter	Class O - Ord C - Clutter	Type	Depth (m)	Azimuth (Deg)	Inclination (Deg)	Length (m)	Radius (m)	MSE
4369451.4	402790.4	2503	2	C	Clutter	-0.02	199.9	116.0	0.012	0.005	0.843
4369433.9	402725.4	536	2	C	Clutter	-0.17	260.6	62.6	0.013	0.003	0.991
4369476.3	402725.9	596	2	C	Clutter	0.00	257.1	19.5	0.013	0.013	0.972
4369487.9	402783.5	2344	2	C	Clutter	-0.04	193.0	21.7	0.013	0.012	0.748
4369457.6	402705.4	125	2	C	Clutter	-0.01	62.7	-18.4	0.014	0.009	0.787
4369460.3	402761.8	1682	2	C	Clutter	0.00	269.7	-1.5	0.014	0.010	0.723
4369417.6	402769.9	1948	2	C	Clutter	-0.01	299.1	-11.4	0.015	0.008	0.879
4369488.5	402772.9	2040	2	C	Clutter	-0.02	163.2	71.0	0.015	0.006	0.856
4369502.5	402701.9	69	2	C	Clutter	0.00	155.5	19.3	0.016	0.016	0.402
4369485.6	402740.4	999	2	C	Clutter	-0.12	276.4	5.0	0.017	0.017	0.549
4369472.6	402804.7	2803	2	C	Clutter	0.00	99.7	-2.4	0.017	0.009	0.792
4369485.4	402810.5	2884	2	C	Clutter	-0.12	288.0	72.8	0.017	0.011	0.604
4369529.1	402717.3	339	2	C	Clutter	-0.02	245.2	68.8	0.018	0.004	0.816
4369431.8	402732.1	729	2	C	Clutter	-0.06	332.0	64.0	0.018	0.016	0.598
4369530.4	402734.7	827	2	C	Clutter	-0.03	127.2	8.8	0.018	0.009	0.636
4369433.8	402773.3	2048	2	C	Clutter	-0.06	12.1	-36.0	0.018	0.007	0.933
4369505.9	402733.9	787	2	C	Clutter	-0.11	19.4	17.1	0.019	0.010	0.793
4369454.0	402747.9	1227	2	C	Clutter	-0.11	18.2	47.2	0.019	0.017	0.961
4369459.8	402700.2	44	2	C	Clutter	-0.02	77.8	69.4	0.020	0.017	0.122
4369472.6	402731.7	751	2	C	Clutter	0.00	83.7	-21.0	0.020	0.002	0.999
4369461.7	402814.4	2944	2	C	Clutter	-0.10	24.3	2.8	0.020	0.013	0.568
4369467.8	402736.2	856	2	C	Clutter	-0.13	168.0	46.7	0.021	0.006	0.945
4369466.9	402748.8	1277	2	C	Clutter	-0.01	345.1	-0.4	0.021	0.007	0.634
4369409.8	402766.1	1823	2	C	Clutter	-0.03	172.8	-62.2	0.021	0.014	0.286
4369423.2	402767.4	1866	2	C	Clutter	-0.02	329.6	40.8	0.021	0.007	0.892
4369460.6	402779.8	2240	2	C	Clutter	-0.06	134.8	58.1	0.021	0.017	0.304
4369465.0	402787.3	2441	2	C	Clutter	0.00	344.6	2.9	0.021	0.013	0.850
4369471.8	402808.3	2855	2	C	Clutter	-0.12	93.6	38.2	0.021	0.015	0.306
4369451.6	402711.6	233	2	C	Clutter	-0.07	267.5	25.8	0.022	0.011	0.586
4369445.5	402713.3	251	2	C	Clutter	-0.27	257.8	61.2	0.022	0.020	0.443
4369500.6	402735.4	835	2	C	Clutter	-0.11	29.6	-6.6	0.022	0.009	0.886
4369501.2	402736.0	863	2	C	Clutter	-0.12	319.7	104.9	0.022	0.013	0.393

APG Indirect Fire Area

Northing, UTM 18N, meters	Easting, UTM 18N, meters	Anomaly Number	Disc. Stage/Rank 3 - Ord 2 - Clutter	Class O - Ord C - Clutter	Type	Depth (m)	Azimuth (Deg)	Inclination (Deg)	Length (m)	Radius (m)	MSE
4369417.1	402768.1	1901	2	C	Clutter	-0.06	304.1	42.2	0.022	0.015	0.275
4369438.3	402768.6	1904	2	C	Clutter	-0.02	305.5	37.4	0.022	0.006	0.537
4369509.9	402723.7	497	2	C	Clutter	-0.15	215.2	28.7	0.023	0.015	0.682
4369435.0	402725.7	560	2	C	Clutter	-0.10	298.7	-21.2	0.023	0.012	0.638
4369424.1	402733.7	781	2	C	Clutter	-0.03	285.3	57.2	0.023	0.006	0.409
4369542.1	402739.8	989	2	C	Clutter	-0.06	130.4	-0.9	0.023	0.014	0.400
4369441.0	402764.9	1779	2	C	Clutter	-0.04	243.8	3.2	0.023	0.010	0.538
4369428.8	402770.3	1950	2	C	Clutter	-0.01	85.1	16.3	0.023	0.005	0.637
4369414.1	402792.1	2551	2	C	Clutter	-0.08	25.6	38.7	0.023	0.019	0.279
4369468.5	402817.9	2989	2	C	Clutter	-0.11	89.4	80.3	0.023	0.005	0.776
4369464.5	402828.8	3070	2	C	Clutter	-0.08	137.5	5.0	0.023	0.014	0.510
4369535.3	402724.4	520	2	C	Clutter	-0.07	132.8	34.6	0.024	0.011	0.720
4369496.0	402732.1	743	2	C	Clutter	-0.13	199.0	-8.3	0.024	0.014	0.686
4369496.0	402734.6	813	2	C	Clutter	-0.08	326.9	74.0	0.024	0.008	0.449
4369450.9	402735.0	838	2	C	Clutter	-0.03	244.9	13.7	0.024	0.005	0.943
4369444.9	402737.3	900	2	C	Clutter	0.00	211.7	-54.1	0.024	0.009	0.565
4369462.6	402742.4	1069	2	C	Clutter	-0.11	346.7	20.6	0.024	0.012	0.558
4369420.0	402743.9	1120	2	C	Clutter	-0.07	333.7	48.8	0.024	0.015	0.182
4369418.4	402750.3	1340	2	C	Clutter	-0.12	271.9	-20.8	0.024	0.011	0.824
4369398.9	402759.0	1613	2	C	Clutter	-0.10	286.1	-27.7	0.024	0.013	0.353
4369426.6	402760.1	1620	2	C	Clutter	-0.03	211.7	22.9	0.024	0.012	0.279
4369419.1	402768.2	1848	2	C	Clutter	-0.06	153.4	38.5	0.024	0.004	0.815
4369433.8	402769.8	1947	2	C	Clutter	-0.10	171.7	135.1	0.024	0.011	0.536
4369434.2	402783.0	2322	2	C	Clutter	-0.07	12.2	5.1	0.024	0.011	0.684
4369421.6	402735.7	840	2	C	Clutter	-0.09	33.1	-9.8	0.025	0.009	0.676
4369447.9	402735.4	850	2	C	Clutter	-0.02	331.6	3.7	0.025	0.007	0.724
4369467.8	402769.4	1929	2	C	Clutter	-0.08	266.9	66.3	0.025	0.008	0.463
4369464.9	402794.0	2593	2	C	Clutter	-0.21	290.4	76.8	0.025	0.021	0.314
4369445.8	402809.4	2860	2	C	Clutter	0.00	43.4	-6.8	0.025	0.007	0.726
4369452.5	402812.8	2921	2	C	Clutter	-0.09	156.5	53.9	0.025	0.012	0.410
4369452.9	402819.0	2998	2	C	Clutter	-0.12	65.0	-16.7	0.025	0.015	0.473
4369459.6	402704.9	115	2	C	Clutter	-0.03	230.7	21.2	0.026	0.011	0.905
4369523.7	402716.1	314	2	C	Clutter	-0.12	173.0	13.4	0.026	0.008	0.833

APG Indirect Fire Area

Northing, UTM 18N, meters	Easting, UTM 18N, meters	Anomaly Number	Disc. Stage/Rank 3 - Ord 2 - Clutter	Class O - Ord C - Clutter	Type	Depth (m)	Azimuth (Deg)	Inclination (Deg)	Length (m)	Radius (m)	MSE
4369475.8	402730.3	685	2	C	Clutter	-0.07	91.4	-55.5	0.026	0.020	0.275
4369460.7	402737.5	916	2	C	Clutter	-0.01	119.7	-6.6	0.026	0.004	0.756
4369484.4	402738.0	942	2	C	Clutter	0.00	287.7	2.4	0.026	0.004	0.705
4369461.1	402740.3	991	2	C	Clutter	-0.13	138.9	1.5	0.026	0.015	0.424
4369462.5	402746.1	1195	2	C	Clutter	0.00	175.5	4.2	0.026	0.017	0.127
4369401.6	402766.9	1834	2	C	Clutter	-0.16	329.0	5.3	0.026	0.018	0.463
4369457.1	402783.6	2323	2	C	Clutter	-0.13	17.9	70.0	0.026	0.012	0.323
4369422.2	402788.8	2474	2	C	Clutter	-0.06	95.6	-47.5	0.026	0.019	0.163
4369461.6	402794.9	2613	2	C	Clutter	0.00	159.6	27.5	0.026	0.006	0.381
4369463.5	402800.1	2710	2	C	Clutter	-0.20	93.5	48.3	0.026	0.011	0.711
4369460.9	402817.9	2985	2	C	Clutter	-0.12	197.4	131.3	0.026	0.014	0.237
4369460.1	402819.3	2999	2	C	Clutter	-0.05	120.0	-6.8	0.026	0.010	0.591
4369459.8	402823.4	3035	2	C	Clutter	-0.09	17.0	10.2	0.026	0.013	0.562
4369444.8	402709.9	191	2	C	Clutter	-0.08	262.2	-20.4	0.027	0.012	0.339
4369523.4	402727.1	588	2	C	Clutter	-0.11	106.6	-60.6	0.027	0.005	0.585
4369513.6	402735.7	854	2	C	Clutter	-0.13	76.7	27.7	0.027	0.006	0.874
4369496.3	402743.7	1100	2	C	Clutter	-0.03	271.4	-9.0	0.027	0.006	0.660
4369402.5	402763.1	1728	2	C	Clutter	-0.16	245.4	1.8	0.027	0.012	0.705
4369446.1	402764.3	1775	2	C	Clutter	-0.02	225.7	21.1	0.027	0.009	0.333
4369411.7	402767.7	1874	2	C	Clutter	-0.07	71.1	-2.5	0.027	0.011	0.502
4369504.1	402775.9	1909	2	C	Clutter	-0.07	82.3	5.0	0.027	0.020	0.108
4369463.4	402771.7	1989	2	C	Clutter	-0.01	213.4	-0.2	0.027	0.003	0.594
4369481.9	402791.0	2521	2	C	Clutter	-0.10	55.9	98.8	0.027	0.016	0.181
4369471.1	402796.9	2653	2	C	Clutter	-0.01	48.5	0.9	0.027	0.009	0.540
4369432.5	402742.4	1062	2	C	Clutter	-0.04	142.8	40.7	0.028	0.019	0.142
4369491.0	402745.2	1162	2	C	Clutter	-0.11	292.8	-27.9	0.028	0.008	0.740
4369525.1	402760.0	1645	2	C	Clutter	-0.07	145.3	-18.2	0.028	0.016	0.190
4369393.7	402763.9	1762	2	C	Clutter	0.17	47.2	16.6	0.028	0.017	0.337
4369444.3	402766.1	1825	2	C	Clutter	-0.12	53.4	17.4	0.028	0.012	0.675
4369414.3	402770.5	1952	2	C	Clutter	-0.19	19.3	1.5	0.028	0.013	0.769
4369410.7	402770.6	1965	2	C	Clutter	-0.02	167.3	8.4	0.028	0.016	0.225
4369467.7	402790.7	2511	2	C	Clutter	-0.17	187.8	86.8	0.028	0.016	0.525
4369480.1	402803.9	2793	2	C	Clutter	-0.11	84.7	-2.5	0.028	0.016	0.361

APG Indirect Fire Area

Northing, UTM 18N, meters	Easting, UTM 18N, meters	Anomaly Number	Disc. Stage/Rank 3 - Ord 2 - Clutter	Class O - Ord C - Clutter	Type	Depth (m)	Azimuth (Deg)	Inclination (Deg)	Length (m)	Radius (m)	MSE
4369457.6	402806.0	2818	2	C	Clutter	-0.10	85.6	-7.8	0.028	0.013	0.382
4369453.4	402809.6	2874	2	C	Clutter	-0.04	46.7	11.0	0.028	0.012	0.527
4369474.7	402822.5	3026	2	C	Clutter	0.00	316.1	20.6	0.028	0.010	0.656
4369468.7	402701.0	52	2	C	Clutter	-0.01	84.1	-22.8	0.029	0.009	0.199
4369532.9	402730.0	676	2	C	Clutter	-0.23	221.7	72.7	0.029	0.012	0.504
4369525.4	402742.8	1074	2	C	Clutter	-0.10	39.2	6.6	0.029	0.011	0.429
4369535.2	402752.2	1391	2	C	Clutter	-0.11	82.9	27.5	0.029	0.011	0.611
4369460.0	402753.4	1425	2	C	Clutter	-0.02	154.2	17.0	0.029	0.005	0.611
4369511.5	402770.3	1951	2	C	Clutter	-0.14	122.7	6.0	0.029	0.012	0.799
4369472.6	402798.3	2678	2	C	Clutter	-0.08	145.0	25.4	0.029	0.013	0.408
4369449.5	402811.2	2897	2	C	Clutter	-0.04	328.7	78.1	0.029	0.013	0.443
4369474.0	402812.4	2923	2	C	Clutter	-0.24	177.6	-6.1	0.029	0.029	0.489
4369455.7	402820.6	3010	2	C	Clutter	-0.14	141.3	-2.2	0.029	0.016	0.385
4369453.8	402820.6	3013	2	C	Clutter	-0.17	35.8	-6.0	0.029	0.016	0.522
4369464.5	402826.7	3050	2	C	Clutter	-0.13	77.0	11.7	0.029	0.011	0.541
4369458.1	402825.2	3053	2	C	Clutter	-0.16	137.2	-7.6	0.029	0.014	0.654
4369495.5	402705.6	130	2	C	Clutter	-0.02	217.6	48.8	0.030	0.006	0.190
4369472.0	402713.4	268	2	C	Clutter	-0.22	209.4	3.0	0.030	0.015	0.805
4369429.9	402726.7	574	2	C	Clutter	-0.12	268.1	-14.9	0.030	0.011	0.408
4369418.8	402762.0	1701	2	C	Clutter	-0.06	56.3	-0.1	0.030	0.015	0.195
4369485.7	402768.5	1899	2	C	Clutter	-0.08	131.1	-20.7	0.030	0.012	0.295
4369395.4	402772.0	2013	2	C	Clutter	-0.13	287.7	-2.9	0.030	0.016	0.393
4369415.6	402775.6	2117	2	C	Clutter	-0.02	48.2	34.9	0.030	0.004	0.945
4369489.2	402794.1	2606	2	C	Clutter	-0.10	91.7	46.2	0.030	0.015	0.292
4369488.8	402799.5	2708	2	C	Clutter	-0.11	20.5	7.6	0.030	0.011	0.567
4369430.5	402803.9	2767	2	C	Clutter	-0.25	318.6	-8.2	0.030	0.021	0.394
4369432.8	402803.9	2788	2	C	Clutter	-0.06	298.4	2.5	0.030	0.010	0.463
4369468.3	402703.4	97	2	C	Clutter	-0.01	144.5	7.9	0.031	0.006	0.952
4369525.1	402711.6	235	2	C	Clutter	-0.03	6.1	99.3	0.031	0.003	0.336
4369452.3	402713.3	267	2	C	Clutter	-0.30	274.9	-11.0	0.031	0.016	0.893
4369450.3	402731.5	717	2	C	Clutter	-0.22	257.6	-3.0	0.031	0.011	0.909
4369454.3	402733.1	767	2	C	Clutter	-0.23	160.4	-13.1	0.031	0.011	0.854
4369516.0	402743.7	1110	2	C	Clutter	-0.04	148.2	14.2	0.031	0.017	0.112

APG Indirect Fire Area

Northing, UTM 18N, meters	Easting, UTM 18N, meters	Anomaly Number	Disc. Stage/Rank 3 - Ord 2 - Clutter	Class O - Ord C - Clutter	Type	Depth (m)	Azimuth (Deg)	Inclination (Deg)	Length (m)	Radius (m)	MSE
4369409.6	402756.8	1529	2	C	Clutter	-0.01	303.7	12.9	0.031	0.006	0.577
4369474.4	402761.5	1683	2	C	Clutter	-0.08	304.4	19.1	0.031	0.015	0.245
4369423.8	402762.6	1723	2	C	Clutter	-0.07	42.8	4.2	0.031	0.021	0.128
4369508.1	402767.9	1876	2	C	Clutter	-0.10	126.5	15.1	0.031	0.019	0.205
4369524.7	402768.1	1889	2	C	Clutter	-0.20	321.6	9.1	0.031	0.011	0.653
4369473.2	402792.5	2559	2	C	Clutter	-0.02	15.5	-14.2	0.031	0.010	0.625
4369471.7	402736.6	877	2	C	Clutter	-0.09	225.0	108.7	0.032	0.018	0.341
4369428.0	402744.9	1153	2	C	Clutter	-0.17	50.4	68.5	0.032	0.014	0.152
4369458.5	402745.5	1172	2	C	Clutter	-0.05	205.2	19.7	0.032	0.010	0.346
4369482.6	402751.9	1385	2	C	Clutter	-0.12	258.8	45.8	0.032	0.022	0.220
4369402.8	402758.4	1574	2	C	Clutter	-0.24	315.7	-4.8	0.032	0.014	0.592
4369512.1	402768.9	1898	2	C	Clutter	-0.22	118.0	-3.0	0.032	0.011	0.930
4369411.8	402769.6	1932	2	C	Clutter	-0.16	244.5	15.6	0.032	0.016	0.474
4369443.8	402783.7	2343	2	C	Clutter	-0.07	328.7	15.6	0.032	0.019	0.147
4369470.2	402789.5	2484	2	C	Clutter	-0.13	139.3	12.3	0.032	0.011	0.492
4369478.8	402808.8	2856	2	C	Clutter	-0.24	231.8	1.3	0.032	0.014	0.847
4369456.7	402813.5	2930	2	C	Clutter	-0.08	54.7	2.6	0.032	0.014	0.207
4369470.5	402826.2	3052	2	C	Clutter	0.00	130.2	-4.2	0.032	0.006	0.744
4369483.1	402721.4	443	2	C	Clutter	-0.12	99.9	7.5	0.033	0.008	0.873
4369462.5	402722.9	476	2	C	Clutter	-0.09	330.4	22.3	0.033	0.005	0.643
4369525.2	402722.6	481	2	C	Clutter	-0.20	127.7	7.3	0.033	0.012	0.811
4369485.2	402727.9	618	2	C	Clutter	-0.26	343.8	12.4	0.033	0.018	0.573
4369487.2	402732.5	757	2	C	Clutter	-0.16	314.3	15.7	0.033	0.009	0.568
4369476.7	402780.7	2256	2	C	Clutter	-0.14	194.7	-15.5	0.033	0.014	0.620
4369435.2	402782.0	2311	2	C	Clutter	-0.15	231.7	3.2	0.033	0.010	0.697
4369414.5	402785.3	2365	2	C	Clutter	-0.32	87.3	0.5	0.033	0.016	0.887
4369417.3	402785.4	2386	2	C	Clutter	-0.26	57.1	-1.4	0.033	0.013	0.846
4369423.7	402791.5	2537	2	C	Clutter	-0.07	138.7	1.0	0.033	0.015	0.683
4369453.5	402793.8	2587	2	C	Clutter	-0.12	15.8	8.0	0.033	0.011	0.426
4369500.9	402708.2	164	2	C	Clutter	-0.08	289.7	-20.7	0.034	0.013	0.230
4369433.1	402739.0	964	2	C	Clutter	-0.23	92.5	-10.5	0.034	0.020	0.275
4369460.9	402805.2	2800	2	C	Clutter	-0.21	11.5	29.3	0.034	0.009	0.578
4369450.5	402810.9	2880	2	C	Clutter	-0.20	116.6	-3.2	0.034	0.013	0.677

APG Indirect Fire Area

Northing, UTM 18N, meters	Easting, UTM 18N, meters	Anomaly Number	Disc. Stage/Rank 3 - Ord 2 - Clutter	Class O - Ord C - Clutter	Type	Depth (m)	Azimuth (Deg)	Inclination (Deg)	Length (m)	Radius (m)	MSE
4369443.9	402812.6	2918	2	C	Clutter	-0.07	201.5	-2.9	0.034	0.011	0.365
4369448.6	402813.0	2929	2	C	Clutter	-0.19	65.2	6.7	0.034	0.017	0.709
4369479.3	402817.5	2984	2	C	Clutter	-0.26	234.6	5.5	0.034	0.019	0.499
4369465.8	402824.1	3034	2	C	Clutter	-0.12	39.8	13.0	0.034	0.014	0.332
4369461.7	402833.6	3089	2	C	Clutter	-0.08	131.8	23.7	0.034	0.009	0.405
4369490.9	402690.8	5	2	C	Clutter	-0.11	206.4	3.3	0.035	0.021	0.158
4369486.4	402716.8	334	2	C	Clutter	-0.02	59.3	-2.8	0.035	0.009	0.908
4369524.4	402724.2	508	2	C	Clutter	-0.03	90.8	38.2	0.035	0.011	0.908
4369446.5	402738.2	943	2	C	Clutter	-0.09	194.3	-32.6	0.035	0.009	0.299
4369526.1	402744.9	1155	2	C	Clutter	-0.11	94.1	-2.5	0.035	0.019	0.161
4369456.4	402746.9	1237	2	C	Clutter	-0.26	270.5	-5.7	0.035	0.020	0.564
4369442.1	402758.9	1605	2	C	Clutter	-0.06	121.3	56.3	0.035	0.013	0.206
4369449.9	402773.8	2070	2	C	Clutter	-0.11	340.9	10.6	0.035	0.009	0.423
4369412.9	402776.2	2136	2	C	Clutter	-0.19	297.2	-1.2	0.035	0.019	0.615
4369462.5	402811.0	2894	2	C	Clutter	-0.11	99.5	3.8	0.035	0.010	0.525
4369474.0	402816.2	2968	2	C	Clutter	-0.10	105.1	-14.3	0.035	0.019	0.175
4369453.8	402816.6	2972	2	C	Clutter	-0.11	262.8	-2.6	0.035	0.014	0.464
4369449.7	402819.6	3003	2	C	Clutter	-0.03	70.5	4.3	0.035	0.010	0.513
4369461.9	402819.4	3005	2	C	Clutter	-0.09	147.5	3.2	0.035	0.021	0.110
4369469.1	402810.9	3007	2	C	Clutter	-0.17	17.6	1.4	0.035	0.019	0.337
4369514.1	402720.7	428	2	C	Clutter	-0.21	194.9	5.8	0.036	0.017	0.398
4369480.2	402722.3	474	2	C	Clutter	-0.33	359.5	4.7	0.036	0.020	0.595
4369433.8	402727.0	610	2	C	Clutter	-0.09	277.0	42.8	0.036	0.002	0.465
4369431.1	402738.0	888	2	C	Clutter	-0.31	37.7	-17.1	0.036	0.013	0.958
4369456.6	402756.1	1515	2	C	Clutter	-0.07	35.1	148.5	0.036	0.010	0.187
4369407.5	402776.2	2127	2	C	Clutter	-0.34	184.5	3.1	0.036	0.021	0.405
4369488.3	402777.4	2169	2	C	Clutter	-0.08	44.2	-13.9	0.036	0.008	0.220
4369494.3	402791.8	2548	2	C	Clutter	-0.05	353.8	28.4	0.036	0.026	0.128
4369431.9	402808.3	2847	2	C	Clutter	-0.23	259.3	-8.8	0.036	0.018	0.364
4369488.0	402725.9	548	2	C	Clutter	-0.28	354.1	-1.5	0.037	0.016	0.654
4369505.1	402735.8	864	2	C	Clutter	-0.06	41.9	-7.0	0.037	0.009	0.958
4369428.6	402741.7	1035	2	C	Clutter	-0.13	190.0	-6.3	0.037	0.011	0.427
4369522.8	402744.6	1099	2	C	Clutter	-0.02	126.2	-5.8	0.037	0.003	0.387

APG Indirect Fire Area

Northing, UTM 18N, meters	Easting, UTM 18N, meters	Anomaly Number	Disc. Stage/Rank 3 - Ord 2 - Clutter	Class O - Ord C - Clutter	Type	Depth (m)	Azimuth (Deg)	Inclination (Deg)	Length (m)	Radius (m)	MSE
4369408.8	402755.9	1528	2	C	Clutter	-0.33	332.5	-22.6	0.037	0.020	0.489
4369398.5	402768.5	1919	2	C	Clutter	-0.16	238.8	8.7	0.037	0.013	0.329
4369412.2	402779.0	2220	2	C	Clutter	-0.05	277.1	4.5	0.037	0.020	0.212
4369497.9	402788.8	2472	2	C	Clutter	-0.07	112.5	11.2	0.037	0.019	0.177
4369461.0	402816.1	2961	2	C	Clutter	-0.05	71.0	7.0	0.037	0.007	0.284
4369458.8	402815.7	2965	2	C	Clutter	-0.09	31.6	8.5	0.037	0.023	0.211
4369454.6	402819.8	3006	2	C	Clutter	-0.22	107.8	-9.0	0.037	0.018	0.406
4369454.6	402821.6	3018	2	C	Clutter	-0.22	242.3	-5.5	0.037	0.015	0.650
4369466.2	402826.4	3054	2	C	Clutter	-0.04	38.3	31.6	0.037	0.006	0.067
4369436.1	402723.1	486	2	C	Clutter	-0.20	219.6	24.0	0.038	0.015	0.183
4369438.1	402737.3	906	2	C	Clutter	-0.11	257.2	29.7	0.038	0.010	0.241
4369454.7	402767.1	1851	2	C	Clutter	-0.12	282.8	11.7	0.038	0.010	0.303
4369520.4	402769.5	1930	2	C	Clutter	-0.20	69.7	89.0	0.038	0.018	0.350
4369404.4	402774.5	2079	2	C	Clutter	-0.32	132.5	-3.2	0.038	0.022	0.528
4369479.5	402778.3	2197	2	C	Clutter	-0.12	77.3	3.0	0.038	0.018	0.290
4369413.3	402782.2	2299	2	C	Clutter	-0.21	184.3	-1.3	0.038	0.015	0.505
4369494.9	402794.9	2615	2	C	Clutter	-0.12	218.8	14.2	0.038	0.016	0.130
4369446.8	402815.6	2952	2	C	Clutter	-0.28	178.2	3.5	0.038	0.018	0.552
4369480.3	402716.0	308	2	C	Clutter	-0.27	310.5	-1.9	0.039	0.021	0.271
4369454.2	402715.7	325	2	C	Clutter	-0.17	52.8	-14.3	0.039	0.007	0.524
4369475.0	402716.8	328	2	C	Clutter	-0.32	190.5	1.6	0.039	0.021	0.493
4369504.3	402728.2	600	2	C	Clutter	-0.12	236.6	13.8	0.039	0.015	0.094
4369441.9	402734.7	823	2	C	Clutter	-0.16	193.1	0.2	0.039	0.012	0.526
4369466.2	402737.5	909	2	C	Clutter	-0.10	37.1	27.1	0.039	0.004	0.486
4369441.4	402777.4	2164	2	C	Clutter	-0.10	242.5	-12.4	0.039	0.006	0.415
4369426.4	402793.4	2574	2	C	Clutter	-0.11	274.6	7.3	0.039	0.023	0.142
4369458.3	402797.3	2663	2	C	Clutter	-0.02	163.0	49.4	0.039	0.022	0.111
4369470.3	402815.5	3016	2	C	Clutter	-0.14	32.2	14.3	0.039	0.020	0.207
4369432.8	402730.4	687	2	C	Clutter	-0.11	2.3	22.9	0.040	0.010	0.205
4369413.4	402755.7	1512	2	C	Clutter	-0.05	180.6	6.2	0.040	0.011	0.212
4369408.3	402759.8	1635	2	C	Clutter	-0.10	276.6	12.1	0.040	0.007	0.404
4369424.6	402765.0	1796	2	C	Clutter	-0.12	279.5	-3.5	0.040	0.013	0.344
4369392.8	402765.9	1807	2	C	Clutter	-0.35	308.6	-0.2	0.040	0.022	0.423

APG Indirect Fire Area

Northing, UTM 18N, meters	Easting, UTM 18N, meters	Anomaly Number	Disc. Stage/Rank 3 - Ord 2 - Clutter	Class O - Ord C - Clutter	Type	Depth (m)	Azimuth (Deg)	Inclination (Deg)	Length (m)	Radius (m)	MSE
4369421.0	402768.3	1871	2	C	Clutter	-0.02	243.3	15.2	0.040	0.004	0.884
4369435.8	402787.6	2444	2	C	Clutter	-0.21	311.1	-30.3	0.040	0.025	0.379
4369452.8	402795.5	2627	2	C	Clutter	-0.07	300.0	16.8	0.040	0.017	0.255
4369418.8	402795.6	2640	2	C	Clutter	-0.34	244.9	-7.2	0.040	0.022	0.381
4369438.2	402797.9	2672	2	C	Clutter	-0.22	351.9	-18.8	0.040	0.030	0.122
4369458.1	402799.8	2714	2	C	Clutter	-0.17	55.1	-17.1	0.040	0.016	0.251
4369450.8	402817.3	2982	2	C	Clutter	-0.10	58.9	-3.6	0.040	0.012	0.326
4369453.4	402823.1	3032	2	C	Clutter	-0.22	81.2	1.1	0.040	0.016	0.641
4369444.5	402739.7	985	2	C	Clutter	-0.11	322.9	12.0	0.041	0.020	0.075
4369475.0	402750.0	1325	2	C	Clutter	-0.18	247.2	128.8	0.041	0.009	0.124
4369435.6	402758.6	1597	2	C	Clutter	-0.12	277.0	-4.5	0.041	0.009	0.591
4369480.4	402764.9	1784	2	C	Clutter	-0.02	139.1	117.2	0.041	0.017	0.196
4369516.5	402774.3	2085	2	C	Clutter	0.00	153.7	-2.5	0.041	0.010	0.284
4369458.5	402779.1	2225	2	C	Clutter	-0.11	191.9	10.7	0.041	0.014	0.276
4369479.4	402798.9	2692	2	C	Clutter	-0.03	110.2	2.5	0.041	0.014	0.153
4369484.4	402801.4	2743	2	C	Clutter	-0.10	44.1	17.8	0.041	0.017	0.193
4369448.1	402809.9	2866	2	C	Clutter	-0.13	79.0	-14.6	0.041	0.014	0.206
4369436.0	402811.6	2901	2	C	Clutter	-0.03	329.3	10.2	0.041	0.009	0.497
4369462.5	402825.1	3045	2	C	Clutter	-0.15	73.2	23.5	0.041	0.013	0.231
4369525.1	402717.1	347	2	C	Clutter	-0.13	194.2	9.9	0.042	0.012	0.224
4369443.1	402720.7	416	2	C	Clutter	-0.29	233.6	-14.8	0.042	0.009	0.722
4369438.6	402728.2	623	2	C	Clutter	-0.20	248.0	8.6	0.042	0.030	0.123
4369458.9	402736.2	879	2	C	Clutter	-0.16	224.3	14.1	0.042	0.002	0.902
4369435.9	402763.7	1764	2	C	Clutter	-0.12	32.8	22.7	0.042	0.008	0.528
4369443.7	402767.7	1872	2	C	Clutter	-0.10	152.5	153.9	0.042	0.017	0.419
4369431.9	402774.8	2102	2	C	Clutter	-0.15	149.5	35.4	0.042	0.003	0.698
4369455.5	402782.4	2308	2	C	Clutter	-0.17	33.6	-5.7	0.042	0.022	0.117
4369436.0	402791.7	2540	2	C	Clutter	-0.14	14.3	20.8	0.042	0.017	0.261
4369455.0	402815.9	2964	2	C	Clutter	-0.15	61.4	3.2	0.042	0.015	0.491
4369449.5	402816.0	2966	2	C	Clutter	-0.09	191.2	6.6	0.042	0.015	0.311
4369475.1	402818.1	2987	2	C	Clutter	-0.14	240.9	31.0	0.042	0.009	0.762
4369492.4	402705.7	128	2	C	Clutter	-0.09	139.2	-10.2	0.043	0.005	0.690
4369452.9	402732.5	746	2	C	Clutter	-0.41	130.5	37.4	0.043	0.007	0.580

APG Indirect Fire Area

Northing, UTM 18N, meters	Easting, UTM 18N, meters	Anomaly Number	Disc. Stage/Rank 3 - Ord 2 - Clutter	Class O - Ord C - Clutter	Type	Depth (m)	Azimuth (Deg)	Inclination (Deg)	Length (m)	Radius (m)	MSE
4369448.8	402753.5	1398	2	C	Clutter	-0.29	98.0	17.2	0.043	0.019	0.638
4369436.2	402759.9	1636	2	C	Clutter	-0.42	206.9	89.8	0.043	0.039	0.118
4369397.3	402762.4	1722	2	C	Clutter	-0.34	278.0	6.8	0.043	0.019	0.409
4369427.8	402766.8	1845	2	C	Clutter	-0.04	207.8	-27.6	0.043	0.019	0.284
4369393.0	402771.9	2025	2	C	Clutter	-0.40	274.4	16.3	0.043	0.026	0.331
4369413.1	402790.1	2496	2	C	Clutter	-0.35	15.1	4.3	0.043	0.018	0.314
4369425.7	402797.0	2638	2	C	Clutter	-0.47	24.5	12.5	0.043	0.024	0.359
4369464.8	402799.0	2683	2	C	Clutter	-0.25	195.7	11.9	0.043	0.018	0.564
4369478.4	402799.5	2704	2	C	Clutter	-0.09	77.7	0.9	0.043	0.004	0.586
4369442.8	402808.8	2859	2	C	Clutter	-0.01	25.3	22.7	0.043	0.011	0.119
4369446.3	402811.0	2896	2	C	Clutter	-0.13	105.9	-15.4	0.043	0.016	0.413
4369460.8	402811.6	2903	2	C	Clutter	-0.27	104.4	25.4	0.043	0.013	0.115
4369442.8	402808.8	2904	2	C	Clutter	-0.01	21.1	24.2	0.043	0.011	0.140
4369466.5	402828.6	3067	2	C	Clutter	-0.14	16.5	-2.9	0.043	0.014	0.244
4369490.5	402729.5	668	2	C	Clutter	-0.07	216.7	7.2	0.044	0.014	0.392
4369443.9	402752.1	1392	2	C	Clutter	-0.33	184.0	-6.0	0.044	0.020	0.715
4369518.2	402770.2	1961	2	C	Clutter	-0.20	273.8	3.6	0.044	0.015	0.315
4369407.3	402771.8	2006	2	C	Clutter	-0.36	118.1	-2.9	0.044	0.021	0.616
4369407.2	402779.9	2237	2	C	Clutter	-0.20	12.2	-175.7	0.044	0.018	0.354
4369433.6	402785.0	2376	2	C	Clutter	-0.04	324.1	12.3	0.044	0.008	0.239
4369438.5	402806.3	2823	2	C	Clutter	-0.10	284.1	15.8	0.044	0.011	0.160
4369450.7	402813.3	2927	2	C	Clutter	-0.03	145.5	9.3	0.044	0.009	0.281
4369461.6	402817.2	2975	2	C	Clutter	-0.16	103.7	16.3	0.044	0.009	0.549
4369438.4	402736.0	852	2	C	Clutter	-0.48	48.3	-12.9	0.045	0.018	0.858
4369428.2	402753.9	1440	2	C	Clutter	-0.14	104.8	18.6	0.045	0.013	0.496
4369444.0	402761.5	1688	2	C	Clutter	-0.15	172.8	21.4	0.045	0.016	0.227
4369410.9	402787.0	2422	2	C	Clutter	-0.27	216.2	-11.7	0.045	0.018	0.444
4369472.3	402796.7	2648	2	C	Clutter	-0.12	81.4	13.3	0.045	0.019	0.112
4369435.1	402804.7	2802	2	C	Clutter	-0.40	335.0	-2.5	0.045	0.021	0.613
4369464.5	402812.4	2919	2	C	Clutter	-0.16	207.3	-2.7	0.045	0.015	0.361
4369466.8	402824.0	3033	2	C	Clutter	-0.12	171.7	-9.3	0.045	0.012	0.320
4369458.3	402828.6	3069	2	C	Clutter	-0.30	47.7	11.4	0.045	0.017	0.673
4369446.8	402715.9	55	2	C	Clutter	-0.25	356.9	34.7	0.046	0.016	0.288

APG Indirect Fire Area

Northing, UTM 18N, meters	Easting, UTM 18N, meters	Anomaly Number	Disc. Stage/Rank 3 - Ord 2 - Clutter	Class O - Ord C - Clutter	Type	Depth (m)	Azimuth (Deg)	Inclination (Deg)	Length (m)	Radius (m)	MSE
4369481.7	402713.5	258	2	C	Clutter	-0.44	104.8	11.2	0.046	0.022	0.654
4369485.0	402720.8	446	2	C	Clutter	-0.39	34.8	1.6	0.046	0.022	0.861
4369441.0	402723.0	464	2	C	Clutter	-0.33	218.0	-16.9	0.046	0.030	0.127
4369469.0	402727.3	613	2	C	Clutter	-0.12	351.1	5.1	0.046	0.013	0.187
4369435.7	402739.9	992	2	C	Clutter	-0.15	73.5	18.9	0.046	0.017	0.182
4369473.0	402753.5	1441	2	C	Clutter	-0.33	10.0	1.9	0.046	0.015	0.751
4369490.8	402773.1	2051	2	C	Clutter	-0.11	341.2	16.1	0.046	0.007	0.359
4369409.8	402775.5	2109	2	C	Clutter	-0.26	311.2	6.6	0.046	0.015	0.528
4369418.1	402781.0	2268	2	C	Clutter	-0.19	319.0	-2.2	0.046	0.014	0.736
4369405.4	402781.2	2277	2	C	Clutter	-0.30	222.2	-4.8	0.046	0.021	0.376
4369493.9	402781.2	2280	2	C	Clutter	-0.09	356.2	-10.0	0.046	0.018	0.162
4369476.1	402795.3	2629	2	C	Clutter	-0.01	46.8	3.9	0.046	0.011	0.418
4369459.1	402801.8	2751	2	C	Clutter	-0.22	172.0	23.2	0.046	0.010	0.363
4369441.1	402808.8	2858	2	C	Clutter	-0.39	241.6	-9.5	0.046	0.026	0.532
4369459.8	402818.8	2992	2	C	Clutter	-0.34	23.1	2.1	0.046	0.014	0.537
4369482.7	402718.7	382	2	C	Clutter	-0.44	212.1	-7.5	0.047	0.023	0.786
4369492.5	402751.9	1406	2	C	Clutter	-0.47	314.8	5.8	0.047	0.015	0.878
4369405.6	402761.9	1694	2	C	Clutter	-0.10	322.9	13.7	0.047	0.018	0.117
4369407.5	402766.3	1838	2	C	Clutter	-0.15	246.3	35.4	0.047	0.012	0.156
4369460.2	402774.0	2074	2	C	Clutter	-0.45	258.7	-49.5	0.047	0.037	0.323
4369416.9	402776.1	2116	2	C	Clutter	-0.37	274.1	6.5	0.047	0.018	0.995
4369446.9	402794.0	2591	2	C	Clutter	-0.07	284.0	7.7	0.047	0.009	0.454
4369451.5	402816.2	2970	2	C	Clutter	-0.07	103.1	20.7	0.047	0.023	0.178
4369452.2	402821.8	3022	2	C	Clutter	-0.36	91.5	2.7	0.047	0.021	0.668
4369458.0	402824.0	3037	2	C	Clutter	-0.42	87.7	10.5	0.047	0.024	0.599
4369456.4	402709.2	182	2	C	Clutter	-0.10	229.5	-18.7	0.048	0.014	0.168
4369475.1	402758.0	1573	2	C	Clutter	-0.22	322.2	78.3	0.048	0.017	0.090
4369416.3	402758.4	1590	2	C	Clutter	-0.01	297.0	18.5	0.048	0.029	0.100
4369415.9	402766.3	1833	2	C	Clutter	-0.08	133.3	152.5	0.048	0.044	0.351
4369513.6	402767.3	1837	2	C	Clutter	-0.25	108.0	7.3	0.048	0.008	0.704
4369394.4	402765.8	1844	2	C	Clutter	-0.48	311.2	2.1	0.048	0.026	0.337
4369415.0	402782.6	2300	2	C	Clutter	-0.02	80.7	3.8	0.048	0.001	0.798
4369472.9	402784.4	2362	2	C	Clutter	-0.01	314.1	-11.9	0.048	0.011	0.360

APG Indirect Fire Area

Northing, UTM 18N, meters	Easting, UTM 18N, meters	Anomaly Number	Disc. Stage/Rank 3 - Ord 2 - Clutter	Class O - Ord C - Clutter	Type	Depth (m)	Azimuth (Deg)	Inclination (Deg)	Length (m)	Radius (m)	MSE
4369493.5	402786.4	2416	2	C	Clutter	-0.12	186.8	4.3	0.048	0.009	0.294
4369461.6	402788.3	2465	2	C	Clutter	-0.07	329.1	31.5	0.048	0.012	0.164
4369429.6	402796.1	2634	2	C	Clutter	-0.20	254.8	-4.5	0.048	0.014	0.449
4369433.8	402796.8	2652	2	C	Clutter	-0.15	306.2	0.4	0.048	0.021	0.209
4369429.7	402805.2	2805	2	C	Clutter	-0.12	267.3	-7.0	0.048	0.013	0.410
4369447.8	402811.3	2906	2	C	Clutter	-0.33	116.2	-16.2	0.048	0.020	0.383
4369452.7	402815.0	2958	2	C	Clutter	-0.02	112.2	-16.6	0.048	0.008	0.245
4369520.8	402714.8	284	2	C	Clutter	-0.13	228.3	4.9	0.049	0.004	0.612
4369450.7	402715.1	297	2	C	Clutter	-0.26	243.4	-20.3	0.049	0.001	0.901
4369511.6	402716.0	319	2	C	Clutter	-0.14	212.1	-25.4	0.049	0.010	0.277
4369476.8	402721.8	456	2	C	Clutter	-0.58	134.4	86.6	0.049	0.033	0.872
4369467.6	402741.3	1028	2	C	Clutter	-0.07	88.4	-3.3	0.049	0.003	0.737
4369409.2	402772.6	2037	2	C	Clutter	-0.07	110.2	-6.9	0.049	0.009	0.339
4369471.2	402776.9	2156	2	C	Clutter	-0.03	354.2	35.8	0.049	0.023	0.317
4369429.1	402778.1	2193	2	C	Clutter	-0.11	135.0	-4.1	0.049	0.017	0.282
4369415.4	402781.5	2286	2	C	Clutter	-0.60	236.7	-26.1	0.049	0.026	0.624
4369441.0	402807.8	2837	2	C	Clutter	-0.25	163.3	19.6	0.049	0.015	0.383
4369466.3	402809.7	2878	2	C	Clutter	-0.10	93.6	-22.2	0.049	0.009	0.190
4369456.2	402816.9	2963	2	C	Clutter	-0.01	31.8	3.3	0.049	0.008	0.331
4369458.6	402822.5	3028	2	C	Clutter	-0.26	53.4	0.7	0.049	0.017	0.530
4369461.5	402826.1	3055	2	C	Clutter	-0.11	278.1	2.5	0.049	0.014	0.252
4369410.6	402784.4	2359	2	C	Clutter	-0.36	334.1	6.7	0.050	0.021	0.545
4369428.4	402799.1	2709	2	C	Clutter	-0.58	229.0	-1.8	0.050	0.024	0.460
4369460.6	402720.9	436	2	C	Clutter	-0.18	5.1	-7.2	0.051	0.013	0.200
4369535.0	402739.6	980	2	C	Clutter	-0.06	267.5	32.2	0.051	0.014	0.376
4369413.3	402748.3	1270	2	C	Clutter	-0.01	301.8	-2.9	0.051	0.012	0.118
4369416.0	402762.6	1715	2	C	Clutter	-0.04	343.1	1.2	0.051	0.011	0.535
4369410.7	402777.8	2185	2	C	Clutter	-0.44	223.0	-10.1	0.051	0.024	0.516
4369477.5	402791.0	2523	2	C	Clutter	-0.16	61.3	3.7	0.051	0.018	0.206
4369440.2	402806.8	2832	2	C	Clutter	-0.07	226.3	-3.9	0.051	0.016	0.125
4369441.2	402812.6	2922	2	C	Clutter	-0.30	241.1	4.9	0.051	0.017	0.438
4369471.0	402817.3	2980	2	C	Clutter	-0.07	205.8	-178.1	0.051	0.020	0.208
4369443.0	402716.9	338	2	C	Clutter	-0.38	341.5	-1.3	0.052	0.016	0.656

APG Indirect Fire Area

Northing, UTM 18N, meters	Easting, UTM 18N, meters	Anomaly Number	Disc. Stage/Rank 3 - Ord 2 - Clutter	Class O - Ord C - Clutter	Type	Depth (m)	Azimuth (Deg)	Inclination (Deg)	Length (m)	Radius (m)	MSE
4369413.5	402773.2	2057	2	C	Clutter	-0.09	283.4	14.8	0.052	0.012	0.331
4369399.7	402774.3	2090	2	C	Clutter	-0.19	100.6	16.7	0.052	0.011	0.243
4369464.6	402820.8	3014	2	C	Clutter	-0.16	243.6	34.5	0.052	0.039	0.207
4369419.1	402764.0	1765	2	C	Clutter	-0.13	135.0	11.1	0.053	0.018	0.508
4369396.3	402771.2	1973	2	C	Clutter	-0.59	7.3	2.1	0.053	0.032	0.404
4369463.2	402748.2	1196	2	C	Clutter	-0.40	120.5	-25.4	0.054	0.020	0.892
4369403.9	402769.8	1941	2	C	Clutter	-0.27	103.4	-0.7	0.054	0.025	0.190
4369409.1	402775.9	2119	2	C	Clutter	-0.52	24.9	1.7	0.054	0.028	0.529
4369407.5	402777.8	2167	2	C	Clutter	-0.56	205.8	-2.1	0.054	0.030	0.379
4369469.3	402821.3	3017	2	C	Clutter	-0.23	84.0	-0.6	0.054	0.051	0.075
4369406.6	402769.6	1937	2	C	Clutter	-0.26	273.0	12.1	0.055	0.017	0.271
4369446.8	402786.8	2426	2	C	Clutter	-0.11	218.2	14.6	0.055	0.017	0.116
4369454.0	402807.9	2842	2	C	Clutter	-0.10	171.4	3.3	0.055	0.020	0.164
4369473.9	402811.5	2902	2	C	Clutter	-0.36	254.1	-16.2	0.055	0.022	0.241
4369429.7	402739.4	974	2	C	Clutter	-0.07	310.7	-3.9	0.056	0.015	0.353
4369434.1	402754.5	1446	2	C	Clutter	-0.03	263.8	-23.1	0.056	0.022	0.291
4369466.6	402754.1	1458	2	C	Clutter	-0.23	23.6	3.3	0.056	0.006	0.518
4369399.6	402770.7	1968	2	C	Clutter	-0.60	251.9	-3.6	0.056	0.031	0.437
4369401.1	402775.1	2108	2	C	Clutter	-0.05	213.2	3.0	0.056	0.009	0.138
4369400.6	402779.0	2223	2	C	Clutter	-0.63	206.0	3.7	0.056	0.031	0.513
4369487.0	402790.9	2519	2	C	Clutter	-0.09	67.4	25.6	0.056	0.020	0.069
4369463.5	402797.8	2673	2	C	Clutter	-0.04	63.4	-357.7	0.056	0.010	0.126
4369444.2	402800.1	2711	2	C	Clutter	-0.52	312.1	17.9	0.056	0.022	0.805
4369440.6	402800.4	2721	2	C	Clutter	-0.30	351.6	-3.4	0.056	0.014	0.433
4369497.5	402716.7	331	2	C	Clutter	-0.13	340.2	-11.8	0.057	0.033	0.221
4369478.1	402720.6	426	2	C	Clutter	-0.26	184.8	7.5	0.057	0.031	0.189
4369456.9	402774.6	2093	2	C	Clutter	-0.07	267.6	15.0	0.057	0.019	0.200
4369435.6	402774.5	2101	2	C	Clutter	-0.14	299.4	4.5	0.057	0.005	0.370
4369509.4	402737.2	901	2	C	Clutter	-0.57	265.5	11.5	0.058	0.033	0.426
4369532.5	402746.5	1213	2	C	Clutter	-0.09	39.3	-0.6	0.058	0.013	0.146
4369425.5	402776.8	2152	2	C	Clutter	-0.09	38.7	-23.4	0.058	0.027	0.084
4369490.8	402776.9	2160	2	C	Clutter	-0.05	18.6	-12.8	0.058	0.031	0.137
4369447.9	402714.4	277	2	C	Clutter	-0.12	277.6	162.2	0.059	0.014	0.576

APG Indirect Fire Area

Northing, UTM 18N, meters	Easting, UTM 18N, meters	Anomaly Number	Disc. Stage/Rank 3 - Ord 2 - Clutter	Class O - Ord C - Clutter	Type	Depth (m)	Azimuth (Deg)	Inclination (Deg)	Length (m)	Radius (m)	MSE
4369479.6	402742.1	1049	2	C	Clutter	-0.18	197.3	13.2	0.059	0.033	0.210
4369437.7	402749.8	1319	2	C	Clutter	-0.18	176.0	7.1	0.059	0.012	0.828
4369465.7	402763.3	1735	2	C	Clutter	-0.17	256.3	12.2	0.059	0.009	0.304
4369431.9	402795.7	2625	2	C	Clutter	-0.23	211.2	7.0	0.059	0.009	0.435
4369445.5	402803.4	2776	2	C	Clutter	-0.06	301.9	5.5	0.059	0.010	0.775
4369478.3	402716.5	332	2	C	Clutter	0.18	283.7	26.2	0.060	0.021	0.183
4369439.5	402732.5	756	2	C	Clutter	-0.02	186.3	6.9	0.060	0.036	0.221
4369426.8	402734.2	810	2	C	Clutter	-0.10	196.7	15.4	0.060	0.018	0.179
4369522.2	402734.8	825	2	C	Clutter	-0.16	208.5	0.0	0.060	0.033	0.070
4369399.1	402762.5	1685	2	C	Clutter	-0.82	256.8	-7.0	0.060	0.033	0.610
4369517.2	402762.3	1712	2	C	Clutter	-0.16	14.0	7.4	0.060	0.017	0.130
4369411.5	402760.7	1664	2	C	Clutter	-0.29	37.1	13.1	0.061	0.020	0.090
4369552.4	402738.2	940	2	C	Clutter	-0.12	226.3	-6.3	0.061	0.050	0.268
4369520.1	402755.9	1513	2	C	Clutter	-0.08	102.4	3.6	0.061	0.012	0.196
4369406.1	402779.2	2236	2	C	Clutter	-0.61	332.3	1.6	0.061	0.032	0.357
4369442.6	402805.2	2804	2	C	Clutter	-0.28	336.0	5.8	0.061	0.023	0.544
4369462.1	402823.3	3036	2	C	Clutter	-0.28	355.1	9.5	0.061	0.014	0.276
4369475.7	402747.8	1226	2	C	Clutter	-0.39	296.0	20.5	0.062	0.016	0.234
4369408.6	402769.9	1945	2	C	Clutter	-0.18	154.9	20.3	0.062	0.030	0.111
4369484.4	402770.4	1960	2	C	Clutter	-0.10	100.1	13.2	0.062	0.024	0.135
4369450.0	402782.9	2319	2	C	Clutter	-0.14	270.3	-30.9	0.062	0.051	0.082
4369485.1	402791.6	2535	2	C	Clutter	-0.04	48.7	-0.7	0.062	0.011	0.118
4369457.1	402798.5	2684	2	C	Clutter	-0.45	102.2	29.9	0.062	0.029	0.221
4369480.1	402805.9	2817	2	C	Clutter	-0.31	189.8	-6.5	0.062	0.020	0.170
4369421.2	402765.4	1803	2	C	Clutter	-0.03	300.6	5.6	0.063	0.006	0.154
4369466.8	402802.1	2755	2	C	Clutter	-0.01	250.2	-10.5	0.063	0.023	0.214
4369453.7	402814.6	2949	2	C	Clutter	-0.25	164.9	-10.4	0.063	0.016	0.604
4369481.8	402711.6	220	2	C	Clutter	-0.60	160.4	13.8	0.064	0.029	0.651
4369487.2	402741.5	1031	2	C	Clutter	-0.11	173.0	-3.9	0.064	0.020	0.120
4369401.0	402771.8	2012	2	C	Clutter	-0.64	288.4	-0.2	0.064	0.028	0.282
4369480.2	402816.9	2977	2	C	Clutter	-0.41	299.1	-20.9	0.065	0.015	0.170
4369422.4	402747.1	1233	2	C	Clutter	-0.14	311.4	-3.6	0.066	0.024	0.633
4369457.2	402768.1	1888	2	C	Clutter	-0.08	255.1	8.7	0.066	0.008	0.237

APG Indirect Fire Area

Northing, UTM 18N, meters	Easting, UTM 18N, meters	Anomaly Number	Disc. Stage/Rank 3 - Ord 2 - Clutter	Class O - Ord C - Clutter	Type	Depth (m)	Azimuth (Deg)	Inclination (Deg)	Length (m)	Radius (m)	MSE
4369444.5	402796.5	2599	2	C	Clutter	-0.68	287.5	-9.5	0.066	0.022	0.866
4369488.1	402800.6	2723	2	C	Clutter	-0.15	30.8	1.9	0.066	0.016	0.215
4369441.5	402779.9	2200	2	C	Clutter	-0.15	295.6	11.6	0.067	0.028	0.463
4369468.8	402803.7	2786	2	C	Clutter	-0.07	56.9	7.8	0.068	0.015	0.234
4369457.0	402762.4	1717	2	C	Clutter	-0.06	316.9	7.1	0.069	0.009	0.530
4369475.6	402717.7	376	2	C	Clutter	-0.62	83.5	-6.0	0.070	0.029	0.717
4369419.0	402753.9	1443	2	C	Clutter	-0.12	168.5	74.6	0.070	0.047	0.135
4369398.4	402775.0	2094	2	C	Clutter	-0.69	219.5	7.1	0.070	0.030	0.401
4369403.0	402776.5	2137	2	C	Clutter	-0.75	82.6	6.4	0.070	0.035	0.374
4369467.6	402788.1	2462	2	C	Clutter	-0.11	34.6	27.5	0.070	0.016	0.085
4369466.2	402799.2	2700	2	C	Clutter	-0.04	93.3	-12.1	0.070	0.008	0.170
4369459.5	402820.8	3012	2	C	Clutter	-0.08	99.3	8.1	0.070	0.016	0.158
4369461.1	402726.7	589	2	C	Clutter	-0.09	186.0	-8.7	0.071	0.016	0.123
4369507.7	402750.1	1329	2	C	Clutter	-0.02	84.3	-4.0	0.071	0.011	0.216
4369424.9	402763.7	1747	2	C	Clutter	-0.13	244.8	7.3	0.071	0.032	0.253
4369414.4	402777.6	2183	2	C	Clutter	-0.60	296.1	2.4	0.071	0.031	0.970
4369414.9	402758.0	1564	2	C	Clutter	-0.09	78.3	6.7	0.072	0.008	0.140
4369396.2	402766.8	1847	2	C	Clutter	-0.68	227.3	7.0	0.072	0.033	0.280
4369397.3	402771.9	2009	2	C	Clutter	-0.83	52.8	-6.3	0.072	0.041	0.444
4369436.5	402803.9	2784	2	C	Clutter	-0.16	8.6	-13.7	0.072	0.013	0.150
4369465.7	402807.0	2831	2	C	Clutter	-0.11	134.9	-34.3	0.072	0.052	0.135
4369462.3	402829.3	3071	2	C	Clutter	-0.19	188.8	-3.7	0.072	0.010	0.296
4369413.4	402765.8	1814	2	C	Clutter	-0.17	156.3	6.0	0.073	0.036	0.246
4369416.7	402771.8	2010	2	C	Clutter	-0.16	246.4	-0.2	0.073	0.013	0.151
4369453.3	402789.9	2499	2	C	Clutter	-0.17	164.4	19.7	0.073	0.007	0.375
4369455.3	402758.6	1641	2	C	Clutter	-0.12	211.1	2.5	0.074	0.013	0.136
4369427.6	402789.4	2481	2	C	Clutter	-0.14	1.4	13.5	0.074	0.032	0.347
4369419.3	402760.1	1652	2	C	Clutter	-0.97	54.4	27.0	0.075	0.011	0.946
4369411.5	402762.3	1710	2	C	Clutter	-0.07	69.9	-8.6	0.075	0.039	0.162
4369425.2	402768.2	1891	2	C	Clutter	-0.07	235.1	-7.4	0.075	0.012	0.126
4369431.7	402778.4	2188	2	C	Clutter	-0.45	138.6	-28.9	0.075	0.031	0.480
4369439.0	402755.2	1478	2	C	Clutter	-0.27	341.6	116.1	0.076	0.014	0.612
4369467.2	402792.8	2549	2	C	Clutter	-0.35	62.2	-50.0	0.076	0.002	0.978

APG Indirect Fire Area

Northing, UTM 18N, meters	Easting, UTM 18N, meters	Anomaly Number	Disc. Stage/Rank 3 - Ord 2 - Clutter	Class O - Ord C - Clutter	Type	Depth (m)	Azimuth (Deg)	Inclination (Deg)	Length (m)	Radius (m)	MSE
4369435.0	402723.5	492	2	C	Clutter	-0.35	278.3	2.8	0.077	0.008	0.353
4369430.8	402776.6	2147	2	C	Clutter	-0.05	154.145,	9.5	0.080	0.011	0.271
4369438.0	402772.9	2196	2	C	Clutter	-0.24	43.8	-2.6	0.082	0.049	0.103
4369437.0	402809.1	2854	2	C	Clutter	-1.13	3.3	1.4	0.082	0.054	0.596
4369436.3	402751.6	1370	2	C	Clutter	-0.25	311.4	2.6	0.084	0.011	0.847
4369415.1	402787.9	2439	2	C	Clutter	-1.01	60.3	-0.3	0.084	0.046	0.499
4369440.4	402787.9	2457	2	C	Clutter	-0.03	322.2	6.4	0.084	0.008	0.104
4369449.6	402798.5	2680	2	C	Clutter	-0.13	308.3	7.4	0.084	0.013	0.372
4369465.0	402802.3	2758	2	C	Clutter	-0.11	85.4	16.9	0.084	0.011	0.119
4369482.5	402765.1	1791	2	C	Clutter	-0.09	6.3	-18.0	0.085	0.037	0.104
4369440.4	402719.4	392	2	C	Clutter	-0.33	290.5	2.5	0.085	0.007	0.455
4369484.7	402754.1	1455	2	C	Clutter	-0.04	335.1	-5.8	0.085	0.007	0.132
4369454.8	402793.9	2594	2	C	Clutter	-0.07	4.1	176.8	0.087	0.009	0.158
4369440.9	402781.6	2244	2	C	Clutter	-0.15	80.8	170.2	0.088	0.009	0.122
4369476.1	402748.8	1272	2	C	Clutter	-0.13	353.0	-4.8	0.089	0.011	0.264
4369443.2	402751.0	1367	2	C	Clutter	-0.08	297.0	-8.0	0.089	0.011	0.157
4369531.0	402760.8	1675	2	C	Clutter	-0.09	186.7	-2.7	0.089	0.017	0.155
4369410.3	402753.4	1431	2	C	Clutter	-0.04	275.0	-3.4	0.090	0.008	0.159
4369463.0	402754.1	1450	2	C	Clutter	-0.62	256.1	11.0	0.090	0.051	0.069
4369450.9	402799.0	2690	2	C	Clutter	-1.24	7.8	54.7	0.090	0.068	0.791
4369465.2	402800.1	2701	2	C	Clutter	0.00	120.1	-5.0	0.090	0.010	0.139
4369476.0	402808.4	3068	2	C	Clutter	-0.10	103.4	6.4	0.090	0.009	0.320
4369473.8	402785.4	2403	2	C	Clutter	-0.12	82.1	1.9	0.091	0.013	0.220
4369458.0	402807.6	2838	2	C	Clutter	-0.22	117.9	15.2	0.091	0.012	0.164
4369474.3	402808.2	2850	2	C	Clutter	-0.14	139.8	0.6	0.091	0.008	0.177
4369448.4	402750.3	1332	2	C	Clutter	-0.23	126.2	4.3	0.092	0.008	0.182
4369443.6	402794.6	2607	2	C	Clutter	-0.17	308.1	-11.1	0.092	0.041	0.142
4369443.9	402801.1	2729	2	C	Clutter	-0.15	261.6	16.8	0.093	0.010	0.159
4369467.4	402813.9	2941	2	C	Clutter	-0.09	165.8	0.5	0.093	0.014	0.100
4369464.1	402801.4	2738	2	C	Clutter	-0.08	78.8	11.3	0.094	0.011	0.116
4369475.2	402809.3	2869	2	C	Clutter	-0.20	130.3	24.0	0.094	0.011	0.100
4369520.3	402725.8	550	2	C	Clutter	-0.69	269.4	22.2	0.097	0.041	0.252
4369476.4	402776.0	2134	2	C	Clutter	-0.16	121.3	-1.2	0.097	0.044	0.575

APG Indirect Fire Area

Northing, UTM 18N, meters	Easting, UTM 18N, meters	Anomaly Number	Disc. Stage/Rank 3 - Ord 2 - Clutter	Class O - Ord C - Clutter	Type	Depth (m)	Azimuth (Deg)	Inclination (Deg)	Length (m)	Radius (m)	MSE
4369464.0	402753.2	1420	2	C	Clutter	-0.20	327.5	0.0	0.098	0.009	0.156
4369408.4	402753.2	1429	2	C	Clutter	-0.03	281.9	-3.8	0.098	0.008	0.117
4369423.5	402787.7	2456	2	C	Clutter	-0.09	117.1	7.8	0.098	0.014	0.228
4369460.9	402797.1	2658	2	C	Clutter	-0.15	115.0	-20.8	0.098	0.013	0.350
4369423.9	402757.8	1582	2	C	Clutter	-0.37	231.7	-0.9	0.099	0.054	0.296
4369488.0	402761.9	1692	2	C	Clutter	-0.64	178.7	8.0	0.099	0.005	0.917
4369468.3	402801.4	2737	2	C	Clutter	-0.18	355.2	1.3	0.100	0.011	0.381
4369417.3	402748.3	1283	2	C	Clutter	-1.10	100.2	-69.5	0.101	0.008	0.991
4369483.0	402715.9	323	2	C	Clutter	-0.02	22.6	8.8	0.102	0.001	0.987
4369446.9	402741.4	1039	2	C	Clutter	-0.71	303.8	-36.4	0.103	0.038	0.822
4369438.3	402783.9	2347	2	C	Clutter	-0.09	272.9	-5.9	0.104	0.019	0.166
4369426.1	402772.0	2020	2	C	Clutter	-0.38	318.2	2.9	0.105	0.050	0.709
4369455.7	402818.2	2993	2	C	Clutter	-0.16	69.6	8.8	0.110	0.024	0.238
4369471.7	402781.7	2295	2	C	Clutter	-0.20	47.7	-17.1	0.116	0.023	0.378
4369497.2	402712.4	241	2	C	Clutter	-0.54	351.7	5.3	0.116	0.020	0.231
4369410.7	402782.2	2287	2	C	Clutter	-0.02	294.2	5.4	0.116	0.001	0.803
4369431.8	402786.7	2431	2	C	Clutter	-0.17	178.1	-0.3	0.118	0.047	0.208
4369510.4	402760.4	1648	2	C	Clutter	-0.11	67.1	3.9	0.122	0.060	0.084
4369483.6	402796.8	2644	2	C	Clutter	-0.09	86.0	-13.5	0.124	0.023	0.117
4369451.9	402744.2	1134	2	C	Clutter	-0.24	124.4	-6.6	0.126	0.066	0.318
4369517.3	402720.1	408	2	C	Clutter	-0.06	103.4	14.7	0.127	0.012	0.477
4369524.4	402740.0	997	2	C	Clutter	-0.23	12.5	-16.9	0.128	0.026	0.164
4369474.3	402743.0	1084	2	C	Clutter	-0.20	3.7	-3.8	0.128	0.033	0.148
4369504.2	402759.8	1593	2	C	Clutter	-0.49	30.3	50.8	0.128	0.001	0.965
4369436.5	402777.8	2172	2	C	Clutter	-0.46	205.1	8.8	0.130	0.030	0.653
4369487.8	402709.7	198	2	C	Clutter	0.00	127.9	3.6	0.130	0.008	0.944
4369521.5	402726.3	575	2	C	Clutter	-0.44	190.1	-8.9	0.134	0.064	0.756
4369545.1	402731.8	690	2	C	Clutter	-0.44	307.5	24.8	0.136	0.001	0.989
4369436.6	402753.3	1438	2	C	Clutter	-0.40	221.5	-1.8	0.136	0.035	0.405
4369469.9	402781.0	2246	2	C	Clutter	-0.34	84.7	-15.6	0.138	0.025	0.382
4369447.2	402751.6	1354	2	C	Clutter	-0.52	73.8	-41.1	0.139	0.032	0.662
4369454.3	402777.0	2158	2	C	Clutter	-0.25	263.9	-22.1	0.140	0.028	0.188
4369483.6	402723.2	469	2	C	Clutter	-0.05	158.2	-1.0	0.162	0.001	0.982

APG Indirect Fire Area

Northing, UTM 18N, meters	Easting, UTM 18N, meters	Anomaly Number	Disc. Stage/Rank 3 - Ord 2 - Clutter	Class O - Ord C - Clutter	Type	Depth (m)	Azimuth (Deg)	Inclination (Deg)	Length (m)	Radius (m)	MSE
4369441.3	402769.3	1946	2	C	Clutter	-1.38	216.2	-21.7	0.171	0.029	0.987
4369495.0	402745.3	1132	2	C	Clutter	-0.05	325.3	-0.6	0.188	0.004	0.943
4369430.0	402749.1	1263	2	C	Clutter	-1.42	148.8	-29.0	0.211	0.027	0.934
4369395.6	402769.6	1936	2	C	Clutter	-0.02	269.4	47.8	0.215	0.002	0.907
4369493.2	402751.3	1432	2	C	Clutter	-1.49	258.2	69.2	0.296	0.035	0.958
4369458.3	402788.9	2459	2	C	Clutter	-0.10	295.8	27.1	0.359	0.003	0.886
4369408.3	402765.2	1787	2	C	Clutter	-0.10	134.4	31.8	0.394	0.001	0.909
4369447.3	402730.6	710	2	C	Clutter	-0.78	118.9	5.7	0.622	0.016	0.906
4369438.7	402794.8	2609	2	C	Clutter	-1.20	305.1	10.1	0.882	0.041	0.489
4369528.9	402763.8	1744	2	C	Clutter	-0.54	308.0	15.1	0.939	0.007	0.922
4369424.5	402798.9	2698	2	C	Clutter	-1.68	79.5	67.3	0.961	0.058	0.624
4369493.0	402746.8	1188	2	C	Clutter	-0.67	118.3	-6.5	1.000	0.009	0.970
4369475.7	402767.8	1879	3	O	105M60	-0.45	334.4	30.1	0.126	0.046	0.092
4369437.8	402793.2	2569	3	O	105M60	-0.41	345.3	-1.2	0.126	0.039	0.106
4369431.2	402793.6	2579	3	O	105M60	-0.37	317.2	22.8	0.128	0.052	0.063
4369406.8	402764.8	1799	3	O	105M60	-0.61	320.1	-1.9	0.130	0.054	0.697
4369499.4	402750.6	1342	3	O	105M60	-0.37	49.1	-3.1	0.131	0.038	0.485
4369463.2	402754.6	1501	3	O	105M60	-0.61	65.9	-3.0	0.131	0.040	0.266
4369461.9	402781.2	2278	3	O	105M60	-0.45	238.3	-8.2	0.131	0.039	0.118
4369447.6	402752.5	1394	3	O	105M60	-0.23	75.9	10.6	0.132	0.039	0.380
4369462.8	402749.5	1311	3	O	105M60	-0.11	318.7	11.7	0.133	0.036	0.213
4369420.7	402734.8	841	3	O	105M60	-1.75	158.8	11.0	0.134	0.048	0.764
4369472.7	402777.7	2182	3	O	105M60	-0.35	21.6	25.5	0.134	0.056	0.096
4369522.1	402724.0	509	3	O	105M60	-0.19	216.3	16.2	0.135	0.055	0.228
4369456.4	402752.9	1411	3	O	105M60	-0.49	179.1	6.9	0.135	0.046	0.088
4369481.1	402775.6	2132	3	O	105M60	-0.47	178.7	28.8	0.136	0.048	0.088
4369530.7	402738.5	949	3	O	105M60	-0.46	209.8	10.6	0.137	0.036	0.158
4369489.7	402743.0	1080	3	O	105M60	-0.38	281.1	13.1	0.137	0.045	0.077
4369462.7	402767.0	1855	3	O	105M60	-0.50	181.0	19.7	0.137	0.052	0.081
4369474.6	402786.6	2404	3	O	105M60	-0.34	152.0	31.5	0.138	0.047	0.063
4369469.4	402787.5	2443	3	O	105M60	-0.22	20.7	31.9	0.138	0.043	0.070
4369453.2	402760.9	1679	3	O	105M60	-0.23	309.6	-5.2	0.139	0.054	0.222
4369428.8	402782.1	2298	3	O	105M60	-0.24	149.7	-23.0	0.139	0.055	0.232

APG Indirect Fire Area

Northing, UTM 18N, meters	Easting, UTM 18N, meters	Anomaly Number	Disc. Stage/Rank 3 - Ord 2 - Clutter	Class O - Ord C - Clutter	Type	Depth (m)	Azimuth (Deg)	Inclination (Deg)	Length (m)	Radius (m)	MSE
4369448.1	402766.1	1816	3	O	105M60	-0.29	321.2	-2.1	0.140	0.042	0.371
4369424.2	402776.3	2144	3	O	105M60	-0.46	122.7	15.8	0.140	0.046	0.119
4369406.6	402764.9	1751	3	O	105M60	-0.70	234.1	30.1	0.140	0.046	0.777
4369517.3	402740.5	1003	3	O	105M60	-0.48	131.8	-31.7	0.142	0.047	0.070
4369472.0	402762.0	1699	3	O	105M60	-0.65	356.3	-8.2	0.142	0.046	0.091
4369460.0	402769.2	1923	3	O	105M60	-0.15	267.7	14.6	0.142	0.046	0.111
4369436.3	402779.0	2201	3	O	105M60	-0.48	222.1	17.3	0.142	0.046	0.058
4369469.9	402771.1	1979	3	O	105M60	-0.20	310.2	-26.8	0.143	0.048	0.246
4369447.4	402799.0	2696	3	O	105M60	-0.53	336.5	159.8	0.143	0.047	0.069
4369454.2	402798.9	2695	3	O	105M60	-0.15	354.0	14.7	0.144	0.051	0.089
4369516.5	402717.2	344	3	O	105M60	-0.21	45.3	14.7	0.145	0.053	0.153
4369514.9	402755.4	1494	3	O	105M60	-0.17	141.4	-2.6	0.145	0.056	0.082
4369446.6	402789.7	2495	3	O	105M60	-0.72	332.9	7.5	0.145	0.038	0.256
4369473.1	402727.6	608	3	O	105M60	-0.39	123.6	12.6	0.146	0.045	0.244
4369435.0	402746.2	1194	3	O	105M60	-0.20	166.5	-3.4	0.146	0.055	0.217
4369465.1	402780.9	2263	3	O	105M60	-0.78	10.1	5.9	0.146	0.039	0.150
4369504.5	402724.9	513	3	O	105M60	-0.88	279.6	22.5	0.147	0.045	0.098
4369440.9	402741.6	1034	3	O	105M60	-0.31	352.7	-4.6	0.147	0.060	0.354
4369446.1	402740.8	1013	3	O	105M60	-0.30	348.7	12.8	0.148	0.052	0.084
4369450.5	402748.8	1267	3	O	105M60	-0.31	262.2	-0.4	0.150	0.061	0.257
4369436.7	402790.2	2505	3	O	105M60	-0.50	264.5	17.6	0.150	0.050	0.089
4369433.0	402799.4	2691	3	O	105M60	-1.35	328.7	10.7	0.150	0.055	0.673
4369502.6	402706.6	140	3	O	105M60	-0.58	9.9	5.8	0.152	0.042	0.087
4369468.6	402730.8	702	3	O	105M60	-0.25	183.8	8.6	0.152	0.044	0.114
4369506.8	402737.5	920	3	O	105M60	-0.17	304.1	15.5	0.152	0.056	0.097
4369476.4	402771.0	1976	3	O	105M60	-0.28	233.8	-10.7	0.152	0.050	0.132
4369484.3	402777.4	2173	3	O	105M60	-0.20	206.2	22.3	0.152	0.042	0.138
4369417.8	402778.0	2187	3	O	105M60	-0.25	321.5	-6.7	0.152	0.048	0.195
4369427.8	402791.7	2543	3	O	105M60	-0.63	333.3	-27.3	0.152	0.051	0.086
4369450.4	402748.5	1266	3	O	105M60	-0.34	86.1	4.3	0.153	0.047	0.237
4369457.7	402749.9	1327	3	O	105M60	-0.13	145.5	-4.5	0.153	0.056	0.109
4369419.4	402783.2	2325	3	O	105M60	-0.36	107.4	8.6	0.153	0.049	0.092
4369479.9	402726.8	585	3	O	105M60	-0.48	166.7	14.0	0.154	0.045	0.083

APG Indirect Fire Area

Northing, UTM 18N, meters	Easting, UTM 18N, meters	Anomaly Number	Disc. Stage/Rank 3 - Ord 2 - Clutter	Class O - Ord C - Clutter	Type	Depth (m)	Azimuth (Deg)	Inclination (Deg)	Length (m)	Radius (m)	MSE
4369441.1	402795.0	2617	3	O	105M60	-0.13	213.8	5.2	0.155	0.052	0.129
4369499.9	402723.0	484	3	O	105M60	-0.19	264.6	18.6	0.156	0.046	0.312
4369456.3	402800.3	2712	3	O	105M60	-0.62	180.6	-6.5	0.156	0.041	0.398
4369486.8	402712.6	234	3	O	105M60	-0.63	138.8	-19.4	0.157	0.045	0.124
4369493.3	402733.5	778	3	O	105M60	-0.60	59.8	15.6	0.157	0.049	0.082
4369449.4	402806.3	2822	3	O	105M60	-0.29	11.5	12.3	0.157	0.041	0.317
4369527.5	402746.6	1212	3	O	105M60	-0.58	259.2	15.7	0.158	0.050	0.081
4369422.5	402772.8	2035	3	O	105M60	-0.51	171.9	-3.3	0.158	0.045	0.097
4369474.9	402779.4	2218	3	O	105M60	-0.67	122.0	7.0	0.158	0.049	0.152
4369448.7	402793.4	2576	3	O	105M60	-0.17	280.9	15.3	0.158	0.057	0.085
4369523.4	402752.7	1404	3	O	105M60	-0.15	161.2	-1.5	0.159	0.054	0.100
4369421.5	402771.3	1990	3	O	105M60	-0.25	351.8	150.3	0.159	0.047	0.087
4369432.2	402783.9	2352	3	O	105M60	-0.27	216.4	-3.7	0.159	0.057	0.103
4369453.3	402805.1	2806	3	O	105M60	-0.47	115.1	-16.1	0.159	0.049	0.097
4369487.0	402743.5	1098	3	O	105M60	-0.27	223.5	-35.0	0.161	0.042	0.074
4369430.7	402785.4	2387	3	O	105M60	-0.52	265.0	-11.1	0.161	0.049	0.105
4369456.3	402772.9	2039	3	O	105M60	-0.51	9.1	23.9	0.162	0.042	0.089
4369477.9	402783.8	2342	3	O	105M60	-0.11	76.9	6.2	0.162	0.055	0.152
4369478.5	402715.4	291	3	O	105M60	-0.75	9.1	16.1	0.163	0.055	0.246
4369438.0	402789.7	2486	3	O	105M60	-0.27	12.2	5.8	0.163	0.050	0.143
4369447.2	402804.0	2791	3	O	105M60	-0.31	299.6	-10.0	0.163	0.051	0.092
4369468.3	402713.3	261	3	O	105M60	-0.39	193.7	1.5	0.164	0.046	0.103
4369433.6	402793.6	2581	3	O	105M60	-0.47	323.6	13.6	0.164	0.052	0.097
4369496.0	402717.0	343	3	O	105M60	-0.31	216.6	-28.9	0.165	0.054	0.094
4369445.4	402747.4	1234	3	O	105M60	-0.65	300.4	-9.6	0.165	0.056	0.101
4369468.1	402764.6	1781	3	O	105M60	-0.35	276.1	13.7	0.165	0.051	0.126
4369509.8	402718.8	365	3	O	105M60	-0.79	39.2	21.7	0.167	0.050	0.159
4369472.3	402765.8	1826	3	O	105M60	-0.25	220.9	8.3	0.167	0.056	0.319
4369421.3	402777.2	2178	3	O	105M60	-0.24	26.1	11.0	0.169	0.046	0.287
4369446.5	402801.5	2742	3	O	105M60	-0.26	74.8	3.3	0.169	0.055	0.120
4369481.9	402700.5	49	3	O	105M60	-0.44	0.4	-1.7	0.170	0.046	0.091
4369426.0	402774.7	2088	3	O	105M60	-0.30	250.3	15.7	0.170	0.056	0.120
4369442.4	402793.4	2575	3	O	105M60	-0.40	258.3	4.0	0.171	0.048	0.085

APG Indirect Fire Area

Northing, UTM 18N, meters	Easting, UTM 18N, meters	Anomaly Number	Disc. Stage/Rank 3 - Ord 2 - Clutter	Class O - Ord C - Clutter	Type	Depth (m)	Azimuth (Deg)	Inclination (Deg)	Length (m)	Radius (m)	MSE
4369429.7	402794.1	2616	3	O	105M60	-1.38	343.1	-4.9	0.172	0.049	0.651
4369451.8	402754.4	1464	3	O	105M60	-0.18	24.4	6.0	0.173	0.057	0.208
4369506.2	402763.0	1732	3	O	105M60	-0.12	162.0	11.1	0.173	0.050	0.118
4369473.1	402778.0	2181	3	O	105M60	-0.56	119.2	2.7	0.174	0.065	0.362
4369428.9	402773.5	2062	3	O	105M60	-0.11	127.7	0.9	0.175	0.058	0.140
4369486.7	402692.7	7	3	O	105M60	-0.21	248.0	3.7	0.176	0.051	0.092
4369509.0	402713.3	257	3	O	105M60	-0.51	192.3	14.8	0.176	0.044	0.104
4369467.2	402759.0	1619	3	O	105M60	-0.18	204.4	6.2	0.176	0.053	0.101
4369465.8	402715.2	298	3	O	105M60	-0.30	350.7	5.6	0.177	0.051	0.143
4369444.2	402746.8	1218	3	O	105M60	-0.37	255.1	-196.7	0.177	0.049	0.144
4369481.7	402728.4	638	3	O	105M60	-0.78	53.8	-1.2	0.179	0.043	0.718
4369443.7	402754.5	1452	3	O	105M60	-0.75	197.0	-13.8	0.179	0.050	0.230
4369451.6	402803.2	2780	3	O	105M60	-0.24	15.5	-181.5	0.179	0.053	0.502
4369495.6	402697.1	24	3	O	105M60	-0.46	18.0	18.6	0.182	0.051	0.149
4369457.7	402757.6	1552	3	O	105M60	-0.59	233.6	2.7	0.183	0.054	0.109
4369466.0	402768.9	1913	3	O	105M60	-0.36	338.8	7.5	0.183	0.050	0.150
4369498.3	402720.1	417	3	O	105M60	-0.35	282.6	-13.8	0.184	0.055	0.221
4369442.8	402799.0	2688	3	O	105M60	-0.70	282.7	-9.4	0.186	0.059	0.469
4369445.5	402789.5	2482	3	O	105M60	-0.66	267.8	9.1	0.188	0.051	0.356
4369438.2	402782.0	2302	3	O	105M60	-0.22	304.1	-2.0	0.189	0.056	0.207
4369472.0	402719.7	403	3	O	105M60	-0.30	315.6	-17.0	0.190	0.059	0.190
4369452.2	402801.9	2750	3	O	105M60	-0.74	47.1	4.8	0.225	0.083	0.542
4369451.4	402800.1	2717	3	O	105M60	-0.22	193.7	-8.9	0.123	0.041	0.137
4369483.7	402780.5	2252	3	O	105M60	-0.28	153.4	15.3	0.129	0.040	0.118
4369441.8	402742.0	1070	3	O	105M60	-1.05	255.4	-39.9	0.178	0.063	0.513
4369517.1	402768.6	1897	3	O	60mm	-0.07	115.0	16.7	0.068	0.025	0.069
4369469.6	402801.8	2747	3	O	60mm	-0.05	42.8	9.1	0.069	0.019	0.454
4369465.1	402817.0	2978	3	O	60mm	-0.10	164.5	21.5	0.070	0.020	0.098
4369490.5	402716.5	327	3	O	60mm	-0.12	46.7	16.8	0.072	0.027	0.354
4369456.9	402818.9	2995	3	O	60mm	-0.37	184.7	-8.6	0.072	0.021	0.468
4369428.0	402776.5	2140	3	O	60mm	-0.40	73.2	-27.1	0.073	0.022	0.176
4369439.4	402810.7	2899	3	O	60mm	-0.41	304.5	-9.6	0.073	0.024	0.483
4369435.0	402749.7	1320	3	O	60mm	-0.14	3.1	11.3	0.074	0.021	0.247

APG Indirect Fire Area

Northing, UTM 18N, meters	Easting, UTM 18N, meters	Anomaly Number	Disc. Stage/Rank 3 - Ord 2 - Clutter	Class O - Ord C - Clutter	Type	Depth (m)	Azimuth (Deg)	Inclination (Deg)	Length (m)	Radius (m)	MSE
4369452.7	402758.3	1584	3	O	60mm	-0.13	318.3	25.1	0.074	0.021	0.210
4369452.0	402808.1	2836	3	O	60mm	-0.37	179.6	4.7	0.074	0.019	0.159
4369512.5	402714.1	275	3	O	60mm	-0.12	329.5	32.1	0.075	0.026	0.098
4369481.5	402723.2	475	3	O	60mm	-0.51	121.0	-1.7	0.075	0.026	0.922
4369513.8	402761.0	1681	3	O	60mm	-0.15	165.8	5.8	0.076	0.025	0.116
4369490.1	402698.6	34	3	O	60mm	-0.27	234.7	18.3	0.077	0.026	0.106
4369437.6	402780.8	2266	3	O	60mm	-0.11	189.9	42.5	0.077	0.025	0.103
4369479.3	402783.3	2332	3	O	60mm	-0.13	64.9	15.3	0.078	0.030	0.176
4369477.0	402787.9	2453	3	O	60mm	-0.25	338.6	43.5	0.078	0.022	0.119
4369496.6	402699.7	40	3	O	60mm	-0.12	184.3	20.3	0.079	0.021	0.132
4369474.6	402736.5	880	3	O	60mm	-0.10	38.1	37.3	0.079	0.022	0.071
4369438.2	402758.8	1601	3	O	60mm	-0.35	223.0	-11.1	0.079	0.024	0.404
4369443.9	402762.8	1729	3	O	60mm	-0.10	116.0	-27.4	0.079	0.023	0.094
4369419.5	402780.2	2242	3	O	60mm	-0.44	85.8	-23.4	0.079	0.027	0.250
4369469.6	402723.6	498	3	O	60mm	-0.18	223.6	-7.5	0.080	0.029	0.481
4369459.8	402795.7	2632	3	O	60mm	-0.11	221.5	51.9	0.080	0.023	0.244
4369458.0	402709.4	188	3	O	60mm	-0.17	34.1	37.6	0.081	0.028	0.120
4369473.5	402739.7	972	3	O	60mm	-0.51	260.4	-8.1	0.081	0.026	0.192
4369512.2	402742.2	1053	3	O	60mm	-0.35	173.3	19.2	0.081	0.021	0.095
4369440.4	402753.2	1428	3	O	60mm	-0.07	359.8	-2.7	0.081	0.026	0.139
4369456.8	402759.7	1640	3	O	60mm	-0.21	83.3	0.2	0.081	0.020	0.309
4369457.0	402803.2	2773	3	O	60mm	-0.09	115.3	23.3	0.081	0.024	0.150
4369444.8	402731.6	724	3	O	60mm	-0.12	80.2	12.5	0.081	0.017	0.133
4369500.1	402705.2	122	3	O	60mm	-0.08	128.6	14.4	0.082	0.025	0.142
4369490.3	402727.4	609	3	O	60mm	-0.35	14.6	-179.4	0.082	0.024	0.097
4369489.6	402749.3	1298	3	O	60mm	-0.33	318.9	28.8	0.082	0.026	0.078
4369437.1	402787.9	2452	3	O	60mm	-0.19	27.2	-228.5	0.082	0.025	0.082
4369455.3	402755.2	1483	3	O	60mm	-0.40	34.3	24.6	0.083	0.017	0.070
4369450.4	402768.6	1903	3	O	60mm	-0.31	345.9	30.1	0.083	0.019	0.095
4369419.1	402773.0	2045	3	O	60mm	-0.39	185.0	-1.8	0.083	0.023	0.929
4369421.0	402783.6	2338	3	O	60mm	-0.10	165.1	-11.1	0.083	0.022	0.138
4369476.4	402703.9	95	3	O	60mm	-0.08	218.2	-1.9	0.084	0.024	0.578
4369479.2	402708.8	172	3	O	60mm	-0.57	148.1	-8.8	0.084	0.022	0.314

APG Indirect Fire Area

Northing, UTM 18N, meters	Easting, UTM 18N, meters	Anomaly Number	Disc. Stage/Rank 3 - Ord 2 - Clutter	Class O - Ord C - Clutter	Type	Depth (m)	Azimuth (Deg)	Inclination (Deg)	Length (m)	Radius (m)	MSE
4369489.7	402709.5	187	3	O	60mm	-0.44	175.8	-4.3	0.084	0.020	0.720
4369485.9	402724.3	511	3	O	60mm	-0.19	251.7	19.9	0.084	0.025	0.595
4369443.3	402748.5	1278	3	O	60mm	-0.24	145.6	0.4	0.084	0.026	0.157
4369506.9	402753.1	1419	3	O	60mm	-0.38	93.7	15.1	0.084	0.019	0.122
4369497.2	402766.9	1846	3	O	60mm	-0.11	231.0	7.5	0.084	0.026	0.213
4369419.5	402787.2	2435	3	O	60mm	-0.09	220.7	350.5	0.084	0.019	0.125
4369431.2	402791.6	2541	3	O	60mm	-0.10	244.9	-3.3	0.084	0.021	0.315
4369449.5	402801.7	2745	3	O	60mm	-0.10	207.0	-35.9	0.084	0.026	0.150
4369496.1	402703.9	101	3	O	60mm	-0.22	106.1	148.1	0.085	0.026	0.117
4369487.3	402721.8	457	3	O	60mm	-0.13	26.4	-11.2	0.085	0.022	0.580
4369425.7	402784.9	2379	3	O	60mm	-0.08	119.4	-4.6	0.085	0.028	0.216
4369455.8	402749.5	1310	3	O	60mm	-0.18	164.6	137.5	0.086	0.024	0.135
4369464.7	402775.1	2105	3	O	60mm	-0.20	183.7	2.9	0.086	0.024	0.112
4369430.6	402777.9	2195	3	O	60mm	-0.14	25.5	14.7	0.086	0.026	0.303
4369430.1	402791.8	2544	3	O	60mm	-0.20	244.5	6.9	0.087	0.027	0.213
4369450.7	402795.7	2630	3	O	60mm	-0.10	285.8	2.0	0.087	0.023	0.115
4369473.6	402710.2	186	3	O	60mm	-0.23	353.4	24.2	0.088	0.024	0.244
4369494.3	402753.5	1433	3	O	60mm	-0.19	236.0	-30.1	0.088	0.024	0.100
4369451.3	402807.1	2821	3	O	60mm	-0.45	107.0	-7.4	0.089	0.024	0.202
4369478.1	402736.9	896	3	O	60mm	-0.15	254.6	33.4	0.090	0.022	0.096
4369446.3	402757.6	1570	3	O	60mm	-0.35	62.0	-5.5	0.090	0.026	0.150
4369511.4	402750.6	1339	3	O	60mm	-0.14	181.4	15.0	0.091	0.024	0.097
4369475.4	402765.0	1790	3	O	60mm	-0.30	353.6	159.6	0.091	0.022	0.153
4369469.8	402781.3	2281	3	O	60mm	-0.19	273.0	39.6	0.091	0.023	0.146
4369447.4	402795.3	2621	3	O	60mm	-0.15	188.8	18.3	0.091	0.027	0.111
4369448.7	402796.3	2642	3	O	60mm	-0.12	325.3	139.1	0.091	0.024	0.115
4369519.5	402733.6	786	3	O	60mm	-0.14	355.9	-20.0	0.092	0.025	0.092
4369458.5	402763.2	1734	3	O	60mm	-0.33	262.5	-21.2	0.092	0.026	0.142
4369425.9	402783.1	2328	3	O	60mm	-0.05	30.3	-0.8	0.092	0.024	0.112
4369428.5	402784.4	2366	3	O	60mm	-0.19	333.2	21.4	0.092	0.022	0.186
4369451.5	402794.5	2608	3	O	60mm	-0.13	266.7	29.2	0.092	0.024	0.123
4369452.4	402796.9	2656	3	O	60mm	-0.59	321.5	-7.7	0.092	0.022	0.245
4369506.7	402707.7	162	3	O	60mm	-0.11	206.6	-31.4	0.093	0.025	0.187

APG Indirect Fire Area

Northing, UTM 18N, meters	Easting, UTM 18N, meters	Anomaly Number	Disc. Stage/Rank 3 - Ord 2 - Clutter	Class O - Ord C - Clutter	Type	Depth (m)	Azimuth (Deg)	Inclination (Deg)	Length (m)	Radius (m)	MSE
4369492.7	402760.6	1658	3	O	60mm	-0.03	140.9	8.3	0.093	0.023	0.100
4369478.5	402767.2	1857	3	O	60mm	-0.04	157.3	-24.4	0.093	0.025	0.089
4369452.6	402771.6	1982	3	O	60mm	-0.26	258.8	3.3	0.093	0.024	0.127
4369482.0	402785.9	2408	3	O	60mm	-0.14	129.8	24.2	0.093	0.021	0.130
4369434.3	402792.4	2560	3	O	60mm	-0.13	334.8	24.8	0.093	0.027	0.097
4369506.5	402748.8	1286	3	O	60mm	-0.63	132.7	23.8	0.094	0.022	0.140
4369452.4	402768.8	1910	3	O	60mm	-0.12	350.0	16.0	0.094	0.026	0.118
4369470.6	402783.6	2340	3	O	60mm	-0.14	153.1	15.8	0.095	0.024	0.107
4369484.7	402783.1	2324	3	O	60mm	-0.15	166.4	-28.4	0.096	0.024	0.127
4369479.7	402717.4	388	3	O	60mm	-0.51	242.0	28.4	0.097	0.025	0.227
4369524.6	402738.0	939	3	O	60mm	-0.18	143.4	32.8	0.097	0.022	0.124
4369440.5	402758.3	1589	3	O	60mm	-0.10	356.3	2.7	0.097	0.025	0.234
4369488.6	402704.6	119	3	O	60mm	-0.13	237.5	36.0	0.098	0.022	0.124
4369438.8	402751.6	1376	3	O	60mm	-0.14	118.8	42.6	0.098	0.021	0.223
4369441.0	402780.0	2291	3	O	60mm	-0.17	350.7	2.3	0.098	0.021	0.295
4369439.5	402791.8	2546	3	O	60mm	-0.17	339.6	6.6	0.098	0.024	0.203
4369462.7	402701.1	59	3	O	60mm	-0.10	179.7	-34.5	0.099	0.021	0.088
4369449.7	402809.4	2870	3	O	60mm	-0.16	152.2	-11.9	0.099	0.025	0.124
4369465.3	402729.4	657	3	O	60mm	-0.08	174.6	18.4	0.102	0.022	0.235
4369481.0	402780.0	2248	3	O	60mm	-0.15	163.2	4.0	0.104	0.022	0.115
4369503.2	402710.4	203	3	O	60mm	-0.30	209.1	19.3	0.105	0.023	0.132
4369449.3	402756.7	1532	3	O	81mm	-0.15	183.3	8.1	0.087	0.035	0.407
4369440.2	402756.6	1533	3	O	81mm	-0.22	57.2	6.1	0.087	0.033	0.470
4369448.8	402764.1	1756	3	O	81mm	-0.25	265.8	2.8	0.087	0.036	0.787
4369449.9	402745.8	1183	3	O	81mm	-0.26	187.3	8.6	0.088	0.036	0.652
4369451.7	402745.6	1186	3	O	81mm	-0.17	73.1	30.8	0.088	0.036	0.250
4369432.8	402780.9	2272	3	O	81mm	-0.25	235.1	21.9	0.089	0.036	0.371
4369413.5	402789.6	2467	3	O	81mm	-0.84	154.8	-6.9	0.091	0.034	0.654
4369521.7	402750.8	1346	3	O	81mm	-0.17	22.6	-7.2	0.093	0.028	0.135
4369440.0	402789.8	2478	3	O	81mm	-0.38	255.7	12.5	0.093	0.031	0.157
4369474.3	402710.2	210	3	O	81mm	-0.71	200.0	-66.9	0.094	0.033	0.755
4369482.7	402771.9	1994	3	O	81mm	-0.11	175.8	-11.2	0.094	0.029	0.183
4369461.2	402712.3	238	3	O	81mm	-0.10	162.0	150.4	0.095	0.031	0.293

APG Indirect Fire Area

Northing, UTM 18N, meters	Easting, UTM 18N, meters	Anomaly Number	Disc. Stage/Rank 3 - Ord 2 - Clutter	Class O - Ord C - Clutter	Type	Depth (m)	Azimuth (Deg)	Inclination (Deg)	Length (m)	Radius (m)	MSE
4369513.3	402746.4	1205	3	O	81mm	-0.40	187.4	17.8	0.095	0.031	0.091
4369428.9	402791.2	2526	3	O	81mm	-0.31	358.5	10.8	0.095	0.032	0.356
4369448.1	402808.1	2844	3	O	81mm	-0.39	96.7	24.1	0.095	0.034	0.110
4369414.1	402780.3	2262	3	O	81mm	-0.95	189.7	0.4	0.096	0.033	0.802
4369493.0	402715.3	302	3	O	81mm	-0.28	145.2	19.1	0.097	0.037	0.621
4369484.6	402716.1	316	3	O	81mm	-0.79	357.9	-10.1	0.097	0.027	0.857
4369448.2	402760.7	1677	3	O	81mm	-0.35	349.2	30.2	0.097	0.031	0.130
4369432.4	402780.0	2243	3	O	81mm	-0.21	49.6	9.1	0.097	0.033	0.486
4369461.2	402709.1	179	3	O	81mm	-0.29	148.5	5.7	0.098	0.033	0.108
4369445.9	402772.7	2036	3	O	81mm	-0.11	295.5	3.9	0.098	0.033	0.125
4369441.9	402797.3	2662	3	O	81mm	-0.12	302.0	127.5	0.098	0.029	0.122
4369455.0	402802.5	2769	3	O	81mm	-0.37	104.0	17.4	0.098	0.032	0.153
4369470.7	402706.4	142	3	O	81mm	-0.19	30.2	26.0	0.100	0.036	0.099
4369505.5	402725.7	558	3	O	81mm	-0.42	354.8	14.9	0.100	0.026	0.120
4369512.4	402729.3	637	3	O	81mm	-0.61	73.4	24.7	0.100	0.028	0.203
4369453.3	402766.3	1829	3	O	81mm	-0.37	270.9	-23.1	0.100	0.028	0.098
4369423.0	402784.8	2370	3	O	81mm	-0.38	201.1	16.2	0.100	0.030	0.105
4369493.9	402729.5	655	3	O	81mm	-0.17	170.4	11.7	0.101	0.033	0.174
4369452.4	402739.3	971	3	O	81mm	-0.06	335.4	-2.4	0.101	0.030	0.127
4369437.5	402746.3	1192	3	O	81mm	-0.35	342.2	25.6	0.101	0.031	0.087
4369445.6	402787.7	2455	3	O	81mm	-0.47	309.4	-8.8	0.101	0.033	0.221
4369445.3	402792.6	2561	3	O	81mm	-0.23	317.2	5.3	0.101	0.032	0.249
4369464.4	402734.0	798	3	O	81mm	-0.13	4.9	-4.6	0.102	0.029	0.129
4369463.4	402759.1	1621	3	O	81mm	-0.04	329.8	8.6	0.102	0.028	0.134
4369468.5	402766.7	1841	3	O	81mm	-0.22	292.9	-4.5	0.102	0.037	0.150
4369463.4	402776.6	2162	3	O	81mm	-0.24	204.4	13.4	0.102	0.026	0.168
4369506.7	402721.6	450	3	O	81mm	-0.16	339.0	13.2	0.103	0.036	0.191
4369460.4	402725.5	554	3	O	81mm	-0.18	0.6	-4.4	0.103	0.039	0.231
4369463.9	402755.3	1500	3	O	81mm	-0.14	269.7	-1.0	0.103	0.031	0.382
4369438.8	402759.9	1639	3	O	81mm	-0.28	32.7	20.6	0.103	0.036	0.133
4369401.2	402765.5	1805	3	O	81mm	-0.13	307.5	-12.2	0.103	0.030	0.246
4369471.3	402773.3	2059	3	O	81mm	-0.42	255.3	9.8	0.103	0.032	0.101
4369426.7	402778.8	2213	3	O	81mm	-0.14	249.9	-5.4	0.103	0.035	0.302

APG Indirect Fire Area

Northing, UTM 18N, meters	Easting, UTM 18N, meters	Anomaly Number	Disc. Stage/Rank 3 - Ord 2 - Clutter	Class O - Ord C - Clutter	Type	Depth (m)	Azimuth (Deg)	Inclination (Deg)	Length (m)	Radius (m)	MSE
4369422.7	402790.3	2515	3	O	81mm	-1.02	7.1	2.8	0.103	0.035	0.847
4369435.9	402797.3	2657	3	O	81mm	-0.30	303.3	-31.5	0.103	0.036	0.104
4369468.7	402757.7	1569	3	O	81mm	-0.53	269.1	9.3	0.104	0.032	0.261
4369498.6	402761.9	1700	3	O	81mm	-0.13	236.8	1.3	0.104	0.036	0.109
4369473.0	402763.0	1730	3	O	81mm	-0.55	300.5	-1.5	0.104	0.038	0.141
4369440.9	402802.6	2766	3	O	81mm	-0.25	312.1	-8.4	0.105	0.037	0.110
4369517.0	402751.6	1375	3	O	81mm	-0.12	181.3	6.9	0.106	0.026	0.143
4369462.5	402764.6	1776	3	O	81mm	-0.21	273.9	-10.9	0.106	0.039	0.134
4369466.0	402784.0	2350	3	O	81mm	-0.20	13.5	0.3	0.106	0.038	0.149
4369484.5	402719.5	397	3	O	81mm	-0.98	63.8	-10.2	0.107	0.041	0.779
4369483.3	402733.9	797	3	O	81mm	-0.47	303.2	23.8	0.107	0.034	0.153
4369517.8	402755.2	1488	3	O	81mm	-0.75	124.0	10.3	0.107	0.034	0.191
4369465.3	402757.4	1563	3	O	81mm	-0.59	305.5	0.3	0.107	0.033	0.417
4369410.2	402776.0	2138	3	O	81mm	-0.90	313.2	9.3	0.107	0.040	0.653
4369430.6	402779.3	2194	3	O	81mm	-0.42	7.1	18.9	0.107	0.033	0.136
4369440.1	402785.6	2393	3	O	81mm	-0.48	315.9	-12.7	0.107	0.032	0.097
4369445.5	402787.0	2405	3	O	81mm	-0.52	41.9	-1.5	0.107	0.032	0.481
4369436.9	402804.3	2785	3	O	81mm	-0.47	302.6	-6.7	0.107	0.039	0.160
4369460.2	402697.4	27	3	O	81mm	-0.11	359.7	11.7	0.108	0.033	0.273
4369525.8	402733.3	755	3	O	81mm	-0.40	85.2	14.5	0.108	0.033	0.100
4369488.2	402735.5	849	3	O	81mm	-0.25	234.2	0.0	0.109	0.036	0.131
4369447.2	402766.8	1843	3	O	81mm	-0.20	325.0	4.8	0.109	0.028	0.175
4369466.3	402778.4	2205	3	O	81mm	-0.15	327.4	7.2	0.109	0.035	0.117
4369425.8	402779.8	2233	3	O	81mm	-0.52	12.7	16.7	0.109	0.035	0.352
4369434.1	402790.1	2502	3	O	81mm	-0.39	7.4	-8.4	0.109	0.031	0.105
4369434.4	402788.0	2458	3	O	81mm	-0.25	211.2	-13.4	0.110	0.035	0.106
4369455.2	402805.6	2812	3	O	81mm	-0.44	276.9	5.6	0.110	0.034	0.163
4369519.9	402718.3	364	3	O	81mm	-0.11	240.4	10.8	0.111	0.036	0.157
4369501.5	402731.6	716	3	O	81mm	-0.32	10.5	-8.0	0.111	0.038	0.128
4369513.9	402739.2	973	3	O	81mm	-0.66	4.6	-11.6	0.111	0.034	0.162
4369463.2	402760.8	1670	3	O	81mm	-0.32	238.7	8.5	0.111	0.035	0.119
4369478.3	402777.6	2174	3	O	81mm	-0.23	168.4	-17.3	0.112	0.037	0.119
4369524.5	402745.5	1174	3	O	81mm	-0.49	128.1	-1.4	0.113	0.032	0.115

APG Indirect Fire Area

Northing, UTM 18N, meters	Easting, UTM 18N, meters	Anomaly Number	Disc. Stage/Rank 3 - Ord 2 - Clutter	Class O - Ord C - Clutter	Type	Depth (m)	Azimuth (Deg)	Inclination (Deg)	Length (m)	Radius (m)	MSE
4369436.1	402756.4	1520	3	O	81mm	-0.57	272.7	13.8	0.113	0.033	0.198
4369493.7	402738.3	952	3	O	81mm	-0.17	204.0	-5.1	0.114	0.038	0.153
4369444.7	402749.7	1315	3	O	81mm	-0.55	193.5	-10.1	0.114	0.042	0.100
4369422.5	402780.7	2258	3	O	81mm	-0.24	129.8	1.9	0.114	0.038	0.168
4369443.8	402786.5	2419	3	O	81mm	-0.44	208.7	10.3	0.114	0.036	0.108
4369446.3	402798.1	2675	3	O	81mm	-0.37	315.4	1.4	0.114	0.037	0.103
4369487.0	402729.6	662	3	O	81mm	-0.18	208.7	-23.0	0.115	0.035	0.106
4369443.0	402789.4	2483	3	O	81mm	-0.16	189.5	3.2	0.115	0.039	0.118
4369496.4	402751.6	1377	3	O	81mm	-0.19	217.1	18.3	0.116	0.039	0.118
4369495.8	402748.1	1261	3	O	81mm	-0.19	14.2	-1.9	0.117	0.036	0.088
4369501.0	402762.6	1726	3	O	81mm	-0.17	52.1	0.1	0.117	0.035	0.117
4369426.1	402786.6	2399	3	O	81mm	-0.99	197.9	-53.3	0.117	0.038	0.757
4369437.8	402800.1	2722	3	O	81mm	-0.28	9.4	-11.5	0.117	0.031	0.104
4369446.0	402805.5	2815	3	O	81mm	-0.38	16.4	25.3	0.117	0.034	0.125
4369499.8	402741.5	1029	3	O	81mm	-0.30	29.2	-13.6	0.118	0.035	0.125
4369465.8	402772.3	2018	3	O	81mm	-0.13	239.9	9.1	0.118	0.029	0.193
4369429.3	402787.1	2447	3	O	81mm	-0.27	279.8	-3.5	0.118	0.037	0.169
4369462.3	402773.2	2041	3	O	81mm	-0.68	57.7	14.0	0.119	0.040	0.081
4369425.4	402786.9	2438	3	O	81mm	-0.38	99.4	7.3	0.119	0.035	0.190
4369431.0	402789.7	2491	3	O	81mm	-0.28	340.9	-6.0	0.119	0.037	0.190
4369475.2	402773.0	2046	3	O	81mm	-0.24	275.7	-0.3	0.120	0.034	0.148
4369454.0	402773.1	2054	3	O	81mm	-0.31	21.8	0.6	0.120	0.035	0.132
4369448.1	402789.8	2492	3	O	81mm	-0.42	213.4	10.7	0.120	0.037	0.165
4369473.3	402786.3	2418	3	O	81mm	-0.11	93.2	-19.2	0.122	0.031	0.287
4369470.3	402769.3	1927	3	O	81mm	-0.20	350.8	0.7	0.123	0.039	0.127
4369443.0	402802.1	2748	3	O	81mm	-0.33	331.3	-10.8	0.123	0.036	0.103
4369463.9	402707.0	147	3	O	81mm	-0.12	55.9	14.3	0.125	0.034	0.162
4369445.6	402769.0	1918	3	O	81mm	-0.25	172.3	20.1	0.126	0.035	0.105

Appendix 5

USGS Points of Contact

POINT OF CONTACT Name	ORGANIZATION Name Address	Phone Fax E-mail	Role in Project
Theodore Asch	USGS, Denver Federal Center Bldg. 20, MS-964 Denver, CO 80225	Phone – (303) 236-2489 FAX – (303) 236-1425 Email – tasch@usgs.gov	Project lead
David Wright	USGS, Denver Federal Center Bldg. 20, MS-964 Denver, CO 80225	Phone – (303) 236-1381 FAX – (303) 236-1425 Email – dwright@usgs.gov	Project support in Denver