

Wei Zhang<sup>1</sup>, Wenxin Liu<sup>1</sup>, Frank Ferrese<sup>2</sup>  
<sup>1</sup>New Mexico State University, <sup>2</sup>NAVSEA

# Distributed Optimal Generation Control of Shipboard Power Systems

## ABSTRACT

Traditionally, power system scheduling and control are separately implemented. To bridge the gap between these two activities, online adjustment of the optimal schedule is necessary. Because such adjustment degrades energy efficiency and dynamic response, it is desirable to integrate the two functions seamlessly. One possible solution is to optimize the control references directly. In this paper, a fully-distributed, multi-agent based control solution is presented to reduce the fuel consumption of shipboard power systems. Every generator has an associated agent that only communicates with its neighboring agents. With a properly-designed communication network, the solution can guarantee convergence, even during losses of the communication channel. This fully-distributed design can significantly improve the reliability and survivability of the system, especially during battle conditions. The improved sub-gradient based optimization solution can address both equality and inequality constraints and can provide performance comparable to that of centralized solutions. Simulation studies demonstrate the effectiveness of the proposed solution.

## INTRODUCTION

Optimal generation scheduling is a much-studied problem in power system research. It aims at allocating the power generation to meet the power demand in an economic or profitable way, while continuously respecting the physical constraints of the power system [1-3]. The optimal generation schedule cannot be mapped to the control reference automatically, so online adjustment is necessary. Considering that the adjustment is not optimal, both energy efficiency and dynamic performance will degrade. To improve performance, it is desirable to bridge the gap between power system operation and control seamlessly. One possible solution is to optimize the control reference for generation directly, though doing so places demanding requirements on the speed of the supporting algorithm.

Most existing generation scheduling solutions are centralized [4-5]. As centralized solutions require the

communication and processing of large amounts of global data, they experience difficulty providing a fast response. The delays inherent in centralized decision-making render it unsuitable for online optimization [6], especially when considering the small inertia of a shipboard power system (SPS) and the severe changes in operating conditions. In addition, centralized solutions are inflexible and susceptible to single-point failures [7-8]. Improving the efficiency and survivability of high-performance naval SPSs requires more reliable alternatives. Because distributed solutions can overcome the previously-mentioned disadvantages of centralized solutions, they have attracted much attention in recent years.

To address the needs of SPSs, a fully-distributed, multi-agent system (MAS)-based solution is proposed to optimize the control references of distributed generators online. As one of the most popular distributed control solutions, MAS can provide good reliability and efficiency if properly designed. In the past years, MAS has been applied widely to various SPS problems [9-12]. Even though MAS has tended to be oversold, its potential has not been fully explored. Recent advancements in consensus and cooperative control make advanced MAS-based design possible.

The proposed solution is fully distributed in the sense that each distributed generator has an associate agent that communicates with its neighboring agents only. No centralized or specialized agent is used to coordinate the operation of the autonomous agents. The topology of the communication network for the agents, which is independent of the topology of the power network, is designed based on the  $N-1$  rule. According to the design, any two agents are always connected directly under the loss of one communication channel. Thus, the proposed solution is less susceptible to single-point failures.

Based on the designed communication network, the autonomous agents can realize an improved distributed sub-gradient algorithm. This algorithm is used to optimize the control references directly. Unlike existing distributed sub-gradient algorithms, the improved algorithm can address both equality and inequality constraints. The equality constraints are satisfied by adjusting local generations based on a properly-designed updating rule. The inequality constraints are addressed by constructing a

# Report Documentation Page

*Form Approved*  
*OMB No. 0704-0188*

Public reporting burden for the collection of information is estimated to average 1 hour per response, including the time for reviewing instructions, searching existing data sources, gathering and maintaining the data needed, and completing and reviewing the collection of information. Send comments regarding this burden estimate or any other aspect of this collection of information, including suggestions for reducing this burden, to Washington Headquarters Services, Directorate for Information Operations and Reports, 1215 Jefferson Davis Highway, Suite 1204, Arlington VA 22202-4302. Respondents should be aware that notwithstanding any other provision of law, no person shall be subject to a penalty for failing to comply with a collection of information if it does not display a currently valid OMB control number.

1. REPORT DATE <b>MAY 2012</b>	2. REPORT TYPE	3. DATES COVERED <b>00-00-2012 to 00-00-2012</b>			
4. TITLE AND SUBTITLE <b>Distributed Optimal Generation Control of Shipboard Power Systems</b>		5a. CONTRACT NUMBER			
		5b. GRANT NUMBER			
		5c. PROGRAM ELEMENT NUMBER			
6. AUTHOR(S)		5d. PROJECT NUMBER			
		5e. TASK NUMBER			
		5f. WORK UNIT NUMBER			
7. PERFORMING ORGANIZATION NAME(S) AND ADDRESS(ES) <b>Naval Surface Warfare Center, Carderock Division, Philadelphia, PA, 19112</b>		8. PERFORMING ORGANIZATION REPORT NUMBER			
9. SPONSORING/MONITORING AGENCY NAME(S) AND ADDRESS(ES)		10. SPONSOR/MONITOR'S ACRONYM(S)			
		11. SPONSOR/MONITOR'S REPORT NUMBER(S)			
12. DISTRIBUTION/AVAILABILITY STATEMENT <b>Approved for public release; distribution unlimited</b>					
13. SUPPLEMENTARY NOTES <b>Presented at the Electric Machines Technology Symposium (EMTS) 2012, MAY 23-24 2012, Philadelphia, PA</b>					
14. ABSTRACT					
15. SUBJECT TERMS					
16. SECURITY CLASSIFICATION OF:			17. LIMITATION OF ABSTRACT <b>Same as Report (SAR)</b>	18. NUMBER OF PAGES <b>8</b>	19a. NAME OF RESPONSIBLE PERSON
a. REPORT <b>unclassified</b>	b. ABSTRACT <b>unclassified</b>	c. THIS PAGE <b>unclassified</b>			

virtual communication network during constraint violations. The distributed algorithm is suitable for online optimization and can provide performance comparable to that of centralized solutions. Simulation studies demonstrate the effectiveness of the proposed solution.

This paper is organized as follows. Section II formulates the SPS generation optimization problem. Section III introduces the distributed sub-gradient based optimization algorithm. Section IV addresses the implementation of the MAS-based solution. Section V presents some simulation results, and Section VI summarizes the conclusion.

## PROBLEM FORMULATION

The optimal generation scheduling problem can be formulated as follows:

$$\begin{cases} \min \sum_{i=1}^n P_i \eta(P_i) & \text{(a)} \\ \text{s.t.} \sum_{i=1}^n P_i = P_d & \text{(b)} \\ \text{s.t.} \underline{P}_i \leq P_i \leq \bar{P}_i & \text{(c)} \end{cases} \quad (1)$$

where  $n$  is the number of generators in a shipboard power system,  $P_i$  is the power output of the  $i^{\text{th}}$  turbine generator,  $\eta(P_i)$  is the unit power fuel consumption of the generator,  $P_d$  is the total power demand, and  $\underline{P}_i$  and  $\bar{P}_i$  are the lower and upper bounds of the  $i^{\text{th}}$  generator's output, respectively.

$\eta(P_i)$  is typically an exponential function with respect to power output ( $P_i$ ) and can be expressed as (2) [1]:

$$\eta(P_i) = \varepsilon_0 + \frac{\varepsilon_2 - \varepsilon_0}{1 - e^{-m}} \left(1 - e^{-\frac{P_i - P_{\min}}{P_{\max} - P_{\min}}}\right) \quad (2)$$

Even though the fuel consumption,  $P_i \cdot \eta(P_i)$ , is not a strictly convex function, it can be approximated by a convex function. The polynomial fitting technique introduced in [13] can be utilized to approximate (2) as a convex function. Usually, a second-order polynomial is sufficient, as shown in (3):

$$P_i \cdot \eta(P_i) \approx f_i(P_i) = a_2 P_i^2 + a_1 P_i + a_0 \quad (3)$$

Thus, (1) can be rewritten as (4):

$$\begin{cases} \min \sum_{i=1}^n f_i(P_i) & \text{(a)} \\ \text{s.t.} \sum_{i=1}^n P_i = P_d & \text{(b)} \\ \text{s.t.} \underline{P}_i \leq P_i \leq \bar{P}_i & \text{(c)} \end{cases} \quad (4)$$

In (4),  $f_i(P_i)$  is a convex function with respect to  $P_i$ .

## DISTRIBUTED SUB-GRADIENT ALGORITHM

In the following derivation,  $\mathbf{P} = [P_1, P_2, P_3, \dots]^T$  denotes the vector of the outputs of the generators,  $f(\mathbf{P}) = \sum_{i=1}^n f_i(P_i)$

denotes the objective function, and  $\nabla f(\mathbf{P}) = (\dot{f}_1, \dot{f}_2, \dot{f}_3, \dots)^T$  denotes the sub-gradient of the fuel consumption functions, with  $\dot{f}_i$  denoting the derivative of  $f_i(P_i)$  with respect to  $P_i$ .

If the inequality constraints are ignored, the convex optimization problem (4) will have a unique optimal solution -  $\mathbf{P}^*$ . As given in [14], the optimal conditions are:

$$\mathbf{1}^T \mathbf{P}^* = P_d, \quad \nabla f(\mathbf{P}^*) = \lambda^* \mathbf{1} \quad (5)$$

where  $\mathbf{1}$  is a column vector of ones and  $\lambda^*$  is the unique optimal Lagrange multiplier.

The challenge with the distributed optimization algorithm is how to find  $P^*$  in a distributed way. According to the distributed sub-gradient algorithm, the local updating rule can be represented in a scalar format, as in (6):

$$P_i(k+1) = P_i(k) - W_{ii} \dot{f}_i + \sum_{j \in N_i} W_{ij} \dot{f}_j \quad (6)$$

where  $W_{ii}$  and  $W_{ij}$  are elements of the weight matrix  $\mathbf{W}$ , and  $N_i$  represents the indices of agents that communicate with agent  $i$ .

The overall system's updating process can be represented as:

$$\mathbf{P}(k+1) = \mathbf{P}(k) - \mathbf{W} \nabla f(\mathbf{P}(k)) \quad (7)$$

The algorithm is distributed because local generation is adjusted based on local information only. (7) is listed here to help clarify the overall system's activities.

According to [14], the selection of  $\mathbf{W}$  must yield the following two properties [14]. First,  $\mathbf{P}(k)$  should always be feasible, i.e.  $\mathbf{1}^T \mathbf{P}(k) = P_d$  for all  $k$ . Second,  $\mathbf{P}^*$  should be a fixed point of (7), i.e.,  $\mathbf{P}^* = \mathbf{P}^* - \mathbf{W} \nabla f(\mathbf{P}^*) = \mathbf{P}^*$ . Accordingly,  $\mathbf{W}$  must satisfy the following two properties:

$$\begin{aligned} \mathbf{1}^T \mathbf{W} &= \mathbf{0}^T \\ \mathbf{W} \mathbf{1} &= \mathbf{0} \end{aligned} \quad (8)$$

where  $\mathbf{0}$  is a column vector of zeros.

If  $\mathbf{W}$  is a symmetrical matrix and satisfies one of the above two conditions, then it will satisfy the other condition automatically. In this paper,  $\mathbf{W}$  is adjusted dynamically based on the topology of the communication network. According to the improved Metropolis method [15-16], elements of  $\mathbf{W}$ , i.e.,  $W_{ij}$ , are calculated according to (9):

$$W_{ij}(k) = \begin{cases} -2/[n_i(k) + n_j(k)] & j \in \text{idx}_i(k), j \neq i, n_i \neq 0 \\ -\sum_{j \in N_i} W_{ij}(k) & j = i \\ 0 & \text{otherwise} \end{cases} \quad (9)$$

where  $n_i(k)$  and  $n_j(k)$  are the numbers of elements in  $N_i$  and  $N_j$ , respectively, and  $\text{idx}_i(k)$  is the set of indices of the neighboring buses of bus  $i$ .

Note that the above method only considers the equality constraint of (4.b). Because the inequality constraint is neglected, the resulting solution might be impractical. To avoid violations of inequality constraints, the above sub-gradient algorithm is modified as follows:

$$P_i(k+1) = \begin{cases} P_i(k) & i \in idx_b(k) \\ P_i(k) - \alpha(k) \sum_{j=1}^n W_{ij}(k) \dot{J}_{j,j} & j \in idx_b(k)^c \end{cases} \quad (10)$$

where  $P_i(k+1)$  is the immediate update of  $P_i(k)$ ,  $\alpha(k)$  is the step size,  $\dot{J}_{j,j}$  is the derivative of the local cost function,  $idx_b(k)$  is the set of indices of the generators whose generations lie on the boundary, and  $idx_b(k)^c$  is the complement of  $idx_b(k)$ .

If the calculated generation of a generator lies within the boundary, the actual generation will be updated as usual. If the calculated value falls beyond the pre-set bound, the generation of the corresponding generator will be held fixed and excluded from future updating. Because other agents still need to update, the boundary agent(s) will work as a hub of communication for its neighboring agents. If two neighboring agents are connected indirectly through the boundary agent, that boundary agent will form a virtual direct communication channel. If two neighboring agents also are connected directly, the boundary agent does nothing for them. These operations can be formulated using graph theory.

If the communication network is represented as an undirected graph, this graph's connectivity can be described using an adjacency matrix whose elements  $a_{ij}$  are calculated according to:

$$a_{ij}(k) = \begin{cases} 1 & \text{if } i \text{ and } j \text{ are connected} \\ 0 & \text{otherwise} \end{cases} \quad (11)$$

Thus,  $n_i(k)$  in (9) can be calculated according to (12):

$$n_i(k) = \sum_{j=0}^n a_{ij}(k) \quad (12)$$

During optimization,  $a_{ij}(k)$  is updated dynamically according to (13). The updated  $a_{ij}(k)$  will change the weight matrix  $\mathbf{W}$  indirectly.

$$a_{ij}(k+1) = \begin{cases} 0 & i \in idx_b(k) \text{ or } j \in idx_b(k) \\ a_{ib}(k) \& a_{bj}(k) | a_{ij}(k) & b \in idx_b(k) \text{ and } i, j \in idx_b(k) \\ a_{ij}(k) & \text{otherwise} \end{cases} \quad (13)$$

If properly designed, the solutions obtained by a distributed algorithm will be comparable to those obtained by a corresponding centralized algorithm.

## DISTRIBUTED CONTROL SYSTEM ARCHITECTURE

The distributed control system is illustrated in Fig. 1. Each generator in an SPS is equipped with an agent that communicates with other generator(s) according to the topology of the designed communication network. The agents will optimize the outermost control loop references of the generators for active power control.

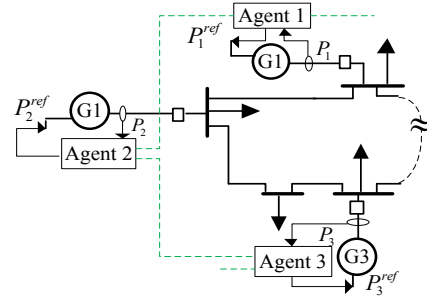

Fig. 1 Control system architecture

The design of the communication network is independent of that of the physical power network. The design of the communication network and the control of the turbine generator are introduced in the following section.

## Communication Network Design

If the communication network is represented as a graph, the communication channels correspond to the edges of the graph. Thus, the edge connectivity of the graph will determine the reliability of the system. The higher the connectivity, the more reliable the network [17-18]. In this paper, the  $N-1$  rule is utilized to design the topology of the communication network.

The  $N-1$  rule dictates that any two nodes are still connected directly when any one of the edges is disabled. In this case, the original graph must contain at least one loop that connects all of the nodes in the graph. For the system illustrated in Fig. 2, loop  $I_3$  can encircle all of the 4 nodes. Thus, the network satisfies the  $N-1$  rule. It can be verified easily that disconnecting any edge will not isolate any of the nodes.

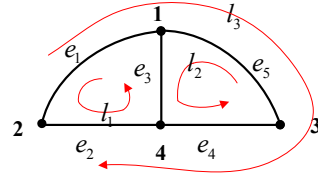

Fig. 2 Simple communication network (graph)

In general, the communication network satisfies the  $N-1$  rule *if and only if* the complete loop matrix (CLM) ( $\mathbf{C}$  for short) of the graph corresponding to the communication network satisfies the following condition:

$$\max_{i=1, \dots, n} \sum_{j=1}^{n_e} C_{ij} = n \quad (14)$$

where  $n_l$  and  $n_e$  are the total number of loops and edges of the graph, respectively, and  $n$  is the total number of nodes.

Now, consider the CLM of the graph depicted in Figure 1.

$$e_1 \ e_2 \ e_3 \ e_4 \ e_5 \mid \sum_{j=1}^5 C_{ij} \quad (15)$$

$$C_1 = \begin{matrix} l_1 \\ l_2 \\ l_3 \end{matrix} \begin{pmatrix} 1 & 1 & 1 & 0 & 0 \\ 0 & 0 & 1 & 1 & 1 \\ 1 & 1 & 0 & 1 & 1 \end{pmatrix} \mid \begin{pmatrix} 3 \\ 3 \\ 4 \end{pmatrix}$$

Because  $l_1$  is composed of  $e_1$ ,  $e_2$ , and  $e_3$ , the corresponding elements of  $C_1$  will be 1, and the remaining elements all will be 0. Three nonzero elements exist in the first row. Similarly, the connections of  $l_2$  and  $l_3$  are described in the second and third rows, respectively.

Because  $\max_{i=1\dots} \sum_{j=1}^5 C_{ij} = 4$ , which is the number of nodes in the network, the communication network satisfies the  $N-1$  rule.

If only  $e_3$  is disconnected, the CLM of the graph is:

$$e_1 \ e_2 \ e_3 \ e_4 \ e_5 \mid \sum_{j=1}^5 C_{ij} \quad (16)$$

$$C_2 = l_3(1 \ 1 \ 0 \ 1 \ 1) \mid (4)$$

Because  $\sum_{j=1}^5 C_j = 4$ , the network still satisfies the  $N-1$  rule.

If only  $e_5$  is disconnected, the CLM of the graph is:

$$e_1 \ e_2 \ e_3 \ e_4 \ e_5 \mid \sum_{j=1}^5 C_{ij} \quad (17)$$

$$C_3 = l_1(1 \ 1 \ 1 \ 0 \ 0) \mid (3)$$

Because  $\sum_{j=1}^5 C_j = 3 < 4$ , the network no longer satisfies the  $N-1$  rule. However, it is easy to verify that the overall network topology is still connected.

If the communication network of the control system is designed based on the  $N-1$  rule, malfunctions of any one of the communication channels will not cause the control system to malfunction. Thus, the distributed optimization process can still operate properly, as will be demonstrated through simulation studies.

## Control of Turbine Generator Sets

Once the active power reference has been optimized by the proposed algorithm, the turbine can be controlled to track the reference in order to control the electric power output of the generator indirectly. The control scheme for the turbine generator set is illustrated in Fig. 3.

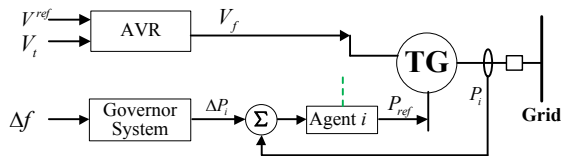

Fig. 3 Control diagram of the generator

As shown in Fig. 3, the input of the optimization system contains two parts, the current output of the generator and the output of the governor system. In a

steady state, the output of the governor system is zero because the algorithm does not alter the total generation during optimization; rather, the optimization control system adjusts the generation among generators according to the current output. In a dynamic state, an unbalance between supply and demand may exist. In this scenario, the output of the governor system is nonzero, and the optimization control system, accordingly, will optimize the generation according to the current power demand (current output plus governor output). Because the governor system can indicate the variation in the power demand, the proposed controller is deployed behind the governor control system to operate according to the updated power demand.

As the system's operating condition continues to change, it becomes more helpful if the algorithm can respond quickly. Compared to centralized solutions, distributed solutions have simpler communication networks and less data to process. Thus, the proposed distributed solution can respond more quickly to changes in operating conditions. If properly designed, both energy efficiency and dynamic response can be improved.

## SIMULATION STUDIES

An SPS shown in Fig. 4 is simulated to test the performance of the proposed solution. The SPS has 4 turbine generators, 2 propulsion motors, 4 zonal load centers and 1 radar load.

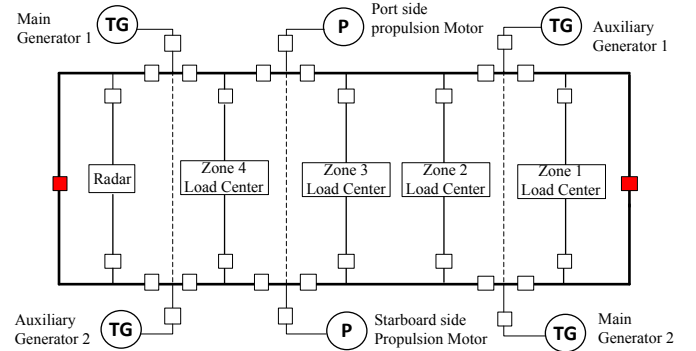

Fig. 4 Test system configuration

The communication network for the proposed control solution is designed as shown in Fig. 5. It consists of 4 nodes (generators/agents) with 6 communication channels. It is easy to verify that the proposed communication network satisfies the  $N-1$  rule. Actually, the communication network can guarantee that the system will operate properly even when any two communication channels are lost. This communication network design helps to improve the reliability and survivability of an SPS.

Parameters of the 4 generators for generation cost minimization are summarized in Tables 1 and 2. During simulation, each generator maintains a minimum of 20% of its capacity in case of a sudden increase in the power demand if the SPS experiences an emergency.

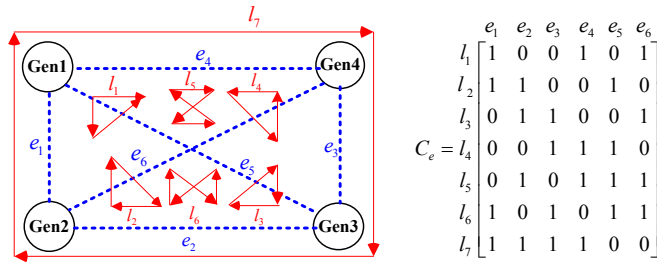

Fig. 5 Communication network topology

Table 1: Parameters of the cost functions

Turbine Power (MW)	Approximated cost functions		
	$a_2$	$a_1$	$a_0$
50	-0.0037133	0.49252	1.3795
13.5	-0.0076707	0.37577	0.18718
20.1	0.0069303	0.58395	-0.41063
7.1	-0.0039909	0.30747	0.07153

Table 2: Parameters of the generators

Num.	Capacity	Minimum	Maximum
1	50	10	50
2	13.5	2.5	7.1
3	20	4	20
4	7.1	1.5	7.1

## Test Case 1

During the first test, a sequence of scenarios is simulated. Originally, the speed of the ship was 20 knots; it accelerated to 21.4 knots within 10 seconds (from 15 s to 25 s). After that, it decelerated to 16.2 knots in 10 seconds (from 25 s to 35 s). The power demanded by the ship's speed and one of its propeller is shown in Fig. 6 (in this test case, the two propellers are assumed to be symmetrical).

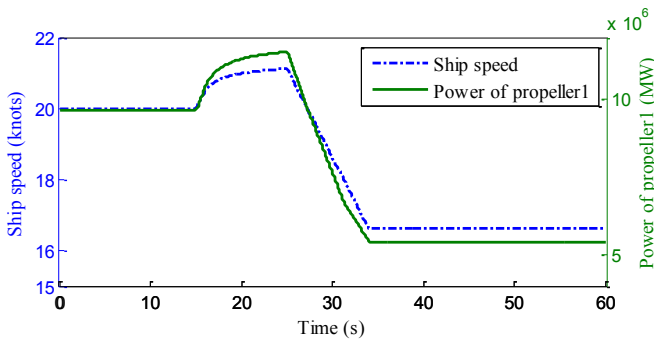

Fig. 6 Ship speed and propeller power

The total load and generation of the system for the duration of the test are shown in Fig. 7.

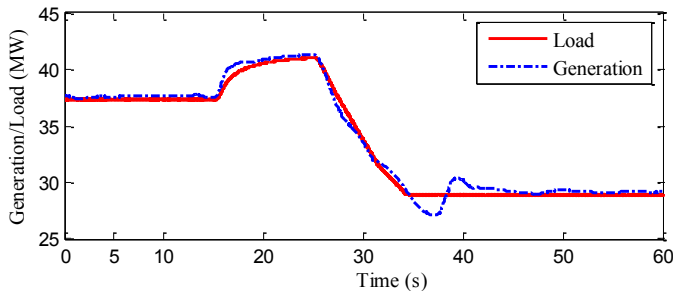

Fig. 7 Total load and generation of the system

The proposed optimal control solution is deployed at 5 seconds. The generation references are updated every 0.1 seconds, which is more than enough to update the reference once according to (10). The optimization results are shown in Fig. 8, which reveals that after the optimization system is turned on, the fuel consumption keeps decreasing until it reaches the minimum at about 15 s. After that, the overall fuel consumption increases during acceleration and decreases during deceleration. Compared with the case in which no optimization occurs, the proposed solution saves approximately 25% more fuel.

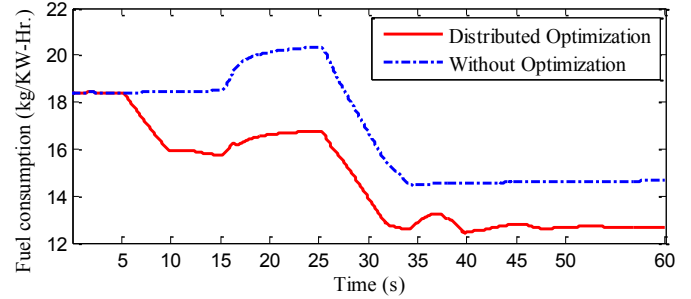

Fig. 8 Fuel consumption with distributed optimization

The active power outputs of the four generators with the proposed solution are shown in Fig. 9.

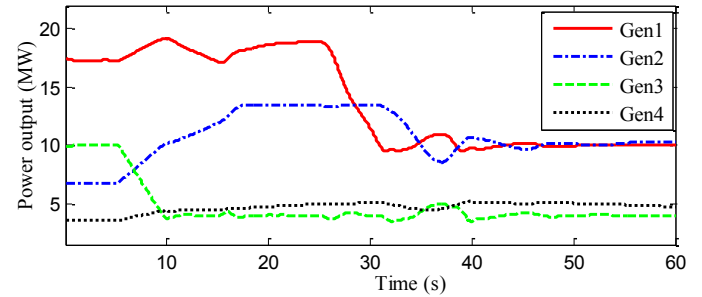

Fig. 9 Active power output of the generators

The frequency and voltage responses are shown in Figs. 10 and 11, respectively. These figures reveal that the system can maintain stability and that the voltage and frequency deviations always fall into the allowable ranges.

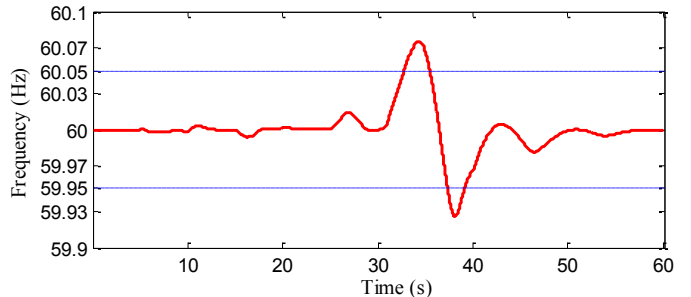

Fig. 10 Frequency response with the proposed solution

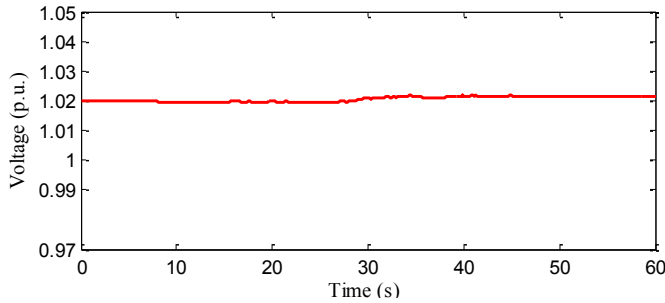

Fig. 11 Voltage response with the proposed solution

## Test case 2

In this test case, two scenarios, the loss of one generator and losses of communication channels, are simulated.

### Loss of One Generator

During simulation, the ship cruises at a constant speed of 20 knots, the proposed solution is deployed at 5 s, and generator 3 is disconnected from the SPS at 20 s. Some simulation results are shown in Figs. 12 and 13.

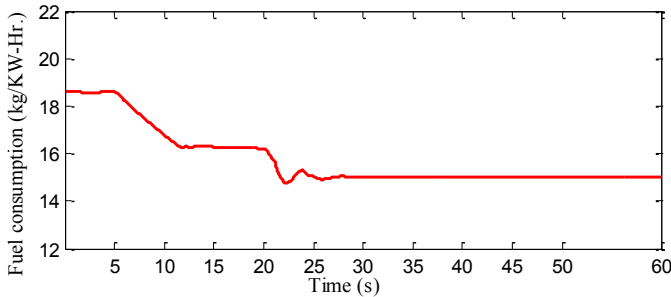

Fig. 12 Fuel consumption profile under generator loss

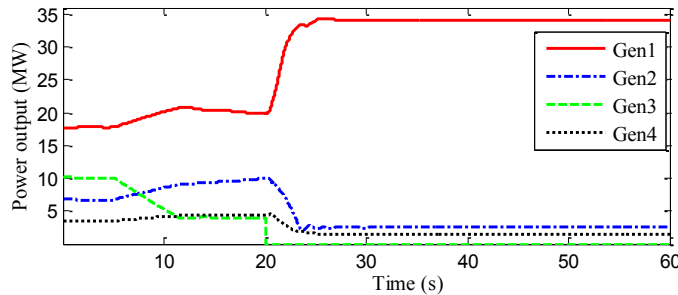

Fig. 13 Active power outputs of the generators

Fig. 12 also shows that the total fuel consumption actually decreases after generator 3 goes offline. It is easy to check that the unit power fuel consumption of generator 3 is relatively high in the range of operation (see Table 1). If generator 3 is online and forced to generate a minimum 20% of its capacity, the total fuel consumption increases.

### Loss of Communication Channels

During simulation, the ship cruises at a constant speed of 20 knots, the proposed solution is deployed at 5 s, and the losses of communication channels occur at 10 s. Some simulation results are shown in Fig. 14.

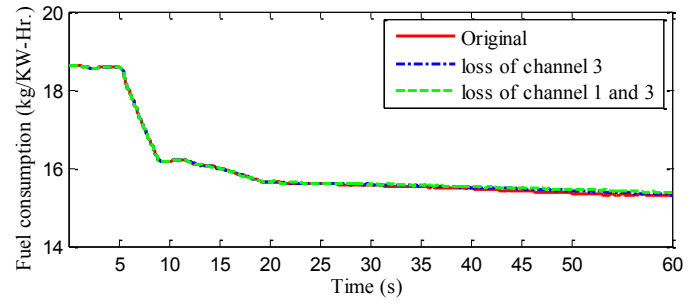

Fig. 14. Optimization results with communication channel losses

Fig. 14 indicates that the two simulated scenarios of communication channel losses did not degrade the control performance significantly. However, fewer communication channels usually translate into slower optimization algorithm convergence speed. Thus, both the algorithm's speed and cost must be considered during communication network design.

## CONCLUSION

A robust distributed control solution for generation cost reduction is proposed for SPSs. The distributed sub-gradient algorithm can be implemented with an MAS framework. A fully-distributed communication network that is robust against communication channel losses can be designed based on the  $N-1$  rule. The distributed solution performs similar to centralized solutions. The proposed solution is stable, efficient, reliable and adaptive. Simulation studies show that the proposed solution is very promising.

## REFERENCES

- [1] W. Wu, D. Wang, A. Arapostathis and K. Davey, "Optimal Power Generation Scheduling of a Shipboard Power System," *Electric Ship Technologies Symposium, 2007. ESTS '07*. IEEE, pp.519-522, 21-23 May 2007.
- [2] K. Davey, "Ship Component in Hull Optimization," *Marine Technology Society Journal*, Vol. 39, No. 2, pp. 39-46, 2005.
- [3] I. Ciornei and E. Kyriakides, "A GA-API Solution for the Economic Dispatch of Generation in Power System Operation," *IEEE Transactions on Power Systems*, Vol.27, No.1, pp.233-242, Feb. 2012.
- [4] J. M. Solanki and N. N. Schulz, "Using intelligent multi-agent systems for shipboard power systems reconfiguration," *Proceedings of the 13th International Conference on Intelligent Systems Application to Power Systems*, 2005, pp. 3, 6-10 Nov. 2005.
- [5] K. Huang, S. K. Srivastava, D. A. Cartes and L. Liu, "Agent Solutions for Navy Shipboard Power Systems," *IEEE International Conference on System of Systems Engineering*, pp.1-6, 16-18 April 2007.
- [6] T. Logenthiran, D. Srinivasan and D. Wong, "Multi-agent coordination for DER in MicroGrid," *IEEE International Conference on Sustainable Energy Technologies*, pp. 77-82, 2008.
- [7] M. Wooldridge, *An introduction to multiagent systems*, John Wiley & Sons, June 2002.
- [8] A. Dimeas and N.D. Hatziargyriou, "Operation of a Multiagent System for Microgrid Control," *IEEE Transactions on Power Systems*, Vol. 20, No. 3, pp. 1447-1455, 2005.
- [9] K. Huang, D. A. Cartes and S. K. Srivastava, "A Multiagent-Based Algorithm for Ring-Structured Shipboard Power System Reconfiguration," *IEEE Transactions on Systems, Man, and Cybernetics, Part C: Applications and Reviews*, Vol.37, No.5, pp.1016-1021, Sept. 2007.
- [10] J. A. Momoh, and O. S. Diouf, "Optimal Reconfiguration of the Navy Ship Power System Using Agents," *IEEE PES T&D 2005/2006*, pp. 562-567, May 21-24, 2006.
- [11] J. A. Momoh, K. Alfred and Y. Xia, "Framework for Multi-Agent System (MAS) Detection and Control of Arcing of Shipboard Electric Power

- Systems,” *15th International Conference on Intelligent System Applications to Power Systems*, pp.1-6, 8-12 Nov. 2009.
- [12] X. Feng; K. L. Butler-Purry, T. Zourmtos and H.-M. Chou, “Multi-agent system-based real-time load management for NG IPS ships in high/medium voltage level,” *Power Systems Conference and Exposition (PSCE), 2011 IEEE/PES*, pp.1-8, 20-23 March 2011.
- [13] J. H. Mathews and K. K. Fink, *Numerical Methods Using Matlab*, 4th Edition, Prentice-Hall Inc., 2004.
- [14] L. Xiao and S. Boyd, “Optimal Scaling of a Gradient Method for Distributed Resource Allocation,” *Journal of Optimization Theory and Applications (JOTA)*, 129(3): 469-488, June 2006.
- [15] L. Xiao, S. Boyd, and S. J. Kim, “Distributed average consensus with least-mean-square deviation,” presented at the 17th Int. Symp. Math. Theory Netw. Syst., Kyoto, Japan, Jul. 24–28, 2006.
- [16] Y. Xu and W. Liu, “Novel Multiagent Based Load Restoration Algorithm for Microgrids,” *IEEE Transactions on Smart Grid*, Vol. 2, No. 1, pp. 152-161, March 2011.
- [17] R. Olfati-Saber, J. A. Fax and R. M. Murray, “Consensus and Cooperation in Networked Multi-Agent Systems,” *Proceedings of the IEEE*, Vol. 95, No. 1, pp. 215-233, Jan. 2007.
- [18] J. A. Bondy and U. S. R. Murty, *Graph theory with applications*, American Elsevier Publishing Co., Inc., 1976.

---

**Wei Zhang** received his B.S. and M.S. degrees both in control science and engineering from Harbin Institute of Technology, China in 2007 and 2009 respectively. Currently, he is pursuing his Ph.D. degree at the Klipsch School of Electrical and Computer Engineering of New Mexico State University, Las Cruces, NM. His research interests include analysis and control of microgrids.

**Wenxin Liu** is currently an Assistant Professor of the Klipsch School of Electrical and Computer Engineering of New Mexico State University, Las Cruces. He received the B.S. and M.S. degrees from Northeastern University, China, in 1996 and 2000, respectively, and the Ph.D. degree in electrical engineering from Missouri University of Science and Technology (formerly University of Missouri-Rolla), Rolla, MO, in 2005. From 2005 to 2009, he was an Assistant Scholar Scientist with the Center for Advanced Power Systems (CAPS) at Florida State University, Tallahassee. His current research interest is focused on fully distributed optimization and control of microgrids with multiple renewable distributed generators.

**Frank Ferrese** works at Naval Surface Warfare Center, Carderock Division, Philadelphia. He conducts research in control theory, computational intelligence, and optimization. He has a BS in Electrical Engineering from Drexel University and an MS in Computer Engineering from Villanova University.