

Structural Design of Dual-Mode Ramjets and Associated System Issues (Conception structurale des statoréacteurs mixtes et défis “système” associés)

Marc BOUCHEZ

MBDA France
Rond-point Marcel Hanriot, route d’Issoudun
18020 Bourges
FRANCE

marc.bouchez@mbda-systems.com

ABSTRACT

The RTO-AVT-VKI course “HIGH SPEED PROPULSION: ENGINE DESIGN – INTEGRATION AND THERMAL MANAGEMENT” was given at the Von Karman Institute in September 2010 and in the Wright State University (Dayton, Ohio) in early December 2010. The present lecture deals with the overall system analysis of scramjets, considering what is the optimum number of engine modules; comparison between fixed or movable geometry; effect of engine mass and size to on-trajectory-performance of an air-breathing space launcher... The results are based on published information, and additional details, presented to the lecturers, can be found in the references.

RÉSUMÉ

Le stage RTO-AVT-VKI “HIGH SPEED PROPULSION: ENGINE DESIGN – INTEGRATION AND THERMAL MANAGEMENT” fut donné à l’Institut Von Karman en septembre 2010 et à l’Université Wright de Dayton (Ohio, USA) début décembre 2010. Le présent cours aborde l’analyse système globale des superstatoréacteurs, considérant par exemple le nombre optimal de modules propulsifs, la comparaison entre une géométrie fixe ou mobile, l’effet de la masse du système propulsif en regard de ses performances ou une façon de faire les compromis entre les différents paramètres lors d’un dimensionnement sur trajectoire d’un lanceur spatial aérobie générique. Il est basé sur des informations publiées, et des détails supplémentaires, présentés aux personnes qui suivaient le cours, pourront être trouvés dans les références bibliographiques.

INTRODUCTION

Nomenclature

a	Thickness of I-beam flanges
b	Thickness of I-beam web
d	Distance between I-beam webs
hg	heat convection coefficient (W/m ² /K)
Mf	Flight Mach number
P	Pressure for panels sizing
Taw	Adiabatic wall temperature (K)
Tw	Hot wall temperature
re	leading edge radius
σ_{limit}	Maximum strength (MPa)

Report Documentation Page

Form Approved
OMB No. 0704-0188

Public reporting burden for the collection of information is estimated to average 1 hour per response, including the time for reviewing instructions, searching existing data sources, gathering and maintaining the data needed, and completing and reviewing the collection of information. Send comments regarding this burden estimate or any other aspect of this collection of information, including suggestions for reducing this burden, to Washington Headquarters Services, Directorate for Information Operations and Reports, 1215 Jefferson Davis Highway, Suite 1204, Arlington VA 22202-4302. Respondents should be aware that notwithstanding any other provision of law, no person shall be subject to a penalty for failing to comply with a collection of information if it does not display a currently valid OMB control number.

1. REPORT DATE SEP 2010		2. REPORT TYPE N/A		3. DATES COVERED -	
4. TITLE AND SUBTITLE Structural Design of Dual-Mode Ramjets and Associated System Issues (Conception structurale des statoréacteurs mixtes et défis système associés)				5a. CONTRACT NUMBER	
				5b. GRANT NUMBER	
				5c. PROGRAM ELEMENT NUMBER	
6. AUTHOR(S)				5d. PROJECT NUMBER	
				5e. TASK NUMBER	
				5f. WORK UNIT NUMBER	
7. PERFORMING ORGANIZATION NAME(S) AND ADDRESS(ES) MBDA France Rond-point Marcel Hanriot, route d'Issoudun 18020 Bourges FRANCE				8. PERFORMING ORGANIZATION REPORT NUMBER	
9. SPONSORING/MONITORING AGENCY NAME(S) AND ADDRESS(ES)				10. SPONSOR/MONITOR'S ACRONYM(S)	
				11. SPONSOR/MONITOR'S REPORT NUMBER(S)	
12. DISTRIBUTION/AVAILABILITY STATEMENT Approved for public release, distribution unlimited					
13. SUPPLEMENTARY NOTES See also ADA564620. High Speed Propulsion: Engine Design - Integration and Thermal Management (Propulsion a vitesse elevee : Conception du moteur - integration et gestion thermique)					
14. ABSTRACT The RTO-AVT-VKI course HIGH SPEED PROPULSION: ENGINE DESIGN INTEGRATION AND THERMAL MANAGEMENT was given at the Von Karman Institute in September 2010 and in the Wright State University (Dayton, Ohio) in early December 2010. The present lecture deals with the overall system analysis of scramjets, considering what is the optimum number of engine modules; comparison between fixed or movable geometry; effect of engine mass and size to on-trajectory-performance of an airbreathing space launcher... The results are based on published information, and additional details, presented to the lecturers, can be found in the references.					
15. SUBJECT TERMS					
16. SECURITY CLASSIFICATION OF:			17. LIMITATION OF ABSTRACT SAR	18. NUMBER OF PAGES 20	19a. NAME OF RESPONSIBLE PERSON
a. REPORT unclassified	b. ABSTRACT unclassified	c. THIS PAGE unclassified			

Acronyms

CMC	Ceramic matrix composite
DCT	Double Col Thermique
DMR	Dual-Mode Ramjet
DOF	Degrees Of Freedom
FEM	Finite Element Method (structures)
FSR	Full Scale Ramjet
HPE	Heat Protective Element
MAI	Moscow Aviation Institute
PAO	Protection Against Oxidation
RBCC	Rocket Based Combined Cycle
RSL	Reusable Space Launchers
SSTO	Single Stage to Orbit
TOW	Take-Off Weight
TSTO	Two Stage to Orbit
WRR	Wide Range Ramjet

Introduction

NASA, DOD, the U.S. industry and global community have studied scramjet-powered hypersonic vehicles for over 40 years, as it can be shown for example in the references ^{1, 2, 3, 4}.

In a large part of the flight regime, the air-breathing mode appears to be a good solution for future Reusable Space Launchers (RSL). Dual-mode ramjets have been studied to propel such TSTO (Two Stage To Orbit) or Single Stage To Orbit (SSTO) vehicles, or other kind of hypersonic vehicles.

For example, in the scope of the French PREPHA program, the study of a generic SSTO vehicle led to conclusion that the best type of airbreathing engine could be the dual-mode ramjet (subsonic then supersonic combustion)^{5, 6}.

Two main ways of approach are possible for the DMR: a fixed or a highly variable geometry. The propulsive performance (thrust, consumption) of the DMR have to be optimised, computed and at-best demonstrated.

But a major concern is the capacity to build such an engine, and to estimate its robustness and its weight.

Vehicle performance analysis, even simplified, is required to do the trade-off of all these characteristics of the propulsion system.

EXAMPLES OF DUAL-MODE RAMJETS

Propulsion for RLV and High Speed Aircraft

Within most of the studies, the dual-mode ramjet has to operate on a wide part of the SSTO trajectory (typically Mach 3 or less to Mach 10 or more). Otherwise it does not pay off its weight (SSTO with only subsonic combustion ramjets associated with rocket engines are generally considered as non-very competitive to full-rocket vehicles). Then, the dual mode ramjet has to have an air intake with a movable geometry (at least the cowl, often the ramps).

The typical height of the whole dual-mode ramjet is between 2.4 and 3 m at maximum capture, the typical total width is 10 m (could be divided in several modules), the engine length (internal duct only) is 5 to 6 m.

During the PREPHA studies, combustor with variable air intake but quite fixed geometry combustor had been chosen, mainly to be conservative on the engine technology. Some engines have been evaluated, such as “B1”, “B2” and “DCT” which was the final one in PREPHA⁷.

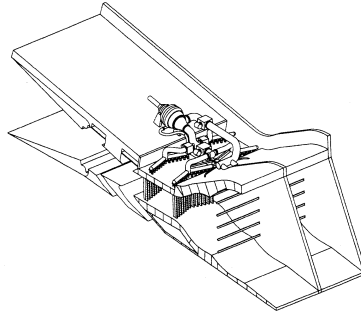
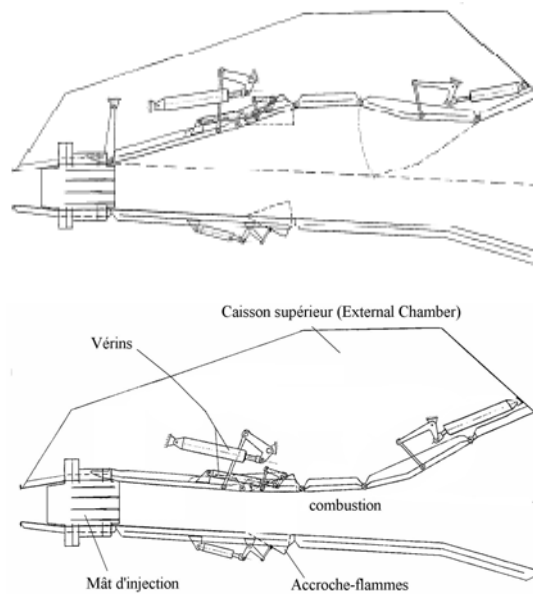

Figure 1: DCT engine (2 modules).

As the opposite, within the MBDA-FRANCE/MAI “WRR” partnership⁸, the studies have led to the concept of a Wide Range Ramjet with variable geometry. The air intake is variable, with a fixed throat. The combustor is variable also, and it is a dual-fuel engine. A sketch of the WRR engine is shown Figure 2.



**Figure 2: Scheme of WRR concept (above: Mach 3 geometry,
below: geometry for flight Mach numbers over 7).**

WRR concept engines are designed to be able to propel a PREPHA class vehicle or SSTO launchers (typical TOW of 450 to 600 tons) and thus referred as « Full Scale Ramjet » (FSR). The height of the duct at the entrance of the FSR combustor is about 0.66 m.

Propulsion for Axisymmetric High Speed Vehicles

In some of the advanced studies, the shape of the vehicle is mostly axisymmetrical, and the movable geometry ramjet is more deeply integrated in the overall structure.

The variable geometry can be limited to a single degree of freedom, of rotating or –the example chosen here- in translating a cowl that modifies simultaneously the minimum cross section of the air intake and the combustor geometry. This solution, which is suitable for 2D engines and vehicles⁹, is also particularly adapted for axisymmetric vehicle.

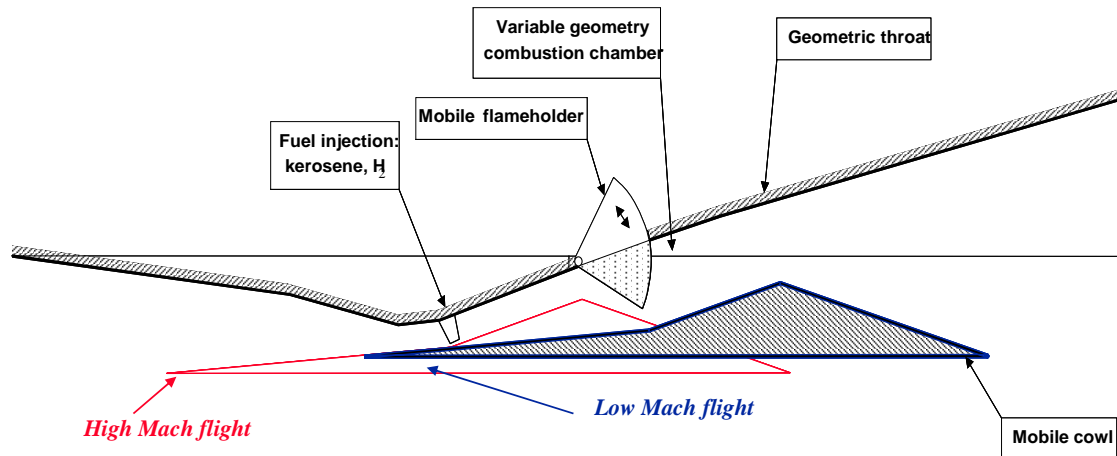

Figure 3: Translating cowl DMR concept.

This concept is then used for the LEA experimental flight vehicle and can be used on the PREPHA-type vehicles, but also for other studies such as one of the LAPCAT high speed aircraft projects¹⁰ or the nano-launcher project¹¹.

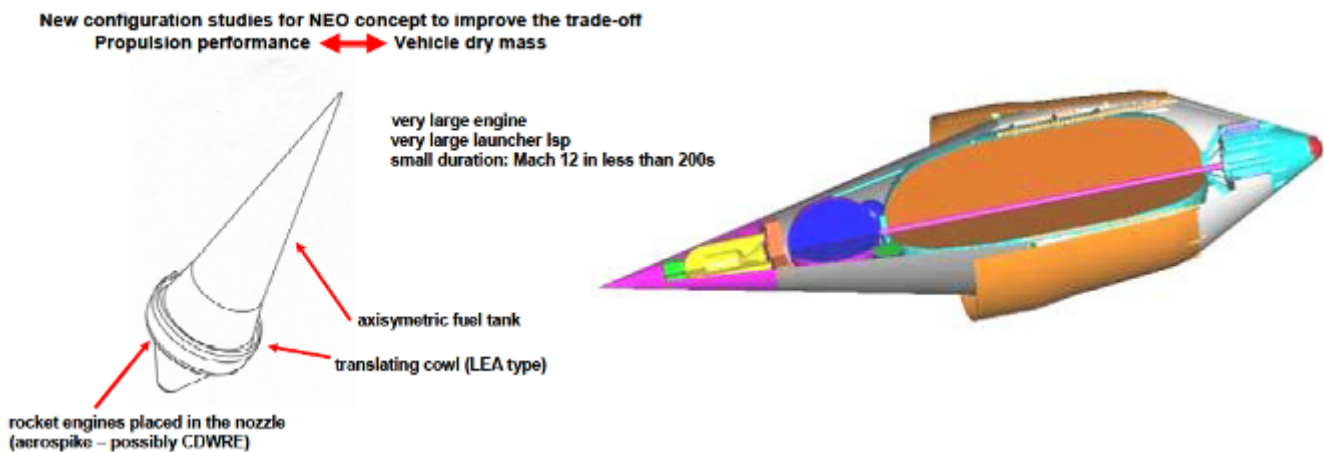

Figure 4: Space nano-launcher project with translating cowl DMR.

Cooled Structures

The high speed, in conjunction with combustion heat release and ‘close box effect’ of the DMR engine requires actively cooled structures. Different solutions are under study worldwide and are described for example in other lectures of the present course, such as¹². These structures are considered here for the integration, weight and mechanical point of view.

SYSTEM ASSESSMENT TECHNIQUE

An analysis method has to be used to assess the effect of an increase (or a decrease) of performance and/or weight on the mission, for example on the “computed payload” for a SSTO or a RLV. Once the performance (thrust, consumption, weight) is identified as a function of flight Mach number and as size (geometrical capture area A_c), a parametric generic vehicle is used to compute the mission and the resulting masses.

Different study levels can be used; a simple but efficient approach for trends studies is described here.

Engine Performance Data Set

Two examples are given below.

The reference PREPHA dual-mode ramjet has a movable geometry inlet (mandatory to operate from Mach 2 to Mach 12) but a fixed geometry combustion chamber.

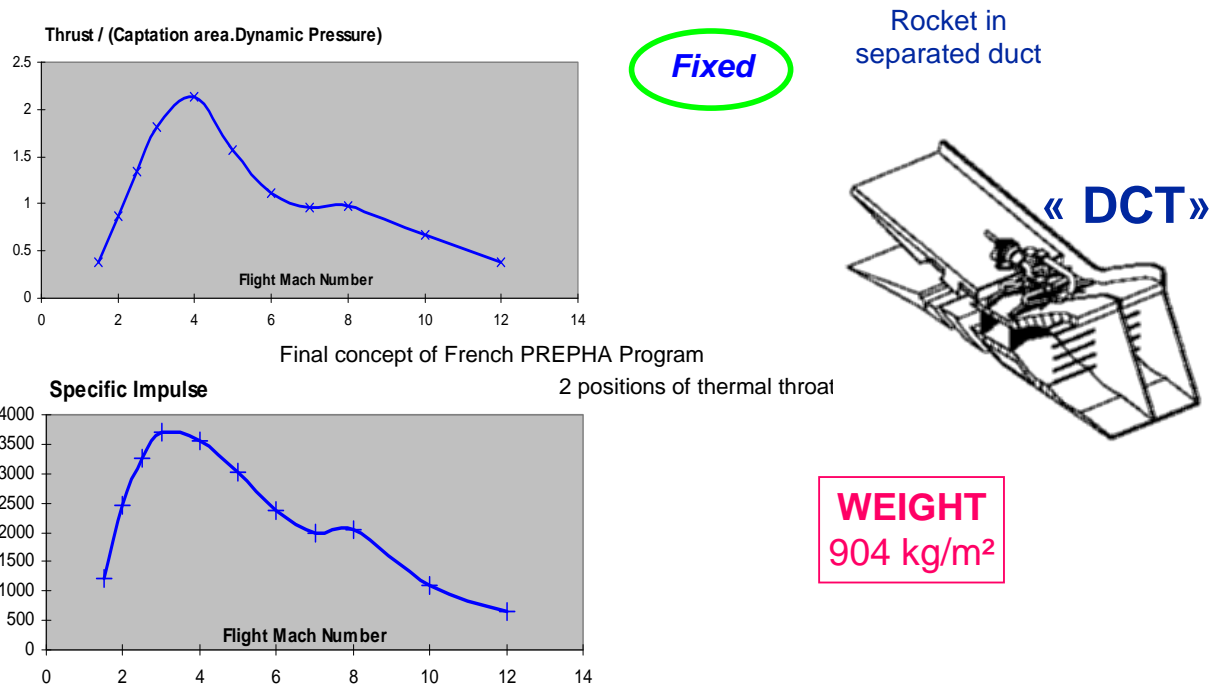

Figure 5: Performance data set of DCT dual-mode ramjet (fixed combustor).

The data set of Wide Range Ramjet variable geometry concept gives logically higher performance and mass.

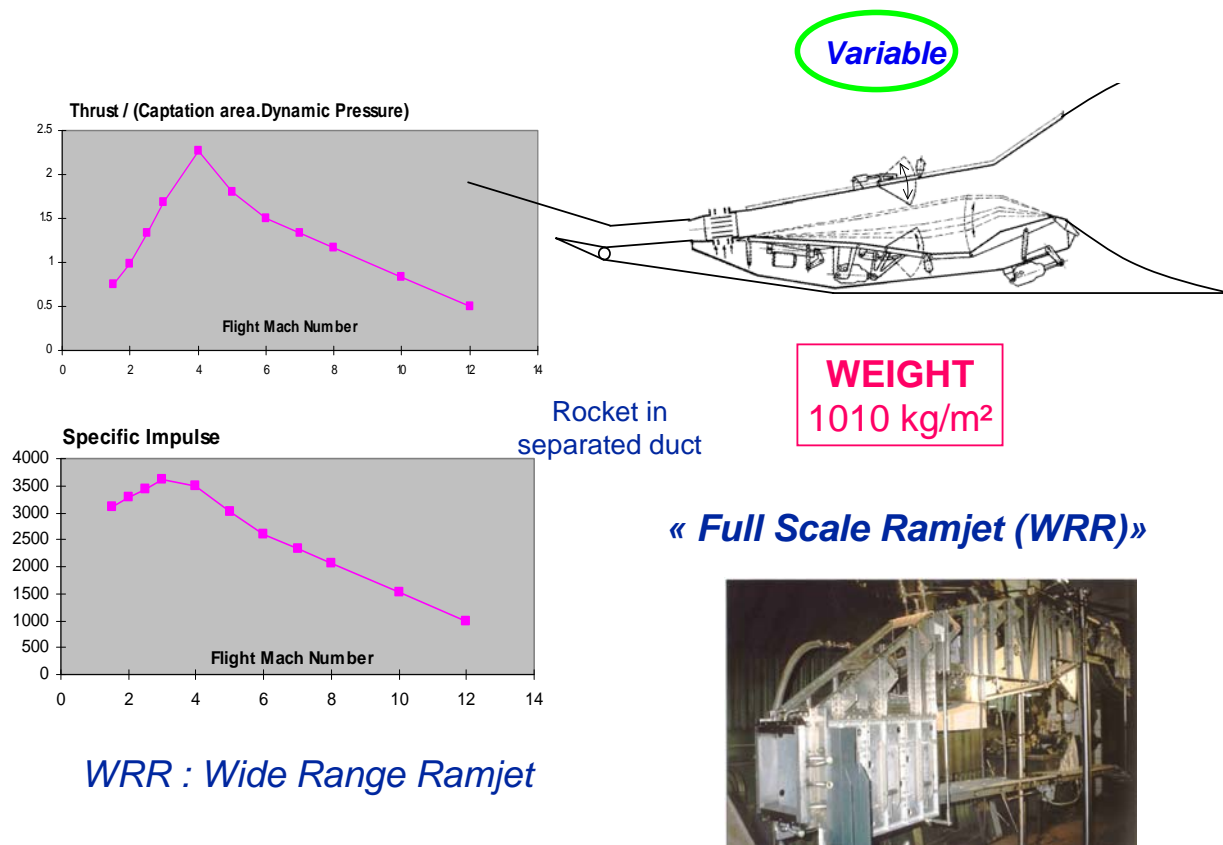

Figure 6: Performance data set of WRR propulsion system.

Example Of System Analysis Tool

The increase of payload of a future SSTO reusable launcher must be quantifiable from the expected performance of the dual-mode ramjets in case of variable or fixed geometry.

Thus, advanced studies have been carried out at MBDA-FRANCE to assess the potential interest of the variable geometry. Simple parametric calculations have been made on trajectories and weight breakdowns of a “rubber” generic SSTO vehicle. These kinds of studies had been performed in France within the framework of the PREPHA program⁶. MBDA-FRANCE/MAI partnership led to continue these studies focused on the propulsion point of view (no change of the “rubber” generic SSTO). Details can be found in Joint Propulsion Conference papers, presented in 1998¹³, 1999¹⁴ and 2000¹⁵.

Summarised in Figure 7, the iterative process is based on 3-DOF computer code using a rubber SSTO vehicle. This method was validated in particular with more detailed studies performed in PREPHA program¹⁶. The target is 80 km x 500 km (before circularisation), 28.5° for the PREPHA-type SSTO generic vehicle.

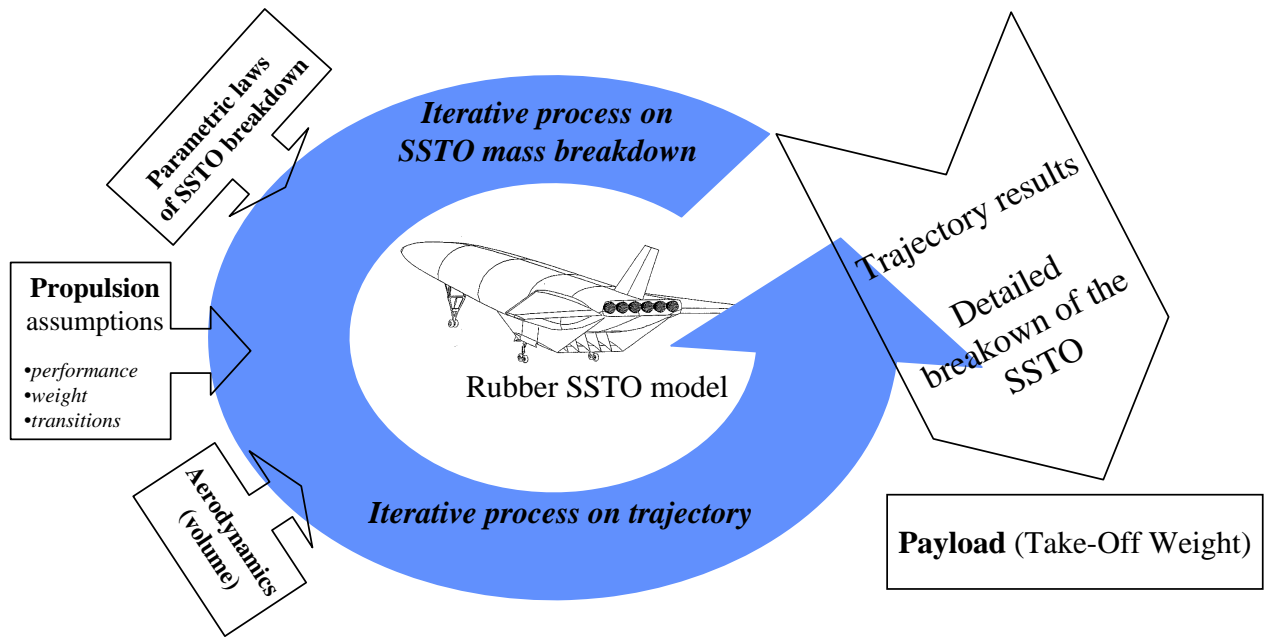

Figure 7: Methodology for propulsion oriented analysis of SSTO payload as a function of Take-Off Weight.

Before to compare designed engines, a study had been made to check the possible interest of having a movable geometry combustor. The “B2” fixed combustor DMR computed performance was compared with a rubber (“caoutchouc”) dual-mode ramjet : its “rubber” geometry was optimized without any concern of feasibility, except the fact that the inner pressure was limited to 5 bar to avoid too heavy system. The result shows a big difference in computed payload, so the actuators and movable geometry system mass increase will not exceed the performance benefit of a movable geometry.

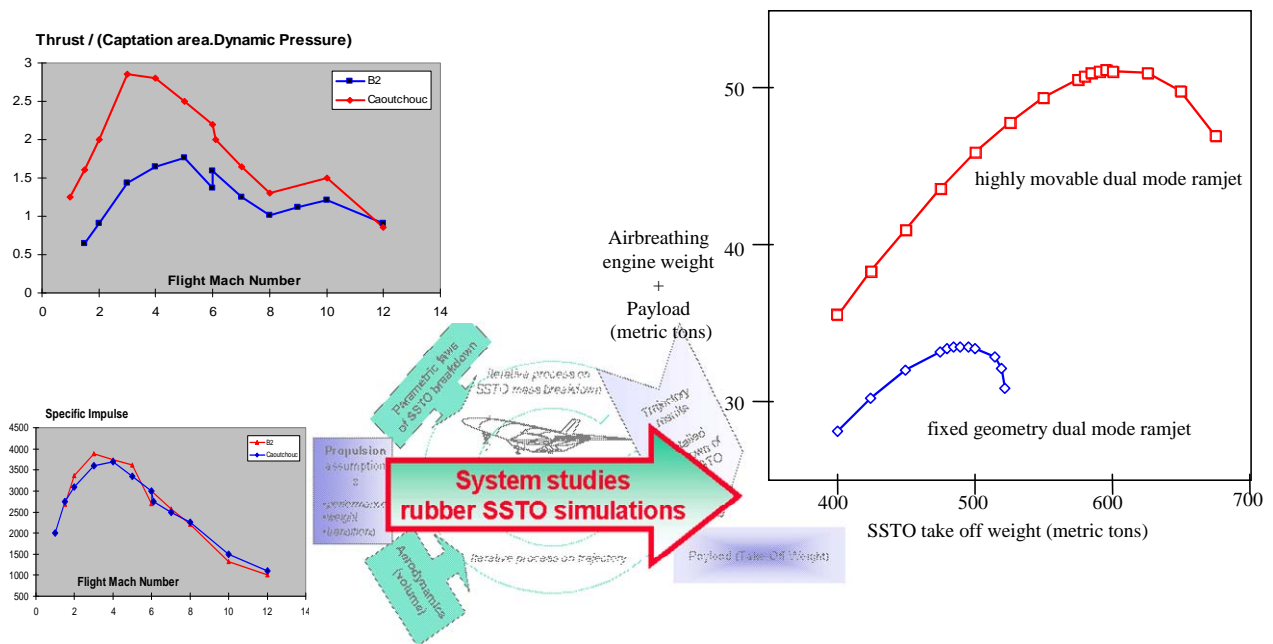

Figure 8: System comparison: potential interest of movable geometry.

MECHANICAL DESIGN

Design Methodology

The current projects conducted by MBDA-FRANCE and its partners and several years of study by young mechanical engineers led to create in the 1990's a user's guide for non-axisymmetric hot ducts, with:

- Analysis of the available literature.
- Selection and development of advanced-study-level structural methods.
- Comparison with Finite Element Method 3D computation of such a 2D engine module.
- Comparison with available experimental studies.

Some examples are given below and in the references.

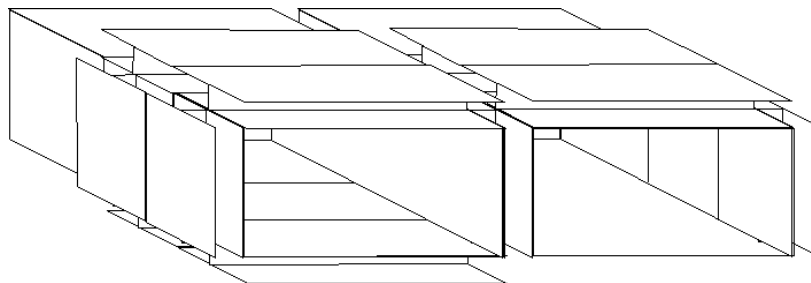

Figure 9: Preliminary mechanical analysis of DMR modules.

This methodology is based mainly on the optimisation of a structure (minimisation of the structural weight) using quick formulas.

Each wall is separately designed after modelization as a succession of I-shape beams. Each I-beam is defined to withstand the internal pressure P in the duct. Some minimum values for thickness are used such as $a=1$ mm or $b=2\%$ of the height of the I-beam to prevent from buckling. The maximum distance d between I-beams (of maximum affordable stress σ_{limit}) is given by the formula for a given flange thickness a :

$$d_{max} = a \times \sqrt{\frac{2 \times P}{\sigma_{limit}}}$$

After such a preliminary design, 2D or 3D FEM codes are used to take into account the 3D effects, the non-isotropy or the temperature-dependency of the materials.

Typical Material Characteristics

Two generic materials are used here to represent the two families of studied materials: Inconel 718 and Carbon/carbon composite materials, the last one assumed to be isotropic (!) and protected against oxidation. Table 1 shows the generic characteristics used for first level advanced studies; refinement is used for more detailed studies.

Table 1: Generic materials assumptions.

		Inconel 718	Carbon-carbon or CMC composite
density	kg/m ³	8150	1600
Limit (traction/compression)	MPa	1050	180
Limit (shear)	MPa	525	20
Young modulus	GPa	150	70

Example of Results

This method has been applied to a small size dual-mode ramjet (missile or experimental vehicle), two different solutions have been investigated thanks to structural advanced analysis: one module of 414 mm width for the combustor or 2 modules of 212 mm. The two different kinds of generic materials were considered. The internal pressure for assumed to be 0.5 MPa. The results were the following:

Table 2: Comparison of the effect of technology and number of modules for a small combustor.

Type	Inconel 718	Carbon-carbon or CMC
1*414 mm	45 kg	35 kg
2*212 mm	33 kg	23 kg

In this particular case, the preferable concept appears to be the two modules one. The benefit thanks to the use of carbon/carbon structures has been estimated to be about 30%, with these assumptions.

The DCT combustor has been extensively studied by MBDA-FRANCE by using these methods. With an internal pressure of 0.5 MPa and a choice of 6 modules, the typical height of the panels is 100 mm, and the distance between I-beams is 100mm.

Mechanical Characterization of the Chosen Structure

During the development phase, and even during the advanced study, some mechanical characterization and mechanical study have to be performed.

An example is given with the fuel-cooled composite PTAH-SOCAR structure. Basic samples are manufactured and tested (in the figure below, it is a bending test in cold conditions) and computed with same tools that are used for the engine system study.

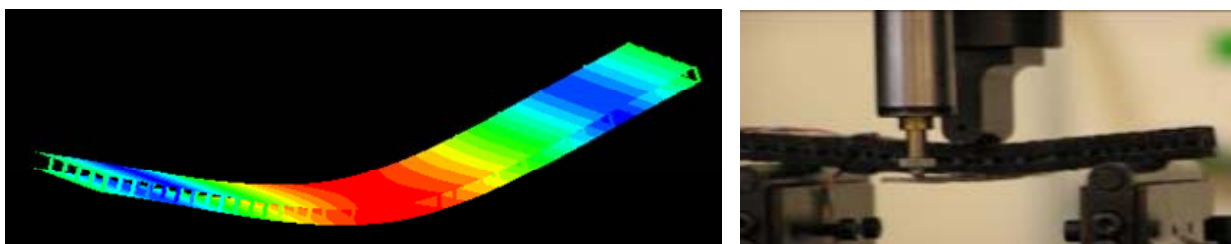

Figure 10: Example of mechanical characterization and associated computations.

As soon as possible, a realistic demonstration has to be built and characterized under relevant boundary conditions.

A characteristic example is given here on the PTAH-SOCAR composite technology.

The FEM computations were made, before the manufacturing and the test of a concept of fuel-cooled 2D PTAH-SOCAR duct, with two approaches: a 3D homogeneous one with an engineering tool (CASTOR/CONCEPT code from CETIM) and a 3D anisotropic one (SAMCEF code) ¹⁷.

Results can be shown in the figures below.

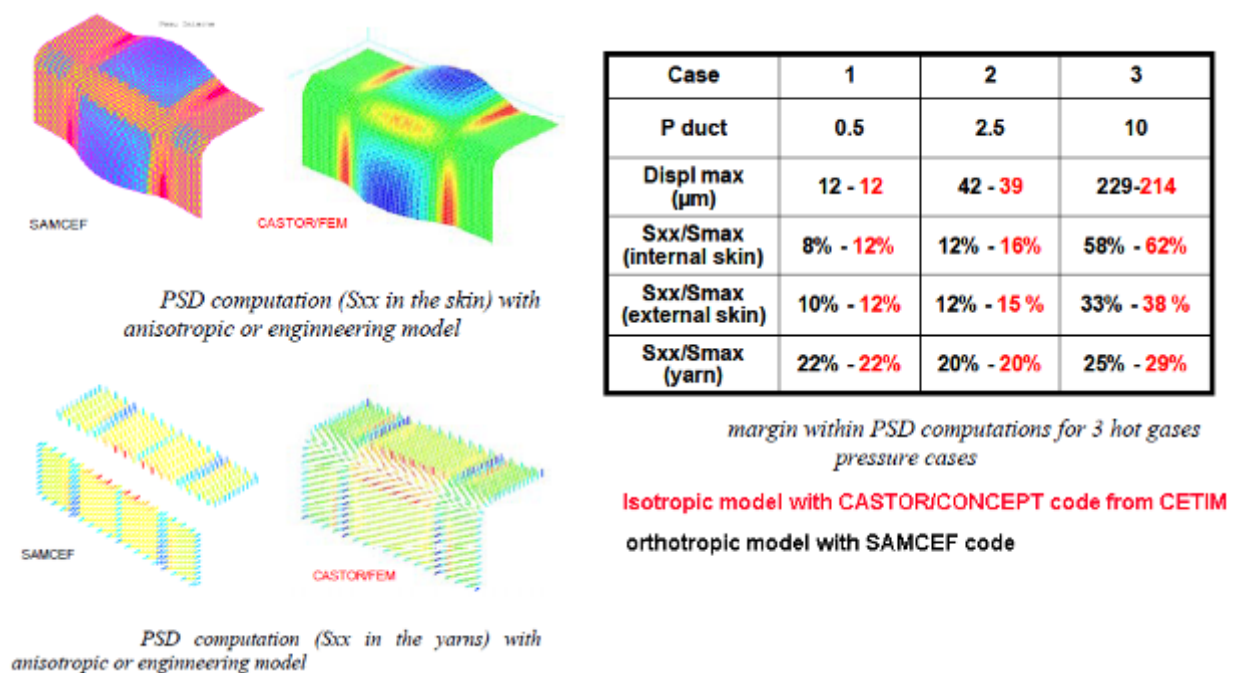

Figure 11: Example of fuel-cooled scramjet duct mechanical 3D computations.

The PSD ducts were then manufactured and tested in cold and hot conditions. For advanced studies, the agreement is quite good between computations and measurements¹⁸.

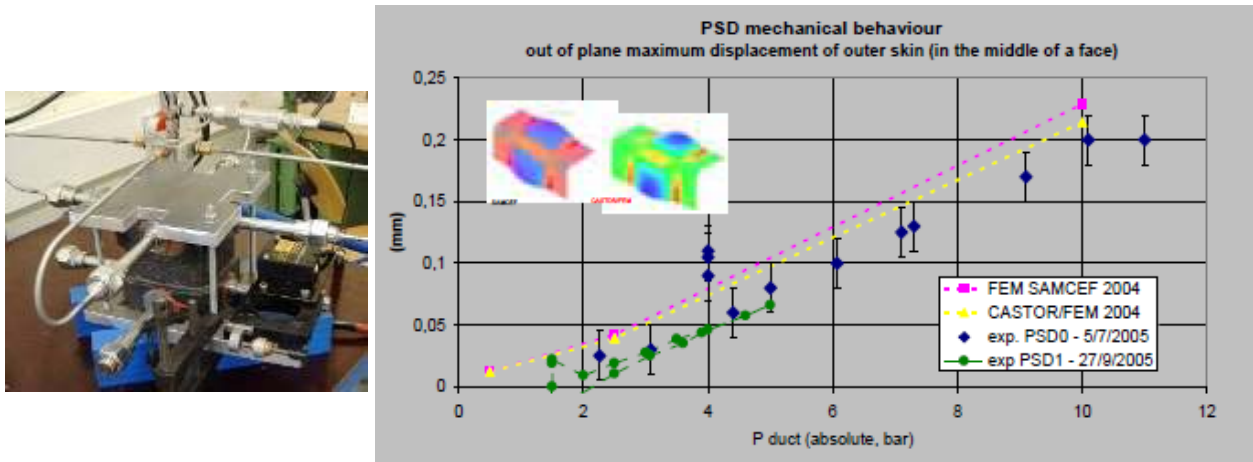

Figure 12: Example of mechanical test and computations of actual scramjet fuel-cooled composite structure.

WEIGHT OF DUAL-MODE RAMJETS

Metallic Structures

The DMR performance (thrust, specific impulse, ...) has to be completed with engine weight. This weight is preferably taken as a function of its capture area (mostly assumed to be linear).

Metallic structures were assumed as a basis for the PREPHA and WRR studies.

For example, the main technological assumptions for the FSR engine (of movable WRR type) are presented in detail in ¹³ and summarised on Table 3.

Table 3: Assumptions for FSR mass estimation.

Technology assumptions for FSR

Type of element	Technology	Weight
Heat Protection Elements	convective cooling	12 kg/m ²
Structural plates	TiAl-alloy	21 kg/m ²
Fuel injection struts	Refractory steel	25 kg/m ²
Actuators (e.g. 120 tons)	Available technology	320 kg

The parameter of engine weight per air intake capture area (kg/m²) is often used to compare several concepts.

With the assumptions detailed in ¹³, the comparison is the following:

Table 4: Specific weight of several DMR for SSTO.

concept	kg/m ²	type
PREPHA "B1"	1000	DMR with ejectors (RBCC) and movable nozzle throat
PREPHA "B2"	900	DMR with fixed combustor
FSR	1015	WRR
PREPHA "DCT"	905	DMR with fixed combustor and two positions of thermal throat

Even with a fixed geometry combustor, it seems difficult to obtain an airbreathing engine weight of much less than 1000 kg/m² of capture area.

The assumption of linearity of weight with capture area A_c has been validated in the required range for the DCT: mechanical design has been done for this engine for assumptions of 24 to 30 m² of capture area and for 4, 6 and 8 modules, with I-panels with a height of 100 mm (Inconel 718).

Typical Mass Budget of WRR Movable Geometry Engine

Typical distribution of mass of a movable geometry DMR, extracted from previous studies¹³, is summarised on Figure 13.

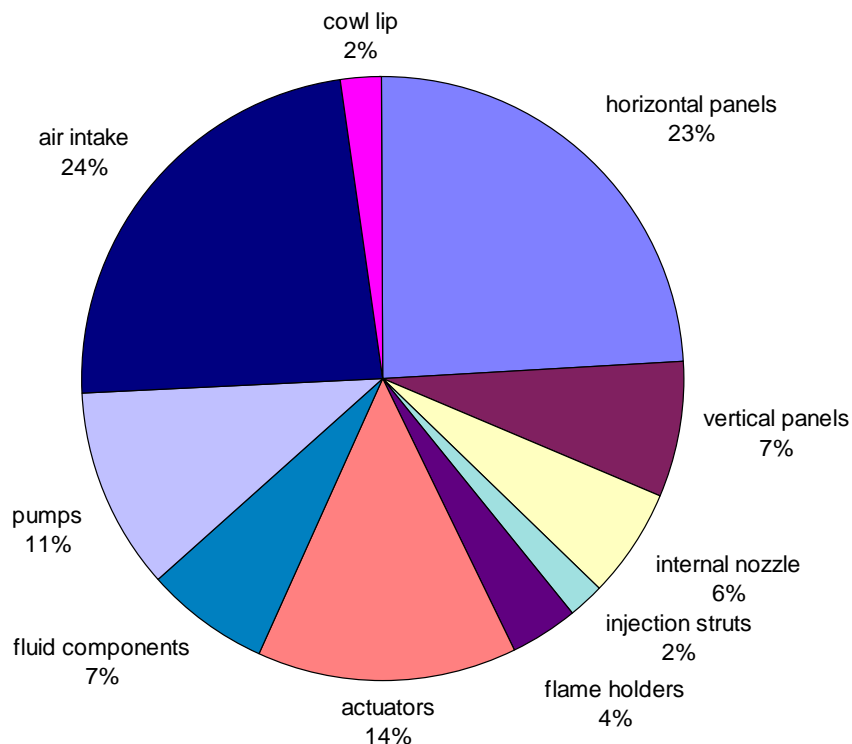

Figure 13: Mass budget of a FSR.

Considering only the combustor in this FSR example, for the whole SSTO, the weight of structures is 30 % (about 7500 kg) and the injection struts represent 2% (about 500 kg).

Composite Structures

The comparison between a metallic and a carbon/carbon structure for the same dual-mode ramjet has been evaluated^{19,20} and summarised on Table 2 page 9.

A benefit of 30% in weight was estimated thanks to this analysis.

The corresponding benefit in the weight engine if applied to a SSTO is more than 2 tons.

Effect on SSTO Performance

The effect of the DMR weight variation on the computed payload (or dry mass margin) of a SSTO could be more than the benefit in weight, as it can be seen Figure 14.

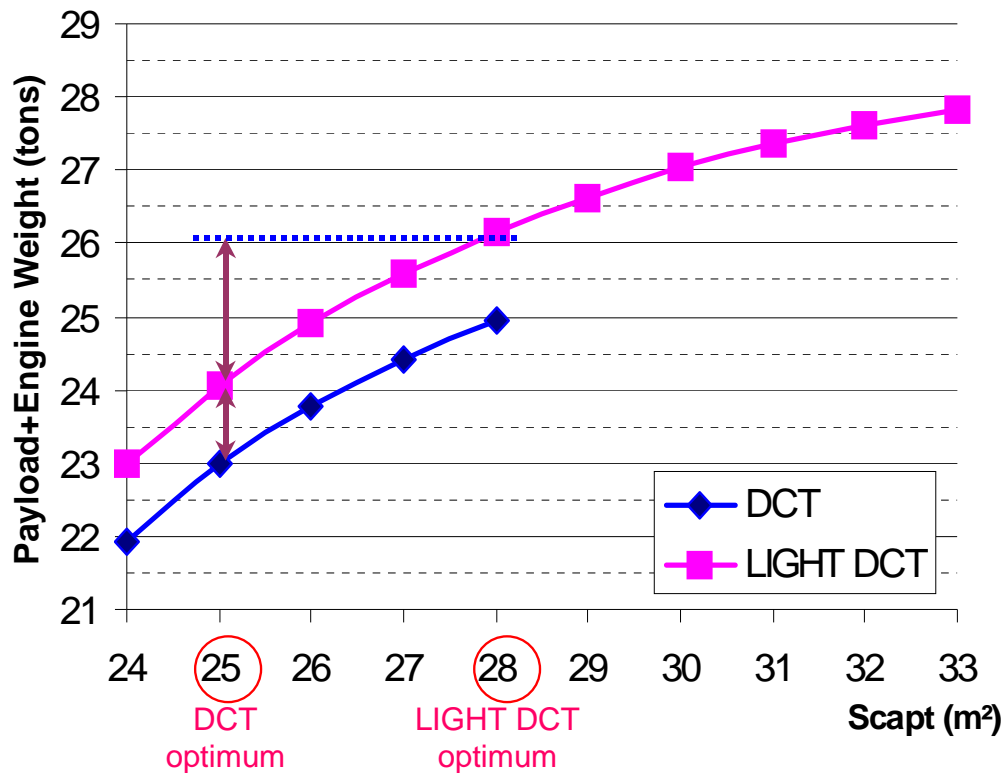

Figure 14: Illustration of snow-ball effect on generic SSTO of lighter DMR.

On this figure, the sum of the computed payload and the DMR weight (in metric tons) is shown as a function of the capture area for a DMR assuming DCT performance and two different specific weights. The “light DCT” assumption is 50% less heavy than the DCT (specific weight formula below, in kg).

$$\text{Weight of "LIGHT - DCT"} = 9412 \times \frac{A_c}{21,367}$$

$$\text{Weight of "DCT"} = 21687 \times \frac{A_c}{24}$$

The lighter engine can be bigger, with a benefit in (computed) payload. The computed benefit is partly due to the “body” weight variation due to the lighter engine: the landing gear is assumed to be a function of the dry mass and is hidden in the “body” in the rubber SSTO present mass budget. The Figure 15 shows these weight breakdown tables with the same capture area “Ac” (non optimised) of 25 m².

DM	DCT Ac=25		LIGHT DCT Ac=25		
Wing and tail	9,372	2,08%	9,372	2,08%	
Body	36,510	8,11%	36,201	8,04%	309 Kg
Main Propulsion	22,591	5,02%	11,012	2,45%	11579 Kg
OMS/RCS Propulsion	8,405	1,87%	8,405	1,87%	
Others	10,370	2,30%	10,370	2,30%	
Dry mass	87,247	19,37%	75,360	16,74%	
Computed Payload	0,388	0,09%	13,048	2,90%	
Other inert mass	9,655	2,14%	8,882	1,97%	773 Kg
In-orbit mass	97,290	21,60%	97,290	21,61%	
LH2 mass	115,979	25,75%	115,979	25,76%	
LOX mass	237,147	52,65%	237,147	52,66%	
rmLOx/mLH2	2,045		2,045		
Total mass	450,416	100%	450,416	100%	

Figure 15: Computed SSTO mass budget for two specific weights of the same DMR.

The optimisation of the capture area led to a complementary benefit: as shown Figure 16, the computed payload is increased by about 13 tons when the DMR estimated weight is decreased by 10 tons (905*25 kg – 440*28 kg).

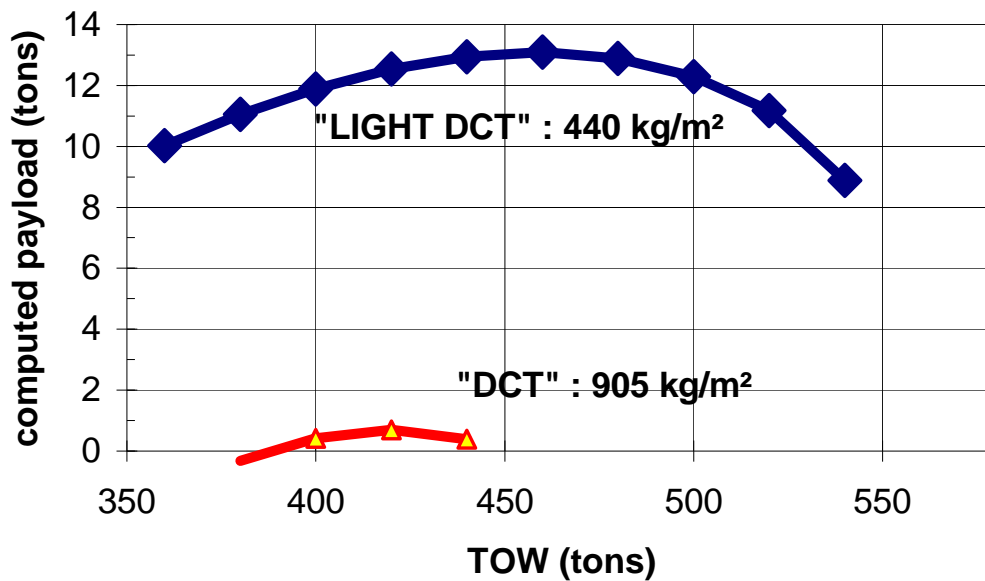

Figure 16: Effect of DMR specific weight on computed payload as a function of SSTO take-off weight.

The difference of 3 tons was also visible Figure 14.

OTHER CONTRIBUTION TO SYSTEM ANALYSIS

The techniques described above have led to several preliminary conclusions or informative results to be used for the system studies.

Effect of Number of Modules

On one hand, thermal analysis and performance estimation should give indications on the optimum number of modules (the wetted area is increasing with the number of modules).

On the other hand, the mechanical effect of the number of modules has been investigated for a small size dual-mode ramjet (missile or experimental vehicle) and for DCT engine suited to SSTO. These two engines have fixed-geometry combustor.

For the small engine, two different solutions have been investigated thanks to structural advanced analysis: one module of 414-mm width for the combustor or 2 modules of 212 mm.

For the small combustor, the results are summarised in Table 5:

Table 5: Comparison of the effect of the number of modules for a small combustor.

Engine weight for	Inconel 718	comment
1*414 mm	45 kg	One module
2*212 mm	33 kg	Two modules

In this particular case, the preferable concept appears to be the two modules one.

The DCT engine has also been extensively studied to see the effect on the structural weight of two parameters:

- Maximum capture area A_c (24 to 30 m²).
- Number of modules (4, 6, 8).

As shown during trajectory optimisations, these two parameters are eventually not independent.

In Table 6, the value in parenthesis is the corresponding height of the I-shape panels.

Table 6: Comparison of the effect of the number of modules for DCT engine (10 m width) for different capture area.

Engine weight for $A_c =$	24 m ²	27 m ²	30 m ²
4 modules of 2500 mm	11790 kg (120 mm)	14630 kg (100 mm)	13790 kg (120 mm)
6 modules of 1660 mm	9351 kg (100 mm)	10600 kg (100 mm)	12120 kg (100 mm)
8 modules of 1250 mm	9965 kg (70 mm)	11950 kg (100 mm)	13820 kg (100 mm)

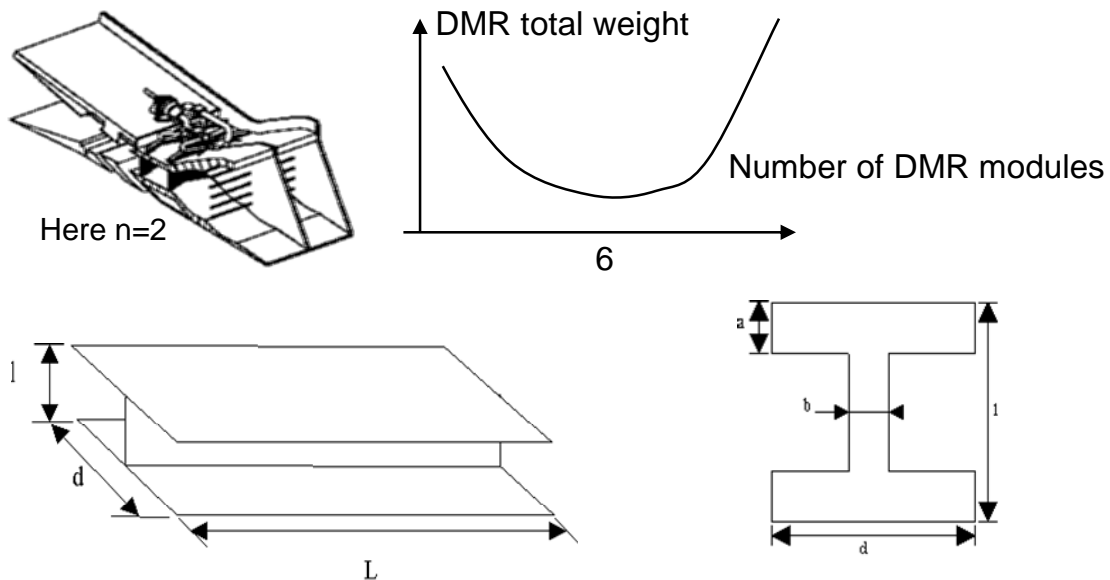

Figure 17: Optimum mechanical design for the DCT engine of a generic SSTO vehicle.

With these assumptions, 6 modules of 1.7 m width seem to be close to an optimum in term of mass.



Scale Effect

Some scale effect has been investigated, from the thermal and mechanical points of view, to extrapolate the ground test results that can not be performed on an engine with a width of several meters, due to mass flow limitations of available test facilities.

The scale factor is also a big issue, from small vehicles like missiles or X51 demonstrator up to huge scramjet for high speed aircraft or future reusable launch vehicle like the generic SSTO studied in the present document.

The capture area A_c determines the air ingested then the fuel mass flow (that can be used to actively cool the engine). The engine wetted area A_w is the one to be cooled and to be taken into account the estimate the weight (while considering a structural weight of 20 kg/m² for example).

Table 7: Size and characteristic areas of scramjet propelled vehicles.

	Lenght	Initial weight	Captation area	Engine wetted area
 <p>Missile or small experimental vehicle</p>	6 m	1,5 tons	0,15 m ²	1,5 m ²
 <p>Reusable space launcher SSTO</p>	70 m	500 tons	30 m ²	100 m ²

An intermediate size has sometimes been studied (30 meters – 30 tons vehicle).

A particular study had been realised with the WRR concept, that shows that it is easier to cool the *FSR* (the big engine of the SSTO RLV project) than the *Prototype* (CHAMOIS scramjet mock-up size : 0.25 entry height by 0.2 wide, corresponding to the propulsion of the ‘intermediate vehicle’ of 30 tons). The necessary cooling power is reduced by about 50% in case of a unique module. For the mechanical point of view, it depends on the integration design, in first approximation we can consider that the weight engine remains proportional to the capture area A_c .

In addition to scale effect, two other topics have to be considered and were discussed:

- The general shape of the vehicle: an axisymmetric vehicle such as ^{10, 11} should have better volumetric and structural efficiency such as a waverider or a inward turning scoop like in the LAPCAT2 project from ESTEC. A “spaceplane” vehicle such as the one in the middle of Figure 7 represents an intermediate class between the two.
- The use of different classes of materials, especially ceramic composite, high temperature alloys, as discussed for example in the next paragraph and in ²¹. The performance, the technology, manufacturing and system readiness levels (TRL, MRL, SRL) have to be considered for the best choice for a given project and mission.

POTENTIAL INTEREST OF COMPOSITE STRUCTURES

The interest of using composite structures have been demonstrated thanks to several analytical and computational studies and to actual technology experimental testing (benefit in weight, benefit in thermal capability, benefit in injection strut drag, ...).

Analysis of Figure 16 showed for example that the expected 30 % benefit in engine weight should lead to a (computed) payload increase of 7000 kg for a SSTO of 500 tons TOW class.

Nevertheless the capacity of realising, using, fastening, monitoring and repairing large cooled composite structures for DMR has not yet been fully demonstrated. Some techniques such as the PTAH-SOCAR technology²² should help to limit drastically fastening problem and to enhance the confidence by ground test demonstration. This technology is for example considered by MBDA in its projects because of its good technology readiness level and its high performance.

Other composite technologies are under study worldwide ¹².

Thus, one of the question to be solved by the designer is the choice between a back structure (that could be metallic) added to the fuel-cooled CMC composite engine structure or an integrated one. In the first case, the fuel-cooled structure has only to be able to sustain the thermal loads and the coolant inner pressure. In the second case, the CMC composite structure integrates stiffeners and should be able to carry the main efforts and hot gas pressures.

REFERENCES

- ¹ Collective, under the direction of E.T. Curran and S.N.B. Murthy, “Scramjet propulsion”, AIAA progress in aeronautics and astronautics, volume 189, 1293 pages, 2000.
- ² M. Bouchez, F. Falempin, “Scramjet and dual mode ramjets”, AGARD Symposium « Hypersonic Sustained Flight », Ecole Polytechnique, France, April 1997.
- ³ J. Philip Drummond, Marc Bouchez and Charles R. McClinton, “Technologies for Propelled Hypersonic Flight, Overview of NATO background on scramjet technology”, RTO-TR-AVT-007-V3, Applied Vehicle Technology Panel Working Group 10, Subgroup 3, published in January 2006.
- ⁴ Dr. Nobuhiro Tanatsugu, Institute of Space and Astronautical Science(ISAS), JAPAN and Dr. Patrick Carrick, SAF/AQRT, Arlington, VA 22309-2404, USA, “Hypersonic and Combined Cycle Propulsion for Earth-to-Orbit Applications”, AIAA 2003-2586.
- ⁵ F. Falempin, D. Scherrer, G. Laruelle, Ph. Rostand, G. Fratacci, J.L.Schultz, “French hypersonic propulsion program PREPHA -results, lessons & perspectives”, AIAA - 98 - 1565 – Norfolk, November 1998.
- ⁶ F. Falempin, “PREPHA Program - System studies synthesis”, XIII ISABE - Chattanooga – 1997.
- ⁷ C. Rothmund, D. Scherrer, M. Bouchez, “Propulsion System for Airbreathing Launcher in the French Prepha Program”, AIAA-96-4498, Norfolk, November 18-22, 1996.
- ⁸ A. Chevalier, V. Levine, M. Bouchez, D. Davidenko, “French-Russian Partnership on Hypersonic Wide Range Ramjets”, AIAA - 96 – 4554.
- ⁹ F. Falempin, L. Serre, “French Flight Testing Program LEA Status in 2009”, AIAA 2009-7227.
- ¹⁰ F. Falempin, M. Bouchez, V Perillat, “LAPCAT 2 –Axisymmetric Concept for a Mach 8 Cruiser Preliminary Design and Performance Assessment” - AIAA-2009-7437.
- ¹¹ F. Falempin, M. Bouchez, “Fully axisymmetric airbreather concept for space launcher – first application to a micro space launcher”, IAC-08-C4.5.6.
- ¹² M. Bouchez, “Scramjet thermal management”, presented at RTO-AVT-VKI lecture series RTO-EN-AVT-185, 13-16 September 2010.

- ¹³ M. Bouchez, V. Levine, F. Falempin, V. Avrashkov, D. Davidenko, “Airbreathing Space Launcher Interest of a Fully Variable Geometry Propulsion System”, AIAA-98-3728, Cleveland, Joint Propulsion Conference, June 1998.
- ¹⁴ M. Bouchez, V. Levine, F. Falempin, V. Avrashkov, D. Davidenko, “Airbreathing Space Launcher Interest of a Fully Variable Geometry Propulsion System: status in 1999”, AIAA-99-2376, Los Angeles, Joint Propulsion Conference, June 1999.
- ¹⁵ M. Bouchez, V. Levine, D. Davidenko, V. Avrashkov, P. Genevieve, “Airbreathing space launcher interest of a fully variable geometry propulsion system and corresponding French-Russian partnership”, AIAA – 2000 – 3340, Joint Propulsion Conference, Hunstville, July 2000.
- ¹⁶ T. Bonnefond, F. Falempin, P. Viala, “Study of a Generic SSTO Vehicle Using Airbreathing Propulsion”, AIAA-96-4490-CP.
- ¹⁷ M. Bouchez, S. Beyer, “PTAH-SOCAR Fuel-cooled Composite Materials Structure for Dual-Mode Ramjet and Liquid Rocket Engines - 2005 status”, AIAA 2005-3434.
- ¹⁸ M. Bouchez, S. Beyer, « PTAH-SOCAR fuel-cooled composite materials structure », AIAA-2008-2626.
- ¹⁹ M. Bouchez, “High speed propulsion: a ten years Aerospatiale-Matra education contribution”, AIAA-99-4894, Norfolk, November 1999.
- ²⁰ M. Bouchez, X. Montazel, E. Dufour, “Hydrocarbon fueled airbreathing propulsion for high speed missiles”, AIAA 98-3729, Joint Propulsion Conference, Cleveland, 1998.
- ²¹ David E. Glass, “Ceramic Matrix Composite (CMC) Thermal Protection Systems (TPS) and Hot Structures for Hypersonic Vehicles”, AIAA-2008-2682.
- ²² M. Bouchez, S. Beyer, “PTAH-SOCAR fuel-cooled composite material structure : 2009 status”, AIAA-2009-7353.

