



US Army Corps  
of Engineers®  
Engineer Research and  
Development Center



## The Structural Insulated Panel “SIP Hut”

Preliminary Evaluation of Energy Efficiency and Indoor Air Quality

Megan A. Kreiger, Dahtzen Chu, Som S. Shrestha, K. James Hay,  
Michael R. Kemme, Andrew C. Johannes, Charles Decker,  
Debbie Lawrence, Ashok Kumar, Steven D. Hart, and Karl F. Meyer

August 2015



**The U.S. Army Engineer Research and Development Center (ERDC)** solves the nation's toughest engineering and environmental challenges. ERDC develops innovative solutions in civil and military engineering, geospatial sciences, water resources, and environmental sciences for the Army, the Department of Defense, civilian agencies, and our nation's public good. Find out more at [www.erdcenter.usace.army.mil](http://www.erdcenter.usace.army.mil).

To search for other technical reports published by ERDC, visit the ERDC online library at <http://acwc.sdp.sirsi.net/client/default>.

# **The Structural Insulated Panel “SIP Hut”**

## **Preliminary Evaluation of Energy Efficiency and Indoor Air Quality**

Megan A. Kreiger, Dahtzen Chu, K. James Hay, Michael R. Kemme,  
Andrew C. Johannes, Charles Decker, Debbie Lawrence, and Ashok Kumar  
*U.S. Army Engineer Research and Development Center (ERDC)*  
*Construction Engineering Research Laboratory (CERL)*  
*2902 Newmark Drive*  
*Champaign, IL 61826-9005*

Som. S. Shrestha  
*Oak Ridge National Laboratory*  
*One Bethel Valley Road*  
*Oak Ridge, TN 37831-6070*

Karl F. Meyer and Steven D. Hart  
*Department of Civil and Mechanical Engineering*  
*United States Military Academy, West Point, NY 10996*

### **Final Report**

Approved for public release; distribution is unlimited.

## **Abstract**

The Army uses a variety of soft shelters and semi-permanent structures at contingency operating bases for functions such as barracks, dining halls, administrative offices, and maintenance shops. Soldiers or local nationals commonly build these structures by hand, and they often manifest performance problems. The use of prefabricated Structural Insulated Panels (SIPs) offers significant benefits for enhancing the performance of building envelopes and reducing assembly time. SIPs used in the simple “SIP hut” can eliminate or reduce many of the problems associated with existing structures constructed in theater. This work compared the performance of the SIP hut with commonly used B-huts in terms of cost, shipping, assembly time, skill level required to build, durability, energy efficiency, and indoor air quality (IAQ). Results show that the SIP hut can be constructed quickly using minimal tools and unskilled labor, has excellent building envelope air tightness, can maintain acceptable IAQ levels with proper ventilation, and may potentially use only about one-fourth of the heating energy and one-sixth of the cooling energy required by an ordinary B-hut. The SIP hut does have some issues with water intrusion, volatile organic compound (VOC) emissions, and fire protection requirements that will be addressed in newer versions of the hut.

# Contents

<b>Abstract .....</b>	<b>ii</b>
<b>Illustrations .....</b>	<b>v</b>
<b>Preface .....</b>	<b>viii</b>
<b>Unit Conversion Factors .....</b>	<b>ix</b>
<b>1 Introduction .....</b>	<b>1</b>
1.1 Background .....	1
1.1.1 B-hut .....	1
1.1.2 SEA and SWA huts .....	2
1.1.3 CMU hut .....	2
1.1.4 Soft shelters .....	2
1.1.5 SIP huts .....	2
1.2 Objectives .....	3
1.3 Scope .....	4
1.4 Approach .....	4
1.5 Mode of technology transfer .....	5
<b>2 Development of the SIP Hut .....</b>	<b>6</b>
2.1 Concept of the SIP hut .....	6
2.2 Previous versions of SIP huts .....	7
2.2.1 Site conditions .....	7
2.2.2 Foundation plan .....	8
2.2.3 SIP hut components .....	8
2.2.4 Erection and finishing .....	8
2.2.5 Lessons learned and recommended modifications .....	10
2.3 Previous testing on SIP huts at U.S. Military Academy, West Point .....	10
<b>3 ERDC-CERL SIP Hut 3.0 .....</b>	<b>13</b>
3.1 Site conditions .....	13
3.2 Foundation plan .....	13
3.3 SIP hut plan and details .....	17
3.4 Erection and finishing .....	17
3.5 Comparison of SIP huts and B-huts .....	23
3.5.1 Material and labor cost .....	23
3.5.2 Shipping considerations .....	24
3.5.3 Assembly time .....	24
3.6 Lessons learned and recommended modifications .....	24
3.7 SIP hut Version 4.0 .....	25
<b>4 Energy Study .....</b>	<b>27</b>
4.1 Instrumentation and data acquisition system .....	27
4.2 Thermal properties test .....	31
4.3 Blower door test .....	32
4.4 EnergyPlus modeling .....	33

4.5	Predicted vs. field-measured data and validation of model.....	35
4.6	Energy performance of the SIP hut.....	41
4.7	Energy performance comparison: SIP hut vs. B-hut .....	43
<b>5</b>	<b>Air Quality Study.....</b>	<b>48</b>
5.1	May 2014 ERDC-CERL SIP hut IAQ study: Construction material outgassing .....	48
5.1.1	<i>Experimental setup</i> .....	48
	<i>Ventilation system</i> .....	48
5.1.2	<i>IAQ assessment methods</i> .....	49
5.1.3	<i>Test conditions</i> .....	52
5.1.4	<i>Test results</i> .....	53
5.1.5	<i>Speciated VOCs</i> .....	55
	<i>Formaldehyde and styrene</i> .....	56
5.1.6	<i>Conclusions and recommendations</i> .....	56
5.2	March 2015 ERDC-CERL SIP hut IAQ Study: Outgassing and ventilation effects.....	58
5.2.1	<i>Experimental setup</i> .....	58
5.2.2	<i>Test results</i> .....	61
5.2.3	<i>Conclusions and recommendations for VOC</i> .....	64
<b>6</b>	<b>SIP Hut Envelope Performance Issues .....</b>	<b>66</b>
<b>7</b>	<b>Integrated Protection of SIP Huts from Chemical/Biological and Ballistic Threats .....</b>	<b>70</b>
<b>8</b>	<b>Summary, Conclusions, and Recommendations.....</b>	<b>72</b>
8.1	Summary.....	72
8.2	Conclusions.....	72
8.2.1	<i>Energy considerations</i> .....	72
8.2.2	<i>Logistics and setup time</i> .....	73
8.2.3	<i>Air quality study</i> .....	74
8.2.4	<i>Effects of weather</i> .....	74
8.3	Recommendations.....	75
8.3.1	<i>Air quality study recommendations</i> .....	75
8.3.2	<i>Water sealing and coating recommendations</i> .....	76
8.4	Issues not addressed .....	76
8.4.1	<i>Climate</i> .....	76
8.4.2	<i>Fire protection considerations</i> .....	77
8.4.3	<i>SIP foam disposal considerations</i> .....	77
	<b>Acronyms and Abbreviations.....</b>	<b>79</b>
	<b>References .....</b>	<b>81</b>
	<b>Appendix A: SIP Hut 3.0 Plans .....</b>	<b>83</b>
	<b>Appendix B: SIP Protective Coatings.....</b>	<b>89</b>
	<b>Appendix C: Weather Observations for SIP Hut IAQ Testing Days .....</b>	<b>100</b>
	<b>Appendix D: EPA TO-15 Detailed Results for SIP Hut IAQ Testing .....</b>	<b>103</b>
	<b>Report Documentation Page (SF 298).....</b>	<b>116</b>

# Illustrations

## Figures

1-1	B-huts (left) and B-hut drawing (right).....	2
2-1	Cam-lock system in Murus SIP .....	7
2-2	Site conditions at Camp Roberts.....	8
2-3	SIP hut 2.0 foundation plan .....	9
2-4	CO <sub>2</sub> test data and model validation .....	12
3-1	SIP hut 3.0 foundation plan .....	14
3-2	Setting up SIP hut foundation piers .....	15
3-3	Foundation connection detail .....	15
3-4	Foundation beam cleat.....	16
3-5	Finishing the foundation.....	16
3-6	SIP unloaded/staged (right).....	18
3-7	Placing floor panels and locking cam-lock.....	18
3-8	Wall panel placement .....	19
3-9	SIP hut wall construction .....	19
3-10	SIP hut pre-roof construction .....	20
3-11	Roof jig .....	20
3-12	SIP hut before finishing.....	21
3-13	Completed SIP hut and partial build crew.....	21
3-14	Completed SIP hut on CERL's EFOB-L.....	22
3-15	Completed SIP hut – north face .....	22
3-16	Completed SIP hut – Interior.....	22
3-17	SIP hut 4.0.....	26
3-18	SIP hut 4.0 interior showing windows.....	26
4-1	The improved B-hut (left), baseline B-hut (middle), and the SIP hut (right).....	28
4-2	Weather station and data acquisition system with remote access capability .....	29
4-3	Direct normal solar radiation measured at weather station and estimated with the ASHRAE clear sky model .....	30
4-4	Measured global horizontal radiation and EnergyPlus calculated incident solar radiation on a horizontal surface .....	30
4-5	Outdoor air temperature and RH for 16 to 22 February 2015 .....	31
4-6	Thermal resistance test result of 4-5/8-in. SIP panel .....	32
4-7	SR of B-hut exterior surfaces measured on 26 September 2013 and on 31 July 2014 .....	32
4-8	Renderings of EnergyPlus model of B-hut (left) and SIP hut (right).....	34
4-9	HFTs on wall and roof.....	34
4-10	EnergyPlus calculated and measured exterior surface temperature before adjusting SR .....	36
4-11	EnergyPlus calculated and measured heat flux before adjusting SR .....	36

## Figures

4-12	EnergyPlus calculated and measured exterior surface temperature after adjusting SR .....	37
4-13	EnergyPlus calculated and measured heat flux after adjusting SR .....	37
4-14	EnergyPlus calculated and measured daily heating load due to heat loss through the envelope.....	38
4-15	SIP hut tracer gas test result when IECU was turned off .....	38
4-16	SIP hut tracer gas test result when IECU was turned on.....	39
4-17	Plot of EnergyPlus-predicted ACH (before adjusting blower door test result) and tracer gas test result.....	40
4-18	EnergyPlus-predicted ACH (after adjusting blower door test result) and tracer gas test result.....	40
4-19	EnergyPlus-predicted daily heating load due to heat loss through envelope and due to air leakage.....	40
4-20	EnergyPlus-predicted heating load and IECU power for SIP hut .....	42
4-21	Correlation between EnergyPlus-predicted heating load and IECU power for SIP hut.....	43
4-22	IECU serving the SIP hut and the flexible ducts used as supply and return ducts.....	44
4-23	Hourly heating energy use in the test huts .....	44
4-24	Indoor air temperature in the test huts .....	45
4-25	Weekly average of hourly heating energy, unadjusted for indoor air temperature .....	45
4-26	Hourly heating energy after adjusting indoor air temperature to 70 °F.....	46
4-27	Weekly average of hourly heating energy, after adjusting indoor air temperature .....	46
5-1	60K Btu/hr IECU.....	49
5-2	IECU remote control unit.....	49
5-3	IECU drawing – showing the location of the slotted flange assembly.....	50
5-4	Total VOCs inside ERDC-CERL SIP hut during May 2014 IAQ study.....	54
5-5	Fantech SHR 1504 heat recover ventilator installed in ERDC-CERL SIP hut.....	59
5-6	Fantech SHR 1504 HRV electrical panel .....	60
5-7	Carbon Dioxide Concentration inside ERDC-CERL SIP hut during March 2015 IAQ study.....	62
6-1	Standing water in SIP hut (14 March 2014).....	67
6-2	Water soaked into OSB panels from leakage (14 March 2014).....	67
6-3	SIP hut with sealant (left half) and roofing tape (right half).....	67
6-4	Icicles on seams with sealant (left) and tape (right).....	68
6-5	Staining on walls from water infiltration .....	68
6-6	Separation of OSB strands in SIP hut panels .....	68
6-7	Deterioration of the edges of the SIP OSB panels on roof eave fascia .....	69
6-8	High-performance sealing tape .....	69
7-1	Currently available HDT Global Inc. COLPRO System (XCP100) using tactical soft wall shelters and airlocks ( <a href="http://www.hdtglobal.com/series/integrated-colpro-systems/">http://www.hdtglobal.com/series/integrated-colpro-systems/</a> ).....	71
7-2	Integrated protection of SIP hut.....	71
A-1	SIP Hut 3.0 Murus Plans, page 1 .....	84
B-1	Technical data sheet for Line-X® XS-252, page 1 .....	89

**Figures**

B-2	Technical data sheet for Line-X® XS-252, Fire Retardant Resin, page 1 .....	92
B-3	Technical data sheet for Line-X® XS-650.....	98
C-1	Weather observations for 20 May 2014 .....	100
C-2	Weather observations for 21 May 2014 .....	101
C-3	Weather observations for 22 May 2014 .....	102

**Tables**

2-1	Total savings from deploying one SIP hut.....	11
3-1	SIP hut 3.0 inventory and tools needed (piece count) .....	17
3-2	SIP hut vs. B-hut costs .....	23
4-1	Performance monitoring instruments.....	28
4-2	Weather station instruments .....	29
4-3	Blower door test results .....	33
4-4	IECU system specifications .....	42
4-5	Hourly heating energy at 70 °F indoor air temperature, kWh .....	46
5-1	Total VOC results summary .....	54
5-2	Summary of EPA TO-15 concentration results in ppm .....	56
5-3	March 2015 ERDC-CERL SIP hut IAQ study test conditions .....	60
5-4	ERDC-CERL SIP hut total VOCs study VOCs results (ppm) .....	61

## Preface

This study was partially funded by the U.S. Department of Defense (DoD), Operational Energy Capability Improvement Fund (OECIF) Program titled “Advanced, Energy Efficient Shelter System (AEESS)” and by U.S. Army 6.2 (Applied Research) Program, AT45 “Modeling and Mitigation of Energy Losses in Building Envelopes.” Funds were also provided by Office of Assistant Secretary of the Army, Acquisition, Logistics, and Technology (ASAALT) Congressional Interest plus up. The technical monitor was Dr. Ashok Kumar, CEERD-CF-M.

The work was performed by the Energy Branch (CF-E) of the Facilities Division (CF) and supported by the Environmental Processes Branch (CN-E) of the Installations Division (CN), U.S. Army Engineer Research and Development Center, Construction Engineering Research Laboratory (ERDC-CERL). Special thanks are given to U.S. Military Academy (USMA) faculty members COL Karl F. Meyer and LTC Steven D. Hart, USMA Cadets Diego Crespo and Scott Ratzer, Phillip Childs and Jerry Atchley of Oak Ridge National Laboratory (ORNL), and Lake Lattimore and Garth Anderson of ERDC-CERL for their technical contributions to this research. At the time of publication, Andrew J. Nelson was Chief, CEERD-CF-E; Michelle J. Hanson was Chief, CEERD-CF; and Kurt Kinnevan, CEERD-CV-T was the Technical Director for Installations. The Deputy Director of ERDC-CERL was Dr. Kirankumar Topudurti and the Director was Dr. Ilker Adiguzel.

LTC John T. Tucker, III was Commander of ERDC, and Dr. Jeffery P. Holland was the Director.

## Unit Conversion Factors

Multiply	By	To Obtain
atmosphere (standard)	101.325	kiloPascals
bars	100	kiloPascals
British thermal units (International Table)	1,055.056	Joules
cubic feet	0.02831685	cubic meters
cubic inches	1.6387064 E-05	cubic meters
degrees (angle)	0.01745329	radians
degrees Fahrenheit	$(F-32)/1.8$	degrees Celsius
feet	0.3048	meters
gallons (U.S. liquid)	3.785412 E-03	cubic meters
horsepower (550 foot-pounds force per second)	745.6999	Watts
inches	0.0254	meters
miles (U.S. statute)	1,609.347	meters
ounces (mass)	0.02834952	kilograms
ounces (U.S. fluid)	2.957353 E-05	cubic meters
pounds (force)	4.448222	newtons
pounds (force) per foot	14.59390	newtons per meter
pounds (force) per square foot	47.88026	Pascals
pounds (mass)	0.45359237	kilograms
square feet	0.09290304	square meters
square inches	6.4516 E-04	square meters
tons (force)	8,896.443	newtons
tons (force) per square foot	95.76052	kiloPascals
yards	0.9144	meters



# 1 Introduction

## 1.1 Background

The Army uses a variety of soft shelters and semi-permanent structures at contingency operating bases including tents, B-huts, Southeast Asia (SEA) huts, and Concrete Masonry Unit (CMU) buildings. These structures are typically used for functions such as barracks, dining halls, administrative offices, and maintenance shops. Unlike similar types of construction projects in the United States, semi-permanent structures at contingency operating bases are either built by hand by Soldiers or contracted out to local nationals. Due to the nature of this construction, buildings generally have energy performance issues due to unintended openings in the building envelope and to simple construction mistakes due to use of unskilled labor, unavailability of certain types of building materials, and material quality. There are also issues of resource constraints, equipment malfunction and breakdowns, and mission priority conflicts.

A significant portion of the energy demand at a contingency base comes from environmental control units (ECUs) for occupied facilities. Improvements to the structure's building envelope can potentially save energy and consequently reduce the amount of fuel that the buildings use, and that often must be delivered by convoy. This reduction in fuel use will result in less frequent need for fuel resupply, which will in turn reduce the amount of risk that Soldiers and contractors are exposed to through the transportation of fuel to contingency bases. A quick review of these building types highlights the need for a more energy efficient, economical building type that serves the purpose of existing soft shelters and semi-permanent structures.

### 1.1.1 B-hut

The most common semi-permanent structure in theater is the barracks hut or B-hut, typically a wood frame building, 16 to 18 ft in width by 32 ft in length, sheathed in plywood, with a corrugated metal roof. Figure 1-1 shows a typical B-hut. Building envelopes are rarely wrapped and insulated due to their bulk and expense of shipping these materials into theater. As a result, B-huts are extremely energy inefficient, greatly increasing their ECU requirements.

Figure 1-1. B-huts (left) and B-hut drawing (right).

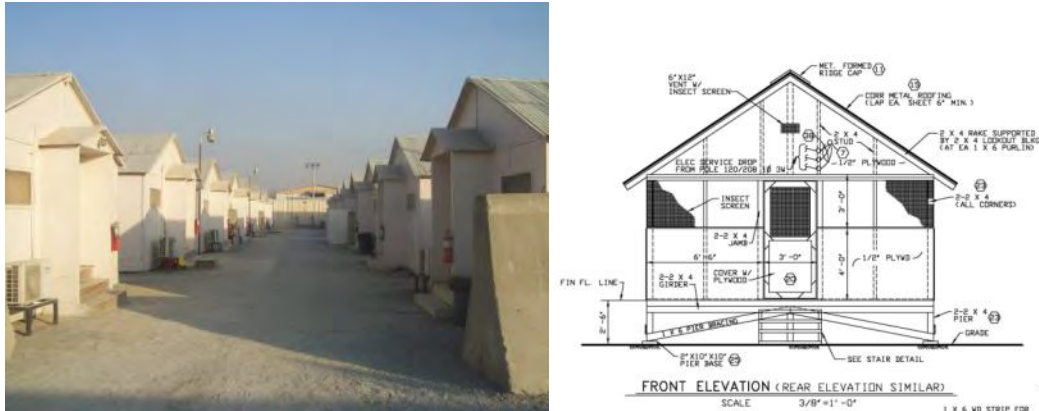

### 1.1.2 SEA and SWA huts

SEA huts and Southwest Asia huts (SWA huts) were developed for their corresponding climate regions and originated during the Vietnam conflict as semi-permanent living quarters. SEA huts were originally built with wooden floors and walls with a canvas roof. SWA huts are more recent incarnations of the SEA huts, but of all wood construction. Their appearance often is similar to B-huts and their names may be used interchangeably.

### 1.1.3 CMU hut

CMU huts have the same footprint as B-huts, but are built out of concrete blocks and mortar in layers with an attached roof system (i.e., wooden truss, plywood, and corrugated steel).

### 1.1.4 Soft shelters

There are many types of soft shelters or tents used at contingency bases, but most of them have the same issues, e.g., leaks (air and water), inefficient energy usage, temperature changes, and drafts. Insulated tent liners are starting to become available to improve their thermal performance. The addition of entry vestibules with multiple zippered entries can also help reduce drafts.

### 1.1.5 SIP huts

The use of prefabricated Structural Insulated Panels (SIPs) offers significant benefits for enhancing the thermal performance of building envelopes

and reduces assembly time. SIPs used in a simple structure known as the “SIP hut” can eliminate or reduce many of the problems associated with existing structures constructed in theater. The concept of the SIP hut was developed by COL Meyer and LTC Hart at the U.S. Military Academy at West Point (USMA) and suggested as a more energy efficient and more easily constructible alternative to current hard-side shelters. In collaboration with the Engineering Research Development Center, Construction Engineering Research Laboratory (ERDC-CERL), USMA-led teams built a total of five SIP huts including one at West Point, NY, one at Camp Roberts, CA, one at Champaign, IL and two at Fort Leonard Wood, MO. The Oak Ridge National Laboratory (ORNL), which is at the leading edge of research in the development, performance evaluation, and deployment of emerging building technologies, was tasked to assist ERDC-CERL to evaluate the performance of the ERDC-CERL Forward Operating Base Laboratory (EFOB-L) SIP hut for potential widespread implementation of SIP hut technology in U.S. Department of Defense (DoD) applications.

However, the durability, life cycle costs, and effectiveness of this technology must first be evaluated and demonstrated. The work, which is being jointly conducted with on-going shelter evaluations by CERL, U.S. Army Natick Soldier Research, Development and Engineering Center (NSRDEC), and the Contingency Basing Integration and Technology Evaluation Center (CBITEC) at Fort Leonard Wood, MO, was undertaken to test the energy efficiency, logistics, constructability, durability, life cycle costs, and indoor air quality (IAQ) of the SIP hut relative to the currently used B-hut.

## 1.2 Objectives

A general objective of this work was to resolve performance and construction issues of current structures used at contingency bases by developing basic, needed improvements to semi-permanent structures while maintaining current structural and durability requirements and keeping life cycle costs at a minimum so that they would meet the following criteria:

- *Rapid Constructability.* One squad (eight Soldiers) should be able to build the designed structure in 12 squad hours or less using only hand tools.
- *Reduced Transportation Requirements.* The entire structure should fit into a standard 20-ft shipping container. The structure should be de-

signed so that it can be easily disassembled, transported, and reused in another location.

- *Improved Energy Efficiency.* The building design should reduce fuel consumption through building envelope improvements.

Specific objectives of this stage of work, undertaken after the initial development of the SIP hut, were to:

- Determine energy savings by performing a side-by-side comparison of the SIP hut with the B-hut.
- Verify that the SIP hut meets air quality standards pertaining to volatile organic compounds (VOCs) and CO<sub>2</sub>.
- Evaluate the SIP hut for its ability to meet fire safety requirements.
- Develop recommendations for further improvements to the SIP hut.

### **1.3 Scope**

The scope of the project is to build, evaluate, and improve the construction and performance over the life cycle of the SIP huts. As such, a SIP hut will continue to be monitored and evaluated at ERDC-CERL and at the CBITEC at Fort Leonard Wood, MO. This work is based on the assumption that these SIP hut sites are representative of constructions in the field and that the data between the types of huts are comparative.

### **1.4 Approach**

The objectives of this work were met through the following steps:

1. Following previous testing on earlier versions of the SIP hut at USMA and ERDC-CERL, ERDC-CERL designed and USMA cadets constructed a SIP hut at the EFOB-L.
2. Tests were done to evaluate the performance of a baseline B-hut and the SIP hut for: (a) energy efficiency, (b) air quality, and (c) other general performance parameters.
3. The results from the two huts were compared, conclusions were drawn, and recommendations formulated for construction improvements to the hut design, and for further study.

## **1.5 Mode of technology transfer**

On completion of full demonstration and validation for safety, efficiency, durability, life cycle costs, etc. under actual Soldier loads, SIP technology will be considered for transfer to the Department of Defense through the Army Facilities Component System, a program of record that maintains DoD's contingency construction standard designs and data. A number of different facilities now designed using wood frame, CMU, and prefabricated steel (e.g., barracks, administrative buildings) may be considered for an additional version using SIPs.

## **2 Development of the SIP Hut**

### **2.1 Concept of the SIP hut**

The concept of the SIP hut originated at USMA and was a joint ERDC-CERL and USMA proposal to study lightweight systems for improving the building envelope efficiency of standard semi-permanent theater structures. In this effort, USMA investigated using SIPs as an alternative to traditional wood frame (“stick-built”) construction. SIPs are a proven technology that has been used in the building industry for over 60 years. They consist of an insulating foam core sandwiched between two structural panels, typically made of oriented strand board (OSB). Walls properly constructed using SIPs have higher R-values and air tightness compared to conventional wood-framed construction with fiberglass insulation. The goal of the USMA was to develop a semi-permanent structure that can be used in place of the B-hut with additional capabilities that include:

- the ability to maintain more comfortable interior conditions while consuming 20% of the energy a B-hut currently requires
- the ability to be constructed in 7-9 squad hours compared to the 30 squad hours currently required for a typical B-hut
- the ability to package and ship all material to construct a SIP hut in one standard 20-ft container
- the ability to be quickly disassembled to allow reuse at a new location.

A key advantage of USMA’s SIP hut is the use of panels produced by the Murus Company, Inc., which have a tongue-and-groove edge profile to allow fast and accurate alignment of joints between panels. The distinctive feature of Murus’ SIP is the incorporation of a patented cam-lock system located every 2 ft along the edges of the SIP to create the tightest possible seal between panels (Figure 2-1). The company claims that the cam-lock can save up to 30% on installation time over other SIPs.

Before the erection of the SIP hut at ERDC-CERL, two earlier versions were constructed by USMA. The lessons learned from these versions were incorporated into ERDC-CERL’s SIP hut, termed “SIP hut 3.0.”

Figure 2-1. Cam-lock system in Murus SIP.



Source: [http://www.murus.com/products/pur\\_sip/](http://www.murus.com/products/pur_sip/)

## 2.2 Previous versions of SIP huts

This section summarizes the work of USMA on the design and construction of early versions of the SIP Huts. SIP hut 1.0 was constructed at West Point, NY in April 2013 using SIPs for the floors, walls, and roof. The lessons learned from SIP hut 1.0 were used to create SIP hut 2.0, which was built 6-8 August 2013 at Camp Roberts, CA for the Joint Inter-agency Field Experiment (JIFX) sponsored by the Naval Post Graduate School. The SIP hut components arrived on Monday, 5 August and the foundation was prepared in 5 work-hours. Construction of the structure began at 0920 on 6 August and was completed at 1230 on 7 August. Doors, trims, heating, ventilating, and air-conditioning (HVAC) systems, and electrical service were completed by noon on 8 August. Initial energy assessments showed that a 1-ton HVAC unit drawing 1150W of power maintained an internal temperature of 68-70 °F with an external temperature of 91+ °F.

### 2.2.1 Site conditions

The Camp Roberts site was a very level site with an existing crushed stone foundation (Figure 2-2). Minimal changes in gravel elevation were required to construct a level building foundation. The delivery truck parked adjacent to the construction site and a forklift was used to stage the SIP bundles for ease of construction.

Figure 2-2. Site conditions at Camp Roberts.



### **2.2.2 Foundation plan**

Foundation plans were adjusted (Figure 2-3) to facilitate construction on an austere site and support the changes to the floor structure. Foundation blocks were placed directly on the ground, then three foundation beams were placed on the blocks. Floor panels were placed on these beams. Three Soldiers were able to build this foundation in 1 hour, 40 minutes, or 5 work-hours.

### **2.2.3 SIP hut components**

One goal of the overall project is to reduce the number of pieces necessary for construction. SIP hut 2.0 had 105 pieces and assembly required only eight cuts made with a handsaw.

### **2.2.4 Erection and finishing**

Construction of the structure for this SIP hut took 10.5 clock hours using a squad that averaged 6.5 Soldiers for a total of 68.25 work-hours. Finish construction including the installation of the electrical system, HVAC system, doors, and trim took 18 work-hours. The construction team consisted of COL Meyer, LTC Hart, MAJ Johannes, and Soldiers from the 270<sup>th</sup> Digital Liaison Detachment. None of the Soldiers had any prior experience with constructing a SIP hut.

Figure 2-3. SIP hut 2.0 foundation plan.

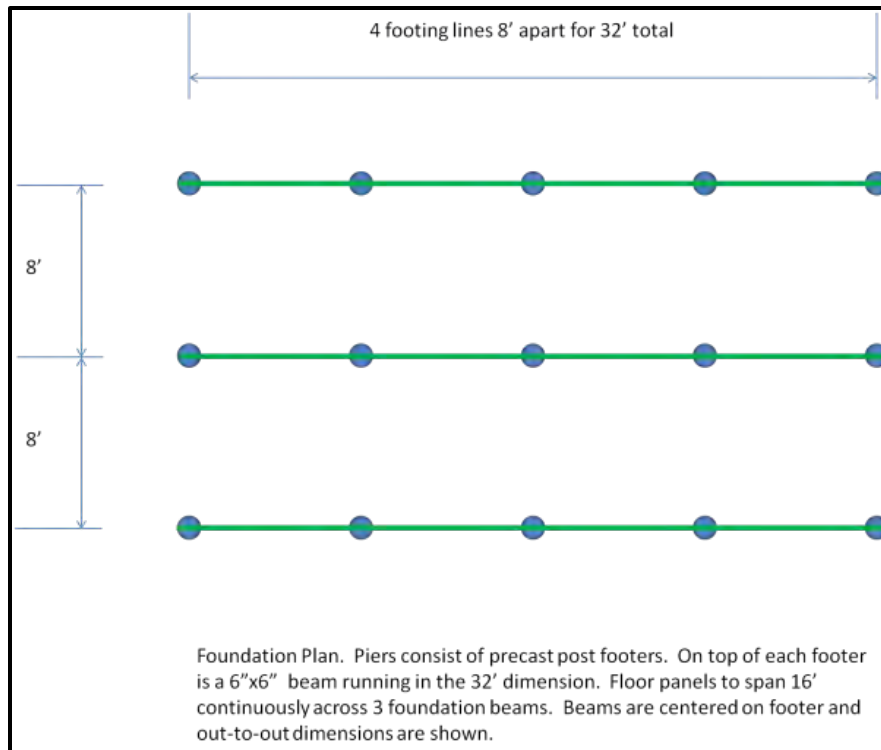

This version of the SIP hut reduced the number of floor pieces from 16 in SIP hut 1.0 to eight. This reduced the floor construction effort to 10 work-hours, or less than one-third of the time (32 work-hours) required by the original design. This improvement is considered to validate this new floor design.

This version also included factory installed infill lumber in some locations. The goal of this installation was to reduce the time spent in the field cutting and nailing/screwing infill material in place. One difficulty in this was in the dimensions of the built-up infill members on the end walls. Structure construction was delayed for approximately 1.5 clock hours because the end walls were about  $\frac{1}{4}$  in. too wide. Walls were cut to fit by hand, and then erected. The concept of factory installed infill material was validated, but because quality control is difficult on built-up dimensioned lumber, engineered wood products are recommended for future versions.

In SIP hut 2.0, the ridge beam was laminated veneer lumber (LVL) as opposed to built-up dimensioned lumber in the first iteration. This resulted in a lighter, straighter beam, which made erection easier. Additionally, a detail was added that locked the ridge beam into the end walls. The bevel

on the ridge beam was factory cut, which resulted in higher quality and reduced field construction time.

### **2.2.5 Lessons learned and recommended modifications**

One goal of this iteration was to construct the SIP structure in 8 squad hours. If the time to resize the end walls is deducted from the construction clock time, then the structure construction was accomplished in 58.6 work-hours. Scaled to an eight Soldier squad, this would mean 7.3 clock hours for construction. Since the goal was to design a structure that was constructible in 6 squad hours, the goal was not achieved. Based on this experience, it was concluded that an 8-squad hour timeframe is more realistic. This time assumed no lift equipment is used. When the foundation, doors, electrical equipment, HVAC system, finishing and roof are included in the plan, then 16-18 squad hours (2 day's work) for the completion of a SIP hut is very realistic.

Two areas that took up a great deal of construction time and effort were the installation of the screws in the floor shims and the installation of the inlet nailer and wall connection to the inlet nailer using screws at 4 to 6 in. on center. In future versions, it would be desirable to modify this detail by reducing the number of screws used by 66 to 75%.

The inside wall height on this version was 8 ft, the normal wall height in a typical house. This could be reduced to as low as 6 ft, 6 in. without a decrease in quality of life. This would decrease shipping cube, weight, and material costs while increasing constructability.

The use of engineered wood products was validated. Their dimensional stability and quality control makes them the preferred choice where precise dimensions are important.

## **2.3 Previous testing on SIP huts at U.S. Military Academy, West Point**

Testing and data from West Point included:

- *Fragment Protection Analysis*, which reviewed improvements to the building structure.
- *Blast Protection Analysis*.
- *Finite Element Analysis*.

- *Life Cycle Evaluation*, done to evaluate whether SIP huts provide overall superior performance compared to traditional B-huts, from economic, environmental, and operational perspectives. Table 2-1 lists economic data. Based on these data, if adopted for use in base camps, SIP huts may offer multiple benefits: large fuel savings, which will result in appreciable long-term cost savings; reduced environmental impact; reduced risks; increased base camp operating efficiency; and more consistent environmental living conditions within the SIP hut.

Table 2-1. Total savings from deploying one SIP hut.

		2 years	5 years	10 years
Costs (USD)	with ECUs & Generators	\$28,287	\$71,802	\$144,327
	without ECUs & Generators	\$16,696	\$60,211	\$132,736
Diesel fuel (gal)		1,934	4,835	9,670
Embodied energy (kWh)		57,538	203,311	446,267
Greenhouse Gas (GHG) Emissions (lb CO <sub>2</sub> eq)		35,105	110,925	237,290
Total impacts (Ecopoints)		1,425	5,190	11,464

- *Energy Use Modeling*.
- *Blower Door Testing*.
- *Thermal Performance* (November 2013).

Testing was conducted from 21 through 29 November 2013. Results were analyzed and used to compare the thermal performance between the SIP hut and a traditional B-hut at West Point. Surface, ambient, and internal temperatures were monitored as well as energy consumption for heating. The SIP hut was heated with a heat pump while the B-hut had approximately 4kW of resistive heaters. Occupancy of eight Soldiers was simulated with 750W space heaters between 1800 and 0600 hours.

The SIP hut consumed less than one-tenth the energy of the B-hut and provided better temperature regulation. The thermostat was set at 71 °F during a period when external temperatures ranged from 19 to 55 °F. The measured temperatures in the SIP hut were between 63 and 76 °F, while measured temperatures in the B-hut ranged between 39 and 72 °F. The SIP hut consumed 8 gal of JP8 fuel; the B-hut consumed 82 gal of JP8. If this performance is scaled to a battalion base camp of 120 huts, the fuel requirement for B-huts and SIP huts would be 33,000 and 3,150 gal/month respectively.

- *Energy Consumption Testing.*  
An energy consumption test was performed on the SIP hut from 2 through 10 February 2014 with a new ECU. The internal temperature of the SIP hut ranged from 70.4 to 72.8 °F, while the ambient temperature was between 3 and 46 °F. Energy consumption was between 12.68 and 20.57 kWh per day, depending on the ambient temperature. The ECU regulated temperature much better than did the heat pump although energy consumption of the two technologies was comparable given similar heating requirements (under ambient conditions).
- *CO<sub>2</sub> and Air Exchange.*  
CO<sub>2</sub> levels in the SIP hut were modeled and analyzed under occupied and unoccupied conditions. The results of this experiment and modeling effort can be used to properly design a system that provides fresh air and reduces CO<sub>2</sub> in the hut. CO<sub>2</sub> levels were collected on 10 February 2014. The tests included an hour of occupancy in the SIP hut at approximately 1500. This caused CO<sub>2</sub> levels to increase, and on vacancy to decrease due to the airflow by the ECU. Parameters from the SIP hut, ECU airflow, and estimated CO<sub>2</sub> from occupants were modeled, which resulted in a closely represented dataset (Figure 2-4). The CO<sub>2</sub> performance was slightly improved, but not sufficient for occupancy.

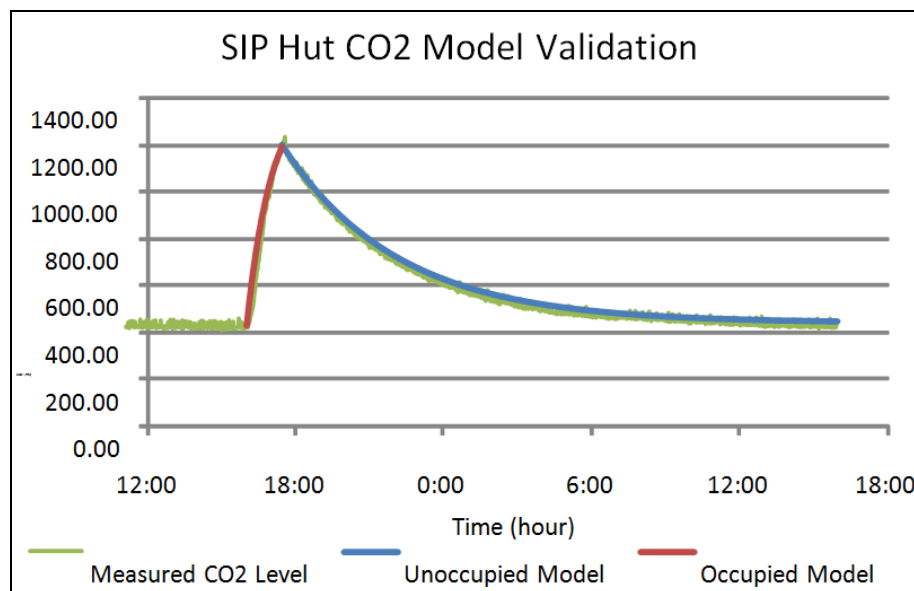
Figure 2-4. CO<sub>2</sub> test data and model validation.

### **3 ERDC-CERL SIP Hut 3.0**

SIP hut 3.0 was built on 7 March 2014 at EFOB-L in Champaign, Illinois. The foundation was prepared in 4 squad hours. Construction of the structure began at 1545 and was completed at 2025. The base structure was erected in 5 squad hours. Doors, trims, and final sealing were completed on 9 March in 2 additional squad hours. This section summarizes the work done at EFOB-L by USMA.

#### **3.1 Site conditions**

The CERL site has a compacted gravel foundation. Vehicles had direct access to the site. SIP panels were delivered on pallets and were staged on-site for construction from a single shipping container. Temperatures were in the 30s (°F) with windy conditions. Precautions were taken to prevent injuries caused by panels exposed to wind loads.

#### **3.2 Foundation plan**

The foundation plan and method of connection between the wall and floor panels was changed after SIP hut 2.0. Additional 2x6 members were added to provide a wider bearing surface on the outside beams and to connect adjacent foundation beams to provide for better continuity during construction. In addition, a double 2x6 was added on both ends of the foundation to provide additional support for the end panels of the structure. In this version, the walls were no longer attached to a cleat fastened to the floor panels. Instead, panel screws were inserted through the wall panels into the edge of floor panels around the perimeter of the building. This change reduced construction time by approximately 6 work hours. Figure 3-1 shows the updated plan. Piers consist of precast concrete foundation blocks (Figure 3-2). On top of each block is a 6x6-ft beam running the length of the building. Beams are centered on the footer and connected on their ends with 2x6x8-ft beams using Simpson Tie Connectors. Concrete foundation blocks were placed directly on the compacted gravel surface. Excavation and adjustments of depths up to 4 in. were required to create a complete level plane for the floor.

Note that it is extremely critical to ensure that SIP-constructed structures have completely level foundations. Proper fit of the panels requires a level platform. Any future foundation settlement that occurs may compromise the seal between the SIP joints, and may allow moisture infiltration. In cold climates, if warm humid interior air leaks to the exterior, it may allow condensation to occur on the interior face of the outer OSB sheathing, thereby causing rot and deterioration to the OSB.

Six foundation beams were then placed on the blocks and connected at their ends with supporting boards. Cleats were screwed into each foundation beam to hold them in place on each foundation block. Tie-down cables were placed into grooves in the foundation beams and anchored with helical anchors on either end. Floor Panels were then placed directly on the foundation beams. Eight Soldiers were able to install the foundation in 4 hours. Figure 3-3 shows a detail view of the laminating board, foundation beam, foundation block, and Simpson Tie Connection. Figure 3-4 shows the placement of the foundation beam cleat in the foundation block, and Figure 3-5 shows the finishing of the foundation.

Figure 3-1. SIP hut 3.0 foundation plan.

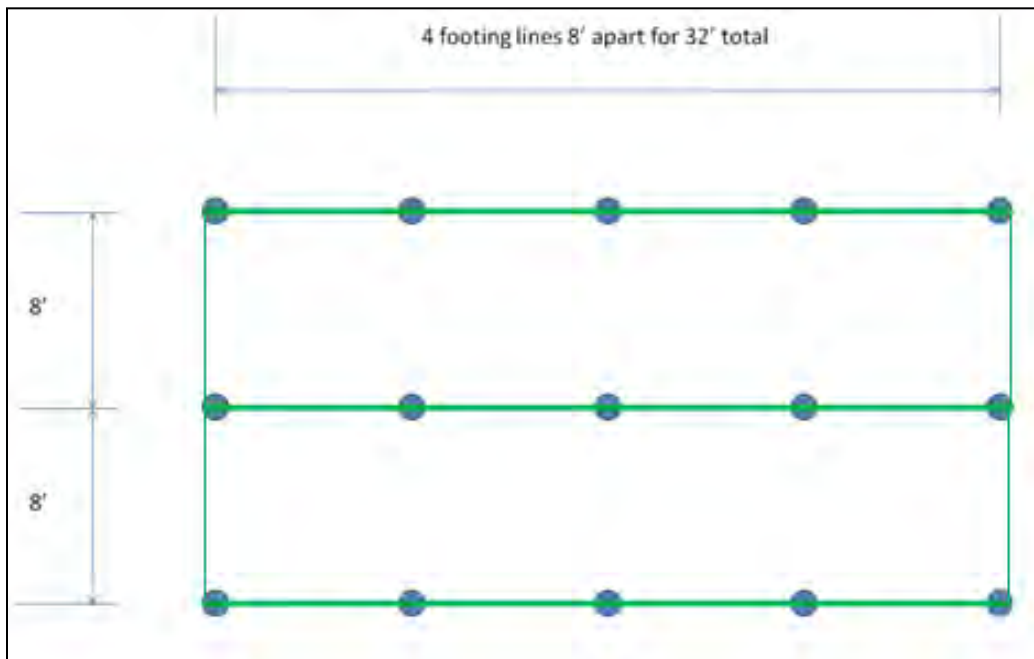

Figure 3-2. Setting up SIP hut foundation piers.



Figure 3-3. Foundation connection detail.



Figure 3-4. Foundation beam cleat.



Figure 3-5. Finishing the foundation.



### 3.3 SIP hut plan and details

The goal was to construct the SIP hut 3.0 in 5 squad hours. Table 3-1 gives the inventory list of SIP hut parts and tools used. Pre-applied Line-X<sup>®</sup> protective covering on the floor, outer walls, and outer roof was new to the plans. Appendix A includes the plans for SIP hut 3.0.

Table 3-1. SIP hut 3.0 inventory and tools needed (piece count).

Item	Count	Item	Count
Foundation Blocks	15	Wall panels	24
6x6x16-ft foundation beams	6	Floor panels	8
2x6x8-ft cleats	2	Roof Panel	18
2x2x8-ft stays	2	Ridge beam	2
2x8x12-ft edge beams	5	Column	1
2x8x8'-ft edge beams	2	Bracket	1
2x4x8-ft wall cleats	12	Helical Anchor	8
2x6x10-ft roof inlet	7	Tie-Down Cable	4
Screw Gun	3	Ladders	3
Hand Saw	1	Chalk Line	1
Level	1	String Line	2
Tape Measure	2	Hammer	1
Foam Gun	2	Drill Bit	As required
Screwdriver	1	Shovel	1
Total Piece Count: 117			

### 3.4 Erection and finishing

Nine Soldiers were able to construct the SIP hut 3.0 in 4.75 clock hours. This is equivalent to 42.75 work-hours, a decrease of 25.5 work-hours from the SIP hut 2.0 construction at Camp Roberts. Finish construction, including doors, trims, and sealing cracks took an additional 18 work-hours. The team consisted of COL Meyer, LTC Hart, MAJ Johannes, Mr. Garth Anderson, CDT Altonji, CDT Callaghan, CDT Crespo, CDT Ratzer, and CERL employees. Only COL Meyer, LTC Hart, and MAJ Johannes had prior experience constructing a SIP hut.

Before construction, the SIP hut components were positioned in close proximity to the site for ease of assembly (Figure 3-6 and Figure 3-7).

Figure 3-6. SIP unloaded/staged (right).



Figure 3-7. Placing floor panels and locking cam-lock.



This version of the SIP hut implemented a few upgrades. One of these was smaller dimensions. The wall heights were shortened to 6.5 ft. They were also shifted to sit directly on the foundation beam as opposed to the floor panels. This change allowed for quicker installation because screws were placed through the wall panels directly into the floor panels. The total time spent setting the floor panels was 4.5 work-hours and the wall panels took 9 work-hours. Figures 3-8, 3-9, and 3-10 show the wall panels being set. (Note that two of the floor panels had the LINE-X coating applied to the wrong side, which explains why bare OSB is visible on the floor in Figure 3-9.)

Figure 3-8. Wall panel placement.



Figure 3-9. SIP hut wall construction.



Figure 3-10. SIP hut pre-roof construction.



Another change implemented during SIP hut 3.0 was that a roof jig was used to assist in the roof panel installation. The roof jig, similar to the prototype shown in Figure 3-11, was used to stabilize the roof panel and to protect the Soldiers doing the installation. The roof took 9 work-hours to install. Figure 3-11 shows the orientation of the roof jig. Figures 3-12 and 3-13 show the structure with the installed roof.

Figure 3-11. Roof jig.

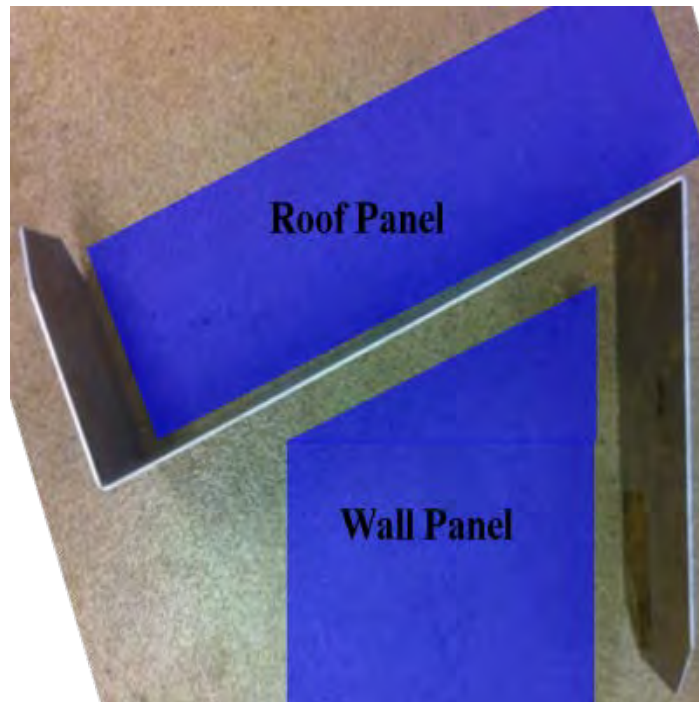

Figure 3-12. SIP hut before finishing.



Figure 3-13. Completed SIP hut and partial build crew.



The finish construction consisted of sealing the joints between panels and hanging the doors. This process took 18 work-hours. Figures 3-14, 3-15, and 3-16 show the completed structure. The following section discusses possible improvements to the process.

Figure 3-14. Completed SIP hut on CERL's EFOB-L.



Figure 3-15. Completed SIP hut – north face.



Figure 3-16. Completed SIP hut – Interior.



### 3.5 Comparison of SIP huts and B-huts

#### 3.5.1 Material and labor cost

A direct comparison of the cost of the SIP hut to an equivalent sized B-hut at the ERDC-CERL EFOB-L site was not possible because different labor sources were involved in their assemblies. The ERDC-CERL B-hut was built by a local area general contractor while the labor source for the SIP huts and a B-hut at West Point was primarily cadets and instructors from USMA. Table 3-2 provides an approximate idea of the cost differences.

Table 3-2. SIP hut vs. B-hut costs

	SIP hut			B-hut	
	West Point*	Camp Roberts	ERDC-CERL	West Point*	ERDC-CERL
Squad hours	10			30	
Equivalent labor hours	80.00	91.25	60.75	240.00	
Labor cost (hrs x wage rate)	\$1,753.60	\$2,000.20	\$1,331.64	\$5,260.80	
Material cost*	\$14,500.00	\$14,500.00	\$14,500.00	\$6,500.00	
Total cost	\$16,253.60	\$16,500.20	\$15,831.64	\$11,760.80	\$36,000.00

\* Source: April 2013 structural comparison by West Point. The material cost values does not include doors, foundations, roofing, HVAC, and electrical since these items are common to both buildings. For the labor cost, a mean hourly wage of \$21.92 was used (Source: U.S. Department of Labor, Bureau of Labor Statistics, Occupational Employment and Wages, May 2014, 47-2031 Carpenters)

The cost for the ERDC-CERL B-hut includes electrical and lighting, but all other costs shown in the table do not include electrical, lighting, or HVAC systems. The actual HVAC systems used in contingency bases vary from military issued ECUs to relatively inexpensive commercial, locally procured split systems.

Information from USMA on the labor expended on building the various versions of the SIP hut included both squad hours and labor hours. Although the labor (cadets, instructors, Soldiers) for these were “free,” a dollar value was estimated for comparison with civilian labor costs. In terms of cost alone, the average cost of the three SIP huts was \$4,400 greater than the cost of the B-hut built at West Point. Note that these costs are significantly lower than the cost of the ERDC-CERL B-hut. The reason for this is that the ERDC-CERL B-hut was procured through a contractor. The amount shown for this B-hut included the cost of preparing and finishing the gravel base for the entire EBOB-L site as well as overhead and profit for the contractor.

Unfortunately, since the ERDC-CERL B-hut cost was part of a larger contract, no itemized costs for labor and material were available.

### **3.5.2 Shipping considerations**

If one considers the structural components alone (i.e., not including HVAC and electrical), the material weight of a SIP hut is about the same as that of a B-hut, but its volume is four times greater. Each weighs ~10,000 lb., but a SIP hut has a material volume of ~1,050 cu ft, and a B-hut has a volume of less than 300 cu ft. A 20-ft standard container (often called “CONEX boxes,” i.e., CONTainer EXpress military shipping containers) can contain only one SIP hut, but a container of the same size can accommodate four B-huts (Gebo).

### **3.5.3 Assembly time**

Based on observations of the actual assembly of the B-huts and the SIP hut on the EFOB-L site, a B-hut takes approximately 1 week to be completed starting from a bare site to a fully enclosed structure. Note that this was with the use of commercial workers working an 8-hour day. The SIP hut was completed in approximately 2 days, again starting from a bare site to a fully enclosed structure, but with cadets and other Army personnel labor. For comparison, an AirBeam model 2032 tent, which is close to the B-hut and SIP hut in footprint, can be set up in less than an hour.

## **3.6 Lessons learned and recommended modifications**

Construction of the SIP hut 3.0 validated many of the upgrades that have been made over the progression of the concept. The construction time of 5 squad hours exceeded expectations. Shortening the wall dimensions and introducing a roof jig expedited the roof installation. Use of the roof jig added a measure of safety, as did the shorter dimensions, which reduced the height to which the heavy roof panels needed to be lifted. Placing the wall panels directly on the foundation beam made the connections to the floor panel more efficient and reduced movement in the wall panels before the roof was installed. Use of Line-X<sup>®</sup> protective coating gave the walls, floor, and roof additional durability. The following recommendations could further improve the process:

- Full construction details should be provided on the first day to help unload and layout panels.
- Conexes should be properly packed and properly spaced to save time and to avoid issues that can arise when the conex doors are fully opened so they do not interfere with the unloading of the panels.
- During assembly, at least two hex keys should be available for fastening the cam-lock assemblies.
- Extend the double 2x8 connecting beams on the end of the foundation and shorten the 6x6 foundation beams to allow fastening directly through the 2x6 into the floor beams to eliminate the need for the Simpson Tie Connectors.
- Use a ratchet strap to pull the end wall panels together thus closing the joints to reduce the difference between the width of the end wall and the length of the floor panels. Insert and clear the cam locks keys before lifting the roof panels to prevent awkward movements in locking the cams when the roof is overhead.
- Introduce a waterproof tape or roof cap to seal the roof ridge during finish construction. Caulking the roof cracks is a timely and unsafe process, especially in wet conditions.

### **3.7 SIP hut Version 4.0**

SIP hut 4.0 was designed and constructed at West Point in the spring of 2015 as part of a research project sponsored by NSRDEC. This version incorporated a shed roof that reduced the total number of roof pieces by half, included four windows on the high side of the building above head level, and a foundation system that could be quickly assembled to account for variations in site elevation of up to 2 ft within the plan of the building. Based on design changes in SIP hut 4.0, the total structure was assembled by a four-person team in less than 7 hours with no mechanical lift assistance. The team consisted of one person with previous SIP hut assembly experience and three people with no prior experience. Approximately 2 weeks after initial construction, SIP hut 4.0 was disassembled, moved by truck to Natick Labs in Natick, MA and reassembled by a different crew with no prior experience in a similar amount of time as the initial crew. SIP hut 4.0 is shown in Figure 3-17 and Figure 3-18.

Figure 3-17. SIP hut 4.0.



Figure 3-18. SIP hut 4.0 interior showing windows.



## 4 Energy Study

ORNL is documenting the energy performance of the SIP hut by monitoring and analyzing energy use in EFOB-L's SIP hut, which is co-located with a baseline B-hut. This B-hut is a 16x32x8-ft (W-L-H, floor to ceiling) basic wood-framed uninsulated structure with exterior and interior plywood walls, interior plywood ceiling, and a metal over plywood covered truss roof. The hut is situated on 12 to 18-in. high "floating" wood piers set on a gravel base. Figure 4-1 shows EFOB-L's two B-huts (baseline B-hut in center) and the SIP hut. The huts are being monitored unoccupied and with no internal load.

EnergyPlus (U.S. Department of Energy EnergyPlus Energy Simulation Software) models of these huts are being developed and simulation results are being validated against field-measured data. Validated models will be used to estimate performance of these huts at other operating conditions and locations. Savings achieved through envelope upgrade techniques, such as the use of insulation on walls, attic, and floor, and reduced infiltration by sealing joints, can also be quantified through the EnergyPlus simulation. ORNL is assisting ERDC-CERL in evaluating the performance of the SIP hut for potential widespread implementation of this design in the DoD building stock.

### 4.1 Instrumentation and data acquisition system

ORNL instrumented and installed a data acquisition system in the test huts. The huts are equipped with sensors to measure temperature at interior and exterior surfaces, heat flux through each side of walls, roofs (ceiling in the case of the B-hut), and floor, energy use by the improved environmental control units (IECUs), plug loads, and temperature and relative humidity in the conditioned space, in the space between the floor and ground, and in the attic of the B-huts.

Figure 4-1. The improved B-hut (left), baseline B-hut (middle), and the SIP hut (right).



An onsite station is collecting all weather parameters required to create an EnergyPlus weather file to run simulations and to validate models. Table 4-1 lists the performance monitoring instruments and Table 4-2 lists the weather station instruments. An instrument to measure the direct beam solar radiation is mounted on Eppley's automatic SMT solar tracker. A Shade Disk Kit (SDK) is mounted on the SMT tracker to measure diffuse solar radiation using a Black & White pyranometer. Each sensor reading is recorded at 5-minute intervals using a Campbell Scientific micrologger CR3000 (Campbell Scientific 2015) along with multiplexers. Two data files were maintained; one with 5-minute interval data and a second one with hourly data. Remote access of data for periodic monitoring and archival is performed through a telephone modem. Each heat flux transducer (HFT) was calibrated at ORNL using a LaserComp Fox-605 heat flux meter (LaserComp 2015). Figure 4-2 shows the data acquisition system (DAQ) and weather station.

Table 4-1. Performance monitoring instruments.

Sensor manufacturer and model	Parameter measured	Sensor location
Fenwall 192-103LET-A01	Temperature	Exterior and interior surfaces of the envelope, conditioned space, attic, and crawl-space
Honeywell HIH-4000-003	Relative humidity	Conditioned space, attic, and crawl-space
Concept Engineering F-002-4	Heat flux through envelopes	Walls, roofs, ceiling and floor
Continental Control Systems WattNode WNB-3Y-208-P	Energy use	Switchgear supplying power to the huts and IECUs

Table 4-2. Weather station instruments.

Sensor manufacturer and model	Parameter measured
Vaisala Weather Transmitter WXT520	Outdoor air temperature
	Outdoor air relative humidity
	Wind speed
	Wind direction
	Rainfall
	Barometric pressure
Eppley Normal Incidence Pyrheliometer SNIP	Direct beam solar radiation
Eppley Black & White Pyranometer 8-48	Diffuse solar radiation
Eppley Standard Precision Pyranometer SPP	Global horizontal solar radiation
Eppley Precision Infrared Radiometer PIR	Infrared radiation from sky
Campbell Scientific Li-200	Solar radiation on B-hut one roof surfaces

Figure 4-2. Weather station and data acquisition system with remote access capability.



To ensure that the measured solar data were accurate, the direct beam solar radiation measured by the pyrheliometer was compared against the American Society of Heating, Refrigerating, and Air-Conditioning Engineers (ASHRAE) clear sky model (ASHRAE 2013) that is used to predict direct beam solar radiation on a clear sky day. For comparison, Figure 4-3 shows the measured direct beam solar radiation against the predicted values from the ASHRAE clear sky model during a fairly clear sky day. EnergyPlus uses the direct beam and diffuse solar radiation from a weath-

er file along with the location and time to calculate the surface outside face incident solar radiation. Figure 4-4 shows measured global horizontal radiation against surface outside face incident solar radiation on a horizontal surface predicted by EnergyPlus for 16-22 February 2015. These comparisons are needed to ensure that the solar data collected from the onsite weather station are reasonably accurate. Additionally, Figure 4-5 shows measured outdoor air temperature and relative humidity (RH) for the same week. These are examples of measurements that were used to validate the EnergyPlus model.

Figure 4-3. Direct normal solar radiation measured at weather station and estimated with the ASHRAE clear sky model.

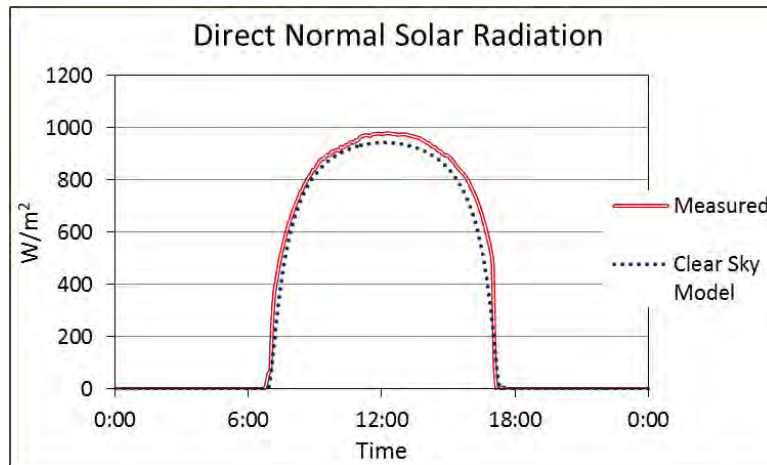

Figure 4-4. Measured global horizontal radiation and EnergyPlus calculated incident solar radiation on a horizontal surface.

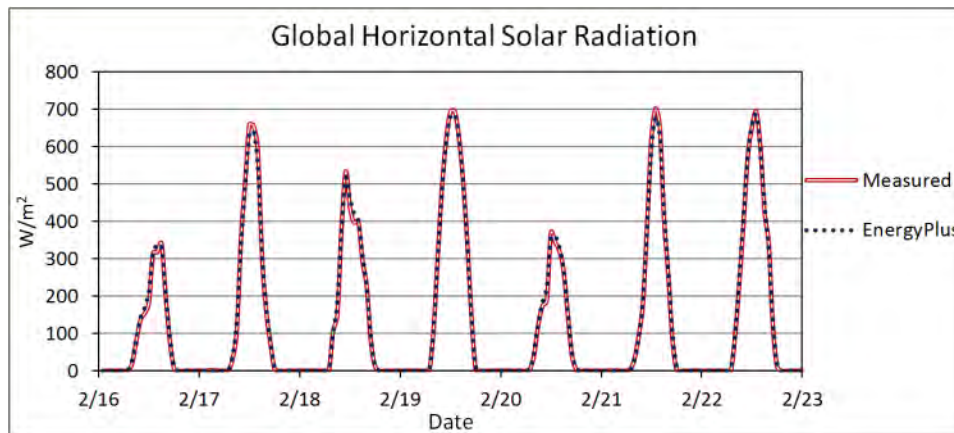
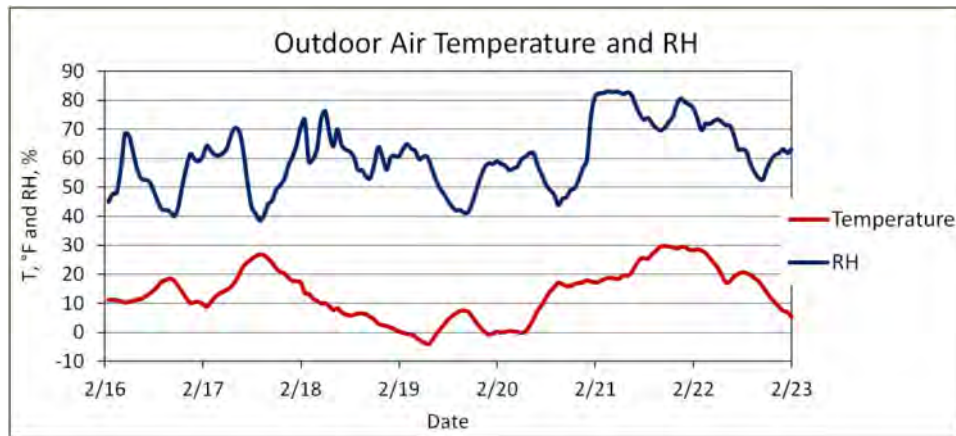

Figure 4-5. Outdoor air temperature and RH for 16 to 22 February 2015.



## 4.2 Thermal properties test

It is essential to use accurate material properties to build a good energy simulation model. The thermal resistance of an in-situ sample cutout from a SIP wall panel was measured at various surface temperature settings using a LaserComp Fox-605 heat flux meter (LaserComp 2015). In a separate test, the thermal resistance of 7/16-in OSB and polyurethane (PUR) foam alone were also measured. Figure 4-6 shows the specimen tested at ORNL and the thermal resistance values of a 4-5/8-in. thick SIP, as well as of the 3-3/4-in. thick foam alone, and of two layers of 7/16-in. thick OSB at various temperatures. The test result shows that the thermal resistance of the SIP panel is a strong function of temperature. Thermal resistance of the PUR foam decreases by 15% when temperature increases from 50 to 100 °F. Therefore, variable thermal properties of each layer of material were used in the EnergyPlus model. An R-value of 6-5/8-in. thick PUR SIPs used for the roof and floor was derived from the 4-5/8-in. thick PUR SIP test result.

The solar reflectance (SR) of surfaces exposed to solar radiation and the thermal emittance (TE) of all surfaces that emit infrared radiation are also important input parameters in building energy simulation. On 31 July 2014, the SR of exterior painted wall and roof surfaces from the SIP hut was measured as 0.377 and 0.675, respectively. These measurements were made using Devices and Services Solar Spectrum Reflectometer (DS 2014). Two tests that were conducted at the B-huts at 10-month intervals showed significant reduction in the SR of exterior surfaces due to discoloration (Figure 4-7).

Figure 4-6. Thermal resistance test result of 4-5/8-in. SIP panel.

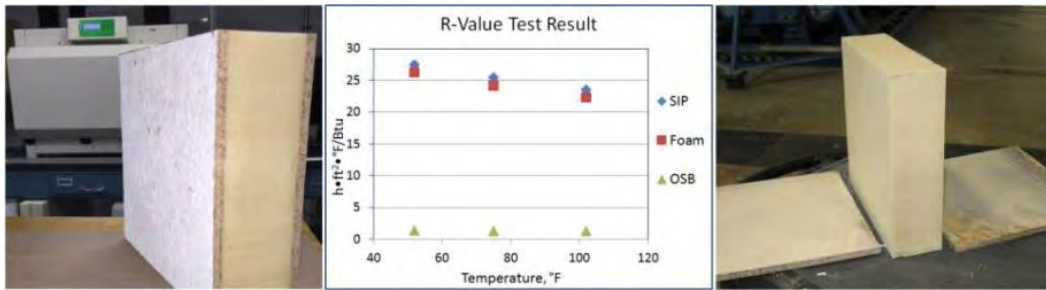
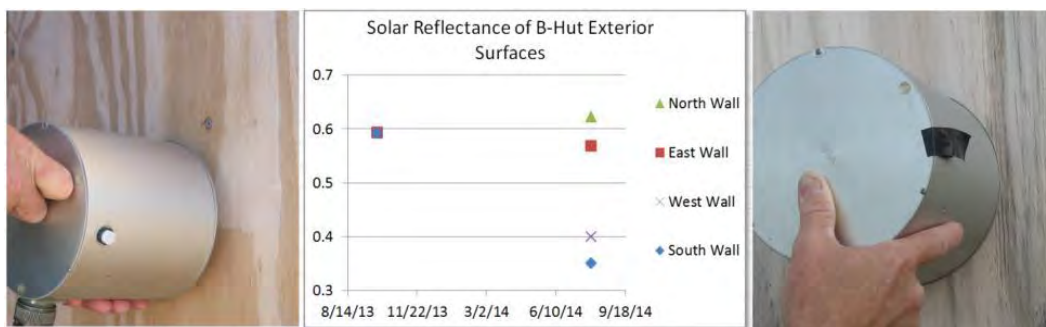

Figure 4-7. SR of B-hut exterior surfaces measured on 26 September 2013 and on 31 July 2014.



Maximum degradation in SR was observed on the south wall, followed by the west and east walls. The SR of the north wall increased slightly. This indicates that the change in SR is directly proportional to the amount of incident solar radiation on the surface. The same can be expected from the SIP hut, especially on its white-colored roof. Therefore, it is desirable to measure the SR of exterior surfaces periodically.

### 4.3 Blower door test

Air leakage can account for 30 to 50% of conditioned air loss in some buildings. A blower door test creates a pressure differential across the building envelope and measures the airflow as a function of the pressure difference. A pressure gauge attached to the blower door assembly measures the rate of airflow required to maintain that pressure differential in cubic feet per minute (cfm).

To measure airflow, the SIP hut and B-huts were closed-up tightly in accordance with standard blower door procedures (ASTM E779 [ASTM 2010]), then pressurized and depressurized (compared with outside conditions) with the blower door fan. A series of flow and pressure readings were

taken over a range of 10 different pressures equally spaced between 40 to 75 Pascals (Pa). A comparison of test results clearly supports the observation that adequately sealing the EFOB-L structures enhances the air tightness of the building envelope. Table 4-3 lists building and test results.

#### 4.4 EnergyPlus modeling

Thermal and physical properties such as thermal conductivity, specific heat, thickness, density, SR, and TE of building materials were either measured on site, determined by conducting laboratory tests at ORNL (as discussed in previous section), gathered from the ASHRAE Handbook, or obtained from manufacturers' data sheets. Each type of envelope system was then assigned one or more layers of materials based on the actual construction, and each surface was assigned its respective construction, outside boundary condition, and relative geometry. Building geometry was set up using architectural drawings while important parameters such as the exact location of HFTs, and shading surfaces were verified with field measurements. The Conduction Finite Difference heat balance algorithm was used in EnergyPlus to model the variable thermal properties of SIPs. Figure 4-8 shows renderings of EnergyPlus models of the B-hut and SIP hut.

HFTs were installed on the interior surfaces of walls and covered by an extra layer of ½-in. plywood and placed halfway between studs (or at the middle of the SIP panel) to measure the heat flux through the wall insulation section with minimal effect from the studs (Figure 4-9). HFTs were also installed on the floor, east- and west-facing roofs, and ceiling (only on B-huts, as shown in Figure 4-9). The exact location of each HFT and wall configuration was maintained in the EnergyPlus model.

Table 4-3. Blower door test results.

Building	SIP hut	B-hut
Envelope Improvements	Partially sealed with roofing caulk and tape. Insulating foam.	None.
Date Tested	9/2/14	7/8/14
Pressurization (cfm/sf)	0.182	1.989
Depressurization (cfm/sf)	0.204	1.828
Average (cfm/sf)	0.193	1.909
Flow coefficient (cfm/Pa <sup>n</sup> )	17.99	318.12
Pressure exponent	0.673	0.549

Figure 4-8. Renderings of EnergyPlus model of B-hut (left) and SIP hut (right).

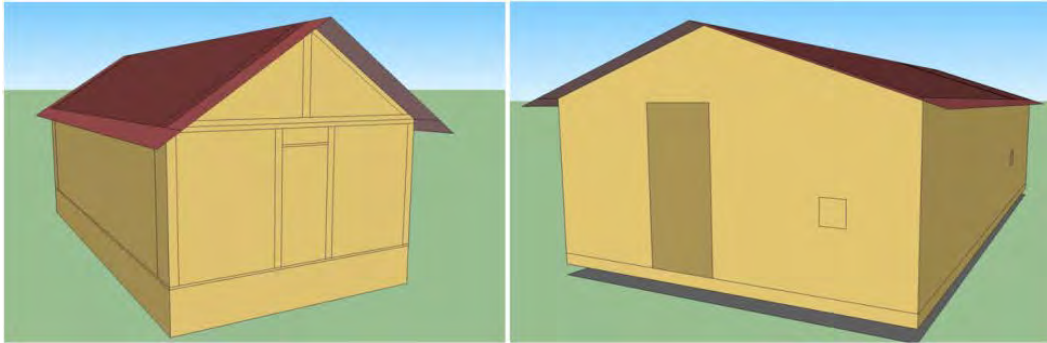

Figure 4-9. HFTs on wall and roof.



EnergyPlus assumes one-dimensional heat transfer. It is desirable to develop a thermally equivalent wall description (ASHRAE 1145-TRP) in the EnergyPlus model to account for the thermal bridging effect caused by framing when performing whole-building energy analysis. However, the thermally equivalent wall cannot be used to compare EnergyPlus simulation results against the heat flux measured by HFTs. This is because the equivalent wall predicts average heat flux for the whole wall, whereas the HFTs installed in the huts measure the heat flux through a small section of the wall, which is practically unaffected by the studs or inlet nailers between SIP panels.

Exact latitude and longitude of the building location are essential inputs for the solar tracker to track the sun and for EnergyPlus to calculate incident solar radiation on exterior surfaces and shading. The values obtained from latlong.net for the B-huts and SIP hut located at EFOB-L are: Latitude: 40.1516 degrees; Longitude: -88.2712 degrees.

Infiltration is an important contributor to conditioning load. CERL conducted blower door tests to characterize leakage in all huts. Table 4-3 (p 33) lists the latest blower door tests' summary results used for this analysis. ORNL conducted tracer gas tests to measure air change rate during normal operating conditions. The next section compares the EnergyPlus-predicted air leakage against tracer gas test data.

#### **4.5 Predicted vs. field-measured data and validation of model**

It is essential to validate building energy models by comparing simulation results against field-measured data to ensure that the models are representative of the actual buildings and the simulation results are meaningful. A few validation examples of the SIP hut model follow.

Initially, the SR of exterior surfaces were used from measurements taken on newly painted SIP panel (measured on 31 July 2014) and using the EnergyPlus default ground SR of 0.2. Figures 4-10 and 4-11 show the EnergyPlus calculated exterior surface temperatures and heat flux through walls to conditioned space, respectively, against field-measured data for 1 week. In these figures, solid double lines represent measured data and dotted lines represent EnergyPlus simulation results. On these plots, heat flux to conditioned space is considered positive and heat loss from conditioned space is considered negative.

Figures 4-10 and 4-11 clearly show that the EnergyPlus estimates for exterior surface temperatures and heat flux to the conditioned space match fairly well with field-measured data at nights and during cloudy conditions; however, EnergyPlus underpredicted these parameters during sunny hours. This is because the initial model did not account for the degradation in SR of exterior surfaces over time (see "Thermal properties test" [Section 4.2]), or for the increase in ground solar reflectance due to snow in the ground.

Figure 4-10. EnergyPlus calculated and measured exterior surface temperature before adjusting SR.

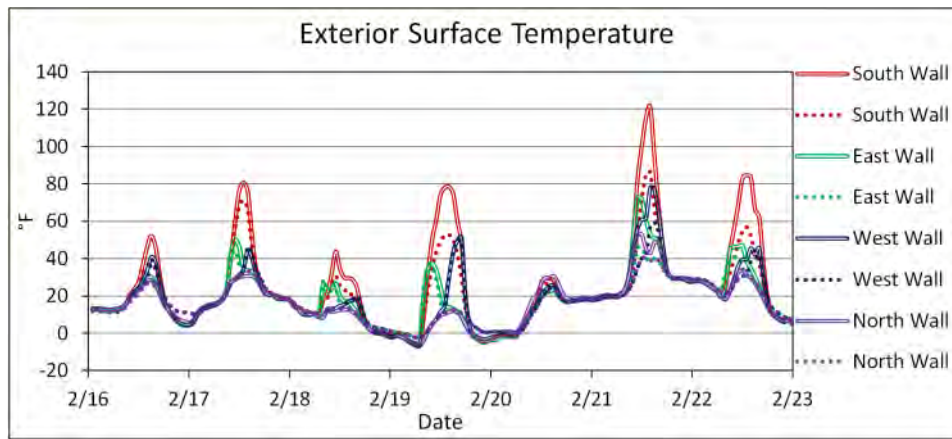
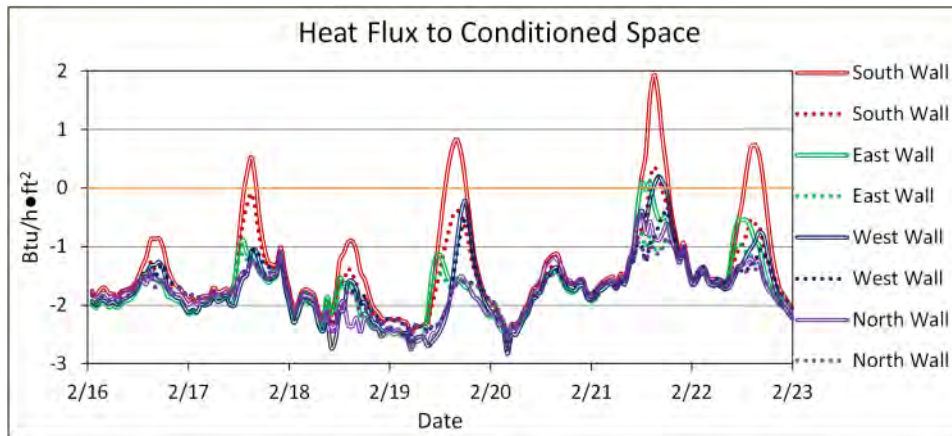

Figure 4-11. EnergyPlus calculated and measured heat flux before adjusting SR.



The SR of the exterior surface of the south, east, and west walls were changed to 0.45, 0.2, and 0.2, respectively and the ground solar reflectance was changed to 0.6 for the period of time when the ground was covered with snow. Figures 4-12 and 4-13. show that the EnergyPlus estimates significantly improved with the revised SR values and new simulation results match fairly well with field-measured values.

Heating loads associated with heat loss through the building envelope ( $Q$ ) were calculated by multiplying heat flux ( $q$ ) by the surface area ( $A$ ) on each side of the walls, roofs, and floor and then summing them as:

$$Q = \sum_{i=1}^n A_i q_i \quad (1)$$

Figure 4-12. EnergyPlus calculated and measured exterior surface temperature after adjusting SR.

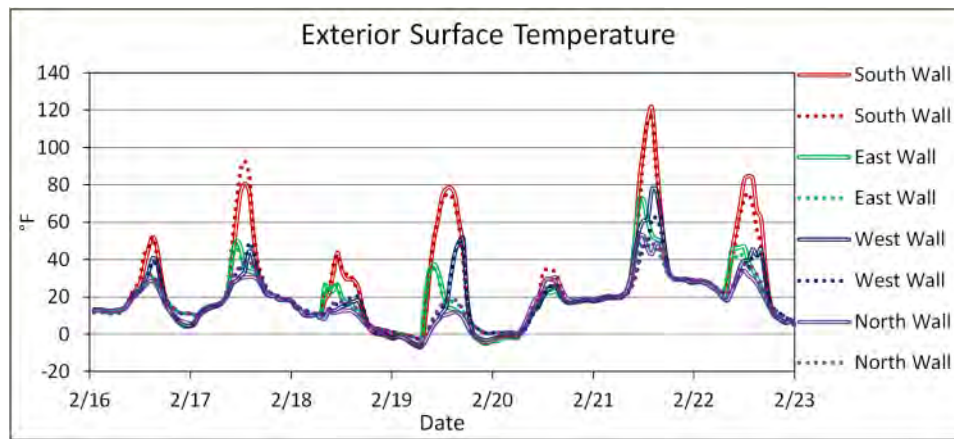

Figure 4-13. EnergyPlus calculated and measured heat flux after adjusting SR.

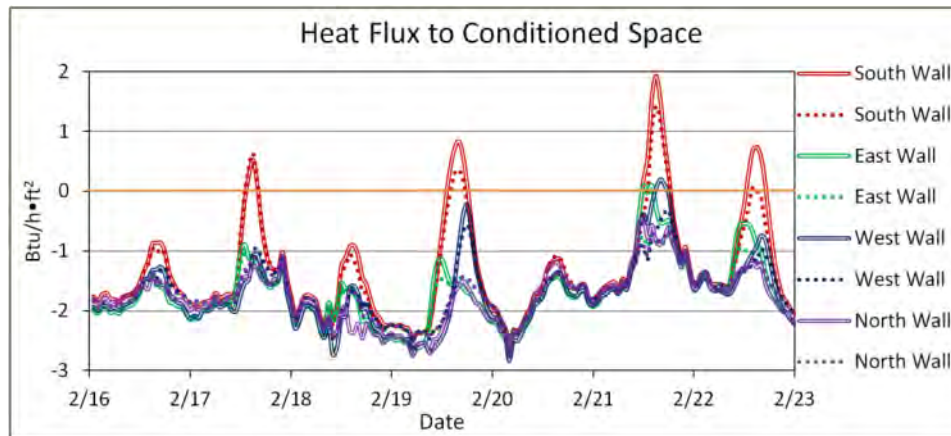
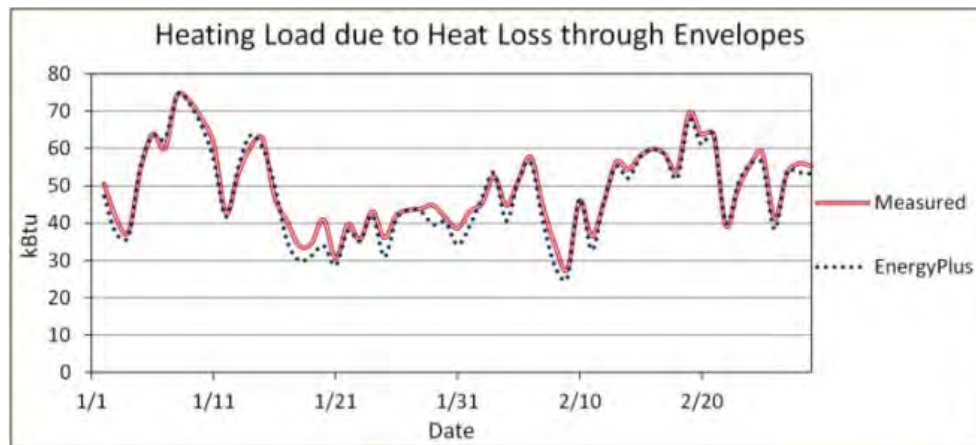

Figure 4-14 shows EnergyPlus calculated and measured daily heating load due to heat loss through the envelope. Overall, EnergyPlus' predicted heating load match fairly well with measured data. For the period on January and February 2015, EnergyPlus underpredicted total heating load due to the heat loss through envelope by 3%. This difference is within the uncertainty of the measurements.

ORNL conducted tracer gas tests using a concentration decay method in the SIP hut on 4 and 5 December 2014, to measure the air exchange rate of the conditioned space during normal operating condition. Because common practice dictates that blower door tests be conducted with the IECUs off, the effect of these units on infiltration rate was evaluated by performing tracer gas tests with the IECU off and on.

Figure 4-14. EnergyPlus calculated and measured daily heating load due to heat loss through the envelope.



After releasing the tracer gas and achieving a well mixed condition, a LumaSense multipoint sampler was used to sample air from the north, center, and south sides of the hut. An Innova 1412 photoacoustic field gas monitor was used to measure the concentration of the tracer gas in the air. Figure 4-15 shows the results when the IECU was off and Figure 4-16 shows the result when the IECU was on. These plots use the natural log of tracer gas concentration in the Y-axis, and time elapsed in hours in the X-axis. The slope of the linear regression lines in these plots, multiplied by -1, gives the air changes per hour (ACH). As seen from these two figures, the air in the hut was well mixed given that concentrations from the three sampled locations were similar. When the IECU was off, the average air leakage rate was 0.119 ACH. When the unit was running, the average leakage rate increased significantly to 0.828 ACH.

Figure 4-15. SIP hut tracer gas test result when IECU was turned off.

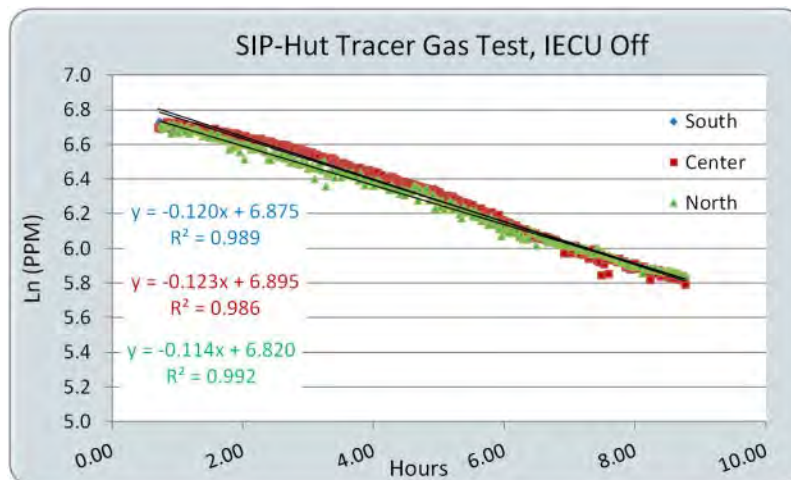

Figure 4-16. SIP hut tracer gas test result when IECU was turned on.

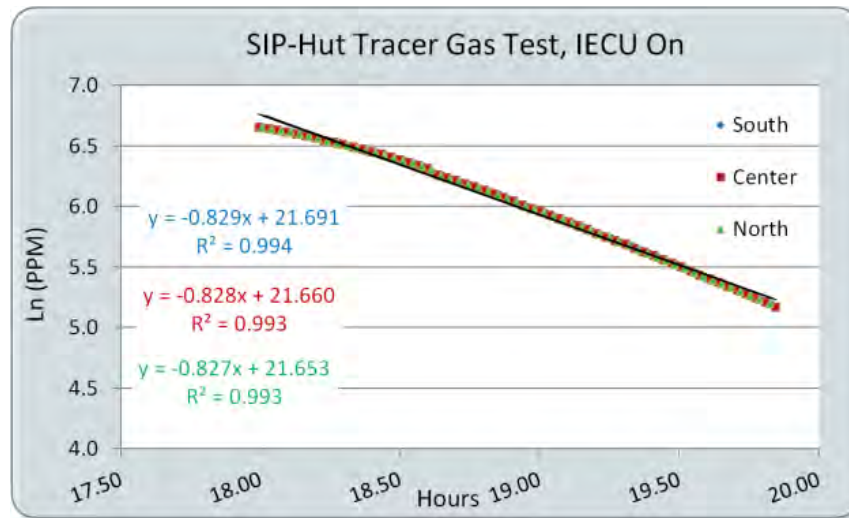

Figure 4-17 shows EnergyPlus-predicted ACH against the tracer gas test results with the IECU on and off. The blower door test results in Table 4-3 were used in EnergyPlus in these simulations. Results from simulation results match well with those from the tracer gas test when the IECU was off. However, when the IECU was on, ACH measured with tracer the gas test was 4.4 times higher than those obtained through EnergyPlus. The increase in ACH is potentially due to two main reasons: (1) the IECU changes the building pressure causing higher air change rate, and (2) a leaky flexible duct connecting the hut and the IECU. The slightly higher ACH from the tracer gas test during the last hour shown in Figure 4-17 was caused by the fact that the door was frequently opened during this period. The tracer gas test was interrupted at ~1:00 a.m. on 5 December due to a power supply loss and it resumed the next day at ~10:00 a.m. after restarting the generator.

This analysis shows that the air leakage obtained from the blower door test must be adjusted for EnergyPlus to calculate a realistic air exchange rate when the IECU is running. Therefore, a schedule file that is based on the IECU run time was created and used so that EnergyPlus could calculate ACH using the flow coefficient from the blower door test when the IECU is not running, and could use the adjusted flow coefficient when the IECU is running. From the limited tracer gas test data, an adjustment factor to correct flow coefficient was calculated as 4.43. Figure 4-18 shows the improvements to the EnergyPlus-predicted ACH after adjusting the flow coefficient.

Figure 4-17. Plot of EnergyPlus-predicted ACH (before adjusting blower door test result) and tracer gas test result.

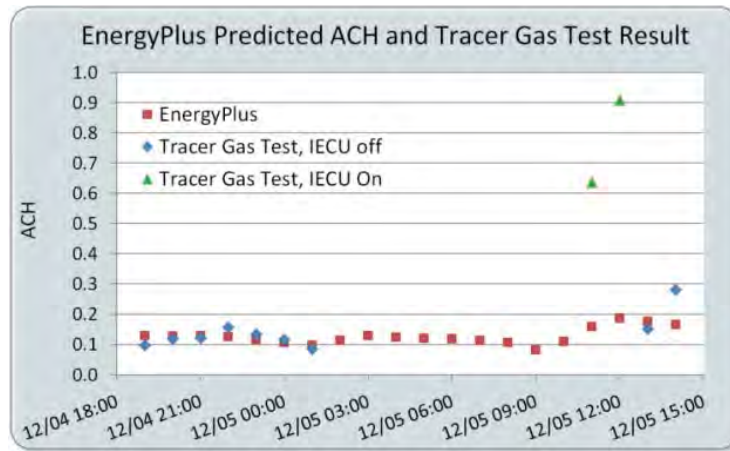

Figure 4-18. EnergyPlus-predicted ACH (after adjusting blower door test result) and tracer gas test result.

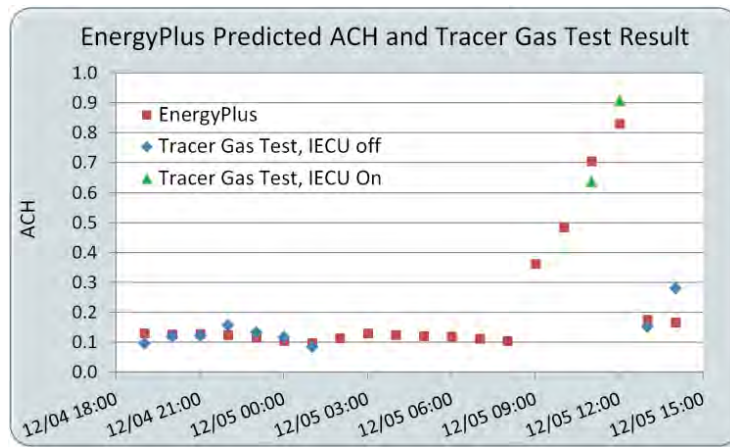

Figure 4-19. EnergyPlus-predicted daily heating load due to heat loss through envelope and due to air leakage.

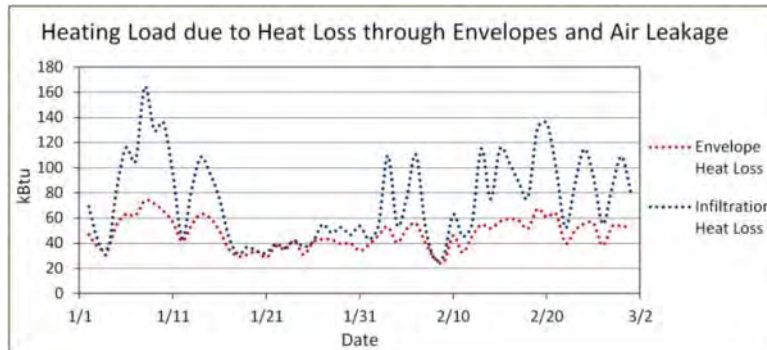

Figure 4-19 shows the EnergyPlus-predicted daily heating load due to heat loss through envelope (also shown in Figure 4-14) and due to air leakage. For the SIP hut, the magnitude of the heat loss associated with heat flow through the envelope and air leakage, which are the two main contributors to heating loads, are comparable during calm conditions. Overall, heat loss due to infiltration was 35% greater than that from heat loss through envelope.

#### **4.6 Energy performance of the SIP hut**

After the instrumentation of the SIP hut was completed in August 2014, data were collected and monitored. However, the power supply to the hut was frequently interrupted until the installation of a permanent power supply to the test site in December 2014. Therefore, this report includes energy use in the SIP hut only for January and February 2015.

A DRS Environmental Systems 60 kBtuh IECUs model NSN 4120-01-543-0741 was used to meet the conditioning loads of the SIP hut. An identical IECU was also installed in the baseline B-hut to allow a side-by-side comparison of the conditioning energy used. Monitoring began in December 2014. Table 4-4 lists the IECU specifications (source HQDA and HQUSAF [2010]). For heating, three tubular electric resistance heaters, each with a 3kW capacity, are used. Evaporator blower motor and tubular heaters are energized and condenser fan motor and compressor are de-energized when the IECU is set on heating mode. Similarly, the evaporator blower motor, condenser fan motor, and compressor are energized, and tubular heaters are de-energized when the IECU is set on cooling mode.

The EnergyPlus-predicted hourly heating load was compared with the IECU power consumption to check how well EnergyPlus tracks the heating load at the SIP hut (Figure 4-20). The overlap between two curves shows that the EnergyPlus simulation results track the heating loads very well. It should be noted that the heating load uses the primary axis and the IECU power uses the secondary axis in this figure. IECU power is the sum of electric resistance heater power and blower motor power. However, the blower motor is located in the air stream so all the electrical energy used by the blower motor is eventually dissipated as heat to the circulating air.

Table 4-4. IECU system specifications.

PARAMETER	SPECIFICATION
Operating Temperatures	Cooling = 40 to 125°F Heating = -50 to 70°F
Control	Internally or remotely mounted control box
Power Required:	
Voltage	197.6 - 228.8 VAC
Frequency	50/60 Hertz
Phase	3-phase, 5-wire
Current	35.8 amps max. at 208 VAC
Power Consumption	
Maximum	11.0 kW
Minimum Power Factor	0.90
Dimensions (Max.)	42-inch (L) x 35-inch (W) x 46-inch (H) Center-of-Gravity (CG) not higher than 23-inches from bottom
Refrigerant	R410A (6.7 lbs (3.04 kg) total charge), non-ozone depleting
Minimum Evaporator Air Flow	1,700 SCFM
Gross Weight	560 lbs.
Compressor	Oil type: Compressor Polyester Oil (CPOE) Capacity: 60 oz
Minimum Cooling Capacity:	Total: 60,000 Btu/hr (Minimum) Sensible: 45,000 Btu/hr (Minimum) Desired Sensible: 48,000 Btu/hr 50 Hz Total: 44,000 Btu/hr (Minimum)
Minimum Heating Capacity:	Total: 9.94 kW (33,935 Btu/hr)
Minimum Fresh Air Airflow	280 SCFM
Noise Level	<80 dbA

Figure 4-20. EnergyPlus-predicted heating load and IECU power for SIP hut.

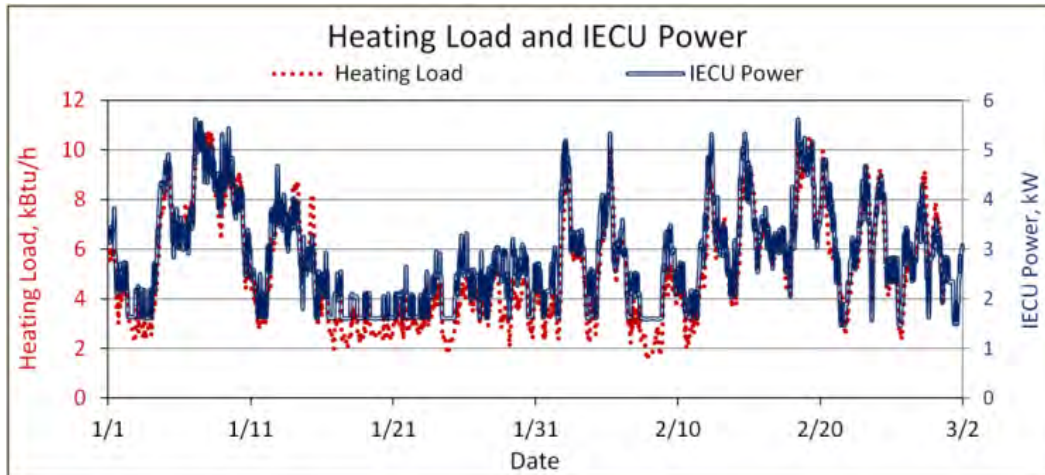

Figure 4-21 shows the correlation between the IECU energy use and the EnergyPlus calculated heating load. The linear regression equation allows the

calculation of the approximate IECU power from the EnergyPlus-estimated heating load for the SIP hut. The average heating load from the SIP hut from January to February 2015 was 1.95 kW and the average IECU power for the same period was 2.85kW. Therefore, energy consumption by the IECU was 1.95 times the heating load. The major contributors to this loss are the heat loss from the flexible supply and the return ducts between the IECU and the shelter, and the heat loss from the IECU housing. Heat transfer through the ducts will be modeled using AirflowNetwork subroutine in EnergyPlus to include in final report. Figure 4-22 shows the IECU that serves the SIP hut and the flexible ducts used as supply and return ducts.

#### 4.7 Energy performance comparison: SIP hut vs. B-hut

This study attempts to determine the energy efficiency of the SIP hut relative to the baseline B-hut. To that end, the energy used by the IECUs serving each hut was compared. The IECU alone could not maintain the desired temperature condition in the baseline B-hut; therefore, supplemental electrical resistance heaters were also used and their energy use was included in this report.

Figure 4-21. Correlation between EnergyPlus-predicted heating load and IECU power for SIP hut.

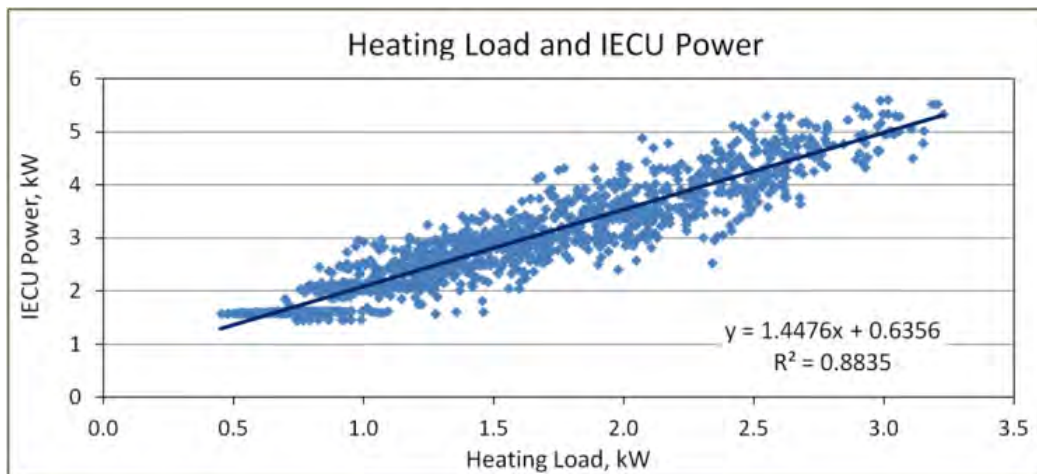

Figure 4-22. IECU serving the SIP hut and the flexible ducts used as supply and return ducts.



Figure 4-23 shows hourly heating energy use and Figure 4-24 shows indoor air temperature in the two huts. IECUs at the two EFOB-L B-huts were tripped during part of the first half of January 2015, which explains the missing data in these figures. Figure 4-25 shows the weekly average of the hourly heating energy for when the IECUs were operating in both huts. Indoor air temperature swing in the baseline B-hut was much more variable than that of the SIP hut during the monitoring period.

Figure 4-23. Hourly heating energy use in the test huts.

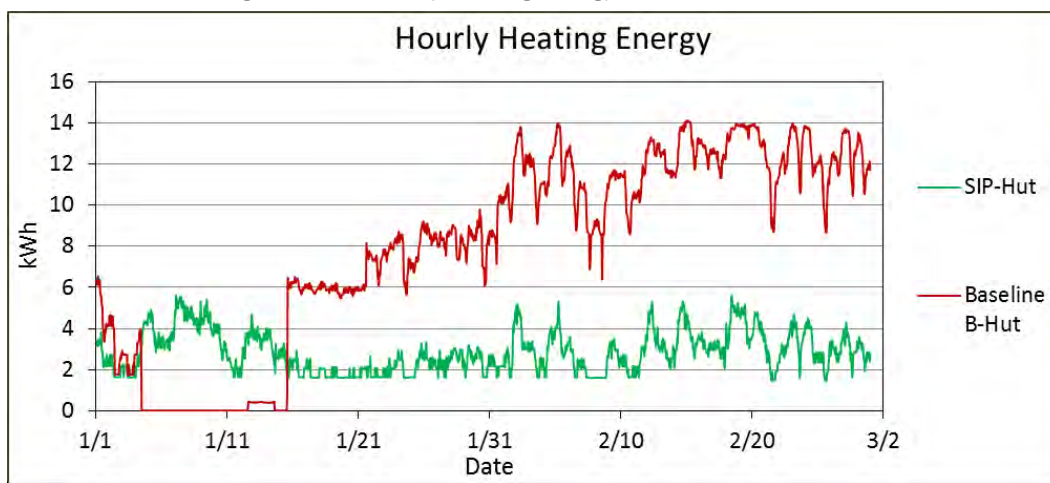

Figure 4-24. Indoor air temperature in the test huts.

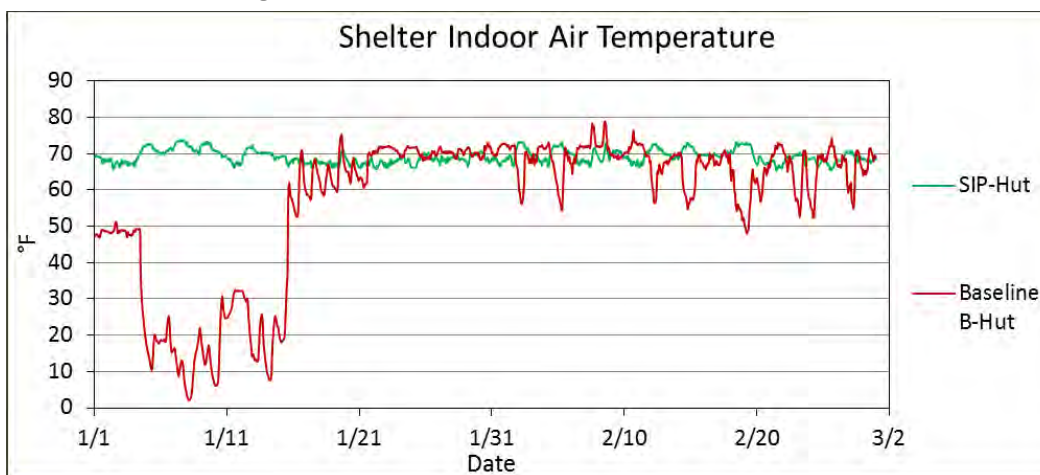
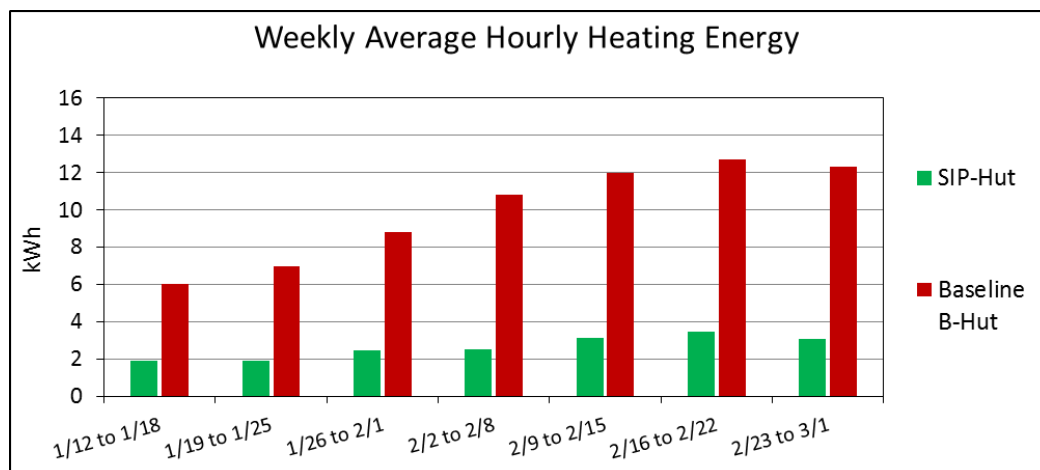

Figure 4-25. Weekly average of hourly heating energy, unadjusted for indoor air temperature.



To estimate the heating energy use in each hut as if they were maintained at 70 °F, a fixed indoor air temperature of 70 °F was set in EnergyPlus and the simulations were rerun. Correction factors were calculated as ratios between EnergyPlus-predicted heating load when the indoor air temperature was set at 70 °F and when the measured indoor air temperature from each hut was used in EnergyPlus. Multiplying the measured IECU hourly energy use from each hut by these correction factors gives heating energy demand if the indoor air temperature was maintained at 70 °F. Figure 4-26 shows the hourly heating energy, Figure 4-27 shows the weekly average of the hourly heating energy, and Table 4-5 lists the average and maximum hourly heating energy after adjusting the indoor air temperature to 70°F for periods of time when the IECUs were on in both huts.

Figure 4-26. Hourly heating energy after adjusting indoor air temperature to 70 °F.

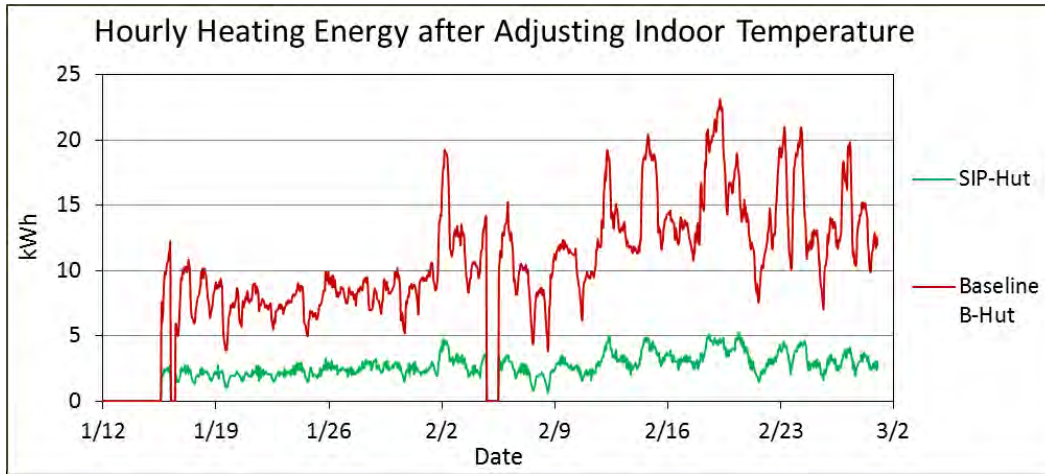

Figure 4-27. Weekly average of hourly heating energy, after adjusting indoor air temperature.

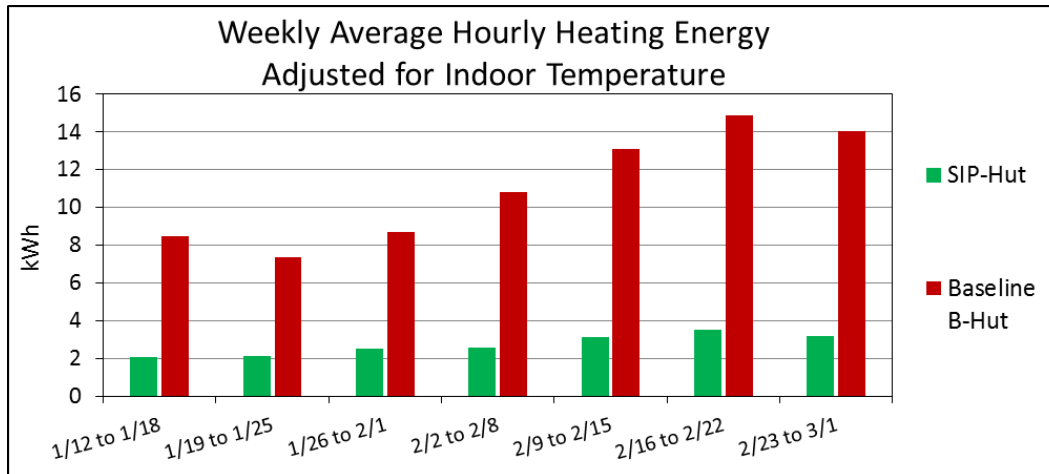

Table 4-5. Hourly heating energy at 70 °F indoor air temperature, kWh.

	Average	Max
SIP hut	2.77	5.28
Baseline B-hut	11.21	23.14

IECUs in the SIP hut and B-hut were instrumented in August and December 2014, respectively. Therefore, cooling energy use data were not available at the time of the writing of this report to compare performance of the huts during cooling season. However, simulation results of the semi-calibrated EnergyPlus models were used to predict cooling load ratio of the SIP hut and the B-hut, which show that the SIP hut will require about one-sixth of cooling energy as compared to the baseline B-hut. A fixed cooling setpoint of 75 °F, unoccupied hut with no internal load, and weather file

for Champaign, IL were used for those simulations. Analysis will be performed and presented in a final report that will determine sensitivity of setpoint temperature and internal load on cooling and heating energy demand for various locations.

A notable observation from the data collected so far is that not only did the B-hut require much more heating energy than did the SIP hut, but its energy use varied much more broadly than the B-hut's relatively consistent level of energy use. At the same time, the temperature swings inside the B-hut were also much greater than inside the SIP hut, which would cause discomfort to the B-hut's occupants. The B-hut will require a larger heating/cooling unit to maintain a consistently comfortable temperature level. A base with a number of B-huts will also need to maintain a larger capacity power generation capability to handle peak energy usage compared with a base with a similar number of SIP huts.

## 5 Air Quality Study

ERDC-CERL performed two separate IAQ studies on the ERDC-CERL SIP hut in May 2014 and March 2015. The SIP components are constructed of polyurethane closed-cell foam sandwiched between two sections of OSB. The SIP hut panels' exterior surfaces were also painted with a Line-X<sup>®</sup> protective coating (see Appendix B for technical data sheets), and openings in the structure were sealed using spray polyurethane foam and several types of caulk. All of these materials have the potential for emitting chemicals into the indoor air through outgassing, i.e., the release of various gases from the materials. The combination of a tight building structure and outgassing of construction materials could lead to an uncomfortable or unsafe IAQ environment.

The objective of this work was to determine if the SIP hut provides a safe IAQ environment for Soldiers occupying the hut. These studies were specifically targeted toward outgassing of construction materials. The second study also included measurements to determine the effectiveness of an energy recovery air ventilation system in reducing the indoor total VOC concentration.

### 5.1 May 2014 ERDC-CERL SIP hut IAQ study: Construction material outgassing

The IAQ sampling and data collection took place from 20 through 22 May 2014. The weather during the 3 days was quite variable. High/Low temperatures varied from 87/58 °F, 91 /66 °F, 77/56 °F, respectively, during each day of this period. The high temperature for 21 May 2014 set a new local record. Appendix C includes other weather details for these 3 days.

#### 5.1.1 Experimental setup

##### Ventilation system

Heating, cooling, and ventilation for the SIP hut were provided by a 60K BTU/hr IECU), HD-1240/G, Model 60K IECU. Figure 5-1 shows a photo of the Model 60K IECU. The IECU is controlled with a remote control unit (Figure 5-2).

Figure 5-1. 60K Btu/hr IECU.

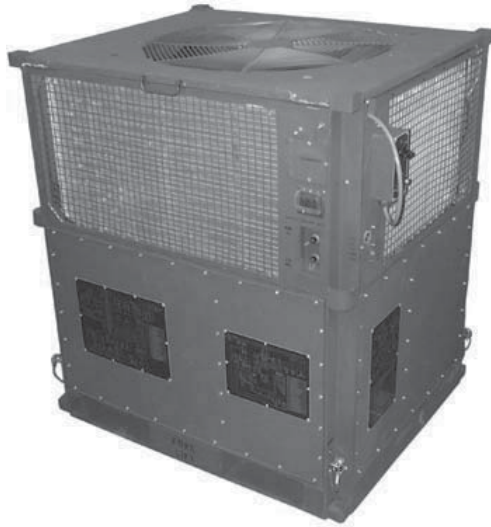
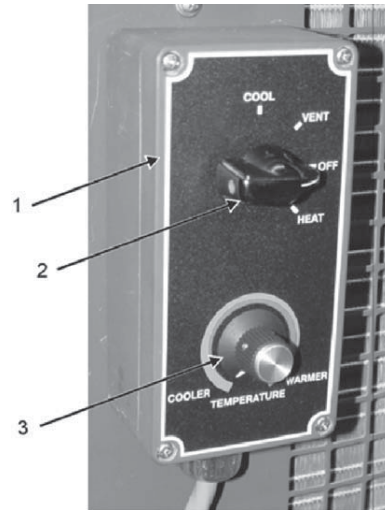

Figure 5-2. IECU remote control unit.



The remote control unit has a selector switch and a thermostat dial control. The selector switch has settings for off, vent, heat, and cool. The “OFF” setting de-energizes all functions of the IECU, the “VENT” setting turns on the evaporator blower motor without heating or cooling, the “HEAT” setting turns on the evaporator blower motor and allows heating but not cooling, and the “COOL” setting turns on the evaporator blower motor and allows cooling but not heating. When “VENT,” “HEAT,” or “COOL” are selected, the evaporator blower motor operates continuously. The IECU allows outdoor air ventilation through a slotted flange assembly at the return air inlet (Figure 5-3). The amount of outdoor air is roughly controlled by sliding the return air duct to expose more or less of the slots in the return air duct flange.

### 5.1.2 IAQ assessment methods

The study focused on potentially toxic organic gases known to outgas from construction materials. The testing included a real-time continuous measurement of total VOCs, Dräger-tube real-time measurement of formaldehyde and styrene, collection of gas samples in evacuated canisters for later laboratory analysis using EPA TO-15, and collection of gas samples in sorbent tubes for later analysis of aldehydes using NIOSH Method 2016. Total VOCs measurement can be a general qualitative indicator of IAQ problems; formaldehyde and other aldehydes are common organic gases emitted from OSB; and styrene was initially selected since most SIPs contain polystyrene foam.

Figure 5-3. IECU drawing – showing the location of the slotted flange assembly.

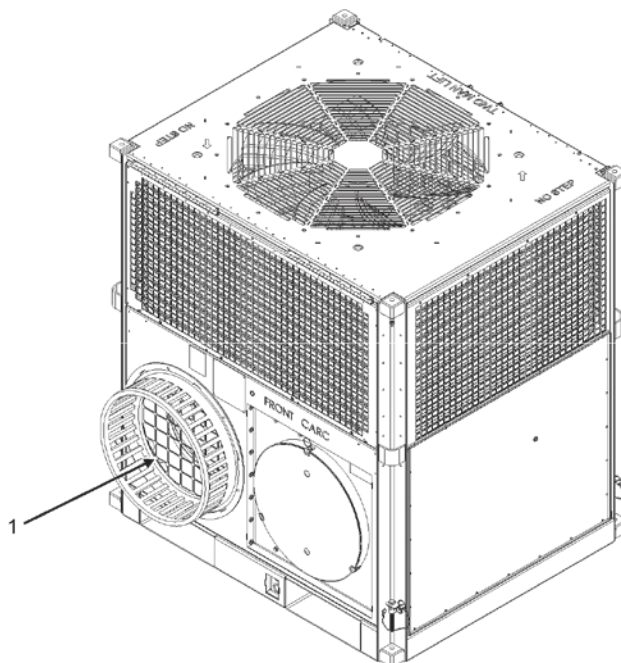

Later it was determined that the foam was polyurethane limiting the value of any styrene results. EPA TO-15 has become a common method for determining concentrations of around 75 specific toxic organic air emissions in indoor air and NIOSH Method 2016 is a common way to measure aldehyde emissions in indoor air. All these testing methods were employed at the same time during each of the test conditions that will be described later in this report.

#### 5.1.2.1 Total VOCs

The real-time total VOCs testing was conducted using an RAE Systems ppb RAE 3000 (SN 594-903299) portable photoionization detector (PID) with a parts per billion (ppb) detection resolution. The device was programmed to record an average VOC reading every minute. The data were recorded in the local memory of the device and later downloaded to a computer. The detector was calibrated before each test using a 10 parts per million (ppm) (10,000 ppb) isobutylene in air calibration mixture. Before each SIP hut test, the PID detector was started outside the hut to sample ambient air (with an expected 0 ppb reading) before being moved into the hut. The device was placed on a table near the center of the hut for the majority of each test, which lasted about an hour. Occasionally the PID detector was briefly moved around the hut to the corners and other locations to determine if

there were specific VOC emission points. This PID detector does not speciate the VOCs, but instead measures the total hydrocarbon concentration in terms of the reference gas (isobutylene). As a general guideline, a concentration value of 1,000 ppb or higher indicates that the VOC level may be of concern (RAE Application Note AP-212). The severity of the concern depends largely on the specific compounds present. Therefore, the total VOCs concentration should only be considered as a qualitative indicator.

#### 5.1.2.2 *Speciated VOCs*

Specific VOCs were measured using EPA Method TO-15. In Method TO-15, samples are collected in an evacuated stainless steel canister known as a SUMMA<sup>®</sup> canister and sent to a laboratory for analysis of specific VOCs by a gas chromatograph/mass spectrometer (GC/MS). The laboratory analyzes the gas sample for a specific list of organic gases found in the method. The SUMMA<sup>®</sup> canister collects the gases at a constant flowrate using a critical orifice built into the canister collection tubing. Sampling is complete when a regulator gauge attached to the canister shows that the pressure inside the canister is close to ambient. The samples in the SIP hut were collected over about a 20-minute sampling period on a table in the middle of the hut.

#### 5.1.2.3 *Formaldehyde and other aldehydes*

Aldehydes were measured using both Dräger-tubes and by NIOSH Method 2016. The Dräger-tubes work by pumping a specified volume of air through the tubes that will express a color change when aldehydes are present. Dräger-tube formaldehyde 0.2/a in conjunction with an activation tube were used in combination to get the lowest range of detection possible (0.04 to 0.5 ppm). The color changes from white to pink in the presence of formaldehyde. Styrene, vinyl acetate, acetaldehyde, acrolein, diesel fuel, and furfuryl alcohol are interferents and are indicated with a yellowish brown discoloration of the tube. The Dräger-tube measurements were made in the center of the SIP hut near the beginning of each test. The pumping of the specified amount of air took from 25 to 30 minutes.

Aldehyde sampling through sorbent tubes also occurred near the center of the SIP hut. The flowrate of the sample pump was set at 0.25 L per minute (lpm) and the samples were collected for an hour so that 15 L of air flowed through the sorbent tube. This is the maximum amount allowed by the NIOSH method and therefore provides the lowest detection level possible

(0.012 ppm for formaldehyde). The aldehyde profile for detection included acetaldehyde, acetone, acrolein, formaldehyde, butyraldehyde, benzaldehyde, and crotonaldehyde. Unfortunately these samples were lost by the laboratory, and no results from NIOSH Method 2016 will be reported.

#### 5.1.2.4 Styrene

Styrene was measured using Dräger-tube Styrene 10/a. Dräger-tubes work by pumping a specified volume of air through the tubes that will express a color change when styrene is present. The measurement range of this tube is 10 to 200 ppm. The color changes from white to pale yellow in the presence of styrene. Other organic compounds that tend toward polymerization (e.g., butadiene) are interferents, but with different sensitivities. It is impossible to measure just monostyrene in the presence of these compounds. The Dräger-tube measurements were made in the center of the SIP hut near the beginning of each test. The pumping of the specified amount of air took about 2 minutes.

### 5.1.3 Test conditions

The study was broken into five test conditions to examine a range of IECU settings and SIP hut environmental conditions, as described below.

#### 5.1.3.1 Test 1: Baseline testing

Test 1 was conducted outside and upwind of the SIP hut on 20 May 2014. The average outside temperature was 83 °F. This test determined background levels in the ambient air for all chemical testing.

#### 5.1.3.2 Test 2: IECU remote control set to OFF

Test 2 was conducted inside the SIP hut on 20 May 2014. These conditions were considered the worst case scenario. The SIP hut was undisturbed at least overnight and a small fan was operated inside to help evenly mix the air inside the SIP hut. The temperature inside the hut was about 74 °F and the outside temperature was 85 °F.

5.1.3.3 *Test 3: IECU remote control set to VENT and the slotted flange covered so that there was no fresh air circulation*

Test 3 was conducted inside the SIP hut on the morning of 21 May 2014. The IECU was started from the OFF setting 2 hours before the testing began. The temperature inside the hut was about 90 °F for most of the test with similar temperature outside the hut.

5.1.3.4 *Test 4: The IECU remote control set to VENT and the slotted flange completely uncovered so that there was maximum fresh air circulation*

Test 4 was conducted during the afternoon of 21 May 2014. The IECU was allowed to operate this way for 2½ hours before the test. The SIP hut was definitely pressurized under this setup as was evident by the increased difficulty opening the door. The temperature in the SIP hut averaged 94 °F during the test.

5.1.3.5 *Test 5: The IECU remote control set to COOL and the slotted flange covered so that there was no fresh air circulation*

Test 5 was conducted on the morning of 22 May 2014. The air-conditioning was turned on the previous day after Test 4 and allowed to operate overnight. The air temperature was ~72 °F inside the hut during this test.

#### **5.1.4 Test results**

Table 5-1 summarizes total VOCs testing results across the entire test period. Figure 5-4 shows average VOC concentration per minute during the five test conditions. The average concentration appears to be very similar during the non-background test scenarios except for Test 3, where the concentration is about 10 times higher. The temperature inside the SIP hut was very high during Test 3, which probably resulted from the volatilization of VOCs from the construction materials and there was no fresh makeup air to dilute contaminated air in the hut. The total VOCs levels are fairly high for all test conditions other than Test 3, but are probably of no great concern based on the 1,000 ppb level of concern. However, total VOCs results are considered a qualitative measure of IAQ and safety is most often judged by concentrations of individual organic chemicals in the air. Test 3 does indicate conditions that would be of concern and that would likely not be safe under prolonged exposure.

Table 5-1. Total VOC results summary.

Test	Description	Avg. Conc.(ppb)	Temp (°F)
1	Background test, outside	0	83
2	Air handling system off	798	74
3	Air handling system on, no fresh air	7114	90
4	Air handling system on, full fresh air	668	94
5	Air handling system on, cooling, no fresh air	774	72

Figure 5-4. Total VOCs inside ERDC-CERL SIP hut during May 2014 IAQ study.

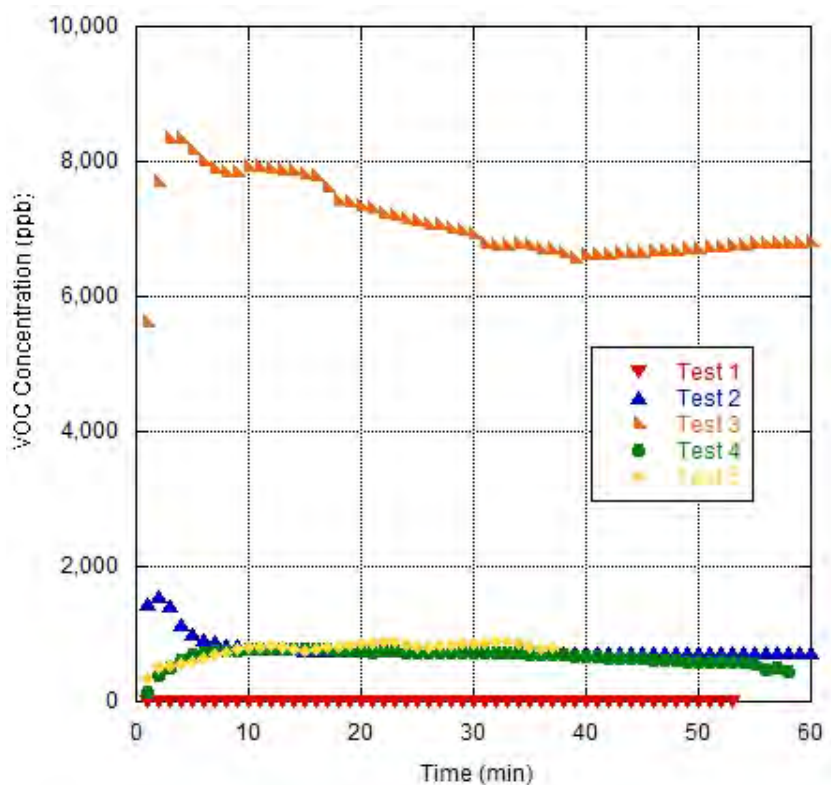

#### 5.1.4.1 Test 1: Baseline testing

The PID detector readings showed that the average concentration was 0 ppb. In fact, all of the 1-minute average measurements during the baseline testing were 0 ppb.

#### 5.1.4.2 Test 2: IECU remote control set to OFF

The VOC reading started at 0 ppb outside the hut and then quickly ramped up to over 1000 ppb (1583 ppm recorded maximum) on initially entering the hut. The concentration then began to steadily drop throughout the

hour measurement period. The average recorded concentration starting from the first full minute of reading (Index 6 through 65) inside the hut was 798 ppb.

5.1.4.3 *Test 3: IECU remote control set to VENT and the slotted flange covered so that there was no fresh air circulation*

Reading started at 0 ppb outside and quickly ramped up on entering the hut to over 8000 ppb (maximum recorded is 8426 ppb). The average reading for 60 minutes from the time of the first complete minute inside (Index 4 through 63) is 7114 ppb. After the hour test, the monitor was moved around the hut and similar readings were observed in all parts of the hut. After taking the monitor outside, the readings went down to just under 100 ppb, but not 0 ppb. This could be caused by residual VOCs in the sampling tubing and the detector.

5.1.4.4 *Test 4: IECU remote control set to VENT and the slotted flange completely uncovered so that there was maximum fresh air circulation*

The reading starting at 0 ppb and increased to maximum of 790 ppb at about 15 minutes into the test, and then slowly declined. The average VOCs reading (Index 3 through 60) was 668 ppb.

5.1.4.5 *Test 5: IECU remote control set to COOL and the slotted flange covered so that there was no fresh air circulation*

The VOCs measurements were only taken for 37 minutes during this scenario because an aldehyde sorbent test was not conducted simultaneously. The VOCs reading went up to a maximum of 903 ppb twice at 22 and 33 minutes into the test. The average VOCs reading (Index 4 through 40) was 774 ppb.

### **5.1.5 Speciated VOCs**

Table 5-2 lists the results of all chemicals that were detected in the SUMMA<sup>®</sup> canister samples for each test. The table also includes each chemical's NIOSH Recommended Exposure Limit (REL). RELs are occupational worker safety limits that should protect worker safety and health over a working lifetime. With the exception of 1,4-dioxane, all the RELs are exposures for time weighted averages across an entire working day.

Table 5-2. Summary of EPA TO-15 concentration results in ppm.

Chemical Name	RELs <sup>i</sup> (ppm)	Test Number				
		Test 1	Test 2	Test 3	Test 4	Test 5
Ethanol	1,000	ND <sup>ii</sup>	0.034	0.043	0.0077	0.0093
Isopropyl alcohol (2-Propanol)	400	ND	0.054	0.12	0.0099	0.017
Acetone	250	0.0061	0.3	0.74	0.071	0.12
Acetonitrile	20.0	ND	0.26	0.28	0.1	ND
2-Butanone (MEK)	200	ND	ND	0.0084	ND	ND
Heptane	85	ND	ND	0.0072	ND	ND
1,4-Dioxane	1 <sup>iii</sup>	ND	ND	0.006	ND	ND
Toluene	100	ND	0.019	0.0085	ND	ND
Xylene (p,m)	100	ND	0.016	0.013	ND	ND
Xylene (Ortho)	100	ND	0.008	0.0065	ND	ND
Total target compound concentrations		0.0061	0.69	1.2	0.19	0.15

<sup>i</sup>REL = NIOSH Recommended Exposure Limits  
<sup>ii</sup>ND = non-detect  
<sup>iii</sup>30 minute average concentration that should not be exceeded at any time.

The REL for 1,4-dioxane is a 30-minute averaging time exposure value. All the results were well below the NIOSH REL values. The closest any of the results come to their REL value is acetonitrile for Test 3, which is 1.4% of its REL. Appendix D includes detailed EPA Method TO-15.

### Formaldehyde and styrene

None of the Dräger-tube tests for either formaldehyde or styrene showed any detectable concentrations of these chemicals. The formaldehyde tubes did show some interference results from other chemicals as indicated by a yellowish brown discoloration in the tubes, which was most evident in Test 3.

#### 5.1.6 Conclusions and recommendations

The IAQ testing results from the IAQ study of the SIP hut show that the hut can be made into a safe IAQ environment by not allowing high temperatures within the hut and by providing some outdoor air ventilation per standards such as ASHRAE 62.1 or 62.2. In the case of the Model 60K IECU used during this testing, ventilation is provided by uncovering the slotted flange assembly at the return air inlet. These recommendations are based on the total VOC results that showed a potentially unsafe condition when there were both high temperatures inside the SIP hut and no outside air ventilation. Test 2 and Test 5 also had no outside air ventilation, but the cooler indoor temperatures seemed to limit the outgassing from the

SIP hut construction materials. Test 4 had slightly higher inside temperatures than Test 3, but the outside air ventilation provided by the IECU seemed to dilute the indoor air enough to compensate for the outgassing of SIP hut construction materials.

None of the test results for any specific analyzed organic gas showed concentrations that would be of concern based on NIOSH RELs. There is some evidence that some of the organic gases detected by the handheld PID device were not part of the EPA TO-15 analyte list. This is because the sum of all the TO-15 concentration results were well below each of the total VOC test condition results and because none of the individual gases showed the large concentration increase for Test 3 that was indicated in the total VOC results.

If future testing of SIP hut construction material outgassing is performed, the TO-15 analyte list should be expanded and “library” type analyses should be performed for GC/MS results that fall outside of the requested analyte list. In addition, the NIOSH Method 2016 should be repeated to get results from this potentially meaningful test.

Other recommendations for future SIP hut IAQ testing include:

- Test the potential for “baking out” volatile chemicals in the construction materials to reduce future emissions from these materials. A bake out would entail raising the temperature in the SIP hut to a high level in hopes of volatilizing a large portion of the reservoir of volatile components found in the construction materials.
- During Soldier occupation of the SIP hut, perform continuous testing of IAQ related parameters such as temperature and concentrations of water vapor and carbon dioxide. Soldier occupation will introduce new sources of indoor air emissions from the Soldiers themselves and any activities performed in the SIP hut.
- Test the potential of separating the heating and cooling of the SIP hut and ventilation of the hut with outdoor air. A common strategy for similar “tight” energy efficient structures is the use of a heat recovery ventilator (HRV) or an energy recovery ventilator (ERV) system that provides adequate ventilation while minimizing the energy expenditure for the ventilation. The choice of an HRV or an ERV is based on the anticipated humidity level; an ERV system is appropriate for areas with higher humidity.

## **5.2 March 2015 ERDC-CERL SIP hut IAQ Study: Outgassing and ventilation effects**

An additional test phase was planned as a follow up test to the initial study performed on the ERDC-CERL SIP hut conducted in May 2014. During one test of the initial study, a total VOC concentration of concern was present (average 7114 ppb) when the indoor air temperature was high (90 °F) and there was no outside air ventilation. This was most likely due to building material outgassing. The primary objective of the second test was to determine if an issue remains with the VOC level and if so, whether the newly installed energy recovery air ventilation system would effectively reduce the indoor total VOC concentration. The test also showed the effect of occupancy on the level of CO<sub>2</sub> concentration inside the SIP hut. There are two notable differences between the two studies: the outdoor temperature range for the second study was much less than during the initial test, and the SIP hut was 10 months older.

### **5.2.1 Experimental setup**

This study employed a different portable VOC monitor, a TSI Model 7575-X handheld Q-Trak monitor with a 986 probe. The 986 probe is capable of 10ppb VOC detection with a PID that uses a Krypton lamp (10.6eV). The Krypton lamp detects a wide range of VOCs with the notable exception of formaldehyde, methanol, acetylene, and some halogenated compounds. The monitor used in the previous study uses a similar detector, but with a lower detection limit (1 ppb). The VOC monitor was calibrated at the factory (10 July 2014) using isobutylene as the reference compound. Calibration did not take place in the field during this test because the proper regulator for the calibration cylinder was not available. This is acceptable because the total VOCs level is a quality indicator of the actual VOC concentration due to probable mixtures of VOCs, and testing the background level of VOCs outside the hut provided an adequate zero level for the tests. This probe is also capable of measuring carbon dioxide (CO<sub>2</sub>), temperature, barometric pressure, and humidity, all of which were recorded during the tests.

After warming up the detector, a background level of VOCs was recorded from outside the SIP hut and then the meter was set up near the center of the hut at a height of about 3 ft. It was positioned in the same location for all tests. Data were recorded every 10 seconds to the internal storage of the

monitor. After all tests were conducted, the data were downloaded by computer and placed in Microsoft Excel spreadsheets for analysis.

The air handling system (IECU) with the temperature control (heat) was operated before all test conditions, primarily because the outside temperature was lower than room temperature. The “normal” heat setting is when the thermostat is set at the  $\frac{1}{2}$  point on the temperature dial. The resulting temperature in the hut at this setting is approximately 75 °F. The heat was increased for some tests. The “full” setting is when the dial is positioned as far clockwise as possible (pointed toward “warmer”). The IECU’s manual ventilation system (slotted flange) was closed as much as possible during all tests to prevent intentional ventilation due to the IECU. The time duration of each test varied.

A ventilation system was installed between the time of the original testing in May 2014 and this study. The Fantech\* HRV model SHR 1504 has a maximum ventilation rate of 170 cfm at 0.2 inches water gauge. Figure 5-5 shows the installed system with ducting positioned near the ceiling of the SIP hut. Figure 5-6 shows the manufacturers label, the electrical connections, and speed switch located on the ventilator. Table 5-3 lists the conditions during each test.

Figure 5-5. Fantech SHR 1504 heat recover ventilator installed in ERDC-CERL SIP hut.



\*Fantech, 10048 Industrial Blvd, Lenexa, KS, 66215, [www.fantech.net](http://www.fantech.net)

Figure 5-6. Fantech SHR 1504 HRV electrical panel.



Table 5-3. March 2015 ERDC-CERL SIP hut IAQ study test conditions

Test#	Heat	Temp Inside (°F)	Temp Outside (°F)	Wind* (mph)	Ventilation System	Time Duration (min)	Comments
1	normal	73	9	19 NW	off	40	Early test on 2/18/15
2A	normal	68	22	19 S	off	20	
2B	¾ setting	68-84	50	9 ESE	off	208	Heat turned up at start of test
3	full	84	42	4 E	off	220	
4	full	83	50	4 NE	on (med)	90	Started right after Test 3
5	normal	75-80	61	9 WNW	off	60	Warmer day, the inside temperature increased some during the test without adjusting the heat
6	full	68-83	46	16 E	off	180	Heat turned up at start of test
7	off	81-78	58	13 E	off then on (med)	97	Started after Test 6. Hut at higher temperature to start from Test 6. Midway through the test the ventilator was started

\* Note that the ERDC-CERL SIP hut is a rectangular building oriented with the two ends with doors positioned north and south.

### 5.2.2 Test results

The original plan was to test the effect of different ventilation schemes on the VOCs level inside the hut. However, because the VOCs concentration was negligible for all tests, introducing ventilation would have no meaningful impact on that concentration. Table 5-4 lists the VOCs levels during all the tests.

At no time did the VOCs concentration approach a level that would indicate a concern (1.00 ppm). The highest VOCs concentration recorded was 0.04 ppm. In contrast, the VOCs concentration exceeded 7 ppm under a warm indoor temperature (90°F) during the May 2014 study. The highest temperature achieved for the current tests using the IECU was 85°F during Test 3. The VOCs concentration did go up slightly during Tests 3 and 4, which could be explained by the low wind speed during these two tests. That caused the natural ventilation through building leaks to be at its lowest for all the tests.

The measured barometric pressure remained nearly constant throughout each test and the RH changed slightly with respect to temperature, as would be expected. However, the most interesting result was a noticeable increase in the CO<sub>2</sub> concentration when the test operator was inside the hut, and a noticeable decrease in CO<sub>2</sub> concentration when the ventilation system was turned on or when the operator left the hut. Figure 5-7 shows the CO<sub>2</sub> concentration observed during all tests.

Table 5-4. ERDC-CERL SIP hut total VOCs study VOCs results (ppm).

Test #	Start	End	Max	Avg
1	0.00	0.00	0.00	0.00
2A	0.00	0.00	0.00	0.00
2B	0.00	0.00	0.00	0.00
3	0.02	0.04	0.04	0.02
4	0.04	0.03	0.04	0.03
5	0.01	0.02	0.02	0.01
6	0.00	0.01	0.01	0.00
7	0.01	0.01	0.02	0.02

Figure 5-7. Carbon Dioxide Concentration inside ERDC-CERL SIP hut during March 2015 IAQ study.

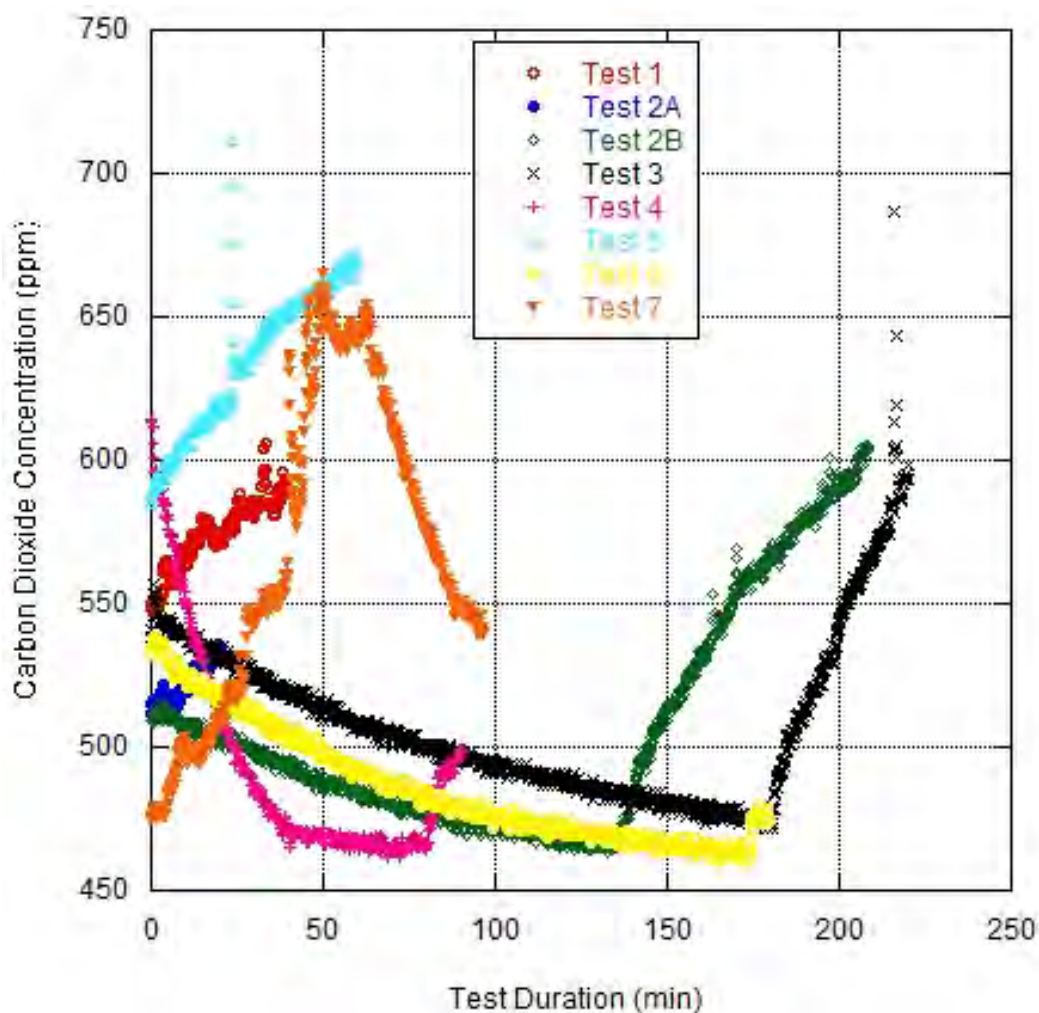

The background CO<sub>2</sub> concentration (outside) was about 470 ppm as measured by the monitor. Most of the tests start at an elevated CO<sub>2</sub> level because the operator was in the hut performing test preparation before the start. The operator was positioned approximately 5 ft away from the sensor during the tests, with occasional movements to check on readings and equipment. According to the Illinois Department of Public Health, a CO<sub>2</sub> concentration above 1000 ppm is an indication of poor ventilation.\* Given the trends shown in Figure 5-7, it appears that that concentration could be reached in a number of hours, and most probably in a much shorter time

\* [http://www.idph.state.il.us/envhealth/factsheets/indoorairqualityguide\\_fs.htm](http://www.idph.state.il.us/envhealth/factsheets/indoorairqualityguide_fs.htm)

period with multiple persons present. The following sections include observations related to the CO<sub>2</sub> concentration and ventilation are described for each test.

#### 5.2.2.1 Test 1

The operator was present during this test and there was a strong North-west wind. Natural ventilation was noticeable through the north door. A slight increase in CO<sub>2</sub> was observed.

#### 5.2.2.2 Test 2A

The operator was present during this test and there was a strong south wind. Natural ventilation was noticeable through the south door. A slight increase in CO<sub>2</sub> was observed during this short test.

#### 5.2.2.3 Test 2B

The operator was not present during the beginning of the test. There was a moderate WNW wind and natural ventilation was not noticeable through the doors. Initially the CO<sub>2</sub> level decreased from a level caused by the operator during test preparation. The operator re-entered the room after 135 minutes, which corresponds to the immediate upward slope of the data curve in Figure 5-7. The operator remained in the hut for the remainder of the test and the CO<sub>2</sub> level climbed above 600 ppm when the test ended.

#### 5.2.2.4 Test 3

There was a light east wind during this test resulting in no noticeable draft near the doors. Similar to Test 2B, the operator was not present during the first part of the test and re-entered the hut after 180 minutes. The CO<sub>2</sub> level decreased from the initial level (due to operator being present before test start) and then immediately began to increase when the operator returned as shown by Figure 5-7. The slope of this data curve is even sharper than for Test 2B probably because the wind was very low and coming from a direction where there were no doors so there was less natural ventilation.

#### 5.2.2.5 Test 4

This test started 6 minutes after Test 3 ended; the CO<sub>2</sub> concentration (606 ppm) started at a level consistent with the end of Test 3 (598 ppm, Figure

5-7). The operator turned the ventilator on (medium setting) and left the hut at the beginning. The rate of decrease in the CO<sub>2</sub> is much greater in this test with the ventilator than without as seen in Tests 2B, 3, and 6.

#### 5.2.2.6 Test 5

This test was started after the operator was present in the hut for 40 minutes. This is reflected in the starting CO<sub>2</sub> concentration (585 ppm). There was a moderate WNW wind and a slightly noticeable draft coming in the north door. As expected, the CO<sub>2</sub> concentration increased throughout the test. This data curve has a spike approximately halfway into the test, which was due to the operator coming close to the sensor to check on the data recording.

#### 5.2.2.7 Test 6

The operator was not present during this test. There was a strong wind, but it was from the east, a side of the hut that has no doors. The CO<sub>2</sub> concentration curve is very similar to Test 2B and shows a decrease to the background level throughout the test. There was a small increase at the very end when the operator came back inside the hut to end the test.

#### 5.2.2.8 Test 7

This test was started right after Test 6, which is shown by the consistency between the initial CO<sub>2</sub> value of Test 7 (476 ppm) and the final CO<sub>2</sub> value of Test 6 (474 ppm). The IECU was turned off for this test so there was no air circulation or manual venting, and the natural ventilation was minimal due to the east wind. The CO<sub>2</sub> concentration increased quickly. At 40 minutes into the test, three other persons entered the hut and remained for 5 minutes. This is reflected in the sudden spike and stronger increase in the CO<sub>2</sub> concentration. At 1 hour into the test, the operator turned on the ventilator (medium) and the CO<sub>2</sub> concentration decreased in a similar manner seen in Test 4 until the end of the test.

### 5.2.3 Conclusions and recommendations for VOC

The measured VOC concentration in the SIP hut was very low during the tests. This indicates that there were no measureable VOC health concerns present and ventilation is not necessary specifically to mitigate VOCs.

However, the data show that the CO<sub>2</sub> level is strongly dependent on occupants and ventilation. They indicate that CO<sub>2</sub> buildup can be a concern if the hut was to be occupied, and a certain level of ventilation will be necessary to prevent occupant related IAQ health concerns. Further tests could be conducted to determine an appropriate ventilation rate, or confirm that the recommended ventilation rate (ASHRAE 62.1, 5 cfm per person plus 0.06 cfm per square foot) is adequate. Based on the results of both studies, it is also recommended that a more thorough study be conducted to define requirements to bring a SIP hut into safe IAQ conditions when it is first constructed so that the amount of time required to remove or reduce potentially toxic gases before troop occupation can be minimized.

## 6 SIP Hut Envelope Performance Issues

Various performance issues with the EFOB-L's SIP hut were observed during the 1-year period beginning after it was first erected in March 2014, to the end of March 2015.

Shortly after the first major rainstorm at EFOB-L, standing water was observed at various locations inside the SIP hut (Figure 6-1). Not only was standing water seen, but water had also absorbed into the OSB panels of the building envelope (Figure 6-2). Closer investigation found that the water intrusion was due to inadequate sealing of the seams between the SIP hut's roof panels. The initial plan was to seal roof joints with silicon caulking. However, the width of the joints made it difficult to correctly seal them with the caulking on-hand.

Several methods were implemented to prevent future occurrence of water leakage. These included the application of various types of sealing tapes and sealants (Figure 6-3). This solution was not fully successful as subsequent observations over the 2014-2015 winter revealed further water intrusion issues. Figure 6-4 shows the formation of icicles at the roof eaves where the SIP seams are located. Gaskets were investigated as part of SIP hut 4.0, but were not perfected. The sealing of roof joints is still an outstanding issue that was not fully addressed in this work, but additional research should be able to solve problem with little additional effort.

The presence of icicles indicates that water had infiltrated into the tapes; their orange color indicates that some breakdown of the sealant between the SIPs may also have occurred. Inspection of the SIP hut's interior found that water was still infiltrating through the panel seams as indicated by water stains at the ceiling-wall interface (Figure 6-5).

External observation of the condition of the exterior of the SIP hut also showed the beginnings of deterioration of the surfaces and edges of the panels. Figure 6-6 shows separation and deterioration of the OSB strands in the panels. While water takes longer to soak into OSB, once the OSB is soaked, it will also take longer to dry out, which makes the OSB more susceptible to rotting (Fisette 2009)

Figure 6-1. Standing water in SIP hut (14 March 2014).



Figure 6-2. Water soaked into OSB panels from leakage (14 March 2014).



Figure 6-3. SIP hut with sealant (left half) and roofing tape (right half).



Figure 6-4. Icicles on seams with sealant (left) and tape (right).



Figure 6-5. Staining on walls from water infiltration.



Figure 6-6. Separation of OSB strands in SIP hut panels.



Figure 6-7 shows deterioration of the edges of the SIP's OSB panels on the fascia of the roof eave. Some separation of the exterior coating is also visible on the bottom side of the SIP's OSB panel. A temporary solution is to apply wide high-performance sealing tape (Figure 6-8) over the fascia surface to cover the edge seams of the SIPs to prevent water intrusion. This type of tape, while very durable and UV-resistant, cannot be exposed to the atmosphere indefinitely and should be covered by flashing when the metal roof is installed. Performing these added steps of roof protection will of course increase the SIP hut construction time, and require additional carpentry skills.

Figure 6-7. Deterioration of the edges of the SIP OSB panels on roof eave fascia.



Figure 6-8. High-performance sealing tape.



Source: <https://sigatapes.com/product/wigluy-230/>

## 7 Integrated Protection of SIP Huts from Chemical/Biological and Ballistic Threats

The SIP hut offers potential advantages over the currently used shelters for protection against chemical/biological threats, since its air infiltration rate, as measured by blower door testing, is low (Table 4-3). The average infiltration rate of a SIP hut is 0.193 cu ft/sq ft, approximately 10 times less than the 1.909 cu ft/sq ft infiltration rate of the B-hut. Tactical AirBeam soft wall shelters have an air infiltration rate of about 0.98 cu ft/sq ft, or 5 times more than that of the SIP hut.

The currently used technology for Chemical/Biological protection of tactical shelters is primarily overpressure (30-50 Pascals) to keep the contaminants out, and High-Efficiency Particulate Air (HEPA) filters, in conjunction with air locks (Figure 7-1) (HDT Global 2015). The minimum overpressure recommended for stationary collective protection shelters is 0.1 inches water gage (iwg) or 25 Pascals, based on preventing air infiltration at ambient wind speeds greater than 15 mph. When preparing buildings and conducting test measurements, it is advisable to provide for a higher pressurization (0.2 iwg Or 50 Pascals) to ensure 0.1 iwg is still achieved over time, as sealing measures and building structures may deteriorate.

The high air infiltration rate for soft walled shelters requires a large volume of air flow, which expends more energy, larger HEPA Filters, and ECUs to handle the airflow. A SIP hut using a smaller ECU with HEPA filters with an average R-value of 25 (as compared to a soft wall shelter with an average R-value of 1) is potentially an energy efficient solution for protection against Chemical/Biological threats in contingency basing. The SIP hut has also shown to be relocatable like a soft shelter. In addition, the Modular Protective System developed by ERDC can also be used for protection against ballistic threats to provide an energy efficient integrated protection to warfighters against Chemical/Biological and Ballistic threats (Figure 7-2). For a video demonstration of the Modular Protective System, see <https://www.youtube.com/watch?v=aCJIICam32U>.

Figure 7-1. Currently available HDT Global Inc. COLPRO System (XCP100) using tactical soft wall shelters and airlocks (<http://www.hdtglobal.com/series/integrated-colpro-systems/>).



Figure 7-2. Integrated protection of SIP hut.



SIP hut and environmental control unit

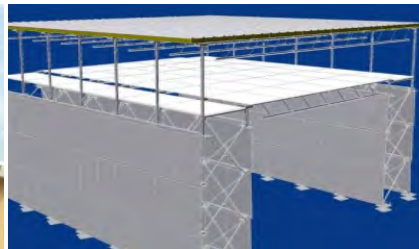

Modular Protective System



HEPA Filter

## **8 Summary, Conclusions, and Recommendations**

### **8.1 Summary**

The SIP hut offers potential energy, logistics, economic and performance benefits, and holds promise as an alternative to existing soft and hard shelters. Its use of SIPs factory-precoated with a durable protective exterior coating, with a built-in cam-lock panel connection system allows a set of panels to be quickly assembled into a complete enclosed structure, even with the use of unskilled labor.

This work evaluated and directly compared a SIP hut co-located with a baseline B-hut with identical floor area to determine and quantify the huts for energy efficiency and IAQ performance. This study found that the SIP hut has excellent building envelope air tightness, can maintain acceptable IAQ levels with proper ventilation, and may potentially use only about one-fourth of the heating energy and one-sixth of the cooling energy required by an ordinary B-hut. The study also found that the SIP hut does have some issues with water intrusion, VOCs emissions, and fire protection requirements, which will be addressed in newer versions of the hut.

### **8.2 Conclusions**

#### **8.2.1 Energy considerations**

Identical IECUs were used to maintain desired indoor air temperature. It was found that the IECU alone could not maintain desired temperature conditions at the baseline B-hut. Consequently, supplemental electrical resistance heaters were subsequently added. Energy performance parameters of the huts were monitored using numerous sensors and power meters. Detailed EnergyPlus models of the huts were created and validated against field-measured data. Thermal properties of materials were measured for use in the EnergyPlus model. An EnergyPlus weather file was created using data collected at EFOB-L's onsite weather station and used for the simulations.

Heating energy demand is a function of the indoor air temperature setpoint vs. exterior temperatures. For this study, the heating and cooling units were adjusted to minimize the variation in indoor air temperatures between huts at all times. A procedure was developed to correlate and estimate heating energy use in each hut if the indoor temperatures were maintained at 70 °F. Adjusted hourly average heating energy demand for the SIP hut and the baseline B-hut for periods of time when IECUs were on at both huts were 2.77 and 11.21 kWh, respectively. The SIP hut required just one-fourth of the heating energy required by the baseline B-hut. Similarly, adjusted hourly maximum heating energy demand (or peak load) for the SIP hut and the baseline B-hut for periods when IECUs were running were 5.28 and 23.14 kWh, respectively.

IECU cooling energy use data were not available at the time of this report writing to compare performance of the huts during cooling season. Hence, simulation results of the semi-calibrated EnergyPlus models were used to predict cooling load ratio of the SIP hut and the B-hut. These predicted results show that the SIP hut will require about one-sixth of the cooling energy that the baseline B-hut will require.

Note that, when the huts were monitored, they were unoccupied and had no internal loads—not even lights. Adding internal loads and occupancy loads will shift the need for heating and cooling energy. Some of the heating hours might also shift to cooling hours. EnergyPlus simulations are planned to evaluate impact of such internal loads on heating and cooling loads. The final report for this project will include those results.

### **8.2.2 Logistics and setup time**

The logistics related to transporting the materials and assembly requirements are also important parameters in comparing the different types of structures. The amount of time required to erect a SIP hut, a B-hut, or a soft shelter was evaluated based on visual observations of construction of actual soft and hard shelters at the ERDC-CERL EFOB-L site. A soft shelter such as an AirBeam tent can be inflated and set up in less than an hour. It does not, however, provide the relative comfort and protection from weather offered by a hard shelter. With its use of factory prefabricated floor, wall, and roof panels, a SIP hut can be substantially completed and ready for installation of electric, lighting, and HVAC equipment in 1 day.

In terms of labor hours, it took untrained Soldiers on average less than 80 work-hours to assemble the SIP huts described in this report. This is a significant reduction in time and effort compared to a equivalently sized B-hut, which can take up to 1 week or more and a crew of 3-4 skilled workers to complete. Design changes made in SIP hut Version 4.0 has further reduced required assembly time to approximately 30 work-hours. The goal of in SIP hut Version 5.0, which will be investigated at West Point in FY16, is reduced required assembly time to less than 20 work-hours.

It is logistically more difficult to ship SIP huts than to ship B-huts or soft shelters. A 20-ft standard container that can contain only one SIP hut (10,000-11,000 lbs) can contain three or four B-huts (~40,000 lbs), or 12 AirBeam tents (8,500 lb). (An AirBeam model 2032 tent with a footprint similar to that of the B-hut and SIP hut has packaged dimensions of 72 x 40 x 40 in.)

### **8.2.3 Air quality study**

Air quality testing of the SIP hut was performed to determine if the SIP hut provides a safe IAQ environment for its occupants since the finished SIP hut is very air tight. The testing measured the amount of outgassing from the construction materials initially and over time, and the effectiveness of an energy recovery ventilation system in reducing the total indoor VOC concentrations.

The first round of testing showed that potentially unsafe conditions inside the SIP hut can occur initially from high VOC concentrations when there were both high temperatures inside the SIP hut and no outside air ventilation. Later tests indicated outgassing does not appear to increase over time. Keeping the interior temperature at a reasonable level and adjusting the IECU or installing a supplemental ventilator to provide some outdoor air ventilation will allow a safe IAQ environment. "Baking out" the VOCs in the construction materials soon after the SIP hut has been constructed may help reduce future emissions from the materials.

### **8.2.4 Effects of weather**

Durability was another key parameter necessary for comparison of life cycle costs between the SIP hut and B-hut. Although this study did not conduct any type of durability testing on OSB or plywood, visual observation

of the SIP hut's exterior surfaces indicated that some areas appeared not to have weathered as well as others. This may be due to uneven application of the protective coating on the SIPs' exterior OSB surfaces. Although OSB and plywood have equivalent structural performance, they respond differently to changes in RH and exposure to liquid water due to their composition. While water takes longer to soak into OSB, once the OSB is soaked, it will also take longer to dry out, which makes the OSB more susceptible to rotting. A B-hut built with exterior OSB panels will be just as vulnerable to water issues if the exterior surfaces are not properly protected against the elements.

As described earlier in this report, the EFOB-L SIP hut also experienced water infiltration between some of the panels, particularly on the roof. Two additional SIP hut 3.0 buildings were constructed at the CBI-TEC in Fort Leonard Wood, MO shortly after the EFOB-L SIP hut. The roof joints in the CBITEC structures were sealed with tape and have had fewer issues with water infiltration.

## **8.3 Recommendations**

### **8.3.1 Air quality study recommendations**

Additional testing has shown that CO<sub>2</sub> buildup will occur if occupants are present inside the SIP hut and no outside ventilation air is provided. Turning on the energy recovery ventilation system was effective in reducing the CO<sub>2</sub> level. CO<sub>2</sub> buildup can also be prevented if the IECU is adjusted to allow exterior air in the air supply. There may be times of the year where providing fresh air through the IECU would not be as energy efficient or effective as using the energy recovery ventilation system. Another recommendation is to add screen doors to the SIP hut's exterior doors. Under many conditions in many places, the best air-conditioning option for a SIP hut would be to simply open the two end doors and let the wind do the work.

Base engineering personnel will need to monitor the operation of SIP huts' IECUs and energy recovery ventilation systems in combination or separately to ensure acceptable IAQ levels are maintained for the occupants in the huts.

### **8.3.2 Water sealing and coating recommendations**

The OSB panel material used for the SIP hut is prone to degradation from moisture. The exterior surfaces of the SIPs must be properly and evenly coated to prevent water intrusion into the OSB, and all exterior joints must be sealed with the most appropriate tapes, sealants, gaskets or membranes to prevent water infiltration. Sealing the structure must be done while the hut is being erected, as sealing afterwards does not yield the desired outcome.

Installing galvanized metal roof panels and a ridge cap on the roof surface will prevent water from entering the seams between the roof SIPs and protect the SIPs' exterior facing surface from weathering effects. SIP Hut 1.0 at USMA had a conventional corrugated steel roof, which added expense, shipping, and construction time comparable to a B-hut, but did not experience water infiltration issues. The use of tape and caulk in lieu of the metal roof was to reduce water intrusion. If this does not work, the use of a metal roof or some other durable membrane should be considered.

Further protection in the form of flashing or drip edges over the roof fascia surfaces will provide the added protection to the currently exposed edges of the SIPs. A temporary solution is to apply wide high-performance sealing tape over the fascia surface to cover the edge seams of the SIPs to prevent water intrusion. This type of tape, while very durable and UV-resistant, cannot be exposed to the atmosphere indefinitely and should be covered by flashing when the metal roof is installed. Performing these added steps of roof protection will of course increase the SIP hut construction time, and require additional carpentry skills. Another possible solution would be to apply a rubber membrane over the entire roof surface. The membrane could be fastened to the underneath side of the eaves to secure it to the structure. Developing a better system for sealing the roof surface will also be investigated as part of work on Version 5.0 during FY16 at West Point.

## **8.4 Issues not addressed**

### **8.4.1 Climate**

This analysis of the performance of the EFOB-L SIP hut was conducted from March 2014 to May 2015. While the weather conditions during this period included all four seasons of central Illinois weather, they do not ap-

proach the temperature and humidity extremes that can be encountered in other extremely cold or extremely hot climatic regions where SIP huts may be deployed. Based on observations of the degradation of the SIP materials over a year's time at EFOB-L, the availability of more durable coating materials should be investigated, and laboratory testing done on the SIP components under more extreme environmental conditions

#### **8.4.2 Fire protection considerations**

This study did not address fire protection was, but construction of SIP huts in the domestic United States must follow the International Building Code (IBC) and National Fire Protection Association (NFPA) fire protection requirements. The IBC classifies most wood frame buildings as Type V. This classification applies to buildings built with SIPs with OSB sheathings as well as B-huts built of lumber and plywood. This code requires a 15-minute fire-resistant thermal barrier, such as ½-inch gypsum board or equivalent performing material, on the interior. Type V buildings used for light commercial or multi-use further require a 1-hour fire rating and a minimum 20-ft separation between buildings. In addition, the NFPA 101: Life Safety Code (revised 2015) requires sprinkler systems in all barracks. Commercially available fire protective coatings can be applied to the surface of the SIPs that will provide at least a 15-minute fire rating. With the size of the hut at 16x32 ft, egress should not be a concern since the furthest distance from any point inside the hut to an exit door is 18 ft.

Unified Facilities Criteria (UFC) 1-201-01 applies to facilities located outside the United States. The UFC requires the same fire protection rating for exterior walls, separation distance, and sprinkler systems as required by the IBC, but these are generally for buildings with floor areas significantly larger than a SIP hut. Waivers from the UFC requirements will need to be requested from the Combatant Commander or delegated engineering authority.

#### **8.4.3 SIP foam disposal considerations**

The proper disposal of foamed structures at contingency bases is a major concern for the Army. Foam pieces that are burned for disposal or as a scavenged fuel source by local inhabitants can emit toxic fumes. Although SIP huts are intended to be reusable, realistically it is doubtful a SIP hut or its components would ever be returned to the continental United States

after a deployment. Optimistically, a SIP hut could be relocated several times as long as joints and connectors are not damaged. Ultimately, however, the SIP hut will likely need to be disposed of at its contingency base location. Given this eventuality, further testing is needed to determine what toxic fumes may be produced if the SIPs, along with their protective coatings, are burned. An alternative approach is to investigate the development of environmentally friendly structural foams that could be used to produce SIPs.

## Acronyms and Abbreviations

<b>Term</b>	<b>Definition</b>
ACH	air changes per hour
ASAALT	Assistant Secretary of the Army for Acquisition, Logistics, and Technology
ASHRAE	American Society of Heating, Refrigerating, and Air-Conditioning Engineers
Btu	British Thermal Unit
CBITEC	Contingency Basing Integration Technology Evaluation Center
CEERD	U.S. Army Corps of Engineers, Engineer Research and Development Center
CERL	Construction Engineering Research Laboratory
CMU	Concrete Masonry Unit
CONEX	Container Express (military shipping container)
CRREL	Cold Regions Research and Engineering Laboratory
DAQ	Data Acquisition System
DoD	U.S. Department of Defense
ECU	Environmental Control Unit
EFOB-L	ERDC-CERL Forward Operating Base Laboratory
EPA	Environmental Protection Agency
ERDC	Engineer Research and Development Center
ERDC-CERL	Engineer Research and Development Center, Construction Engineering Research Laboratory
GC/MS	Gas Chromatograph/Mass Spectrometer
GHG	Greenhouse Gas
HEPA	High-Efficiency Particulate Air (filter)
HFT	Heat Flux Transducer
HQUSACE	Headquarters, U.S. Army Corps of Engineers
HVAC	Heating, Ventilating, and Air-Conditioning
IAQ	Indoor Air Quality
IBC	International Building Code
IDPH	Illinois Department of Public Health
IECU	Improved Environmental Control Unit
JIFX	Joint Inter-agency Field Experiment
lpm	liters per minute
LVL	Laminated Veneer Lumber
MEK	Methyl Ethyl Ketone (2-Butanone)
ND	Non-Detect
NIOSH	National Institute for Occupational Safety and Health
NSN	National Supply Number
NSRDEC	U.S. Army Natick Soldier Research, Development and Engineering Center

---

<b>Term</b>	<b>Definition</b>
ORNL	Oak Ridge National Laboratory
OSB	Oriented Strand Board
PID	Photoionization Detector
PIR	Precision Infrared Radiometer
PUR	Polyurethane
REL	Recommended Exposure Limit
RH	Relative Humidity
SDK	Shade Disk Kit
SEA	Southeast Asia (huts)
SF	Standard Form
SIP	Structural Insulated Panel
SPP	steam producing power
SR	Solar Reflectance
SWA	Southwest Asia (huts)
TE	Thermal Emittance
TM	Army Technical Manual
TO	Technical Order
TR	Technical Report
U.S.	United States
USD	U.S. dollars
USMA	U.S. Military Academy (West Point)
VOC	Volatile Organic Compound

## References

- American Society of Heating, Refrigerating, and Air-Conditioning Engineers (ASHRAE). 2013. *2013 ASHRAE Handbook—Fundamentals*. Atlanta, GA: ASHRAE
- American Society for Testing and Materials (ASTM). 2010. *Standard Test Method for Determining Air Leakage Rate by Fan Pressurization*. ASTM E779. West Conshohocken, PA: ASTM.
- Campbell Scientific. 2015. CR3000 Micrologger. Web page, <https://www.campbellsci.com/cr3000>
- Devices and Services Company (DS). 2014. *Solar Spectrum Reflectometer Model SSR*. Web page, <http://www.devicesandservices.com/prod01.htm>
- Fisette, Paul. 2009. *Choosing Between Oriented Strandboard and Plywood*. Building and Construction Technology. Amherst, MA: University of Massachusetts, <http://bct.eco.umass.edu>
- Gebo, Kevin Michael. 2014. *A Comparison of the Lifecycle Cost and Environmental Impact of Military Barracks Huts in Deployed Environments Constructed from Structural Insulated Panels (SIPs) versus Traditional Techniques*. Thesis. Rochester, NY: Rochester Institute of Technology, <http://scholarworks.rit.edu/theses/7848/>
- HDT Global. 2015. *Product: Integrated COLPRO Systems*. Web page, <http://www.hdtglobal.com/series/integrated-colpro-systems/>
- Headquarters, Department of the Army (HQDA) and Headquarters, U.S. Air Force (HQUSAF). 2011. *Operator, Field, and Sustainment Maintenance Manual for 60k Btu/hr Improved Environmental Control Unit (IECU) HD-1240/G Model 60K IECU NSN 4120-01-543-0741 (EIC: VZ2)*. TM 9-4120-431-14, TO 35E9-9-55. Washington, DC: HQDA and HQUSAF.
- Illinois Department of Public Health (IDPH). 2011. *Illinois Department of Public Health Guidelines for Indoor Air Quality*. Springfield, IL: IDPH, [http://www.idph.state.il.us/envhealth/factsheets/indoorairqualityguide\\_fs.htm](http://www.idph.state.il.us/envhealth/factsheets/indoorairqualityguide_fs.htm)
- International Code Council (ICC). 2007. *International Building Code (IBC)*. Web site. Washington, DC: ICC, <https://www.campbellsci.com/cr3000>
- latlong.net. 2015. *Get Latitude Longitude*. Website, <http://www.latlong.net/>
- LazerComp. 2015. *Thermal Conductivity Instruments*. Web page, <http://www.lasercomp.com/?gclid=Cl-ZqvXDwr4CFRAaOgodPgkA6A>
- National Institute for Occupational Safety and Health (NIOSH). 2003. *NIOSH Manual of Analytical Methods (NMAM)*. 4<sup>th</sup> ed. "Formaldehyde: Method 2016, Issue 2." (NIOSH Method 2016.) Atlanta, GA: Child Development Center (CDC), NIOSH.

U.S. Department of Energy, EnergyPlus Energy Simulation Software,  
<http://apps1.eere.energy.gov/buildings/energyplus/>

U.S. Environmental Protection Agency (USEPA). 1999. *Compendium of Methods for the Determination of Toxic Organic Compounds in Ambient Air*. 2d ed. Compendium Method TO-15. Washington DC: USEPA,  
<http://www.epa.gov/ttnamti1/files/ambient/airtox/to-15r.pdf>

## **Appendix A: SIP Hut 3.0 Plans**

Figure A-1. SIP Hut 3.0 Murus Plans, page 1.

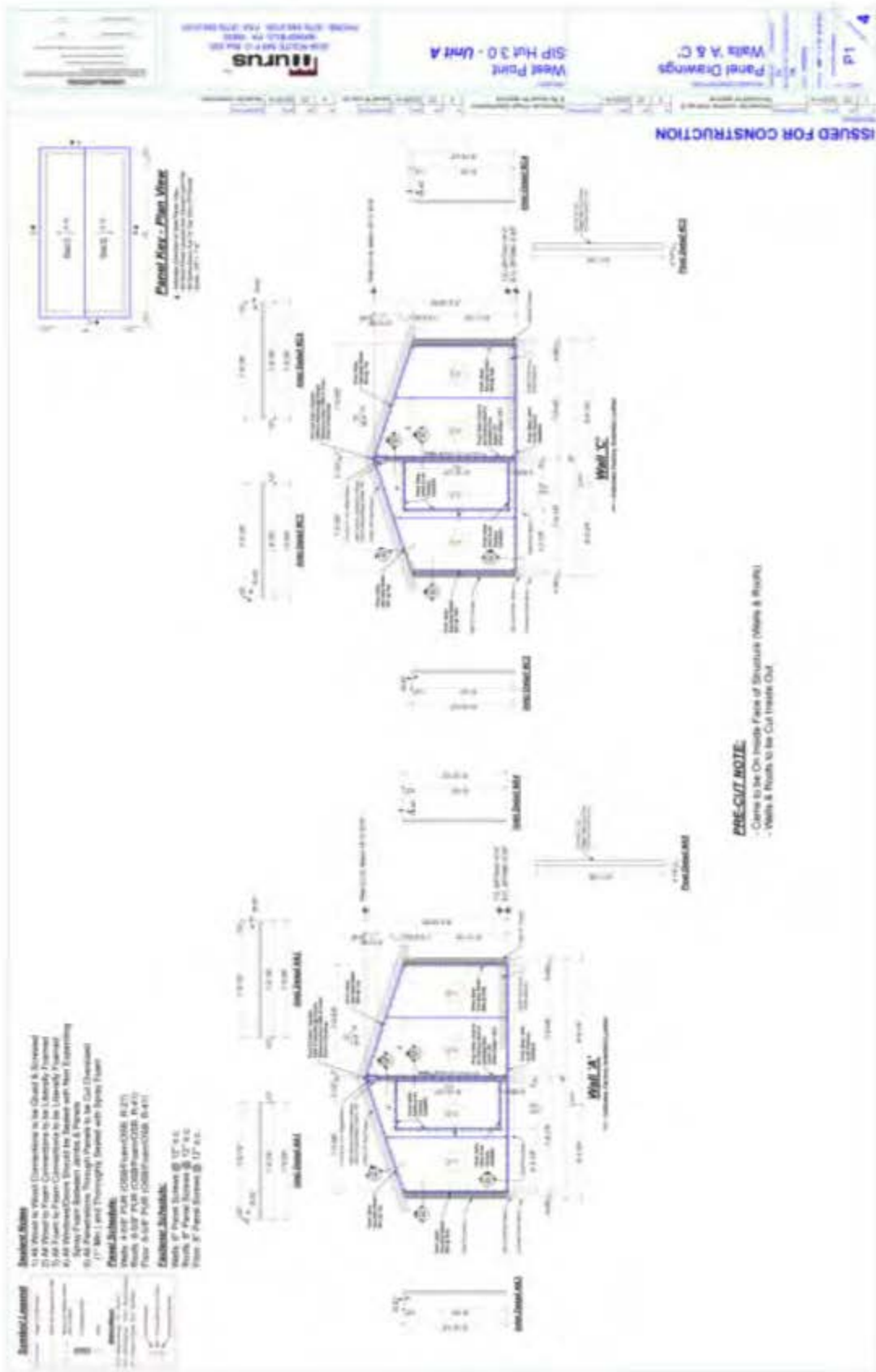

Figure A-1. SIP Hut 3.0 Murus Plans, page 2.

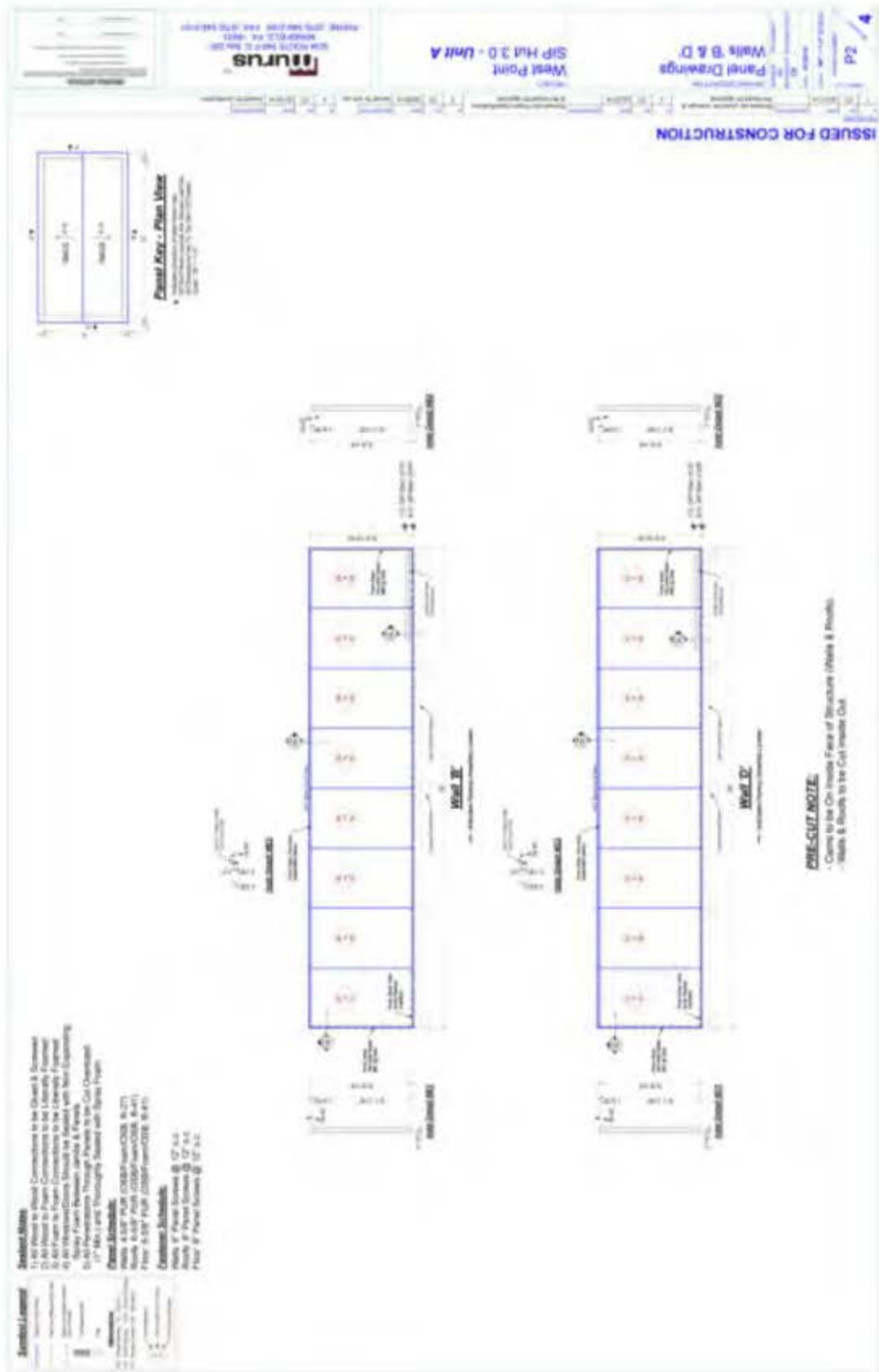

Figure A-1. SIP Hut 3.0 Murus Plans, page 3.

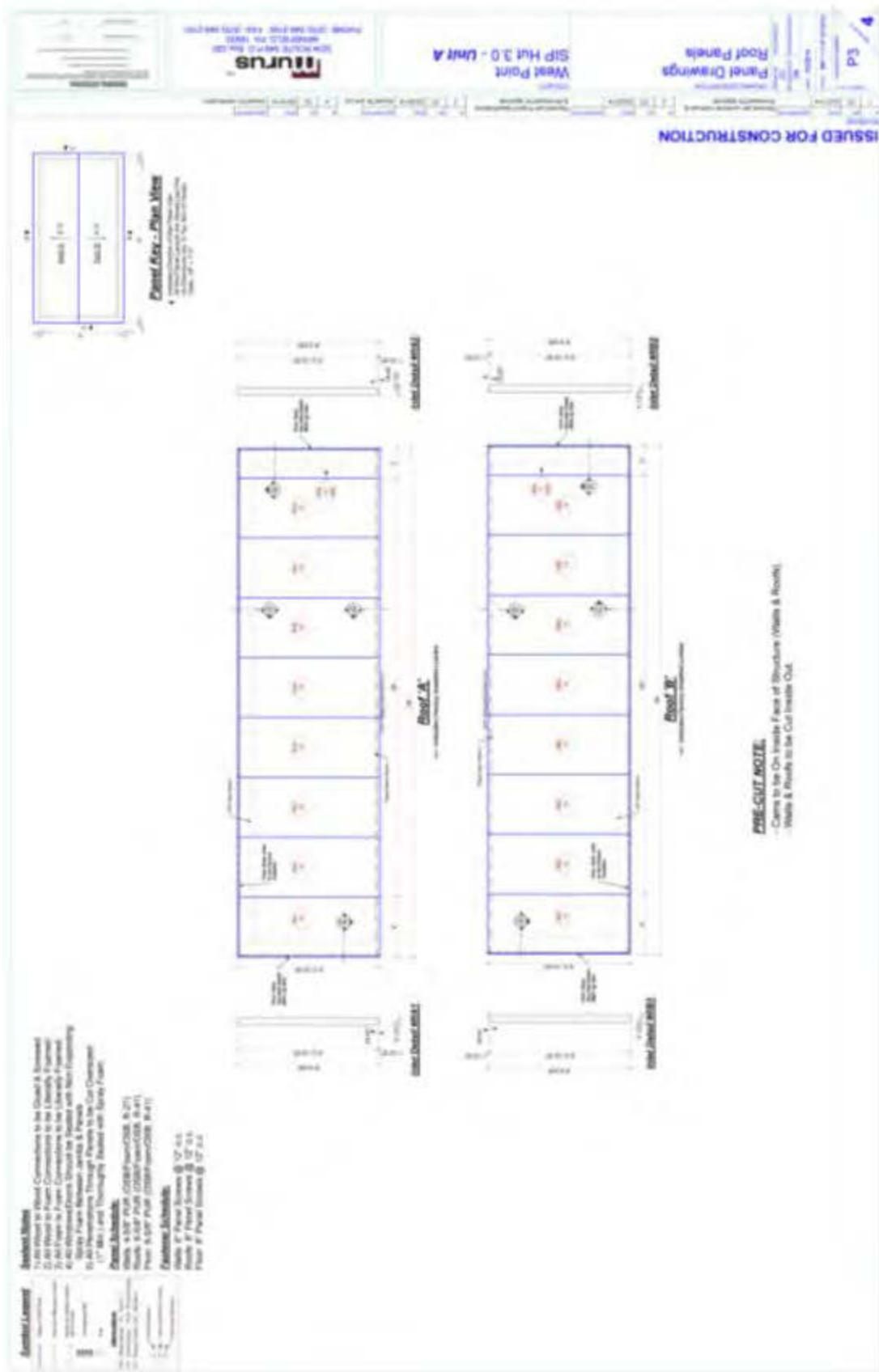
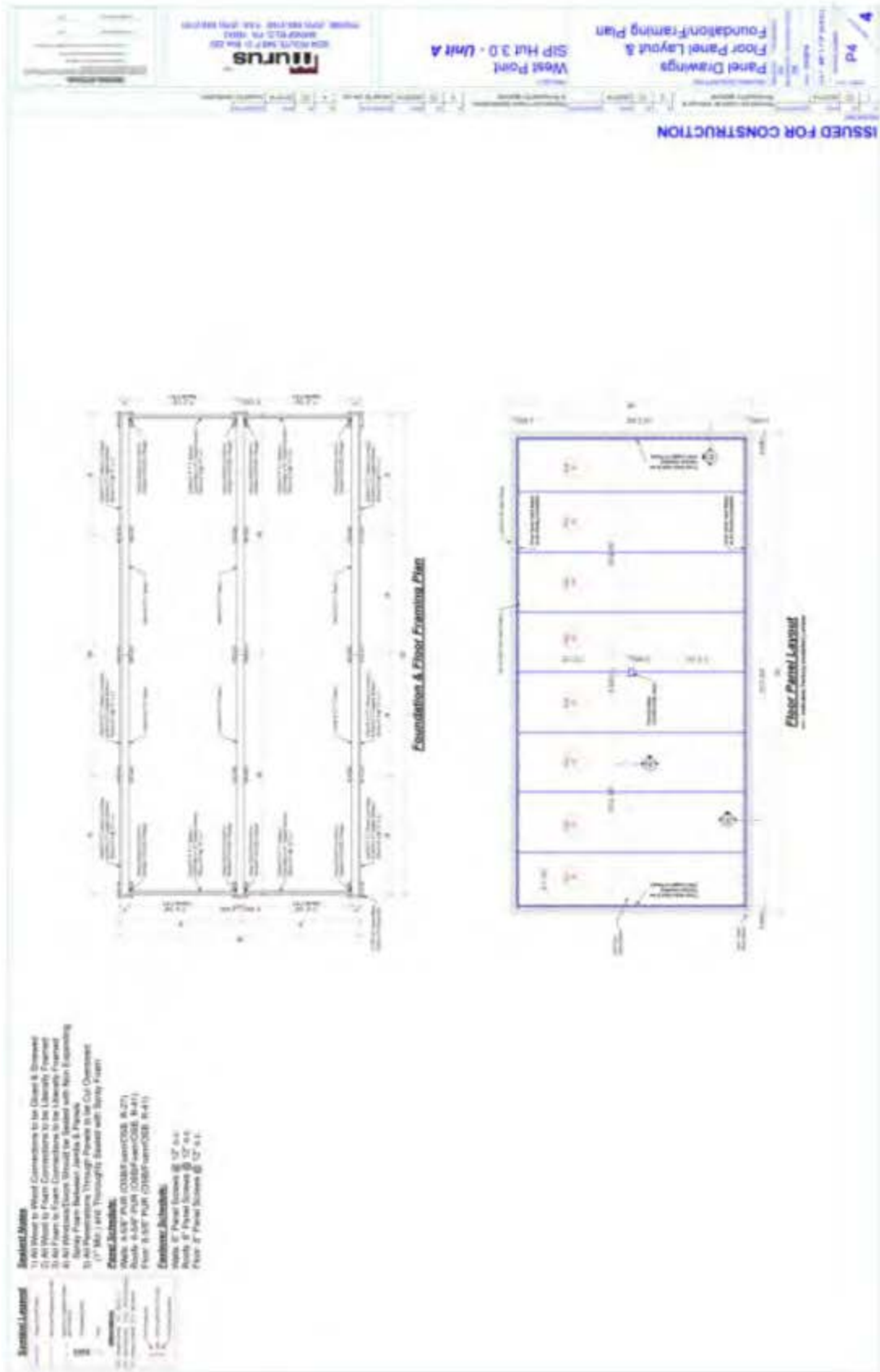

Figure A-1. SIP Hut 3.0 Murus Plans, page 4.





## Appendix B: SIP Protective Coatings

Line-X<sup>®</sup> XS-252 was used for the base coating and Line-X<sup>®</sup> XS-650 was used for the white top coat on the SIP hut's roof. Figures B-1 and B-2 show the technical data sheets for Line-X<sup>®</sup> XS-252 and Figure C-3 shows the technical data sheets for Line-X<sup>®</sup> XS-650.

Figure B-1. Technical data sheet for Line-X<sup>®</sup> XS-252, page 1.

**TECHNICAL DATA SHEET – LINE-X<sup>®</sup> XS-252**

**PRODUCT MANUFACTURER:**  
LINE-X<sup>®</sup> Franchise Development Company  
9 Hutton Centre Drive, Suite 500  
Banks AFB, GA 30707

**GENERAL PRODUCT DESCRIPTION:**  
LINE-X<sup>®</sup> XS-252 is an inhomocent two-component, high performance isocyanate polyurethane/polyurethane spray system with exceptional flame retardant properties. This product is designed to retard flame spread during an event of fire. The product contains zero VOC (Volatile Organic Compounds) and is 100% solid. LINE-X<sup>®</sup> XS-252 is positioned as a user-friendly product with a built-in activator for quick cure times.

LINE-X<sup>®</sup> XS-252 has been accepted (Assignment Marking No. "MSHA ID-241") to meet the requirements of the Mine Safety and Health Administration (MSHA) for use in the mining industry for protection against abrasion, corrosion and impact, as well as a non-solvent enhancing mine sealant. This revolutionary product, the only in its industry, has exceptional flame retardant properties that are ideal during the event of a fire and can be applied to any type of underground equipment, regardless of shape or size.

More recently, LINE-X<sup>®</sup> XS-252 has met the requirements of the MSHA Standard Application Procedures for Sealants Applied to Underground Ventilation Controls (MSHA Standard No. 33000) and is the only one in its category to be used as a sealant for mining shaft seals.

Falling shaft seals have been an ongoing concern in the mining industry, but with LINE-X<sup>®</sup> XS-252 these concerns are minimized since the product forms a monolithic membrane to minimize the different gaseous migration into the working areas, therefore protecting mining company employees.

**APPLICATION:**  
Both Iso "A" Side and Resin "B" Side should be pre-conditioned between 70-80°F before application.

LINE-X<sup>®</sup> XS-252 must be applied using a fixed pressure, fluid component, heated, 1:1 by volume, spray equipment with 2000 PSI fluid pressure capability. LINE-X<sup>®</sup> XS-252 material, both Iso "A" Side and Resin "B" Side, should be heated between 140-150°F and spray equipment should generate adequate fluid pressure for proper mixing and heat polymerization results.

**APPLICATION EQUIPMENT:**  
LINE-X<sup>®</sup> XS-252 is designed to be sprayed through high pressure impingement mixing equipment. Fluid component spray equipment must have material heat-control capability, 1:1 by volume, and can either be sprayed with a round or flat tip. Refer to equipment manufacturer for equipment specifics and accessories.

**EQUIPMENT SETTING PARAMETERS:**  
Iso "A" and Polyol "B" components must be pumped by low-pressure transfer pumps to high-pressure proportional pumping equipment.

*Filter Screens:*  
Filters must be removed on the B-side before spraying LINE-X<sup>®</sup> XS-252.

REMOVE Y-Filter across on the B-side.  
REMOVE gun's check-valve filter screen on the B-side.

*Temperature Setting:*  
Iso "A" Block Heater: 140-150°F  
Resin "B" Block Heater: 140-150°F  
Hoses (Iso and Polyol): 140-150°F  
*Pressure Setting:*  
Equipment Pressure: 2,000-3,000 PSI

**EQUIPMENT CLEAN-UP:**  
Spray equipment should be cleaned immediately after use and users should follow the equipment manufacturer's recommended procedure. Please refer to the spray equipment operating and maintenance procedures for further details. LINE-X<sup>®</sup> XS-252 should be cleaned with environmentally safe hydrocarbons-grade cleaner. Cleaning materials must be free of reactive contaminants, such as water and alcohol. All gun cleaners and spray equipment cleaning materials must be used and disposed under permitted local rules and regulations.



9 Hutton Centre Drive, Suite 500, Banks AFB, GA 30707 • (800) 826-3333 • www.line-x.com

Rev. 04/09

Figure B-1. Technical data sheet for Line-X® XS-252, page 2.

**MATERIAL STORAGE:**

Product must be re-aerated every three months.

LINE-X XS-252K has a shelf life of six months from manufacture date in factory sealed containers. LINE-X XS-252K has to be stored between 20-50°F. Do not expose unlined materials to humid conditions; always provide airtight sealed conditions to unlined materials. With materials currently connected to the pump, provide as much airtight, moisture free conditions to unlined materials as possible to ensure proper chemical performance. Drums should be stored on a pallet to avoid direct contact with water-soaked floor/ground.

**SAFETY AND HANDLING:**

Please refer to MSDS for safety and handling of this material. All personnel working with this material are expected to read and understand the safety recommendations per the MSDS. All Personal Protection Equipment must be properly worn to protect worker health and safety.

**CHEMICAL TECHNICAL DATA:**

Mix Ratio by Volume	1A:1B
Set Time	7-10 Sec
Walk Free Time	0-12 Sec
Flowrate (gph) @ 77°F	
*A* 1oz Side	160±20
*B* Back Side	200±100

*Material Density (lb/gal) @ 77°F*

*A* 1oz Side	10.85 lb/gal
*B* Back Side	10.00 lb/gal

**BASIC PHYSICAL PROPERTIES:**

Test Name	Test Methods	Value
Hardness Shore D	ASTM D2240	71
Elongation %	ASTM D413	2750
Tensile Strength, psi	ASTM D413	2850-2950
Tear Strength, lb/in	ASTM D3684	200-220
Water Absorption, mg/1000 cycle	ASTM D6970	55
Density (lb/gal)		10.0 ± 1

*Fire Rating Certifications:*

HF 490 (Part V), classification of the surface spread of flame of products; specimens tested are classified as class 1

ASTM E 108 "Surface Flammability of Materials Using a Radiant Heat Energy Source"

Flame Spread Index: 20.27

Ministry And Health Administration: Acceptance of Flame-Resistant Solid Products Taken Into Mines - MIRA 10340

Met the requirements of the voluntary Standard Application Procedure for Products Applied to Underground Ventilation Controls ASAP 5005

Non-Strength Enhancing Mine Sealant, Suitability Number-MSSA-350/00

**PRODUCT USER RESPONSIBILITIES:**

Users of LINE-X XS-252K product are responsible for reading the general guidelines, product data sheets, specifications and material safety data sheets (MSDS) before using these materials. Printed technical data and instructions are subject to change without notice. For additional information, or for current technical data instructions, contact a LINE-X representative or visit [www.LineX.com](http://www.LineX.com).

**PRODUCT DISCLAIMER:**

All guidelines, recommendations, statements, and technical data contained herein are based on information and tests we believe to be reliable and correct, but accuracy and completeness of said tests are not guaranteed and are not to be construed as a warranty, either expressed or implied. It is the user's responsibility to assess himself, by his own information and tests, to determine suitability of the product for his own intended use, application and job situation. User assumes all risk and liability resulting from his use of the product. We do not suggest or guarantee that any hazards listed herein are the only ones which may exist. Neither seller nor manufacturer shall be liable to the buyer or any third person for any injury, loss or damage directly or indirectly resulting from use of, or inability to use, the product. Recommendations or statements, whether in



Figure B-1. Technical data sheet for Line-X® XS-252, page 3.



Figure B-2. Technical data sheet for Line-X® XS-252, Fire Retardant Resin, page 1.

**MATERIAL SAFETY DATA SHEET**  
 LINE-X XS-252 FIRE RETARDANT RESIN



**1. SUBSTANCE/PREPARATION AND COMPANY IDENTIFICATION**

Company:  
 Line-X Franchise Development Corporation  
 87 Fulton Centre Dr, Suite 600  
 Santa Ana, CA 92707

24 Hour Emergency Response Information:  
 CHEMTREC: 1-800-424-9300  
 Line-X Corporate Office: 1-800-832-3232

Chemical family:  
 resin

Synonyms:  
 Urethane System Resin Component

**2. COMPOSITION/INFORMATION ON INGREDIENTS**

CAS Number	Content (W/W)	Chemical name
	< 45.0 %	Polyol
	< 2.0 %	Catalyst
111-46-6	< 7.0 %	Diethylene glycol
	< 2.0 %	Additive
	< 20.0 %	Drying agent
	< 25.0 %	Flame Retardant
88479-98-1	< 8.0 %	Diethylmethylenedianiline
25265-71-5	< 2.0 %	Dipropylene Glycol

**3. HAZARD IDENTIFICATION**

Emergency overview

CAUTION; MAY CAUSE EYE, SKIN AND RESPIRATORY TRACT IRRITATION.  
 INGESTION MAY CAUSE GASTRIC DISTURBANCES.  
 CONTAINS MATERIAL WHICH CAN CAUSE CENTRAL NERVOUS SYSTEM DAMAGE.  
 CAN CAUSE LIVER DAMAGE.  
 CAN CAUSE KIDNEY DAMAGE.  
 MAY BE HARMFUL IF SWALLOWED.  
 May be harmful if absorbed through skin.  
 SENSITIZER.

[www.LineX.com](http://www.LineX.com)

Figure B-2. Technical data sheet for Line-X® XS-252, Fire Retardant Resin, page 2.



**MATERIAL SAFETY DATA SHEET**

LINE-X XS-252 FIRE RETARDANT RESIN

**Potential health effects**

**Primary routes of exposure**  
Routes of entry for solids and liquids include eye and skin contact, ingestion and inhalation. Routes of entry for gases include inhalation and eye contact. Skin contact may be a route of entry for liquified gases.

**Acute toxicity:**  
Ingestion may cause gastrointestinal disturbances.

**Information on: Diethylene glycol**  
Acute ingestion overexposures to large doses of diethylene glycol (DEG) may produce nausea, vomiting, gastrointestinal cramping, CNS effects, diarrhea, liver necrosis, renal tubular degeneration and even death.

**Information on: Diethyl toluenediamine**  
Diethyltoluenediamine can be absorbed through the skin in toxic amounts. Sensitization can result in some individuals.

**Information on: Dipropylene glycol**  
Acute intravenous overexposures of dipropylene glycol were shown to produce CNS effects in dogs; however, this is not considered a relevant route of exposure. Prolonged overexposure to the skin may produce slight softening of the tissue.

**Irritation:**  
Irritating to respiratory system.  
**Information on: Polyol**  
Contact with the eyes and skin may result in irritation.

**Repeated dose toxicity:**  
**Information on: Diethylene glycol**  
Chronic overexposures via ingestion may produce liver and kidney damage. DEG has been known to produce reproductive toxicity in experimental animals at very high gavage doses.

**Information on: Diethyl toluenediamine**  
Sub-chronic and lifetime animal studies with diethyl toluene diamine failed to show tumorigenic effects. However, because some phenylenediamine compounds have been shown to be animal carcinogens, exposure should be minimized. In 28-day and 90-day studies, rats administered 125 ppm and 320 ppm in their food exhibited adverse pancreas effects, some of which were reversible. No effects were noted at 50 ppm.

**Information on: Dipropylene glycol**  
Rats administered 10% DPG in the drinking water for 77 days exhibited slight liver and kidney effects. Those given 5% in the water were not affected. Significant inhalation exposures to DPG are considered unlikely unless the product is heated or aerosols are generated.

[www.LineX.com](http://www.LineX.com)

Figure B-2. Technical data sheet for Line-X® XS-252, Fire Retardant Resin, page 3.



**MATERIAL SAFETY DATA SHEET**

LINE-X XS-252 FIRE RETARDANT RESIN

**Medical conditions aggravated by overexposure:**  
Data available do not indicate that these are medical conditions that are generally recognized as being aggravated by exposure to this substance/product.

**4. FIRST-AID MEASURES**

**General advice:**  
Remove contaminated clothing.

**If inhaled:**  
Remove the affected individual into fresh air and keep the person calm. Assist in breathing if necessary. Immediate medical attention required.

**If on skin:**  
Wash affected areas thoroughly with soap and water. If irritation develops, seek medical attention.

**If in eyes:**  
In case of contact with the eyes, rinse immediately for at least 15 minutes with plenty of water. Immediate medical attention required.

**If swallowed:**  
Rinse mouth and then drink plenty of water. Do not induce vomiting. Immediate medical attention required.

**5. FIRE-FIGHTING MEASURES**

Flash point:	> 100 °C	(Unspecified)
Autoignition:		No data available

**Suitable extinguishing media:**  
water, dry extinguishing media, carbon dioxide, foam

**Hazards during fire-fighting:**  
No particular hazards known.

**Protective equipment for fire-fighting:**  
Firefighters should be equipped with self-contained breathing apparatus and turn-out gear.

**6. ACCIDENTAL RELEASE MEASURES**

**Cleanup:**  
Spills should be contained, solidified, and placed in suitable containers for disposal.

**7. HANDLING AND STORAGE**

Handling  
Protection against fire and explosion.

[www.LineX.com](http://www.LineX.com)

Figure B-2. Technical data sheet for Line-X® XS-252, Fire Retardant Resin, page 4.



**MATERIAL SAFETY DATA SHEET**

LINE-X XS-252 FIRE RETARDANT RESIN

No explosion proofing necessary.

**Storage**  
**General advice:**  
 No special precautions necessary. Avoid extreme heat. Store protected against fire(s).

**Storage stability:**  
 Protect against moisture.  
 Storage temperature: 16–27 °C.

**8. EXPOSURE CONTROLS AND PERSONAL PROTECTION**

**Advice on system design:**  
 Provide local exhaust ventilation to control vapours/mists.

**Personal protective equipment**  
 Respiratory protection:  
 Wear a NIOSH-certified (or equivalent) organic vapour/particulate respirator.

**Hand protection:**  
 Chemical resistant protective gloves.

**Eyes protection:**  
 Tightly fitting safety goggles (chemical goggles). Wear face shield if splashing hazard exists.

**General safety and hygiene measures:**  
 Avoid contact with skin. Wear protective clothing as necessary to prevent contact. Avoid inhalation of vapours/mists. Handle in accordance with good industrial hygiene and safety practice. Wash soiled clothing immediately.

**9. PHYSICAL AND CHEMICAL PROPERTIES**

Form:	liquid	
Odour:	mild	
Colour:	dark bronze	
pH value:	7	
Density:	10.58 lb/USG	(25 °C)
Viscosity, dynamic:	600 mPa.s	(25 °C)
Solubility in water:	soluble	

**10. STABILITY AND REACTIVITY**

**Hazardous reactions:**  
 The product is chemically stable.

[www.LineX.com](http://www.LineX.com)

Figure B-2. Technical data sheet for Line-X® XS-252, Fire Retardant Resin, page 5.

<b>MATERIAL SAFETY DATA SHEET</b>	
<b>LINE-X XS-252 FIRE RETARDANT RESIN</b>	
	
<b>Decomposition products:</b> Hazardous decomposition products: carbon monoxide, carbon dioxide	
<b>Thermal decomposition:</b> No data available	
<b>11. TOXICOLOGICAL INFORMATION</b>	
<b>12. ECOLOGICAL INFORMATION</b>	
<b>13. DISPOSAL CONSIDERATIONS</b>	
<b>Waste disposal of substance:</b> Incinerate in a licensed facility. Do not discharge substance/product into sewer system. Dispose of in a licensed facility.	
<b>Container disposal:</b> Steel drums must be emptied and can be sent to a licensed drum reconditioner for reuse, a scrap metal dealer or an approved landfill. Refer to 40 CFR § 261.7 (residues of hazardous waste in empty containers). Decontaminate containers prior to disposal. Recommend crushing, puncturing or other means to prevent unauthorized use of used containers.	
<b>14. TRANSPORT INFORMATION</b>	
Reference Bill of Lading	
<b>15. REGULATORY INFORMATION</b>	
<b>Federal Regulations</b>	
<b>Registration status:</b> TSCA, US released / listed	
<b>OSHA hazard category:</b> Chronic target organ effects reported, ACGIH TLV established	
<b>SARA hazard categories (EPCRA 311/312):</b> Acute, Chronic	
<b>SARA 313:</b>	
<b>CAS Number</b>	<b>Chemical name</b>
1344-28-1	Aluminum oxide
<a href="http://www.LineX.com">www.LineX.com</a>	

Figure B-2. Technical data sheet for Line-X® XS-252, Fire Retardant Resin, page 6.

MATERIAL SAFETY DATA SHEET		
LINE-X XS-252 FIRE RETARDANT RESIN		
		
<u>State regulations</u>		
State RTK		
CAS Number	Chemical name	State RTK
111-46-6	Diethylene glycol	1A
<b>16. LOCAL CONTACT INFORMATION</b>		
Dustin Lee	Dlee@linexmail.com	
Bobby Bailey	Bobby@linexmail.com	
<b>17. OTHER INFORMATION</b>		
<b>HMIS III rating</b>		
Health: 1	Flammability: 1	Physical hazard: 1
HMIS uses a numbering scale ranging from 0 to 4 to indicate the degree of hazard. A value of zero means that the substance possesses essentially no hazard; a rating of four indicates high hazard.		
IMPORTANT: WHILE THE DESCRIPTIONS, DESIGNS, DATA AND INFORMATION CONTAINED HEREIN ARE PRESENTED IN GOOD FAITH AND BELIEVED TO BE ACCURATE, IT IS PROVIDED FOR YOUR GUIDANCE ONLY BECAUSE MANY FACTORS MAY AFFECT PROCESSING OR APPLICATION USE. WE RECOMMEND THAT YOU MAKE TESTS TO DETERMINE THE SUITABILITY OF A PRODUCT FOR YOUR PARTICULAR PURPOSE PRIOR TO USE. NO WARRANTIES, OF ANY KIND, EITHER EXPRESSED OR IMPLIED, INCLUDING WARRANTIES OF MERCHANTABILITY OR FITNESS FOR A PARTICULAR PURPOSE, ARE MADE REGARDING PRODUCTS DESCRIBED OR DESIGNS, DATA OR INFORMATION SET FORTH, OR THAT THE PRODUCTS, DESIGNS, DATA OR INFORMATION MAY BE USED WITHOUT INFRINGING THE INTELLECTUAL PROPERTY RIGHTS OF OTHERS. IN NO CASE SHALL THE DESCRIPTIONS, INFORMATION, DATA OR DESIGNS PROVIDED BE CONSIDERED A PART OF OUR TERMS AND CONDITIONS OF SALE. FURTHER, YOU EXPRESSLY UNDERSTAND AND AGREE THAT THE DESCRIPTIONS, DESIGNS, DATA, AND INFORMATION FURNISHED BY LINE-X HEREUNDER ARE GIVEN GRATIS AND LINE-X ASSUMES NO OBLIGATION OR LIABILITY FOR THE DESCRIPTION, DESIGNS, DATA AND INFORMATION GIVEN OR RESULTS OBTAINED, ALL SUCH BEING GIVEN AND ACCEPTED AT YOUR RISK.		
<a href="http://www.LineX.com">www.LineX.com</a>		

Figure B-3. Technical data sheet for Line-X® XS-650.

**TECHNICAL DATA SHEET LINE-X® XS-650****PRODUCT MANUFACTURER:**

LINE-X® Acquisition LLC  
166R Sparkman Dr.  
Buntville, AL 36010  
807-530-1331

**GENERAL PRODUCT DESCRIPTION:**

LINE-X XS-650 is a two-component, 100% high performance aliphatic polyurea spray elastomer system with zero VOC's (Volatile Organic Compounds), 100% solids. LINE-X XS-650 offers outstanding performance UV (ultraviolet) protection with superior elastomeric properties. LINE-X XS-650 is designed as a user-friendly product and offers exceptional adhesion properties for properly prepared substrates. The high performance formulation of LINE-X XS-650 produces an excellent skin formation for chemical resistance and moisture protection.

**APPLICATION GUIDELINES:**

Both the Iso "A" Side and Resin "B" Side should be preconditioned between 70-100°F before application. LINE-X XS-650 must be applied using high pressure, plural component, heated, 1:1 by volume, spray equipment with a minimum of 3000 PSI fluid pressure capability. LINE-X XS-650 material (both Iso "A" Side and Resin "B" Side) should be heated between 85-110°F. Spray equipment must generate adequate fluid pressure for proper mixing and best polymerization results.

**APPLICATION EQUIPMENT:**

LINE-X XS-650 is designed to be sprayed through high pressure impingement mixing equipment. Plural component spray equipment must have material heat-control capability, 1:1 by volume, and sprayable with round or flat tip. Refer to equipment manufacturer for equipment specifics and accessories.

**EQUIPMENT SETTING PARAMETERS:**

Iso "A" and Polyol "B" components must be pumped by low pressure transfer pumps to high-pressure proportional pumping equipment.

Iso "A" Block Heater:	100-110°F
Resin "B" Block Heater:	85-95°F
hoses (Iso and Polyol):	85-90°F
Equipment Pressure:	3000-4500 PSI

**EQUIPMENT CLEAN-UP:**

Spray equipment should be cleaned immediately after use following equipment manufacturer's recommended procedures. Please refer to spray equipment operating and maintenance procedures for further details. LINE-X XS-650 should be cleaned with environmentally safe urethane-grade cleaners. Cleaning materials must be free of reactive contaminants such as water and alcohol. All gun cleaners and spray equipment cleaning materials must be used and disposed of as permitted under local rules and regulations.

**MATERIAL STORAGE:**

LINE-X XS-650 has a shelf life of twelve (12) months from manufacture date in factory sealed containers. The material should be stored between 60-100°F. Do not expose unused materials to high humidity conditions. Always provide airtight reseal conditions to unused materials. For materials that are currently connecting to the pumps, always provide as much airtight and moisture free conditions to unused materials as possible to ensure proper chemical performance. Drums should be stored on pallets to avoid direct contact with the warehouse floor/ground.

**SAFETY & HANDLING:**

Please refer to MSDS for safety and handling of this material. All personnel working with this material are expected to read and understand all safety recommendations per MSDS. All Personal Protection Equipment must be properly worn to comply with worker health and safety requirements.

**CHEMICAL TECHNICAL DATA:**

Mix Ratio by Volume:	1A:1B
Gel Time:	12-14 Seconds
Touch Free Time:	30-40 Seconds
Viscosity @ 77°F:	
"A" Iso Side:	550 cPs
"B" Resin Side:	65 cPs
Weight Per Gallon:	
"A" Iso Side:	9.80 W/G
"B" Resin Side:	7.50 W/G

**BASIC PHYSICAL PROPERTIES:**

Test Name	Test Methods	Value
Hardness Shore D	ASTM D2240	90-2
Elongation	ASTM D412	80%



Figure B-3. Technical data sheet for Line-X® XS-650.

TECHNICAL DATA SHEET			LINE-X® XS-650
Taber Abrasion	ASTM D-4090	20 mg loss/1000 cycles	a corporate officer of the manufacturer. Technical and application information is provided for the purpose of establishing a general profile of the material and proper application procedures. Test performance results were obtained in a controlled environment and LINE-X FID makes no claim that these tests or any other tests accurately represent all environments.
Tear Strength	ASTM D-384	945 PLI	
Tensile Strength	ASTM D-412	2200 psi	
<b>LIMITATIONS:</b>			
The chemical resistance chart should be consulted prior to application. Application-specific processing parameters such as temperature and operating pressure of coated objects must be considered before installing LINE-X XS-650 coating systems.			
<b>PRODUCT USER RESPONSIBILITIES:</b>			
Users of Line-X XS-650 product are responsible for reading the general guidelines, product data sheets, specifications and material safety data sheets (MSDS) before using this material. Printed technical data and instructions are subject to change without notice. Contact your local LINE-X representative or visit our website <a href="http://www.LINE-X.com">www.LINE-X.com</a> for current technical data instructions.			
<b>PRODUCT DISCLAIMER:</b>			
All guidelines, recommendations, statements, and technical data contained herein are based on information and tests we believe to be reliable and correct, but accuracy and completeness of said tests are not guaranteed and are not to be construed as a warranty, either expressed or implied. It is the user's responsibility to satisfy himself, by his own information and test, to determine suitability of the product for his own intended use, application and job situation. User assumes all risk and liability resulting from his use of the product. We do not suggest or guarantee that any hazards listed herein are the only ones which may exist. Neither seller nor manufacturer shall be liable to the buyer or any third person for any injury, loss or damage directly or indirectly resulting from use of, or inability to use, the product. Recommendations or statements, whether in writing or oral, other than those contained herein shall not be binding upon the manufacturer, unless in writing and signed by			
			
<small>©2015 Spaulding Coatings, Birmingham, AL 35242      337-330-1001      www.LINE-X.com</small>			
<small>No. 011</small>			

# Appendix C: Weather Observations for SIP Hut IAQ Testing Days

Figure C-1. Weather observations for 20 May 2014.

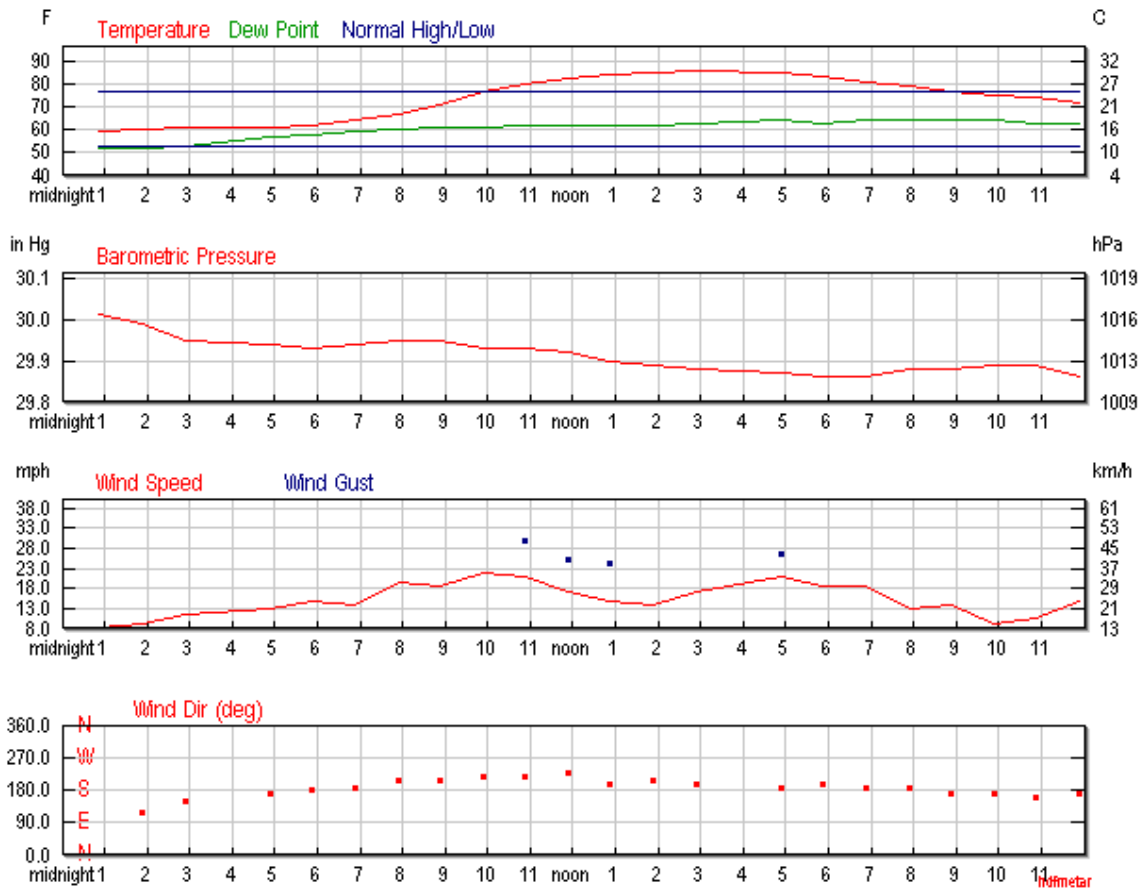

Figure C-2. Weather observations for 21 May 2014.

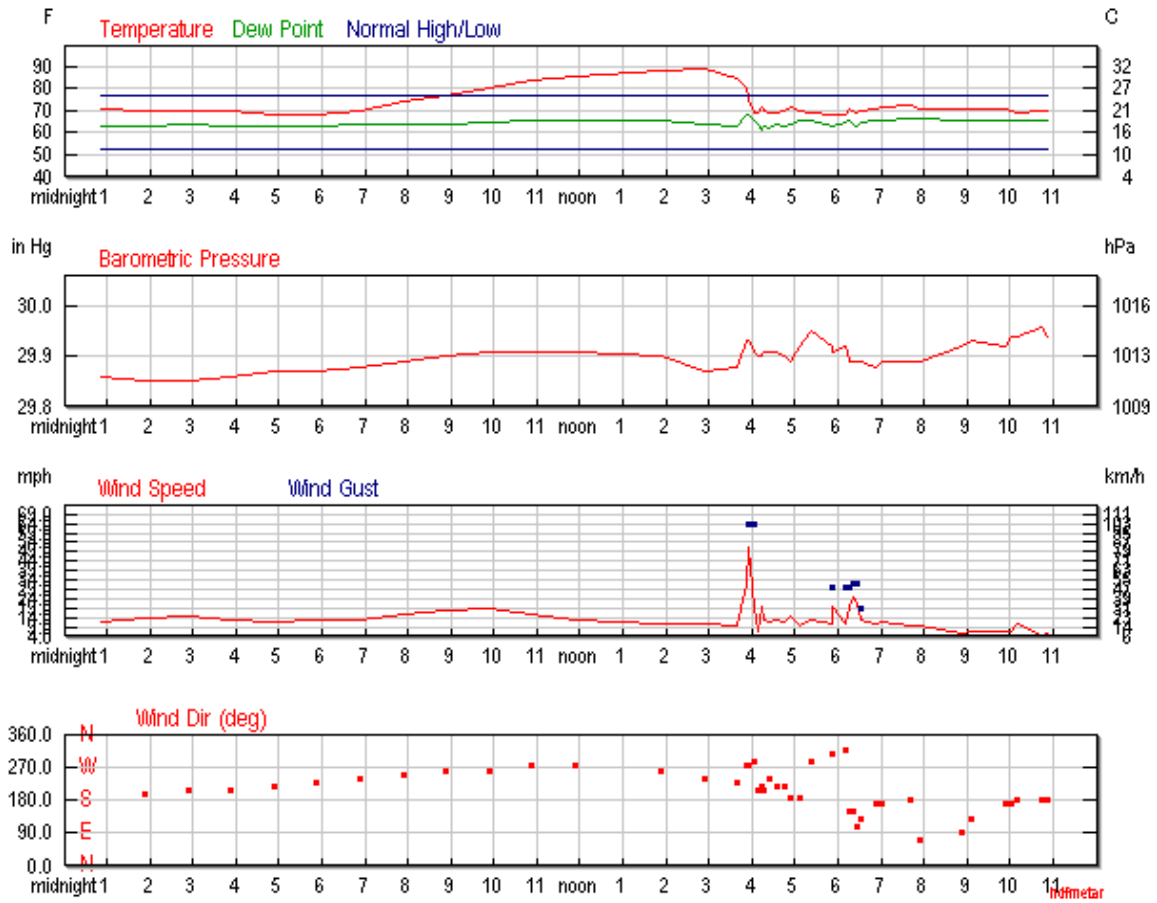
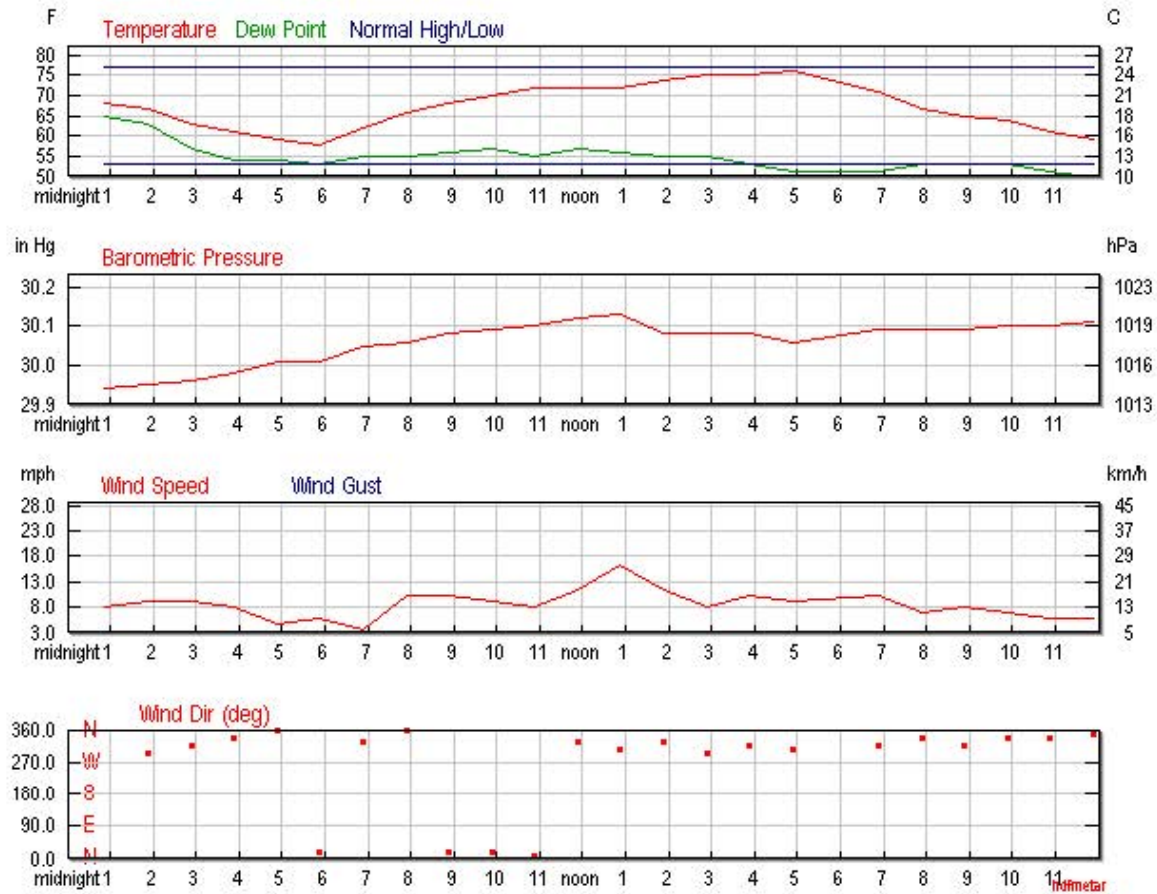

Figure C-3. Weather observations for 22 May 2014.



## **Appendix D: EPA T0-15 Detailed Results for SIP Hut IAQ Testing**





**EMSL Analytical**  
 200 Route 130 North, Commission, NJ 08933  
 Phone/Fax: (953)554-6000 / (953)558-4571  
<http://www.EMSL.com> TOLL-FREE Lab Services

EMSL Order # **491400456**  
 EMSL Sample # **491400456-1**  
 Customer ID **USAC50**  
 Customer PO **Not Available**

Alt: **Michael Kemme**  
**USACE/ER**  
**P. O. Box 9005**  
**Champaign, IL 61826**

Phone: **217-373-6758**  
 Fax: **217-373-7222**  
 Collected: **05/20/2014**  
 Received: **05/23/2014**

Project: \_\_\_\_\_ Sample ID: **1**

**Analysis**      **Analysis Date**      **Analyst Init.**      **Lab File ID**      **Canister ID**      **Sample Vol.**      **Dil. Factor**  
**initial**              **06/06/2014**              **KW**              **H0267.D**              **HD2750**              **25 cc**              **10**

**Target Compound Results Summary**

Target Compound	CAS#	MW	Result ppbv	RL ppbv	O	Result ug/m3	RL ug/m3	Comments
Freon-11	67-61-1	120.9	ND	10		ND	17	
Freon-12	75-05-3	120.9	ND	5.0		ND	25	
Freon-114	1,1,2-Dichloro-1,1,2,2-tetrafluoroethane	107.18-1	ND	5.0		ND	35	
Chloroethane	107-05-1	64.48	ND	5.0		ND	10	
n-Butane	71-43-2	58.12	ND	5.0		ND	12	
Vinyl chloride	100-44-7	62.50	ND	5.0		ND	13	
1,3-Butadiene	75-37-4	54.09	ND	5.0		ND	11	
Bromochloroethane	593-60-2	94.94	ND	5.0		ND	19	
Chloroethane	75-35-2	64.52	ND	5.0		ND	15	
Ethanol	74-83-9	46.07	ND	5.0		ND	9.4	
Bromoethane	106-98-0	106.9	ND	5.0		ND	22	
Freon-113	1,1,1-Trichloro-1,2,2,2-tetrafluoroethane	106-97-8	137.4	ND	5.0	ND	28	
Isopropyl alcohol	2-Propanol	108-10-7	60.10	ND	5.0	ND	12	
Freon-113B1	1,1,2-Trichloro-1,1,2,2-tetrafluoroethane	75-00-2	167.4	ND	5.0	ND	38	
Acetone	67-66-3	58.08	6.1	5.0		14	12	
1,1-Dichloroethane	74-87-3	96.94	ND	5.0		ND	20	
Acetonitrile	75-15-0	41.03	ND	5.0		ND	3.4	
Tertiary butyl alcohol	(TBA)	56-23-5	74.12	ND	5.0	ND	15	
Bromoethane	(Ethyl bromide)	95-46-8	108.0	ND	5.0	ND	22	
5-Chloropropenal	(Allyl chloride)	110-63-7	78.53	ND	5.0	ND	16	
Carbon disulfide	124-48-1	76.14	ND	5.0		ND	16	
Methylene chloride	106-93-8	84.94	ND	3.0		ND	17	
Acrylonitrile	95-50-1	53.06	ND	5.0		ND	11	
Methyl-tert-butyl ether	(MTE)	541-73-1	88.15	ND	5.0	ND	18	
trans-1,2-Dichloroethane	106-46-7	96.94	ND	5.0		ND	20	
n-Hexane	75-71-8	86.17	ND	5.0		ND	18	
1,1-Dichloroethane	75-34-3	98.96	ND	5.0		ND	20	
Vinyl acetate	107-06-2	86.09	ND	5.0		ND	15	
2-Butanone	(MEK)	75-35-4	72.10	ND	5.0	ND	16	
cis-1,2-Dichloroethane	156-59-2	98.94	ND	5.0		ND	20	
Ethyl acetate	156-80-5	88.10	ND	5.0		ND	18	
Chloroform	78-87-5	119.4	ND	5.0		ND	24	
Tetrahydrofuran	10061-01-5	72.11	ND	5.0		ND	15	
1,1,1-Trichloroethane	10061-02-6	133.4	ND	3.0		ND	27	
Cyclohexane	76-14-2	98.16	ND	5.0		ND	17	
2,2,4-Trimethylpentane	(isooctane)	114-26-1	114.2	ND	5.0	ND	22	
Carbon tetrachloride	541-78-6	153.8	ND	5.0		ND	31	
n-Heptane	64-17-5	100.2	ND	5.0		ND	20	
1,2-Dichloroethane	100-41-6	98.96	ND	5.0		ND	20	
Eaizone	622-96-8	78.11	ND	5.0		ND	16	
Trichloroethane	142-82-5	131.4	ND	5.0		ND	27	
1,2-Dichloropropane	87-08-2	113.0	ND	5.0		ND	23	
Methyl Methacrylate	110-54-3	100.12	ND	5.0		ND	20	
Bromodichloromethane	67-83-0	163.8	ND	3.0		ND	33	
1,4-Dioxane	96-83-8	98.12	ND	5.0		ND	18	
1,1-Methyl-2-pentanone	(MEK)	75-06-2	100.2	ND	5.0	ND	20	



**EMSL Analytical**

200 Route 130 North, Commission, NJ 08933  
 Phone/Fax: (908)558-4800 / (908)558-4571  
 http://www.EMSL.com TO-15 Lab

EMSL Order # 491400456  
 EMSL Sample # 491400456-1  
 Customer ID USAC50  
 Customer PO Not Available

Attn: Michael Kemme  
 USACE/CR  
 P. O. Box 9005  
 Champaign, IL 61826

Phone: 217-373-6758  
 Fax: 217-373-7222  
 Collected: 05/20/2014  
 Received: 05/23/2014

Project:

Sample ID: 1

Analysis	Analysis Date	Analyst Init.	Lab File ID	Canister ID	Sample Vol.	Dil. Factor
initial	06/06/2014	KW	H0267.D	HD2750	25 cc	10

**Target Compound Results Summary**

Target Compound	CAS#	MW	Result ppbv	RL ppbv	O	Result ug/m3	RL ug/m3	Comments
cis-1,4-Dichlorobenzene	501-78-6	111.0	ND	5.0		ND	23	
Toluene	78-93-3	92.14	ND	5.0		ND	49	
trans-1,3-Dichlorobenzene	108-90-1	111.0	ND	5.0		ND	23	
1,1,2-Trichloroethane	88-62-6	133.4	ND	5.0		ND	27	
2-Hexanone(MBK)	1634-04-8	100.1	ND	5.0		ND	20	
Tetrachloroethene	91-20-3	165.9	ND	5.0		ND	34	
Dibromochloromethane	115-07-1	206.9	ND	10		ND	35	
1,2-Dibromobenzene	100-42-5	187.8	ND	5.0		ND	38	
Chlorobenzene	75-65-0	112.6	ND	5.0		ND	23	
Ethylbenzene	78-34-9	106.2	ND	5.0		ND	22	
Xylene (o,m)	127-18-4	106.2	ND	10		ND	43	
Xylene (Ortho)	109-99-0	106.2	ND	5.0		ND	22	
Styrene	102-68-3	104.1	ND	5.0		ND	21	
propylbenzene (cumene)	120-92-1	120.19	ND	5.0		ND	25	
Ethylbenzene	71-65-8	106.2	ND	5.0		ND	22	
1,1,2,2-Tetrachloroethane	79-09-5	167.9	ND	5.0		ND	34	
4-Ethyltoluene	79-01-8	120.2	ND	5.0		ND	25	
1,3,5-Trimesitylbenzene	75-68-4	120.2	ND	5.0		ND	25	
3-Chlorotoluene	76-13-7	126.0	ND	5.0		ND	26	
1,2,4-Trimethylbenzene	95-83-6	120.2	ND	5.0		ND	25	
1,3-Dichlorobenzene	108-87-8	147.0	ND	5.0		ND	30	
1,4-Dichlorobenzene	540-84-1	147.0	ND	5.0		ND	30	
Benzyl chloride	108-05-4	126.0	ND	5.0		ND	26	
1,2-Dichlorobenzene	74-96-4	147.0	ND	5.0		ND	30	
1,2,4-Trichlorobenzene	75-01-4	181.5	ND	5.0		ND	37	
Hexafluoro-1,3-butadiene	1330-20-7	260.8	ND	5.0		ND	33	
Naphthalene	95-47-6	128.17	ND	5.0		ND	26	
<b>Total Target Compound Concentrations:</b>			<b>6.1</b>	<b>ppbv</b>		<b>14</b>	<b>ug/m3</b>	

**Surrogate**

4-Bromofluorobenzene

Result	Subst	Recovery
99	10	990%

**Qualifier Definitions**

ND = Non Detect

B = Compound also found in method blank

E = Estimated concentration exceeding upper calibration range

D = Result repaired from diluted analysis

**Method Reference**

USEPA: Compendium Method TO-15 "Determination of Volatile Organic Compounds (VOCs) in Air: 152 (selected Specialty-Prepared Cleaners and Analyzed by Gas Chromatography/Mass Spectrometry (GC/MS))" Analy. 1988, EPA/625/R-98/010g



ILDEP Certification #: 03036



**EMSL Analytical**

200 Route 150 North, Champaign, IL 61820  
 Phone/Fax: (855)958-4000 / (855)958-4571  
 E-mail: [EMSL@emsl.com](mailto:EMSL@emsl.com) [www.emsl.com](http://www.emsl.com)

EMSL Order #: 491400456  
 EMCL Sample #: 491400456-2  
 Customer ID: USAC50  
 Customer PO: Not Available

Attn: Michael Kemme  
 USACE/CR  
 P. O. Box 9005  
 Champaign, IL 61826

Phone: 217-373-6758  
 Fax: 217-373-7322  
 Collected: 05/20/2014  
 Received: 05/23/2014

Project: Sample ID: 2

Analysis	Analysis Date	Analyst Init.	Lab File ID	Canister ID	Sample Vol.	Dil. Factor
Initial	06/06/2014	KW	R0268.D	HD2337	25 cc	10
Dilution1	06/09/2014	KW	K0316.D	HD2337	20 cc	12.5

**Target Compound Results Summary**

Target Compounds	CAS#	MW	Result ppbv	RL ppbv	O	Result ug/m3	RL ug/m3	Comments
Freonine	67-64-7	42.08	ND	10		ND	17	
Freon 12 (Dichlorodifluoromethane)	75-05-8	120.9	ND	5.0		ND	25	
Freon 114 (1,2-Dichlorotetrafluoroethane)	107-13-1	170.9	ND	5.0		ND	35	
Chloroform	107-05-1	98.49	ND	5.0		ND	10	
n-Butane	71-43-2	58.12	ND	5.0		ND	12	
Vinyl chloride	100-44-7	62.50	ND	5.0		ND	13	
1,2-Dibromoethane	75-27-4	54.09	ND	5.0		ND	11	
Bromomethane	593-60-2	94.94	ND	5.0		ND	19	
Chloroethane	75-25-2	64.52	ND	5.0		ND	13	
Ethanol	74-83-9	46.07	34	5.0		64	14	
Bromobenzene (Vinyl bromide)	106-90-0	166.0	ND	5.0		ND	22	
Freon 113 (Trichlorobromomethane)	106-97-3	137.4	ND	5.0		ND	28	
Isopropyl alcohol (2-Propanol)	105-80-7	60.10	54	5.0		130	12	
Freon 113 (1,1,2-Trichloro-1,1,2-fluoroethane)	75-00-3	167.4	ND	5.0		ND	36	
Acetone	67-66-3	58.08	300	6.3	D	710	15	Reported Dilution #1
1,1-Dichloroethene	74-67-3	96.94	ND	5.0		ND	20	
Acetonitrile	75-15-0	41.05	280	5.0		440	8.8	
Tertiary butyl alcohol (TBA)	55-23-5	74.12	ND	5.0		ND	15	
Bromomethane (Ethyl bromide)	65-49-3	168.0	ND	5.0		ND	22	
3-Chloropropene (Allyl chloride)	110-63-7	76.53	ND	5.0		ND	16	
Carbon disulfide	124-45-1	76.14	ND	5.0		ND	16	
Methylene chloride	106-93-4	84.94	ND	5.0		ND	17	
Acrylonitrile	65-50-7	53.06	ND	5.0		ND	11	
Methyl tert-butyl ether (MTBE)	541-73-1	88.15	ND	5.0		ND	18	
trans-1,2-Dichloroethane	106-46-7	96.94	ND	5.0		ND	20	
n-Hexane	75-71-5	86.17	ND	5.0		ND	19	
1,1-Dichloroethane	75-34-3	96.96	ND	5.0		ND	20	
Vinyl acetate	107-08-2	86.09	ND	5.0		ND	18	
2-Butanone (MEK)	75-35-4	72.10	ND	5.0		ND	15	
cis-1,2-Dichloroethane	156-59-2	96.94	ND	5.0		ND	20	
Ethyl acetate	155-80-5	86.10	ND	5.0		ND	18	
Chloroform	78-37-5	119.4	ND	5.0		ND	24	
Tetrahydrofuran	10061-01-5	72.11	ND	5.0		ND	15	
1,1,1-Trichloroethane	10061-02-8	133.4	ND	5.0		ND	27	
Cyclohexane	76-14-2	84.16	ND	5.0		ND	17	
2,2,4-Trimethylpentane (Isocetane)	133-91-1	114.2	ND	5.0		ND	23	
Carbon tetrachloride	141-78-6	153.8	ND	5.0		ND	31	
n-Heptane	64-17-5	100.2	ND	5.0		ND	20	
1,2-Dichloromethane	100-11-4	98.96	ND	5.0		ND	20	
Benzene	622-86-8	78.11	ND	5.0		ND	16	
Trichloroethene	142-62-5	131.4	ND	5.0		ND	27	
1,2-Dichloropropane	67-89-5	113.0	ND	5.0		ND	23	
Methyl Methacrylate	110-54-3	100.12	ND	5.0		ND	20	
Bromodichloromethane	67-63-0	163.8	ND	5.0		ND	33	
1,4-Dioxane	98-82-8	98.12	ND	5.0		ND	18	
4-Methyl-2-pentanone (MBO)	75-09-2	100.2	ND	5.0		ND	20	



**EMSL Analytical**

200 Route 190 North, Cranston, NJ 08903  
 Phone/Fax: (856)558-4000 / (856)558-4571  
 1125 Lakeside Plaza, Suite 100, Chicago, IL 60606

EMSL Order #: 491400456  
 EMSL Sample #: 491400456-2  
 Customer ID: USAC50  
 Customer PO: Not Available

Attn: Michael Kemme  
 USACE/CEP  
 P. O. Box 9005  
 Champaign, IL 61826

Phone: 217-373-6758  
 Fax: 217-373-7322  
 Collected: 05/20/2014  
 Received: 05/23/2014

Project: \_\_\_\_\_ Sample ID: 2

Analysis	Analysis Date	Analyst Init.	Lab File ID	Canister ID	Sample Vol.	Dil. Factor
Initial	06/06/2014	KW	R0268.D	HD2337	25 cc	10
Dilution1	06/09/2014	KW	K0318.D	HD2337	20 cc	12.5

**Target Compound Results Summary**

Target Compounds	CAS#	MW	Result ppbv	RL ppbv	Q	Result ug/m3	RL ug/m3	Comments
cis-1,3-Dichloropropene	591-78-6	111.0	ND	5.0		ND	23	
Toluene	78-93-3	92.14	19	5.0		71	19	
trans-1,3-Dichloropropene	105-10-1	111.0	ND	5.0		ND	23	
1,1,2-Trichloroethane	80-62-6	133.4	ND	3.0		ND	27	
3-Hexenoal(MB)	1634-04-4	100.1	ND	5.0		ND	20	
Tetrafluoroethane	99-36-3	168.0	ND	5.0		ND	34	
Dibromochloromethane	115-07-1	208.3	ND	10		ND	95	
1,3-Dibromoethane	100-42-5	167.0	ND	5.0		ND	38	
Chlorobenzene	75-65-0	112.6	ND	5.0		ND	23	
Ethylbenzene	78-34-9	106.2	ND	5.0		ND	22	
Xylene (p,m)	127-16-4	106.2	16	10		88	43	
Xylene (Ortho)	104-94-9	106.2	6.0	5.0		35	22	
Styrene	105-68-3	104.1	ND	5.0		ND	21	
Isopropylbenzene (Cumene)	120-42-1	120.19	ND	5.0		ND	25	
Bromobenzene	71-55-6	252.0	ND	5.0		ND	52	
1,1,2,2-Tetrachloroethane	79-00-5	167.0	ND	5.0		ND	34	
4-Ethyltoluene	78-01-8	120.2	ND	5.0		ND	25	
1,3,5-Trimethylbenzene	75-09-4	120.2	ND	5.0		ND	25	
2-Chlorotoluene	76-12-1	126.6	ND	5.0		ND	26	
1,2,4-Trimethylbenzene	95-63-6	120.2	ND	5.0		ND	25	
1,3-Dichlorobenzene	105-67-8	147.0	ND	5.0		ND	30	
1,4-Dichlorobenzene	540-84-1	147.0	ND	5.0		ND	30	
Benzyl chloride	105-05-4	126.0	ND	5.0		ND	26	
1,2-Dichloroethane	74-97-4	147.0	ND	5.0		ND	30	
1,3,4-Trichlorobenzene	75-03-4	181.5	ND	5.0		ND	37	
Hexachloro-1,3-butadiene	1330-20-7	280.9	ND	5.0		ND	59	
Naphthalene	95-47-8	128.17	ND	5.0		ND	26	
<b>Total Target Compound Concentrations:</b>			<b>690</b>	<b>ppbv</b>		<b>1500</b>	<b>ug/m3</b>	

**Surrogate**

4-Ethylchlorobenzene

Result	Rel%	Recovery
110	10	110%

**Qualifier Definitions**

ND = Non Detect

B = compound not found in method blank

E = Estimated concentration exceeding upper calibration range

Q = Result reported from duplicate analysis

**Method Reference**

USEPA. Compendium Method TO-15. "Determination of Volatile Organic Compounds (VOCs) in Air." 7. Combustion Inversion Preceded Cofactors and Analyzed by Gas Chromatography/Mass Spectrometry (GC/MS), January 1 1997 (EPA/625/R-96/010a)



EPA Certification # 00006



**EMSL Analytical**

200 Route 190 North, Champaign, IL 61820  
 Phone/Fax: (855)858-4800 / (855)858-4571  
 Email: [EMSL@emsl.com](mailto:EMSL@emsl.com) [info@emsl.com](mailto:info@emsl.com)

EMSL Order #: 491400456  
 EMSL Sample #: 491400456-3  
 Customer ID: USAC50  
 Customer PO: Not Available

Attn: Michael Kemme  
 USACE/ER  
 P. O. Box 9005  
 Champaign, IL 61826

Phone: 217-373-6758  
 Fax: 217-373-7222  
 Collected: 05/20/2014  
 Received: 05/23/2014

Project

Sample ID: 3

Analysis	Analysis Date	Analyst Init.	Lab File ID	Canister ID	Sample Vol.	Dil. Factor
Initial	06/06/2014	KW	K0269.D	HD2106	25 cc	10
Dilution1	06/06/2014	KW	K0319.D	HD2106	25 cc	30

**Target Compound Results Summary**

Target Compounds	CAS#	MW	Result ppbv	RL ppbv	O	Result ug/m3	RL ug/m3	Comments
Propylene	67-63-1	42.08	ND	10		ND	17	
Freon 12(Dichlorodifluoromethane)	75-05-8	120.9	ND	5.0		ND	25	
Freon 114(1,2-Dichloro-1,1,2,2-tetrafluoroethane)	107-13-1	170.9	ND	5.0		ND	95	
Chloromethane	107-05-1	50.49	ND	5.0		ND	10	
n-Butane	71-43-2	58.12	ND	5.0		ND	12	
Vinyl chloride	100-44-7	62.50	ND	5.0		ND	13	
1,2-Dichloroethane	75-27-4	54.09	ND	5.0		ND	11	
Bromomethane	693-60-2	94.94	ND	5.0		ND	19	
Chloroethane	75-25-2	64.52	ND	5.0		ND	13	
Ethanol	74-83-9	46.07	43	5.0		80	84	
Bromochloroethane(Vinyl Chloride)	106-39-0	166.0	ND	5.0		ND	22	
Freon 113(Trichlorofluoromethane)	106-97-9	137.4	ND	5.0		ND	28	
Isopropyl alcohol(2-Propanol)	105-80-7	60.10	120	5.0		300	12	
Freon 113(1,1,2-Trichloro-1,2,2,2-tetrafluoroethane)	75-00-3	167.4	ND	5.0		ND	38	
Acetone	67-66-3	58.08	740	15	D	1800	36	Reported Dilution 30
1,1-Dichloroethene	74-87-3	96.94	ND	5.0		ND	20	
Acetonitrile	75-15-0	43.00	290	5.0		470	8.8	
Tertiary butyl alcohol(TBA)	56-23-5	74.12	ND	5.0		ND	15	
Bromochloroethane(Ethyl bromide)	95-49-8	168.0	ND	5.0		ND	22	
S-Chloropropene(AW #Hond)	110-63-7	76.53	ND	5.0		ND	16	
Carbon disulfide	72-45-1	76.14	ND	5.0		ND	16	
Methylene chloride	106-95-4	84.94	ND	5.0		ND	17	
Acrylonitrile	65-50-7	53.06	ND	5.0		ND	11	
Methyl-tert-butyl ether(MTBE)	541-75-1	88.15	ND	5.0		ND	28	
trans-1,2-Dichloroethene	106-46-7	96.94	ND	5.0		ND	20	
n-Hexane	75-71-9	86.17	ND	5.0		ND	19	
1,1-Dichloroethene	75-34-3	96.96	ND	5.0		ND	20	
Vinyl acetate	107-06-2	86.00	ND	5.0		ND	18	
2-Butanone(ME)	75-35-4	72.10	6.4	5.0		25	15	
cis-1,2-Dichloroethene	156-59-2	96.94	ND	5.0		ND	20	
Ethyl acetate	156-60-5	86.10	ND	5.0		ND	16	
Chlorobenzene	78-87-5	112.4	ND	5.0		ND	24	
Tetrahydrofuran	10061-01-5	72.11	ND	5.0		ND	15	
1,1,1-Trichloroethane	10061-02-8	133.4	ND	5.0		ND	27	
Cyclohexane	76-14-2	84.16	ND	5.0		ND	17	
2,2,4-Trimethylpentane(isooctane)	123-01-1	114.2	ND	5.0		ND	23	
Carbon tetrachloride	141-78-6	153.8	ND	5.0		ND	31	
n-Heptane	64-17-5	100.2	7.2	5.0		30	20	
1,2-Dichloroethane	100-41-4	98.96	ND	5.0		ND	20	
Benzene	622-86-6	78.11	ND	5.0		ND	16	
Trichloroethene	142-62-5	131.4	ND	5.0		ND	27	
1,2-Dichloropropane	67-69-3	113.0	ND	5.0		ND	23	
Methyl Methacrylate	110-54-3	100.12	ND	5.0		ND	20	
Bromodichloromethane	67-63-0	163.8	ND	5.0		ND	33	
1,4-Dioxane	96-83-8	98.12	6.0	5.0		22	16	
4-Methyl-2-pentanone(MBK)	75-09-2	100.2	ND	5.0		ND	20	



**EMSL Analytical**  
 200 Route 190 North, Carmichael, NJ 08053  
 Phone/Fax: (953)954-6000 / (953)958-4571  
 E-Mail: [EMSL@emsl.com](mailto:EMSL@emsl.com) [www.emsl.com](http://www.emsl.com)

EMSL Order #: 491400456  
 EMSL Sample #: 491400456-3  
 Customer ID: USAC50  
 Customer PO: Not Available

Attn: Michael Kemme  
 USACE/CR  
 P. O. Box 9005  
 Champaign, IL 61826

Phone: 217-373-6758  
 Fax: 217-373-7222  
 Collected: 05/20/2014  
 Received: 05/23/2014

Project

Sample ID: 3

Analysis	Analysis Date	Analyst Init.	Lab File ID	Canister ID	Sample Vol.	Dil. Factor
Initial	06/06/2014	KW	H0269.D	HD2106	25 cc	10
Dilution1	06/06/2014	KW	K0319.D	HD2106	25 cc	30

**Target Compound Results Summary**

Target Compounds	CAS#	MW	Result ppbv	RL ppbv	Q	Result ug/m3	RL ug/m3	Comments
cis-1,3-Dichlorobenzene	591-78-6	111.0	ND	5.0		ND	23	
Toluene	78-93-3	92.14	8.8	5.0		32	19	
trans-1,3-Dichlorobenzene	108-10-1	111.0	ND	5.0		ND	23	
1,1,2-Trichloroethane	80-62-6	133.4	ND	5.0		ND	27	
3-Hexanone(MBK)	1634-04-8	100.1	ND	5.0		ND	20	
Tetrahydrofuran	91-20-3	166.0	ND	5.0		ND	34	
Dibromodichloromethane	115-07-1	208.3	ND	10		ND	65	
1,3-Dibromoisobutane	100-42-5	167.8	ND	5.0		ND	38	
Chlorobenzene	75-65-0	112.6	ND	5.0		ND	23	
Ethylbenzene	78-34-8	106.2	ND	5.0		ND	22	
Xylene (p,m)	127-18-4	106.2	13	10		37	43	
Xylene (ortho)	109-99-9	106.2	6.8	5.0		26	22	
Styrene	106-98-3	104.1	ND	5.0		ND	21	
Isopropylbenzene(cumene)	120-82-1	120.19	ND	5.0		ND	25	
Extrahum	71-55-6	252.8	ND	5.0		ND	62	
1,1,2,2-Tetrachloroethane	79-00-2	167.8	ND	5.0		ND	34	
4-Ethyltoluene	79-01-8	120.2	ND	5.0		ND	25	
1,3,5-Trimethylbenzene	75-69-4	120.2	ND	5.0		ND	25	
2-Chlorotoluene	76-13-3	126.0	ND	5.0		ND	26	
1,2,4-Trimethylbenzene	95-63-6	120.2	ND	5.0		ND	25	
1,3-Dichlorobenzene	408-87-8	147.0	ND	5.0		ND	30	
1,4-Dichlorobenzene	540-84-1	147.0	ND	5.0		ND	30	
Benzyl chloride	105-19-4	126.0	ND	5.0		ND	26	
1,2-Dichlorobenzene	74-06-4	147.0	ND	5.0		ND	30	
1,2,4-Trichlorobenzene	75-01-4	181.5	ND	5.0		ND	37	
Hexachloro-1,3,5-triazine	1330-20-7	280.6	ND	5.0		ND	53	
Naphthalene	95-47-6	128.17	ND	5.0		ND	26	
<b>Total Target Compound Concentrations:</b>			<b>1200</b>	<b>ppbv</b>		<b>2800</b>	<b>ug/m3</b>	

**Surrogate**

4-Bromofluorobenzene

Result	Spike	Recovery
110	10	1100%

**Qualifier Definitions**

ND = Non Detect

B = Compound was found in method blank

E = Estimated (due to dilution exceeding upper calibration range)

D = Result reported from duplicate analysis

**Method References**

EPA: Comparison Method for High-Resolution Gas Chromatography/Mass Spectrometry (GC/MS) for Air. 7. Collection: Specialty Prepared Canisters and Analyzed by Gas Chromatography/Mass Spectrometry (GC/MS), January, 1998. (PNA626R-960104)



NJDEP Certification #: 03006



**EMSL Analytical**

200 Route 130 North, Champaign, IL 61826  
 Phone/Fax: (855)558-4800 / (855)558-4571  
<http://www.EMSL.com> [info@EMSL.com](mailto:info@EMSL.com)

EMSL Order #: 491400456  
 EMSL Sample #: 491400456-4  
 Customer ID: USAC50  
 Customer PO: Not Available

Alt: Michael Kemme  
 USACE/ER  
 P. O. Box 9005  
 Champaign, IL 61826

Phone: 217-373-6758  
 Fax: 217-373-7222  
 Collected: 05/20/2014  
 Received: 05/23/2014

Project: Sample ID: 4

Analysis initial      Analysis Date 06/06/2014      Analyst Init. KW      Lab File ID R0270.D      Canister ID HD2124      Sample Vol 25 cc      Dil. Factor 10

**Target Compound Results Summary**

Target Compounds	CAS#	MW	Result ppbv	RL ppbv	O	Result ug/m3	RL ug/m3	Comments
Freon-11	67-61-1	120.9	ND	10		ND	17	
Freon-12 (Dichlorodifluoromethane)	75-75-3	120.9	ND	5.0		ND	25	
Freon-114 (1,2-Dichloro-1,1,2,2-tetrafluoroethane)	107-18-1	170.9	ND	5.0		ND	35	
Chloromethane	107-05-1	50.49	ND	5.0		ND	10	
n-Butane	71-43-2	58.12	ND	5.0		ND	12	
Vinyl chloride	100-44-7	62.50	ND	5.0		ND	13	
1,2-Dibutane	75-27-4	54.09	ND	5.0		ND	11	
Bromomethane	593-80-2	94.94	ND	5.0		ND	19	
Chloroethane	75-25-2	64.52	ND	5.0		ND	15	
Ethanol	74-83-9	46.07	7.7	5.0		15	9.4	
Bromochloromethane (vinyl bromide)	105-95-0	106.0	ND	5.0		ND	22	
Freon-113 (1,1,2-trichloro-1,2,2,2-tetrafluoroethane)	106-87-8	137.4	ND	5.0		ND	38	
Isopropyl alcohol (2-Propanol)	108-90-7	60.10	9.9	5.0		24	12	
Freon-113B1 (1,1,2-trichloro-1,1,2,2-tetrafluoroethane)	75-00-2	167.4	ND	5.0		ND	38	
Acetone	67-66-3	58.08	71	5.0		179	12	
1,1-Dichloroethane	74-87-3	96.94	ND	5.0		ND	20	
Acetonitrile	75-15-0	41.05	100	5.0		179	14	
Tertiary butyl alcohol (TBA)	56-23-5	74.12	ND	5.0		ND	15	
Bromochloroethane (Ethyl bromide)	95-49-8	108.0	ND	5.0		ND	22	
5-Chloropropenal (Alyl chloride)	110-62-7	78.53	ND	5.0		ND	16	
Carbon disulfide	124-48-1	76.14	ND	5.0		ND	16	
Methylene chloride	106-93-8	84.94	ND	3.0		ND	17	
Acrylonitrile	95-50-1	53.06	ND	5.0		ND	11	
Methyl-tert-butyl ether (MTBE)	541-73-1	88.15	ND	5.0		ND	18	
trans-1,2-Dichloroethane	106-46-7	96.94	ND	5.0		ND	20	
n-Hexane	75-71-8	86.17	ND	5.0		ND	18	
1,1-Dichloroethane	75-34-3	98.96	ND	5.0		ND	20	
Vinyl acetate	107-06-2	86.09	ND	5.0		ND	15	
2-Butanone (MEK)	75-35-4	72.10	ND	5.0		ND	16	
cis-1,2-Dichloroethane	156-59-2	96.94	ND	5.0		ND	20	
Ethyl acetate	156-80-5	88.10	ND	5.0		ND	18	
Chloroform	78-87-5	119.4	ND	5.0		ND	24	
Tetrahydrofuran	10061-01-5	72.11	ND	5.0		ND	15	
1,1,1-Trichloroethane	10061-02-6	133.4	ND	3.0		ND	27	
Cyclohexane	75-14-2	98.15	ND	5.0		ND	17	
2,2,4-Trimethylpentane (isooctane)	123-91-1	114.2	ND	5.0		ND	23	
Carbon tetrachloride	64-17-6	153.8	ND	5.0		ND	31	
n-Heptane	64-17-6	100.2	ND	5.0		ND	20	
1,2-Dichloroethane	100-41-6	98.96	ND	5.0		ND	20	
Etanone	622-96-8	78.11	ND	5.0		ND	16	
Trichloroethane	142-83-5	131.4	ND	5.0		ND	27	
1,2-Dichloropropane	87-08-2	113.0	ND	5.0		ND	23	
Methyl Methacrylate	110-54-3	100.12	ND	5.0		ND	20	
Bromodichloromethane	67-83-8	163.8	ND	5.0		ND	33	
1,4-Dioxane	98-83-8	98.12	ND	5.0		ND	16	
1,1-Methyl-2-pyrrolidone (NMP)	75-08-2	100.2	ND	5.0		ND	20	



**EMSL Analytical**  
 200 Route 130 North, Commission, NJ 08933  
 Phone/Fax: (953)554-6000 / (953)558-4571  
 http://www.EMSL.com TO-15 Lab@EMSL.com

EMSL Order # 491400456  
 EMSL Sample # 491400456-4  
 Customer ID USAC50  
 Customer PO# Not Available

Attn: Michael Kemme  
 USACE/CER  
 P. O. Box 9005  
 Champaign, IL 61826

Phone: 217-373-6758  
 Fax: 217-373-7322  
 Collected: 05/20/2014  
 Received: 05/23/2014

Project:

Sample ID: 4

Analysis Initial	Analysis Date	Analyst Init.	Lab File ID	Canister ID	Sample Vol.	Dil. Factor
	06/06/2014	KW	R0270.D	HD2124	25 cc	10

**Target Compound Results Summary**

Target Compound	CAS#	MW	Result ppbv	RL ppbv	O	Result ug/m3	RL ug/m3	Comments
cis-1,4-Dichlorobenzene	501-78-6	111.0	ND	5.0		ND	23	
Toluene	78-93-3	92.14	ND	5.0		ND	49	
trans-1,3-Dichlorobenzene	108-90-1	111.0	ND	5.0		ND	23	
1,1,2-Trichloroethane	88-62-6	131.4	ND	5.0		ND	27	
2-Hexanone(MBK)	1634-04-8	100.1	ND	5.0		ND	20	
Tetrachloroethene	91-20-3	165.9	ND	5.0		ND	34	
Dibromochloromethane	115-07-1	206.9	ND	10		ND	35	
1,2-Dibromobenzene	100-42-5	187.8	ND	5.0		ND	38	
Chlorobenzene	75-85-0	112.6	ND	5.0		ND	23	
Ethylbenzene	78-34-9	106.2	ND	5.0		ND	22	
Xylene (o,m)	127-18-4	106.2	ND	10		ND	43	
Xylene (ortho)	109-99-0	106.2	ND	5.0		ND	22	
Styrene	102-68-3	104.1	ND	5.0		ND	21	
Isopropylbenzene (cumene)	120-92-1	120.19	ND	5.0		ND	25	
Ethylbenzene	71-65-8	106.2	ND	5.0		ND	22	
1,1,2,2-Tetrachloroethane	79-09-5	167.9	ND	5.0		ND	34	
4-Ethyltoluene	79-01-8	120.2	ND	5.0		ND	25	
1,3,5-Trimethylbenzene	75-68-4	120.2	ND	5.0		ND	25	
3-Chlorotoluene	76-13-7	126.0	ND	5.0		ND	26	
1,2,4-Trimethylbenzene	95-83-6	120.2	ND	5.0		ND	25	
1,3-Dichlorobenzene	108-87-8	147.0	ND	5.0		ND	30	
1,4-Dichlorobenzene	540-84-1	147.0	ND	5.0		ND	30	
Benzaldehyde	108-05-4	126.0	ND	5.0		ND	26	
1,2-Dichlorobenzene	74-96-4	147.0	ND	5.0		ND	30	
1,2,4-Trichlorobenzene	75-01-4	181.5	ND	5.0		ND	37	
Hexafluoro-1,3-butadiene	1330-20-7	280.8	ND	5.0		ND	33	
Naphthalene	95-47-6	128.17	ND	5.0		ND	26	
<b>Total Target Compound Concentrations:</b>			<b>190</b>	<b>ppbv</b>		<b>380</b>	<b>ug/m3</b>	

**Surrogate**

4-Bromofluorobenzene

Result	Subst	Recovery
100	10	100%

**Qualifier Definitions**

ND = Non Detect

B = Compound also found in method blank

E = Estimated concentration exceeding upper calibration range

D = Result repaired from diluted analysis

**Method Reference**

USEPA: Compendium Method TO-15: "Determination of Volatile Organic Compounds (VOCs) in Air: 152 (selected Specialty-Prepared Cleaners and Analyzed by Gas Chromatography/Mass Spectrometry (GC/MS))" Analy. 1988, EPA/625/R-98/010g



NJDEP Certification #: 03036



**EMSL Analytical**

200 Route 130 North, Champaign, IL 61826  
 Phone/Fax: (855)556-4800 / (855)558-4571  
 Web: www.EMSL.com, TOLL FREE 1-855-556-4800

EMSL Order #: 491400456  
 EMRL Sample #: 491400456-5  
 Customer ID: USAC50  
 Customer PO: Not Available

Attn: Michael Kemna  
 USACE/ER  
 P.O. Box 9006  
 Champaign, IL 61826

Phone: 217-373-6758  
 Fax: 217-373-7222  
 Collected: 05/20/2014  
 Received: 05/23/2014

Project: Sample ID: 5

Analysis Initial      Analysis Date      Analyst Init.      Lab File ID      Canister ID      Sample Vol.      Dil. Factor  
 Initial              05/06/2014              RW              H0271.D              HD2174              25 cc              10

**Target Compound Results Summary**

Target Compound	CAS#	MW	Result ppbv	RL ppbv	O	Result ug/m3	RL ug/m3	Comments
Freonine	67-64-7	42.09	ND	10		ND	17	
Freon 12 (Dichlorodifluoromethane)	75-05-3	120.9	ND	5.0		ND	25	
Freon 114 (1,1,2-Dichloro-1,1,2,2-tetrafluoroethane)	107-15-1	170.9	ND	5.0		ND	35	
Chloroethane	107-05-1	64.49	ND	5.0		ND	10	
n-Butane	74-92-2	58.12	ND	5.0		ND	12	
Vinyl chloride	100-44-7	62.50	ND	5.0		ND	13	
1,3-Butadiene	75-27-4	54.09	ND	5.0		ND	11	
Isomethane	593-80-2	94.94	ND	5.0		ND	19	
Chloroethane	75-25-2	64.52	ND	5.0		ND	13	
Ethanol	74-83-9	46.07	9.3	5.0		18	9.4	
Bis(methylamyl) amide	106-80-0	106.0	ND	5.0		ND	22	
Freon 11 (Trichlorofluoromethane)	106-97-8	137.4	ND	5.0		ND	28	
Isopropyl alcohol (2-Propanol)	106-90-7	60.10	17	5.0		41	12	
Freon 113 (1,1,2-Trichlorotrifluoroethane)	75-00-8	187.4	ND	5.0		ND	38	
Acetone	67-66-3	58.08	120	5.0		300	12	
1,1-Dichloroethane	74-87-5	96.94	ND	5.0		ND	20	
Acetonitrile	75-15-0	41.00	ND	5.0		ND	9.4	
Tertiary butyl alcohol (TBA)	56-23-5	74.12	ND	5.0		ND	15	
Bromochloroethane (Ethyl bromide)	95-49-8	108.0	ND	5.0		ND	22	
3-Chloropropene (Allyl chloride)	110-02-7	78.53	ND	5.0		ND	16	
Carbon disulfide	75-48-1	76.14	ND	5.0		ND	16	
Methylene chloride	106-95-9	84.94	ND	5.0		ND	17	
Acrylonitrile	95-50-1	53.00	ND	5.0		ND	11	
Methyl-tert-butyl ether (MTBE)	54-175-1	88.15	ND	5.0		ND	18	
trans-1,2-Dichloroethane	106-46-7	96.94	ND	5.0		ND	20	
n-Hexane	75-21-8	86.17	ND	5.0		ND	16	
1,1-Dichloroethane	75-34-3	96.98	ND	5.0		ND	20	
Vinyl acetate	107-10-2	86.00	ND	5.0		ND	18	
2-Butanone (MEK)	75-35-4	72.10	ND	5.0		ND	15	
cis-1,2-Dichloroethane	156-59-2	96.94	ND	5.0		ND	20	
Ethyl acetate	156-60-5	88.10	ND	5.0		ND	18	
Chloroform	78-87-5	119.4	ND	5.0		ND	24	
Tetrahydrofuran	10067-01-5	72.11	ND	5.0		ND	15	
1,1,1-Trichloroethane	10061-02-6	133.4	ND	5.0		ND	27	
Cyclohexane	78-14-2	98.16	ND	5.0		ND	17	
2,2,4-Trimethylpentane (isooctane)	123-91-1	114.2	ND	5.0		ND	23	
Carbon tetrachloride	141-76-6	153.8	ND	5.0		ND	31	
n-Heptane	64-17-5	100.2	ND	5.0		ND	20	
1,2-Dichloroethane	100-41-4	96.96	ND	5.0		ND	20	
Benzene	622-96-8	78.11	ND	5.0		ND	16	
Trichloroethane	142-82-5	131.4	ND	5.0		ND	27	
1,2-Dichloropropane	87-69-3	113.0	ND	5.0		ND	23	
Methyl Methacrylate	110-54-3	100.12	ND	5.0		ND	20	
Bromodichloromethane	67-63-0	153.8	ND	5.0		ND	33	
1,4-Dioxane	95-82-8	98.12	ND	5.0		ND	16	
4-Methyl-2-pentanone (MIBK)	75-08-2	100.2	ND	5.0		ND	20	



**EMSL Analytical**  
 200 Route 130 North, Commission, NJ 08933  
 Phone/Fax: (953)554-6000 / (953)558-4571  
 http://www.EMSL.com TO-15 Lab@EMSL.com

EMSL Order # 491400456  
 EMSL Sample # 491400456-5  
 Customer ID USAC50  
 Customer PO Not Available

Alt: Michael Kemme  
 USACE/ER  
 P. O. Box 9005  
 Champaign, IL 61826

Phone: 217-373-6758  
 Fax: 217-373-7222  
 Collected: 05/20/2014  
 Received: 05/23/2014

Project: Sample ID: 5

Analysis	Analysis Date	Analyst Init.	Lab File ID	Canister ID	Sample Vol.	Dil. Factor
initial	06/06/2014	KW	R0271.D	HD2174	25 cc	10

**Target Compound Results Summary**

Target Compound	CAS#	MW	Result ppbv	RL ppbv	O	Result ug/m3	RL ug/m3	Comments
o1,3-Dichlorobenzene	501-78-6	111.0	ND	5.0		ND	23	
Toluene	78-93-3	92.14	ND	5.0		ND	49	
trans-1,3-Dichlorobenzene	108-90-1	111.0	ND	5.0		ND	23	
1,1,2-Trichloroethane	88-62-6	133.4	ND	5.0		ND	27	
2-Hexanone(MBK)	1634-04-8	100.1	ND	5.0		ND	20	
Tetrachloroethene	91-20-3	165.9	ND	5.0		ND	34	
Dibromochloromethane	115-07-1	206.9	ND	10		ND	35	
1,2-Dibromobenzene	100-42-5	187.8	ND	5.0		ND	38	
Chlorobenzene	75-65-0	112.6	ND	5.0		ND	23	
Ethylbenzene	78-34-9	106.2	ND	5.0		ND	22	
Xylene (o,m)	127-18-4	106.2	ND	10		ND	43	
Xylene (ortho)	109-99-0	106.2	ND	5.0		ND	22	
Styrene	102-68-3	104.1	ND	5.0		ND	21	
propylbenzene (cumene)	120-92-1	120.19	ND	5.0		ND	25	
Ethylbenzene	71-65-8	106.2	ND	5.0		ND	22	
1,1,2,2-Tetrachloroethane	79-09-5	167.9	ND	5.0		ND	34	
4-Ethyltoluene	79-01-8	120.2	ND	5.0		ND	25	
1,3,5-Trimethylbenzene	75-68-4	120.2	ND	5.0		ND	25	
3-Chlorotoluene	76-13-7	126.0	ND	5.0		ND	26	
1,2,4-Trimethylbenzene	95-83-6	120.2	ND	5.0		ND	25	
1,3-Dichlorobenzene	108-87-8	147.0	ND	5.0		ND	30	
1,4-Dichlorobenzene	540-84-1	147.0	ND	5.0		ND	30	
Benzaldehyde	108-05-4	126.0	ND	5.0		ND	26	
1,2-Dichlorobenzene	74-96-4	147.0	ND	5.0		ND	30	
1,2,4-Trichlorobenzene	75-01-4	181.5	ND	5.0		ND	37	
Hexafluor-1,3-butadiene	1330-20-7	260.8	ND	5.0		ND	33	
Naphthalene	95-47-6	128.17	ND	5.0		ND	26	
<b>Total Target Compound Concentrations:</b>			<b>150</b>	<b>ppbv</b>		<b>390</b>	<b>ug/m3</b>	

**Surrogate**

4-Bromofluorobenzene

Result	Subs	Recovery
100	10	100%

**Qualifier Definitions**

ND = Non Detect

B = Compound also found in method blank

E = Estimated concentration exceeding upper calibration range

D = Result repaired from diluted analysis

**Method Reference**

USEPA: Compendium Method TO-15 "Determination of Volatile Organic Compounds (VOCs) in Air: 152 (selected Specialty-Prepared Cleaners and Analyzed by Gas Chromatography/Mass Spectrometry (GC/MS))" Analy. 1988, EPA/625/R-98/010a



ILDEP Certification #: 03036



# USEPA TO-15

## External Chain of Custody/ Field Test Data Sheet

EMSL Analytical, Inc.  
 200 Route 130 North  
 Cinnaminson, NJ 08077  
 Ph. (800) 220-3675  
 Fax (856) 786-0327

EMSL Analytical, Inc. EMSL Order Number (Lab Use Only): 491400456

Report To Contact Name: Michael Kemme Bill To Company: CINNAMINSON, NJ Sampled By (Sign):  
 Company Name: USACE ERDC-CERL Attention To:  
 Address 1: PO Box 9005 Address 1: 14 MAY 23 AM 10: 29 Sampled By (Name):  
 Address 2: Champaign, IL 61826-9005 Address 2: Date Shipped:  
 Phone No.: 217-373-4554 Fax: Phone No.: Fax: Sample Collection Zip Code: 61822  
 Email Results To: michael.n.kemme@usace.army.mil Project Name: Purchase Order:

Turnaround Time (in Business Days):  10 Day Standard  5 Day  4 Day  3 Day  2 Day  1 Day  Other

Reporting Format:  Results Only (Standard Lab Report)  Full Deliverables (Surcharge may apply)  Other

EMSL Sample Identifier

Client Field Sample Identification	Field Use - All Information Required								Lab Use Only						USEPA TO-15 NUDEP LLTO-15 LIBRARY SEARCH	Other (Specify)	Matrix				
	Sampling Start Information				Sampling Stop Information				Canister Information				Flow Controller				Indoor/ Ambient Air	Soil Gas	Landfill/ Vent		
	Start Date	Time (24 hr clock)	Canister Pressure (Hg)	Interior Temp. (F)	Stop Date	Time (24 hr clock)	Canister Pressure (Hg)	Interior Temp. (F)	Canister ID	Size (L)	Can Cert Batch ID	Outgoing Pressure (Hg)	Incoming Pressure (Hg)	Reg. ID						Cal Flow (ml/min)	
	Barometric Pres. (Hg): <u>29.89</u>								Barometric Pres. (Hg): <u>29.90</u>												
1	5/20/14	11:13	-25.0	82	5/20/14	11:38	-20	82	HD 2750	6.4	H0216	-30.0	-2.0	3653	22.2						
2	5/20/14	14:04	-29.0	78	5/20/14	14:27	-22	77	2337				-1.0	3709	19.7						
3	5/21/14	10:33	-28.0	88	5/21/14	11:57	-20.0	89	2106				-2.0	3600	19.9						
4	5/21/14	14:32	-24	93	5/21/14	14:50	-1.0	95	2124				-4.0	3652	20.1						
5	5/22/14	10:57	-30	73	5/22/14	11:25	-2.0	72	2174				0.0	3537	19.8						

Comments: Pressure from weather station 29.89 on 5/20/14 and 29.90 on 5/21/14 30.09 "Hg on 5/22/14

Lab Canister Certification Analyst Signature (TO-15):

Relinquished by:	Date/ Time	Received by:	Date/ Time	Affixed Seal #	Reason for Exchange (circle appropriate)
<u>Michael Kemme</u>	5/21/14 16:25	<u>Michael Kemme</u>	5/21/14 14:00	525	Shipping Courier Receiving Sampling Other:
<u>Michael Kemme</u>	5/19/14 14:00	<u>Michael Kemme</u>	5/19/14 14:00		Shipping Courier Receiving Sampling Other:
<u>Michael Kemme</u>	5/20/14 11:00	<u>Michael Kemme</u>	5/22/14 13:30	525	Shipping Courier Receiving Sampling Other:
<u>Michael Kemme</u>	5/22/14 13:30	<u>Michael Kemme</u>	5/23/14 9:30		Shipping Courier Receiving Sampling Other:
<u>Michael Kemme</u>	5/23/14 9:30	<u>Michael Kemme</u>	5/25/14 10:10		Shipping Courier Receiving Sampling Other: <u>Other</u> <u>AN</u>

# REPORT DOCUMENTATION PAGE

*Form Approved*  
*OMB No. 0704-0188*

Public reporting burden for this collection of information is estimated to average 1 hour per response, including the time for reviewing instructions, searching existing data sources, gathering and maintaining the data needed, and completing and reviewing this collection of information. Send comments regarding this burden estimate or any other aspect of this collection of information, including suggestions for reducing this burden to Department of Defense, Washington Headquarters Services, Directorate for Information Operations and Reports (0704-0188), 1215 Jefferson Davis Highway, Suite 1204, Arlington, VA 22202-4302. Respondents should be aware that notwithstanding any other provision of law, no person shall be subject to any penalty for failing to comply with a collection of information if it does not display a currently valid OMB control number. PLEASE DO NOT RETURN YOUR FORM TO THE ABOVE ADDRESS.

<b>1. REPORT DATE (DD-MM-YYYY)</b> 19-08-2015			<b>2. REPORT TYPE</b> Final		<b>3. DATES COVERED (From - To)</b>	
<b>4. TITLE AND SUBTITLE</b> The Structural Insulated Panel "SIP Hut": Preliminary Evaluation of Energy Efficiency and Indoor Air Quality					<b>5a. CONTRACT NUMBER</b>	
					<b>5b. GRANT NUMBER</b>	
					<b>5c. PROGRAM ELEMENT</b>	
<b>6. AUTHOR(S)</b> Megan A. Kreiger, Dahtzen Chu, Som S. Shrestha, K. James Hay, Michael R. Kemme, Andrew C. Johannes, Charles Decker, Debbie Lawrence, Ashok Kumar, Steven D. Hart, and Karl F. Meyer					<b>5d. PROJECT NUMBER</b>	
					<b>5e. TASK NUMBER</b>	
					<b>5f. WORK UNIT NUMBER</b>	
<b>7. PERFORMING ORGANIZATION NAME(S) AND ADDRESS(ES)</b> U.S. Army Engineer Research and Development Center (ERDC) Construction Engineering Research Laboratory (CERL) PO Box 9005, Champaign, IL 61826-9005					<b>8. PERFORMING ORGANIZATION REPORT NUMBER</b>  ERDC/CERL TR-15-19	
<b>9. SPONSORING / MONITORING AGENCY NAME(S) AND ADDRESS(ES)</b> U.S. Army Natick Soldier Research, Development and Engineering Center (NSRDEC) 15 Kansas Street Natick, MA 01760-5000					<b>10. SPONSOR/MONITOR'S ACRONYM(S)</b>  NSRDEC	
					<b>11. SPONSOR/MONITOR'S REPORT NUMBER(S)</b>	
<b>12. DISTRIBUTION / AVAILABILITY STATEMENT</b> Approved for public release; distribution is unlimited.						
<b>13. SUPPLEMENTARY NOTES</b>						
<b>14. ABSTRACT</b> The Army uses a variety of soft shelters and semi-permanent structures at contingency operating bases for functions such as barracks, dining halls, administrative offices, and maintenance shops. Soldiers or local nationals commonly build these structures by hand, and they often manifest performance problems. The use of prefabricated Structural Insulated Panels (SIPs) offers significant benefits for enhancing the performance of building envelopes and reducing assembly time. SIPs used in the simple "SIP hut" can eliminate or reduce many of the problems associated with existing structures constructed in theater. This work compared the performance of the SIP hut with commonly used B-huts in terms of cost, shipping, assembly time, skill level required to build, durability, energy efficiency, and indoor air quality (IAQ). Results show that the SIP hut can be constructed quickly using minimal tools and unskilled labor, has excellent building envelop air tightness, can maintain acceptable IAQ levels with proper ventilation, and may potentially use only about one-fourth of the heating energy and one-sixth of the cooling energy required by an ordinary B-hut. The SIP hut does have some issues with water intrusion, VOCs emissions, and fire protection requirements that will be addressed in newer versions of the hut.						
<b>15. SUBJECT TERMS</b> Structural Insulated Panel, SIP Hut, energy conservation, energy efficient, construction, indoor air quality (IAQ)						
<b>16. SECURITY CLASSIFICATION OF:</b>			<b>17. LIMITATION OF ABSTRACT</b>	<b>18. NUMBER OF PAGES</b>	<b>19a. NAME OF RESPONSIBLE PERSON</b>	
<b>a. REPORT</b> Unclassified	<b>b. ABSTRACT</b> Unclassified	<b>c. THIS PAGE</b> Unclassified			SAR	128