



**NAVAL
POSTGRADUATE
SCHOOL**

MONTEREY, CALIFORNIA

**SYSTEMS ENGINEERING
CAPSTONE PROJECT REPORT**

**APPLICATION OF MODEL-BASED SYSTEMS
ENGINEERING (MBSE) TO COMPARE LEGACY AND
FUTURE FORCES IN MINE WARFARE (MIW) MISSIONS**

by

Team MIW
SE311-132Open/

December 2014

Capstone Project Advisors:

Eugene Paulo
Brigitte Kwinn
Paul Beery
Raymond Madachy

Approved for public release; distribution is unlimited

THIS PAGE INTENTIONALLY LEFT BLANK

REPORT DOCUMENTATION PAGE			<i>Form Approved OMB No. 0704-0188</i>
Public reporting burden for this collection of information is estimated to average 1 hour per response, including the time for reviewing instruction, searching existing data sources, gathering and maintaining the data needed, and completing and reviewing the collection of information. Send comments regarding this burden estimate or any other aspect of this collection of information, including suggestions for reducing this burden, to Washington headquarters Services, Directorate for Information Operations and Reports, 1215 Jefferson Davis Highway, Suite 1204, Arlington, VA 22202-4302, and to the Office of Management and Budget, Paperwork Reduction Project (0704-0188) Washington DC 20503.			
1. AGENCY USE ONLY (Leave blank)	2. REPORT DATE December 2014	3. REPORT TYPE AND DATES COVERED Capstone Project Report	
4. TITLE AND SUBTITLE APPLICATION OF MODEL-BASED SYSTEMS ENGINEERING (MBSE) TO COMPARE LEGACY AND FUTURE FORCES IN MINE WARFARE (MIW) MISSIONS		5. FUNDING NUMBERS	
6. AUTHOR(S) SE311-132Open/Team MIW		8. PERFORMING ORGANIZATION REPORT NUMBER	
7. PERFORMING ORGANIZATION NAME(S) AND ADDRESS(ES) Naval Postgraduate School Monterey, CA 93943-5000		10. SPONSORING/MONITORING AGENCY REPORT NUMBER	
9. SPONSORING /MONITORING AGENCY NAME(S) AND ADDRESS(ES) N/A		11. SUPPLEMENTARY NOTES The views expressed in this thesis are those of the author and do not reflect the official policy or position of the Department of Defense or the U.S. Government. IRB protocol number _____N/A_____.	
12a. DISTRIBUTION / AVAILABILITY STATEMENT Approved for public release; distribution is unlimited		12b. DISTRIBUTION CODE A	
13. ABSTRACT (maximum 200 words) This capstone report describes the expected mine countermeasures (MCM) performance of the Avenger class MCM ship (MCM 1), landing helicopter deck (LHD) support ship, and MH-53E helicopter legacy systems and Increment 1 of the littoral combat ship (LCS) and MH-60S helicopter future systems. The study focused on two measures of effectiveness (MOEs): area coverage rate sustained (ACRS) and percent clearance of mines. The systems engineering (SE) approach used to address stakeholder needs identified foundational requirements and developed functional and physical architectures for simulation in conducting the comparative technical analysis. A design of experiments (DOE) methodology was used to determine which factors have the greatest influence on the MOEs. The significant factors' values were varied to develop a set of recommended improvements to the future MCM systems. The study found that maintaining a constant search speed of 10 knots, improving the stream and recover time to 15 minutes, and improving the sortie time to 24 hours for the remote minehunting system (RMS) would provide a future ACRS performance greater than that provided by the legacy systems. When factoring in risk and operating and sustainment (O&S) costs, the future capability and recommended improvements provide better performance per cost than the legacy capability.			
14. SUBJECT TERMS model based systems engineering, design of experiments, requirements analysis, mine warfare, MIW, mine countermeasures, MCM, littoral combat ship, LCS, Avenger, MCM 1, MCM-1, ACRS, area coverage rate sustained, remote minehunting system, RMS, minehunting		15. NUMBER OF PAGES 359	
		16. PRICE CODE	
17. SECURITY CLASSIFICATION OF REPORT Unclassified	18. SECURITY CLASSIFICATION OF THIS PAGE Unclassified	19. SECURITY CLASSIFICATION OF ABSTRACT Unclassified	20. LIMITATION OF ABSTRACT UU

NSN 7540-01-280-5500

Standard Form 298 (Rev. 2-89)
Prescribed by ANSI Std. Z39-18

THIS PAGE INTENTIONALLY LEFT BLANK

Approved for public release; distribution is unlimited

**APPLICATION OF MODEL-BASED SYSTEMS ENGINEERING (MBSE) TO
COMPARE LEGACY AND FUTURE FORCES IN MINE WARFARE (MIW)
MISSIONS**

SE311-132Open/Team MIW

David Frank Kevin Hogan Shane Schonhoff

Submitted in partial fulfillment of the
requirements for the degree of

MASTER OF SCIENCE IN SYSTEMS ENGINEERING

and

Nicole Becker Timothy Byram Richard Kim
Glenna Miller Scott Myers Heather Whitehouse

Submitted in partial fulfillment of the
requirements for the degree of

MASTER OF SCIENCE IN ENGINEERING SYSTEMS

from the

**NAVAL POSTGRADUATE SCHOOL
DECEMBER 2014**

Lead Editor: Nicole Becker

Reviewed By:

Eugene Paulo
Capstone Project Advisor

Brigitte Kwinn
Project Advisor

Paul Beery
Project Advisor

Raymond Madachy
Project Advisor

Accepted By:

Cliff Whitcomb
Systems Engineering Department

THIS PAGE INTENTIONALLY LEFT BLANK

ABSTRACT

This capstone report describes the expected mine countermeasures (MCM) performance of the Avenger class MCM ship (MCM 1), landing helicopter deck (LHD) support ship, and MH-53E helicopter legacy systems and Increment 1 of the littoral combat ship (LCS) and MH-60S helicopter future systems. The study focused on two measures of effectiveness (MOEs): area coverage rate sustained (ACRS) and percent clearance of mines. The systems engineering (SE) approach used to address stakeholder needs identified foundational requirements and developed functional and physical architectures for simulation in conducting the comparative technical analysis. A design of experiments (DOE) methodology was used to determine which factors have the greatest influence on the MOEs. The significant factors' values were varied to develop a set of recommended improvements to the future MCM systems. The study found that maintaining a constant search speed of 10 knots, improving the stream and recover time to 15 minutes, and improving the sortie time to 24 hours for the remote minehunting system (RMS) would provide a future ACRS performance greater than that provided by the legacy systems. When factoring in risk and operating and sustainment (O&S) costs, the future capability and recommended improvements provide better performance per cost than the legacy capability.

THIS PAGE INTENTIONALLY LEFT BLANK

TABLE OF CONTENTS

I.	INTRODUCTION AND BACKGROUND.....	1
A.	PROJECT BACKGROUND.....	2
B.	PROBLEM	3
C.	APPROACH.....	4
D.	PROJECT CONSTRAINTS	5
E.	PROJECT ASSUMPTIONS	6
F.	PROJECT SCOPE.....	6
G.	RESEARCH QUESTIONS	9
H.	LITERATURE REVIEW	12
	1. History of Mine Countermeasures	12
	2. Summary of Lessons Learned from History	13
I.	TRANSITION TO REVOLUTION IN MIW	13
	1. New Threats.....	14
	2. Mine Warfare: a Neglected Mission.....	15
	3. Technology and the Current Threat	16
	4. The Asymmetric Threat	17
J.	DEVELOPING NEW CAPABILITY AGAINST A NEW THREAT	18
K.	MINE TYPES.....	21
L.	MCM CONCEPTS, CAPABILITIES, AND COMPETENCIES.....	24
M.	MCM OPERATIONAL FUNCTIONS OVERVIEW	27
N.	MIW CHALLENGES AND MISSIONS	28
O.	INTELLIGENCE IN MCM OPERATIONS	30
P.	INTRODUCTION AND BACKGROUND SUMMARY	33
II.	SYSTEMS ENGINEERING APPROACH	35
A.	PROCESS OVERVIEW	35
B.	REQUIREMENTS ANALYSIS	38
C.	FUNCTIONAL ANALYSIS	40
D.	PHYSICAL SYNTHESIS	41
E.	ANALYSIS OF ALTERNATIVES	41
F.	MODEL BASED SYSTEMS ENGINEERING APPROACH.....	43
G.	SYSTEMS ENGINEERING PROCESS MANAGEMENT	44
H.	STRENGTHS AND LIMITATIONS.....	44
I.	SE PROCESS SUMMARY	45
III.	STAKEHOLDER ANALYSIS	47
A.	STAKEHOLDER IDENTIFICATION AND ANALYSIS.....	47
B.	REQUIREMENTS ANALYSIS	53
	1. Primitive Need Summary	53
	2. Effective Need Summary	53
	3. Capability Need Statement.....	54
	4. Problem Statement.....	54
C.	REQUIREMENTS.....	55

D.	REQUIREMENTS ANALYSIS SUMMARY	60
IV.	SYSTEMS ARCHITECTURE	61
A.	SYSTEM CONTEXT	61
B.	FUNCTIONAL DECOMPOSITION.....	65
1.	MCM Operational Functions Overview	66
2.	Top-Level Functional Description.....	66
3.	Minehunting Functional Description	71
a.	<i>1.1.2.1 Detect Mines</i>	<i>72</i>
b.	<i>1.1.2.2 Classify Mines</i>	<i>72</i>
c.	<i>1.1.2.3 Reacquire MILCOs</i>	<i>72</i>
d.	<i>1.1.2.4 Identify Mines</i>	<i>72</i>
e.	<i>1.1.3 Neutralize Mines</i>	<i>73</i>
f.	<i>1.1.3.1 Reacquire Mines</i>	<i>73</i>
g.	<i>1.1.3.2 Destroy Mines.....</i>	<i>73</i>
4.	Other Functions Related to Minehunting.....	73
a.	<i>1.2 Control Equipment.....</i>	<i>73</i>
b.	<i>1.2.1 Transit Systems</i>	<i>74</i>
c.	<i>1.2.2 Load Fuel</i>	<i>74</i>
d.	<i>1.2.3 Maneuver Systems.....</i>	<i>74</i>
e.	<i>1.2.4 Recover Equipment.....</i>	<i>74</i>
f.	<i>1.2.5 Stream Equipment.....</i>	<i>75</i>
g.	<i>1.2.6 Reload / Rearm.....</i>	<i>75</i>
h.	<i>1.3 Gather or Receive Data and Information</i>	<i>75</i>
i.	<i>1.3.1 Analyze Data</i>	<i>76</i>
j.	<i>1.3.2 Decide Course of Action</i>	<i>76</i>
k.	<i>1.4 Maintain Equipment.....</i>	<i>76</i>
5.	Functional Flow Block Diagrams and Descriptions	77
a.	<i>Top-Level Minehunting Functions</i>	<i>77</i>
b.	<i>Transit Function</i>	<i>80</i>
c.	<i>Detect Function.....</i>	<i>80</i>
d.	<i>Classify and Analyze Functions</i>	<i>81</i>
e.	<i>Identify Function</i>	<i>82</i>
f.	<i>Neutralize Function</i>	<i>83</i>
g.	<i>Control and Maintenance Functions</i>	<i>83</i>
6.	Conclusion of the Functional Architecture.....	84
C.	PHYSICAL DECOMPOSITION	85
1.	Legacy MCM Systems Operational View and Physical Architecture.....	85
2.	Future MCM Systems Operational View and Physical Architecture.....	89
3.	Physical Traceability to Functions	94
D.	VALUE HIERARCHY.....	95
1.	Effective Need.....	99
2.	Primary Objective.....	99
E.	REQUIREMENTS.....	102

F.	SYSTEM ARCHITECTURE SUMMARY	110
V.	OPERATIONAL CONCEPT AND SCENARIO ANALYSIS	111
A.	OPERATIONAL CONTEXT	111
B.	OPERATIONAL CONCEPTS	114
C.	OPERATIONAL SCENARIO.....	116
D.	OPERATIONAL CONCEPT AND SCENARIO SUMMARY	127
VI.	MODEL AND SIMULATION DEVELOPMENT	129
A.	CHOICE OF MODELING AND SIMULATION TOOL.....	129
1.	ExtendSim.....	129
2.	MANA	131
3.	Evaluation for Utility in Capstone Study.....	132
4.	Recommendation for Use	133
B.	DESCRIPTION OF MODELS.....	134
1.	Model of Legacy System MCM	138
a.	<i>Concept of Operations</i>	139
b.	<i>Model Design</i>	143
c.	<i>Model Implementation</i>	145
2.	Model of Future MCM Systems	148
a.	<i>Concept of Operations</i>	148
b.	<i>Model Design</i>	149
c.	<i>Model Implementation</i>	151
C.	MODELING ASSUMPTIONS	154
D.	MODEL INPUTS.....	155
E.	MODEL INTERNAL VARIABLES	164
1.	Attributes.....	164
2.	Local Variables.....	165
3.	Global Variables.....	165
a.	<i>General Use Global Variables</i>	165
b.	<i>User-Defined Global Arrays</i>	166
4.	Connector Values	166
5.	System Variables.....	167
F.	MODEL OUTPUTS.....	167
1.	Hunt Effectiveness Table.....	168
2.	Target Outputs Data Table	171
3.	History Blocks	174
G.	RUNNING THE SIMULATION.....	174
1.	Repeated Runs versus Multiple Different Runs.....	175
2.	Selecting Legacy MCM Model Configurations.....	175
H.	VERIFICATION AND VALIDATION	175
1.	Definitions	176
2.	Verification	176
3.	Validation.....	187
I.	MODELING AND SIMULATION CONCLUSION.....	188
VII.	DOE AND SENSITIVITY ANALYSIS	189

A.	VARIABLES OF INTEREST	189
B.	DESIGN OF EXPERIMENTS	192
C.	SENSITIVITY ANALYSIS	193
1.	Outputs of the Initial DOE.....	196
2.	Refinement of the Initial DOE.....	196
3.	Refinement of the First DOE	203
D.	DESIGN OF EXPERIMENTS AND SENSITIVITY ANALYSIS SUMMARY	225
VIII.	SYSTEM PERFORMANCE ANALYSIS	227
A.	BASELINE CONFIGURATIONS	227
1.	Baseline Legacy Configuration 1A	228
2.	Baseline Legacy Configuration 1B	230
3.	Baseline Legacy Configuration 2A	232
4.	Baseline Legacy Configuration 2B	233
5.	Baseline Future Configuration 3	236
B.	COMPARISON OF LEGACY AND FUTURE SYSTEMS	238
C.	FUTURE LCS CONFIGURATION 3 IMPROVEMENTS.....	239
D.	ANALYSIS CONCLUSIONS.....	243
IX.	COST AND RISK ANALYSIS	245
A.	COST ANALYSIS	245
1.	Cost Analysis Methodology	246
2.	Hourly O&S Cost Estimates for MIW Systems	246
3.	Neutralizer Cost Estimates.....	251
4.	Scenario Cost Estimates	252
5.	Cost Comparison for LCS Improvements.....	256
B.	RISK ANALYSIS.....	259
1.	Risk Assessment Methodology	259
2.	Legacy Option Risk Assessment	263
3.	Future Option Risk Assessment	267
4.	Risk Comparison.....	270
C.	COST AND RISK CONCLUSIONS.....	270
X.	SUMMARY, CONCLUSIONS, AND RECOMMENDATIONS	271
A.	CAPSTONE CONCLUSIONS	272
B.	RECOMMENDATIONS FOR ENHANCED LCS OPERATION	275
C.	RECOMMENDATIONS FOR FUTURE STUDIES.....	276
1.	Expanded Operational Scenario.....	277
2.	Model Improvements.....	277
3.	Study Extensions	278
APPENDIX A.	SUMMARY OF MCM HISTORY	281
A.	WAR OF INDEPENDENCE TO FIRST WORLD WAR (1777–1918)..	281
B.	BETWEEN THE TWO WORLD WARS (1918–1938).....	283
C.	SECOND WORLD WAR (1939–1945).....	283
D.	POST-SECOND WORLD WAR (1946–1949)	285
E.	KOREAN CONFLICT TO VIETNAMESE CONFLICT (1950–1964) .	286

F.	VIETNAMESE CONFLICT (1965–1973).....	288
G.	POST-VIETNAMESE CONFLICT (1974–1983).....	289
H.	MIDDLE EAST (1984–1990).....	292
I.	OPERATION DESERT STORM (1991).....	294
J.	AFTER OPERATION DESERT STORM (1992–2014).....	294
APPENDIX B. OVERVIEW OF MANA AND EXTENDSIM.....		297
A.	MANA OVERVIEW	297
1.	Evaluation for Utility in Capstone Study.....	297
2.	Advantages of MANA.....	298
3.	Disadvantages of MANA	299
4.	Recommendations for MANA Use	301
B.	EXTENDSIM DESCRIPTION.....	301
1.	Evaluation for Utility in Capstone Study.....	301
2.	Advantages of ExtendSim	302
3.	Disadvantages of ExtendSim.....	302
4.	Recommendations for ExtendSim Use.....	303
C.	SIMULATION TOOL RECOMMENDATION	303
APPENDIX C. SIMULATION OVERVIEW		305
A.	SINGLE AND REPEATED RUNS	308
B.	DESIGN OF EXPERIMENTS OR MULTIPLE RUNS	309
C.	SELECTING LEGACY MCM MODEL CONFIGURATIONS	311
APPENDIX D. SOFTWARE DESIGN DOCUMENT		313
A.	CONTACT INFORMATION.....	313
B.	SDD TABLE OF CONTENTS	313
LIST OF REFERENCES.....		317
INITIAL DISTRIBUTION LIST		323

THIS PAGE INTENTIONALLY LEFT BLANK

LIST OF FIGURES

Figure 1.	U.S. Navy Mine Casualties (from PEO LMW 2007, 8)	3
Figure 2.	Types and Locations of Mines (from Amador 2011)	22
Figure 3.	Advances in Mine Technology Since the 18th Century (after Melia 1991)	24
Figure 4.	MIW Subdivisions and MCM Categories (from DON 2010)	25
Figure 5.	Classic Systems Engineering “Vee” (from Forsberg and Mooz 1991, Exhibit 5)	36
Figure 6.	Tailored SE Process used for the MCM Comparative Analysis Study	38
Figure 7.	Requirements Analysis used for the MCM Comparative Analysis Study	39
Figure 8.	Functional Analysis used for the MCM Comparative Analysis Study	40
Figure 9.	Physical Synthesis used for the MCM Comparative Analysis Study	41
Figure 10.	AoA used for the MCM Comparative Analysis Study	42
Figure 11.	MCM SOS Context Diagram.....	63
Figure 12.	Defensive MCM Functions—The Top-level FFBD View of the MCM Functions (from PEO LMW 2008).....	68
Figure 13.	MIW Functional Hierarchy (after PEO LMW 2008)	70
Figure 14.	Minehunting Functional Hierarchy.....	71
Figure 15.	Control Equipment Functional Hierarchy.....	74
Figure 16.	Gather/Receive Data and Information Functional Hierarchy	76
Figure 17.	EFFBD for Minehunting Functions—Overview	79
Figure 18.	Prepare for Operations EFFBD.....	80
Figure 19.	Detect Mines EFFBD.....	81
Figure 20.	Classify and Analyze EFFBD.....	82
Figure 21.	Identify EFFBD	82
Figure 22.	Neutralize Mines EFFBD	83
Figure 23.	Control and Maintenance EFFBD	84
Figure 24.	MCM Physical Systems Hierarchy.....	85
Figure 25.	MCM 1 CONOPS (from MIW C4ISR 2001, Slide 14).....	86
Figure 26.	Legacy MCM Physical Systems Hierarchy	87
Figure 27.	Legacy AMCM Neutralizing Systems Hierarchy.....	88
Figure 28.	Legacy SMCM Neutralizing Systems Hierarchy	88
Figure 29.	LCS CONOPS (from Broughton and Burdon 1998).....	90
Figure 30.	LCS Countermining Warfare Flow Chart (after National Geographic Channel 2014).....	92
Figure 31.	Future MCM Physical Systems Hierarchy	93
Figure 32.	Defensive MCM MOEs and MOPs Per PEO LMW 3370.1A (after PEO LMW 2008)	97
Figure 33.	Value Hierarchy (after PEO LMW 2008).....	98
Figure 34.	MCM Roadmap (from Amador 2011).....	112
Figure 35.	MCM Transition	113
Figure 36.	Transition from Legacy to Future MCM Capability (from Amador 2011)..	114
Figure 37.	Common Deep-Water SLOC Scenario.....	117

Figure 38.	Configuration 1: MCM 1 with MH-53E (Parallel Hunt and Serial Neutralization)	122
Figure 39.	Configuration 2: MCM 1 with MH-53E (Parallel Hunt and Parallel Neutralization)	124
Figure 40.	Configuration 3: LCS Increment 1	126
Figure 41.	ExtendSim Model—Decomposition	136
Figure 42.	MCM 1—Detect to Neutralize.....	140
Figure 43.	MH-53E—Detect and Classify	141
Figure 44.	MCM 1 and MH-53E—RI&N.....	142
Figure 45.	Legacy MCM Model—Top Level Model Sequence Diagram (Phase 1)	143
Figure 46.	Legacy MCM Model—Top Level Model Sequence Diagram (Phase 2)	144
Figure 47.	ExtendSim Model for Legacy MCM—Top Level View	147
Figure 48.	LCS (RMS) and MH-60S—Parallel Operations.....	149
Figure 49.	Future MCM Model—Top Level Model Sequence Diagram.....	151
Figure 50.	ExtendSim Model for Future MCM—Top Level View	153
Figure 51.	Model Input Parameters in Inputs Database	156
Figure 52.	Model Output Data—Outputs Database	168
Figure 53.	Example of a History Block (shown in red circle)	174
Figure 54.	Figurative Solution Space Saturation: A Method to Find Data Correlations (after Vieira Jr. et al. 2013).....	193
Figure 55.	Sensitivity Analysis Process	195
Figure 56.	Residual by Predicted Plot—Configuration 1A.....	213
Figure 57.	Residual by Predicted Plot—Configuration 1B	213
Figure 58.	Residual by Predicted Plot—Configuration 2A.....	214
Figure 59.	Residual by Predicted Plot—Configuration 2B	214
Figure 60.	Residual by Predicted Plot—Configuration 3.....	215
Figure 61.	Residual by Predicted Plot-Configuration 3 Without Outlier.....	215
Figure 62.	Configuration 1A Transformed Residuals Plot.....	216
Figure 63.	Configuration 1B Transformed Residuals Plot.....	216
Figure 64.	Configuration 2A Transformed Residuals Plot.....	216
Figure 65.	Configuration 2B Transformed Residuals Plot.....	217
Figure 66.	Configuration 3 Transformed Residuals Plot	217
Figure 67.	Configuration 3 Without Outlier Transformed Residuals Plot.....	217
Figure 68.	Baseline Configuration Performance	238
Figure 69.	Baseline Configurations: Normalized ACRS vs. Total Estimated Cost.....	255
Figure 70.	Baseline Configurations: Normalized Percent Clearance vs. Total Estimated Costs.....	255
Figure 71.	LCS Improvements: Normalized ACRS vs. Total Estimated Costs.....	258
Figure 72.	Sample Risk Cube (from Under Secretary of Defense (AT&L) SSE/ED, 2006, 11)	261
Figure 73.	Risk Summary for Legacy MIW System.....	264
Figure 74.	Risk Summary for Future MIW System	267
Figure 75.	Comparison of Normalized ACRS per O&S Cost for Baseline and Improved LCS Configurations.....	276
Figure 76.	Change in U.S. MCM Capability Over Time (after Melia 1991).....	295

Figure 77.	ExtendSim Run Menu.....	305
Figure 78.	ExtendSim Simulation Setup Table.....	306
Figure 79.	Structure of the Set Initial Conditions Block.....	307
Figure 80.	Structure of Create Targets Block.....	308
Figure 81.	Assign Attributes Block, Read Data Tab—Single or Repeated Runs	308
Figure 82.	Read Block, Options Tab—Single or Repeated Runs	309
Figure 83.	Assign Attributes Block, Read Data Tab—Multiple or DOE Runs	310
Figure 84.	Read Block, Options Tab—Multiple or DOE Runs	311

THIS PAGE INTENTIONALLY LEFT BLANK

LIST OF TABLES

Table 1.	The Importance of Intelligence to MCM	33
Table 2.	Stakeholder Identification and Analysis	50
Table 3.	Requirements	56
Table 4.	Legacy MCM Systems (after PEO LMW 2009)	89
Table 5.	Future MCM Systems (after PEO LMW 2009).....	93
Table 6.	Functional/Physical Traceability Matrix.....	95
Table 7.	Detailed Requirements (after PEO LMW 2008)	103
Table 8.	MOP to Requirement Mapping Matrix.....	108
Table 9.	LCS Incremental Capabilities (after GAO 2013)	118
Table 10.	Operational Scenario Configuration	119
Table 11.	Configurations 1A and 1B: MCM 1 with MH-53E (Serial Hunt)	120
Table 12.	Configurations 2A and 2B: MCM 1 with MH-53E (Parallel Hunt)	123
Table 13.	Configuration 3: LCS Increment 1	125
Table 14.	Comparison of Functionality: ExtendSim vs. MANA.....	132
Table 15.	Overview of the MCM Configurations Modeled.....	137
Table 16.	Input Parameters—Physical Units of Measure Naming Conventions	157
Table 17.	Blue Surface Force Data Table	158
Table 18.	Blue Airborne Force Data Table.....	161
Table 19.	Search Area Data Table	163
Table 20.	Red Force Data Table	163
Table 21.	Hunt Effectiveness Data Table	169
Table 22.	Target Outputs Data Table.....	173
Table 23.	Parameter Settings to Select Legacy MCM Configurations	175
Table 24.	Verification Test Summary.....	178
Table 25.	Input Model Parameters and DOE Factors—Initial Ranges.....	189
Table 26.	Input Model Parameters and DOE Factors—First Refinement	197
Table 27.	Simulation Outputs from the First DOE	199
Table 28.	Sensitivity Analysis of Outputs from the First DOE	201
Table 29.	Sensitivity Analysis for Outputs of the Second DOE.....	203
Table 30.	Simulation Outputs from the Second DOE.....	206
Table 31.	Sensitivity Analysis for Outputs of the Second DOE.....	208
Table 32.	ACRS Fit Summary Statistics.....	211
Table 33.	Factors Included in the ACRS Model Fit	219
Table 34.	Top Five Significant Model Factors	221
Table 35.	Percent Clearance Fit Summary Statistics	222
Table 36.	All Factors Included in Percent Clearance Fit Model.....	223
Table 37.	Five Most Influential Factors for Percent Clearance Fit.....	224
Table 38.	Model Results for Baseline Configurations.....	228
Table 39.	Input Parameters Effects on ACRS for Baseline Configuration 1A (MCM 1 and MH-53E Conducting MCM in Series).....	228
Table 40.	Input Parameters Effects on Percent Clearance for Baseline Configuration 1A (MCM 1 and MH-53E Conducting MCM in Series).....	229

Table 41.	Input Parameters Effects on ACRS for Baseline Configuration 1B (MCM1 and MH-53E Conducting MCM in Series).....	230
Table 42.	Input Parameters Effects on Percent Clearance for Baseline Configuration 1B (MCM 1 and MH-53E Conducting MCM in Series)	231
Table 43.	Input Parameters Effects on ACRS for Baseline Configuration 2A (MCM 1 and MH-53E Conducting MCM in Parallel)	232
Table 44.	Input Parameters Effects on Percent Clearance for Baseline Configuration 2A (MCM 1 and MH-53E Conducting MCM in Parallel)	233
Table 45.	Input Parameters Effects on ACRS for Baseline Configuration 2B (MCM 1 and MH-53E Conducting MCM in Parallel)	235
Table 46.	Input Parameters Effects on Percent Clearance for Baseline Configuration 2B (MCM 1 and MH-53E Conducting MCM in Parallel).....	236
Table 47.	Input Parameters Effects on ACRS for Baseline Configuration 3 (LCS and MH-60S Conducting MCM in Series).....	237
Table 48.	Inputs Parameters Effects on Percent Clearance for Baseline Configuration 3 (LCS and MH-60S Conducting MCM in Series)	237
Table 49.	Descriptions of Key LCS Input Parameters Affecting the MOEs of ACRS and Percent Clearance.....	240
Table 50.	Experiment Adjustments Made to the LCS Configuration 3 Model to Gauge Effects on the ACRS and Percent Clearance MOEs	241
Table 51.	Results of Experiments Conducted on LCS Model	242
Table 52.	O&S Cost Information for the MCM 1.....	248
Table 53.	O&S Cost Information for the LHD 1	248
Table 54.	O&S Cost Information for the LCS 1 (Freedom Class)	249
Table 55.	O&S Cost information for the LCS 2 (Independence Class).....	249
Table 56.	O&S Cost Information for the MH-53E (per flight hour)	250
Table 57.	O&S Cost Information for the MH-53E (based on annual hours).....	250
Table 58.	O&S Cost Information for MH-60S (per flight hour)	251
Table 59.	O&S Cost Information for MH-60S (based on annual hours).....	251
Table 60.	Neutralizer Costs.....	252
Table 61.	Estimated Configuration Costs	253
Table 62.	Estimated LCS Improvement Costs.....	257
Table 63.	Levels of Likelihood Criteria (from Under Secretary of Defense (AT&L) SSE/ED, 2006, 12).....	262
Table 64.	Levels and Types of Consequences (from Under Secretary of Defense (AT&L) SSE/ED, 2006, 13)	262
Table 65.	Summary MOE Comparison.....	272
Table 66.	Performance and O&S Cost Comparison for Baseline Configurations.....	274
Table 67.	Parameter Settings to Select Legacy MCM Configurations	311

LIST OF ACRONYMS AND ABBREVIATIONS

3-D	three-dimensional
A _o	operational availability
AAW	anti-air warfare
ABM	agent based model
ACRI	area coverage rate instantaneous
ACRS	area coverage rate sustained
ALMDS	airborne laser mine detection system
AMCM	airborne mine countermeasures
AMCU	Coastal Minesweeper (Underwater Locator)
AMNS	airborne mine neutralization system
AoA	analysis of alternatives
API	application programming interface
ASuW	anti-surface warfare
ASW	anti-submarine warfare
AT&L	acquisition, technology, and logistics
C4ISR	command, control, communications, computers, intelligence, surveillance, and reconnaissance
CA	cellular automation
CAIV	cost as an independent variable
CI	configuration item
CNO	Chief of Naval Operations
COMINEWARCOM	Commander Mine Warfare Command
COMINEWARFOR	Commander Mine Warfare Force
CONOPS	concept of operations
COOP	Craft of Opportunity Program
COTS	commercial off-the-shelf
CSV	comma separated value
CY	calendar year
DAG	Defense Acquisition Guidebook
DC	duty cycle

DOD	Department of Defense
DOE	design of experiments
DON	Department of the Navy
DTA	Defence Technology Agency
EFFBD	enhanced functional flow block diagram
EOD	explosive ordnance disposal
FFBD	functional flow block diagram
GAO	Government Accountability Office
GUI	graphical user interface
I&W	indications and warnings
IAW	in accordance with
IED	improvised explosive device
INCOSE	International Council on Systems Engineering
ISR	intelligence, surveillance, and reconnaissance
J/CFMCC	Joint/Combined Forces Maritime Component Commander
JP	Joint Publication
LCS	littoral combat ship
LMW	littoral and mine warfare
LPD	amphibious transport dock
LHD	landing helicopter dock
LPH	amphibious assault ship
M&S	modeling and simulation
MANA	map aware non-uniform automata
MBSE	model based systems engineering
MCM	mine countermeasures
MCM 1	Avenger class mine countermeasures ship
MCS	mine countermeasures command ship
MEDAL	Mine Warfare and Environmental Decision Aids Library
MHC	coastal minehunter
MILCO	mine-like contact

MILEC	mine-like echo
MIW	mine warfare
MLO	mine-like object
MMS	marine mammal systems
MNS	mine neutralization system
MOE	measure of effectiveness
MOP	measure of performance
MPF	maritime prepositioning force ships
MSB	minesweeping boat
MSC	coastal minesweeper
MSES	Master of Science in Engineering Systems
MSH	coastal minesweeper hunter
MSL	minesweeping launch
MSO	ocean minesweeper
MSSE	Master of Science in Systems Engineering
NATO	North Atlantic Treaty Organization
NM	nautical miles
NMAWC	Naval Mine and Anti-Submarine Warfare Command
NOAB	nearly orthogonal-and-balanced
NOLH	nearly orthogonal Latin hypercube
NPS	Naval Postgraduate School
NSWC	Naval Surface Warfare Center
NWP	naval warfare publication
O&S	operations and sustainment
OMCM	organic mine countermeasures
OPNAV	Office of the Chief of Naval Operations
OPSIT	operational situation
PBM	“Mariner” patrol-bomber
PC	Panama City
PEO	Program Executive Office
PINS	precise integrated navigation system

PMA	post mission analysis
R&D	research and development
RI&N	reacquisition, identification, and neutralization
RMMV	remote multi-mission vehicle
RMS	remote minehunting system
ROV	remotely operated vehicle
SDD	software design document
SE	systems engineering
SEED	Simulation Experiments and Efficient Designs
SLOC	sea line of communication
SMCM	surface mine countermeasures
SME	subject matter expert
SOH	Straits of Hormuz
SOS	system-of-systems
SUW	surface warfare
T&E	test and evaluation
TTP	tactic, technique, and procedure
U.S.	United States
UISS	Unmanned Influence Sweep System
UMCM	underwater mine countermeasures
USS	United States ship
UUV	unmanned underwater vehicle
UWIED	underwater improvised explosive device
V&V	verification and validation
VAMOSOC	Visibility and Management of Operating and Support Costs
VDS	variable depth sensor
VSW	very shallow water
VV&A	verification, validation, and accreditation
WWI	World War I
WWII	World War II
XML	extensible markup language

EXECUTIVE SUMMARY

Since the Second World War, the U.S. Navy has lost four times as many ships from sea mines than from all other forms of attack (Program Executive Office (PEO) Littoral and Mine Warfare (LMW) 2009, 8). This makes effective mine countermeasures (MCM) critical to the safety of personnel and equipment, as well as for the unimpeded ability to operate in any region in the world. MCM is extremely challenging and dangerous to the personnel conducting the mine clearance operations (PEO LMW 2009). Currently, the U.S. Navy uses specially designed ships, the Avenger class MCM ships (MCM 1), to hunt for and destroy mines within minefields (PEO LMW 2009). Presently, the Navy is moving towards a safer approach to conduct MCM using ships that can remotely control unmanned equipment to clear areas of mines (PEO LMW 2009) thereby keeping MCM ships and crew out of the minefield. This involves installing equipment on the new littoral combat ships (LCS) (PEO LMW 2009).

This study began with an extensive literature review to understand MCM systems and operations. The review was conducted concurrently with a stakeholder analysis to develop the study's problem statement, project scope, and project requirements. This was necessary to define and limit the problem space to one that was both needed and realizable within the capstone project constraints.

The primary research questions that guided the reviews of the literature and previous studies centered around the current and planned MCM capabilities, gaps in desired capabilities, systems and functions required or planned to provide a capability, the concept of operations (CONOPS) that is followed by each of the MCM platforms, and the evaluation metrics that the U.S. Navy uses to assess the effectiveness of the MCM capabilities.

MCM is a complicated endeavor due to the impacts of multiple elements: types and locations of mines, size and density of the minefield, sea and environmental conditions, and the mission requirements of clearance time and effectiveness allocations (Erickson et al. 2009; PEO LMW 2009; Truver 2012). The conduct of this comparative

analysis project was further complicated due to the requirement to complete it using only unclassified data, which prevented the study from using actual performance values for the MCM systems.

The stakeholders need quantitative data for evaluating the effectiveness of future MCM capabilities, the core of which is the LCS, as compared to the legacy MCM capabilities, the core of which is the Avenger class MCM ship (MCM 1) (DON 2010). In order to address the stakeholders' need, it was important to gain an understanding of functional and physical architectures that characterize both the legacy and future MCM capabilities. A functional and physical analysis of MCM capabilities provided the basis for developing the configurations modeled in this study. Four different configurations were examined for the legacy capability (LT Andrew Watts, personal communication, 10 July 2014) and one for the future capability (see Table 1).

Table 1. Operational Scenario Configuration

Configuration	Ship	Helicopter	Subsystems
1A	MCM 1	MH-53E	MCM 1: AN/SQQ-32, SLQ-48 MH-53E: AN/AQS-24 Hunt Method: Serial
1B	MCM 1	MH-53E	MCM 1: AN/SQQ-32, SeaFox MH-53E: AN/AQS-24 Hunt Method: Serial
2A	MCM 1	MH-53E	MCM 1: AN/SQQ-32, SLQ-48 MH-53E: AN/AQS-24, SeaFox Hunt Method: Parallel
2B	MCM 1	MH-53E	MCM 1: AN/SQQ-32, SeaFox MH-53E: AN/AQS-24, SeaFox Hunt Method: Parallel
3	LCS	MH-60S	LCS: RMS with AN/AQS-20 MH-60S: Archerfish Hunt Method: Serial

Of the four legacy configurations studied, two utilize the older AN/SLQ-48 mine neutralizer systems for 5th fleet and two utilize the newer SeaFox mine neutralizer system for 7th fleet (LT Andrew Watts, personal communication, 10 July 2014). The legacy con-

figurations consider MCM operations in two ways: one uses a serial search and neutralize approach and the other operates with a more parallel approach (LT Andrew Watts, personal communication, 10 July 2014). The future configuration consists of systems operating in a serial fashion.

Since each configuration results in a MCM mission being executed in a different manner, the comparative analysis was based on a common mission scenario profile: mine clearing a rectangular area (10 nautical miles (NM) by 10 NM) that would be within a deep water sea line of communication (SLOC) containing bottom mines. In collaboration with the MIW subject matter experts (SMEs) and the advisors, the MIW Team focused the study on comparing the effectiveness of the different MCM systems in completing a minehunting operation against bottom mines in deep water (200 feet) in a predefined rectangular area (Admiral Richard Williams III, personal communication, 16 May 2014). The evaluation was based on two measures of effectiveness (MOEs) to provide a comparison between the configurations in both the time to conduct the mission and the mission effectiveness. These were the area coverage rate sustained (ACRS), calculated for the entire clearance mission, and the percentage of mines cleared.

Models were developed to represent both legacy and future MCM performance in accordance with the relevant activities and components characterized by the functional and physical analysis. There were 65 input parameters included in each model, which allowed for sufficient flexibility in the comparative study analysis and for the evaluation of capability improvements. These parameters included characteristics of the various systems found in each of the four configurations, such as search and transit speeds of the platforms, the stream and recover times for the various systems, and the probabilities of the search, classify, reacquire, and neutralization systems and sensors. These parameters were used as the factors in the subsequent design of experiments (DOE). As discussed previously, the responses were the two MOEs: ACRS and percent clearance. The initial DOE was developed using wide ranges for each variable, based on recommendations from MIW SMEs (Brett Cordes, personal communication, 29 July 2014, 12 August 2014, 25 September 2014, and 2 October 2014). Actual performance data was classified, so in order to keep this report unclassified, wide variable ranges were used and then pared

down based upon what factors significantly impacted ACRS and percent clearance. The factors that were found not to be significant were then set to constant values during the development of a second DOE to allow more scrutiny of the results and the interactions between the significant factors. Additionally, some of the ranges were refined to smaller intervals based on the simulation results from the first DOE and consultation with the MIW SME (Brett Cordes, personal communication, 25 September 2014, and 2 October 2014).

A sensitivity analysis was run on the second DOE to determine which factors had the greatest impact on ACRS and percent clearance. Furthermore, all two-factor interactions were analyzed to see which ones were impactful on the MOEs. The factors found to be significant at $\alpha = 0.05$ (that is, having a p-value of less than or equal to 0.05) for ACRS include the speed of the surface search systems, the time to deploy and recover the reacquisition, identification, and neutralization (RI&N) equipment, the percentage of the minefield to be searched by the surface systems, and the airborne systems' probability of classifying a non-mine like contact (MILCO) as a non-MILCO. Table 2 provides the performance comparison between the configurations that resulted from the simulation analysis and Figure 1 displays the results graphically using the mean values for ACRS and percent clearance.

Table 2. Summary of MCM Performance Results for Each Baseline Configuration

	ACRS			Percent Clearance		
	Mean	95% Confidence Interval		Mean	95% Confidence Interval	
		Lower	Upper		Lower	Upper
Configuration 1A	4.32	4.25	4.39	0.33	0.32	0.34
Configuration 1B	4.28	4.21	4.35	0.31	0.30	0.32
Configuration 2A	5.35	5.25	5.45	0.33	0.32	0.34
Configuration 2B	5.30	5.20	5.40	0.31	0.30	0.32
Configuration 3	4.80	4.71	4.89	0.33	0.32	0.34

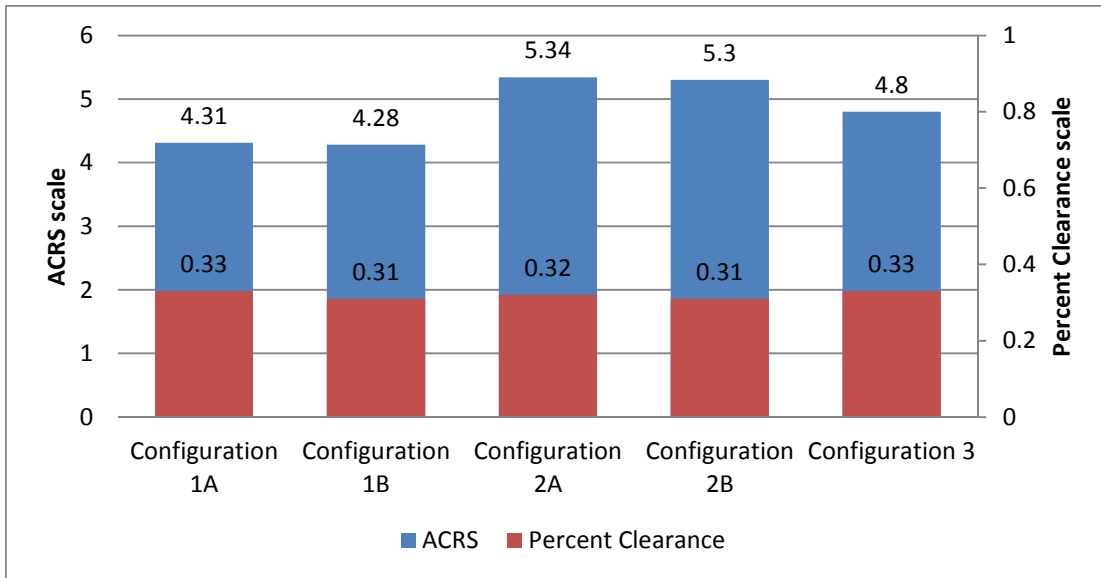

Figure 1. Baseline Configuration Performance

The mission costs for each configuration were also compared using point estimates for operations and sustainment (O&S) and neutralizer costs. A key result from the cost analysis was that the per-mission O&S costs for the future systems are lower than for the legacy systems.

Figures 2 and 3 contain the MOE performance and mission cost for each configuration studied (note that the configurations are described in the tables above; configuration 3 (LCS 1) is the United States Ship (USS) Freedom class ship and configuration 3 (LCS 2) is the USS Independence class ship—both have the same performance but each has a different O&S cost).

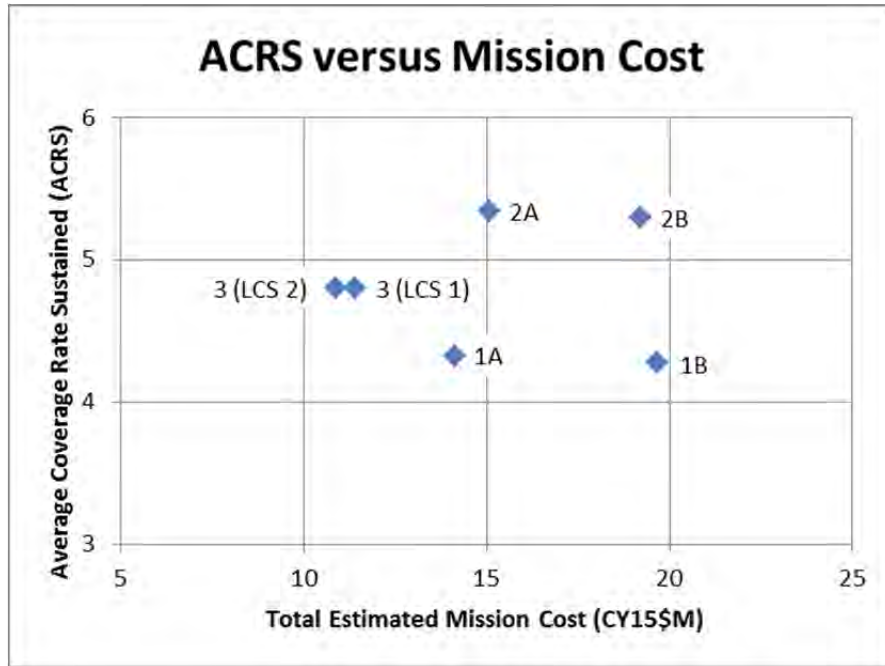

Figure 2. ACRS MOE vs. Mission Cost for Each Configuration

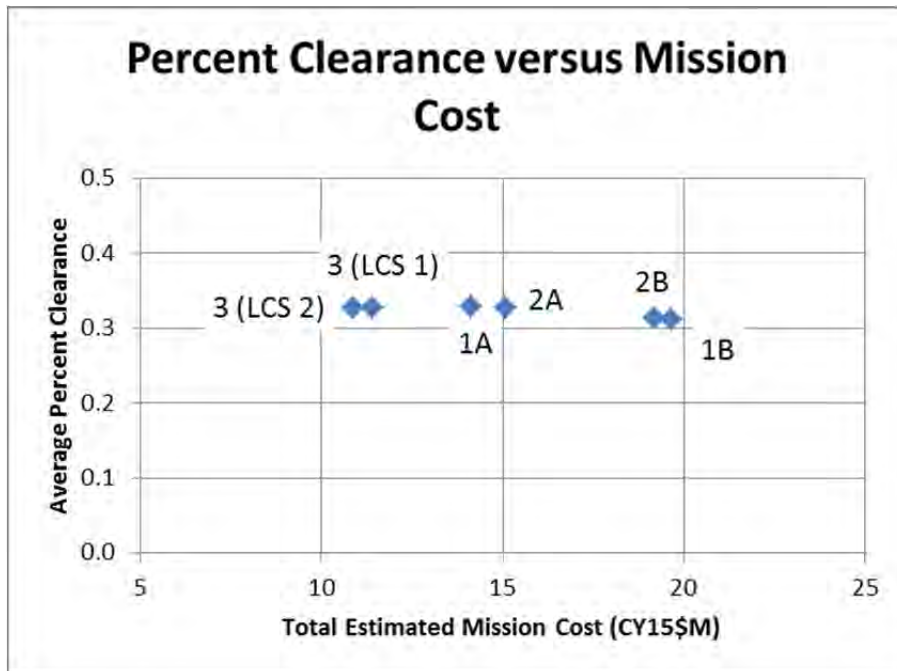

Figure 3. Percent Clearance MOE vs. Mission Cost for Each Configuration

Based on the analysis performed within this study, several recommendations were developed to improve the performance of the LCS in clearing an area within a SLOC of

bottom mines in deep water (greater than 200 feet) to match that of legacy MCM 1 systems evaluated by the MOEs. Three of the recommendations improve the ACRS and one recommendation is provided for improving the mine clearance effectiveness in terms of the percent of mines cleared. These recommendations are:

1. Operate the remote minehunting system (RMS) at its maximum search speed of 10 knots. This provides an increase in ACRS of approximately 27 percent over the current capability.
2. Decrease the time required to stream and recover the RMS to 15 minutes each. This provides an increase in ACRS of over 15 percent from the current capability.
3. Increase the RMS sortie time to 24 hours. This provides an increase in ACRS of over 15 percent over the current capability.
4. Enhance the sensors' performance to 0.95. This provides an increase in mine clearance effectiveness of over 58 percent.

These modifications and improvements would result in the LCS MCM performance capability exceeding that of the best performing legacy system configuration. As identified, recommendation one is not an improvement in capability, but rather a recommendation to operate the RMS at 10 knots instead of varying the speed from one to 10 knots. Therefore, it is very likely that additional incurred development costs would be minimal.

Figure 4 shows the normalized performance in ACRS per estimated O&S mission cost for the improvements listed above as compared to the baseline performance of the future (shown in dark blue) and legacy systems (shown in green). The values are normalized to the best performing configuration. As shown, the performance per cost of the baseline LCS exceeds all legacy configurations and the recommended improvement to the RMS search speed provides the best performance per cost ratio of all other configurations (note that due to project constraints, the cost analysis was based on point estimates and not probability distribution functions).

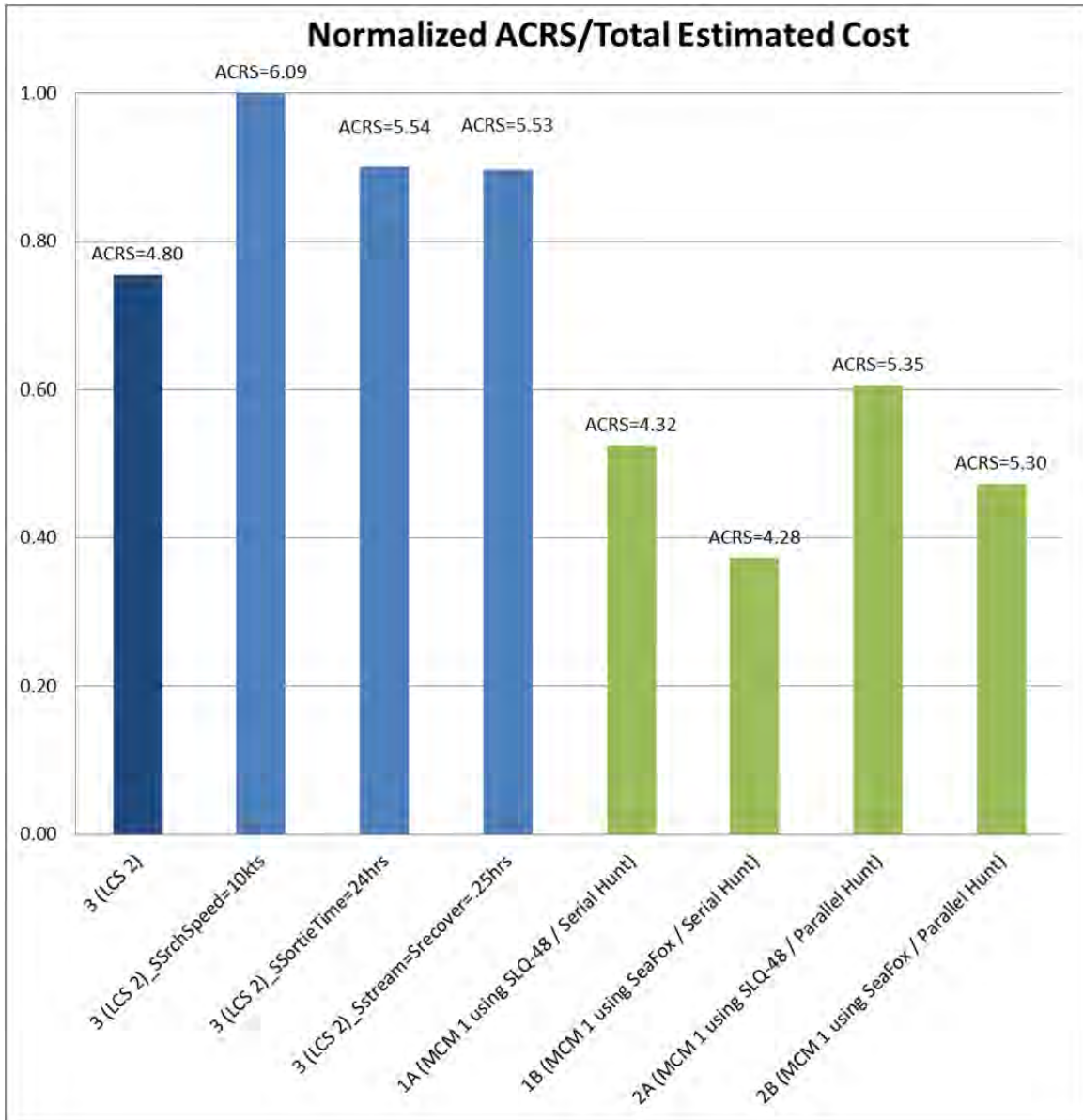

Figure 4. Normalized ACRS per Total Estimated O&S Cost for Baseline and Improved Configurations

Recommendations for future, follow-on studies in this area are proposed to allow for the analysis described within this report to be extended to provide more utility to the stakeholders. The future study recommendations involve expanding the operational scenario from the one used within this project and expanding the models to allow for additional analyses. Specifically, modifying the models to allow the simulation to run until a defined mine clearance level to determine the ACRS with respect to that clearance level

would provide data that more closely represents how missions are planned for different MCM mission scenarios. Additional modifications involving the incorporation of environmental and sea factors as well as accommodating surface mines would extend the analysis described within this report. Finally, using actual cost element distributions to develop the cost analysis for each configuration is recommended to account for uncertainty. These analyses could not be conducted within this project due to the constraints within which it was conducted.

REFERENCES

- Department of the Navy. 2010. *Navy Warfare Publication: Naval Mine Warfare* Vol. 1. NWP 3-15. Norfolk, VA: Navy Warfare Development Command.
- Erickson, Andrew S., Lyle J. Goldstein, and William S. Murray. 2009, June. "Chinese Mine Warfare: A PLA Navy 'Assassin's Mace' Capability." Naval War College, China Maritime Studies. http://www.usnwc.edu/Research---Gaming/China-Maritime-Studies-Institute/Publications/documents/CMS3_Mine-Warfare.aspx
- Program Executive Office Littoral and Mine Warfare. 2009. *21st Century U.S. Navy Mine Warfare—Ensuring Global Access and Commerce*. http://www.navy.mil/n85/miw_primer-june2009.pdf
- Truver, Scott C. 2012. "Taking Mines Seriously, Mine Warfare in China's Near Seas." *Naval War College Review* 65(2):30-66.

THIS PAGE INTENTIONALLY LEFT BLANK

ACKNOWLEDGMENTS

The mine warfare (MIW) Team would like to extend a special thanks to Admiral Richard Williams (Retired) and Mr. Brett Cordes for providing valuable stakeholder feedback and sponsorship to the SE311–132Open Cohort and Capstone Project. Additionally, the team would like to thank the Naval Postgraduate School (NPS), especially the Systems Engineering (SE) Department, for the opportunity to complete our Masters of Systems Engineering (MSSE) or Masters of Engineering Systems (MSES) degree. The team would also like to extend a special thanks to the SE Department Chair, Dr. Cliff Whitcomb, as well as to our capstone project advisors: Dr. Eugene Paulo, Professor Brigitte Kwinn, Professor Paul Beery, and Dr. Raymond Madachy, for being an integral part of the review process and for ensuring that the MIW Team stayed within scope and schedule for graduation. Finally, the MIW Team thanks our families, friends, and respective commands and employers who supported our efforts over the last two years.

THIS PAGE INTENTIONALLY LEFT BLANK

I. INTRODUCTION AND BACKGROUND

This report is intended to provide the results of the defensive mine countermeasures (MCM) capabilities study of the current, legacy system and the planned, future system. The legacy system is based on the Avenger class mine countermeasures ship (MCM 1) as each is configured to support 5th Fleet and 7th Fleet operations. The future system is based on the littoral combat ship (LCS) that will be incrementally updated in four stages to fully develop the MCM capabilities. According to LT Andrew Watts, the MCM Tactician MCMRON Five, the United States Ship (USS) *Independence* (LCS-2), is slated for 5th Fleet and the USS *Freedom* (LCS-1) class is to be deployed with 7th Fleet (personal communication, 10 July 2014). Additionally, as this study was conducted to satisfy the Naval Postgraduate School's (NPS) Masters of Systems Engineering (MSSE) and Masters of Engineering Systems (MSES) requirements, the processes followed in the completion of this study and the development of the included recommendations are detailed herein.

To conduct this study, a thorough review of the mine warfare (MIW) literature was conducted to gain an understanding of the complexity of MCM. A stakeholder analysis was performed concurrently to develop the stakeholders' needs so that the project could be scoped in a manner to best satisfy the needs within the constraints. A systems engineering (SE) approach was developed for the conduct of the study, which framed the processes of transforming the stakeholders' needs into requirements. These requirements were the foundation of the functional and physical architecture that was developed. Ultimately, the process concluded with this product that contains recommendations and analysis of the minehunting capabilities of the different platforms. As described within the report, the problem statement and project scope had to be refined several times to develop the appropriate plan to satisfy the stakeholders. A simulation was then built as a tool for the comparative analysis and a structured design of experiments (DOE) approach was developed and followed to produce results. Finally, a cost and risk analysis was performed and recommendations were developed.

Nine MSSE and MSES students collaborated on this project, which began in April 2014 and concluded in December 2014. Three NPS advisors and a primary consultant guided the team through the execution of the project. Due to the tight schedule and the small, disparately located team, the project had to be scoped so that a meaningful set of analyses could be completed. Recommendations for follow-on studies are included in Chapter X.

This section presents the summary of MIW and the associated challenges, the problem statement, project constraints, and analytical approach. The background information includes the historical use of sea mines, the types of mines, the challenges associated with different MCM operations, and the basic functions involved in MCM. Additionally, these descriptions draw from previous MCM studies and research, which enable a more comprehensive understanding of MCM operations and requirements. The summary included in this section highlights the complex nature of conducting defensive MCM operations as the processes employed and the effectiveness of the mission are affected by many variables. These variables include the state of the MCM technology and systems available, the mission parameters, the types and locations of the sea mines, the sea state and type of sea bottom, the level of intelligence of the minefield area, and the level of proficiency of the forces operating the MCM systems. The information derived from the literature review enabled the MIW Team to develop the problem definition and define the project scope, as well as the SE approach and analysis plan.

A. PROJECT BACKGROUND

The use of mines to impede an enemy naval attack is a warfare tactic employed concurrent with an adversary's ability to engage in a naval offensive. MIW includes defensive mine laying, offensive mine laying, and MCM. MCM include those activities involved with locating and destroying mines. According to the Program Executive Office (PEO) Littoral and MIW (LMW), mines are those “‘weapons that wait’ [and] are the quintessential global asymmetric threat, pitting our adversaries’ strengths against what they perceive as our naval and maritime weaknesses” (PEO LMW 2009, 1). Figure 1 underscores the importance of effective defensive MCM, as it illustrates that since the sec-

ond World War, more ships (by a factor of four) have been damaged or sunk by mines than by any other threat (PEO LMW 2009, 8).

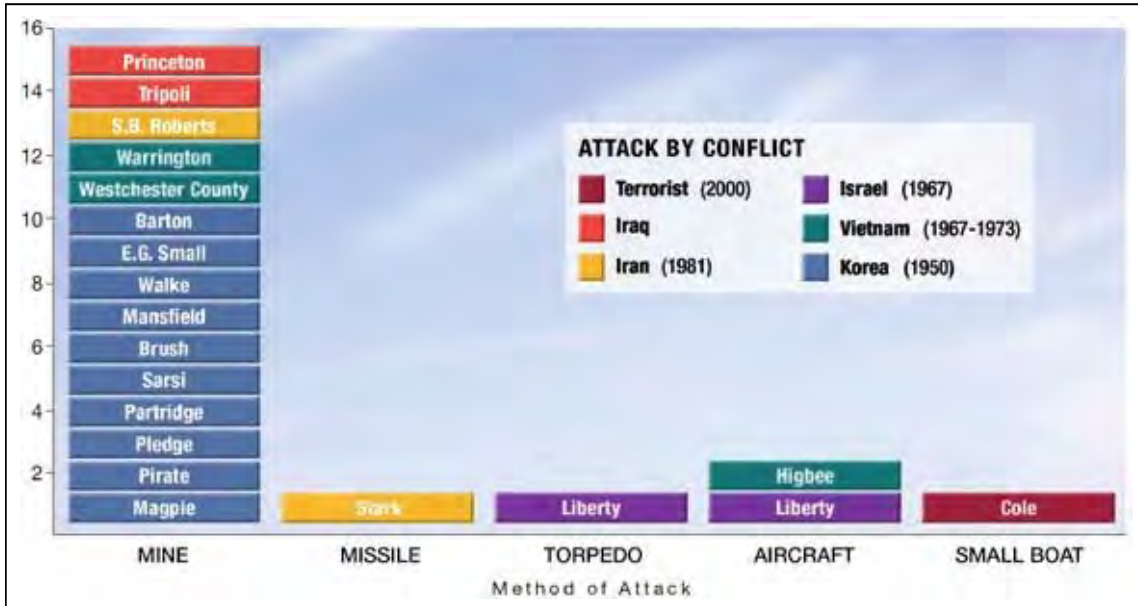

Figure 1. U.S. Navy Mine Casualties (from PEO LMW 2007, 8)

The MIW Team, comprised of NPS students in the MSSE and MSES program, were tasked to conduct a study to develop a comparison between the U.S. Navy’s current and planned MCM capabilities. The MIW Team had members located in California, Arizona, Maryland, and Rhode Island, which made communication and collaboration very challenging. The study had to be scoped so that the team could accomplish a meaningful analysis that would both satisfy the stakeholders’ needs and be accomplished within the NPS timeline. This study involved the evaluation of the current MCM capabilities, as they exist on the MCM 1 platforms, against those of the planned MCM capabilities, which are to be installed on the LCS as part of Increment 1.

B. PROBLEM

The Department of the Navy (DON) needs to have an effective defensive MCM capability that can be conducted in a manner that improves safety for sailors and the ships they operate (PEO LMW 2009). The DON stakeholders need quantitative data for evalu-

ating the effectiveness of future MCM capabilities, the core of which is the LCS, as compared with the legacy MCM capabilities, the core of which is the MCM 1 (DON 2010). Since each ship conducts the MCM mission differently, the MIW Team based the comparative analysis on a common mission scenario profile: clearing bottom mines from a rectangular area in deep water (greater than 200 feet) that would be within a sea line of communication (SLOC). This evaluation is primarily based on the area coverage rate sustained (ACRS) metric for each ship type over a 24-hour period as well as the mine clearance effectiveness in terms of percent of mines cleared (percent clearance). Although the LCS MCM capabilities are increased through four MCM mission module increments, the MCM comparison scenario chosen for this study dictated that only the first MCM module increment on the LCS be compared to MCM 1.

C. APPROACH

The MIW Team performed a comparative analysis the MCM systems of the two ship platforms with respect to one key operational mission scenario. This operational scenario focused on the ability of these ship systems to clear a relatively small rectangular area as if part of a mission to perform SLOC clearance in key choke points during times of conflict. An example of the need for this type of scenario is in the Straits of Hormuz (SOH), a key strategic waterway (U.S. Energy Information Association 2012), which ranges in water depths averaging “25 meters to 250 meters [82 to 820 feet]” (Robert S. Strauss Center 2008).

As there are many systems that perform the various functions that contribute to the overall mine clearing operations, this study focused primarily on the evaluation of one aspect of MCM operations. According to the stakeholders from Naval Surface Warfare Center (NSWC), Panama City (PC), in a meeting on 6 May 2014, the two areas of interest are the ACRS metric and residual risk of mines in the area after clearing operations. Due to the lack of accessible, unclassified performance metrics and the limited time in which to conduct this study, the MIW Team chose to focus this study on evaluating and comparing the ACRS and percent clearance metrics in the conduct of minehunting operations during an area-clearing scenario. This involved a comparative analysis of the ACRS

and mine clearance effectiveness between the MCM systems currently deployed on the MCM 1 with the planned MCM baseline of Increment 1 on the LCS. This comparative analysis considered both performance and cost metrics.

Through the performance of sensitivity analysis and simulation-based testing in accordance with (IAW) a DOE approach, the study identified key features that have the greatest impact on the ACRS of the MCM systems on the two primary platforms. Using the key features identified in the analysis, recommendations for optimizing the effectiveness of the MCM systems were developed. A secondary evaluation of mine clearance effectiveness (in terms of percent clearance) was also performed using a parametric approach to the performance capabilities of the systems found on each platform. Finally, some recommendations are provided.

This analysis study was conducted within certain constraints and with the assumptions as identified. The constraints and assumptions that guided this study are described in the following sections.

D. PROJECT CONSTRAINTS

A group of nine MSSE and MSES students from the NPS conducted this research and analysis effort over a nine-month period as part of the NPS Systems Engineering graduation requirements. This study was conducted within the following environment and under the following constraints:

- The study had to meet all graduation requirements by December 2014.
- The study had to be conducted and completed at the unclassified level.
- No specific software, tools, or funding was provided for this study.
- Due to the direction provided by the MIW Consultant, Admiral Richard Williams III, on 16 May 2014, only SLOC operations conducted in deep water (> 200 feet) were evaluated and included in this study.
- The sea mine characteristics used in the analysis were generalized; actual data on sea mines was not precisely modeled. The study used generalized types and characteristics of sea mines in the analysis.
- Only minehunting operations were studied; minesweeping functions between the various MCM platforms were found to be very different and were therefore excluded from this study.

To fully apply the problem statement above and to appropriately define the project scope, extensive research and stakeholder interaction and analysis had to be conducted. The next section describes the assumptions used to frame the study.

E. PROJECT ASSUMPTIONS

The MIW Team developed the following assumptions to scope and bound the project. The team used experience, research, and sponsor provided information to develop these assumptions. The list evolved throughout the project as information and facts were established. The final assumptions used are:

- Actual performance metrics were unavailable at the unclassified level and were not used within this study. The MIW Team developed notional performance parameter values and ranges based on research. These values were evaluated by some project sponsors and determined to be reasonable. Chapter VII contains the methodology and assumptions used to derive the notional parameter values used within this study.
- This study only focused on a simplified geometry for the area clearance operation; it did not use the complicated geometries as would be found in actual SLOC clearance operations. A fixed rectangular mine field area of 10 nautical miles (NM) by 10 NM was used for the analysis.
- Minesweeping and shallow mines were not included in the study due to the constraints listed in Section D.
- The study only evaluated time to clear and effectiveness in clearing bottom mines.

From the problem statement, the MIW Team developed the project scope, which is defined in the following section. This provided additional refinement and focus of the problem set studied.

F. PROJECT SCOPE

While it would be desirable to evaluate the operational effectiveness of the complete spectrum of defensive MCM operations in multiple scenarios and under a variety of conditions, this comprehensive study could not be accomplished given the constraints listed in Section D. After discussions with the MIW Consultant, SMEs, and advisors, it was determined that a focused study of the ACRS and percent clearance of the legacy and future MCM systems suites in a single operational scenario would result in a more satis-

factory outcome. Therefore, this project focused on the elements that contribute to the ACRS and mine clearance effectiveness metrics for each platform and associated MCM system suite as they pertain to the completion of a 10 NM by 10 NM area of a SLOC MCM mission in deep water of greater than 200 feet. Where actual performance parameter values were not available, the MIW Team used estimated values based on research and consultation with the MIW Consultant, MIW subject matter experts (SMEs), and stakeholders. These assumptions and estimates are documented and described in this report in Chapter VII.

As specified in the PEO LMW Instruction 3370.1A (PEO LMW 2008), the ACRS must be “qualified by the level of coverage attained within the area covered” (72). This level of coverage pertains to “the percent clearance level and the level of detection/classification” (72). As indicated in the PEO LMW Instruction (PEO LMW 2008), the ACRS of each platform is a result of several parameters as described below.

The calculation for ACRS as described in Equation A-47 of the PEO LMW Instruction 3370.1A (PEO LMW 2008, 72) is

$$ACRS_p = \frac{Area}{T_{Total}} \quad (1)$$

where,

$ACRS_p$ = the area coverage rate sustained to level p ,

$Area$ = the area covered, and

T_{total} = the total mission time.

As indicated in the PEO LMW Instruction 3370.1A (PEO LMW 2008), there is a clear distinction between the ACRS and the area coverage rate instantaneous (ACRI). The ACRI is the “area coverage per unit time” of a “single pass along one track” (72). This involves the following performance metrics:

- The speed of the system as it conducts search, sweep, cutting, actuation, and/or neutralization functions.
- The mine hunting or mine sweeping subsystems’ search, sweep, and/or actuation width.

- The mine hunting or mine sweeping subsystems’ search, cutting, and/or actuation probability.

The calculation as described in Equation A-48 of the PEO LMW Instruction 3370.1A (PEO LMW 2008, 72) is

$$ACRI = (A * B) * V \tag{2}$$

where,

ACRI = the area coverage rate instantaneous,

A = the characteristic search/sweep/actuation width,

B = the characteristic search/cutting/actuation probability, and

V = the system speed.

Although the area to be covered in a single pass per unit of time is incorporated indirectly into the ACRS calculation, the MIW Team did not have access to actual characteristic width, probability, or speed data for the MCM systems under evaluation, so these values were generalized and incorporated into the ACRS evaluation.

To determine the ACRS, the total time necessary to complete the mission is required. This total time includes the duty cycle (DC), which is defined in the 3370.1A Instruction (PEO LMW 2008) as the descriptor for the “operational constraints” involving operations, crew availability, and equipment availability (46–47). Therefore, the DC includes the launch-recovery time of the subsystems used to sweep, search, detect, classify, identify, and neutralize. The DC can be found through the following equation, which is identified as Equation A-17 (PEO LMW 2008, 47):

$$DC = \frac{T_{on}}{(T_{on} + T_{off})} \tag{3}$$

where,

DC = Duty Cycle,

T_{on} = platform on-duty time, and

T_{off} = platform off-duty time.

Other factors, including the speed of the platform and mission vehicles as well as the turn radius, rate of turning, and the amount of time required to return to the platform and/or staging area to be refueled, reconfigured, and repaired, contribute to the time required from mission initiation until mission completion. Usually, the level of residual risk that mines still exist in the area determines mission completion, as achieved by the mine clearing operation.

Non-MCM system elements will also affect the performance capabilities of the platform-based systems. These variables were not accounted for within the simulation or this study due primarily to the complexity these elements have on the MCM performance and operations and the limited time and resources available within which to conduct the study. For the purposes of this study, only deep water operations in a steady-sea-state environment and bottom mines were evaluated.

The project scope was further detailed in order to derive the appropriate problem definition and study focus. It was important to succinctly state these to enable effective communication with the stakeholders as to the goals of this analytical study project.

G. RESEARCH QUESTIONS

The following questions for research were used to scope and define the problem in order to provide a solution for the stakeholders. This section includes a top-level list of research questions, which was refined as the research was conducted and the MIW Team developed a better understanding of the problem space.

1. What are the critical capabilities required for successful MIW/MCM?

In order to identify and address the capability gap in MIW, there must be an understanding of the critical functions that need to be performed and the capabilities that must exist. Preliminary research indicated that detection, classification, identification, reacquisition, neutralization, and sweeping (including release and actuation) of mines, as well as communication, and transit to the area of operations are critical tasks in MIW operations.

The answers to this question, as uncovered by research and stakeholder input, were verified through the modeling efforts as they address the next two questions.

2. What are the gaps and limitations in meeting these capabilities with the current (legacy) force?

The current platform for the MCM mission is the MCM 1. In order to identify gaps in the MCM capability of the U.S. Navy, it was important to understand the capabilities of the Avenger. The Avenger's defensive MCM operational performance metrics and operating costs were required to provide a basis of comparison for the new LCS that is the core of the future capability.

Capabilities were considered in the context of measures of effectiveness (MOEs) and measures of performance (MOPs) in a particular operational scenario. Some example measures include search speed, detection and classification capabilities, neutralization effectiveness, operating costs, etc. A more comprehensive list of MOEs and MOPs are contained within Chapter IV. As discussed in the project constraints, due to the classification of much of the specific data about each ship's MCM system capabilities, this research question was primarily addressed by modeling, using reasonable ranges for the parameters (factors) that directly impact the MCM capability. Reasonable ranges were determined from research and input from SMEs.

Once the required set of system parameters and their values were defined, models were used to identify those most critical to performance of the MCM mission.

3. What capabilities and limitations does the projected future force have?

The future platform for the MIW and MCM mission is the LCS. In order to compare the capability of the legacy and future MCM systems, it was important to understand the capabilities of the LCS. Furthermore, as the MCM mission packages will be deployed in increments, the capabilities afforded the Navy with each delivery had to be examined. It was found that only the MCM capabilities to be delivered with Increment 1 would affect the study within the constraints and assumptions as described (see Section D and Section E). The MIW Team did obtain concurrence of this decision from the SMEs. The LCS' defensive MCM operational performance metrics and operating costs were required

to provide the basis of comparison against the Navy's current MCM ship, the MCM 1. As with the legacy MCM systems, performance capability data was unavailable for the future systems; therefore, reasonable ranges were developed and used. These were verified as reasonable by the SMEs.

4. What are the MIW operational situations (OPSITs) of primary interest and what data and information are available for use within this study?

To ensure applicability of the results of this study, it was necessary to identify the mission type and operational scenario that is of primary concern for the stakeholders and sponsors. The performance of the defined mission type, (e.g., minehunting or minesweeping, time to conduct operations) is affected by several variables that are outside of the control of the MCM commanders; these include: the environment, objective, mine type, and threats or enemy forces. To be informative, it was necessary to select a mission type and scenario that would be particularly stressful to MCM capabilities, under the assumption that this stress would make any capability gaps more apparent.

In addition to the mission type, the MCM operating scenarios in which to study MCM effectiveness had to be identified. From the MIW Team's research of the literature, mine trigger type, mine emplacement method(s), minefield density, water depth, naval objective, enemy objective, and geographic location greatly impact the method and efficacy of the MCM operation. To conduct the comparative analysis, it was determined that once these conditions were defined, each MCM configuration would use the same operational scenario and environmental and minefield conditions. The chosen MCM mission scenario and conditions were defined by the MIW Team, in collaboration with the SMEs, to select the most relevant context for the modeling and analysis.

In addition to the MIW and MCM research, it was essential to engage the stakeholders, including the sponsors, consultants, and advisors. These discussions helped to determine their primitive and effective needs so that these could be transformed into actionable requirements.

H. LITERATURE REVIEW

This section provides a comprehensive summary of the research performed, resulting in a detailed background of MCM history as well as an overall MIW history. Appendix A contains a detailed and comprehensive summary of the research conducted prior to the development of the problem statement and project scope.

1. History of Mine Countermeasures

Tamara Melia, a Navy Department historian, produced a history of naval MCM (1991) at the request of the Director of Naval History. The extensive bibliography contained in Melia's report is only part of her research efforts, which also included access to a considerable body of original source material. In this historical summary, Melia (1991) observes that the U.S. Navy has "not sustained an effective interest in mine countermeasures" (1). Typically, neglect of MCM during periods of peace has occurred, while mine technology has advanced. Then, with the next conflict there has been a hurried attempt to deal with specific threats followed by another period of peace and neglect. Lessons are continually relearned and this cycle has repeated several times. Melia's work covers the period from 1777 to 1991 and is used as the primary source to explore the way in which MCM has changed over the years within the broader field of MIW. Although an attempt was made to cast the net wider for sources of historical information, this proved to be problematical because many other studies use Melia (1991) as their primary source of historical information.

An example is Griner's (1997) study of naval MCM. Looking through the lens of expeditionary warfare (deployed forces), identifying this as the future posture of the service, Griner argues that the development of MCM, and the procedures to employ them, has been unfocused. In many cases, emphasis has been placed on technical solutions without the development of a coherent doctrine. The primary recommendation of Griner's paper is to reverse this situation through "the development of a coherent doctrine to focus the integration of forces and the development of technology" (49).

2. Summary of Lessons Learned from History

The research into the history of MCM and the current state of MCM capabilities highlights the need for the revolution in MCM operations. This revolution is driven by doctrinal changes that demand safer and more effective mine clearing operations. The lessons learned in Operation Desert Storm, in 1991, were the catalysts behind the defensive MCM doctrinal shifts. A review of the MCM history highlights the need for sustained focus on the area of MCM to protect the U.S. Navy as it performs its operations. Appendix A contains a summary of the MCM history from 1777 through 2014. As detailed in the summary, the U.S. has continually had to quickly learn the best ways to conduct MCM during conflicts, as it has not maintained a systematic approach to increasing or maintaining its MCM competencies. At times, the systems employed have not been as effective as other defensive systems, putting the U.S. Navy at risk and impeding its abilities to operate in regions containing sea mines.

Although Melia (1991) indicates that capabilities have generally increased during times of conflict and then decayed during time of peace, it seems that the U.S. capabilities reached a peak in the decade following the Korean War, both in terms of MCM systems and operational capability. Figure 77, in Appendix A, is a graphical representation of this evolving capability. The focus on riverine MCM during the Vietnam conflict and subsequent neglect of a surface MCM capability during the 1970s resulted in a significant decline in capability. Even though this trend was reversed, to some extent, with the introduction of the MCM 1 at the end of the 1980s—the first new mine countermeasures command ship (MCS) since the 1950s (Naval Mine Warfare Engineering Activity 1991)—that capability is now aging. The U.S. Navy needs a replacement system, currently envisioned as the LCS with the MCM Mission Package, before its MCM capability can improve.

I. TRANSITION TO REVOLUTION IN MIW

Just as all warfare has changed and evolved, the history of MIW has been very dynamic, and has required forward thinking strategies to maintain effective methods to counter this effective method of warfare.

As embodied in the Navy-Marine Corps post-Cold War operational concepts, ‘Forward...From the Sea’, and ‘Operational Maneuver From the Sea’, the primary objective of joint expeditionary operations is to provide unencumbered maneuver within all dimensions of the littoral battle space. This calls for a ‘(R)evolution in Mine Countermeasures’. Fortunately we are not starting from scratch, but we do need to elevate mine countermeasures (MCM) to a top priority by evolving, in a measured fashion, new dimensions and applications of technology to defeat the mine threat, improve the resources dedicated to this mission, and ensure that MCM warfare is integrated fully into the fleet. (Broughton and Burdon 1998, Para. 3)

Based on the research and discussions with the stakeholders, the lack of persistent, intense focus on MCM operations is insufficient for effective mine clearing that is required for safe transit. The new revolution that Broughton and Burdon (1998) reference requires new capabilities and a new way of thinking to ensure access to the vital littoral regions and safe SLOC transits that are the focus of U.S. naval power projection and sea basing operations in the future. The progression and development of the appropriate MCM capabilities that should ensure more reliable mine clearing of current sea mine technologies in a safer manner does appear to be slow, as this reference is 16 years old; however, the U.S. Navy appears to be moving in the right direction.

1. New Threats

Technological advances and the unrestricted proliferation of technologically advanced types of sea mines pose a significant threat to naval expeditionary forces, especially naval forces operating in the littorals. This is especially problematic as “the potential exists for non-state actors to acquire sea mines and subsequently employ mine warfare as a means,” of blocking, delaying or “crippling the Navy throughout the range of military operations.” (Bahr 2007, Abstract). Also according to Bahr (2007),

[n]aval mine countermeasures warfare is a small but crucial element of operational warfare that influences the balancing of naval objectives against the operational factors of space, time, and force. Additionally, it is one of the few critical warfare disciplines that can enable unimpeded movement, maneuver, and operational logistics in the maritime environment. However, given its current status as a warfare specialty, its capabilities, limitations, and training cycles, the Navy’s mine countermeasures

community may struggle to meet future warfare requirements as well as the challenges presented by an increasing asymmetric threat. (1)

The advances and proliferation of mine technology, combined with the impacts on U.S. Navy operations, make the development and enhancement of MCM competencies an essential part of U.S. Navy capabilities.

2. Mine Warfare: a Neglected Mission

The modern sea mine threat is sophisticated and deserves the diligent efforts of the DON to protect U.S. forces and commercial shipping. State actors, like China have an estimated “80,000 sea mines” (Rabirot 2011) that can be used to block approaches to its vital shorelines. It is also reported that North Korea is developing “nuclear sea mines,” (Rabirot 2011) which are intended to counter the U.S. naval superiority in the Pacific Region. Despite the fact that MIW has been the single most effective weapon enemies have used against U.S. Naval forces since World War II (WWII), MIW has become one the most misunderstood and neglected naval warfare missions. Based on the Department of Defense (DOD) funding obligations in 2007, Bahr (2007) states, “one might assume that naval mine warfare, particularly mine countermeasures, has ceased to exist as a core competency, concluding that international partners surely must bear the burden in accomplishing the mine countermeasures (MCM) mission.” (1). Bahr (2007) bases this claim after,

[a] cursory glance at currently funded projects within the Department of Defense suggests that the only initiative of any importance related to naval mine warfare is the Littoral Combat Ship (LCS) and even this program may be in jeopardy due to contract issues. (1)

Bahr (2007) goes further in describing the importance of MCM and the apparent neglect of MCM capabilities. Based on research conducted in 2007,

[t]hough it will likely never garner the attention of tactical aviation or *Aegis* cruisers, U.S. Navy MCM can and likely will play a significant role in future naval operations and it is a specific capability that the Joint/Combined Forces Maritime Component Commander (J/CFMCC) should expect at his disposal. Paradoxically, many operational commanders have little understanding of the complexities, limitations and importance of fully integrating MCM into current operational plans and ex-

ercises; instead treating it as an operational ‘afterthought’ or simply assuming it will be there when needed with little regard for its potential operational impact. Generally seen as an inconvenience or, in many cases ignored altogether during fleet exercises and routine deployments, Navy mine countermeasures may soon find itself unable to fulfill its operational roles pertaining to ‘full dimension naval power – from the stern gate, over water, across the beach, and to the objectives ashore.’ (Bahr 2007, 2)

Bahr (2007) also evaluates the doctrinal publications published by the U.S. Navy,

Joint Publication (JP) 3-15 and the current mine warfare doctrine in Naval Warfare Publication (NWP) 3-15 thoroughly describe naval mine warfare, but only in a very systematic and traditional sense. Both documents fail to address developing asymmetric threats and the operational considerations associated with them. (3)

Although both of these instructions were updated in 2010 and 2011 (DON 2010; U.S. Joint Chiefs of Staff 2011), many of Bahr’s criticisms of the doctrines were not addressed in these updates. This failure to emphasize MCM operations may be overcome with the planned introduction of the LCS MCM-capable platforms to the fleet.

As of 2014 a fleet of as few as 24 LCS ships is planned for acquisition (Secretary of Defense 2014; O’Rourke 2014). Despite being dependent on allied partnerships for MCM support, the United States (U.S.) does invest very heavily in a MCM capability.

3. Technology and the Current Threat

The current MIW trend that U.S. naval forces face is the intense proliferation of technologically advanced sea mines that are very affordable and available to state and non-state actors. The new sea mine systems are designed to make MCM more challenging.

Advanced counter-countermeasures mechanisms such as ship counting, inter-look/inter-count dormant periods and new mine-case geometries exacerbate an already difficult mission. Technical advancement in countermeasures systems inherently exceeds that of the mines themselves. Mines employ many of the same basic principles with which they were developed over 200 years ago and it is their relative simplicity, in lieu of technological advances, that keeps production costs low and makes them a viable weapon for use by small nations with limited budgets. Affordability and availability make sea mines particularly appealing to rogue states and terrorists looking to disrupt stability in key parts of the world. They are

an economical force multiplier in the denial of sea control. Of particular concern to operational and theater commanders is technology proliferation from friendly and 'other' nations to unfriendly actors. While some countries (for example, China, Russia and Italy) sell high-tech mines on the open market, there is limited information to indicate the extent of the extent that advanced designs have been bootlegged and put into production indigenously by countries with less-than-desirable intentions. Proliferation can have as profound an effect on operational warfare and planning as it does on regional security cooperation and stability. (Bahr 2007)

Current sea mines threaten naval expeditionary forces, and specifically the forces that would disembark from these expeditionary task forces and project power ashore. The very shallow water (VSW) area of less than 40 feet deep and surf zones are particularly dangerous places, due to the new, advanced mine systems that are currently being employed specifically for these areas.

4. The Asymmetric Threat

Asymmetric warfare in its simplest terms means not to fight fair. Given the availability, affordability, and ease of deployment of sea mines, there is a fear that state and non-state actors in the littoral regions of the United States could use these systems.

This concern is specifically illustrated in the *National Strategy for Maritime Security*, which recognizes that "mines are...an effective weapon because they are low cost, readily available, easily deployed, difficult to counter, and require minimal training" (Alperen 2011, 200). Though the U.S. Coast Guard bears most of the burden for port protection, there is little doubt that close coordination between the Navy and Coast Guard is required to meet the challenges in this unique environment. With the bulk of U.S. and international trade occurring via maritime shipping, any disruption within the industry from terrorist attacks could have severe economic fallout. Fortunately, the Department of Homeland Security has at least identified the potential mine threat to commercial vessels, which is the beginning of an effort to counter terrorist-planted sea mines near U.S. ports. Seaports are not the only areas vulnerable to terrorist attack from a foreign mine threat. International straits and strategic chokepoints also pose a hazard to navigation should they be mined to accomplish terrorist or wartime objectives. Nations at war with the United States are not likely to follow the guidelines of the 1907 Hague Conference and

the United Nations Convention of the Law of the Sea regarding the use of sea mines, and the only warning of presence might simply be a detonation. This assumes a defensive or “traditional” approach to laying a minefield, but what about the use of asymmetric methods? With remote detonation capability and an indefinite dormant time, unfriendly actors including terrorists might easily discriminate and attack U.S. or international vessels when the best opportunity presents itself (Bahr 2007, 8–9).

The threat from MIW is exacerbated as terrorists and non-state actors routinely strike targets of opportunity. For example, non-state actors, or terrorist organizations might use sea mines as terrorist weapons, much like terrorist and insurgent militant groups did with improvised explosive devices (IEDs) in Iraq and Afghanistan against our forces. Sea mines can easily be deployed off any boat, ship, or low flying aircraft into sea-lanes or harbors, which makes persistent intelligence, surveillance and reconnaissance (ISR) the first line of defense for the U.S. Persistent ISR must then be backed up with a dedicated ability to counter such threats, in the form of MCM.

J. DEVELOPING NEW CAPABILITY AGAINST A NEW THREAT

Just as the revolution in naval airpower during WWII made the battleships obsolete, new capabilities and requirements drive the operational need to execute MIW more efficiently and safely for the ships’ crew, and new technologies are driving new capabilities for MIW. It is no longer considered advantageous or necessary to require personnel to venture into mine fields with wood and fiberglass ships in order to hunt and neutralize mines. The need to find and neutralize mines without jeopardizing the ship and crew has developed new MCM requirements, and these new requirements have been transformed into new capabilities.

Operational factors of space, time, and force are closely tied to the operational objective but within each, there is little flexibility with the current capability.

MCM exists on a linear scale with dedicated MCM on one end and [organic MCM] OMCM on the other, and this scale will only get wider as dedicated assets age and/or retire and OMCM assets are fielded with fewer and fewer capabilities. The Navy must quickly reconcile this issue with technology *as well as* changes in doctrinal-employment. For traditional

operations, the previous construct, even with its associated limitations, may still provide enough options to get the job done. But what about the ability to counter the already-recognized terrorist mine threat? No matter the forces, whether dedicated, organic, future, legacy or other, the ability to determine if a port entrance or chokepoint has been mined is extremely limited. Short of continuous exploratory MCM at every chokepoint and every harbor entrance around the world, defensive MCM is severely handicapped. Preemption through aggressive intelligence, reconnaissance and surveillance (ISR) to stop the laying of mines may be the only real solution. The focus on new devices must not surpass the importance of doctrine and the use of offensive mine countermeasures. (Bahr 2007, 11–12)

The threat of sea mines to U.S. interests is enormous, and is increasing in comparison to investments in force capabilities to counter the threat.

Fortunately, there are several prominent initiatives that might bring MCM out of its malaise and provide for not only new technological advancements but also updated doctrine. These include development of the Littoral Combat Ship (LCS), MCM participation in joint and interagency exercises, and the merger of Mine Warfare Command with Fleet Anti-Submarine Warfare Command to form Naval Mine and Anti-Submarine Warfare Command (NMAWC). (Bahr 2007, 13)

The LCS is a multi-mission platform, which is optimized for littoral operations. The LCS is fast; it can transit at over 40 knots, has a shallow draft of only 15 feet, and has the capability to upload different modular mission packages based on the particular mission. The three mission packages are anti-submarine warfare (ASW), surface warfare (SUW), and MCM (Ailes 2011). The LCS with applicable MCM mission package is projected to take over the MCM role from the current MCM 1 by FY25 (Amador 2011).

The Littoral Combat Ship concept is the next step in fulfilling the organic mine countermeasures vision and is to be part of the eventual replacement for dedicated airborne and surface assets. The inherent flexibility of the platform opens new possibilities and helps to mitigate long lead times and decreased capability of dedicated and organic forces respectively. The concept blends many of the features of a dedicated MCM capability into an organic component of the fleet. As a multi-mission platform that requires interchangeable force packages however, its technological advantages may ultimately be overshadowed by slow ‘real-time’ flexibility at sea when converting from one package to the next (e.g., ASW to MCM). This limitation could be overcome by designating specific ships in the class to perform a particular mission on routine deployments with a

strike group, but that would require several ships on each coast and a pre-determined deployment cycle. (Bahr 2007, 13–14)

The U.S. Navy has historically been focused on other warfare capabilities, such as ASW, anti-surface warfare (AsuW), and anti-air warfare (AAW); MCM is not normally a focal point unless there is a problem with sea mines, and at that point it then becomes a priority.

With the offensive combat power of the carrier battle group established firmly as the bedrock of current naval warfare doctrine, it is unlikely that the less glamorous role of naval mine countermeasures can compete for funding and resources in a climate of constrained defense spending. The threat of mines to U.S. military and commercial interests, however, is not going away. Amid the increasing risk of terrorist-planted sea mines and the potential for conflicts in worldwide trouble spots, the mine countermeasures community may struggle to meet future warfare requirements. Unless a fundamental shift in the perception of mine warfare occurs at the operational level of war, it is unlikely that the Navy and Marine Corps will be able to successfully execute littoral warfare against a competent enemy. As much as mine warfare, particularly mine countermeasures, has been neglected in the past, the loss of operational maneuver in the littorals is something the military cannot ignore. (Bahr 2007, 17–18)

Littoral regions are the zones that the U.S. Navy must use, and be able to control in the future, in order to project naval power inland when necessary to achieve national strategic goals. The need for a countermine warfare strategy and a countermine warfare capability is clear.

The primary difference between the current and new concepts in conducting MIW operations, especially MCM operations is the location of the countermine combatant during these operations. Countermine ships have historically been made out of wood, with the most recent variant, the:

Avenger class ships are designed as mine sweepers/hunter-killers capable of finding, classifying and destroying moored and bottom mines. The last three MCM ships were purchased in 1990, bringing the total to 14 fully deployable, oceangoing Avenger class ships. These ships use sonar and video systems, cable cutters, and a mine detonating device that can be released and detonated by remote control. They are also capable of conventional sweeping measures. The ships are of fiberglass sheathed, wooden

hull construction. (Naval Sea Systems Command Office of Corporate Communication n.d.)

In contrast to conducting countermine operations inside a mine field, the new concept of conducting these operations, as designed into the new line of LCS type naval warships, involves the ships staying outside of the minefield and conducting countermine operations by use of a MH-60s and the Remote Minehunting System (RMS), which is composed of the Remote Multi-Mission Vehicle (RMMV), and the variable depth sensor (VDS), the AN/AQS-20A sonar (PEO LCS Public Affairs 2013). Details about how the LCS conducts MCM operations are discussed in Chapter IV, which covers physical architectures.

K. MINE TYPES

In 2008, it was estimated that countries other than the U.S. have more than a quarter-million sea mines in their inventories, comprised of over 300 different types of mines. This estimate includes only proper sea mines, and does not include underwater improvised explosive devices (UWIEDs) (Truver 2008). These mines vary greatly in technical complexity: ranging from contact mines designed before World War I (WWI) to rocket-propelled mines with advanced target-detection systems (Truver 2012). Mines have taken a wide variety of forms throughout the history of MIW, but most mines share some common traits. Sea mines consist of a housing, sensors, detonation mechanisms, and explosive payloads. Mines are most often classified by their activation method, although they may also be classified by their position in the water or their delivery method (Melia 1991). Figure 2, taken from Amador (2011), illustrates many of the mines and their likely locations; these are discussed in detail following the illustration.

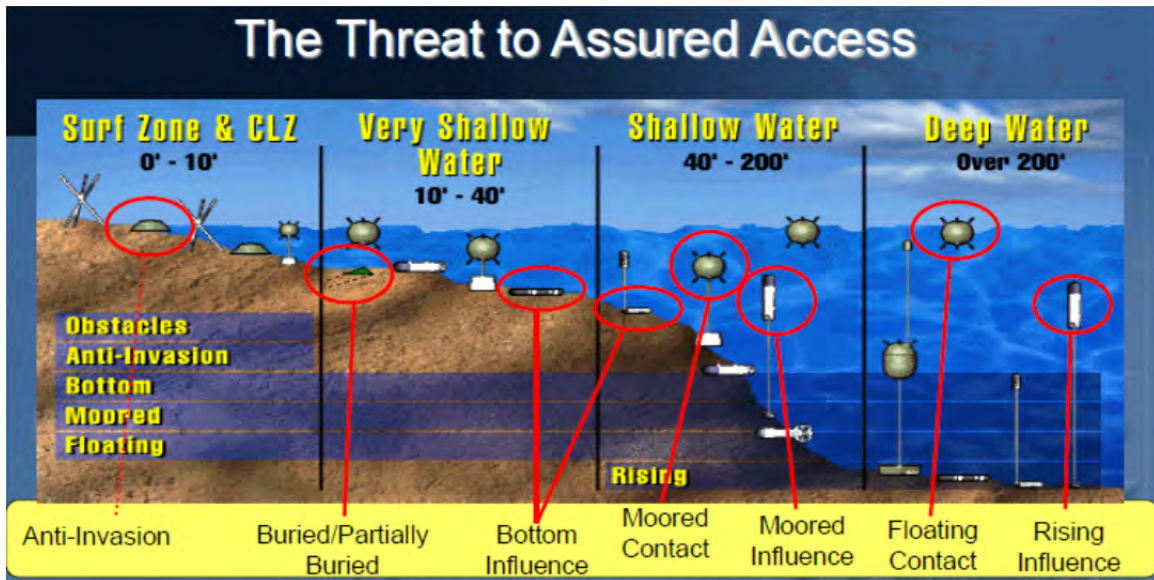

Figure 2. Types and Locations of Mines (from Amador 2011)

The four primary categories for classifying mines by their position in the water are bottom mines, moored mines, drifting mines, and limpet mines. Bottom mines lie on the sea floor; hence, they are often difficult to detect. Depth, sea floor clutter, amount of burial, and sediment type all affect bottom mine detectability. Bottom mines can be used in shallow water to target surface ships, or in deeper water to target submarines. Moored mines float below the surface of the water, and are tethered to an anchor to maintain their location. Moored mines are often limited to depths of less than 650 feet (200 meters) due to the lengths of the mooring cables (Erickson, Goldstein, and Murray 2009). Drifting mines float on or near the sea surface, and are carried freely by the sea currents. These mines are prohibited by international law, but they are still used (Erickson, Goldstein, and Murray 2009). Limpet mines are attached directly to a ship's hull, generally by divers, and detonated by a delayed timer (Truver 2012). The primary methods for mine delivery are aircraft, surface ship, and submarine (Truver 2012).

The two primary methods of mine activation are contact and influence sensing. The earliest sea mines were contact mines, which require physical contact with a target to actuate the detonation. Jarring physical contact may initiate a chemical trigger within the mine to initiate detonation, or an electric switch within the mine may initiate detonation (Truver 2012). Antenna mines are a type of contact mine with a copper wire floating up-

ward from the mine housing that detonates upon contact with a ship's steel hull (Melia 1991). Contact mines are often moored below the sea surface. After initial detection, contact mines are often cut from their moorings for easier neutralization (Melia 1991). Contact mines are still used due to their low cost and relative effectiveness. In 1988, the USS *Samuel B. Roberts* (FFG-58), a guided-missile frigate, was almost sunk by a \$1,500 contact mine. The WWI era mine caused damage that resulted in \$96 million in repairs (Truver 2008).

Influence mines use sensors to detect a target's magnetic, acoustic, seismic, or pressure signature (Erickson, Goldstein, and Murray 2009). When a ship moves through the water it has emissive characteristics that can be detected using these sensors. As technology has advanced, the sensors used in influence mines have been able to identify a target's signatures with greater accuracy. The sensors allow for discrimination between targets. Moreover, mines may employ ship-counters or delay timers to confound MCM operations (Erickson, Goldstein, and Murray 2009). Ship-counters delay detonation until a set number of ships have been detected, while delay timers delay detonation until a set amount of time has passed after initial detection. These mines cost much more, but are able to distinguish real ship targets, making them more difficult to counter. MCM platforms have to simulate a combination of ship signatures to neutralize modern influence mines effectively (Truver 2012). In addition to influence mines, which are moored or bottom lying, they are also used on torpedoes and rockets and known as rising mines. The Russian PMK-2 is an example of a rising mine; it is an acoustic influence mine attached to a torpedo payload. These mines typically target submarines, can be laid at a depth of 6,500 feet (2,000 meters), and fire their payload upward after a target has been detected (Erickson, Goldstein, and Murray 2009). These "smart" mines may also use sonar to locate and target ships (Melia 1991).

Several types of mines have been developed to counter minehunting and minesweeping operations. Stealth mines are designed to blend in with the underwater environment. Command controlled mines are detonated by remote control and are not vulnerable to influence minesweeping (Melia, 1991). Figure 3 was developed after the infor-

mation contained within Melia (2009) illustrating the significant advances in mine technology since the first mines in the eighteenth century.

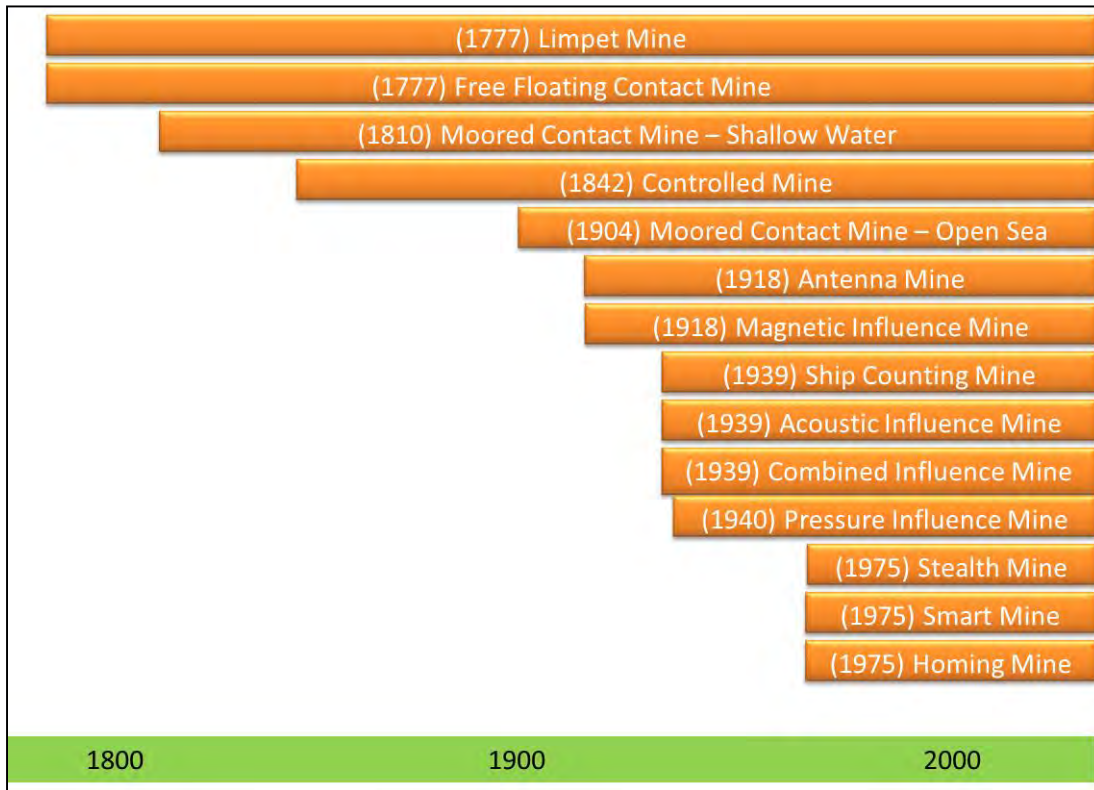

Figure 3. Advances in Mine Technology Since the 18th Century (after Melia 1991)

L. MCM CONCEPTS, CAPABILITIES, AND COMPETENCIES

MCM concepts are best described in the context of the broader MIW discipline. MIW encompasses both laying mines to deter an enemy's warfare capability as well as countering enemy laid mines to allow friendly forces to operate freely. It is the countering of enemy mines to reduce the mines' inherent danger and the potential damage they could cause that embodies the concepts of MCM. MCM competences include designing, producing, and deploying equipment used for both offensive and defensive purposes. The effectiveness of MCM capabilities is dependent on situational intelligence and mission planning as indicated in NWP 3-15 (DON 2010).

Offensive MCM involves addressing an enemy’s ability to pose a threat with mines. Offensive MCM activities include destroying an enemy’s mine production capability, nullifying an enemy’s mine laying ability, and targeting an enemy’s mine storage facilities. Offensive MCM attempts to reduce the risk of mine exposure to friendly forces by effectively minimizing the enemy’s ability to deploy mines (DON 2010).

Defensive MCM can be passive or active. Passive defensive MCM involves detecting enemy minefields and avoiding them so as to preclude interaction between enemy mines and friendly forces. The aim of passive defensive MCM is to reduce the chances of individual ships triggering a mine and to reduce the vulnerability of ships should a mine be triggered. When passive defensive MCM does not sufficiently reduce the risk of enemy mine interaction or when the minefield area cannot be avoided, active defensive MCM becomes necessary. Like passive defensive MCM, the aim of active defensive MCM is to reduce the risk of a mine damaging a friendly ship. Active defensive MCM, however, involves not only detecting the mines, but also neutralizing them to make safe a particular area. Active defensive MCM resulting in the neutralization of enemy mines is achieved through minehunting and minesweeping (DON 2010). Figure 4 shows a MCM concept hierarchy.

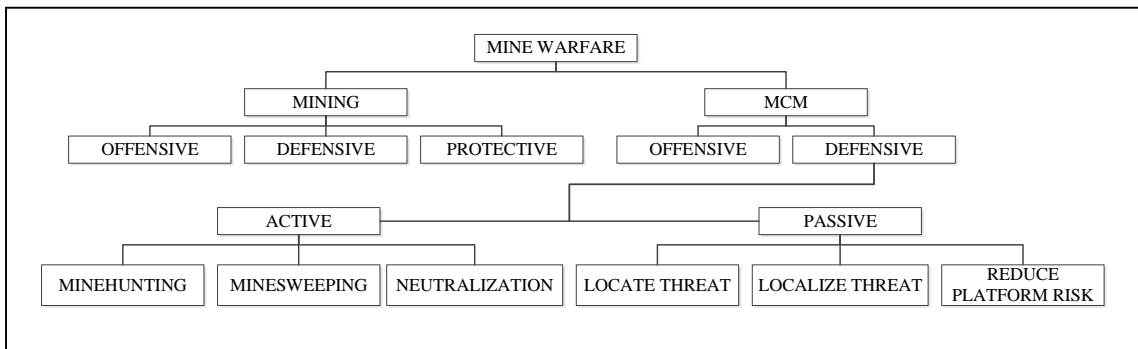

Figure 4. MIW Subdivisions and MCM Categories (from DON 2010)

Mine hunting involves the use of sensors to detect, classify, identify, and possibly reacquire enemy mines leading to mine neutralization. Minesweeping involves the use of systems that either trigger mines to detonate or sever the cables that attach mines to the

sea floor so that the mines can be neutralized on the surface (DON 2010). Mechanical sweeping involves either cutting the tether of moored mines or damaging a mine to render the mine safe for neutralization or analysis. Influence sweeping involves simulating the acoustic, magnetic, electric, seismic, and/or pressure signature of a ship so that a mine detonates (PEO LMW 2009).

There are several systems that provide MCM capabilities. This section will describe the basic capabilities of the MCM systems in general terms; they are described in detail in Chapter IV. The U.S. Navy performs MCM operations using airborne MCM (AMCM), surface MCM (SMCM), and underwater MCM (UMCM) assets (DON 2010). This MCM “triad” is often employed simultaneously to provide a complementary capability for detecting and neutralizing enemy mines (PEO LMW 2009).

AMCM capabilities are provided by helicopters and their subsystems. The legacy AMCM capability consists of 28 MH-53E helicopters that can be deployed anywhere in the world within 72 hours (PEO LMW 2009). The next generation AMCM capability is provided by MH-60S helicopters that are able to embark on LCS ships for rapid MCM response (DON 2010). Both helicopters are configurable to support hunting, sweeping, and neutralization missions by carrying systems that provide detection, localization, and neutralization capabilities. Specifically, the helicopters can carry sonar, laser, mine-sweeping, and mine neutralization systems (MNS) depending on the mission (PEO LMW 2009).

Two surface ships and their subsystems primarily provide SMCM capabilities. The legacy SMCM capability consists of MCM 1 ships. The U.S. Navy currently deploys 13 MCM 1 vessels after the USS *Guardian* (MCM-5) ran aground in the Philippines in 2013 (Craggs 2013). The MCM 1 ships are capable of performing minehunting and minesweeping missions using several different systems including towed sweep systems, towed sonar, and remote MNSs (PEO LMW 2009). The next generation SMCM capability will be provided by the LCS ships. As of 2013, the U.S. Navy plans to award contracts to procure 24 LCS ships and 24 MCM mission modules to provide MCM capabilities (U.S. Government Accountability Office (GAO) 2013). Like the MCM 1 ships, the LCS ships are projected to provide minehunting and minesweeping capabilities using

several different systems. The LCS will not have an onboard towed sweep capability but instead will have a towed magnetic and acoustic influence sweep capability provided by the Unmanned Influence Sweep System (UISS), a remote unmanned surface vehicle. The LCS is also projected to have remote unmanned underwater vehicles to provide sensing functionality from inherent or towed sonar. Moreover, the LCS will provide additional minehunting and minesweeping capabilities from an embarked MH-60S helicopter (DON 2010).

UMCM capabilities are provided by explosive ordnance disposal (EOD) detachments and Marine Mammal Systems (MMS). EOD detachments consist of personnel and systems that specialize in locating, identifying, neutralizing, recovering, exploiting, and disposing of enemy mines, torpedoes, and UWIEDs using non-magnetic and acoustically silent diving gear, handheld sonars, and specialized recovery or neutralization equipment (PEO LMW 2009). The MMS capability consists of trained dolphins and sea lions that are able to detect and neutralize mines. MMSs are also able to perform recovery operations and detect buried mines (PEO LMW 2009).

M. MCM OPERATIONAL FUNCTIONS OVERVIEW

MCM operations are determined by MCM missions, which in turn are described by MCM functions that are characterized by specific MOPs. MCM functions and MOPs are described in detail in Chapter IV and Chapter V, respectively, but are described at the top-level, as they pertain to the actual MCM operation, in this section to allow for a complete understanding of MCM operations before the specific description of the study are introduced. In PEO LMW Instruction 3370.1A (PEO LMW 2008), defensive active MCM MOPs are divided into four functional areas: sense, engage, control, and logistics.

The sense function involves those sub-functions used in the non-neutralization aspect of mine hunting. Sub-functions include detection, classification, reacquisition, and identification of mines. These functions, as they apply to acquiring contacts and targets, are implemented with various sonar and laser MCM systems and described by several MOPs including probabilities of detection, classification, reacquisition and their associated execution times (PEO LMW 2008).

The engage function involves those sub-functions used in neutralization and minesweeping. Sub-functions include mechanical sweep, influence sweep, and neutralization of mines. These functions, as they apply to the direct conflict between sensors and mines, are implemented with various sweep and neutralization MCM systems and described by several MOPs including probabilities of neutralization and neutralization time (PEO LMW 2008).

The control function involves those sub-functions used in controlling whether a mine acquires a ship or a sensor acquires a mine. Sub-functions include ship acquisition, mine acquisition, and platform performance. These functions, as they apply to signature and maneuver control, are implemented with particular MCM platforms and described by several MOPs including transit times to minefields as well as the times to deploy and collect gear (PEO LMW 2008).

The logistic function involves those sub-functions relevant to the MCM systems' ability to perform their intended purpose. Sub-functions include system availability and DC. These functions can sometimes be described through the application of other functions and are described by several MOPs including platform availability and duty-cycle (PEO LMW 2008).

Operational command, control, communications, computers, intelligence, surveillance, and reconnaissance (C4ISR) functions are not explicitly addressed pending better functional need explanations (PEO LMW 2008).

N. MIW CHALLENGES AND MISSIONS

Every Navy mission has its own particular challenges and dangers, and MIW is no exception. As described in Section H, one of the most fundamental problems to date has been the relatively low level of sustained attention on MCM by the Navy. According to Melia (1991), one of the key trends in MIW has been the cyclical nature of its funding and the attention paid to it. During most of the major wars and conflicts since the advent of naval mining, the Navy has discovered that mines are a substantial threat to naval actions. For example, since WWII, naval mines damaged or destroyed more naval ships than all other forms of enemy attack, to include missiles and small boat swarms (Marine

Corps Combat Development Command and Naval Doctrine Command 1998) (see Figure 1). In both Korea and Iraq, mines were the only type of attack to damage or sink a U.S. Naval ship (Marine Corps Combat Development Command and Naval Doctrine Command 1998). Yet, shortly after hostilities ended, the Navy reduced its funding and emphasis on MIW and mine clearing (Marine Corps Combat Development Command and Naval Doctrine Command 1998).

Another challenge has been the diversity and complexity of threats. As discussed in Section K, there are numerous types of mines, each of which can be emplaced in several ways and triggered in several more ways. The myriad potential combinations of mine type, triggering mechanism, and emplacement impact the ability to detect and neutralize the mines. This also affects how dangerous mine clearing operations are.

Finally, there is the problem of actually detecting and neutralizing the mines. Mines are explosive devices capable of damaging ships and equipment and injuring sailors. By their very nature, they are dangerous to handle. Historically, mine clearing efforts have required ships to physically enter a suspected minefield in order to bring their detection systems to bear. This places the mine clearing ship in danger of being destroyed by the very devices it hunts. Additionally, many historic methods of clearing required the use of divers or very lightly protected ships, usually made out of wood so as not to trip magnetic influence mines, and equipment to neutralize mines inside the minefield, placing personnel in danger. The LCS is the beginning of a shift away from putting Navy personnel directly in harm's way for mine clearing operations inside minefields. The LCS achieves this goal through extensive use of aerial and unmanned assets; however, the problem still has not been completely solved.

An additional complicating factor is the wide range of mine clearing missions the Navy has to perform. A partial list of potential missions includes:

- Deep water mine clearing: this mission is difficult because of the large volume of water that must be cleared. This is partially mitigated by the difficulty miners have in deploying enough mines to adequately cover the area and prevent ships from passing through. One of the greatest examples of a deep water minefield was the "North Sea Barrage" in WWI (Melia 1991). This field stymied German forces for several months.

- Opening a harbor: one of the historically common uses of mines has been to deny access to harbors. When an enemy force uses mines to either block U.S. force movements or to try to direct the ships through specific areas, the Navy may need to clear some or all of the mines in order to transit and maneuver as desired. Selective clearing may enable the Navy to accomplish its military objectives, but harbors and bays are often difficult environments due to navigational hazards, non-combatants, and defensive emplacements. A classic example of this type of mission occurred very early in the history of MIW at Mobile Bay during the American Civil War. (Melia 1991)
- Landing Marines: this mission combines the difficulties of maneuvering in shallow water, the hazards of being within observation and possibly firing range of enemy forces, and the increased danger presented by bottom mines. Bottom mines, as discussed, are particularly dangerous because they can have larger charges and may be more difficult to detect depending on bottom features of the area. The landings at Normandy on D-Day were planned around an assumed high likelihood of mines in the area. Several ships and landing craft were lost on the approach to the beaches, and it was primarily due to luck that the Allies managed to avoid most of the particularly dangerous mines. The Allies only discovered the extent and sophistication of the Axis minefields after the invasion was complete. (Melia 1991)
- Shipping lane clearance: this mission may take place in very deep or fairly shallow water, but it is critical to note the presence of large amounts of non-combatant shipping in the area. Additionally, enemy forces may also be in the area, requiring mine clearing in conjunction with self-defense and defense of non-combatants. Because of the smaller volume of water that must be mined in order to be effective, minefields may be fairly dense and comprised of large numbers of mines of various types. Threats made by Iran to close the Strait of Hormuz would fall into this mission type. (Melia 1991)

O. INTELLIGENCE IN MCM OPERATIONS

Nearly every practical component of MCM operations is contingent upon the presence of high-quality ISR information prior to operations. According to PEO LMW (2009), “90 percent of all mine hunting and sweeping operations have been conducted in areas in which mines have not been deployed—underscoring the need for good actionable intelligence” (22). A 2001 report by the Committee for MIW Assessment stated, “Improvement in ISR for mine warfare can have a greater impact on naval forces mine warfare capability than any other step that might be taken” (Committee for Mine Warfare

Assessment 2001, 38). In their taxonomy of MCM ISR, PEO LMW (2009) provides a convenient conceptualization of intelligence and its unique functions: strategic, operational, and tactical intelligence.

Strategic intelligence is coordinated and conducted at the national and international levels. Specifically, strategic intelligence involves participation among the State Department, DOD, and the Intelligence Community. These national and joint organizations participate in information sharing among foreign and coalition partners who have an interest in creating safe seas (PEO LMW 2009). This involves the analysis of what potential threat countries are doing in the area of MIW, including the proliferation of MIW systems. Strategic intelligence may result in new indications of state-level adversaries that are engaging in MIW.

Both the DOD and the DON conduct operational intelligence. These activities include monitoring “the development, acquisition, and sale of sea mines through intelligence-collection activities and interaction with foreign militaries” (PEO LMW 2009, 23). The objective of operational intelligence activities as they pertain to MIW is to obtain scientific and technical intelligence regarding the technical characteristics of adversaries’ sea mines, such as mine types, firing methods, and explosive weights. This analysis is informed by the acquisition of foreign mines, which are studied for the purpose of developing specific countermeasure strategies (PEO LMW 2009). Operational intelligence also includes the analysis of doctrine; tactics, techniques, and procedures (TTPs); orders of battle; and the number of each specific system in a country’s inventory.

Tactical intelligence is conducted by the Navy. The purpose of tactical intelligence is to obtain information regarding the offensive and defensive mining strategies of adversaries. Specifically, tactical intelligence is used to understand whether an adversary’s objective is to mine in order to engage in a blockade, area denial, or harassment. Moreover, tactical intelligence seeks insight into the specific complement of mines and their deployment state for a specific event (PEO LMW 2009).

These varying types of intelligence generally result in two forms of actionable intelligence: predictive indications and warnings (I&W) and in situ intelligence. Predictive

I&W are produced by strategic and operational intelligence collection efforts. The ultimate objective of predictive I&W are to collect tips and cues on mining activities before they occur. This level of predictive knowledge enables Navy forces to either prevent the mine laying efforts altogether or, if possible, to engage in strategic planning to avoid the minefields. In situ intelligence is produced by operational and tactical intelligence collection efforts. This level of intelligence equips Navy forces to engage in the MCM functions of search, detect, identify, and neutralize with greater effectiveness (PEO LMW 2009).

A separate but related intelligence concern is the fusion of environmental considerations into the common operating picture. PEO LMW (2009) wrote:

[a] critical factor contributing to U.S. mine domain awareness is good knowledge of the physical, geographic, oceanographic, bathymetric, and environmental characteristics of potential mining areas and data of sufficient quality and currency to support mine countermeasures operations. These factors will drive both the use and placement of mines and the tactics and the choice of techniques used to counter them. (24)

The Navy relies on an automated tool called the Mine Warfare and Environmental Decision Aids Library (MEDAL) to provide decision support services for MIW forces. The MEDAL fuses and synthesizes ISR information and local environmental conditions to create a common operating picture that enables the command and control of MIW and MCM forces. PEO LMW (2009) provides a thorough description of MEDAL, noting:

MEDAL provides tactical decision aid functionality to the warfighter, including integrated mission planning, evaluation, and situational awareness capability. MEDAL also provides the warfare commander and other supporting commanders with coordinated mine warfare situational awareness. MEDAL integrates intelligence preparation of the environment data, mission planning and evaluation, situation awareness, and command-and-control capabilities to support the Mine Countermeasures Commander, organic and dedicated mine countermeasures operators, and all naval and maritime forces requiring mine warfare situational awareness. (24–25)

James Bahr (2007) describes a 1987 incident involving the mine laying activities of the Iranian vessel, Iran Ajr. Intelligence provided by the USS *Jarrett* (FFG-33) was acted upon and the Iran Ajr was engaged before it could deploy its full cargo of mines

within the Persian Gulf. This incident demonstrates how ISR is used to improve the effectiveness and efficiency of MCM operations. Table 2 describes the importance of several types of intelligence used during MCM operations.

Table 1. The Importance of Intelligence to MCM

Intelligence	Importance to MCM
Activity levels at mine storage facilities or the presence of mines on transportation and deployment assets.	Increased activity levels at mine storage facilities may indicate that mines are being prepared or transported for deployment. When rules of engagement permit, mine storage, transportation, and deployment assets can be attacked before mines are deployed. MCM operations become much more difficult once mines are in the water (Truver 2008).
The location of deployed mines.	Knowing where mines are deployed makes it possible to avoid them and provides a starting point location for mine hunting and mine sweeping operations.
Mining objectives, doctrine, tactics, and inventories. Technical details about mine sensors, firing criteria, and countermeasures. Ocean terrain and presence of mine-like objects (MLOs).	This information greatly improves the effectiveness of mine hunting and mine sweeping operations, especially influence minesweeping (Truver 2008).

The collection and transfer of intelligence data was not explicitly evaluated in this study, however, their impacts on successful MCM operations would be an interesting future study that may provide valuable insights to the Navy. The portion of intelligence involving MEDAL (or post mission analysis (PMA)) was modeled in a limited form to capture the effects on time to complete and mine clearance effectiveness. This included the time delay that contributes to the overall ACRS and the probability that the system will select and prioritize mine-like contacts (MILCOs) for RI&N.

P. INTRODUCTION AND BACKGROUND SUMMARY

Before, during, and after the research of the information contained within published material, the MIW Team developed and refined a list of research questions to

guide efforts in identifying the necessary information for the conduct of the study and for the formulation of the topics to discuss with the stakeholders. The focus was on systems used to perform each function of MCM operations, types of mines and the methods used to neutralize them, and the sequence of events for MCM operations. These focused areas of interest helped to shape the problem definition and project scope. The research was conducted to develop a baseline understanding of the MCM systems (legacy and planned), MCM operations and function, MCM systems and subsystems, mine threats, and operational requirements for MCM operations. The findings summarized within this section helped to shape the discussions with the stakeholders and SMEs to develop their needs and to formulate the project scope and plan for completion IAW with the project's SE process. The research also scoped the MCM analysis study to compare MCM performance of the legacy MCM 1 MIW ship to the new LCS ship.

II. SYSTEMS ENGINEERING APPROACH

This section describes the SE approach and processes used to conduct the MCM comparative analysis study. The results and outcomes of each SE process are included in other sections within this report; the purpose of this section is to describe the SE processes and approach used for this study. The MIW Team selected the classic “Vee” process model and then tailored it to accommodate project specific objectives and constraints. This section describes the rationale for selecting and tailoring the “Vee” process model and identifies steps taken to conduct the analysis in a disciplined manner in which the stakeholders can have confidence.

A. PROCESS OVERVIEW

The objective of the MCM comparative analysis study was to use a model based systems engineering (MBSE) approach, where such an approach uses modeling tools to develop requirements and MOEs, as well as functional and physical architectures, to compare MCM performance of the legacy MCM 1 ship, and legacy MCM MH-53E helicopter, to the new LCS ship, with the MH-60S helicopter and incremental MIW packages. To accomplish this objective, the MIW Team performed an analysis of alternatives (AoA) using scenario-based modeling and simulation (M&S). Based upon stakeholder feedback, an operational scenario was developed and ACRS was selected as the primary MOE for comparison. Lifecycle cost and risks were also considered, and are detailed in Chapter IX.

The waterfall, spiral, and “Vee” process models were considered for the MCM comparative analysis study (Forsberg and Mooz 1991; Sikder 2009). The purely sequential waterfall model was not selected because it does not accommodate changes in the overall SE process or requirements changes that occur partway through the process. Conversely, the spiral process model was not selected because it was deemed excessively process-oriented and not well suited for the aggressive timeline of the MIW research project. The classic “Vee” model was selected because it provides the required balance of flexibility and rigor.

The classic “Vee” model, originally developed by Forsberg and Mooz (1991, 5), is depicted in Figure 5. The process begins at the upper left side of the “Vee” with the refinement of stakeholder requirements into a system performance specification. Decomposition and definition continue down the left side, resulting in “design-to” specifications and “build-to” documentation. Construction of system components begins at the base of the “Vee” and continues up the right side with the assembly of components into configuration items (CIs) and integration of CIs into a coherent system. The scope of the MCM comparative analysis was to evaluate existing systems rather than to design and build a new system. For this reason, activities on the right side of the “Vee” were not included in the tailored SE process.

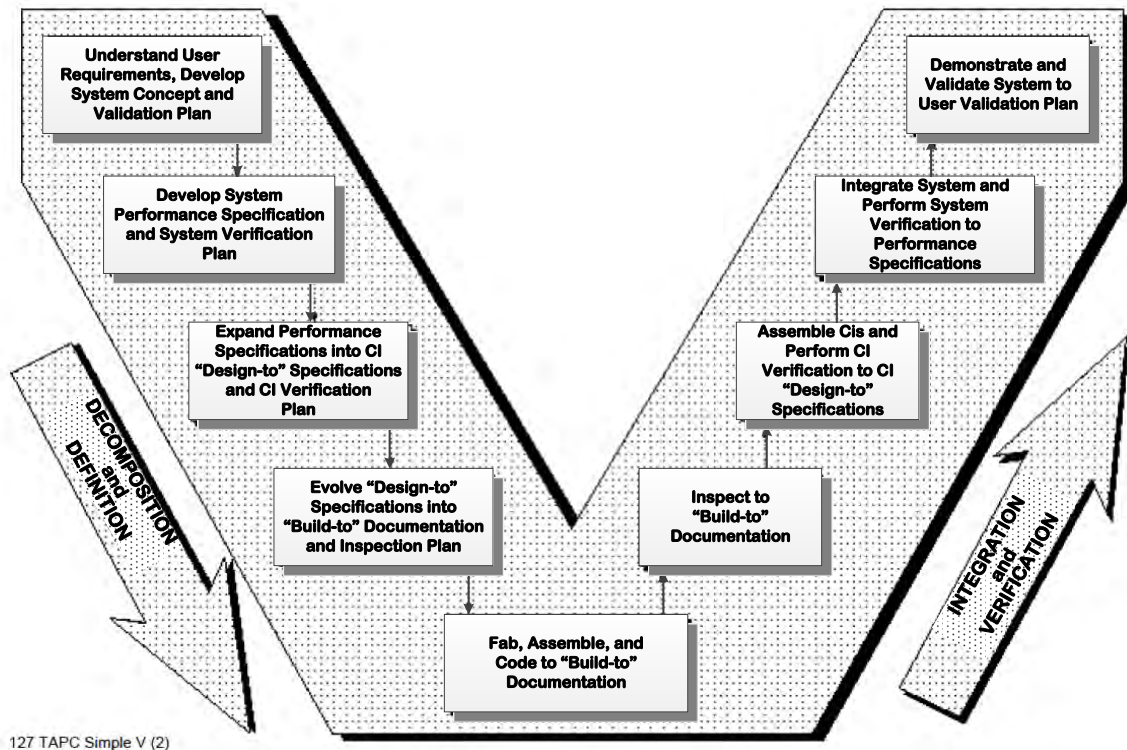

127 TAPC Simple V (2)

Figure 5. Classic Systems Engineering “Vee” (from Forsberg and Mooz 1991, Exhibit 5)

Though the classic “Vee” model has long stood as the paragon of SE models for manufactured systems, a key criticism is the lack of intrinsic iteration offered by the

model (Mohammed, Munassar, and Govardhan, 2010). To overcome this shortfall, iterative feedback was included in the tailored SE process. The practical effects of this iterative feedback included: (1) the ability to adjust the model and simulation design as stakeholder needs and system requirements were further refined and (2) the implementation of M&S changes with minimal effort. Figure 6 depicts the tailored SE process used for the MCM comparative analysis study.

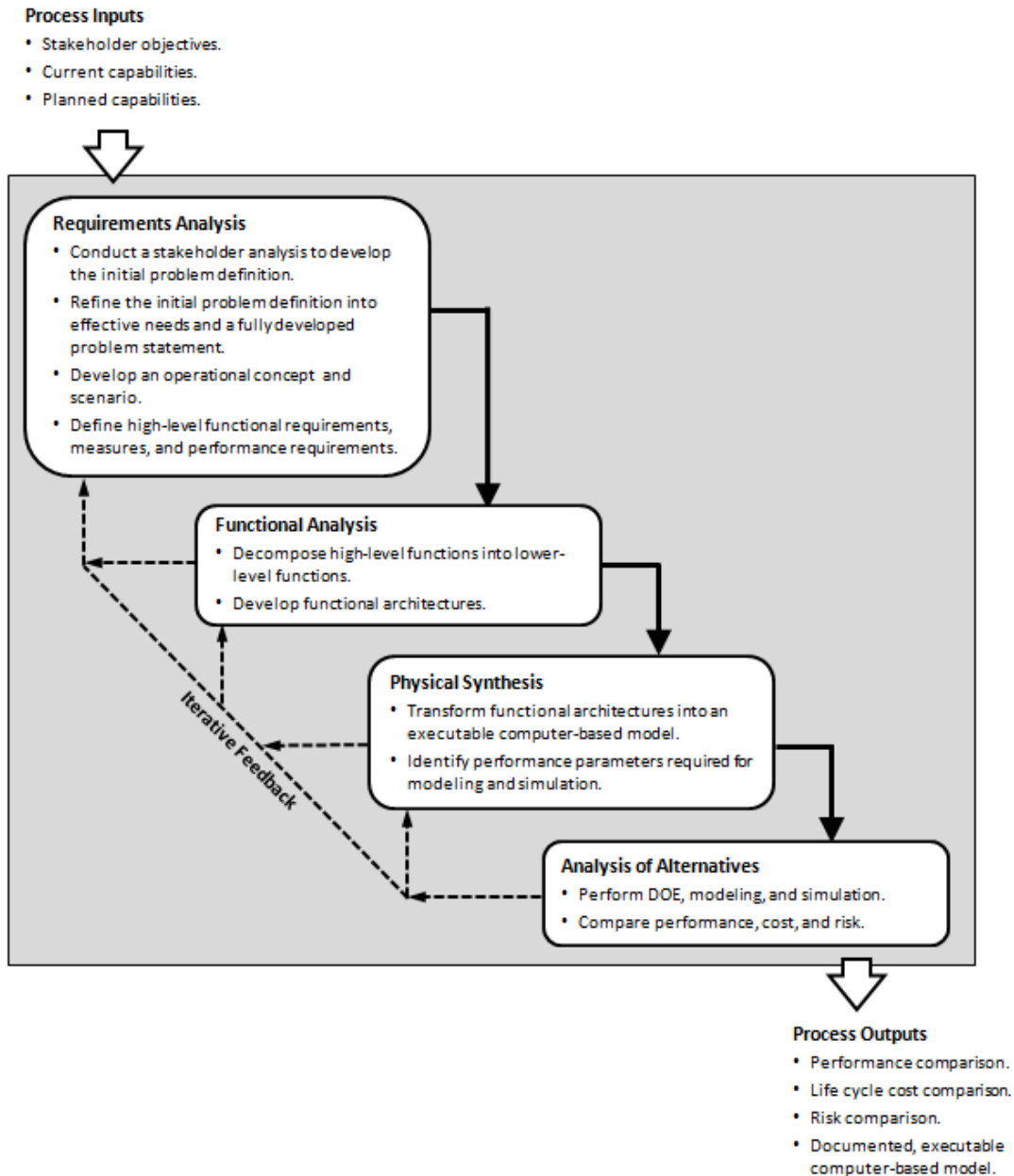

Figure 6. Tailored SE Process used for the MCM Comparative Analysis Study

B. REQUIREMENTS ANALYSIS

In order to produce an accurate and meaningful comparison of the current and planned MCM systems, the team had to first understand the functional and performance requirements for this type of system. A requirements analysis was conducted to obtain stakeholder requirements and translate them into system requirements to serve as a basis

for comparison. Figure 7 depicts the requirements analysis process used for the MCM comparative analysis study.

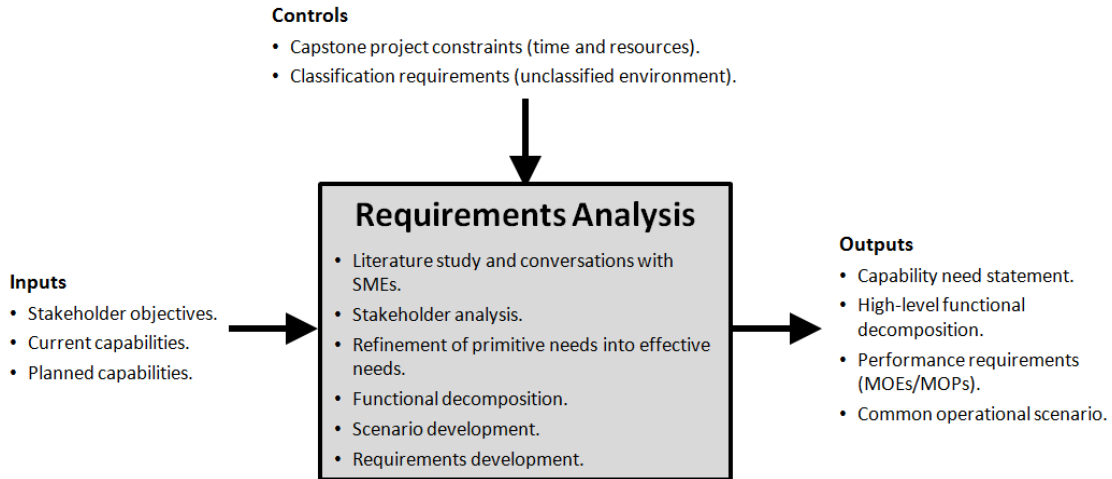

Figure 7. Requirements Analysis used for the MCM Comparative Analysis Study

Inputs to the requirements analysis included information related to stakeholder objectives, current capabilities, and planned future capabilities. This information was obtained through a literature study and during several conversations with SMEs in the field of MCM. To begin the requirements analysis, a stakeholder analysis was conducted to identify MCM stakeholders and their primitive needs. Although somewhat ambiguous and in need of further development, these primitive stakeholder needs provided an initial definition of the problem to be solved.

Next, through a series of conversations with stakeholders and SMEs, primitive needs were refined into a less ambiguous effective need and an overarching capability need statement. Project constraints, such as the time and resources available to complete the study, were carefully considered and a problem statement was developed. This problem statement clearly defined the problem to be solved by conducting the MCM comparative analysis study. A common operational scenario was created to allow for a fair comparison to be made in a small subset of the larger MCM problem set. The M&S efforts

were based upon this common operational scenario. The requirements analysis produced a set of high-level functional requirements describing functions that an MCM system must perform in order to satisfy stakeholder needs. For each high-level functional requirement, one or more performance requirements were developed along with the associated MOEs and corresponding MOPs.

C. FUNCTIONAL ANALYSIS

The high-level functional requirements identified during the requirements analysis did not provide sufficient detail for the upcoming physical synthesis. A functional analysis was performed to decompose high-level functions into lower-level functions. Figure 8 depicts the functional analysis process used for the MCM comparative analysis study.

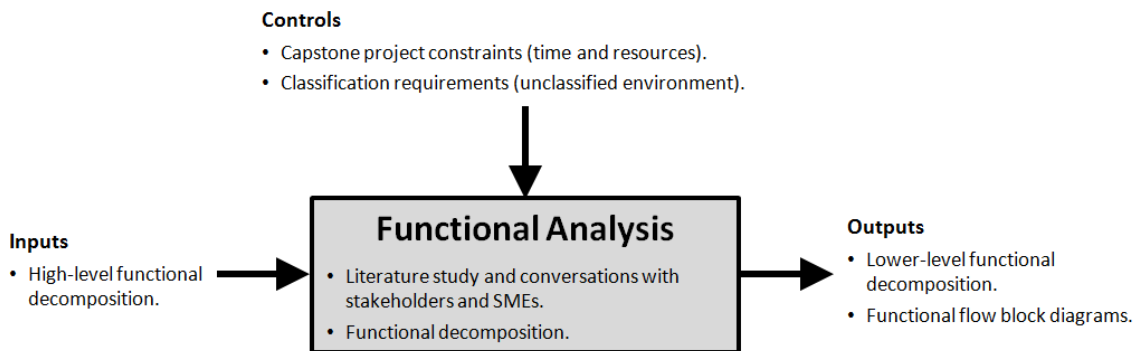

Figure 8. Functional Analysis used for the MCM Comparative Analysis Study

The input to the functional analysis was the high-level functional decomposition resulting from the requirements analysis. The team consulted available literature, stakeholders, and SMEs to determine how best to decompose the high-level functional requirements. This also resulted in the functional architecture that is described in Chapter IV. MOPs identified during the requirements analysis were likewise decomposed and assigned to the new lower-level functions. Iterative feedback led to minor revisions to products developed during the requirements analysis.

D. PHYSICAL SYNTHESIS

A physical synthesis was performed to transform the functional architecture in order to develop the physical architecture (see Chapter IV) and then develop a computer-based model. Figure 9 depicts the physical synthesis used for the MCM comparative analysis study.

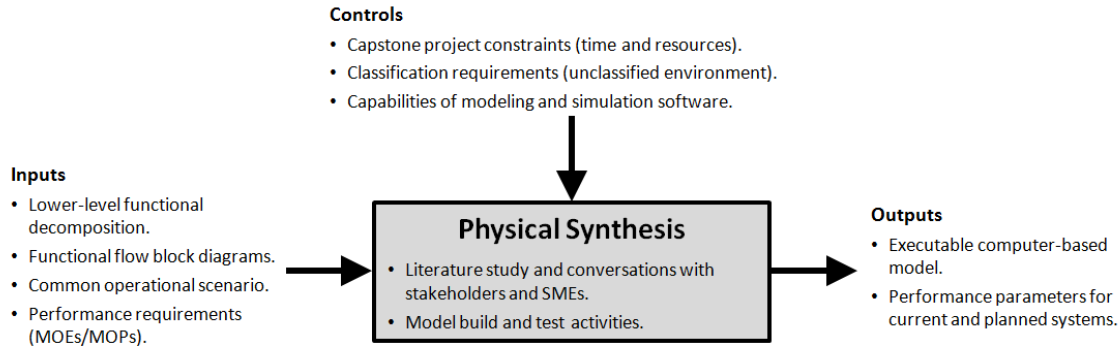

Figure 9. Physical Synthesis used for the MCM Comparative Analysis Study

Inputs to the physical synthesis included the low-level functional decomposition, functional flow block diagrams (FFBDs), common operational scenario, and performance requirements in the form of MOEs and MOPs. Available literature and SMEs were consulted to determine how best to model the MCM mission and to obtain performance parameters for use within the model. A simple proof-of-concept model was first created using Microsoft Excel; this was followed by a more complex model, developed using Imagine That Inc.'s ExtendSim software. Iterative feedback led to minor revisions of products developed earlier in the SE process.

E. ANALYSIS OF ALTERNATIVES

An AoA was performed to compare the tools and methods available for use in assessing the current and planned MCM systems. Platforms for both developing the model and performing the analysis on the simulation results had to be considered and analyzed to see what platforms were able to fulfill the requirements of the study. This AoA considered both ExtendSim and Map Aware Non-uniform Automata (MANA) software for

model platforms with which to simulate the MCM 1 and LCS. A description of each software tool is included in Chapter VI and the evaluation is extended in Appendix B.

After carefully considering both ExtendSim and MANA as possible platforms for the models to be built on, it was determined that ExtendSim was the better platform for this project. MANA had numerous technical drawbacks for this application, and there was also a lack of familiarity in programming with MANA. Given the project constraints in resources (time and people) it was determined that ExtendSim was a better fit for the team involved. Furthermore, the scope of the project would use little of MANA’s advantages, and relies mostly on the sensitivity analysis, DOE, and subsequent performance analysis, where ExtendSim had the clear advantage over MANA.

Figure 10 depicts the factors that were considered during the AoA used for the MCM comparative analysis study.

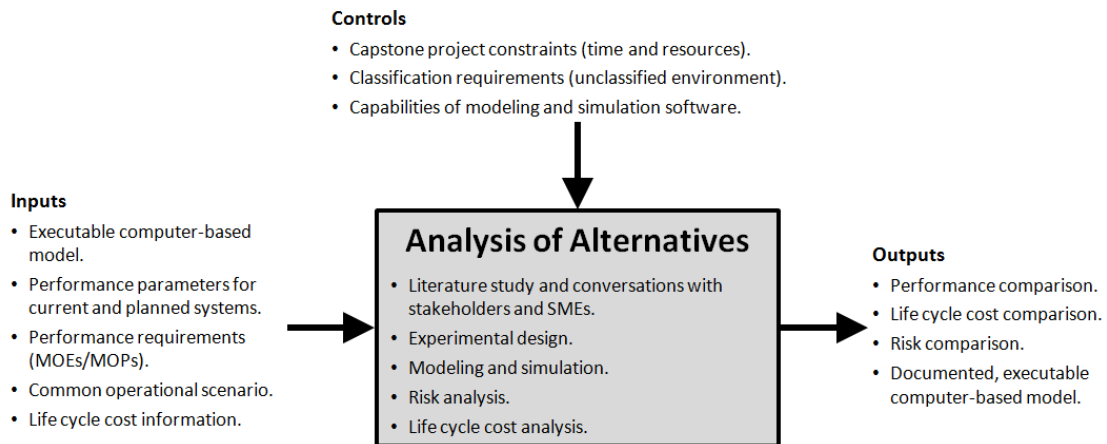

Figure 10. AoA used for the MCM Comparative Analysis Study

Inputs to the AoA included the executable computer-based model, performance parameters for the current and planned systems, performance requirements, common operational scenario, and life cycle cost information. ACRS and percent clearance were selected as the primary MOEs for a quantitative system performance comparison based upon a common operational scenario. Life cycle cost and risk analyses were conducted by examining the risks associated with the various models, and the various systems, as well

as looking at cost as an independent variable (CAIV). Sensitivity analysis using a DOE was used to determine the impact of various mission-based and environmental parameters for performance analysis and overall comparison of the two models. Iterative feedback led to minor revisions of products developed earlier in the SE process.

DOE was performed to characterize the performance of various MOEs and MOPs under a representative range of conditions for each input parameter (factor). The objective behind the DOE methodology was to (1) use a systematic method of varying input values into the architecture models, (2) maximize the yield of useful information as the output of model-based analysis, and (3) create a statistical model by which results could be analyzed for quantitative comparison (Hernandez 2013).

Upon completion of the DOE, the sufficient information, including raw output data and statistical models, was available to perform quantitative comparison.

F. MODEL BASED SYSTEMS ENGINEERING APPROACH

The SE team used a MBSE approach to develop the requirements, MOEs, and functional and physical architectures that drove the development of the tool and methodology used to compare current and planned MIW architectures in a scenario-based analysis. The tailored SE process was in keeping with the International Council on Systems Engineering (INCOSE) definition of MBSE as “the formalized application of modeling to support system requirements, design, analysis, verification, and validation activities beginning in the conceptual design phase and continuing throughout the development and later life cycle phases” (Crisp 2007).

In an MBSE framework, the following steps are followed:

1. The system boundary is defined.
2. The requirements are captured.
3. The system logic is defined.
4. The system logic is implemented.
5. The model is tested (Scott 2011).

In practical terms, the MIW Team worked with stakeholders to define an operational scenario, capture system requirements, and define system boundaries. A computer-

based model was then built and simulations were conducted under a spanning set of variants. CORE was used to develop the physical and functional architectures for this project.

G. SYSTEMS ENGINEERING PROCESS MANAGEMENT

For planning purposes, the tasks described above were divided into three project phases. The first phase, planning and research, included the requirements analysis. This phase involved initial research, stakeholder analysis, needs definition, and problem definition development. Once the SE process was defined and the initial research was conducted, the MIW Team focused on the development of the problem statement and project scope. The importance of clearly identifying the stakeholders' needs and defining the problem allowed the MIW Team to focus on what needed to be built. This ensured that the final product met the stakeholders' needs. Also during this phase, additional effort was devoted to the development of the preliminary functional analysis and architecture.

The second phase, AoA, included the functional analysis, physical synthesis, and the beginning of the AoA. The functional and physical architectures were defined and the requirements were refined. These were then mapped to each other to ensure that all requirements were being met. This phase also included activities required for planning, building, and exercising the computer-based model.

The final phase, implementation, included completing the AoA, which involved exploring alternative architectures and analyses in addition to the cost, risk, and decision analysis tasks. As necessary, the MIW Team cycled back to previous tasks to refine the products and approach regardless of the phase in which the need was identified.

H. STRENGTHS AND LIMITATIONS

The tailored version of the classic "Vee" process model worked well within the scope and constraints of the MIW research project. The MIW research team had no prior experience in the field of MIW and, unlike the waterfall process model, the classic "Vee" model with iterative feedback allowed products to be revisited as the team became more knowledgeable about the subject. The classic "Vee" model, unlike the excessively pro-

cess-oriented spiral process model, was also well suited for the aggressive timeline of the MIW research project.

I. SE PROCESS SUMMARY

The team used a tailored SE process that best fit the scope of the project. The first step of the process evaluated the stakeholders' needs and developed the problem statement. Following that, a MBSE approach that developed the requirements, MOEs, as well as functional and physical architectures was then be used to develop the methodology for the comparative study. These products were then used as the foundation for the AoA phase, which was initiated by modeling the MCM configurations IAW the requirements. DOE was used to generate the run matrices that allowed for the factors to be screened and evaluated.

The final output of the process were the recommendations, which are specified in this report in Chapter VIII and summarized in Chapter X. Cost and risk analyses were performed on the current and future MCM configurations and a cost-benefit analysis was performed on the recommendations developed by the MIW Team after the initial analysis was completed.

THIS PAGE INTENTIONALLY LEFT BLANK

III. STAKEHOLDER ANALYSIS

Concurrent with the literature review and research into previous, related studies, the MIW Team worked with the stakeholders, advisors, and MIW SMEs to develop the problem definition and project scope. This process involved identifying the stakeholders and eliciting their primitive needs and then transforming those into an effective need statement and a detailed problem statement. The familiarization with the scope of the MCM problem domain's challenges and the constraints within which the project had to be conducted assisted the MIW Team in its efforts to develop a relevant, useful, and realizable project scope.

This section identifies and describes the stakeholders, their primitive needs, and their roles in MIW countermeasures development and then describes the transformation of those primitive needs into an effective need. Following that description, the definition of the problem statement and project scope is described. Additionally, the project's constraints and the assumptions used in the definition of the project's scope and approach are listed in this section. As summarized, the problem definition evolved throughout the initial planning and research phase of the project as the MIW Team and the key stakeholders increased their knowledge of and appreciation for the environment within which the study had to be conducted.

A. STAKEHOLDER IDENTIFICATION AND ANALYSIS

For this project, the stakeholders included any individual, group, or institution with a vested interest in MIW. Conducting stakeholder analysis ensured the appropriate stakeholders' needs were identified, analyzed, and addressed early in the SE process. The stakeholders' needs drive the system requirements, so an attempt to thoroughly and accurately identify all stakeholders and capture their needs was imperative to correctly forming, scoping, and bounding the system architecture. The following steps were taken to perform the stakeholder analysis:

1. Identify potential stakeholders and their interests in MCM.
2. Classify potential stakeholders.

3. Determine key stakeholders and prioritize the needs of those stakeholders.
4. Identify stakeholders' primitive needs.
5. Identify stakeholders' effective need from the primitive needs.
6. Transform stakeholders' effective need into requirements and a problem statement.
7. Communicate the captured needs and resulting requirements to the stakeholders for feedback.
8. Incorporate stakeholder comments into a final list of requirements.

The initial list of stakeholders was developed from the initial project description in which the project sponsors were identified. Research into MIW and MCM systems identified additional, potential stakeholders as those organizations involved with the development and operational use of MCM systems. Attention was given to the entire lifecycle of the MCM system to ensure a comprehensive list of potential stakeholders was identified. After all potential stakeholders were identified, classification to define the roles of each of the potential stakeholders began.

The first step in classifying potential stakeholders was determining the level of involvement in the MCM systems and operations for the identified stakeholders. Internal stakeholders are those who have direct interaction with the MCM systems. Stakeholders identified as having direct contact with the system, but no direct interaction with internal stakeholders were classified as first-order stakeholders. Stakeholders whose only connection to the MCM systems is through interaction with first-order stakeholders were identified as second-order stakeholders. The first-order and second-order stakeholders comprise the boundary stakeholders. After the internal and boundary stakeholders were classified, the relationships between the stakeholders and the MCM systems were analyzed.

The interest and influence that stakeholders have over funding, design and development, system acceptance, operations, and disposal were used to prioritize the stakeholders. Typically, the prioritization of stakeholders aids in determining the key system stakeholders and assists the SE team in identifying and focusing on the most important stakeholders and their needs in the event of a conflict. In this case, it assisted the MIW Team to understand and appreciate the spectrum of the needs for the MCM study.

For complex systems, determining the key stakeholders is critical to allow for proper identification of needs that shape the system design, development, acquisition, and operation (INCOSE 2010, Section 4.1). Each stakeholder's importance, influence, interactions with other stakeholders, and duration of involvement with the subject under study must be considered. After being identified as a key stakeholder, each key stakeholder was ranked as either primary or secondary. Primary stakeholder's needs must be addressed. Secondary stakeholder's needs are addressed if and when possible. In this project, the stakeholders' needs were communicated via the MIW consultant. The primitive needs were discussed, evaluated, and analyzed until an effective need could be developed. This effective need formed the foundation for the problem statement. These were refined and modified until acceptable need and problem statements were developed.

The requirements for the project were finally derived by analyzing the effective need of the key stakeholders. Research into the current state of MCM systems coupled with the key stakeholder's requirements for future MCM capabilities helped define the project's scope. Table 2 summarizes the results of the stakeholder analysis and includes the stakeholders, their interest in MIW, their classification and priority ranking, and their influence in systems that are related to MIW operations and capabilities. As shown in Table 2, there were two types of primary stakeholders identified as designated with the classifications of either project or internal. The groups and personnel who had a direct interest and involvement with the successful completion of this project were considered project, primary stakeholders. Those who were primarily involved with the conduct and outcome of this study were characterized as internal, primary stakeholders.

Table 2. Stakeholder Identification and Analysis

Stakeholders	Classification (Project, Internal, 1st, 2nd, Boundary)	Type Prioritization (Primary, Secondary)	Level of Involvement in MIW	Interest in MIW & MCM (Primitive Need)
NPS	Project	Primary	Conducting research and development to support the warfighter. Provide quality educational environment to prospective SEs for DOD.	Interested in developing new strategies and system for MIW Operations. Interested in developing skilled DOD SE personnel.
Admiral Richard Williams III (Ret.)	Project	Primary	Primary MIW expert consultant for NPS led study.	Interested in providing expert advice for the MIW Team to ensure the development of quality, useful research-based product.
NSWC PC	Internal	Primary	Conduct research, development, test and evaluation (T&E), in-service support of MIW systems, mines, naval special warfare systems, and other systems primarily occurring in coastal regions. (Naval Sea Systems Command n.d.—b)	Interested in all aspects of MIW. As stated in 9 May 2014 meeting and in personal communication dated 15 May 2014, particularly interested in increasing the ACRS for defensive MCM operations.
NSWC, Future Ship Concept Branch	Internal	Primary	Specializes in ship design & integration. (Naval Sea Systems Command, n.d.—c)	Interested in requirements for ship designs and equipment integration that enable best performance of MIW operations.
PEO LCS (Formerly PEO LMW)	Internal	Primary	Responsible for acquiring and maintaining the littoral mission capabilities of the LCS class including programs to support MIW (Secretary of the Navy n.d.)	Interested in capabilities assessments and recommendations for enhancements to shipboard, deployable vehicles
PEO Ships	Internal	Primary	Responsible for executing the development and procurement of all destroyers, amphibious ships, special mission and support ships, and special warfare craft. (Naval Sea Systems Command n.d.—d)	Interested in capabilities assessments and recommendations for enhancements to shipboard, deployable vehicles
Personnel: Navy and Marines	Internal	Secondary	Operational involvement	Interested in the best equipment and methods to destroy enemy sea mines.

Stakeholders	Classification (Project, Internal, 1st, 2nd, Boundary)	Type Prioritization (Primary, Secondary)	Level of Involvement in MIW	Interest in MIW & MCM (Primitive Need)
PMS 340: Naval Special Warfare Program Office	Internal	Secondary	Involved in the development of systems and procedures for naval special warfare operations.	Interested in outfitting the War Fighters with the best equipment and training possible to accomplish the mission.
PMS 403: Remote Mine Hunting Program Office	Internal	Secondary	Involved in the development of systems and procedures for remote mine hunting.	Interested in outfitting the War Fighters with the best equipment and training possible to accomplish the mission.
PMS 406: Unmanned Maritime Systems Program Office	Internal	Secondary	Involved in the development of systems and procedures for maritime surveillance operations.	Interested in outfitting the War Fighters with the best equipment and training possible to accomplish the mission.
PMS 420: LCS Mission Modules Program Office	Internal	Secondary	Involved in the development of systems and procedures for LCS Mission Module Systems.	Interested in outfitting the War Fighters with the best equipment and training possible to accomplish the mission.
PMS 495: MIW Systems	Internal	Secondary	Involved in the development, fielding, and –n-service support for all mining and mine countermeasure systems in the areas of minehunting, minesweeping, mine neutralization, and the development of mines for offensive MIW. (PMS 495 Mine Warfare Program Office 2008)	Interested in developing the highest value MIW systems possible.
Nation’s Allies	Boundary	Secondary	Direct stakeholders as mines can affect any allied nation with littoral coastline.	Interested in protecting their naval and commercial shipping, and keeping their SLOCs open.
PMS 480: Anti-Terrorism Force Protection Afloat Program Office	Boundary	Secondary	Involved in the development of systems and procedures for maritime anti-terrorism operations.	Interested in outfitting the War Fighters with the best equipment and training possible to accomplish the mission.
PMS 485: Maritime Surveillance Systems Program Office	Boundary	Secondary	Involved in the development of systems and procedures for maritime surveillance operations.	Interested in outfitting the War Fighters with the best equipment and training possible to accomplish the mission.

Stakeholders	Classification (Project, Internal, 1st, 2nd, Boundary)	Type Prioritization (Primary, Secondary)	Level of Involvement in MIW	Interest in MIW & MCM (Primitive Need)
N81 (Assessments)	1st Order	Secondary	Involved with the determination of system effectiveness through the conduct of capability assessment analyses for warfighting and warfighting support. Also responsible for the integration and prioritization of enhancements and upgrades to capabilities. Lastly, interested in the development and validation of analytic tools and techniques. (“N81 Alignment Warfare” 2006)	Interested in methods to enhance and/or upgrade existing MIW scenario and warfighting models
N95 (Expeditionary Warfare)	1st Order	Secondary	Responsible for assessing requirements for naval expeditionary warfare missions and programs, including MIW. Also responsible for determining characteristics and structure for all MIW ships. (“[Office of the Chief of Naval Operations] OPNAV 95” 2013)	Interested in capabilities assessments and recommendations for enhancements to shipboard, deployable vehicles
N96 (Surface Warfare)	1st Order	Secondary	Responsible for determining requirements for surface combatants and support ships, as well as to coordinate, supervise, and execute Navy shipbuilding for above surface combatant ships. (“OPNAV N96” 2013)	Interested in developing improvement modifications to the LCS current design

B. REQUIREMENTS ANALYSIS

After the stakeholder analysis, it was necessary to analyze their needs in order to translate the primitive needs into an effective need. This section includes the progression from the identification of the primitive needs to the development of the effective need and then the problem definition as detailed in the SE Process (Chapter II). These tasks were necessary to develop the requirements and architecture to ensure that the project would satisfy the stakeholders' needs.

1. Primitive Need Summary

Consistent among the many stakeholders is the need to develop the most capable and cost-effective MIW resources and to deploy those systems to the fleet for operational use. Initially, this was translated into the project requirement for a comprehensive comparative analysis that would result in sufficient data to provide an extensive assessment of the current MIW capabilities and that could be used as a foundation for decisions and plans that will result in the most effective MIW systems. Due to the project constraints (listed in Chapter I), however, it was deemed infeasible to conduct such a broad study. This reality combined with advice and guidance resulted in the need for a study that was focused on one aspect of MIW: the analysis of the MCM effectiveness and the ACRS in defensive MCM operations in deep water SLOC missions (see Chapter I for a detailed description of this metric).

2. Effective Need Summary

After extensive research to collect all available, unclassified performance data and through several iterations with the stakeholders at NSWC PC, the MIW Consultant, and MIW Team Advisors, the following effective need statement was developed: the stakeholders need to quantitatively analyze the MCM effectiveness involving the capability to clear a minefield and the ACRS between the current and planned MCM capabilities to base procurement and planning decisions. The problem statement was then refined from this effective need.

Once the effective need was determined, the MIW Team transitioned to identifying the stakeholders' capability needs. This was essential to develop the MCM problem set into a manageable, focused effort as described in the problem definition.

3. Capability Need Statement

According to PEO LMW (2014) and the Joint Chiefs of Staff (2011) the DON needs to have an effective and responsive defensive MCM capability in order to ensure “successful maritime and joint force access and power projection, and is essential to the protection of shipping, friendly forces, and noncombatants” (Joint Chiefs of Staff, 2010, 1-1). Keeping the SLOC clear is necessary to support safe commerce, enable naval maneuverability, and maintain the ability of the U.S. Navy to project power from the sea. Clearing littoral regions is necessary to support beach landings and amphibious assaults. There are many scenarios in which areas need to be cleared of sea mines and, as described in Chapter I, each one presents significant challenges to the overall MCM operation. Furthermore, with the current fiscal environment and reductions in force, this capability must be effectively and efficiently operated without excess personal requirements and costs. Moreover, there is a requirement to conduct effective MCM missions with minimal risk to the lives of the service men and women controlling the MCM systems and platforms (DON 2010; PEO LMW 2009, 27; Secretary of Defense 2014).

The MIW Team developed the problem statement based on the project goals and constraints as identified by the stakeholders. This more focused problem statement allowed the project goals and objectives to take form in a manageable project that could be completed within the constraints contained within the next section.

4. Problem Statement

As described in the first paragraph of this section and in Section 3, the DON needs to have an effective defensive MCM capability that can be conducted in a manner that improves safety for sailors and the ships they operate (PEO LMW 2009). The DON stakeholders need quantitative data for evaluating the effectiveness of future MCM capabilities, the core of which is the LCS, as compared with the legacy MCM capabilities, the core of which is the MCM 1 (DON 2010). Since each ship conducts the MCM mission

differently, the MIW Team based the comparative analysis on a common mission scenario profile: mine clearing a rectangular area (10 NM by 10 NM) that would be within a SLOC. This evaluation was primarily based on the ACRS metric for each ship type over a 24-hour period. Additionally, the mine clearance effectiveness as represented by the percent clearance metric was analyzed to provide a comparison between the MCM platforms in both time to conduct the mission and the mission effectiveness.

Initially, the MIW Team pursued a study that would comprehensively evaluate all MCM functionality in the performance of multiple mission types. Due to the constraints to use unclassified data and the time required to complete the study, the MIW Team had to revise the original project scope. After extensive research and guidance provided by Admiral Richard Williams and Professor Eugene Paulo on 16 May 2014, the MIW project team updated the problem statement and project focus, with favorable results.

C. REQUIREMENTS

According to Beude (2000), requirements for a system address the needs of the stakeholders. These initial requirements are the originating requirements, which focus on the boundary of the system in the context of the mission and use the stakeholder terminology (Buede 2000). As first discussed in Chapter II, the goal of the requirements analysis for this project was to produce a set of high level requirements for the models that, when met, adequately describe the MCM system functions relevant toward meeting the stakeholders' effective need to quantitatively analyze legacy and future MCM effectiveness. Taken in this context, the system requirements for this project outline the need for a MCM comparison method, or model. The extent to which the MCM functional and physical system architectures, as described in Chapter IV, relate to the system requirements for generating a model is characterized by those parameters which the model must utilize or describe. That is, while traditional system development provides a direct mapping from system to functional to physical requirements, this project dictates not that a system be developed but rather that a tool be created to simulate systems that perform defined functions with existing physical architectures in order to analyze their performance. Therefore, the purview of the system requirements is to define the scope of the model and

not to specify MCM system performance. Given the stakeholder analysis and needs analysis the originating requirements were:

- R.1 An unclassified model shall be developed to determine the operational effectiveness of the LCS versus MCM capabilities
 - R.1.1 The model shall take unclassified inputs for various performance parameters for the LCS and MCM to enable sensitivity Analysis
 - R.1.1.1 The model shall use best estimates of input factors in cases when real values are unavailable
 - R.1.2 The model shall identify parameters with high predictive power (relative to other parameters)
 - R.1.3 The model shall use an operationally relevant situation as the basis of comparison, focusing on system effectiveness in a SLOC scenario
- R.2 The model shall provide quantitative estimates of overall mine clearing effectiveness
 - R.2.1 The model shall produce a metric of ACRS
 - R.2.2 The model shall produce a metric of percent clearance to evaluate the minehunting effectiveness.

These originating requirements were translated into top-level system requirements for the model, in the correct terminology. There are five top-level requirements for the study and for the development of the models and simulations necessary to complete the analysis. Table 3 lists the requirements and the type of requirement, the description of each follows the table.

Table 3. Requirements

Number	Requirement	Type / MOE Mapping
1.0	The simulation shall enable the determination of the ACRS for each MCM configuration in the performance of mine hunting.	Top-Level
1.1	The simulation shall represent the time required to perform each minehunting function within the minehunting operation: travel, detect, classify, identify, reacquire, and neutralize for each MCM configuration.	ACRS
1.2	The simulation shall calculate the ACRS (time required to conduct the entire minehunting sequence).	ACRS
2.0	The simulation shall model the effectiveness of each minehunting function.	Top-Level
2.1	The simulation shall calculate and store the effectiveness of each	Percent Clearance

Number	Requirement	Type / MOE Mapping
	minehunting function.	
2.2	The simulation shall calculate and output the overall minehunting effectiveness in terms of the number of mines cleared, number of mines remaining, and the number of non-mines that were neutralized.	Percent Clearance
3.0	The simulation shall contain models of the minehunting sequence of events for the different configurations.	Top-Level
3.1	The simulation shall represent each of the three MCM configuration's minehunting functions: search, detect, classify, identify, reacquire, and neutralize.	ACRS and Percent Clearance
3.2	The simulation shall represent the minefield size and location for use in the effectiveness and ACRS calculations.	ACRS and Percent Clearance
3.3	The simulation shall transition the state and minehunting results of the previous function to the subsequent function IAW PEO LMW Instruction 3370.1A.	ACRS and Percent Clearance
4.0	The simulation shall support setting and modifying the listed performance parameters without requiring modifying the simulation.	Top-Level
4.1	The simulation shall import specified input parameters without requiring modifications to the code.	Non-Functional
4.2	The simulation shall support the export of the resulting effectiveness and time-to-complete parameters to a form that can be analyzed by statistical software products such as Excel and Minitab.	Non-Functional
4.3	The simulation shall be developed in a modular method that allows for each function to be replaced.	Non-Functional
5.0	The simulation shall include documentation that facilitates the use of the simulation tool by future study groups.	Top-Level Non-Functional
5.1	The simulation shall include documentation that describes the use of the code and descriptions of the input and output parameters.	Non-Functional
5.2	The simulation shall include documentation that describes the code, the structure of the code, and the required inputs and outputs of each functional block.	Non-Functional

- Requirement 1.0: Determine the ACRS for each MCM configuration in the performance of mine hunting.

The top-level requirement was to calculate the ACRS of each configuration based on specified performance parameters. The calculation of the ACRS supports one of the MOEs described in Chapter I. This requirement was decomposed into two lower-level requirements.

- Req. 1.1: The simulation shall represent the time required to perform each minehunting function within the minehunting operation: travel, detect, classify, identify, reacquire, and neutralize for each MCM configuration.
- Req. 1.2: The simulation shall calculate the ACRS (time required to conduct the entire minehunting sequence).
- Requirement 2.0: The simulation shall model the effectiveness of each minehunting function.

As with the time to complete measure, the effectiveness of each function had to be represented; therefore, the following requirements were derived. The overall effectiveness was measured as the percentage of mines cleared from the minefield, which is a function of the performance of each function involved in the minehunting operation.

- Req. 2.1: The simulation shall calculate and store the effectiveness of each minehunting function.
- Req. 2.2: The simulation shall calculate and output the overall minehunting effectiveness in terms of the number of mines cleared, number of mines remaining, and the number of non-mines that were neutralized.

In order to satisfy the above requirements, the MIW Team had to build a simulation to use as a basis for the comparison. The next set of requirements reflects the objective for the tool, that is, to represent the minehunting functions in a modular manner that provides the ability to replace functional modules. For future studies, it will be necessary to completely replace some functions with those having alternative attributes and operations. To be useful, the structure of the simulation had to be modular to support the ease of use and modification in the future. Two requirements were developed to decompose this objective.

- Requirement 3.0: The simulation shall contain models of the minehunting sequence of events for the different configurations.

As stated, this project evaluated three different MCM configurations; therefore, the performance and operation of the different systems for each had to be represented in the simulation. This single requirement was decomposed into three requirements. Requirements 3.1 and 3.3 deal with the modeling of the MCM functions and transition of results from one function to the next and requirement 3.2 was required to allow for the specification of the mine field size and location.

- Req. 3.1: The simulation shall represent each of the three MCM configuration's minehunting functions: search, detect, classify, identify, reacquire, and neutralize.
- Req. 3.2: The simulation shall represent the minefield size and location for use in the effectiveness and ACRS calculations.
- Req. 3.3: The simulation shall transition the state and minehunting results of the previous function to the subsequent function IAW PEO LMW Instruction 3370.1A.

There was a requirement to represent the minehunting functions in a manner that supports varying the performance capabilities of the represented functions to support excursions and “what if” analyses. The MIW Team determined that a simulation that was capable of using tables and/or databases containing the many input parameters would best satisfy this objective. Three requirements were developed to decompose this top-level requirement.

- Requirement 4.0: The simulation shall support setting and modifying the listed performance parameters without requiring modifying the simulation.

As stated, this project evaluated three different MCM configurations; therefore, the actual performance parameters of the different MCM systems and subsystems were unavailable. In order for the model to be useful, the tool needed to have a way to allow for relatively easy manipulation and modification of the many parameters that affect the effectiveness and ACRS for the minehunting operation. The following lower-level requirements decompose this top-level requirement.

- Req. 4.1: The simulation shall import specified input parameters without requiring modifications to the code.
- Req. 4.2: The simulation shall support the export of the resulting effectiveness and time-to-complete parameters to a form that can be analyzed by statistical software products such as Excel and Minitab.

This requirement was needed to specify that the calculated performance parameters had to be exported for evaluation in standard tools.

- Req. 4.3: The simulation shall be developed in a modular method that allows for each function to be replaced.

This requirement relates to best practices for developing code, the modular nature of the simulation not only enables future users the ability to modify it, but also allows for easier debugging.

The last top-level requirement pertains to the documentation necessary to allow the simulation tool to be used in future studies.

- Requirement 5.0: The simulation shall include documentation that facilitates the use of the simulation tool by future study groups.

Appropriate documentation was required that specifies the way the simulation was developed and the way in which the parameters can be varied. Without this docu-

mentation, the tool would be useless for further studies. Two requirements decompose this top-level requirement.

- Req. 5.1: The simulation shall include documentation that describes the use of the code and descriptions of the input and output parameters.
- Req. 5.2: The simulation shall include documentation that describes the code, the structure of the code, and the required inputs and outputs of each functional block.

1. Verification of Requirements

The team verified the results to ensure the project met the requirements. Most of the requirements (requirements 3.x, 4.x, and 5.x) were verified through inspection to visually check that the requirements were met. Requirements 1.x and 2.x were verified through comparison between an Excel model and the ExtendSim models. Test cases were modeled in Excel in which the effectiveness and time-related factors were used to compute the ACRS and Percent Effectiveness values. These values were compared to the simulation results to indicate that the calculations and sequence of events were represented correctly. Chapter VI contains the detailed results from the verification and validation of the simulation in achieving the above requirements.

D. REQUIREMENTS ANALYSIS SUMMARY

This study was to conduct a comparative analysis of the ACRS metric as applied to defensive MCM operations employed to clear an area within a SLOC in deep water for the MCM 1 and the four variants of the LCS class ships. Once the problem was defined and the project focus identified, the context in which the MCM operations occur, including the relationships between the entities, was defined. This step helped to further bind the problem space. The material within this section of the report describes the process with which the MIW Team defined the problem and scoped the project as part of the SE process used to conduct the study. Once concurrence was provided in the approach as outlined in this section, and IAW the SE approach, the MIW Team initiated the operational analysis. This analysis detailed the MCM operational concepts and the scenarios to be modeled and studied as part of the comparative analysis.

IV. SYSTEMS ARCHITECTURE

A system architecture for each of the MCM systems is detailed in this chapter and provides fidelity to a model structure as it relates to various MIW systems. As stated by Blanchard and Fabrycky (2011), “Given an identified need for a new improved system, the advanced stages of system planning and architecting can be initiated. Planning and architecting are essential and coequal activities for bringing a new or improved capability into being” (58). Though this research project did not involve the physical development of a new system, it did involve the development of simulations to represent the actual systems for the conduct of the analysis. Therefore, the conceptual needs that were antecedent to the actual MIW systems (both legacy MCM 1 and future LCS) and their resultant system architectures were necessary in order to understand the system on which this project was based. Moreover, a thorough understanding of the system architecture was required in order to trace the component functional and physical architectures to their specific system functions, which were studied during this project. The goal was to gain an understanding of the MIW systems from a SE perspective, versus attempting to construct a new MIW system, in order to develop a model for MCM analysis.

This chapter contains the contextual description for the MCM system, the functional architecture, physical architecture, and the requirements. Additionally, the MOEs and MOPs are described and mapped to the system’s objectives and the requirements. These definitions were necessary to develop the approach to, and structure of, the simulations that were used to conduct the analysis.

A. SYSTEM CONTEXT

As described, MCM requires the operation and interaction of many systems. These systems need to perform the various functions of detection, classification, identification, neutralization, control, movement, and communications. As these systems are integrated to function as part of the larger MCM capabilities, performing MCM requires a system-of-systems (SOS).

Before developing the functional decomposition for the MCM SOS, it was necessary to define the system boundaries and the context within which the MCM system operates. This section begins with a top-level view of the MCM system context and then describes the portion of the system that is the focus of this study. The overall system boundaries or scope of the project is focused on understanding the functional capabilities of legacy MCM systems and comparing them to the future MCM capabilities as the enterprise transitions to new MCM systems.

Figure 11 displays the MCM SOS context diagram. Shown in the diagram are the external factors that affect, or are affected by, the MCM SOS. The SOS terminology is used because the MCM systems and sub-systems of each MCM platform are independent systems that are functionally linked in performing MCM operations.

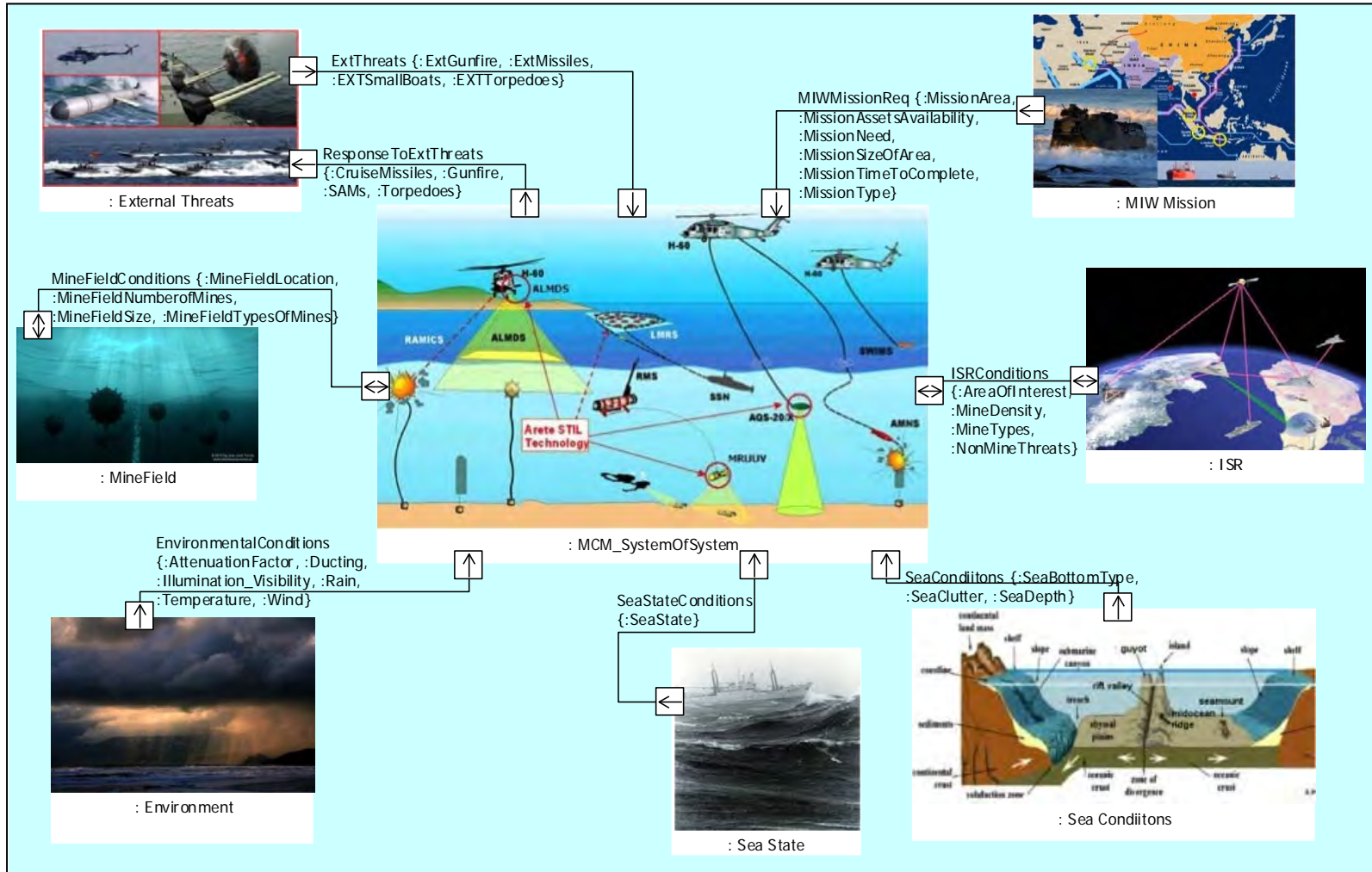

Figure 11. MCM SOS Context Diagram

The MCM mission or operation (as seen in the upper right corner of Figure 11) is initiated by orders to commence operations. These orders involve the area of interest, the assets that can be made available to conduct the operation, the need (requirement) for the particular MCM operation (e.g., the clearance type, type of support required), the amount of time in which the MCM operation has to be completed, and the mission type (e.g., exploratory, reconnaissance, breakthrough, clearing, attrition). This information informs the MCM commander of the requirements for the mission so that he/she can determine the appropriate course(s) of action (e.g., whether to perform minesweeping, minehunting, or both, or whether to investigate and mark the area as dangerous or safe). This also determines the functions that are to be performed and allows for the selection and sequencing of the proper MCM systems to employ based on the operational conditions and circumstances. Based on SME feedback, this study assumed that the mission requirements were for mine clearing of a limited area in deep water using minehunting in a SLOC.

Moving clockwise through the figure from MCM mission description, it shows that ISR also provides valuable data to the MCM operation such as the area of interest, the density and types of mines, and other non-mine threats that the assets must evade. This is a two-way link because the MCM SOS will provide updated intelligence regarding the area(s) as it conducts its operations. None of the ISR capabilities were included in this study.

The sea conditions also affect the MCM operations. The depth of the sea, the clutter, and the type of bottom directly impact the performance of the MCM systems and therefore the overall effectiveness of the MCM SOS. None of these elements are being varied within this study.

In addition to the sea conditions, the sea state conditions contribute to the overall effectiveness and operation of the MCM systems. Some systems likely cannot be operated in certain conditions or their effectiveness will be adversely impacted in high or low sea state conditions. This study assumed a steady-state sea condition during operation; therefore, the impacts of varying sea states were not evaluated.

Not only do the conditions of the sea affect the MCM operations, but the environment will also play a role in the operation and effectiveness of the MCM SOS. The sea state is directly correlated to wind, but there are other factors that may impact the MCM SOS. These include the amount of ducting and environmental attenuation, which affects the communications between the MCM systems, the MCM platform, and other assets. The visibility, rain, and temperature may also affect the way in which the MCM operation is conducted. Environmental factors were not included in this study.

The mine fields and their conditions both impact and are impacted by the MCM SOS. The location and size of the mine field will directly impact the operations due to range limitations of the various MCM systems and the amount of time required to clear the area. Additionally, the actual number and types of mines (as opposed to the suspected conditions provided by the ISR data) obviously impact operations. Different mine types and mine densities directly impact the operational effectiveness of the MCM SOS as well as the time to complete operations. This link is bidirectional due to the impact on the mine field as the MCM SOS begins clearing mines. Again, this study only accounted for a fixed mine field area containing bottom mines with the numbers and densities modeled as variable parameters.

Finally, the MCM SOS and all assets supporting the MCM operation are affected by, and affect, the external, non-mine threats in the area. These include threats from guns, missiles, small boat attacks, and torpedoes. In the conduct of the mine clearance operation, the ships' commanders must watch for and respond to these external threats. The threats are affected by the response provided by the MCM platforms including guns, missiles (both cruise and surface-to-air), and torpedoes. No external threats were accounted for within this study.

B. FUNCTIONAL DECOMPOSITION

The next step in defining the architecture was to develop the functions that are performed in MCM operations. The definition and decomposition of the functions resulted in the functional architecture for the MIW project. This section describes the functional architecture.

1. MCM Operational Functions Overview

MCM operations are determined by MCM missions, which in turn are described by MCM functions that are characterized by specific MOPs. MCM functions and MOPs are described in detail in this section. In PEO LMW Instruction 3370.1A (PEO LMW 2008), active defensive MCM MOPs are divided into four functional areas: sense, engage, control, and logistics. These functional areas are described in detail in Chapter I. Operational C4ISR functions are not explicitly addressed due to the constraints within which the study was conducted.

2. Top-Level Functional Description

As introduced in Chapter I, the basic functions of MCM operation include: detection, classification, identification, and neutralization. The top-level view of the MCM functions in the form of a functional flow block diagram (FFBD) is shown in Figure 12. During detection (sometimes referred to as sensing), the system searches for and records, or transmits, mine-like echoes (MILECs), which are indications of possible mines. These MILEC items are then interrogated with higher resolution in order to classify them as either MILCOs or non-MILCOs and this information is then passed to the next stage: identification. The systems that perform the identification function may first have to reacquire the MILCO signals and then resolve the objects to identify each as either a mine or a non-mine.

An important characteristic that mine hunters use to determine if a moored MILCO is suitable for identification is the contact persistence of the MILCO. If the contact is persistent to sensors, with respect to time, or persistent through multiple interrogations of the same area, this factor weighs heavily on a MILCO being selected for identification. For bottom mines, it is more important that the search tracks be chosen to ensure MILECs are within the range of classification systems. Once an object has been detected and classified as a persistent MILCO, identification is used to identify a MILCO as a mine. Once an object has been identified as a mine, the MCM platform (ship or aircraft) attempts to determine the type of mine.

The identification stage in the mine hunting chain of events usually happens just before a mine is neutralized, but if a mine is identified as a new type of mine, the mine can be designated for exploitation (where the mine is captured for analysis). This process continues as mines are either exploited or subsequently neutralized in order to clear the mine field of mines to make the waterway safe for follow-on forces or as dictated by the mission. The information regarding the identified mines, specifically their location and type (if resolved), is sent to the next function, neutralization, to clear the mines. The neutralization function may reacquire the mine contacts and then either destroy the mines or render them safe for collection and exploitation. Not shown in Figure 12, but very relevant to the effectiveness of mine clearance operations, are the reacquiring functions that must occur when the signals from one function have to be transferred to another system to perform the next function; it is assumed, at this top-level, that the reacquisition of the signals is accomplished within the function receiving the signals.

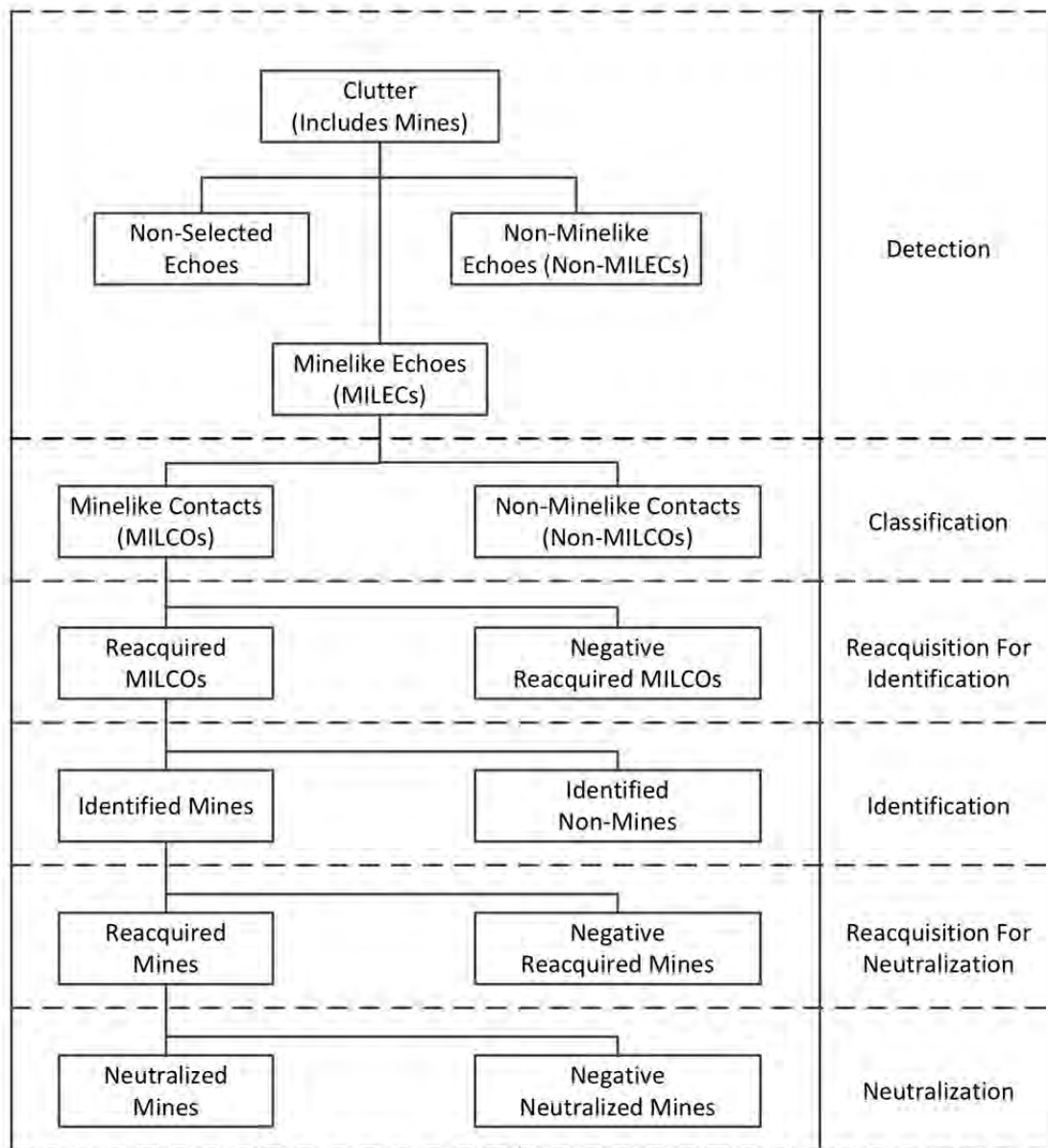
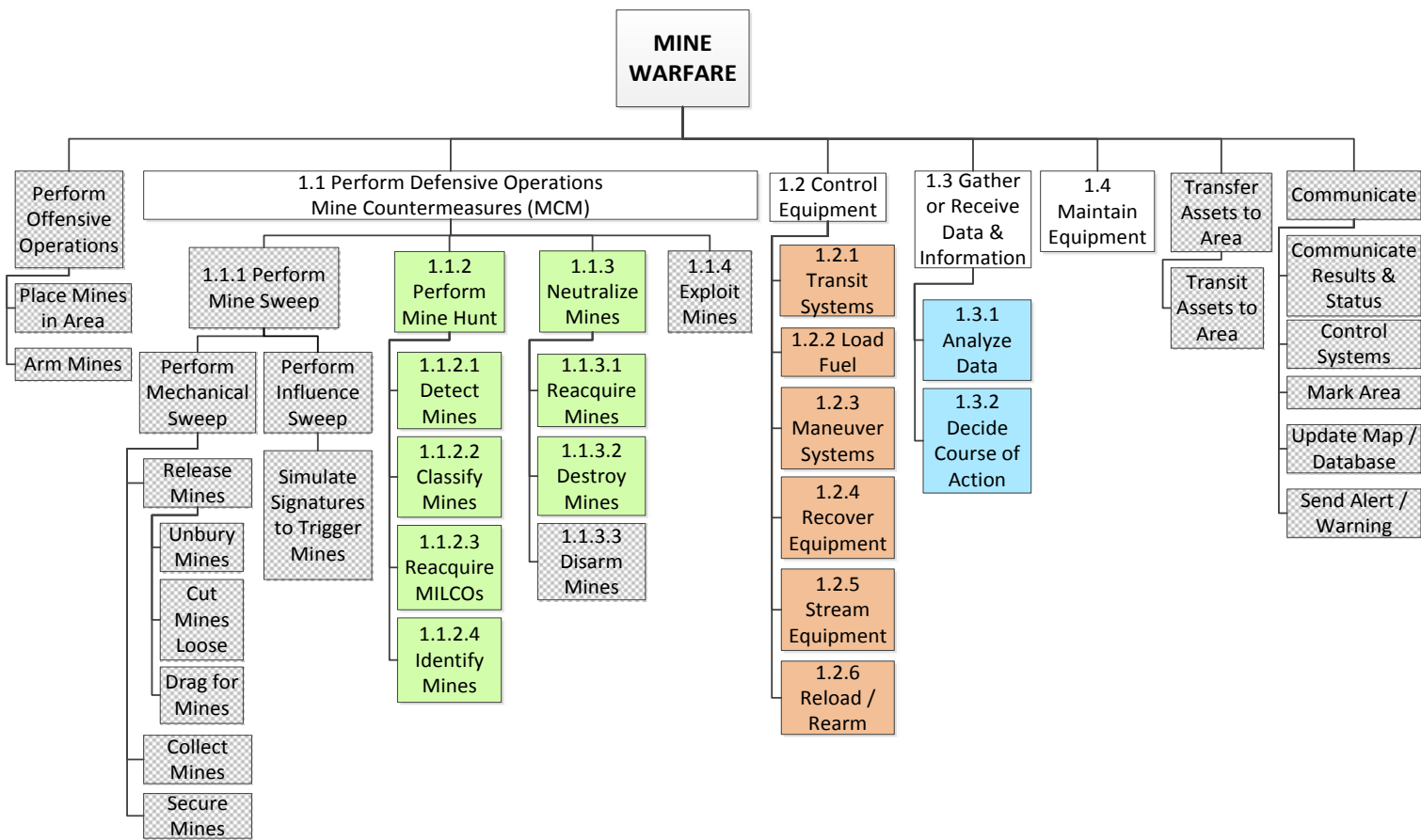

Figure 12. Defensive MCM Functions—The Top-level FFBD View of the MCM Functions (from PEO LMW 2008)

Two primary approaches are used to accomplish these functions: minehunting and minesweeping, although each performs the MCM functions differently. In minehunting, each function is accomplished sequentially and generally results in a higher probability of mine clearance. Minesweeping operations are primarily focused on the neutralization function and skip the detect-classify-identify functions so they can be accomplished

much faster. There are missions where minesweeping is performed first (especially for surface mines) and then followed by minehunting, and others in which minehunting and minesweeping occur simultaneously.

As described in previous sections, this study will focus on minehunting operations in deep water (water depths greater than 200 feet). For completeness, the functional hierarchy for MIW is shown in Figure 13. The MIW functions that are beyond the scope of this study are in grey. The primary functions associated with minehunting are shown in green. Other functions that are necessary to include in order to capture and analyze the ACRS for the operation are the control equipment functions (shown in orange) and the analyze function data (shown in blue). This last function is referred to as PMA and is described in Section B. Additionally, the maintain equipment function will be considered, as the A_O affects the ACRS and the conduct of the mission. It is important to note that those functions not directly associated with the primary minehunting functions are of interest due to their impact on the time required to conduct and complete the minehunting operation.



Note: These functions are not included in this study.

Figure 13. MIW Functional Hierarchy (after PEO LMW 2008)

3. Minehunting Functional Description

Figure 14 displays the functional hierarchy involved with minehunting operations. Again, those functions in grey are not included in this study. The descriptions of those functions that are included in the study are detailed in this section.

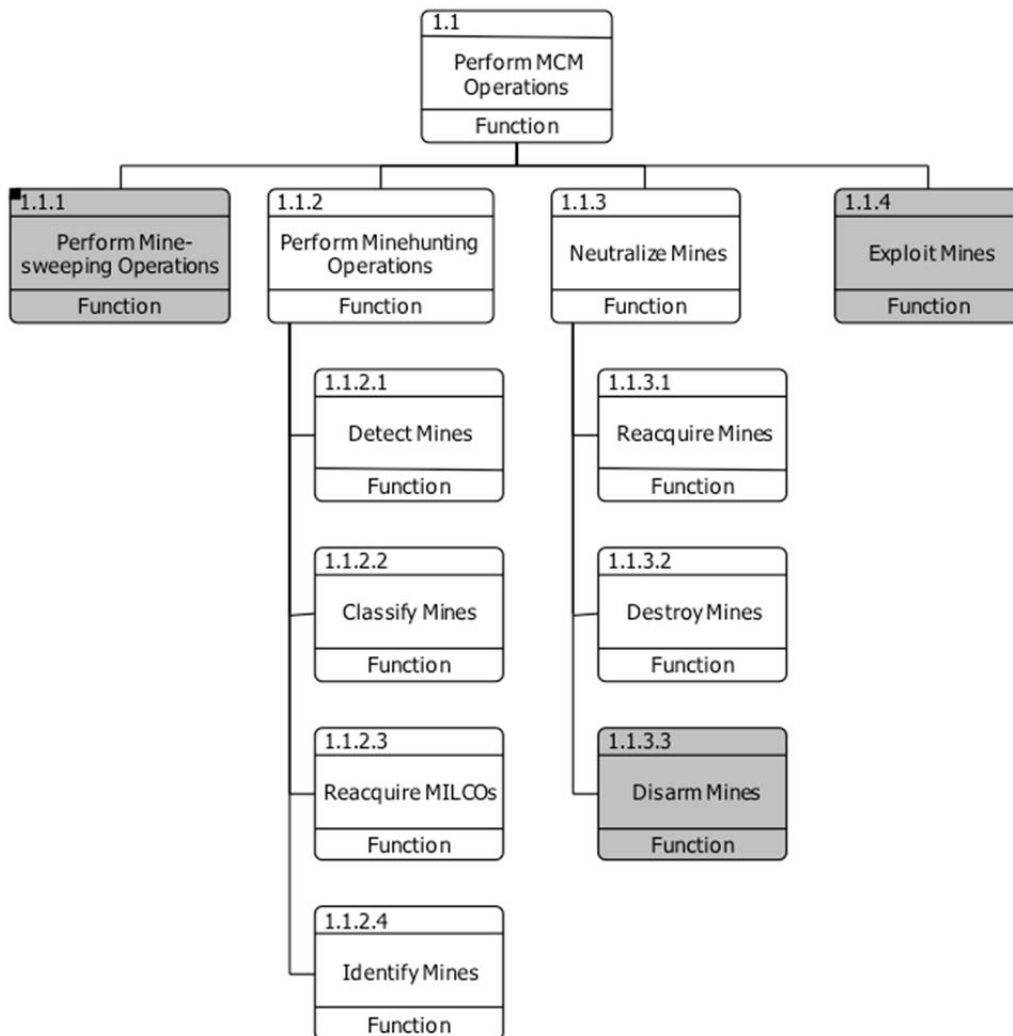

Figure 14. Minehunting Functional Hierarchy

a. 1.1.2.1 Detect Mines

The first step in mine hunting is to detect mines and MILECs. This is usually performed through sensing, in which sensing systems detect the returns from the mines, sea-floor, and other objects. This can be extremely challenging and is dependent upon the sea state, the depth of the water, the conditions of the sea floor, and the materials used to build the mine. Humans, mammals, or sonar systems can perform this operation. Once the detection of the area is complete, the system will report that it either detected or did not detect possible mines in the area. If no possible mines are detected, these results are communicated to the personnel and platforms in the area and the system moves to the next mission area. Objects that are detected are designated as MILECs. These MILECs are passed to the next function for classification.

b. 1.1.2.2 Classify Mines

Once objects have been detected and designated as MILECs, they must be classified as either a MILCO or a non-MILCO based on the sonar image of the MILEC. This function is performed to determine which MILECs have a high probability of being a mine. This information is used to direct assets (systems) to further interrogate those objects to determine which are mines and which are not mines.

c. 1.1.2.3 Reacquire MILCOs

This reacquisition function is only performed when a different system is used in the next phase, identification. This function involves the tasks to search for and find the MILCO signal sources so that they can be investigated and identified as mines or non-mines.

d. 1.1.2.4 Identify Mines

The identification process will further interrogate the MILCO objects to determine if they are mines or non-mines. At this point non-mines are designated as false targets. The type and location of the mines are then communicated to the supporting platform and the other ships in the area. The Mine / Non-Mine information is then used to direct neutralization assets and to mark the area as a minefield to warn other vessels.

e. 1.1.3 Neutralize Mines

This function involves rendering the mines impotent so that they cannot cause damage. This can be accomplished by destroying the mines or by disarming the mines. Disarming mines may be necessary if the U.S. Navy desires to collect the mines for study and analysis. In this study, the focus is on destroying the mines.

f. 1.1.3.1 Reacquire Mines

Similar to function 1.1.2.3 (Reacquire MILCOs), this reacquisition function is performed when a different system is used for neutralization. Again, this function involves the tasks to search for and find the mine signal sources so that they can be neutralized.

g. 1.1.3.2 Destroy Mines

The mine destruction function involves making mines safe so that their explosions do not cause damage or harm. There are a number of ways to destroy mines, dependent upon the type of mine, the location of the mine, the destruction capabilities present, and the speed with which the mines must be destroyed. In this study, the focus was on destroying the mines through a neutralization system and not with a sweep system, as described in Section C.

4. Other Functions Related to Minehunting

In addition to the minehunting functions, the simulation had to account for the time delays imposed on the completion of the mine clearance mission due to movement of the equipment and the analysis of the signals data from the minehunting systems that is necessary to determine the next course of action in a minehunting operation. These functions are described within this section.

a. 1.2 Control Equipment

The functions decomposing this top-level function involve the actual movement of the MCM systems to the correct location, as well as the functions necessary to ensure each system is configured properly and is fueled. These functions were important to

model as each contributes to the amount of time that is captured in the ACRS metric. The hierarchy for these functions is shown in Figure 15.

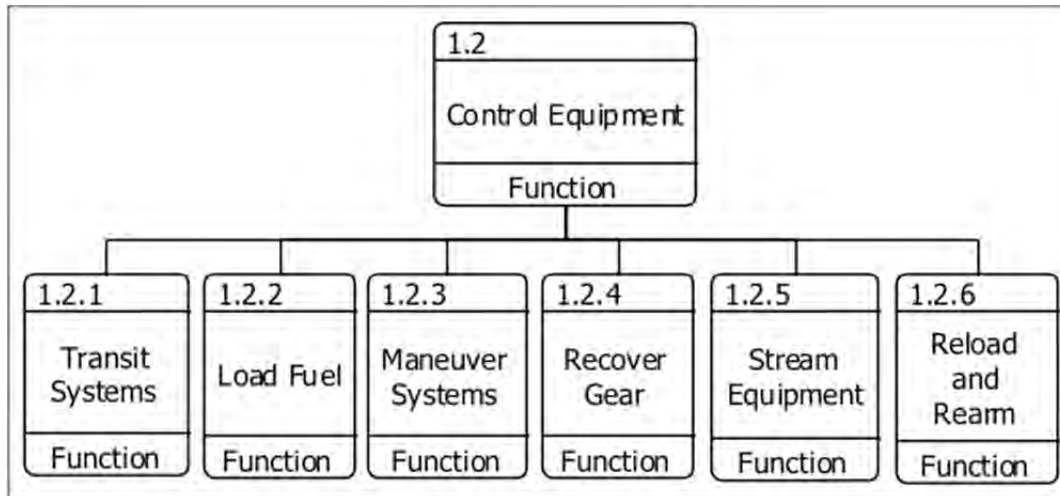

Figure 15. Control Equipment Functional Hierarchy

b. 1.2.1 Transit Systems

This function involves the tasks necessary to move the appropriate system between the staging area and the minefield of interest.

c. 1.2.2 Load Fuel

This function involves the critical tasks of loading fuel onto the systems so that each system can perform its tasks.

d. 1.2.3 Maneuver Systems

This function involves the tasks necessary to put the systems in the right altitude, longitude, latitude, and depth such that the tasks performed by each system can be accomplished. This function also includes turning to the next track to continue operations.

e. 1.2.4 Recover Equipment

This function involves the tasks necessary to load the MCM systems onto the carrying and support platform. This is accomplished after each system has completed its

tasks and when the systems need to be refueled, rearmed, reconfigured, maintained, and repaired.

f. 1.2.5 Stream Equipment

This function involves the tasks necessary to configure and launch the appropriate MCM systems so that each can perform its tasks.

g. 1.2.6 Reload / Rearm

This function involves the tasks necessary to either reload or rearm equipment (e.g., armament, equipment) onto the MCM systems so that each can continue its tasks.

h. 1.3 Gather or Receive Data and Information

This top-level function involves the gathering or collecting of data and information regarding the minefield, to include: the types and quantities of mines, type and condition of the sea-floor, etc. Additionally, this function involves receiving the various signals from the MCM systems as they go through the detect-classify-identify-neutralize sequence of operations. The signals of interest (e.g., MILEC, MILCO, Mine) are processed and analyzed in this function to determine the appropriate course of action. This function was important to model as the time spent on receiving and analyzing the signal data contributes to the ACRS metric, which was analyzed for this study. Additionally, the probability that the analysis function will direct MCM neutralization assets to particular mines and/or MILCOs was required to develop the effectiveness MOE. The functional hierarchy for the gather/receive data and information functions is shown in Figure 16.

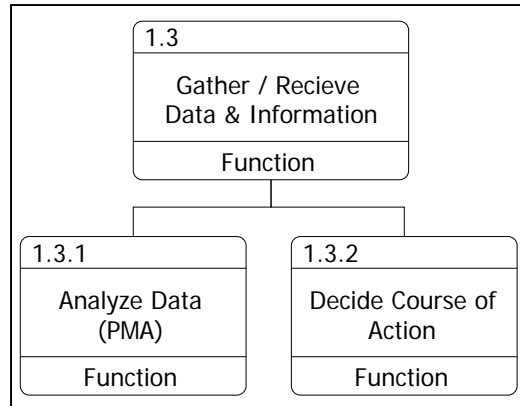

Figure 16. Gather/Receive Data and Information Functional Hierarchy

i. 1.3.1 Analyze Data

This function involves the PMA that is performed to determine the MILCOs that are most likely to be real mines. Although time-consuming, this crucial function in mine-hunting allows the MCM commander to expend precious resources wisely. The fidelity of the data from this function (from the PMA process and system) is much better than that of the signal processing capability on the MCM systems involved with classifying and identifying mines and MILCOs.

j. 1.3.2 Decide Course of Action

This function involves the processing of the analysis data from the PMA tool in the conduct of the analyze data function. The processed data will result in a recommended course of action for the MCM SOS. The human-in-the-loop decision-making process was not explicitly modeled in this study. The PMA results that determine the mines and non-mines were modeled using a probability distribution function to replicate the accuracy of the post-processing analysis.

k. 1.4 Maintain Equipment

This function involves the tasks required to maintain the MCM equipment so that it attains the highest possible operational time. This function was not modeled in the simulation, although including the related A_O for the different equipment in future studies

would provide more information in evaluating the ACRS metric. The functional hierarchy for this function is not shown as it was not modeled or analyzed within this project.

5. Functional Flow Block Diagrams and Descriptions

Once the functions were identified, defined, and organized, the interactions between the functions that were required in the conduct of the minehunting operation were developed. This step resulted in a number of FFBDs and enhanced FFBDs (EFFBDs). Due to the inclusion of the data transferred between functions, the EFFBDs allowed the MIW Team to analyze the functions and steps involved in minehunting operations and to define the detailed requirements for the models. The EFFBDs made it possible to develop a model that properly accounted for the necessary functions and parameters (variables) for the scenario being modeled. The EFFBDs further allowed for the development of the physical architecture as well as the model requirements.

a. Top-Level Minehunting Functions

Figure 17 displays a top-level EFFBD for functions involved with minehunting operations. The individual functions were described previously within this section. The basic flow begins after the MCM systems have transited to the minefield area and streamed the equipment. The system then goes through the minefield looking for MILECs. As the system gets to the end of the current track through the minefield, it must maneuver to the next track (shown in another EFFBD) to continue searching for MILECs.

The next function is reacquire MILECs, during which the MILECs transferred from the detect function are located. This is then followed by the classify function, which interrogates the MILEC sources to classify the signal return as either a MILCO or a non-MILCO. This is particularly important, as there could be thousands of MILECs transferred by the detect function, many of which are not mines. Through the elimination of as many non-MILCOs as possible, the MCM system can expend resources where they are most needed. The MILCO returns are sent to the next function, analyze data, which is also known as the PMA system. This system is able to more accurately resolve the signal returns from the classification function to further eliminate false targets. Additionally, the results of the analyze data function (or PMA) are processed to identify highly critical

mines that are the most dangerous due to their type and location and to assist with planning of the remainder of the MCM operations. Once the data has been analyzed and decisions are made, the remaining MILCO signals are sent to the reacquire MILCOs function for localization so they can be processed by the identify mines function. The identify mines function examines the sources of the MILCOs to determine which are mines and which are non-mines. These mine objects are then sent to the reacquire mines function to be located and sent to the neutralize mines function.

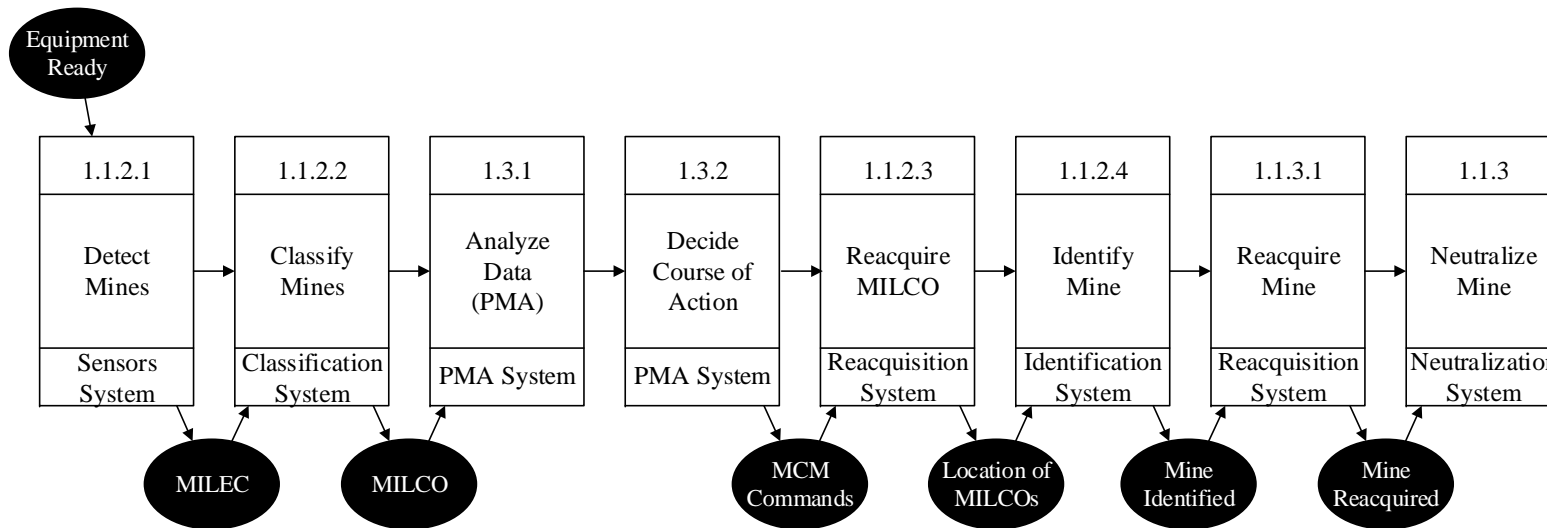

Figure 17. EFFBD for Minehunting Functions—Overview

These functions are repeated until the minefield has been cleared, with an acceptable probability that all mines have been neutralized, or until the MCM commander orders an end to the operation. Not shown in Figure 17 are the other functions involved that have to do with the movement, control, and maintenance of the MCM systems. Due to the project's focus on ACRS, these functions were important to define. The following sections and figures will describe these functions in more detail.

b. Transit Function

Figure 18 displays the EFFBD for preparing the equipment for MCM operations. Shown are the transit from staging area to minefield area function and stream equipment function. Once the equipment has been configured and put into the correct position, the equipment is ready. This green bubble indicates that this condition is a trigger that causes another function to activate.

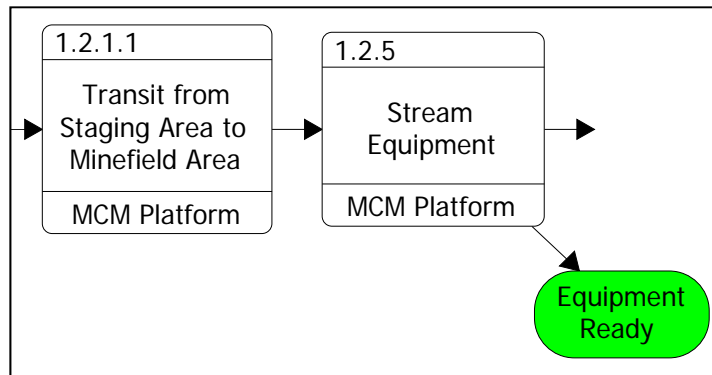

Figure 18. Prepare for Operations EFFBD

c. Detect Function

Figure 19 displays the first portion of the minehunting operations, the detect function. Once the MCM system maneuvers into position, the detect mines function is activated. Two items are output from the detect mines function: MILEC or Non-MILEC. The MILEC will trigger subsequent functions to resolve the signals to determine which are actually mines and which are not. At the end of the track, if the MCM detecting system has enough resources (e.g., fuel), it will loop back around, maneuver to the next track and

repeat the detecting function. If the MCM detecting system is out of fuel or requires maintenance, it will transit from the minefield to the staging area for service.

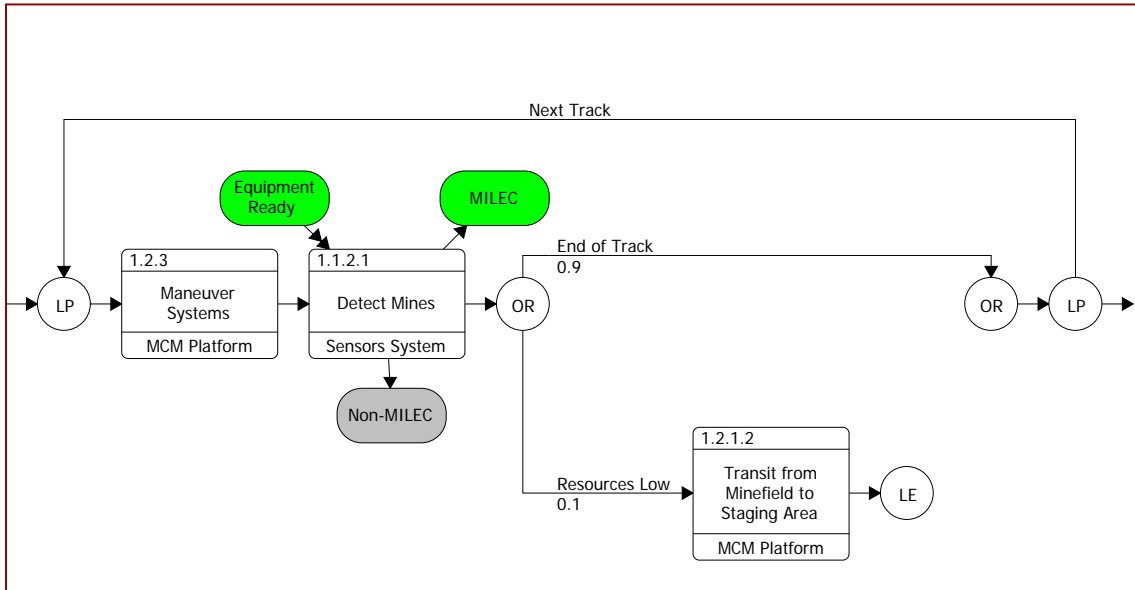

Figure 19. Detect Mines EFFBD

d. Classify and Analyze Functions

Figure 20 displays the EFFBD associated with the classify and analyze functions. Once the MCM system maneuvers into position, the reacquire MILECs function will attempt to locate the MILECs from the detect function. These reacquired MILECs are sent to the classify mines function to be interrogated in more detail. The classify mines function outputs non-MILCOs or MILCOs. The MILCO contacts are sent to the analyze data (PMA) function to be analyzed as previously described. The resultant information is passed to the decide course of action function for MCM planning information regarding highly critical MILCOs and high probability MILCOs.

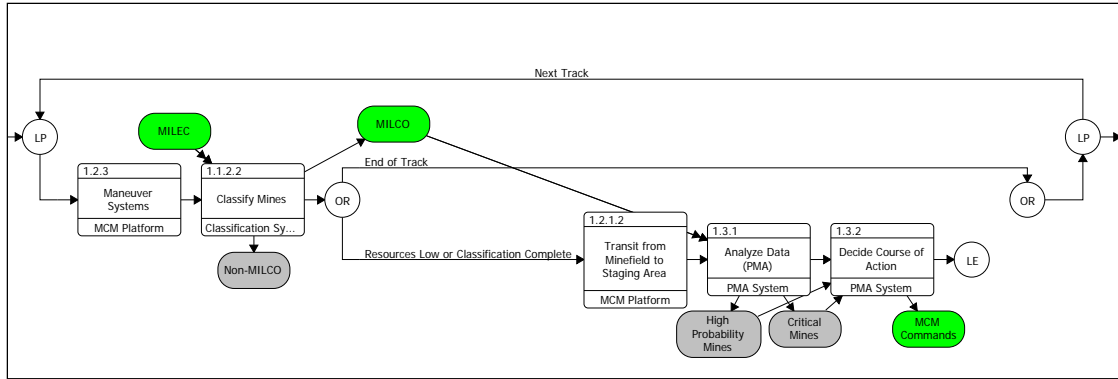

Figure 20. Classify and Analyze EFFBD

e. Identify Function

Figure 21 displays the EFFBD associated with the identify function. Once the MCM system maneuvers into position, the remaining MILCOs from the analyze function are sent to the reacquire MILCOs for contact location and then to the identify mines function. The outputs from the identify mines function are mines or non-mines. As with the detect function, once the identify mines function has reached the end of the track, it will proceed to the next track or location and the sequence will repeat. If the MCM system requires maintenance, service, or fuel, it will return to the staging area.

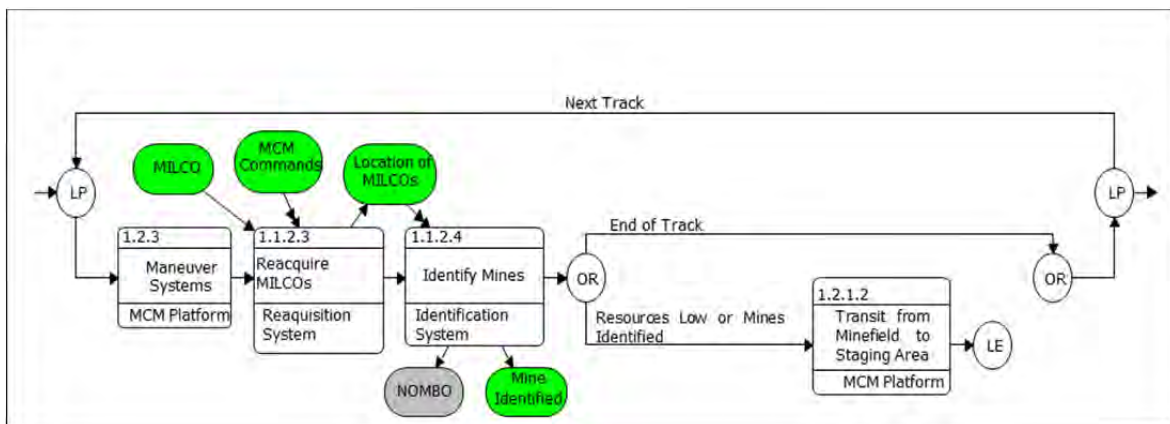

Figure 21. Identify EFFBD

f. Neutralize Function

Figure 22 displays the neutralize mines EFFBD. As in the previous stages, the system first maneuvers to position and then the reacquire mines function attempts to locate the mine objects that were identified by the identify mines function. Once located, the destroy mines function destroys the mines. Again, this sequence is repeated until the system performing the neutralization requires maintenance tasks, such as refueling or re-arming, at which time it returns to the staging area.

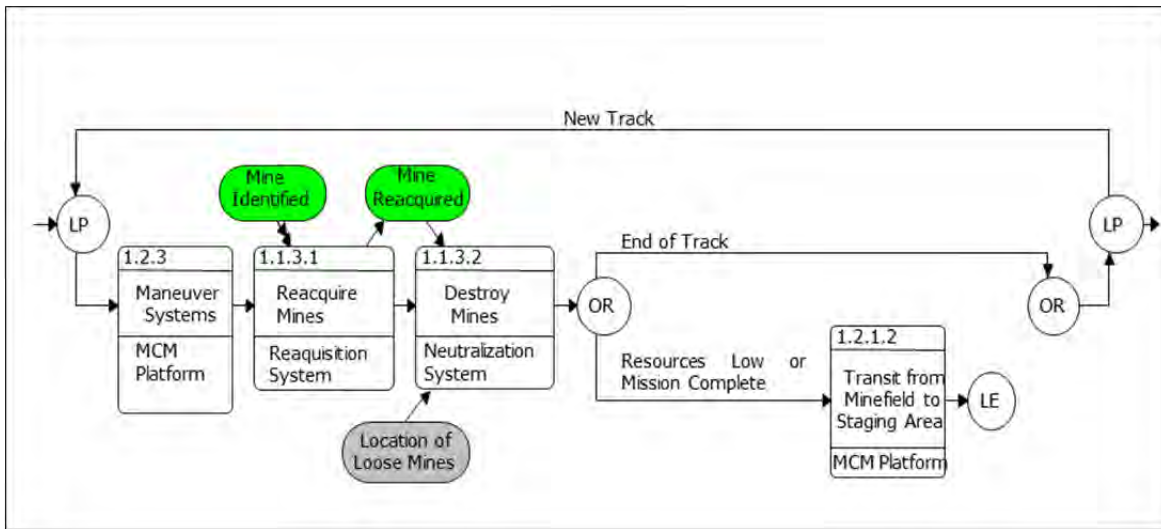

Figure 22. Neutralize Mines EFFBD

g. Control and Maintenance Functions

Figure 23 displays the EFFBD for the control and maintenance functions. Once the MCM system has transited from the minefield to the staging area, the recover gear function is initiated to reload the MCM system onto the support platform. At that time, dependent upon the system’s need, the platform will load fuel, reload and rearm equipment, and perform maintenance activities on the system as needed. Once all necessary service has been provided, the MCM system is again streamed so that it can transit back to the minefield to continue operating.

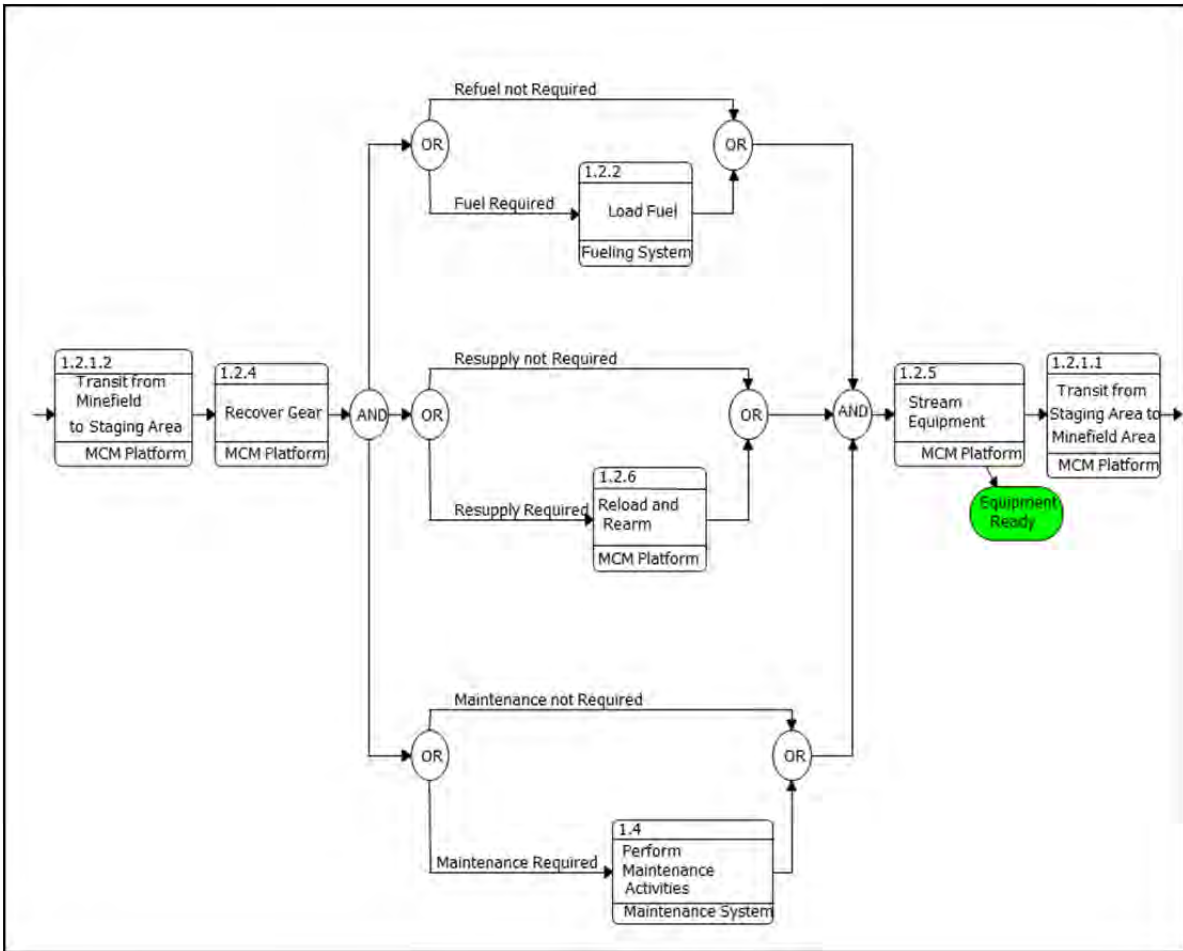

Figure 23. Control and Maintenance EFFBD

6. Conclusion of the Functional Architecture

The functional architecture was developed and refined to represent those functions of interest to this study of minehunting operations and capabilities within the predefined scenario. To verify the functional architecture was complete, the MIW Team used MBSE methods, specifically CORE's simulation capability, to ensure that all functions and data transfers were accurately represented. Once the functional architecture had been developed, using the FFBDs, EFFBDS, hierarchy, and decomposition, it was necessary to define and develop the physical architecture. As described in the next section, this involved mapping the physical systems to the functions ensuring that every physical entity had a function and vice versa. The physical architecture was then transformed into mod-

els that represent the functions and the configurations that are described in the physical architecture section.

C. PHYSICAL DECOMPOSITION

The MCM functions described above are performed by several systems. For the purposes of this report, MCM systems can be thought of as being legacy, future, or both. Figure 24 shows the first three levels of MCM Systems. As with the functional hierarchies, those systems not part of this study are colored in grey. As described in Section B, both legacy and future MCM systems consist of AMCM, SMCM, and UMCM systems.

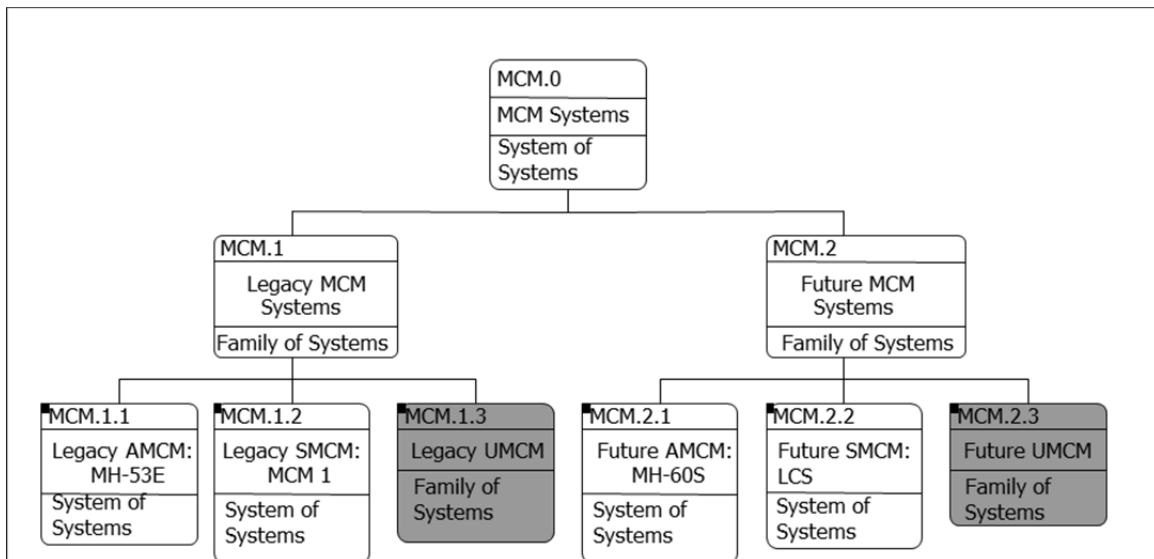

Figure 24. MCM Physical Systems Hierarchy

1. Legacy MCM Systems Operational View and Physical Architecture

Figure 25 shows a graphical depiction of the concept of operations (CONOPS) for the legacy MCM 1 MIW operations in terms of tasks, activities, operational elements, and data flow paths. It was necessary for the MIW Team to understand these details in order to develop the functional and physical architectures that led to the model design requirements and representation of the operational scenario under evaluation. Shown in Figure 25 is the MCM 1 ship platform towing the detection sonar systems through the minefield. Also depicted are the other support platforms that are required to support the

helicopter, MH-60S and MH-53E, with the AMCM equipment for detection and neutralization.

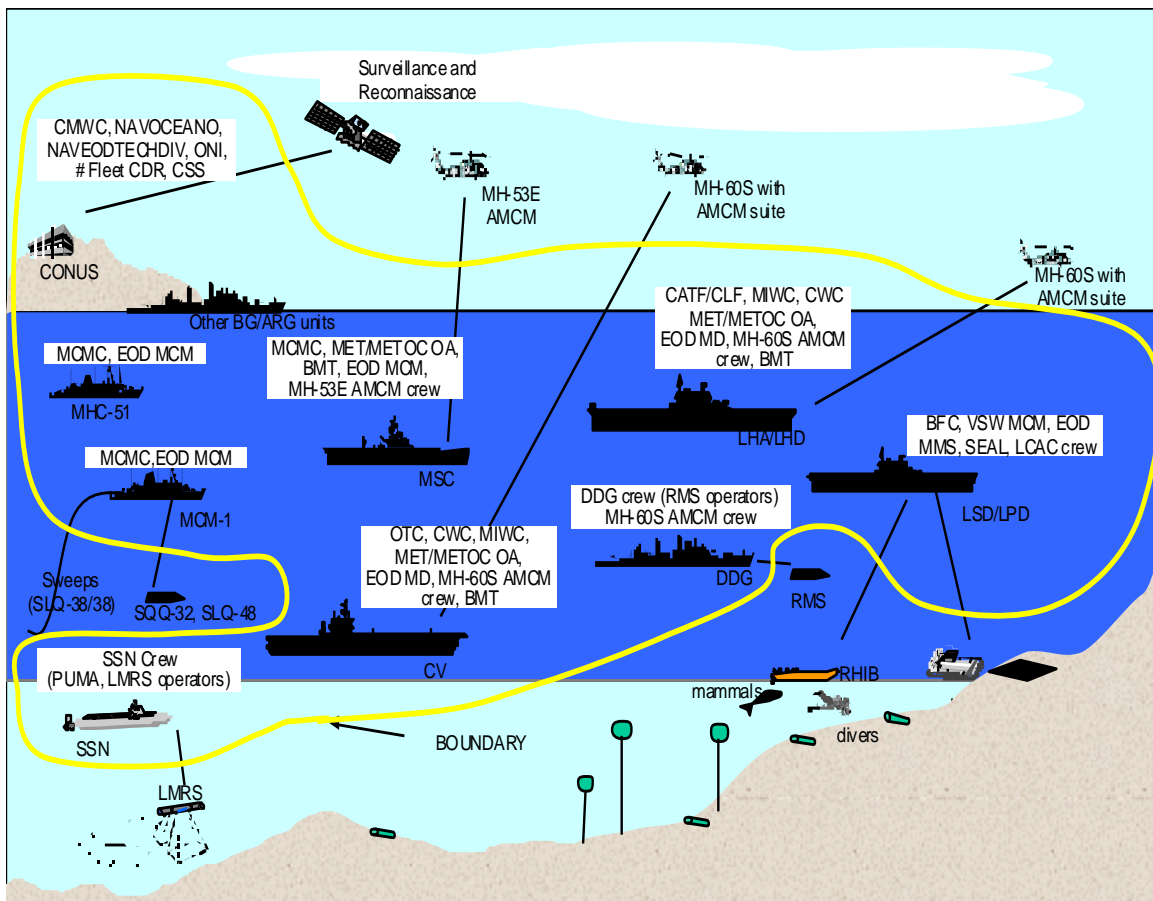

Figure 25. MCM 1 CONOPS (from MIW C4ISR 2001, Slide 14)

Once the airborne surface sweep systems clear the area of surface mines, the MCM 1 ships move through the minefield, towing the sensor equipment to detect mines. Once mines are detected, classified, and identified, they are either neutralized immediately or their locations are sent to other systems (airborne, underwater, and/or surface) to reacquire the contacts and then to neutralize the mines. There are many neutralization options available in this operational view including the MCM 1 platforms.

Figure 26 shows the legacy AMCM, SMCM, and UMCM family of systems broken down into their respective systems or systems of systems. The legacy AMCM, consisting of the MH-53E helicopter, contains both sensing (detecting) and neutralizing sys-

tems that carry out minehunting and minesweeping functions. Similarly, the legacy SMCM consisting of the MCM 1 ship contains both sensing and neutralizing systems. Legacy UMCM consists of the EOD divers and MMSs.

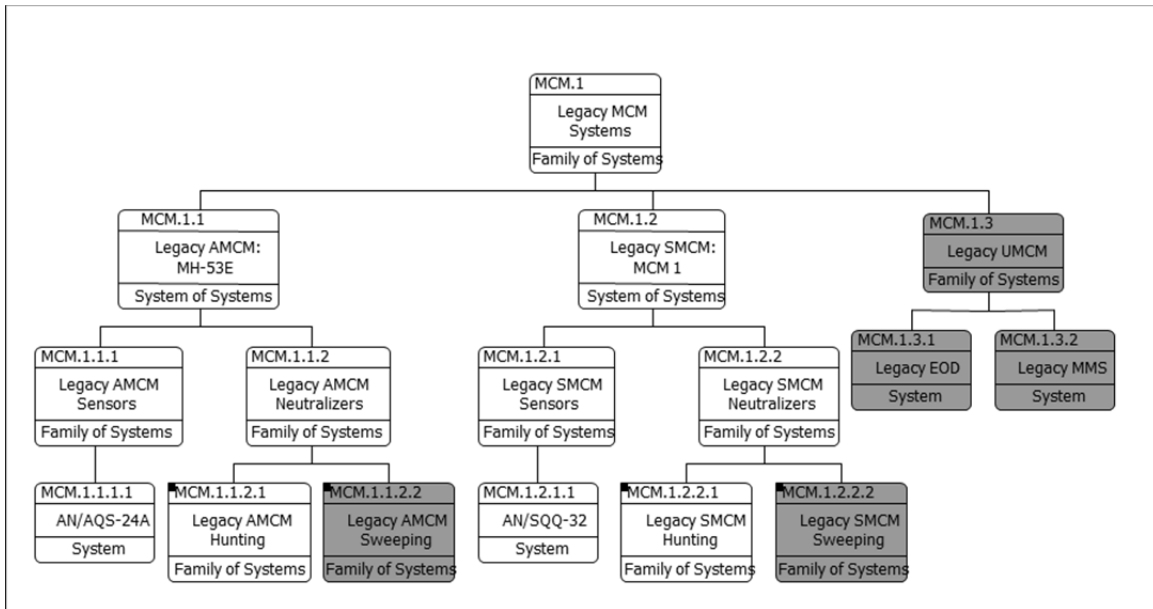

Figure 26. Legacy MCM Physical Systems Hierarchy

Figure 27 and Figure 28 show the legacy AMCM minehunting and minesweeping neutralizers and SMCM minehunting and minesweeping neutralizers; respectively. The descriptions of the legacy MCM systems are in Table 4.

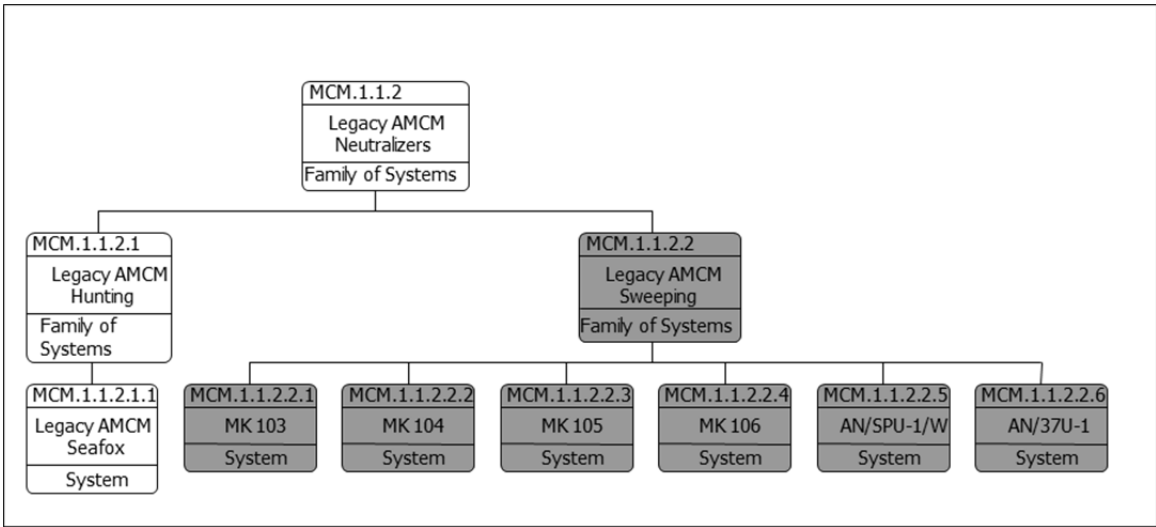

Figure 27. Legacy AMCM Neutralizing Systems Hierarchy

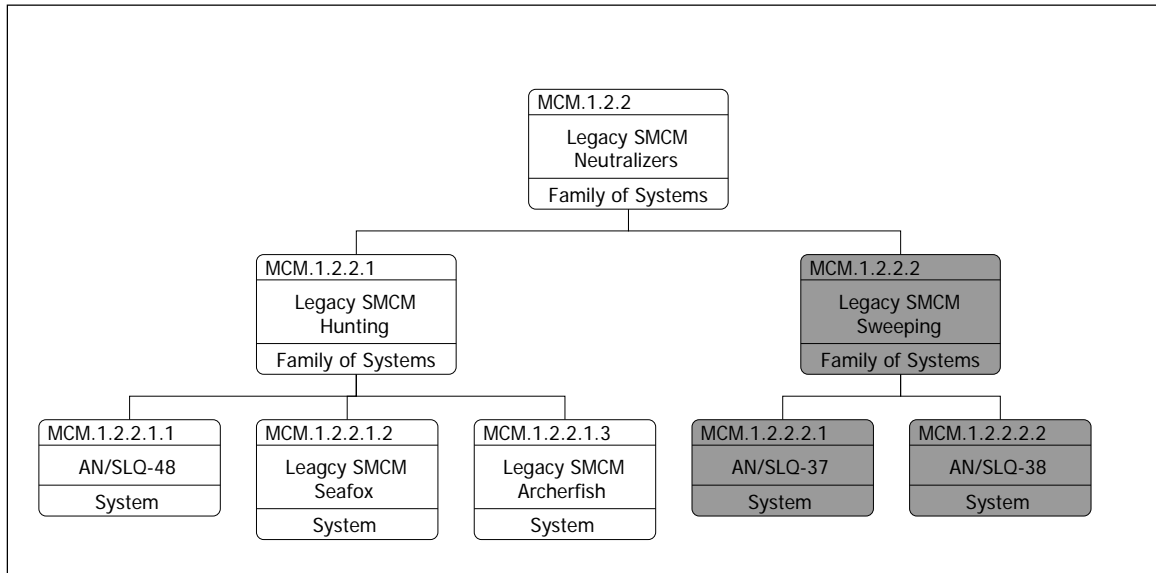

Figure 28. Legacy SMCM Neutralizing Systems Hierarchy

Table 4. Legacy MCM Systems (after PEO LMW 2009)

System of Systems	Family of Systems	System	Description	
AMCM MH-53E	Sensing	AN/AQS-24A	Side-looking sonar that can detect and classify bottom and moored mines as well as identify bottom mines	
	Hunting	SeaFox	Unmanned underwater vehicle (UUV) capable of detecting, classifying, identifying, and neutralizing mines	
	Sweeping	MK103	MK103	Mechanical sweep with a tow wire, cutters, and floats to target shallow-water moored mines
		MK104	MK104	Acoustic sweep with a self-rotating cavitating disk inside a venturi tube
		MK105	MK105	Magnetic sweep consisting of a gas turbine generator mounted on a sled
		MK106	MK106	Combination sweep consists of both the MK104 and MK105
		AN/SPU-1/W	AN/SPU-1/W	Magnetic and acoustic sweep consisting of parallel pipes or bars
AN/37U-1	AN/37U-1	Mechanical sweep with cable cutters that actuate when in contact with mooring cables		
SMCM MCM 1	Sensing	AN/SQQ-32	Sonar that can detect and classify moored, close-tethered, and bottom mines	
	Hunting	SeaFox	UUV capable of detecting, classifying, identifying, and neutralizing mines	
		AN/SLQ-4	AN/SLQ-4	Remote and unmanned submersible MNS that can neutralize bottom and moored mines
		Archerfish	Archerfish	UUV capable of identifying and neutralizing mines
	Sweeping	AN/SLC-37	AN/SLC-37	Magnetic and acoustic sweep consisting of a straight-tail magnetic sweep and an acoustic sweep device
AN/SLC-38		AN/SLC-38	Mechanical sweep able to cut the mooring cable of buoyant mines that are near the surface	
UMCM	EOD		Support MCM operations in locating, identifying, neutralizing, recovering, and disposing near surface sea mines, torpedoes, and other undersea weapons, including underwater IEDs	
	MMS		Specially trained dolphins and sea lions used for detection and neutralization, swimmer defense, and recovery of mines, torpedoes, and other objects	

2. Future MCM Systems Operational View and Physical Architecture

Figure 29 is a graphical depiction of the CONOPS of the LCS capabilities, indicating the tasks, operational elements, data flows, and activities performed within the MIW mission. As seen within the CONOPS depiction, the conduct of MIW operations involves the integration of several systems working together. It was essential to represent these elements shown in Figure 29 in the architectures to be able to translate them into the models that were used to develop the comparative data. This approach instilled relevance to the project, because the functional and physical architecture were mirrored from

fleet MIW legacy and future operations. This MCM operation is conducted by the use of a Sea Hawk helicopter, which departs the ship, flies a track search pattern over the minefield, and scans below the surface of the water with a laser scanner pod to hunt for MLOs. Once the helicopter has scanned the suspected minefield, the helicopter returns to the ship and the data from the laser scanner is downloaded and analyzed by countermine mission personnel aboard the ship (Broughton and Burdon 1998).



Figure 29. LCS CONOPS (from Broughton and Burdon 1998)

Based on the analysis of the data, one of two courses of action then takes place, dependent upon the identification of shallow-water mines. If the laser scan results indicate that there are no shallow water mines in the area that could endanger the ship, the ship enters the suspected mine field and initiates a search pattern with its semi-submersible RMMV that is towed behind the ship. Attached to the RMMV is a tethered sonar that is winch-controlled to search different depths with its high-resolution, high

frequency sonar. The Sea Hawk helicopter also continues searching the minefield with a tethered sonar that it winches into the water and tows through the water to locate the deep water mines (mines located 200 to 600 feet below the surface). Once the deep-water mines are located, the helicopter is used to carry another pod to neutralize the mines. This pod is also winched into the water and maneuvered close to the mines where individual torpedo-like modules, called Archer Fish, then separate from the pod. A flight crew operator remotely controls the Archer Fish from the helicopter to direct them to the mine, at which point they are detonated to destroy the mines. If shallow water mines are found by the initial laser scan from the Sea Hawk, the pod containing the Archer-Fish can be loaded and the helicopter can then deploy to destroy the shallow water mines, making it safe for the ship-towed sonar and helicopter-towed sonar to continue the search for the deep water mines. This process is continued until all the mines are neutralized. See Figure 30 for a flow chart of this mine hunting operation (National Geographic Channel 2014).

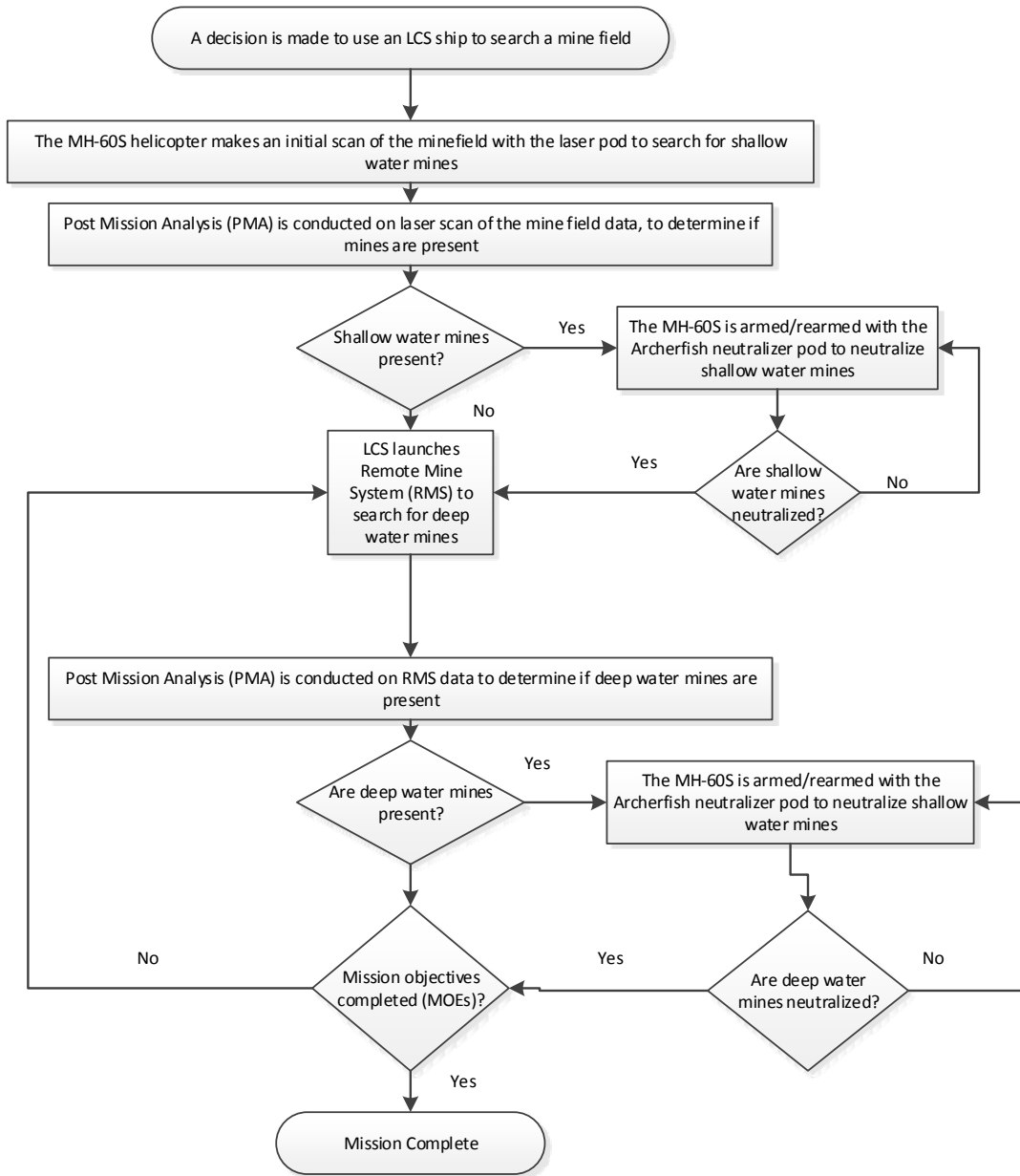

Figure 30. LCS Countermine Warfare Flow Chart (after National Geographic Channel 2014)

Figure 31 shows the future AMCM, SMCM, and UCM family of systems broken down into their respective systems or systems of systems. The legacy AMCM, consisting of the MH-60S helicopter, contains both sensing (detecting) and neutralizing systems that carry out minehunting functions. The future SMCM, consisting of the LCS

ship, contains both sensing and neutralizing systems. Future UMCM, like legacy UMCM, consists of the EOD divers and MMSs.

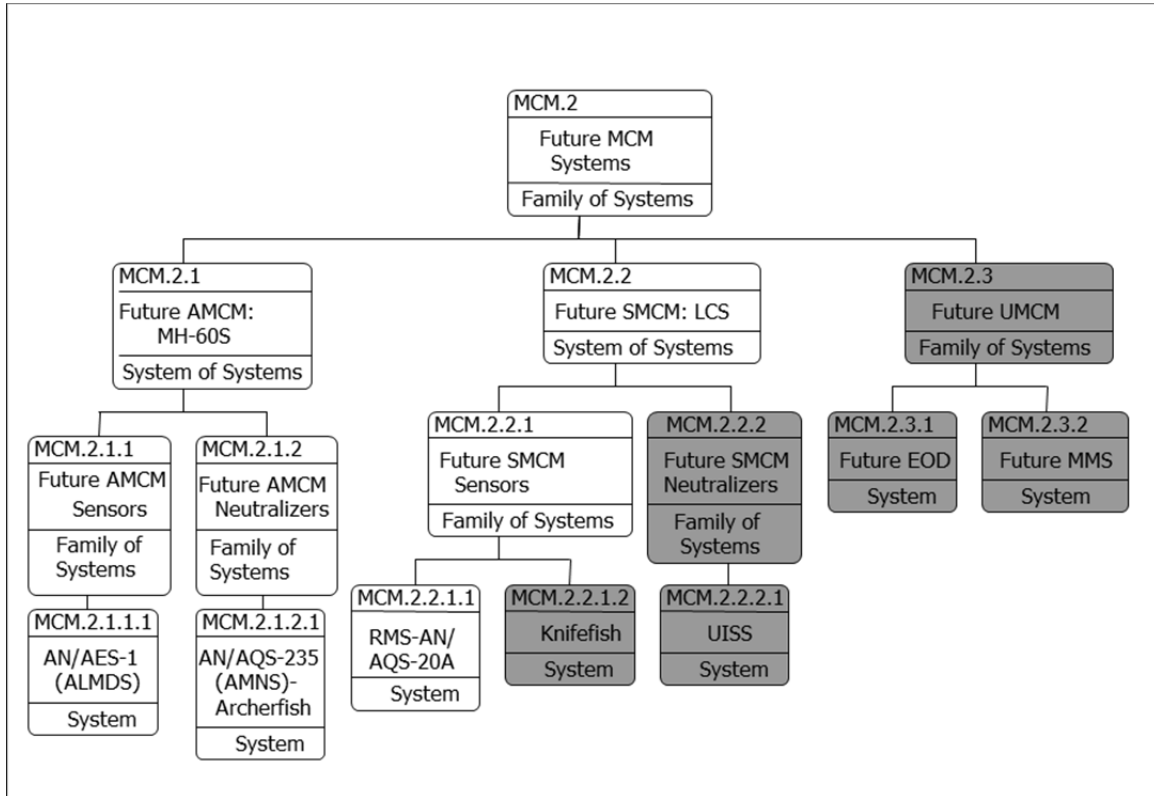

Figure 31. Future MCM Physical Systems Hierarchy

Table 5 shows the future MCM system hierarchy and provides a description of the future MCM systems.

Table 5. Future MCM Systems (after PEO LMW 2009)

System of Systems	Family of Systems	System	Description
AMCM MH-60S	Sensing	Airborne laser mine detection system (ALMDS)	Electro-optic laser system to detect, classify, and localize floating and near-surface moored sea mines
	Hunting	Airborne mine neutralization system (AMNS)—Archerfish	Remotely operated MNS that reacquires and neutralizes previously identified targets with Archerfish
SMCM LCS	Sensing	RMS-AN/AQS-20A	Unmanned, semi-autonomous vehicle that tows the AQS-20A, a sonar for detecting, classifying, locating, and identifying bottom, close-tethered, and moored sea mines

System of Systems	Family of Systems	System	Description
		Knifefish	Autonomous unmanned undersea system that provides buried mine detection capability
	Sweeping	UISS	Unmanned surface craft that tows a magnetic cable and acoustical signal generator
UMCM	EOD		Support MCM operations in locating, identifying, neutralizing, recovering, and disposing near surface sea mines, torpedoes, and other undersea weapons, including underwater IEDs
	MMS		Specially trained dolphins and sea lions used for detection and neutralization, swimmer defense, and recovery of mines, torpedoes, and other objects

3. Physical Traceability to Functions

Table 6 shows the traceability of the functions described in Section B to the physical systems described in this section. Only the minehunting functions and systems relevant to the scope of this report are shown. This mapping, in addition to the value hierarchy described in Section D, acts as a tool to validate that the basis for the project model is grounded to actual functions and physical systems.

Table 6. Functional/Physical Traceability Matrix

Functions		Physical Systems												
		Legacy MCM						Future MCM						
		Legacy AMCM: MH-53E	AN/AQS-24A	Legacy AMCM Seafox	Legacy SMCM: MCM 1	AN/SQQ-32	AN/SLQ-48	Legacy SMCMSeafox	Legacy SMCM Archerfish	Future AMCM: MH-60S	ALMDS	AMNS-Archerfish	Future SMCM: LCS	RMS-AN/AQS-20A
		1.1	1.1.1.1	1.1.2.1.1	1.2	1.2.1.1	1.2.2.1.1	1.2.2.1.2	1.2.2.1.3	2.1	2.1.1.1	2.1.2.1	2.2	2.2.1.1
1.1.2	Perform Mine Hunting Operations													
1.1.2.1	Detect Mines	X	X		X		X			X			X	
1.1.2.2	Classify MILECs		X	X		X		X		X			X	
1.1.2.3	Reacquire MILCOs		X	X		X		X		X			X	
1.1.2.4	Identify Mines		X	X			X	X	X		X		X	
1.1.3	Neutralize Mines													
1.1.3.1	Reacquire Mines		X	X			X	X	X		X		X	
1.1.3.2	Destroy Mines			X			X	X	X		X			
1.2	Control Equipment													
1.2.1	Transit Systems	X			X					X			X	
1.2.2	Load Fuel	X			X					X			X	
1.2.3	Maneuver Systems	X			X					X			X	
1.2.4	Recover Gear	X			X					X			X	
1.2.5	Stream Gear	X			X					X			X	
1.2.6	Reload and Rearm	X		X	X		X	X	X	X		X	X	
1.3	Gather/Receive Data and Information													
1.3.1	PMA				X								X	
1.3.2	Decide Course of Action				X								X	
1.4	Perform Maintenance Activities	X	X	X	X	X	X	X	X	X	X	X	X	

D. VALUE HIERARCHY

The value hierarchy is based on the objectives derived from the functional hierarchy described in Section B. The functional hierarchy portrays the sub-functions derived from the MCM research and from analyzing stakeholder needs; these sub-functions acted as objectives for the SE team in developing appropriate qualitative functional evaluation measures.

After the system functional hierarchy was developed, the MIW Team performed a value system design analysis as a precursor to considering design implementation alternatives. Value system design allows the association of evaluation measures to sub-functions

and objectives so that stakeholders have a metric by which they can later score design alternatives. In this project, the value system design allowed for the definition of the requirements for the simulations that were used to develop the performance comparisons between the different MCM configurations. A fundamental tool used as part of value system design is the value hierarchy. The value hierarchy depicts a value tree where the stakeholder effective need is traced to functions and objectives and their corresponding evaluation measures. The evaluation measures identify qualitative metrics for verifying that stakeholder needs are being met. Evaluation measures are further decomposed into MOEs and MOPs. MOEs formalize the qualitative evaluation measure for a particular function/objective while MOPs provide a foundation for formulating a performance requirement to meet the MOEs.

The performance and evaluation measures for MIW operations is defined in PEO LMW Instruction 3370.1A (Hagan 2008) and was used as the foundation for the MOEs and MOPs used within this project. The measures associated with defensive MCM are shown in Figure 32.

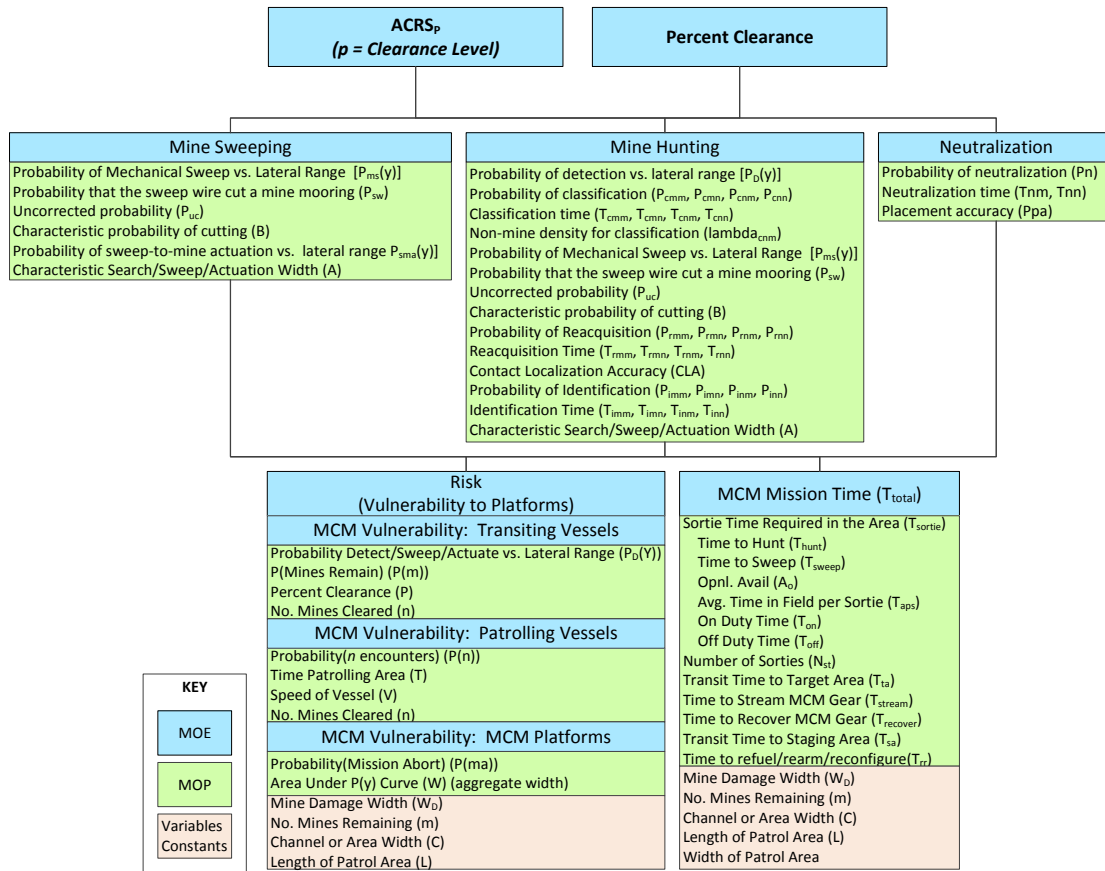

Figure 32. Defensive MCM MOEs and MOPs Per PEO LMW 3370.1A (after PEO LMW 2008)

Not all of the measures identified in Figure 32 applied to this project. Due to the study’s focus and the project’s constraints, only a subset of the measures were required for this analysis. Therefore, the MIW Team developed the value hierarchy depicted in Figure 33. This figure contains the objectives, MOEs, and MOPs associated with the overall purposes and goals for the simulation to be run in order to develop the comparative analysis.

The MIW Team also used the MOPs from the value hierarchy as a basis for generating requirements described in Section E. These requirements are associated with the functional hierarchy shown in Figure 13.

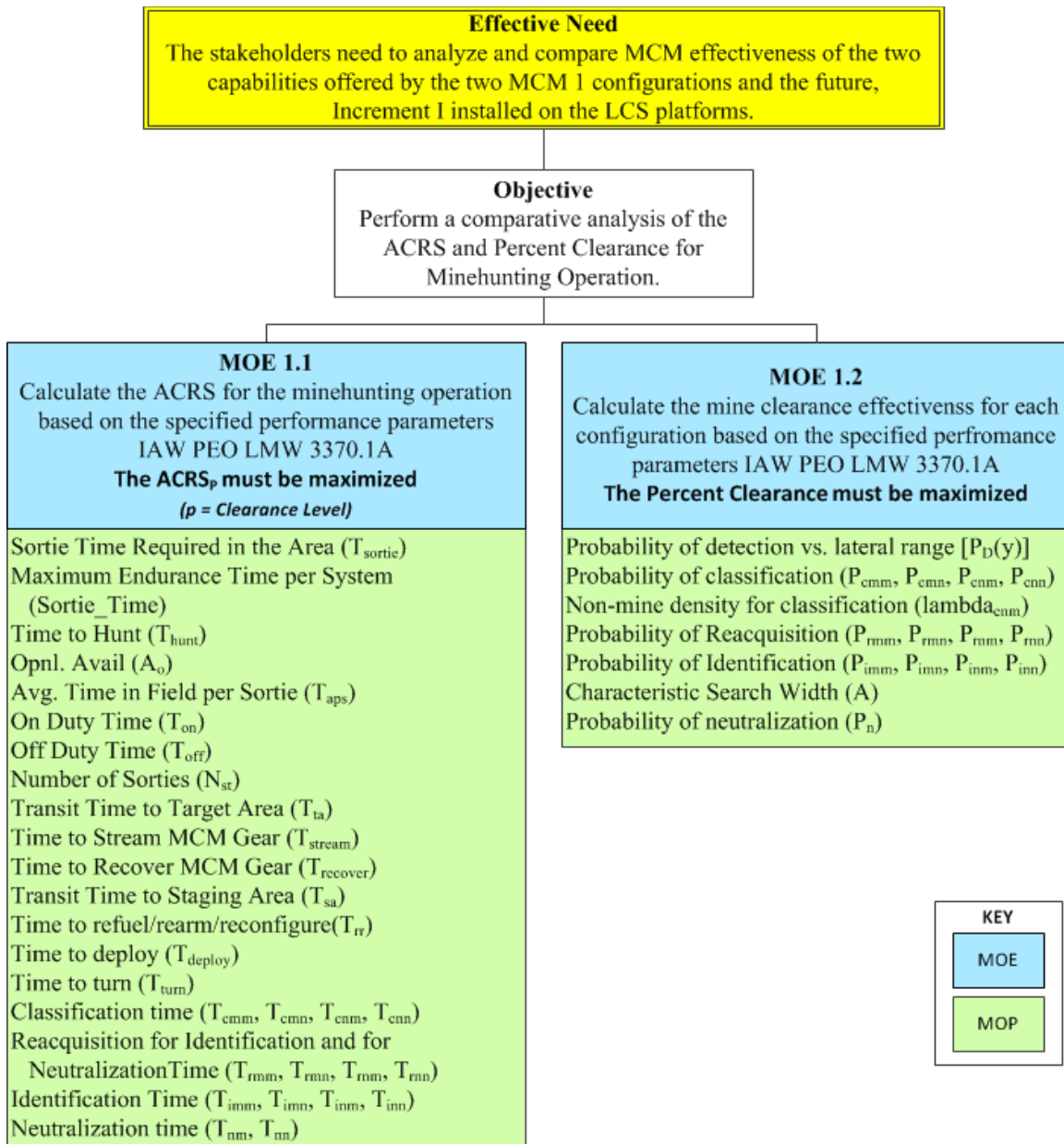

Figure 33. Value Hierarchy (after PEO LMW 2008)

The effective need is to conduct a comparative analysis between the five different MCM configurations (four MCM 1 and one LCS configuration) in terms of ACRS and effectiveness. This overarching need was decomposed into a single objective and then to two MOEs and further decomposed into multiple MOPs.

1. Effective Need

The effective need is shown in Figure 33 and is restated here: the stakeholders need to analyze and compare MCM effectiveness of the two capabilities offered by the two MCM 1 configurations and the future, Increment 1 installed on the LCS platforms. This need was decomposed into one primary objective.

2. Primary Objective

The primary objective was to perform a comparative analysis of the ACRS and percent clearance for the three MCM configurations in the conduct of minehunting in a predefined area in deep water. The MIW Team determined that a simulation containing models of the minehunting functions was the best way to represent the functions in representative mission scenarios.

The first MOE is to determine the ACRS for the conduct of the minehunting operation.

- MOE 1.1: Calculate the ACRS for the minehunting operation based on the specified performance parameters IAW PEO LM 3370.1A (2008).

As stated, this project evaluated three different MCM configurations; therefore, the performance and operation of the different systems for each had to be represented in the simulation. This single MOE was decomposed into 18 MOPs to provide evidence of satisfying this MOE.

- MOP 1.1.1 Sortie Time Required in the Area (Tsortie): This MOP supports the ACRS MOE and is the total sortie time in an area. It is a function of the number of sorties, the average time in the area per sortie, the platform duty-cycle, and systems' availabilities, and the time to sweep or hunt.
- MOP 1.1.2 Transit Time to Target Area (Tta): This MOP supports the ACRS MOE and is the time to transit from the staging area to the area of the mine. In this study, this is calculated within the simulation using the supplied transit speed in knots and the distance from the current location to the mine location.
- MOP 1.1.3 Transit Time to Staging Area (Tsa): This MOP supports the ACRS MOE and is the time to transit from the mine area to the staging area. In this study, this is calculated within the simulation using the supplied

transit speed (in knots) and the distance from the current location to the staging location.

- MOP 1.1.4 Time to Stream MCM Gear for Search Equipment (T_{stream}): This MOP supports the ACRS MOE and is the time required to deploy the MCM equipment from the platform.
- MOP 1.1.5 Time to Recover MCM Gear ($T_{recover}$): This MOP supports the ACRS MOE and is the time required to recover or load the MCM equipment to the platform.
- MOP 1.1.6 Time to Refuel/Rearm/Reconfigure (T_{rr}): This MOP supports the ACRS MOE and is the time required to refuel, rearm, or reconfigure the MCM equipment.
- MOP 1.1.7 Time to Turn (T_{turn}): This MOP supports the ACRS MOE and is the time required for the MCM platform to turn from one track to the next.
- MOP 1.1.8 Time to Deploy for RI&N Equipment (T_{deploy}): This MOP supports the ACRS MOE and is the time required to deploy the MCM equipment from the platform.
- MOP 1.1.9 Average Time in Field per Sortie (T_{aps}): This MOP supports the ACRS MOE and is the average time in the field per sortie for each MCM platform.
- MOP 1.1.10 Number of Sorties (N_{st}): This MOP supports the ACRS MOE and is the number of sorties needed to complete a mission.
- MOP 1.1.11 Operational Availability (A_o): This metric primarily supports the ACRS MOE and is the probability that the MCM equipment is capable of performing its function when it is needed. This metric is not explicitly modeled within the simulation, but is accounted for by a delay in the operation time.
- MOP 1.1.12 On Duty Time (T_{on}): This metric supports the ACRS MOE and captures the operational constraints of the use of the MCM equipment.
- MOP 1.1.13 Off Duty Time (T_{off}): This metric supports the ACRS MOE and captures the operational constraints of the use of the MCM equipment.
- MOP 1.1.14 Time to Hunt (T_{hunt}): This MOP supports the ACRS MOE and accounts for the total amount of time to perform minehunting. It is a function of the search time, time to classify, time to reacquire for identification, time to identify, time to reacquire for neutralization, and time to neutralize.
- MOP 1.1.15 Classification Time (T_{cmm} , T_{cmn} , T_{cnm} , T_{cnn}): This MOP supports the ACRS MOE and is the total time to classify. Classification time is a function of the number of classification attempts on mines, the

number of classification attempts on non-mines, the time to classify a mine as mine (Tcmm), the time to classify a non-mine as mine (Tcnm), the time to classify a non-mine as a non-mine (Tcnn) and the time to classify a mine as a non-mine (Tcnm).

- MOP 1.1.16 Reacquisition Time for Identification and for Neutralization (Trmm, Trmn, Trnm, Trnn): This MOP supports the ACRS MOE and is the total time to reacquire a mine for identification or neutralization. Reacquisition time is a function of the number of reacquisition attempts on mines, the number of reacquisition attempts on non-mines, the time to reacquire a mine as mine (Trmm), the time to reacquire a non-mine as mine (Trnm), the time to reacquire a non-mine as a non-mine (Trnn) and the time to reacquire a mine as a non-mine (Trnm).
- MOP 1.1.17 Identification Time (Timm, Timn, Tinm, Tinn): This MOP supports the ACRS MOE and is the total time to identify a mine. Identification time is a function of the number of identification attempts on mines, the number of identification attempts on non-mines, the time to identify a mine as mine (Timm), the time to identify a non-mine as mine (Timn), the time to identify a non-mine as a non-mine (Tinn) and the time to identify a mine as a non-mine (Tinm).
- MOP 1.1.18 Neutralization Time (Tnm, Tnn): This MOP supports the ACRS MOE and is the total time to neutralize a mine. Neutralization time is a function of the number of neutralization attempts on mines, the number of neutralization attempts on non-mines, the time to neutralize a mine (Tnm) and the time to neutralize a non-mine (Tnn) (PEO LMW 2008).

The second MOE is to determine the effectiveness of the minehunting operation in terms of the percent clearance.

- MOE 1.2: Calculate the mine clearance effectiveness for each configuration based on the specified performance parameters IAW PEO LMW 3370.1A (2008).

There are five MOPs for this MOE.

- MOP 1.2.1 Probability of Detection vs. Lateral Range [PD(y)]: This metric deals with the probability that a mine will be detected by the search sonar system as a function of the lateral range from the sonar system to the mine object.
- MOP 1.2.2 Probability of Classification (Pcmm, Pcmn, Pcnm, Pcnn): This metric supports the effectiveness MOE and deals with the probability that a mine, once detected, is properly classified as a MILCO. The MOP deals with the probability of classifying a MILCO as a MILCO (Pcmm), the probability of classifying a MILCO as a non-MILCO (Pcmn), the probability of classifying a non-MILCO as a MILCO (Pcnm) and the probability of classifying a non-MILCO as a non-MILCO (Pcnn).

- MOP 1.2.3 Probability of Reacquisition (Prmm, Prmn, Prnm, Prnn): This metric supports the effectiveness MOE and is the probability that the next MCM system used either for identification or for neutralization can accurately locate the MILCO or identified mine so that the object can be either identified or neutralized. The MOP deals with the probability of reacquiring a MILCO or mine as a MILCO or mine (Prmm), the probability of reacquiring a MILCO or mine as a non-MILCO or non-mine (Prmn), the probability of reacquiring a non-MILCO or non-mine as a MILCO or mine (Prnm) and the probability of reacquiring a non-MILCO or non-mine as a non-MILCO or non-mine (Prnn).
- MOP 1.2.4 Probability of Identification (Pimm, Pimn, Pinm, Pinn): This metric supports the effectiveness MOE and is the probability that a MILCO is accurately identified as a mine. The MOP deals with the probability of identifying a MILCO as a mine (Pimm), the probability of identifying a MILCO as a non-mine (Pimn), the probability of identifying a non-MILCO as a mine (Pinm) and the probability of identifying a non-MILCO as a non-mine (Pinn).
- MOP 1.2.5 Probability of neutralization (Pn): This metric supports the effectiveness MOE and is the probability that a mine is successfully neutralized. Although this MOP refers to detonation of the mine by any means (i.e., mechanical sweeping, influence sweeping, or charge placement), this study only evaluated this metric as it pertains to minehunting operations (charge placement, detonation, and accuracy) (PEO LMW 2008).

Not captured in the listed MOPs are the set of elements that are required for the simulation to function such that the MOPs can be represented and calculated to provide the resultant MOEs, ACRS and percent clearance.

E. REQUIREMENTS

The following describes the detailed requirements for the study. IAW the defined SE process, the top-level requirements (Chapter III) were decomposed into detailed requirements as listed in Table 7. The top-level requirements are shown in bold.

Table 7. Detailed Requirements (after PEO LMW 2008)

REQ. NO.	REQUIREMENT
1.0	The simulation shall enable the determination of the ACRS for each MCM configuration in the performance of mine hunting.
1.1	The simulation shall represent the time required to perform each minehunting function within the minehunting operation: travel, detect, classify, identify, reacquire, and neutralize for each MCM configuration.
1.1.1	The simulation shall represent the sortie time required in the area (Tsortie).
1.1.1.1	The simulation shall represent the maximum endurance time per system (Sortie_Time) for surface platforms between 336 and 504 hours.
1.1.1.2	The simulation shall represent the maximum endurance time per system (Sortie_Time) for airborne systems between one and four hours.
1.1.2	The simulation shall represent the transit time to target area (Tta).
1.1.2.1	The simulation shall represent the transit speed of MCM 1 between 10 and 15 knots.
1.1.2.2	The simulation shall represent the transit speed of LCS between 20 and 40 knots.
1.1.2.3	The simulation shall represent the transit speed of helicopter between 80 and 150 knots.
1.1.2.4	The simulation shall represent the transit speed of airborne deployed neutralizer between zero and five knots.
1.1.3	The simulation shall represent the transit time to staging area (Tsa).
1.1.4	The simulation shall represent the time to stream MCM gear (Tstream)
1.1.4.1	The simulation shall represent the time to stream MCM gear (Tstream) for search equipment for surface platforms between 0.25 and two hours.
1.1.4.2	The simulation shall represent the time to stream MCM gear (Tstream) for search equipment for airborne systems between 0.2 and 0.5 hours.
1.1.5	The simulation shall represent the time to recover MCM gear (Trecover).
1.1.5.1	The simulation shall represent the time to recover RI&N equipment for surface platforms between 0.1 and two hours.
1.1.5.2	The simulation shall represent the time to recover the search equipment for surface platforms between 0.25 and two hours.
1.1.5.3	The simulation shall represent the time to recover RI&N equipment for airborne systems between 0.2 and one hour.
1.1.5.4	The simulation shall represent the time to recover the search equipment for airborne systems between 0.2 and 0.5 hours.
1.1.6	The simulation shall represent the time to refuel/rearm/reconfigure (Trr)
1.1.6.1	The simulation shall represent the time to refuel/rearm/reconfigure (Trr) for surface platforms between four and eight hours.
1.1.6.2	The simulation shall represent the time to refuel/rearm/reconfigure (Trr) for airborne systems between four and eight.
1.1.7	The simulation shall represent the time to turn (Tturn).
1.1.7.1	The simulation shall represent the time to turn (Tturn) for surface platforms between 300 and 600 seconds.
1.1.7.2	The simulation shall represent the time to turn (Tturn) for airborne systems between 120 and 240 seconds.
1.1.8	The simulation shall represent the time to deploy (Tdeploy) for RI&N equipment.

REQ. NO.	REQUIREMENT
1.1.8.1	The simulation shall represent the time to deploy (Tdeploy) for RI&N equipment for surface platforms between 0.1 and two hours.
1.1.8.2	The simulation shall represent the time to deploy (Tdeploy) for RI&N equipment for airborne systems between 0.1 and one hour.
1.1.9	The simulation shall represent the average time in field per sortie (Taps).
1.1.10	The simulation shall represent the number of sorties (Nst).
1.1.11	The simulation shall represent the operational availability (A _o).
1.1.12	The simulation shall represent the on duty time (Ton).
1.1.13	The simulation shall represent the off duty time (Toff).
1.1.14	The simulation shall represent the time to hunt (Thunt).
1.1.14.1	The simulation shall represent the speed in search area for surface platforms between one and five knots.
1.1.14.2	The simulation shall represent the speed in search area for airborne systems between 10 and 30 knots.
1.1.14.3	The simulation shall represent the number of search tracks per NM for surface platforms between 10 and 40.
1.1.14.4	The simulation shall represent the number of search tracks per NM for airborne systems between 10 and 40.
1.1.14.5	The simulation shall represent the number of passes per track for airborne systems between one and four.
1.1.15	The simulation shall represent the classification time (Tcmm, Tcmn, Tcnm, Tcnn).
1.1.16	The simulation shall represent the reacquisition for identification and for neutralization time (Trmm, Trmn, Trnm, Trnn).
1.1.16.1	The simulation shall represent the mean reacquisition and identification for surface platforms between 0.25 and one hour.
1.1.16.2	The simulation shall represent the standard deviation time for reacquisition and identification for surface platforms between 0.1 and 0.5 hours.
1.1.16.3	The simulation shall represent the mean reacquisition and identification for airborne systems between 0.5 and one hour.
1.1.16.4	The simulation shall represent the standard deviation time for reacquisition and identification for airborne systems between 0.1 and 0.5 hours.
1.1.16.5	The simulation shall represent the mean reacquisition and neutralization for surface platforms between 0.2 and 0.5 hours.
1.1.16.6	The simulation shall represent the standard deviation time for reacquisition and neutralization for surface platforms between 0.10 and 0.25 hours.
1.1.16.7	The simulation shall represent the minimum safe stand-off distance during neutralization (MCM 1) between 250 and 300 yards.
1.1.16.8	The simulation shall represent the minimum safe stand-off distance during neutralization (helicopter) between 300 and 350 yards.
1.1.16.9	The simulation shall represent the minimum time for reacquisition for identification, airborne deployed neutralizer between 0.25 and 0.50 hours.
1.1.17	The simulation shall represent the identification time (Timm, Timn, Tinn, Tinn).
1.1.18	The simulation shall represent the neutralization time (Tnm, Tnn).
1.1.18.1	The simulation shall represent the number of neutralizers for MH-53E between zero and six.
1.1.18.2	The simulation shall represent the number of neutralizers for MH-60S between zero and four.

REQ. NO.	REQUIREMENT
1.2	The simulation shall calculate the ACRS (time required to conduct the entire minehunting sequence).
2.0	The simulation shall model the effectiveness of each minehunting function.
2.1	The simulation shall calculate and store the effectiveness of each minehunting function.
2.1.1	The simulation shall represent the probability of detection vs. lateral range [PD(y)] between 0.3 and 0.9.
2.1.2	The simulation shall represent the probability of classification (Pcmm, Pcmn, Pcnm, Pcnn).
2.1.2.1	The simulation shall represent the probability of classifying a mine as a MILCO for surface platforms between 0.5 and 0.9.
2.1.2.2	The simulation shall represent the probability of classifying a non-mine as a non-MILCO for surface platforms between 0.5 and 0.9.
2.1.2.3	The simulation shall represent the probability of classifying a mine as a MILCO for airborne systems between 0.5 and 0.9.
2.1.2.4	The simulation shall represent the probability of classifying a non-mine as a non-MILCO for airborne systems between 0.5 and 0.9.
2.1.3	The simulation shall represent the probability of reacquisition (Prmm, Prmn, Prnm, Prnn).
2.1.3.1	The simulation shall represent the probability of reacquiring a mine as a MILCO for identification for surface platforms between 0.3 and 0.8.
2.1.3.2	The simulation shall represent the probability of reacquiring a mine for neutralization given mine was already identified as a mine for surface platforms between 0.3 and one.
2.1.3.3	The simulation shall represent the probability of not reacquiring a non-mine as a MILCO for identification for surface systems between 0.01 and 0.30.
2.1.3.4	The simulation shall represent the probability of not reacquiring a non-mine for neutralization given non-mine was already identified as a mine for surface systems between 0.01 and 0.30.
2.1.3.5	The simulation shall represent the probability of reacquiring a mine as a MILCO for identification for airborne platforms between 0.3 and 0.8.
2.1.3.6	The simulation shall represent the probability of not reacquiring a non-mine as a MILCO for identification for airborne systems between 0.01 and 0.50.
2.1.4	The simulation shall represent the probability of identification (Pimm, Pimn, Pinm, Pinn).
2.1.4.1	The simulation shall represent the probability of identifying a mine as a mine for surface platforms between 0.5 and one.
2.1.4.2	The simulation shall represent the probability of identifying a non-mine as a non-mine for surface platforms between 0.5 and one.
2.1.4.3	The simulation shall represent the probability of identifying a mine as a mine for airborne systems between 0.5 and one.
2.1.4.4	The simulation shall represent the probability of identifying a non-mine as a non-mine for airborne systems between 0.5 and one.
2.1.5	The simulation shall represent the probability of neutralization (Pn) between 0.5 and 0.9.
2.2	The simulation shall calculate and output the overall minehunting effectiveness in terms of the number of mines cleared, number of mines remaining, and the number of non-mines that were neutralized.
3.0	The simulation shall contain models of the minehunting sequence of events for the different configurations.

REQ. NO.	REQUIREMENT
3.1	The simulation shall represent each of the three MCM configuration's mine-hunting functions: search, detect, classify, identify, reacquire, and neutralize.
3.2	The simulation shall represent the minefield size and location for use in the effectiveness and ACRS calculations.
3.2.1	The simulation shall represent the search area.
3.2.1.1	The simulation shall represent the length of search area between one and 100.
3.2.1.2	The simulation shall represent the width of search area between one and 100.
3.2.1.3	The simulation shall represent the percentage of area covered by surface search (MCM 1) between zero and 100.
3.2.1.4	The simulation shall represent the percentage of area covered by surface neutralization (MCM 1) between zero and 100.
3.2.2	The simulation shall represent the staging position's coordinates for use in the ACRS and effectiveness calculations.
3.2.2.1	The simulation shall represent the staging position—X-Coordinate between -50 and zero.
3.2.2.2	The simulation shall represent the staging position—Y-Coordinate between zero and SLOC width.
3.2.3	The simulation shall represent the number of mines between one and 1000.
3.2.4	The simulation shall represent the non-mine density for classification (λ_{cnm}) between one and 1000.
3.3	The simulation shall transition the state and minehunting results of the previous function to the subsequent function IAW PEO LMW Instruction 3370.1A (2008).
4.0	The simulation shall support setting and modifying the listed performance parameters without requiring modifying the simulation.
4.1	The simulation shall import specified input parameters without requiring modifications to the code.
4.2	The simulation shall support the export of the resulting effectiveness and time-to-complete parameters to a form that can be analyzed by statistical software products such as Excel and Minitab.
4.3	The simulation shall be developed in a modular method that allows for each function to be replaced.
5.0	The simulation shall include documentation that facilitates the use of the simulation tool by future study groups.
5.1	The simulation shall include documentation that describes the use of the code and descriptions of the input and output parameters.
5.2	The simulation shall include documentation that describes the code, the structure of the code, and the required inputs and outputs of each functional block.

Table 8 displays the mapping of the MOPs to the detailed requirements indicating that each MOP has a matching requirement. Note that some of the requirements do not map directly to specific MOPs, these requirements ensure that the simulation developed is sufficient to be used as the tool for performing the comparative analysis. These are marked on the table as “Non-functional—Ease of Use” to indicate that the satisfaction of these requirements had been addressed.

Table 8. MOP to Requirement Mapping Matrix

MOP(s)	REQUIREMENT											
	1.1	1.2	2.1	2.2	3.1	3.2	3.3	4.1	4.2	4.3	5.1	5.2
Sortie Time Required in the Area (Tsortie)	X	X			X	X	X	X	X			
Transit Time to Target Area (Tta)	X	X				X		X	X			
Transit Time to Staging Area (Tsa)	X	X				X		X	X			
Time to Stream MCM Gear (Tstream) for Search Equipment	X	X						X	X			
Time to Recover MCM Gear (Trecover)	X	X						X	X			
Time to Refuel/Rearm/Reconfigure (Trr)	X	X						X	X			
Time to Turn (Tturn)	X	X						X	X			
Time to Deploy (Tdeploy) for RI&N Equipment	X	X						X	X			
Average Time in Field per Sortie (Taps)	X	X				X	X	X	X			
Number of Sorties (Nst)	X	X				X	X	X	X			
Operational Availability (Ao)	X	X							X			
On Duty Time (Ton)	X	X							X			
Off Duty Time (Toff)	X	X							X			
Time to Hunt (Thunt)	X	X			X	X	X	X	X			
Classification Time (Tcmm, Tcmn, Tcnm, Tcnn)	X	X			X	X	X	X	X			
Reacquisition for Identification and for Neutralization Time (Trmm, Trmn, Trnm, Trnn)	X	X			X	X	X	X	X			
Identification Time (Timm, Timn, Tinn, Tinn)	X	X			X	X	X	X	X			
Neutralization Time (Tnm, Tnn)	X	X			X	X	X	X	X			
Probability of Detection vs. Lateral Range (PD(y))			X	X	X	X	X	X	X			

MOP(s)	REQUIREMENT											
	1.1	1.2	2.1	2.2	3.1	3.2	3.3	4.1	4.2	4.3	5.1	5.2
Probability of Classification (Pcmm, Pcmn, Pcnm, Pcnn)			X	X	X	X	X	X	X			
Probability of Reacquisition (Prmm, Prmn, Prnm, Prnn)			X	X	X	X	X	X	X			
Probability of Identification (Pimm, Pimn, Pinm, Pinn)			X	X	X	X	X	X	X			
Probability of Neutralization (Pn)			X	X	X	X	X	X	X			
Non-Functional—Ease of Use										X	X	X

F. SYSTEM ARCHITECTURE SUMMARY

A methodical, MBSE methodology was used to develop the system architecture that included the functional, physical architectures as well as the mapping of the performance parameters required to fully represent the two MCM SOS. The development of the architectures was initiated with an evaluation of the various tasks and elements required for the conduct of MCM from a top-level perspective. This was then transformed into the functional and physical architectures through the development of a functional decomposition, FFBDs, and EFFBDs. The physical systems that perform the various functions were then evaluated and the physical decomposition and mapping to the functional architecture was performed. Subsequent to the development of these architecture designs were the identification of the MOEs and MOPs and the development of the value hierarchy to associate these with the performance of the MCM systems. Once the functional and physical architectures were developed and the requirements and MOPs defined, it was necessary to evaluate the scenario within which the study was to be performed. The information regarding the scenario is included in the next chapter.

V. OPERATIONAL CONCEPT AND SCENARIO ANALYSIS

This chapter provides an operational analysis of the U.S. Navy's MCM missions as well as the operational concept for legacy and future MCM operations and capabilities. This chapter also lists and describes different operational vignettes for a particular MCM scenario based on relevant operational context that were modeled and studied as a basis for comparative analysis between the legacy and future MCM systems.

A. OPERATIONAL CONTEXT

As described in Chapter I, naval MIW has not sustained a consistent level of interest, historically, as compared to some other primary naval warfare disciplines, such as ASuW, ASW, and AAW. Consequently, organic fleet surface assets for MCM have consisted of wood ships optimized for hunting or sweeping for sea mines by venturing into minefields to conduct MCM operations. These MIW ships were made small and maneuverable so that they could negotiate operations inside the minefields. Limitations of these ships are that they need to be carried to the minefield by heavy lift ships (one heavy lift ship carries two MCM 1 ships) and must rely on other large ships, such as Landing Helicopter Dock (LHD) ships, in the fleet to carry any MIW aviation assets, such as the CH-53D Sea Dragon. As a result, MCM warfare has had to maintain a very large footprint, due to the large number of specialized equipment and personnel as well as the logistics requirements to move this equipment to the minefield in case an operational need arises. This operational concept is shown on the left side of Figure 34 where four smaller MCM platforms, a larger LHD ship with aerial MCM assets, and a separate LSD with EOD detachment are needed to carry out a particular MCM mission. As a result of the past inefficient and dangerous methods of conducting MCM, the new line of MIW capable ships, the LCS, is planned to provide the fleet with an organic MCM capability through the four-phase LCS MIW package integration plan. This new operational concept is shown on the right side of Figure 34 where five LCS ships with their inherent aerial MCM capability are able to perform the same MCM mission with fewer personnel (390 instead of 2,300 sailors) and equipment.

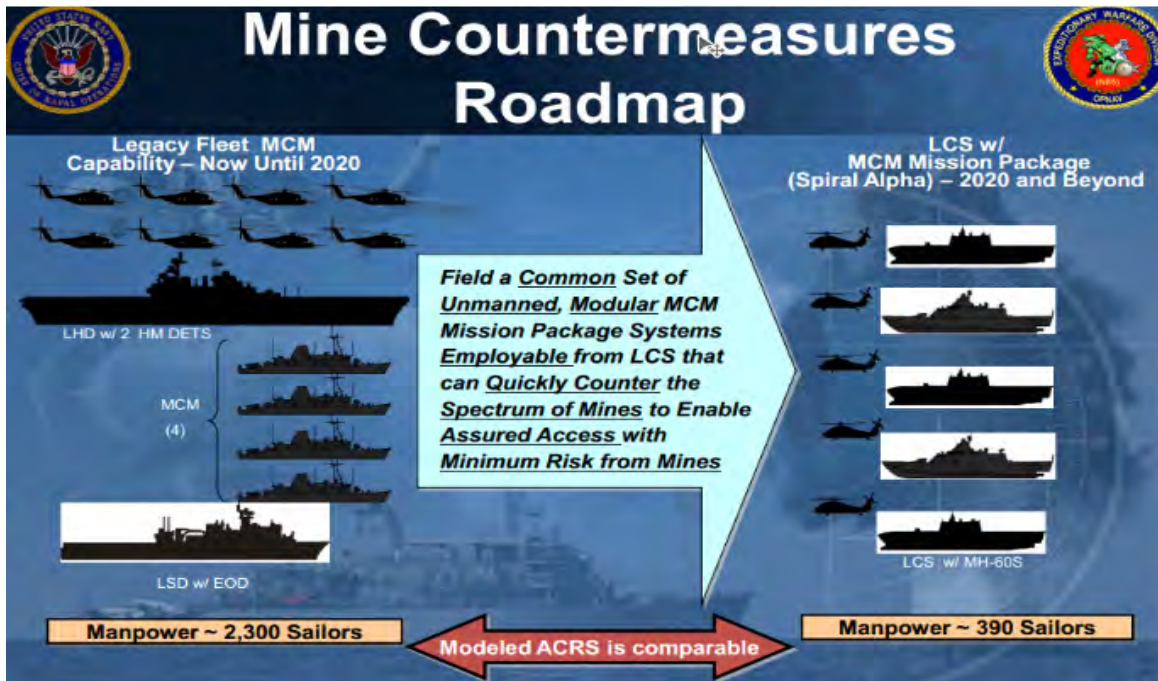

Figure 34. MCM Roadmap (from Amador 2011)

The LCS MIW deployment mission packages will be a four-phase process, beginning in 2014, and scheduled to be completed in 2024. Each phase of LCS MIW development and fielding process will add MIW capabilities to the LCS platform. As can be seen in Figure 35, as the LCS MIW capabilities are fielded (indicated by the label “LCS/MIW Ramp-Up”), new fleet MIW capabilities will be gained. Simultaneously, during the LCS MIW ramp-up period, the legacy MCM ship, MCM 1 ships, will be decommissioned, as indicated by the arrow labeled “MCM 1 Ramp-down.”

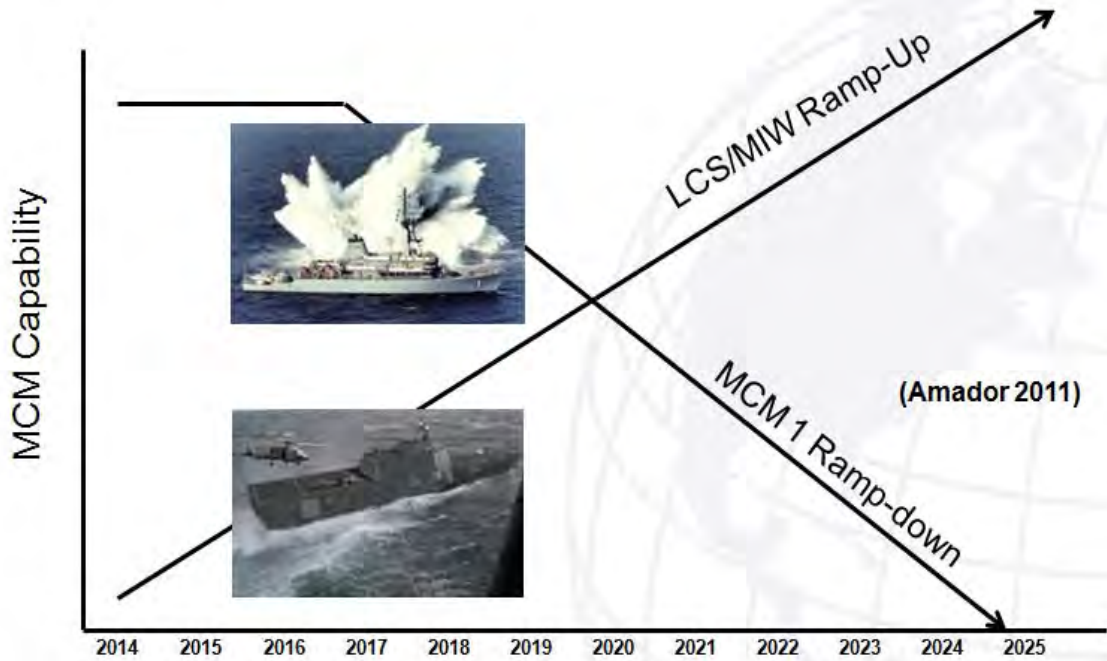

Figure 35. MCM Transition

It is this transition, from the MCM 1 being the cornerstone of naval MIW and operating inside the minefield, to the LCS taking over this responsibility that poses a challenge to maintaining an effective MCM capability. The LCS will primarily operate outside of the minefield (for initial phases of MCM) and then venture into the minefield once it is verified that mines have been neutralized and are not a threat to the ship. During this transition phase, occurring between 2017 and 2024, both MCM systems will be in operation, with the simultaneous ramp-down of the legacy MCM system and ramp-up of the LCS over the four phases of its MIW mission package deployment. This LCS MIW mission package deployment schedule can be seen in Figure 36. Note that in the legend for Figure 36, the reduction of the MH-53E Sea Dragon is tied to the reduction of the MCM 1, as each is part of the legacy MIW mission package despite the MCM 1 not being an aircraft capable ship. Figure 36 also depicts the simultaneous ramp down of the MCM 1 and MH-53E and ramp up of the LCS and MIW Increment 1 (Spiral Alpha) MCM Mission Package.

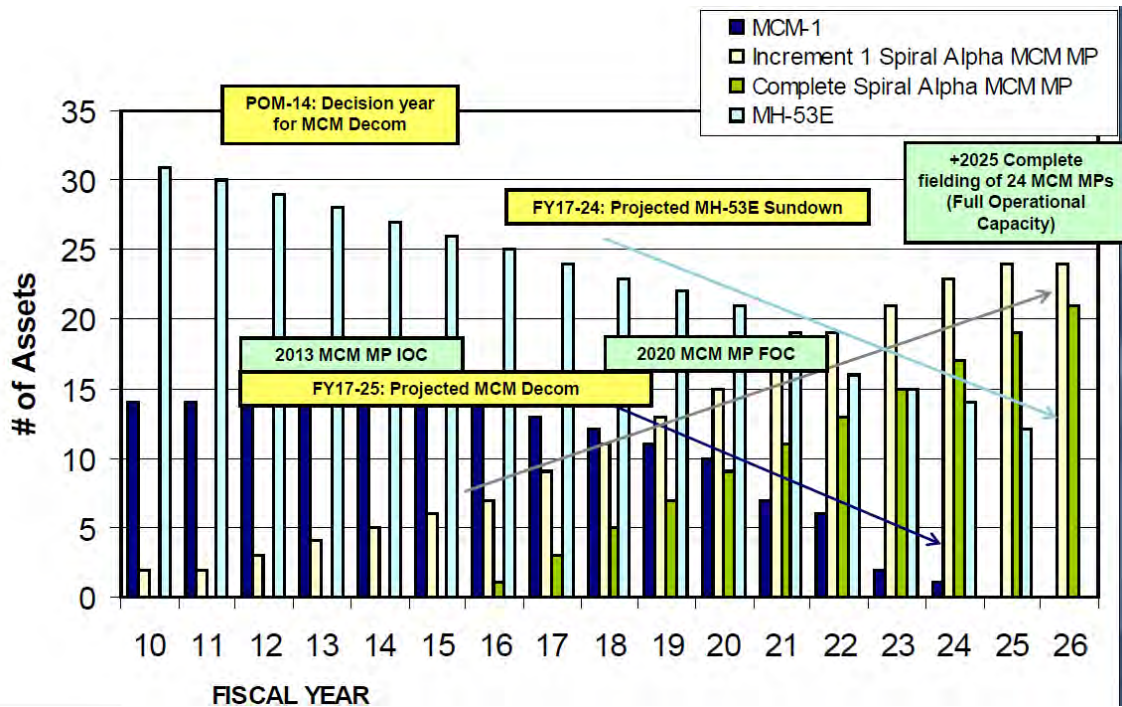

Figure 36. Transition from Legacy to Future MCM Capability (from Amador 2011)

B. OPERATIONAL CONCEPTS

As described in Chapter I, MCM operations involve minehunting and minesweeping. The comparative analysis focused on the minehunting capabilities of the legacy MCM 1 including the MH-53E and future incremental minehunting capabilities of the LCS including the MH-60S. In comparing legacy and future MCM effectiveness, it was important to consider differences in the way the legacy systems perform an MCM operation as compared to future systems.

Legacy systems are able to perform a complete minehunting mission, from detection to neutralization, but must perform the functions of the mission in a more serial fashion compared to future systems (LT Andrew Watts, personal communication, 10 July 2014). Typically, the MH-53E is first deployed from a LHD ship outside the minefield to detect and classify mines with towed sonar. For surface mines, EOD divers or legacy sweep systems are needed for neutralization. The MH-53E also checks for moored MILCOs using “persistence by checking MLO track position with respect to time during

several runs, which is an indication a MLO is a mine” (Brett Cordes, personal communication, 12 August 2014). Following a PMA of MILCOs, a target list is generated for neutralization. If the list contains a large number of targets then both the MH-53E and MCM 1 are utilized for neutralization; otherwise, the MH-53E is the primary neutralizer. If the helicopter is not outfitted with a neutralization system, such as SeaFox, then the MCM 1 is brought in to reacquire the MILCOs, identify them as mines, and neutralize them. The MH-53E can fly for approximately four hours. Each stage of hunting has an associated execution time, making the serial aspect of legacy MCM operations for particular missions especially time consuming (DON 2010).

The future MCM capabilities afforded by the incremental LCS phases will also be able to complete a minehunting mission, from detection to neutralization, but several of the functions may be executed in parallel (LT Andrew Watts, personal communication 10 July 2014). With the embarked MH-60S that is outfitted with both detection and neutralization systems, the LCS will not have to wait on another ship to provide aerial assets. Furthermore, the assets themselves will be able to carry out an entire minehunting mission for certain types of mines. For near surface mines in shallow water the MH-60S will use the ALMDS for detection and classification and the AMNS for neutralization. For subsurface mines in deeper water, the LCS will deploy the RMS with towed sonar for detection and classification and then utilize the MH-60S outfitted with an Archerfish for neutralization. Like the legacy systems, the future systems will be reliant on EOD and sweep systems for surface mines (Brett Cordes, personal communication, 8 May 2014).

For minesweeping, the legacy and future capabilities differ in how they deploy surface sweep systems. Both are able to sweep from the air using the MH-53E and MH-60S for legacy and future, respectively. The legacy surface sweep capability requires the MCM 1 to drag the sweep systems in the minefield while the future surface sweep capability will be provided by a remote unmanned vessel controlled by the LCS outside the minefield.

C. OPERATIONAL SCENARIO

MCM operations are defined by the type of MCM mission objectives where the purpose of the attack conducted against the minefield defines the MCM mission (PEO LMW 2008). There are five basic objectives that are considered for MCM missions (DON 2010):

- Exploratory: Determine whether mines are present within a certain confidence level.
- Reconnaissance: Determine the minefield characteristics including the number of mines.
- Breakthrough: Reduce the threat to shipping in an area within a certain amount of time through mine clearance.
- Clearing: Remove the greatest number of mines from an area to an acceptable level of risk.
- Attrition: Remove mines from a field as they are added to maintain a certain risk level.

Though different strategies are used, with some missions meeting several objectives, a clearance mission in deep water was considered for analysis based on stakeholder feedback as to the relevant scenario to study.

Deep water is defined as water deeper than 200 feet and was selected for this project because this depth is the common depth for SLOCs, such as shipping channels, and has the potential to have less variability due to terrain effects of shallow water. The goal was to use the scenario context to answer the following questions:

- What are the capabilities (parameters) that have the largest impact on the effectiveness of the MCM operations?
- How does the method of mine clearing (i.e., serial or parallel) impact the effectiveness of the different MCM platforms?
- What are the performance and execution time differences of the different configured platforms in the conduct of mine clearing operations?

Figure 37 depicts a general scenario in which two variants of legacy MCM systems and one variant of future MCM will be compared, with respect to the clearing of a 10 NM by 10 NM (100 NM²) portion of a SLOC. Given that each MCM 1 and LCS variant conducts MCM differently, the common metrics of ACRS, defined as the area (in NM²) cleared of mines in a 24-hour period, and the percent effectiveness, defined as the

percentage of mines successfully neutralized, were used to compare each variant for minehunting.

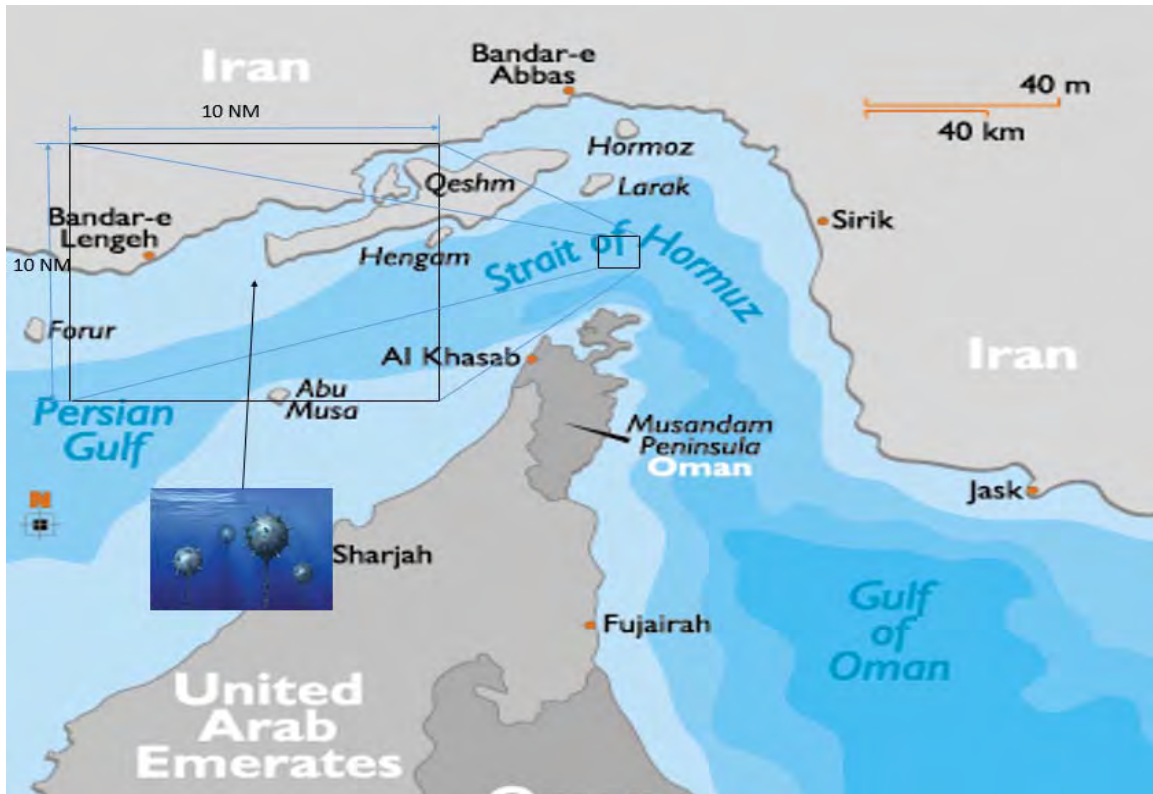

Figure 37. Common Deep-Water SLOC Scenario

The aforementioned transitional environment is the situation considered by this project in addressing and analyzing some important stakeholder questions. The comparative analysis accounted for the first LCS MCM increment capabilities as well as two different configurations of the MCM 1 platforms with a complement of MH-53E helicopters. As described in Chapter I, the MCM 1 platforms assigned to the 7th Fleet area of responsibility are equipped with the newer SeaFox mine neutralizer system, and the MCM 1 platforms assigned to the 5th Fleet have the older AN/SLQ-48 mine neutralizer systems (LT Andrew Watts, personal communication, 10 July 2014). Consequently, a robust scenario was developed that helped to drive the M&S process to ensure that a thorough analysis was conducted to evaluate the performance in terms of percent clearance (effectiveness) and ACRS between the different MCM configurations. A total of three specific

alternative system configurations were required to conduct a direct comparison between two MCM 1 platforms with their complement of MH-53E helicopters and Increment 1 of the LCS MCM systems. Table 10 lists the system complement and capabilities projected to be afforded by the four increments of the LCS MCM mission package (GAO 2013).

Table 9. LCS Incremental Capabilities (after GAO 2013)

MCM Mission Package	INC 1	INC 2	INC 3	INC 4	Capability
ALMDS	X				Detect, classify, and localize near surface mines
AMNS	X		X*		Identify and neutralize bottom and moored mines in shallow water. *add near surface mines
AN/AQS-20A	X				Detect, localize, classify of bottom mines in deep water
RMS	X				Remote vehicle that tows AN/AQS-20A
Coastal Battlefield Reconnaissance and Analysis System		X			Provide intelligence preparation for the minefield
UISS			X		Unmanned surface vehicle that tows an influence sweep
Knifefish				X	Unmanned undersea system that detects buried mines

To normalize the basis for comparison, the same general operational deep water SLOC scenario was used to compare the system specific configurations shown in Figure 37. In addition, it was assumed that the SLOC had already been cleared of surface and near surface mines. This assumption allowed the focus to be on hunting bottom mines in deep water, where each configuration had comparable capability based on system complements. This assumption also allowed the analysis to be limited to the first LCS mission package, Increment 1, since it provides all necessary systems for hunting bottom mines. Additionally, the following MCM system context assumptions were made:

- Only bottom mines were evaluated.

- The area was predefined.
- The density and number of mines were fixed.
- The locations of the mines and non-mines was randomly selected.
- No effects of different sea conditions were considered.
- No external threats were modeled or studied in this project.

The stakeholders wanted the comparison to include the current MCM 1 configurations for 5th Fleet and 7th Fleet. Furthermore, as the minehunting operations of the MCM 1 ships are conducted in different ways (parallel and serial), two different scenarios for each configuration had to be evaluated for a total of four MCM 1 scenarios. The LCS configuration and operation made the fifth configuration to be studied. Table 10 summarizes these five configurations.

Table 10. Operational Scenario Configuration

Configuration	Ship	Helicopter	Subsystems
1A	MCM 1	MH-53E	MCM 1: AN/SQQ-32, SLQ-48 MH-53E: AN/AQS-24 Hunt Method: Serial
1B	MCM 1	MH-53E	MCM 1: AN/SQQ-32, SeaFox MH-53E: AN/AQS-24 Hunt Method: Serial
2A	MCM 1	MH-53E	MCM 1: AN/SQQ-32, SLQ-48, MH-53E: AN/AQS-24, SeaFox Hunt Method: Parallel
2B	MCM 1	MH-53E	MCM 1: AN/SQQ-32, SeaFox MH-53E: AN/AQS-24, SeaFox Hunt Method: Parallel
3	LCS	MH-60S	LCS: RMS with AN/AQS-20 MH-60S: Archerfish Hunt Method: Serial

The actual M&S for these comparative configurations was conducted using a combination of M&S tools including Excel and ExtendSim. Additional modeling processes such as DOE, nearly orthogonal Latin hypercube (NOLH), and linear regression were utilized, as introduced in Chapter II and described in Chapter VII, to determine the system parameters that have the highest impact on the performance of the minehunting

functions. The configurations considered in addressing the scenario based on stakeholder feedback are shown in Tables 11–13.

Table 11. Configurations 1A and 1B: MCM 1 with MH-53E (Serial Hunt)

Situation:	A red force navy has laid a minefield in a blue force SLOC. The dimensions of the minefield are 10NM x 10NM (100 NM ²). Currently there is a MIW task group on station consisting of four MCM 1 ships outfitted with SQQ-32 sonar and SLQ-48 (Configuration 1A) or Sea-Fox (Configuration 1B) neutralizers. For air support, one LHD is on station carrying four MH-53E Sea Dragons outfitted with the side scan AQS-24A sonar. Currently the task force is located outside of the minefield, only the MH-53Es have been operating inside of the minefield due to a large number of shallow water mines that have been neutralized with the MH-53E's minesweeping gear. Currently, 100 percent of the surface and shallow water mines have been neutralized by the MH-53Es, MCM 1s, or EODs. The rest of the mines in the SLOC are deep water bottom mines which will require the cooperative mine hunting efforts of the MCM 1 and the MH-53Es. The MCM 1 will detect, classify, identify and neutralize mines while the MH-53E will, in parallel, detect and classify mines to be neutralized later by a MCM 1.
Mission:	Complete the clearing of the deep water mines in the SLOC with the MCM 1 and MH-53E.
Execution:	On my command clear the mines out of the SLOC in the most efficient manner and with the highest level of confidence possible.
Admin & Logistics:	The MIW task force will be supplied with fuel, ordinance, spare parts, food, and water from a constant rotation of maritime prepositioning force ships (MPF) ships on rotation from Diego Garcia.
Command & Signal:	The LHD will be the flag ship, all commands and status reports will be communicated through encrypted blue force radio frequencies and data link. Report mission status updates to task force commander, as well as all mission MIW performance parameters and metrics. The task force commander is especially interested in the ACRS for each operational unit. MH-53E MILCOs will undergo PMA prior to being considered for neutralization

The complete physical architecture and functional flows are described in detail in Chapter IV. Figure 38 provides a high-level representation of how configuration 1 executes the scenario described in Table 11.

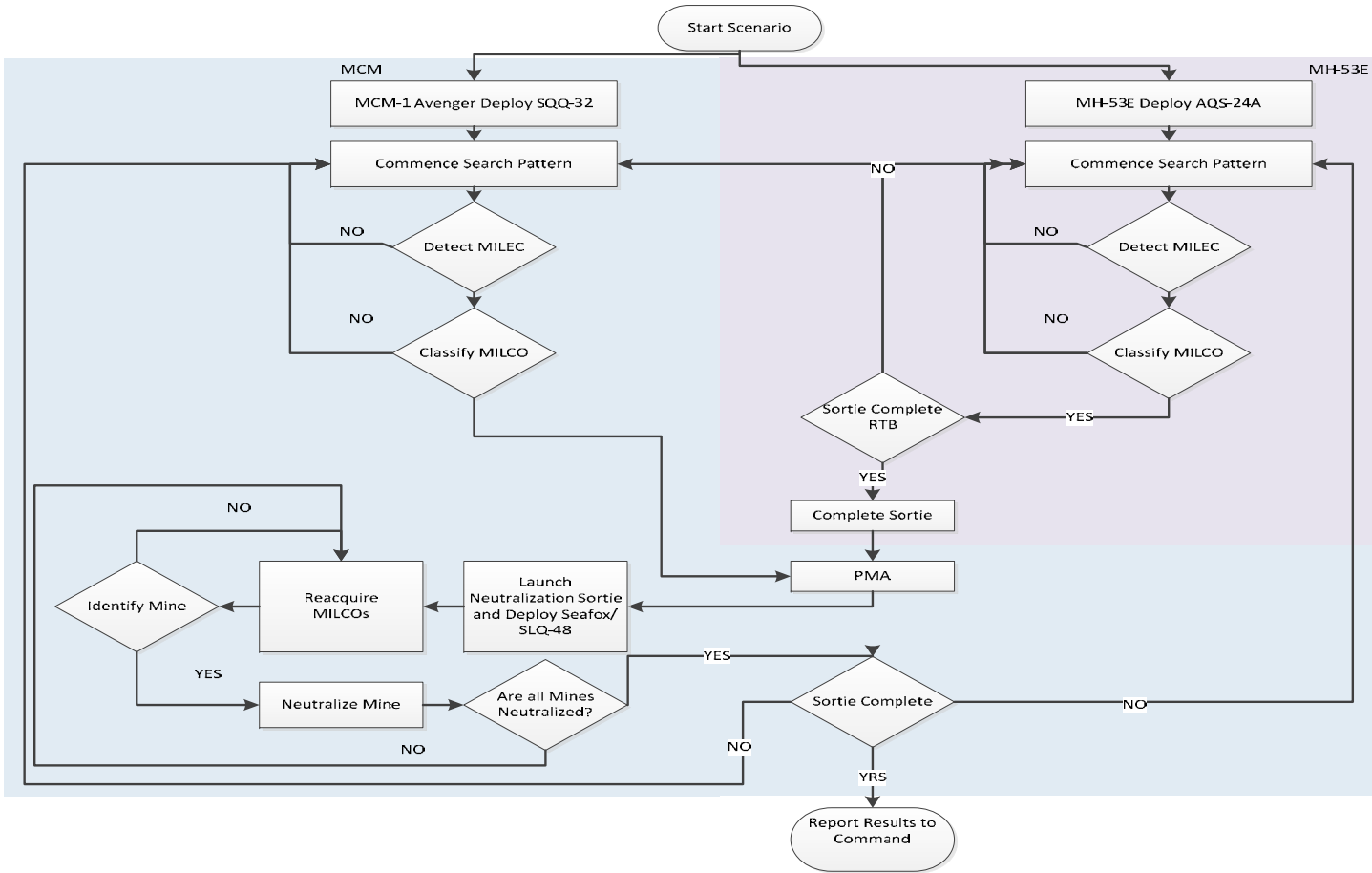

Figure 38. Configuration 1: MCM 1 with MH-53E (Parallel Hunt and Serial Neutralization)

Table 12. Configurations 2A and 2B: MCM 1 with MH-53E (Parallel Hunt)

Situation:	A red force navy has laid a minefield in a blue force SLOC. The dimensions of the minefield are 10NM x 10NM (100 NM ²). Currently there is a MIW task group on station consisting of four MCM 1 ships outfitted with SQQ-32 sonar and SLQ-48 (Configuration 2A) or Sea-Fox (Configuration 2B) neutralizers. For air support, one LHD is on station carrying four MH-53E Sea Dragons outfitted with the side scan AQS-24A sonar and SeaFox neutralizers. Currently the task force is located outside of the minefield; only the MH-53Es have been operating inside of the minefield due to a large number of shallow water mines that have been neutralized with the MH-53E's minesweeping gear. Currently, 100 percent of the surface and shallow water mines have been neutralized by the MH-53Es, MCM 1s, or EODs. The rest of the mines in the SLOC are deep water bottom mines which will require the cooperative mine hunting efforts of the MCM 1 and the MH-53Es. The MCM 1 will detect, classify, identify and neutralize mines. The MH-53E will, in parallel, first detect and classify mines to be neutralized later by either a MCM 1 or MH-53E.
Mission:	Complete the clearing of the deep water mines in the SLOC with the MCM 1 and MH-53E.
Execution:	On my command clear the mines out of the SLOC in the most efficient manner and with the highest level of confidence possible.
Admin & Logistics:	The MIW task force will be supplied with fuel, ordinance, spare parts, food, and water from a constant rotation of MPF ships on rotation from Diego Garcia.
Command & Signal:	The LHD will be the flag ship, all commands and status reports will be communicated through encrypted blue force radio frequencies and data link. Report mission status updates to task force commander, as well as all mission MIW performance parameters and metrics. The task force commander is especially interested in the ACRS for each operational unit. MH-53E MILCOs will undergo PMA prior to being considered for neutralization.

Figure 39 provides a high-level representation of how configuration 2 executes the scenario described in Table 12.

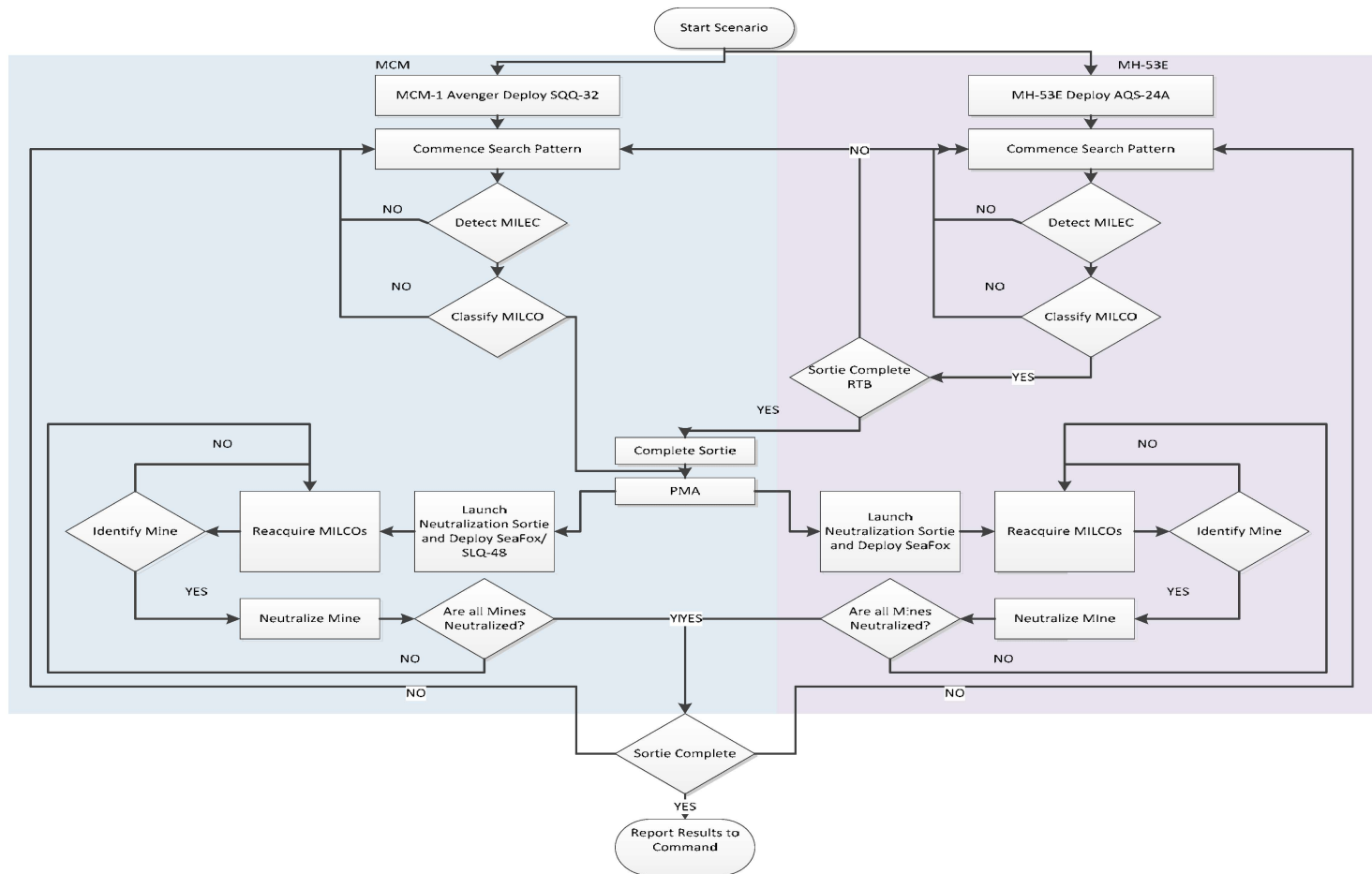

Figure 39. Configuration 2: MCM 1 with MH-53E (Parallel Hunt and Parallel Neutralization)

Table 13. Configuration 3: LCS Increment 1

Situation:	A red force navy has laid a minefield in a blue force SLOC. The dimensions of the minefield are 10NM x 10NM (100 NM ²). Currently there is a MIW task group on station consisting of four LCS (MIW Mission Package Increment 1) ships, each carrying one MH-60S SeaHawk. The task force is located outside of the minefield; only the MH-60Ss have been operating inside of the minefield due to a large number of shallow water mines that have been detected and classified with the MH-60S's ALMDS laser scanner system, and identified and neutralized by the MH-60S Archerfish system. Currently 100 percent of the surface and shallow water mines have been neutralized by the MH-60Ss or EODs. Now that the shallow water mines have been neutralized, the LCS will need to engage the minefield. It will launch the RMS towing the AQS-20 sonar to detect and classify mines. The MH-60S and flight crew will be standing by ready to identify and neutralize mines once the RMS/AQS-20 sweeps and a PMA to identify targets is complete.
Mission:	Complete the clearing of the deep water mines in the SLOC with the LCS and MH-60S.
Execution:	On my command clear the mines out of the SLOC in the most efficient manner and with the highest level of confidence possible.
Admin & Logistics:	The MIW task force will be supplied with fuel, ordinance, spare parts, food and water from a constant rotation of MPF ships on rotation from Diego Garcia.
Command & Signal:	The USS <i>Freedom</i> (LCS-1) will be the flag ship, all commands and status reports will be communicated through encrypted blue force radio frequencies and data link. Report mission status updates to task force commander, as well as all mission MIW performance parameters and metrics. The task force commander is especially interested in the ACRS for each operational unit. RMS MILCOs will undergo PMA prior to being considered for neutralization.

The complete physical architecture and functional flows are described in detail in Chapter IV, but Figure 40 provides a high-level representation of the way in which configuration 3 executes the scenario described in Table 13.

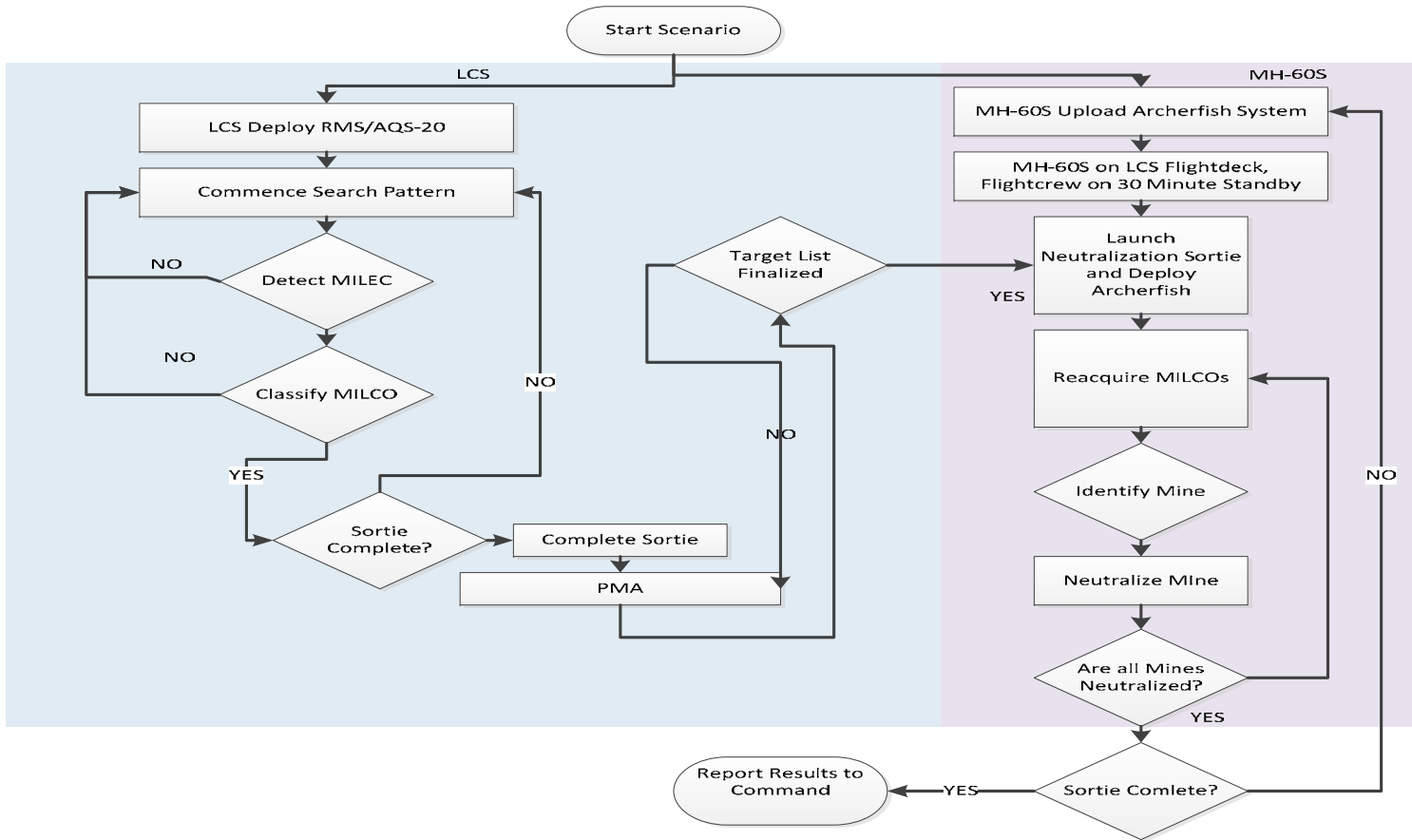

Figure 40. Configuration 3: LCS Increment 1

D. OPERATIONAL CONCEPT AND SCENARIO SUMMARY

Based on feedback from sponsors and input from SMEs, a relevant scenario was developed for comparative analysis between the performances of legacy MCM systems and future MCM systems. Specifically, clearance of an area within a deep water SLOC of bottom mines was considered with three different configurations. These configurations were represented IAW the functional and physical architectures. Once the operational scenario was defined, the modeling was initiated. The model provided the method through which the comparative analysis was conducted.

THIS PAGE INTENTIONALLY LEFT BLANK

VI. MODEL AND SIMULATION DEVELOPMENT

This chapter discusses the development of the models designed as a result of the SE process followed. As discussed in Chapter V, a total of five different configurations needed to be modeled (four legacy configurations and one future configuration). This chapter describes the modeling and simulation tool, ExtendSim, as well as how the decision was made to use this particular tool for this study. This chapter then delves into a brief discussion of the models, the methodology behind the models, and instructions on how to run the models. This chapter also includes an overview of how to configure the inputs of the models to run a simulation, and is heavily tied to Appendix C, which contains more detailed information. Additional detail about the models is included in a separate *Software Design Document* (SDD) that is available with the models (see Appendix D).

A. CHOICE OF MODELING AND SIMULATION TOOL

Two M&S tools were considered for the comparison of legacy and future MCM capabilities. The MIW Team initially planned to use ExtendSim (Diamond 2007) based on previous experience with ExtendSim during the Capabilities Engineering course (SE3250) of the MSSE/MSES program, but was made aware of the MANA tool as a possible alternative. In ExtendSim, models are built by the user from configurable building blocks in a graphical programming environment coupled with the ability to integrate hand-written code. MANA, on the other hand, is a cellular automation model within the general class of agent based models (ABMs), in which entities in the model interact with their surroundings in an adaptive way, including behavioral modeling of the entities through the use of “personalities” (McIntosh et al. 2007). The model is already coded and must be configured through user-selection of inputs. The following sections describe the major features of ExtendSim and MANA, followed by an evaluation of the tools for use in this project.

1. ExtendSim

ExtendSim is a commercial off-the-shelf (COTS) application developed by Imagine That Inc. (Diamond 2007). ExtendSim is a simulation tool that allows the user to de-

velop dynamic models through a graphical interface that provides access to libraries of building blocks to represent a wide range of real-world processes, such as queuing and transport delays, as well as mathematical and statistical functions. The individual blocks can be configured through graphical user interfaces (GUIs) to modify their behaviors. ExtendSim also has an equation editor for creating custom algorithms to add functionality not already present in the block libraries. ExtendSim is designed for rapid prototyping so that basic functionality can be achieved quickly and then additional complexity or fidelity can be added as needed, which is facilitated by allowing unlimited hierarchical decomposition to allow the user to produce a modular design with reusable components. According to the ExtendSim User Guide (Diamond 2007), ExtendSim can be used to “dynamically model continuous, discrete event, discrete rate, agent-based, linear, non-linear, and mixed-mode systems” (5).

ExtendSim also includes probabilistic elements to enable Monte Carlo analysis, which is supported not only in terms of data input and output, but also by the algorithms used within the model itself. Due to the uncertainties in the source data (due to natural variations, as well as the need to use unclassified data rather than system specific data), the ability to perform Monte Carlo analysis was a critical feature in tool selection for the MIW Team. The ExtendSim User Guide (Diamond 2007) provides the following description of Monte Carlo modeling:

Monte Carlo modeling uses random numbers to vary input parameters for a series of calculations. These calculations are performed many times and the results from each individual calculation are recorded as an observation. The individual observations are statistically summarized, giving an indication of the likely result and the range of possible results. This not only tells what could happen in a given situation, but how likely it is that it will happen. (47)

These factors led to the need to model the MCM systems using a range of values for the individual system parameters within a DOE approach. The data-passing capabilities of ExtendSim, particularly the ability to import and export data between the built-in ExtendSim data tables and Excel, make it ideally suited to performing DOE studies.

Members of the MIW Team had some limited experience with ExtendSim from previous course work in the Capabilities Engineering course (SE3250) of the MSSE/MSES program; however, the MIW Team was unfamiliar with some of the more advanced features of ExtendSim, such as 3-D animation, application programming interfaces (APIs) to access code created in high level languages (such as C++), and some of the other features such as ABM. Even limited the use of ExtendSim to some of its more basic capabilities, the MIW Team considered ExtendSim as a viable option because of the ability to develop a model specific to the analysis requirements rather than configuring an existing model not build to the project's requirements.

2. MANA

The MANA software (McIntosh et al. 2007) is an ABM that has been in development by New Zealand's Defence Technology Agency (DTA) since 2000. ABMs are a class of models that contain entities whose actions are controlled by decision-making algorithms. Within the general class of ABMs, MANA is a cellular automation (CA) combat model. A characteristic of CA models is the adaptive way in which the entities in the model interact with their surroundings. Unlike other CA combat models, "the MANA model uses a 'memory map' to provide shared situational awareness and guide entities about the battlefield" (McIntosh et al. 2007, iii). A key aspect of MANA is the behavioral modeling of the entities through the use of "personalities" that dictate their behaviors in response to one another and the environment. Entities may have weapons, sensors, and expendables such as ammunition and fuel. MANA models play out on maps and can include concealment, cover, terrain, and vegetation. Friendly, enemy, and neutral forces can be included and designated by various icons. Built-in trigger states, such as making contact with the enemy or running out of fuel, can lead to different behaviors. MANA's strengths are the incorporation of combat factors such as: "change of plans due to the evolving battle; the influence of situational awareness when deciding an action; and the importance of sensors and how to use them to best advantage" (McIntosh et al. 2007, 5).

MANA takes its inputs from extensible markup language (XML) files, which can be edited directly or altered through the GUI. MANA can also be instructed to output into comma separated value (CSV) files several pre-determined parameters as the results of a run or set of runs. MANA can be configured in multi-run mode to run a scenario stochastically a number of times, with up to two of the parameters being systematically varied for each run. MANA also includes a genetic algorithm capability to optimize user-selected personality and agent characteristics based on predefined MOEs (McIntosh et al. 2007). Genetic algorithms mimic the natural selection process where the “genes” are selected input parameters of the model. With each successive run of the model the genes are varied slightly and those that do well in terms of the MOPs are propagated to the next generation. There is also a randomization element to the selection of genes that allows the complete solution space to be explored and makes it less likely that the solution will converge to a locally optimal solution and more likely to find the global maximum.

3. Evaluation for Utility in Capstone Study

Table 14 presents the primary functionality required for the M&S tool for this study, as well as features that may be required for possible future developments. These future developments may include the human decision making element of MCM rather than the prescriptive approach taken with the current study. This would also need to include messaging (transfer of information between agents) and perhaps genetic algorithms for optimization of strategies. This would also make it more important to include 3-D animation to view model outputs graphically and dynamically.

Table 14. Comparison of Functionality: ExtendSim vs. MANA

Current Model		
Functionality Required	ExtendSim	MANA
Design of experiments	Well supported	Limited
User-defined functions	Yes (ModL language)	No
MCM functionality	Can be created by user	Limited
Probabilistic features	Yes	Limited
Expendables (e.g., neutralizers, fuel)	Yes	Yes
Positional resolution	Continuously variable	1000x1000 grid

Future Development		
Functionality Required	ExtendSim	MANA
Messaging	Yes	Yes
Agent based modeling	Sample models available	Yes
Cellular automation	Sample models available	Yes
Genetic algorithm	Optimization (uses a similar evolutionary strategy)	Yes
3-D animation	Yes	Yes

4. Recommendation for Use

ExtendSim was chosen as the modeling program for use in this project. MANA had numerous technical drawbacks for application in this project and the MIW Team's lack of familiarity with MANA impacted the ability to work around these issues. The key issues were the limited capability to perform DOE studies with MANA and the inability to modify or add functionality to the library of available model components through direct insertion of source code with user-coded algorithms. Executing a DOE is difficult in MANA. Although it has a multi-run capability, which can be set to vary up to two variables, this capability is limited and does not allow for importing a DOE developed set of parameter values for execution (McIntosh et al. 2007). Additionally, MANA only has the functionality to represent the detection and classification, but not the identification, of the mine targets (McIntosh et al. 2007). Moreover, due to the limited information on actual system performance parameters available for the study, the model being created would rely on using ranges of factors and identifying critical points and factors of relatively large statistical significance to come to conclusions. Therefore, MANA's limited ability to effectively ingest a DOE set of runs for automatic execution was considered a critical failing.

If the models that have been developed during this study are to be developed further, the required functionality is believed to exist in ExtendSim; however, this will require familiarity with some of the more advanced features of ExtendSim. Some of that functionality is already contained in MANA. Therefore, an alternative approach may be a hybrid of ExtendSim and MANA. It should be noted, however, that in order to integrate these two tools it would first be necessary to define and implement an interface between

ExtendSim and MANA. Additional information regarding the evaluation of the modeling tools is contained within Chapter VI and Appendix B.

B. DESCRIPTION OF MODELS

Two MCM models were developed by the MIW Team to support the comparative analysis of legacy and future MCM capabilities. One model was developed for the legacy MCM 1 system and a separate model for the future LCS system. The decision to develop two separate models was made because of the differences in physical architecture of the two systems as well as differences in their concepts of operations. Although it would have been possible to create a single model to accommodate both systems, it would have made it difficult to trace specific parts of the model to each physical system. This lack of traceability would unnecessarily complicate the maintainability of a single model. Each model is implemented using the discrete event modeling feature within ExtendSim (Diamond 2007). Discrete event modeling involves the event-based modeling of distinct items. When events can be widely separated in time, discrete event modeling can lead to a more efficient code, rather than using a continuous modeling approach. In a continuous modeling approach, the simulation advances in a sequence of very small time increments requiring the computation of the simulation variables at every time step, rather than only when an event occurs.

Figure 41 shows the modularity that can be included in an ExtendSim model. The top portion of the illustration shows a number of “hierarchical blocks,” each representing a separate function. These hierarchical blocks will themselves be part of a higher-level hierarchical block representing a higher-level function. By the same token, each of the hierarchical blocks shown may itself comprise a set of hierarchical blocks, each representing a lower-level function. The use of these hierarchical blocks to encapsulate different functions results in modules that have high cohesion and low coupling. This facilitates both reuse and modification of the individual models. At the lowest level of the hierarchy, shown in the lower left portion of Figure 41, the modules will contain individual blocks from the ExtendSim function libraries that can be reconfigured by the user to vary their behavior. One of the blocks shown is an “equation” block that can be used to im-

plement the ModL programming language to add functionality not present in the standard libraries of ExtendSim blocks. A short segment of ModL code is shown in the lower right portion of Figure 41; however, apart from this example, the details of the model design and implementation are described in the SDD (see Appendix D) developed by the MIW Team as part of the development process.

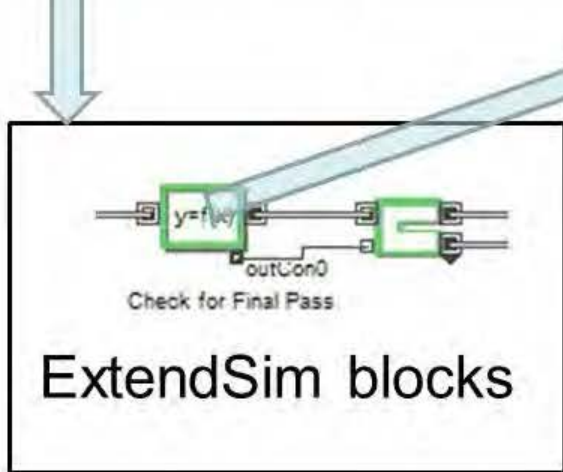
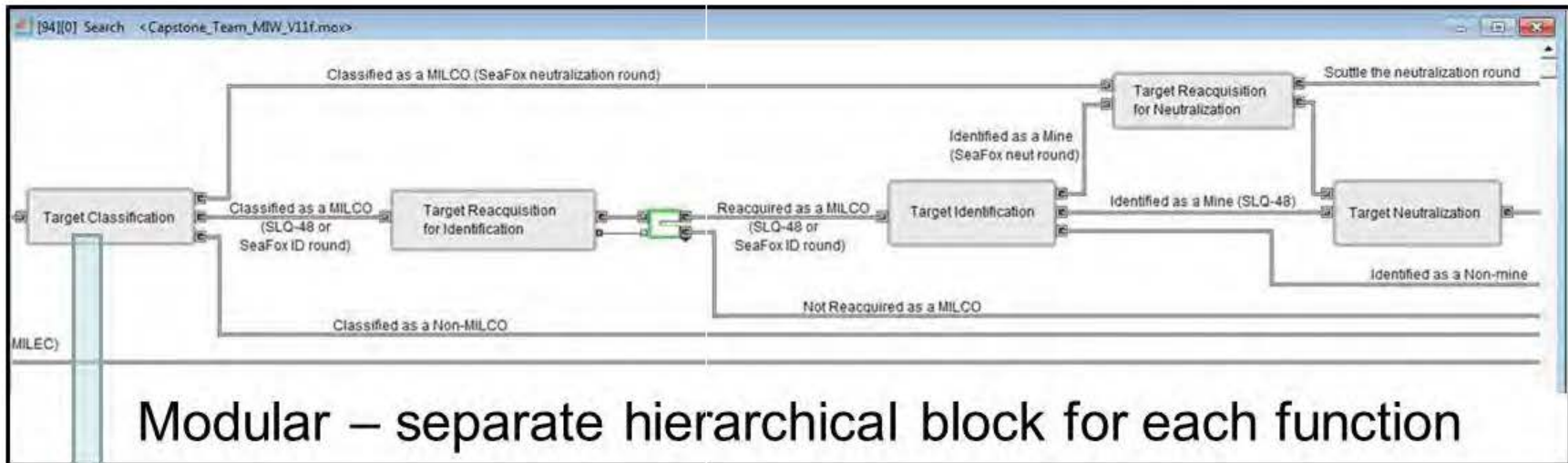

```

outCon0 = 0;

// Check to see if this is last pass on last track (search complete)

if (MaxY_NM - HuntYPos_NM < HuntTrkWdth_NM)
{
  If (CurrentPass == NumPassPerTrack) outCon0 = 1;
}

```

ModL programming language

Figure 41. ExtendSim Model—Decomposition

The model of the legacy MCM 1 system was developed first. The modular architecture of the models allowed considerable reuse of components and the model of the future LCS system was developed in less than 20 percent of the time taken to develop the model of the legacy MCM 1 system.

Four different configurations of the legacy MCM system and one configuration of the future LCS system needed to be modeled. The various configurations are summarized in Table 15. Although only one model is used for all four configurations of the legacy MCM 1 system, the different functions and physical characteristics of each of the four configurations are controlled through the settings used for various input parameters (See Section D and Section G).

Table 15. Overview of the MCM Configurations Modeled

Configuration	Model	Description
1A	Legacy	MCM 1 with SLQ-48 and MH-53E—Serial Hunt
1B	Legacy	MCM 1 with SeaFox and MH-53E—Serial Hunt
2A	Legacy	MCM 1 with SLQ-48 and MH-53E with SeaFox—Parallel Hunt
2B	Legacy	MCM 1 with SeaFox and MH-53E with SeaFox—Parallel Hunt
3	Future	LCS with RMS-AN/AQS-20A and MH-60S with Archerfish—Parallel Hunt

For configurations 1A and 1B, which are termed “serial hunt,” the first phase of the clearance mission involves the MCM 1 performing detection-to-neutralization in one part of the target area, while the MH-53E is assigned the remainder of the target area to perform detection and classification only. After the MH-53E has downloaded the detection and classification data at the end of each sortie, a PMA is performed to decide which contacts to reacquire for neutralization. The reacquisition of targets for neutralization only commences after both the MCM 1 and MH-53E have completed this first phase of operations in their respective portions of the target area. In the second phase of operations the MCM 1 alone performs the reacquisition-to-neutralization of targets identified by the MH-53E. For both phases of the operations, in configuration 1A the MCM 1 uses the SLQ-48, while in configuration 1B the MCM 1 uses the SeaFox.

For configurations 2A and 2B, which are termed “parallel hunt,” the first phase of the clearance mission involves the MCM 1 performing detection-to-neutralization in one part of the target area while the MH-53E is assigned the remainder of the target area to perform detection and classification only. This is identical to configurations 1A and 1B, respectively. After the MH-53E has downloaded the detection and classification data at the end of each sortie, a PMA is performed to decide which contacts to reacquire for neutralization. Again, the reacquisition of targets for neutralization only commences after both the MCM 1 and MH-53E have completed this first phase of operations in their respective portions of the target area. The reacquisition-to-neutralization is then performed by both the MCM 1 and the MH-53E working in parallel in different portions of the target area. In configuration 2A the MCM 1 uses the SLQ-48 while in configuration 2B the MCM 1 uses the SeaFox. The MH-53E uses the SeaFox in both configurations 2A and 2B to perform the reacquisition-to-neutralization.

For configuration 3 the clearance mission commences with the LCS releasing the RMS to detect and classify targets in the search area. At the end of each sortie, the RMS downloads data for a PMA to create a list of contacts to be reacquired for neutralization. This reacquisition-to-neutralization is performed by the MH-60S with Archerfish. After the RMS has completed its first sortie, and after the first PMA has been performed to create the initial list of contacts, the remainder of the mission proceeds with the RMS and MH-60S working in parallel. The RMS continues to detect and classify targets while the MH-60S performs the follow-on reacquisition-to-neutralization of contacts identified in the PMA. The list of contacts for reacquisition and neutralization is updated by performing a PMA at the end of each sortie of the RMS or the MH-60S.

1. Model of Legacy System MCM

This section provides an overview of the legacy system MCM model. A brief overview of the concept of operations, by phases, is given. This overview is a look at the functions and stages modeled throughout a MCM mission using the legacy system. This section also provides a description of the legacy model, as well as describing the steps

necessary to properly implement this model to provide meaningful results from the simulation.

a. Concept of Operations

This section provides the detailed description of the CONOPS for the legacy MCM system. It is divided into two phases; the first phase includes the operations involved with the initial detection through classification and the second phase begins with the reacquisition and identification through the neutralization operations.

(1) First Phase of Operations

Figure 42 shows the CONOPS for the MCM 1 and its onboard systems during the first phase of operations, as represented in the legacy MCM model. The MCM 1 will pass backwards and forwards across its assigned portion of the target area (shown in blue) in a series of parallel tracks starting at the lower edge of the target area and progressing upwards until the whole of its assigned portion of the target area has been covered. Although the MCM 1 is capable of sortie times up to a few weeks in duration, this may require multiple sorties. The MCM 1 first transits from the staging area to the edge of the target area closest to the staging area (shown by the green arrow labeled “1”) where it will stream its search equipment before entering the target area. It will then travel to the far end of the target area where it will turn onto a reciprocal heading on the next track. It will finish its sortie at the end of a track that is closest to the staging area, recover the search equipment and transit to the staging area where it will be replenished (shown by the red arrow labeled “1”). Additional sorties proceed in a similar fashion and Figure 42 shows two more sorties (the arrows labeled “2” and “3”). As targets are detected they will be classified. Any targets that are classified as MILCOs will be reacquired for identification and neutralization before resuming the search for additional targets. Figure 42 also shows the model parameters and variables that define the geometry of the area assigned to the MCM 1 and its position relative to the staging area. These model parameters are described in Section D.

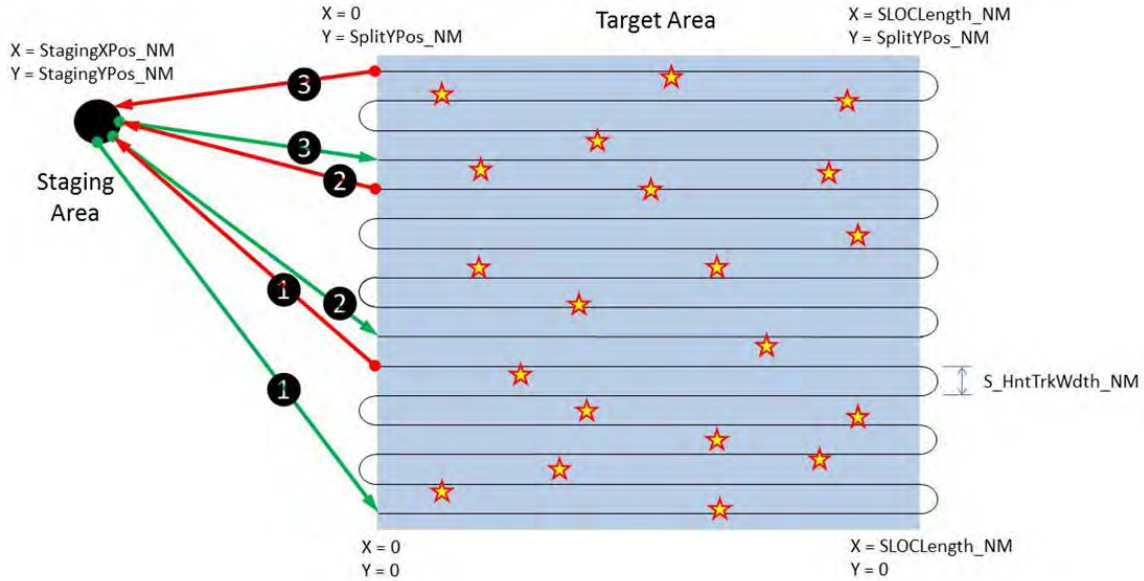

Figure 42. MCM 1—Detect to Neutralize

Figure 43 shows the CONOPS for the MH-53E as it searches for targets during the first phase of operations, as represented in the legacy MCM model. The MH-53E will pass backwards and forwards across its assigned portion of the target area (shown in blue) in a series of parallel tracks starting at the upper edge of the target area and progressing downwards until the whole of its designated portion of the target area has been searched. This will require multiple sorties. The MH-53E first transits from the staging area to the edge of the target area closest to the staging area (shown by the green arrow labeled “1”) where it will stream its search equipment before entering the target area. It will then travel to the far end of the target area where it will turn onto a reciprocal heading on the next track. Since the MH-53E will transit above the target area (and not through it like the MCM 1), it may finish its sortie at either end of a track where it will recover the search equipment before transiting to the staging area to be replenished (shown by the red arrow labeled “1”). Additional sorties proceed in a similar fashion and Figure 43 shows two more sorties (the arrows labeled “2” and “3”).

During each sortie a number of targets will probably have been detected and classified as MILCOs. These MILCOs will include mines and non-mines. Other targets, both mines and non-mines, will have failed to be detected, or failed to be classified as

MILCOs. The detection and classification data from the MH-53E undergo PMA to create a target list for reacquisition and neutralization, either by the MCM 1 alone or by both the MCM 1 and MH-53E. In the model the list is sorted by using a “nearest neighbor” approach as a solution to the “traveling salesman problem” to create a list of targets in the order in which they are to be reacquired. The duration of the PMA, following the completion of each MH-53E sortie, is modeled to be equal to the time spent on the search process by the MH-53E, per recommendation from the MIW SME (Brett Cordes, personal communication, 29 July 2014). Figure 43 also shows the model parameters and variables that define the geometry of the area assigned to the MCM 1 and its position relative to the staging area. These model parameters are described in Section D.

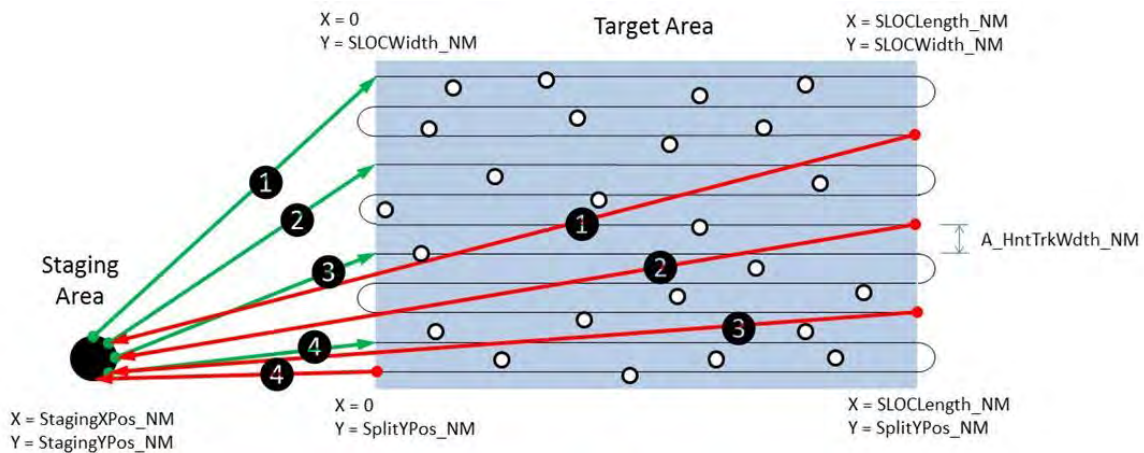

Figure 43. MH-53E—Detect and Classify

(2) Second Phase of Operations

Figure 44 shows the CONOPS for the MCM 1 and MH-53E to reacquire, identify, and neutralize targets during the second phase of operations, as represented in the legacy MCM model. When both the MCM 1 and MH-53E work in parallel it is termed “parallel hunt.” Alternatively, the MCM 1 may also perform this operation without the support of the MH-53E, which is termed “serial hunt.”

When working in parallel, the MCM 1 and MH-53E will be allocated different portions of the target area (shown by the dashed line across the target area, highlighted in

blue). The MCM 1 and MH-53E will transit directly to the first target on their individual target list created during the PMA (these transits are shown by the green arrows labeled “1”) and will then transit to each successive target on their list until it is necessary to terminate the sortie. For its first sortie, the MCM 1 will transit from the lower portion of the search area where it will have just completed the first phase of operations whereas the MH-53E will transit from the staging area. In the case of the MCM 1, sortie termination will be due to time constraints. However, in the case of the MH-53E, sortie termination could also result from using all of the onboard SeaFox neutralization rounds, if this comes first. At the end of its sortie each of the platforms will transit to the staging area (shown by the red arrows labeled “1”) for replenishment and another PMA will be performed. Any targets that have undergone a reacquisition attempt will be removed from the PMA-generated list. The list will then be resorted into the order in which the remaining targets should be reacquired. Additional sorties proceed in a similar fashion; Figure 44 shows one additional sortie for both the MCM 1 and the MH-53E (the arrows labeled “2”). Figure 44 also shows the model parameters and variables that define the geometry of the areas assigned to the MCM 1 and MH-53E and their position relative to the staging area. These model parameters are described in Section D.

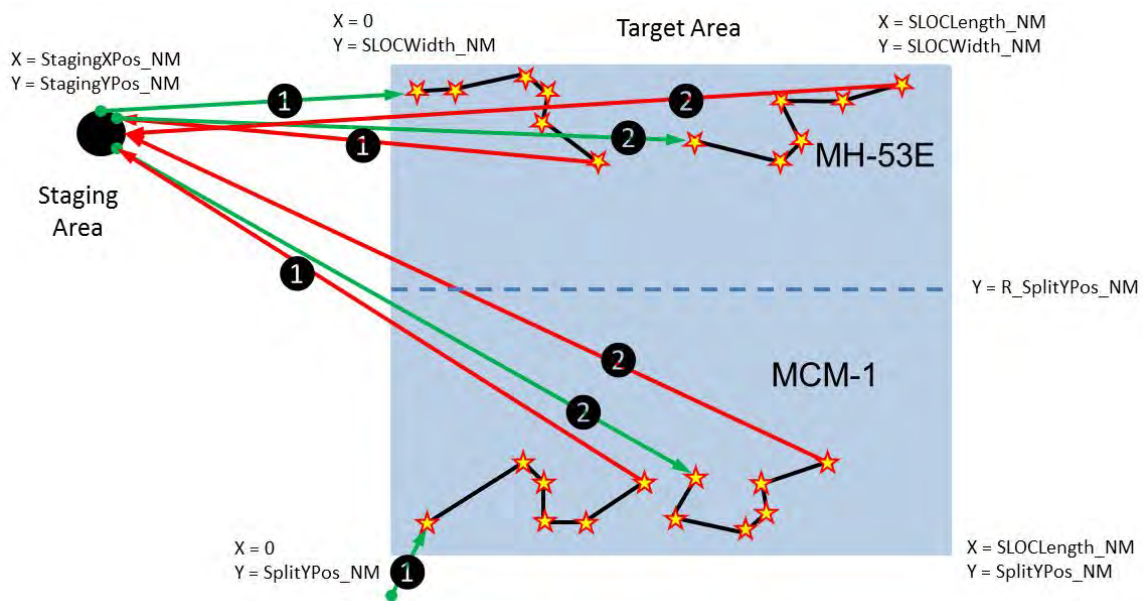

Figure 44. MCM 1 and MH-53E—RI&N

b. Model Design

The model sequence diagram in Figure 45 shows the top-level design for the legacy MCM model for the first phase of operations and Figure 46 illustrates the top-level design for the second phase of operations. The green colored blocks indicate the primary functions that will be executed by the model and the orange colored blocks are the primary decision points that affect the execution sequence of the functions. These diagrams are independent of the programming language used to implement the models. The design of the model required several iterations of the functional and physical architectures as well as the CONOPS. The need to design an executable model identified features that required further refinement to ensure consistency between different functions or physical components.

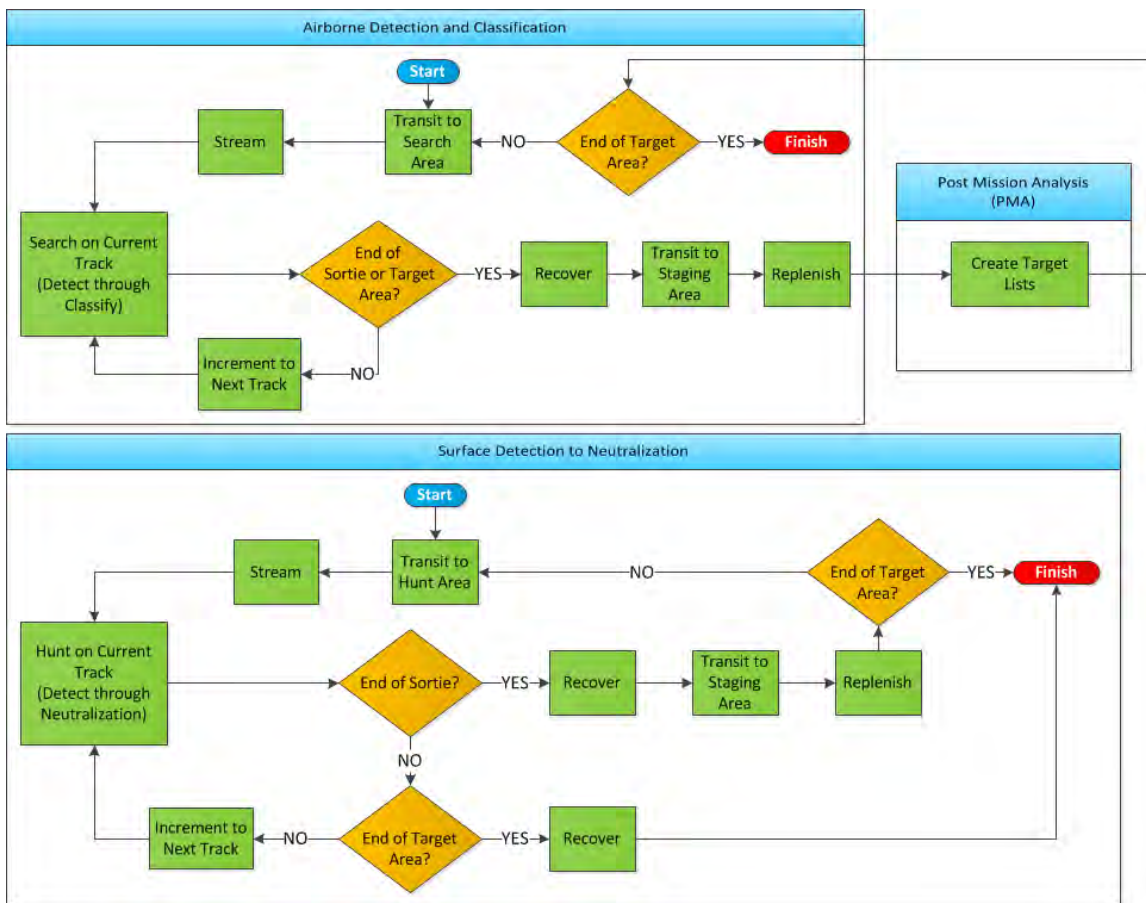

Figure 45. Legacy MCM Model—Top Level Model Sequence Diagram (Phase 1)

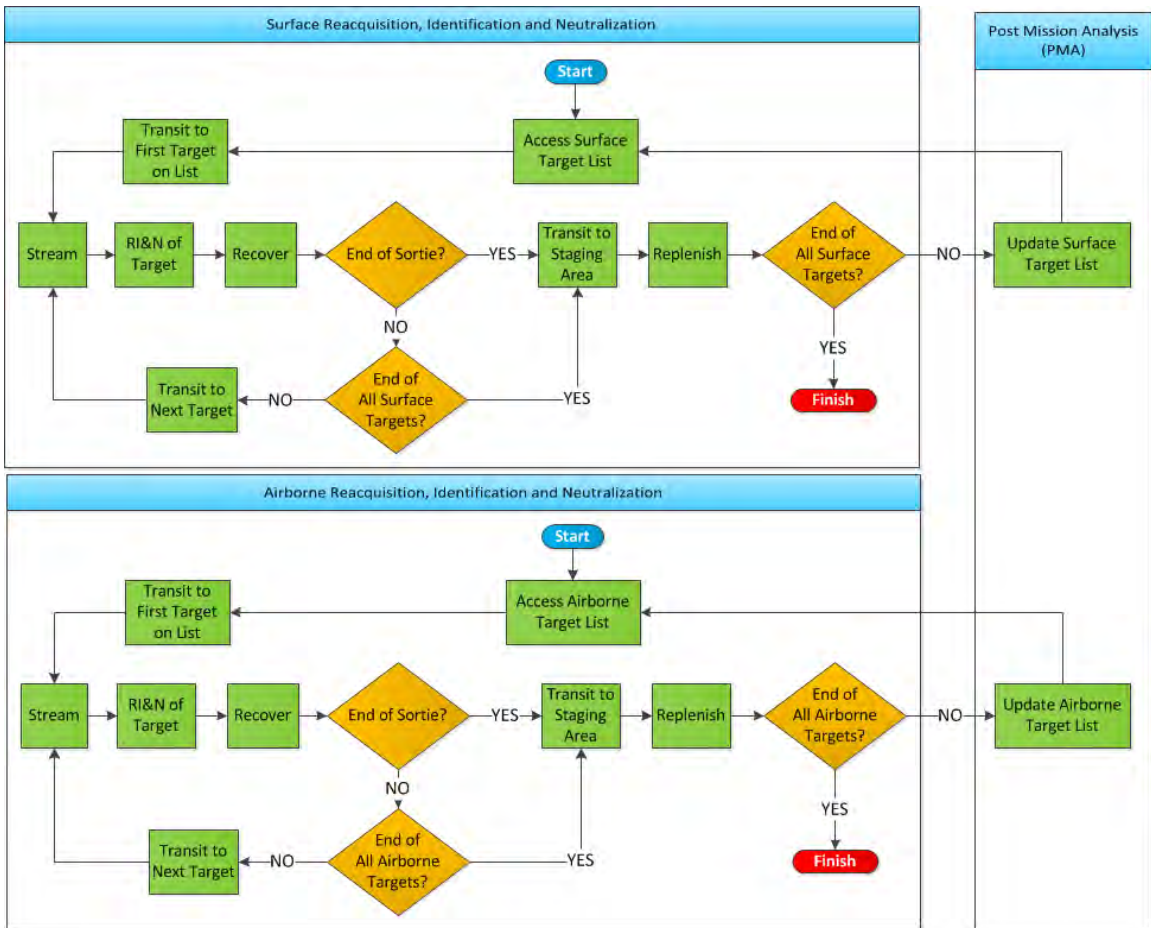

Figure 46. Legacy MCM Model—Top Level Model Sequence Diagram (Phase 2)

For the first phase of operations (shown in Figure 45) the model design comprises three top-level functions: airborne detection and classification; surface detection to neutralization; and PMA. The airborne detection and classification function models the MH-53 searching for targets from the air and this occurs in the upper portion of the target area. The surface detection to neutralization function models the MCM 1 hunting for targets from the surface and this occurs in the lower portion of the target area. These two portions of the model are independent of each other and proceed in parallel. Each one will terminate once the operations in the designated portion of the target area have been completed. The target detection and classification data from the airborne search will undergo PMA at the end of each sortie in the PMA function to create the target lists for the reacquisition of targets classified as MILCOs. Once the PMA has been completed for the

last airborne sortie by the MH-53E, and the MCM 1 has completed the last surface sortie, the model will progress to the second phase of operations.

In the second phase of operations (shown in Figure 46) the model also comprises three top level functions: surface RI&N; airborne RI&N; and PMA. The model allows both surface operations and airborne operations to proceed in parallel; however, it is possible to configure the model so that only surface operations are performed. In the second phase of operations the PMA is used to update the target lists at the end of each sortie to remove any targets that have been subject to reacquisition and to modify the order in which the remaining targets should be revisited. RI&N will continue until no more targets remain on the reacquisition lists.

There are several hierarchical levels below this top level of the model in which the various individual functions of the legacy MCM system and its operation are modeled. A complete hierarchy of the model is provided in the SDD (see Appendix D) developed by the MIW Team during the development process.

c. Model Implementation

The model of the legacy MCM system was implemented using the discrete event modeling feature of ExtendSim. The top-level view of the model is shown in Figure 47. The items within the model that are being transferred between the individual blocks are the targets (mines and non-mines). The individual blocks implement the various functions that can be performed by MCM systems together with the appropriate time delays. The “flow” of a particular target through the model will depend on the result of these individual functions, e.g., if a target is detected, it will be subject to further processing up to and including neutralization. The orange colored blocks are used to set up the global arrays. These global arrays are used to store information that can be accessed by any block within the model. Some of the functions, such as post mission analysis, need to be aware of the state of all targets and this is accomplished through the use of the global arrays.

The set initial conditions block reads in the input parameters and sets the initial values of the model variables. The first phase of operations is set up by dividing the target area into separate portions for the MCM 1 and MH-53E in the designate target areas

block. Operations of the MCM 1 and MH-53E then proceed in parallel in the surface search and hunt and airborne search blocks, respectively. The MCM 1 performs the surface search for targets followed by RI&N of any MILCOs while the MH-53E performs the airborne search for targets in a separate portion of the target area. At the conclusion of each sortie of the MH-53E, the targets classified as MILCOs by the MH-53E will be subject to PMA in the PMA block to build a target list for RI&N. This will be performed in the second phase of operations either by the MCM 1 working alone in the surface RI&N block, or by the MCM 1 in the surface RI&N block working in parallel with the MH-53 in the airborne RI&N block, each working in a separate portion of the target area. At the end of each sortie by the MCM 1 or MH-53E in the second phase of operations, a further PMA is performed to update the target list by removing any targets that have been the subject to a reacquisition attempt. After the completion of the clearance operations the output variables are written to data tables in the data output block.

There are several hierarchical levels below this top level of the model in which the various individual functions of the legacy MCM system and its operation are modeled. A complete hierarchy of the model is provided in the SDD (see Appendix D) developed by the MIW Team as part of the development process.

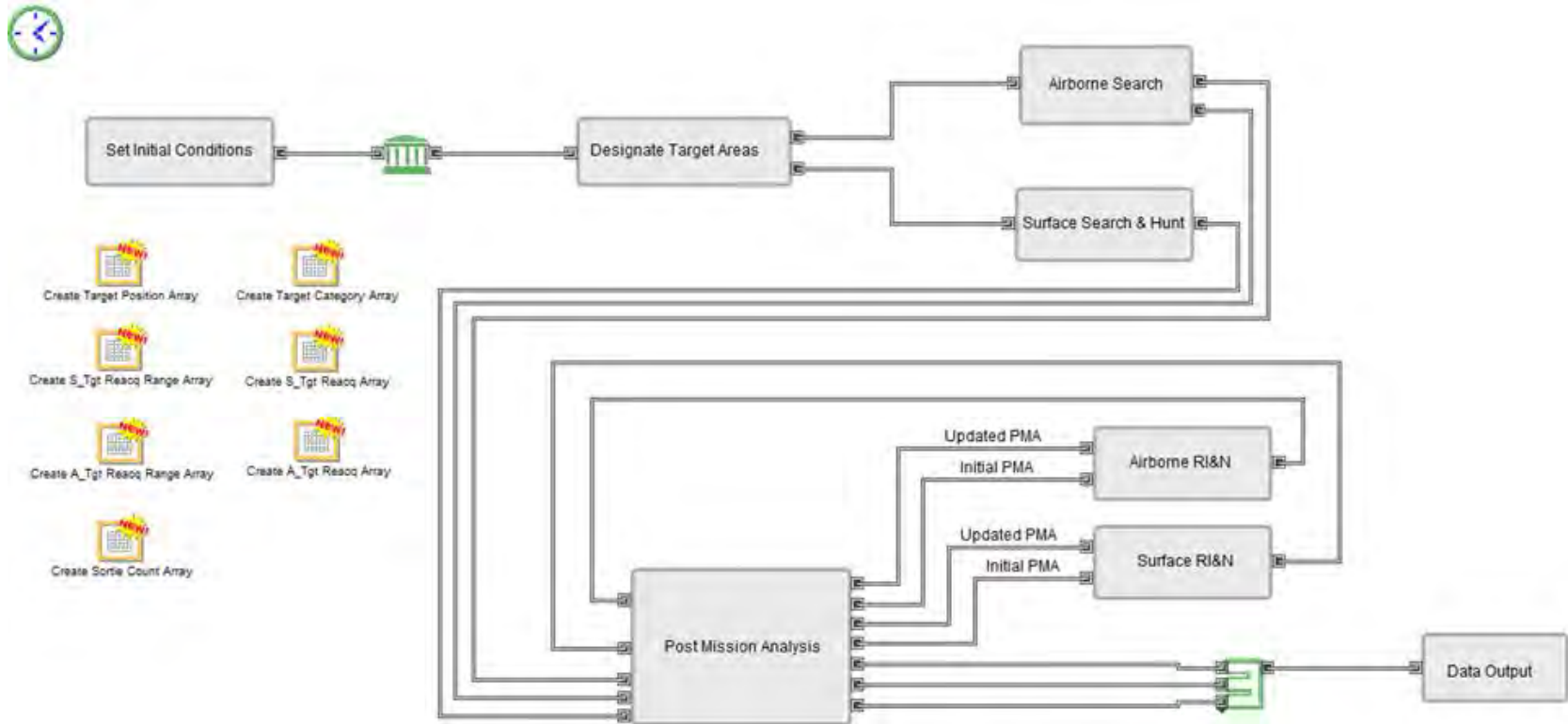

Figure 47. ExtendSim Model for Legacy MCM—Top Level View

2. Model of Future MCM Systems

This section provides an overview of the future system MCM model. A brief overview of the concept of operations is given. This overview is a look at the functions and stages modeled throughout a MCM mission using the future system. This section also provides a description of the future model, as well as describing the steps necessary to properly implement this model to provide meaningful results from the simulation.

a. Concept of Operations

Figure 48 shows the CONOPS for the LCS and its onboard systems, as represented in the future MCM model. The LCS remains in a staging area outside the target area. First the RMS is deployed to search the target area for mines. The RMS will pass backwards and forwards across the target area in a series of parallel tracks starting at the lower edge of the target area (the whole of the area marked by the two shades of blue) and progressing upwards until the entire target area has been searched. This will require multiple sorties. The second sortie for the RMS is illustrated in Figure 48. The RMS first transits from the staging area to the edge of the target area closest to the staging area (shown by the green arrow labeled “2”) where it will stream its search equipment before entering the target area. It will then travel to the far end of the target area where it will turn onto a reciprocal heading on the next track. It will finish a sortie at the end of a track that is closest to the staging area, recover the search equipment, and transit to the staging area where it will be replenished (shown by the red arrow labeled “2”). A number of targets, both mines and non-mines, will probably be detected and classified as MILCOs while other targets will fail to be detected or fail to be classified as MILCOs.

The detection and classification data from the RMS undergo PMA to create a target list for RI&N by the MH-60S using Archerfish. As in the legacy model, the list is sorted by using a “nearest neighbor” approach to create a list of targets in the order in which they are to be reacquired. The MH-60S will transit directly from the staging area to the first target on the list (shown by the green arrow labeled “1”) and will then transit to each successive target on the list until it has to terminate the sortie due to time constraints or due to the depletion of the onboard Archerfish neutralization rounds, whichever comes

first. At the end of each sortie the MH-60S will transit to the staging area where it will be replenished (shown by the red arrow labeled “1”). In Figure 48, the first sortie of the MH-60S is illustrated and this takes place in the area already searched by the RMS (the area shaded in darker blue). The MH-60S will continue to execute the process of reacquiring, identifying, and neutralizing targets, working in the area previously searched by the RMS, until no more MILCOs remain. After each sortie by the MH-60S, an additional PMA is performed. New MILCOs classified by the RMS will be added to the list at the end of each RMS sortie and any targets that have undergone a reacquisition attempt by the MH-60S will be removed from the list. The list will then be resorted into the order in which the targets should be reacquired. Again, the duration of each PMA, following the completion of an RMS sortie, is equal to the time spent on the search process by the RMS. Figure 48 also shows the model parameters and variables that define the geometry of the target area its position relative to the staging area. These model parameters are described in Section D.

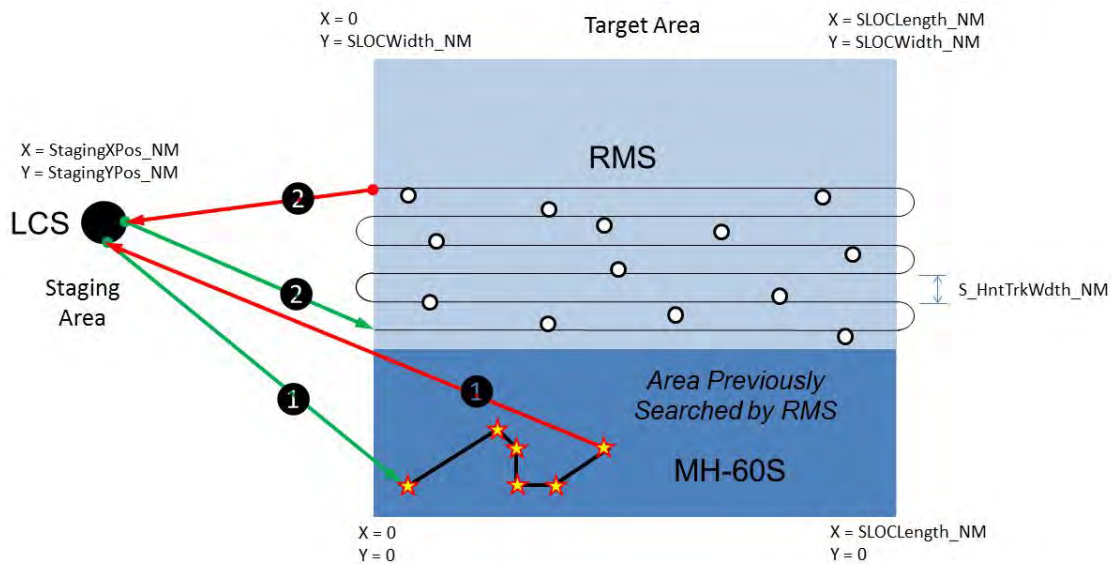

Figure 48. LCS (RMS) and MH-60S—Parallel Operations

b. Model Design

Figure 49 displays the model sequence diagram for the top-level design for the future MCM model. The green colored blocks indicate the primary functions that will be

executed by the model and the orange colored blocks are the primary decision points that affect the sequence of execution of the functions. This model sequence diagram is agnostic to the programming language used to implement the models. The design of the model required several iterations of the functional and physical architectures as well as the concept of operations. The need to design an executable model identified features that required further refinement to ensure consistency between different functions or physical components.

The model design comprises three top-level functions: surface detection and classification; airborne RI&N; and PMA. Surface detection and classification models the RMS searching for targets over the entire target area. Airborne RI&N models the MH-60S neutralization operations that also take place over the entire target area. The airborne RI&N can only commence after the RMS has completed its first sortie and after the post mission analysis function processes the RMS detection and classification data of the targets classified as MILCOs and builds a list of targets to be reacquired by the MH-60S. This means that the MH-60S may proceed no faster than the RMS can detect and classify targets. At the end of each sortie by the RMS, any targets classified as MILCOs will be subject to PMA to update the list of targets for reacquisition by the MH-60S. In addition, at the end of each sortie by the MH-60S, a PMA will be performed to remove any targets that were subject to reacquisition from the target list. The last sortie of the RMS will end once it has completed its search of the target area. After the last sortie of the RMS, no more targets will be added to the list of targets for reacquisition and then the last sortie of the MH-60S will end once there are no targets left on the reacquisition list.

There are several hierarchical levels below this top level of the model in which the various individual functions of the future MCM system and its operation are modeled. A complete hierarchy of the model is provided in the SDD (see Appendix D) developed by the MIW Team as part of the development process.

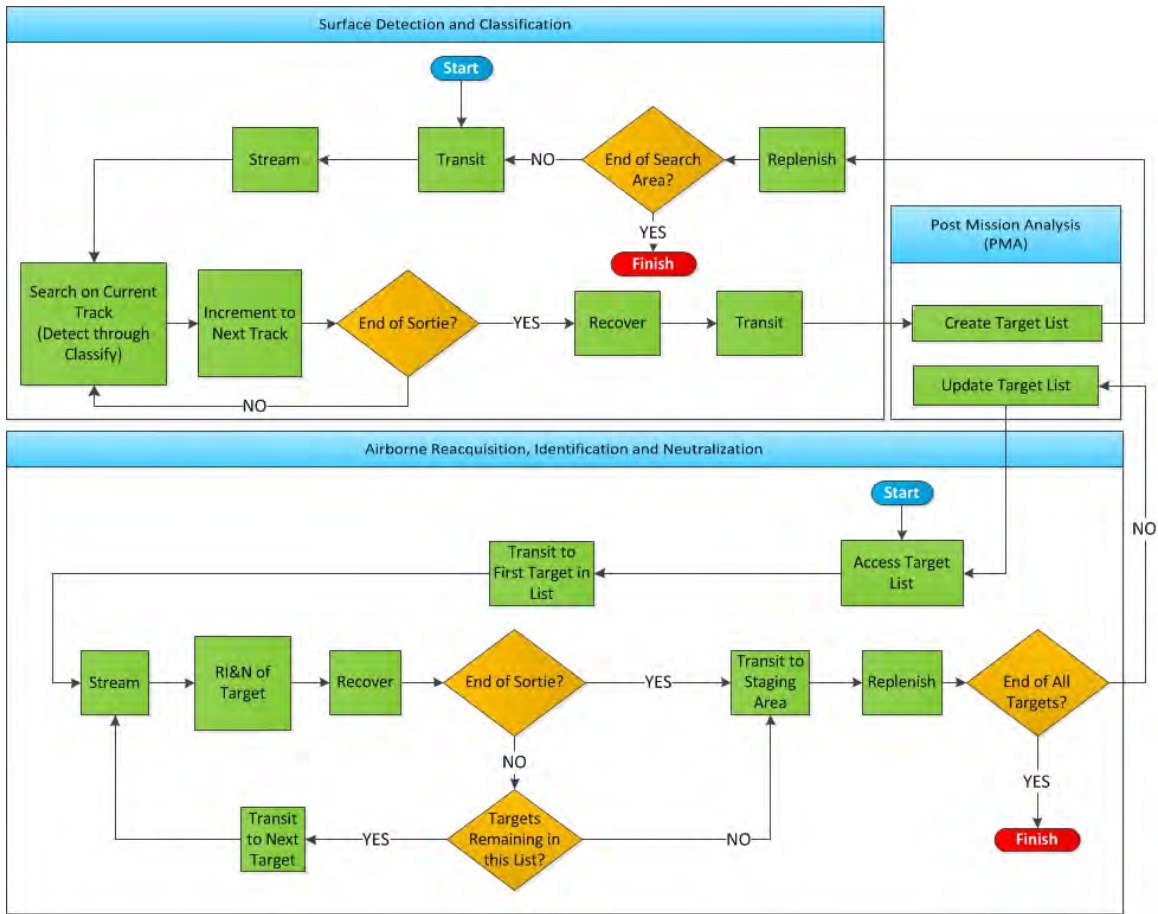

Figure 49. Future MCM Model—Top Level Model Sequence Diagram

c. Model Implementation

The model of the future MCM system was implemented using the discrete event modeling feature of ExtendSim. The top-level view of the model is shown in Figure 50. The items within the model that are being transferred between the individual blocks are the targets (mines and non-mines). The individual blocks implement the various functions that can be performed by MCM systems as well as accounting for the appropriate time delays. The “flow” of a particular target through the model will depend on the result of these individual functions, e.g., if a target is detected, it will be subject to further processing up to and including neutralization. The orange colored blocks are used to set up the global arrays. These global arrays are used to store information that can be accessed by any block within the model. Some of the functions, such as post mission analysis,

need to be aware of the state of all targets and this is accomplished through the use of the global arrays.

The set initial conditions block reads in the input parameters and sets the initial values of the model variables. The RMS performs the surface search for targets over the entire target area and this is implemented in the Surface Search block. As a result of each sortie by the RMS, a number of targets will have been detected and classified as MILCOs while other targets will have failed to be detected or failed to be classified as MILCOs. The MILCOs are sent to the PMA block to be processed into a target list for reacquisition and neutralization by the MH-60S. No further action will be taken against the non-MILCO targets, and they are sent to the data output block. The MH-60S will continue to execute reacquisition and neutralization sorties until no more MILCOs remain. After each sortie by the MH-60S, another PMA is performed in the PMA block to process any new MILCOS discovered by the RMS and to remove any MILCOs that were subject to a reacquisition attempt. The MILCOs that were subject to a reacquisition attempt are sent to the data output block since no further action will be taken against them. After the completion of the clearance operations, the output variables are written to data tables in the data output block.

There are several hierarchical levels below this top level of the model in which the various individual functions of the future MCM system and its operation are modeled. A complete hierarchy of the model is provided in the SDD (see Appendix D) developed by the MIW Team.

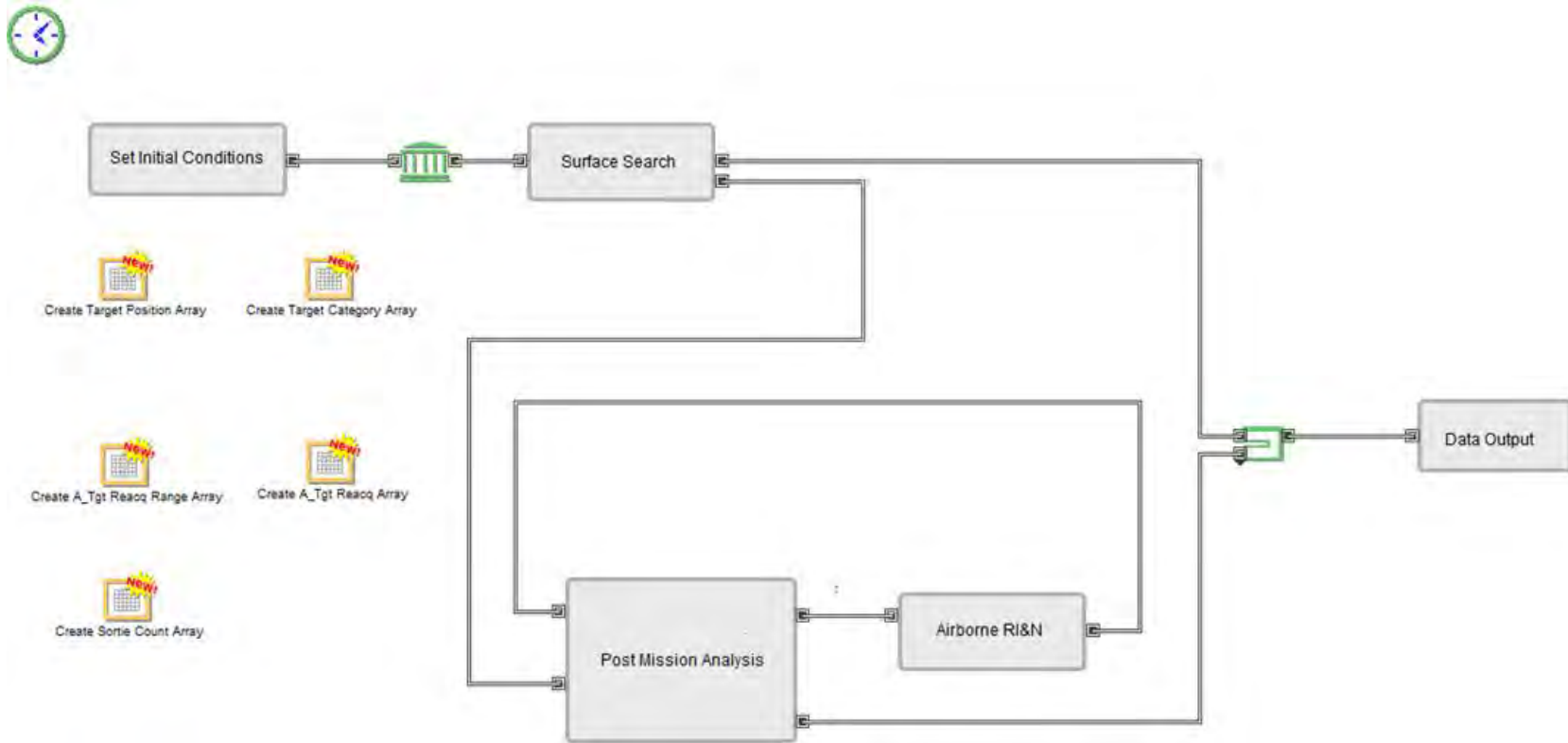

Figure 50. ExtendSim Model for Future MCM—Top Level View

C. MODELING ASSUMPTIONS

There are a number of assumptions made in the design and development of the models. Some were due to a lack of information and others were required to represent the MCM operations and performance within the constraints outlined in Chapter I. The assumptions were discussed with the advisors and/or MIW SMEs during the model development and are:

- The hunt for mines would be conducted over a rectangular area representing a SLOC.
- The only mines present would be bottom mines in water deeper than 200 feet. Near surface mines would have already been neutralized to permit safe operation of the MCM 1 and RMS in the target area.
- Only the mine clearance objective of the CONOPS was addressed in the model. Exploration, reconnaissance, breakthrough, and attrition were not modeled.
- Environmental effects that could affect MCM operations were not modeled. This includes sea state and weather that could affect MCM platform operations as well as water visibility and sea floor type that could affect detectability of mines.
- The staging area, where each sortie originates and terminates, was at a fixed location to the left (west) of the target area.
- The models accommodate multiple passes along the same track to improve the probability of detection of targets. A MILEC will be declared on a single detection from the multiple passes. Although multiple passes are accommodated by the model, SME input indicated (Brett Cordes, personal communication, 12 August 2014) that for the systems being considered within this project, the search speeds are slow enough to establish the persistence of targets on a single pass. If multiple passes are required to establish target persistence for detection purposes (e.g., “m” detections from “n” passes), the model will need to be modified.
- The areas assigned to the surface and airborne platforms were set by input parameters and were not varied dynamically during a run to reflect the progress made by each of the platforms.

The probability of detection was a single value and not a function of range. In PEO LMW Instruction 3370.1A (PEO LMW 2008) the probability of detection is characterized as a function of range from the sensor. If probability of detection were to be implemented in the model as a function of range then, as the number of tracks per nautical mile is increased (i.e., the lateral separation between tracks is decreased), this would in-

crease the probability of detecting a target. First, the maximum distance of a target from the sensor would be reduced (this is half the lateral separation between tracks) and there will also be a possibility of detecting a target on multiple tracks. Due to the lack of data to describe the probability of detection as a function of range, this range dependency was not included in the models. Therefore, in the models, changing the number of tracks per nautical mile will not change the probability of detecting a target. It is up to the user to determine how the probability of detection will vary with the number of tracks per nautical mile and to ensure that these two separate input parameters have consistent values. A procedure is described in PEO LMW Instruction 3370.1A (PEO LMW 2008, 50) in which the range-dependent probability of detection is used to compute a constant characteristic probability of detection over a characteristic width.

D. MODEL INPUTS

All of the input parameters for the model are contained within four ExtendSim data tables within the Inputs database, as shown in Figure 51. The data tables in ExtendSim contain a separate column for each parameter and each row represents a different run. These data tables can be created in other applications, such as Excel, and then copied and pasted into ExtendSim.

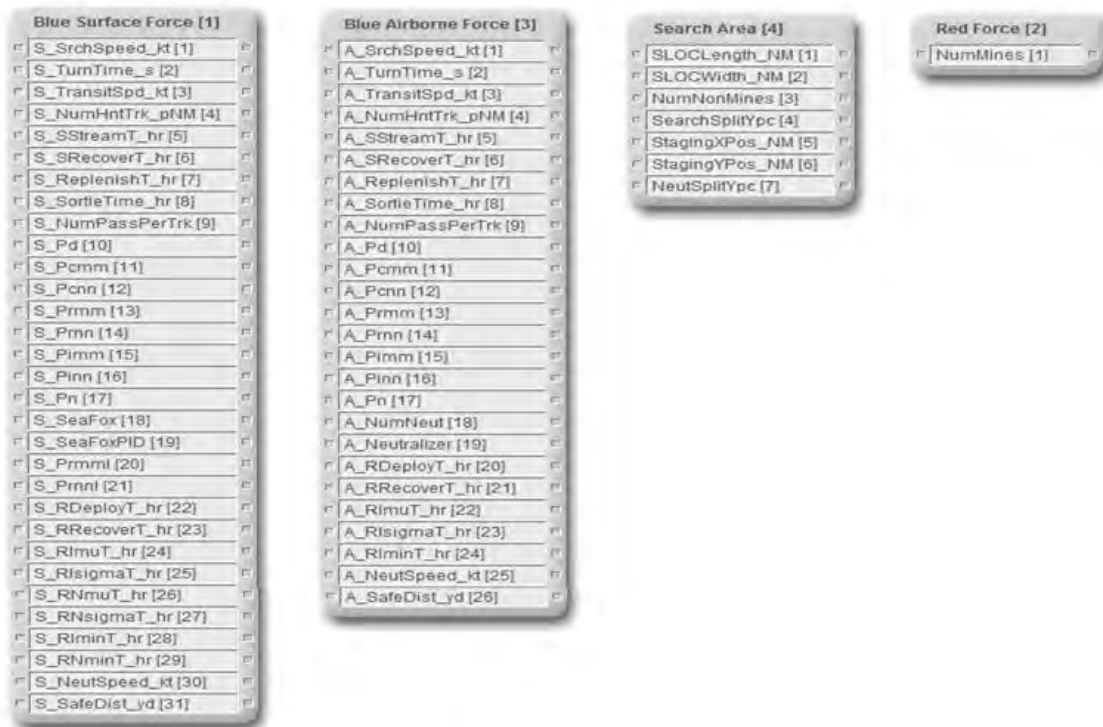

Figure 51. Model Input Parameters in Inputs Database

Many of these input parameters are taken from PEO LMW Instruction 3370.1A (PEO LMW 2008). In ExtendSim the names of the input parameters are limited to a maximum of 15 characters. Within this constraint, an attempt was made to make the parameter names as descriptive as possible. Also, where appropriate, the parameter name includes a suffix to indicate the physical units for that parameter. The naming convention for physical units of measure is provided in Table 16. In addition, for parameters in the Blue Surface Force data table the prefix “S_” indicates that the input parameter applies for the surface minehunting systems whereas, in the Blue Airborne Surface Force data table, the prefix “A_” indicates that the parameter applies to the airborne minehunting systems.

Table 16. Input Parameters—Physical Units of Measure Naming Conventions

Parameter Suffix	Physical Unit	Physical Quantity
_hr	hour	time
_kt	knot	speed
_NM	nautical mile	distance
_pNM	per nautical mile	1/distance
_s	second	time
_yd	yard	distance

The values of the input parameters can be varied within reasonable limits (e.g., probabilities should be between zero and one) but no checks are made in the model to ensure inputs will not cause the model to crash. The number of mines (“NumMines” in the Red Force data table) and the number of non-mine objects (“NumNonMines” in the Search Area data table) must both be greater than zero, but no more than 1,000, for the model to run. The input data tables can be set up for a single run, which may be repeated multiple times using the same parameter values, or set up to perform stacked runs, with different parameter values for each run, as part of a DOE.

The MIW Team decided to use the same data table structure for all of the configurations being modeled. If a parameter is not used by a particular configuration, the input value will be ignored. In the data table descriptions that follow, the cells for input parameters that are not required for a particular configuration are shaded gray. Table 17 describes the input parameters in the Blue Surface Force data table, Table 18 describes the input parameters in the Blue Airborne Force data table, Table 19 describes the input parameters in the Search Area data table, and Table 20 describes the one parameter in the Red Force data table. Also shown in the tables are the particular MCM systems that use each parameter value. Within each data table, the input parameters are listed in alphabetical order.

Table 17. Blue Surface Force Data Table

Input	Description	MCM 1				LCS
		1A	1B	2A	2B	3
S_NeutSpeed_kt	The transit speed of the surface deployed neutralizer.	SLQ-48	SeaFox	SLQ-48	SeaFox	
S_NumHntTrk_pNM	The number of search tracks per nautical mile in the Y-direction during the search phase of minehunting. The Y-axis is normal to the direction of the search tracks, with the origin at the lower boundary of the target area (PEO LMW 2008).	MCM 1	MCM 1	MCM 1	MCM 1	RMS
S_NumPassPerTrk	The number of passes that will be made along each search track during the search phase of minehunting. These passes are performed sequentially before moving to the next track (PEO LMW 2008).	MCM 1	MCM 1	MCM 1	MCM 1	RMS
S_Pcmm	The probability of classifying a mine as a MILCO (PEO LMW 2008).	SQQ-32	SQQ-32	SQQ-32	SQQ-32	AQS-20A
S_Pcnn	The probability of classifying a non-mine as a non-MILCO (PEO LMW 2008).	SQQ-32	SQQ-32	SQQ-32	SQQ-32	AQS-20A
S_Pd	The probability of detecting a target. This should be consistent with the separation between search tracks (the reciprocal of S_NumHntTrk_pNM). Note: if data are available, the probability of detection should be implemented as a function of range from the sensor to the target in future studies (PEO LMW 2008).	SQQ-32	SQQ-32	SQQ-32	SQQ-32	AQS-20A
S_Pimm	The probability of identifying a mine as a mine (PEO LMW 2008).	SLQ-48	SeaFox	SLQ-48	SeaFox	
S_Pinn	The probability of identifying a non-mine as a non-mine (PEO LMW 2008).	SLQ-48	SeaFox	SLQ-48	SeaFox	
S_Pn	The probability of neutralizing a mine (PEO LMW 2008).	SLQ-48	SeaFox	SLQ-48	SeaFox	
S_Prmm	The probability of reacquiring a mine as a MILCO for identification (PEO LMW 2008).	SLQ-48	SeaFox	SLQ-48	SeaFox	
S_PrmmI	The probability of reacquiring a mine as a mine given that the mine has already been identified as a mine.		SeaFox		SeaFox	
S_Prnn	The probability of not reacquiring a non-mine as a MILCO for identification (PEO LMW 2008).	SLQ-48	SeaFox	SLQ-48	SeaFox	

Input	Description	MCM 1				LCS
		1A	1B	2A	2B	3
S_PrnnI	The probability of not reacquiring a non-mine as a mine, given that the non-mine has already been identified as a mine.		SeaFox		SeaFox	
S_RDDeployT_hr	The time to deploy the RI&N equipment.	SLQ-48	SeaFox	SLQ-48	SeaFox	
S_ReplenishT_hr	The time to replenish the surface minehunting platform at the end of a sortie (PEO LMW 2008).	SLQ-48	SeaFox	SLQ-48	SeaFox	
S_RIminT_hr	The minimum time for reacquisition for identification, for the surface-deployed neutralizer.	SLQ-48	SeaFox	SLQ-48	SeaFox	
S_RImuT_hr	The mean time for reacquisition and identification, excluding the transit time of the equipment to the target (assuming a normal distribution).	SLQ-48	SeaFox	SLQ-48	SeaFox	
S_RIsigmaT_hr	The standard deviation of the time for reacquisition and identification, excluding the transit time of the equipment to the target (assuming a normal distribution).	SLQ-48	SeaFox	SLQ-48	SeaFox	
S_RNminT_hr	Minimum time for reacquisition and neutralization for the surface-deployed neutralizer.		SeaFox		SeaFox	
S_RNmuT_hr	The mean time for reacquisition and neutralization, excluding the transit time of the equipment to the target (assuming a normal distribution).		SeaFox		SeaFox	
S_RNsigmaT_hr	The standard deviation of the time for reacquisition and neutralization, excluding the transit time of the equipment to the target (assuming a normal distribution).		SeaFox		SeaFox	
S_RRecoverT_hr	The time to recover the RI&N equipment.	SLQ-48	SeaFox	SLQ-48	SeaFox	
S_SafeDist_yd	The minimum safe stand-off distance for the MCM 1 during neutralization.	MCM 1	MCM 1	MCM 1	MCM 1	
S_SeaFox	Flag to indicate the equipment, the SeaFox or SLQ-48, used for the RI&N of targets (S_SeaFox = 1 indicates SeaFox is used, S_SeaFox = 0 indicates SLQ-48 is used). This applies to legacy MCM 1 only.	MCM 1	MCM 1	MCM 1	MCM 1	

Input	Description	MCM 1				LCS
		1A	1B	2A	2B	3
S_SeaFoxPID	The probability the commander will send out a SeaFox identification round first before sending out a SeaFox neutralization round. Note: the MH-53E does not have the option of sending out an identification round first, it always sends out a neutralization round. Therefore, this parameter does not apply to the MH-53E with SeaFox, it applies only to the MCM 1 with SeaFox.		SeaFox		SeaFox	
S_SortieTime_hr	The total endurance time of the surface minehunting platform before requiring replenishment (i.e. the maximum sortie time). Note: Replenishment takes 1-2 days.	MCM 1	MCM 1	MCM 1	MCM 1	RMS
S_SrchSpeed_kt	The speed of the surface minehunting platform while in the target area (PEO LMW 2008).	MCM 1	MCM 1	MCM 1	MCM 1	RMS
S_SRecoverT_hr	The time to recover the search equipment (PEO LMW 2008).	SQQ-32	SQQ-32	SQQ-32	SQQ-32	AQS-20A
S_SStreamT_hr	The time to stream the search equipment (PEO LMW 2008).	SQQ-32	SQQ-32	SQQ-32	SQQ-32	AQS-20A
S_TransitSpd_kt	The speed of the surface minehunting platform while transiting between the staging area and the target area.	MCM 1	MCM 1	MCM 1	MCM 1	RMS
S_TurnTime_s	The time taken by the surface minehunting platform, at the end of a search pass, to turn onto a reciprocal heading to establish the next search pass (PEO LMW 2008).	MCM 1	MCM 1	MCM 1	MCM 1	RMS

Table 18. Blue Airborne Force Data Table

Input	Description	MCM 1				LCS
		1A	1B	2A	2B	3
A_Neutralizer	Flag to indicate if the SeaFox is used by the MH-53E for the RI&N of targets (A_Neutralizer = 1 indicates SeaFox is used, A_Neutralizer = 0 indicates no airborne neutralizer is being used and all of the RI&N of targets is performed by the MCM 1). This applies to legacy MCM 1 only.			MH-53E	MH-53E	
A_NeutSpeed_kt	The transit speed of the airborne deployed neutralizer.			SeaFox	SeaFox	Archerfish
A_NumHntTrk_pNM	The number of search tracks per nautical mile in the Y-direction during the search phase of minehunting. The Y-axis is normal to the direction of the search tracks, with the origin at the lower boundary of the target area (PEO LMW 2008).	MH-53E	MH-53E	MH-53E	MH-53E	
A_NumNeut	The number of neutralizers carried onboard the helicopter.			MH-53E	MH-53E	MH-60S
A_NumPassPerTrk	The number of passes that will be made along each search track during the search phase of minehunting. These passes are performed sequentially before moving to the next track (PEO LMW 2008).	MH-53E	MH-53E	MH-53E	MH-53E	
A_Pcmm	The probability of classifying a mine as a MILCO (PEO LMW 2008).	AQS-24A	AQS-24A	AQS-24A	AQS-24A	
A_Pcnn	The probability of classifying a non-mine as a non-MILCO (PEO LMW 2008).	AQS-24A	AQS-24A	AQS-24A	AQS-24A	
A_Pd	The probability of detecting a target. This should be consistent with the separation between search tracks (the reciprocal of A_NumHntTrk_pNM). Note: if data are available, the probability of detection should be implemented as a function of range from the sensor to the target in future studies (PEO LMW 2008).	AQS-24A	AQS-24A	AQS-24A	AQS-24A	
A_Pimm	The probability of identifying a mine as a mine (PEO LMW 2008).			SeaFox	SeaFox	Archerfish
A_Pinn	The probability of identifying a non-mine as a non-mine (PEO LMW 2008).			SeaFox	SeaFox	Archerfish
A_Pn	The probability of neutralizing a mine (PEO LMW 2008).			SeaFox	SeaFox	Archerfish
A_Prmm	The probability of reacquiring a mine as a MILCO for identification (PEO LMW 2008).			SeaFox	SeaFox	Archerfish

Input	Description	MCM 1				LCS
		1A	1B	2A	2B	3
A_Prnn	The probability of not reacquiring a non-mine as a MILCO for identification (PEO LMW 2008).			SeaFox	SeaFox	Archerfish
A_RDeployT_hr	The time to deploy the RI&N equipment.			SeaFox	SeaFox	Archerfish
A_ReplenishT_hr	The time to replenish the helicopter at the end of a sortie (PEO LMW 2008).			SeaFox	SeaFox	Archerfish
A_RIminT_hr	The minimum time for reacquisition for identification, for the airborne-deployed neutralizer.			SeaFox	SeaFox	Archerfish
A_RImuT_hr	The mean time for reacquisition and identification, excluding the transit time of the equipment to the target (assuming a normal distribution).			SeaFox	SeaFox	Archerfish
A_RIsigmaT_hr	The standard deviation of the time for reacquisition and identification, excluding the transit time of the equipment to the target (assuming a normal distribution).			SeaFox	SeaFox	Archerfish
A_RRecoverT_hr	The time to recover the RI&N equipment.			SeaFox	SeaFox	Archerfish
A_SafeDist_yd	The minimum safe stand-off distance for the minehunting helicopter during neutralization for the helicopter.			MH-53E	MH-53E	MH-60S
A_SortieTime_hr	The total endurance time of the minehunting helicopter before requiring replenishment (i.e. the maximum sortie time).	MH-53E	MH-53E	MH-53E	MH-53E	Archerfish
A_SrchSpeed_kt	The speed of the minehunting helicopter while performing detection and classification in the target area (PEO LMW 2008).	MH-53E	MH-53E	MH-53E	MH-53E	
A_SRecoverT_hr	The time to recover the search equipment (PEO LMW 2008).	AQS-24A	AQS-24A	AQS-24A	AQS-24A	
A_SStreamT_hr	The time to stream the search equipment (PEO LMW 2008).	AQS-24A	AQS-24A	AQS-24A	AQS-24A	
A_TransitSpd_kt	The speed of the minehunting helicopter while transiting between the staging area and the start or finish position of its work in the target area.	MH-53E	MH-53E	MH-53E	MH-53E	MH-60S
A_TurnTime_s	The time taken by the minehunting helicopter to turn at the end of a search pass to turn on a reciprocal heading to establish the next search pass (PEO LMW 2008).	MH-53E	MH-53E	MH-53E	MH-53E	MH-60S

Table 19. Search Area Data Table

Input	Description
NumNonMines	The number of non-mine objects in the target area that could be detected as MILECs. This value must be greater than zero, but no more than 1,000, for the model to run.
SLOCLength_NM	The extent of the target area in the X-direction. The X-axis is parallel to the direction of the search tracks, with the origin at the left boundary of the target area.
SLOCWidth_NM	The extent of the target area in the Y-direction. The Y-axis is normal to the direction of the search tracks, with the origin at the lower boundary of the target area.
SearchSplitYpc	The percentage of the total target area covered by surface search system (MCM 1) in the first phase of operations (detection to neutralization). This is entered as a value between zero and one (i.e., a value of one is equivalent to 100 percent). This only applies to the legacy MCM system.
NeutSplitYpc	The percentage of the target area remaining after the first phase of operations (the area not cleared by the MCM 1) that will be covered by surface neutralization (MCM 1) in the second phase of operations (RI&N). This is entered as a value between zero and one (i.e., a value of one is equivalent to 100 percent). This only applies to the legacy MCM system.
StagingXPos_NM	The X-coordinate of the staging area. The X-axis is parallel to the direction of the search tracks, with the origin at the left boundary of the target area. The model is constructed with the assumption that the staging area will always be to the left (west) of the target area. Therefore, the maximum value for this parameter is zero (i.e. the value of this parameter will be zero or negative).
StagingYPos_NM	The Y-coordinate of the staging area. The Y-axis is normal to the direction of the search tracks, with the origin at the lower boundary of the target area. The staging area should be within the width of the SLOC (although the model does allow any value).

Table 20. Red Force Data Table

Input	Description
NumMines	The number of mines in the target area. This value must be greater than zero, but no more than 1,000, for the model to run.

E. MODEL INTERNAL VARIABLES

Internal variables within the ExtendSim model are used to communicate data between the items in the model and the functions that operate on those items. In the models of the legacy and future MCM systems, the items are the targets (the mines and non-mines). There are five types of internal variables:

1. Attributes are variables that are attached to the items within the simulation and are passed with each item as that item passes from block to block.
2. Local variables only exist within the block in which they are declared, typically an equation block, but the local variables can be applied to any item passing through that block.
3. Global variables are available to any block within the model and can be applied to any item passing through any block.
4. Connector values are variables that are passed from one block to another that do not contain information about the item being passed. A different type of connector is used to pass values than the type of connector used to pass items. Connector values are primarily used by one block to control the action of another block.
5. System variables are used to provide information about the state of the simulation and are accessible to any block within a model.

A knowledge of the internal variables is not required to use the models, but is required if the models are to be developed further. The sections below provide an overview of the internal variables; the details, including a complete data dictionary, are provided in the SDD (see Appendix D) developed by the MIW Team. A full description of the different types of model internal variables is provided in the ExtendSim User Guide (Diamond 2007).

1. Attributes

Each target (mine or non-mine) is an item within ExtendSim and, as it passes through the simulation, it has a number of associated attributes. The attribute names and their descriptions are listed in the SDD (see Appendix D) developed by the MIW Team. It should be noted that the list of attributes includes a number of simulation variables that appear to have nothing to do with the targets themselves. This was necessary because the blocks in ExtendSim operate on each item as it passes through the block. Since the targets are individual items, it is necessary for them to carry an awareness of other simulation variables that may affect their behavior, especially in terms of the timing of events. As an

example, the sortie time is an attribute of every target so that the information is always available to determine when a sortie should end. It also has to be recognized that when the value of an attribute is changed for a specific target, the value of that same attribute for the other targets will not be changed. Therefore, during development, care has to be taken when setting and referencing the values of attributes.

2. Local Variables

There is a class of equation blocks within ExtendSim that operate on the items within the simulation, targets in this case. The equation blocks can be used to create specific functionality using the ModL programming language. The GUI of the equation blocks allows access to the target attributes and the ModL programming language allows access to the global variables of the models; however, in many instances there is a need to use variables to store the results of intermediate calculations that do not need to be shared with other parts of the model. These variables are declared as local variables within the ModL programming language. This means these variables do not provide any coupling with other ExtendSim blocks and this facilitates reuse and maintenance of the code. The names and descriptions of the local variables are provided in the source code listings contained in the SDD (see Appendix D) developed by the MIW Team.

3. Global Variables

The models use global variables to allow direct communication of values between model blocks throughout the simulation. This section describes the use of two types of global variables: general use and user defined.

a. General Use Global Variables

The ModL programming language, which can be used within the ExtendSim equation blocks, includes twenty general-use global variables (Global0 through Global19) that are available to all blocks. Effectively, this allows direct communication between any two blocks in the model. These general-use global variables can be used to store arrays of values but, currently, the model uses them to store single values. If the models are developed further to support future studies, it may be necessary to take ad-

vantage of the array feature of these general-use global variables or replace them with user-defined global variables. Although there are benefits from the direct communication between blocks provided by general-use global variables, any blocks that use the same general-use global variable are directly coupled, which is not obvious from an examination of the connections between the blocks in the ExtendSim model diagrams. Therefore, in the SDD (see Appendix D) developed by the MIW Team, the data dictionary of the general-use global variables includes an indication of every block that uses each of the general-use global variables and whether the block references or sets the value of the general-use global variable. Another downside to the general-use global variables is that their names cannot be changed so, without the data dictionary, it is not obvious what data are being represented by the global variable.

b. User-Defined Global Arrays

ExtendSim allows the developer to create user-defined global arrays. These have the same benefit as the general-use global variables, but they can be tailored (including the ability to assign a meaningful name to a global array). In the models of the legacy and future MCM systems, the most significant use of user-defined global arrays is in the PMA block. Without the use of user-defined global arrays, it would not have been possible to include the PMA functionality within the ExtendSim models.

The user-defined global arrays also have the same downside as the general-use global variables, by providing direct coupling between the blocks that use the same global array. Therefore, in the SDD (see Appendix D) developed by the MIW Team, the data dictionary of the user-defined global arrays includes an indication of every block that uses each of the user-defined global arrays and whether the block references or sets the value of the elements of the user-defined global arrays.

4. Connector Values

Connector values are used extensively in the ExtendSim models of the MCM systems. There are three ways in which they are used. The first is to use one block to control the action of another block. For example, a calculation in an equation block can be used to control another block that will change the path of an item through the model. The sec-

ond way is to use the connector value as an input to an equation block to control the flow within an algorithm or to change the value of a variable used in an equation, including item attributes. The third way is to pass a value to an output block, either as a value that will be written to an output table, or to control how values are written to an output table.

5. System Variables

There are two ExtendSim system variables that are accessed in the ExtendSim models of the MCM systems. The first is the current time in the simulation and the second is the current run number when executing repeated runs or multiple different runs.

F. MODEL OUTPUTS

The output variables (responses) from the model are contained within two ExtendSim data tables within the Outputs database, as shown in Figure 52. The data tables are the Hunt Effectiveness data table and the Target Outputs data table. Both the legacy MCM model and the future MCM model have the same set of output variables.

Hunt Effectiveness [1]		Target Outputs [2]	
<input type="checkbox"/>	Undetected non-mine [1]	<input type="checkbox"/>	Target Type [1]
<input type="checkbox"/>	Non-mine class as non-MILCO [2]	<input type="checkbox"/>	Target Detection [2]
<input type="checkbox"/>	Non-mine not reacq as MILCO [3]	<input type="checkbox"/>	Target Classification [3]
<input type="checkbox"/>	Non-mine ident as non-mine [4]	<input type="checkbox"/>	Target Reacquisition(l) [4]
<input type="checkbox"/>	Neut attempt against non-mine [5]	<input type="checkbox"/>	Target Identification [5]
<input type="checkbox"/>	Undetected mine [6]	<input type="checkbox"/>	Target Neutralization [6]
<input type="checkbox"/>	Mine class as non-MILCO [7]	<input type="checkbox"/>	Target X-Position [7]
<input type="checkbox"/>	Mine not reacq as MILC [8]	<input type="checkbox"/>	Target Y-Position [8]
<input type="checkbox"/>	Mine ident as non-mine [9]	<input type="checkbox"/>	Target ID [9]
<input type="checkbox"/>	Mine successfully neutralized [10]	<input type="checkbox"/>	Run Number [10]
<input type="checkbox"/>	Mine unsuccessfully neutralized [11]		
<input type="checkbox"/>	Number of non-mines [12]		
<input type="checkbox"/>	Number of mines [13]		
<input type="checkbox"/>	Number of Neutralizers Used [14]		
<input type="checkbox"/>	Total Time (hrs) [15]		
<input type="checkbox"/>	Number of Surface Sorties [16]		
<input type="checkbox"/>	Number of Abn Search Sorties [17]		
<input type="checkbox"/>	Number of Abn Reacq Sorties [18]		
<input type="checkbox"/>	Number of Sfc Neut Used [19]		
<input type="checkbox"/>	Number of Abn Neut Used [20]		

Figure 52. Model Output Data—Outputs Database

1. Hunt Effectiveness Table

The Hunt Effectiveness data table contains summary information for each run. The data table contains twenty columns of output variables and each row represents a different run of the simulation, i.e., the number of rows will be equal to the total number of runs. The data in the Hunt Effectiveness data table can be copied from ExtendSim and pasted into another program, such as Excel or Minitab, for analysis. Table 22 provides a list and description of the output variables (listed in column one).

Table 21. Hunt Effectiveness Data Table

Output Variable	Description
Undetected non-mine	The number of non-mine targets that went undetected.
Non-mine classified as non-MILCO	The number of non-mine targets that were correctly classified as non-MILCOs.
Non-mine not reacquired as MILCO	The number of non-mine targets that were incorrectly classified as MILCOs but were not reacquired for identification.
Non-mine identified as non-mine	The number of non-mine targets that were correctly identified as non-mines.
Neutralization attempt against non-mine	The number of non-mine targets that were erroneously subject to a neutralization attempt. Although a non-mine does not pose a threat and cannot be neutralized, these represent false targets and a “waste” of both time and warheads due to the incorrect identification of the non-mine as a mine.
Undetected mine	The number of mine targets that went undetected.
Mine classified as non-MILCO	The number of mine targets that were incorrectly classified as non-MILCOs.
Mine not reacquired as MILCO	The number of mine targets that were correctly classified as MILCOs but were not reacquired for identification.
Mine identified as non-mine	The number of mine targets that were incorrectly identified as non-mines.
Mine successfully neutralized	The number of mine targets that were successfully neutralized. When this number is divided by the total number of mines in the target area (the input parameter “NumMines” in the Red Force data table) it yields the percent clearance for the mine-hunting operation. The percent clearance is one of the MOEs.
Mine unsuccessfully neutralized	The number of mine targets against which the neutralization attempt was unsuccessful.
Number of non-mines	The total number of non-mine targets (this is the same as the input parameter “NumNonMines” in the Search Area data table).
Number of mines	The total number of mine targets (this is the same as the input parameter “NumMines” in the Red Force data table).
Number of Neutralizers Used	The total number of neutralizers used.

Output Variable	Description
Total Time (hours)	The total length of the simulation run. This is the total time of the clearance mission. Dividing the size of the target area by the Total Time and multiplying by 24 gives the ACRS (the average area covered per day). The ACRS is one of the MOEs.
Number of Surface Sorties	The number of sorties made by the surface platform. For the legacy MCM system this includes the sorties by the MCM 1 for the initial detection to neutralization during the first phase of operations and the number of sorties for the reacquisition, identification and neutralization in the second phase of operations. Since the sortie time of the MCM 1 is on the order of a few weeks, it is highly likely that the MCM 1 will transition from the first phase of operations to the second phase of operations during a sortie. For the future MCM system this is the number of detection and classification sorties made by the RMS.
Number of Airborne Search Sorties	The number of detection and classification sorties performed by the airborne platform. This only applies to the MH-53E component of the legacy MCM system during the first phase of operations.
Number of Airborne Reacquisition Sorties	The number of airborne sorties for RI&N. For the legacy MCM system this applies to the MH-53E during the second phase of operations and for the future MCM system this applies to the MH-60S.
Number of Surface Neutralizers Used	The number of surface neutralizers used by the surface platform. This only applies to the MCM 1 during the second phase of operations.
Number of Airborne Neutralizers Used	The number of airborne neutralizers used. For the legacy MCM system this applies to the MH-53E during the second phase of operations and for the future MCM system this applies to the MH-60S.

At the end of the simulation, the targets are sorted into eleven different categories that represent the state of each target at the end of the simulation. These categories comprise the first eleven columns of the Hunt Effectiveness data table (Table 21). The first five categories apply to non-mine targets and the next six categories apply to mine targets. Every target should be accounted for in these first eleven columns of the data table, provided ExtendSim was configured to allow sufficient time for the clearance mission to

be completed. Therefore, the sum of the first five columns of each row should equal the number of non-mine targets (column 12) and the sum of the next six columns of each row should equal the number of mine targets (column 13). This provides a means to perform a basic quality check on the correct functioning of the simulation. If the totals of either the non-mine or the mine target categories do not match the expected values (column 12 or column 13, respectively) then a check should be made to ensure that sufficient time was allowed for the simulation to complete the clearance mission. If an excessively long time is required to complete the clearance mission, the input parameters should be examined to see if any of the values was set to an unreasonable value.

Some of the outputs in the Hunt Effectiveness data table (Table 21) are provided for the post-run calculation of MOEs or to support the cost analysis. The time to complete the clearance mission (Total Time (hours)) is used to calculate the ACRS, which was one of the two primary MOEs for this study. ACRS is the total area of the target area divided by the time taken to clear it (measured in days). The other primary MOE was the mine-hunting effectiveness as represented by the percent clearance. This is the number of mines that were neutralized divided by the total number of mines in the target area. Other outputs, such as the number of neutralizers used, were used to develop elements of the cost estimates for the clearance mission.

2. Target Outputs Data Table

The Target Outputs data table (Table 22) contains summary information for each target (mine or non-mine). The data table contains ten columns of output variables (responses) and each row represents a different target and a different simulation run; therefore, the total number of rows will be equal to the product of the number of targets and the number of runs. The data in the Target Outputs data table can be copied from ExtendSim and pasted into Excel or other tools for analysis. Table 22 provides a list of the output variables (listed in column one) and a brief description of each. These data outputs can be used as a first level diagnostic if the data in the Hunt Effectiveness data table does not appear to be reasonable, particularly if it is just a few runs out of many. Since the

Target Output data table contains data for every target run, it is possible to see what happened to every target in the run(s) in question.

Table 22. Target Outputs Data Table

Output Variable	Description
Target Type	Flag to indicate the type of target (Target Type = 0 indicates a non-mine target, and Target Type = 1 indicates a mine target).
Target Detection	Flag to indicate if the target was detected (Target Detection = 0 indicates target was not detected, Target Detection = 1 indicates the target was detected as a MILEC).
Target Classification	Flag to indicate if the target was classified as a MILCO (Target Classification = 0 indicates no attempt was made to classify the target, Target Classification = 1 indicates the target was classified as a MILCO, and Target Classification = 2 indicates the target was classified as a non-MILCO).
Target Reacquisition	Flag to indicate if the target was reacquired for identification (Target Reacquisition = 0 indicates no attempt was made to reacquire the target for identification, Target Reacquisition = 1 indicates the target was reacquired as a MILCO, and Target Reacquisition = 2 indicates the target was not reacquired as a MILCO).
Target Identification	Flag to indicate if the target was identified as a mine (Target Identification = 0 indicates no attempt was made to identify the target, Target Identification = 1 indicates the target was identified as a mine, and Target Identification = 2 indicates the target was identified as a non-mine).
Target Neutralization	Flag to indicate if the target was neutralized (Target Neutralization = 0 indicates no attempt was made to neutralize the target, Target Neutralization = 1 indicates the target was successfully neutralized, and Target Neutralization = 2 indicates the neutralization attempt against the target was unsuccessful).
Target X-Position	The X-coordinate of the target. The X-axis is parallel to the direction of the search tracks, with the origin at the left boundary of the target area. The unit of measure is nautical miles.
Target Y-Position	The Y-coordinate of the target. The Y-axis is normal to the direction of the search tracks, with the origin at the lower boundary of the target area. The unit of measure is nautical miles.

Output Variable	Description
Target ID	The unique identifier of the target within the particular run. The Target ID is assigned in the order of increasing values of Target X-Position.
Run number	The number of the current simulation run. In ExtendSim the numbering of runs starts at zero, so the n^{th} run will show up as $(n-1)$.

3. History Blocks

The model contains a number of history blocks, an example of which is shown highlighted in Figure 53. These history blocks are primarily used for debugging the model because they capture the value of specified model attributes as each item passes through the block, including the time in the simulation when the item passed through. The History table can be opened by double-clicking the history block icon in the ExtendSim model and selecting the history tab. The information within the History table can then be copied and pasted into Excel for further analysis; however, if multiple runs are performed, the history block will only include the data from the most recent run.

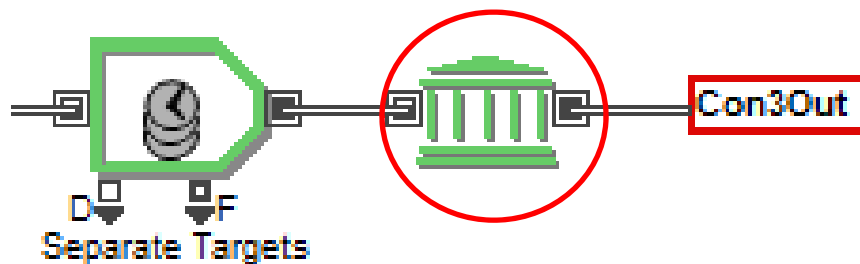

Figure 53. Example of a History Block (shown in red circle)

G. RUNNING THE SIMULATION

The models were built using ExtendSim version 8 and this is the version of ExtendSim that should be used to execute simulation runs. The following sections summarize how to run a simulation in ExtendSim 8 using the models described in the previous sections.

1. Repeated Runs versus Multiple Different Runs

Depending on whether an ExtendSim model is going to be used for a set of repeated runs or to execute a set of multiple different runs as part of a DOE, the model needs to be configured differently. In other words, these different run options cannot be controlled from the ExtendSim Run menu, but require modifications within the model itself to structure how the input data are read into the model. It was decided to maintain two versions of the legacy MCM model and two versions of the future MCM model. In each case, one model is configured for single or repeated runs, while the other is configured for multiple DOE runs. Full details of how the models are configured for these different use cases are provided in Appendix C.

2. Selecting Legacy MCM Model Configurations

Two of the input parameters are used to configure the model of the legacy MCM 1 system to represent the four possible configurations. The setting of these parameters for each of the configurations is show in Table 23. The input parameter “A_Neutralizer” is in the Blue Airborne Force input data table and the input parameter “S_SeaFox” is in the Blue Surface Force input data table. These settings need to be present in every record (row) in the input data tables.

Table 23. Parameter Settings to Select Legacy MCM Configurations

Configuration	Description	A_Neutralizer	S_SeaFox
1A	Serial Hunt - SLQ-48	0	0
1B	Serial Hunt - SeaFox	0	1
2A	Parallel Hunt - SLQ-48	1	0
2B	Parallel Hunt - SeaFox	1	1

H. VERIFICATION AND VALIDATION

Before the simulations could be run to develop and collect performance data, they had to be evaluated to ensure they met the requirements and that they worked in the way they were intended. The first step after developing the models was to verify and validate the models by running various simulations. This section describes these efforts, including the results.

1. Definitions

The following definitions for verification and validation have been extracted from Department of Defense Instruction 5000.61, “DOD Modeling and Simulation (M&S) Verification, Validation, and Accreditation (VV&A)” (Under Secretary of Defense for Acquisition, Technology, and Logistics (AT&L) 2009).

- “Verification: The process of determining that a model or simulation implementation and its associated data accurately represent the developer’s conceptual description and specifications” (Under Secretary of Defense for Acquisition, Technology, and Logistics 2009).
- “Validation: The process of determining the degree to which a model or simulation and its associated data are an accurate representation of the real world from the perspective of the intended uses of the model” (Under Secretary of Defense for Acquisition, Technology, and Logistics 2009).

2. Verification

The requirements presented in Chapter IV define the modeling and simulation capabilities required for this project. The solution to these requirements was the development of a modeling and simulation capability using the ExtendSim general-purpose application (Diamond 2007). The purpose of the verification activity was to determine whether or not the requirements were met in the solution that was developed. The vast majority of the requirements were of a functional nature and, while some numerical values were included in the requirements, these numerical values only referred to the numerical ranges of input parameters. Therefore, most of the verification comprised inspection of the model code and input parameters.

Two verification tests were performed to determine whether the sequence of MCM activities and the interactions between them were correctly captured in the model. This was done with respect to the calculation of the primary MOEs for this study, the “timing” test was relevant to the ACRS (top-level requirement 1.0) and the “effectiveness” test was relevant to minehunting effectiveness (top-level requirement 2.0). For these calculations to be correct, however, the sequence of events (top-level requirement 3.0) had to be captured correctly in the models.

The result of the verification test for each of the requirements is summarized in Table 24. The results from the verification tests were placed in one of three categories: pass, partial pass, or fail. The three categories are indicated in Table 24 through shading of the appropriate cell in the result column: green for pass, orange for partial pass, and red for fail. In all, there were 61 passes, six partial passes, and four failures.

Table 24. Verification Test Summary

REQ. NO.	REQUIREMENT	VERIFICATION TEST	RESULT
1.0	The simulation shall enable the determination of the ACRS for each MCM configuration in the performance of mine hunting.		
1.1	The simulation shall represent the time required to perform each minehunting function within the minehunting operation: travel, detect, classify, identify, reacquire, and neutralize for each MCM configuration.	Test 1: Timing	Pass
1.1.1	The simulation shall represent the sortie time required in the area (Tsortie).		
1.1.1.1	The simulation shall represent the maximum endurance time per system (Sortie_Time) for surface platforms between 336 and 504 hours.	Inspection: Model code and date input	Pass
1.1.1.2	The simulation shall represent the maximum endurance time per system (Sortie_Time) for airborne systems between one and four hours.	Inspection: Model code and date input	Pass
1.1.2	The simulation shall represent the transit time to target area (Tta).		
1.1.2.1	The simulation shall represent the transit speed of MCM 1 between 10 and 15 knots.	Inspection: Model code and date input	Pass
1.1.2.2	The simulation shall represent the transit speed of LCS between 20 and 40 knots.	Inspection: Model code and date input	Pass
1.1.2.3	The simulation shall represent the transit speed of helicopter between 80 and 150 knots.	Inspection: Model code and date input	Pass
1.1.2.4	The simulation shall represent the transit speed of airborne deployed neutralizer between zero and five knots.	Inspection: Model code and date input	Pass
1.1.3	The simulation shall represent the transit time to staging area (Tsa).	Inspection: Model code and date input	Pass
1.1.4	The simulation shall represent the time to stream MCM gear (Tstream)		

REQ. NO.	REQUIREMENT	VERIFICATION TEST	RESULT
1.1.4.1	The simulation shall represent the time to stream MCM tear (Tstream) for search equipment for surface platforms between 0.25 and two hours.	Inspection: Model code and date input	Pass
1.1.4.2	The simulation shall represent the time to stream MCM gear (Tstream) for search equipment for airborne systems between 0.2 and 0.5 hours.	Inspection: Model code and date input	Pass
1.1.5	The simulation shall represent the time to recover MCM gear (Trecover).		
1.1.5.1	The simulation shall represent the time to recover RI&N equipment for surface platforms between 0.1 and two hours.	Inspection: Model code and date input	Pass
1.1.5.2	The simulation shall represent the time to recover the search equipment for surface platforms between 0.25 and two hours.	Inspection: Model code and date input	Pass
1.1.5.3	The simulation shall represent the time to recover RI&N equipment for airborne systems between 0.2 and one hour.	Inspection: Model code and date input	Pass
1.1.5.4	The simulation shall represent the time to recover the search equipment for airborne systems between 0.2 and 0.5 hours.	Inspection: Model code and date input	Pass
1.1.6	The simulation shall represent the time to refuel/rearm/reconfigure (Trr)		
1.1.6.1	The simulation shall represent the time to refuel/rearm/reconfigure (Trr) for surface platforms between four and eight hours.	Inspection: Model code and date input	Pass
1.1.6.2	The simulation shall represent the time to refuel/rearm/reconfigure (Trr) for airborne systems between four and eight hours.	Inspection: Model code and date input	Pass
1.1.7	The simulation shall represent the time to turn (Tturn).		
1.1.7.1	The simulation shall represent the time to turn (Tturn) for surface platforms between 300 and 600 seconds.	Inspection: Model code and date input	Pass
1.1.7.2	The simulation shall represent the time to turn (Tturn) for airborne systems between 120 and 240 seconds.	Inspection: Model code and date input	Pass
1.1.8	The simulation shall represent the time to deploy (Tdeploy) for RI&N equipment.		

REQ. NO.	REQUIREMENT	VERIFICATION TEST	RESULT
1.1.8.1	The simulation shall represent the time to deploy (Tdeploy) for RI&N equipment for surface platforms between 0.1 and two hours.	Inspection: Model code and date input	Pass
1.1.8.2	The simulation shall represent the time to deploy (Tdeploy) for RI&N equipment for airborne systems between 0.1 and one hour.	Inspection: Model code and date input	Pass
1.1.9	The simulation shall represent the average time in field per sortie (Taps).	Inspection: Model code and date input	Fail (requirement not met due to schedule constraints)
1.1.10	The simulation shall represent the number of sorties (Nst).	Inspection: Model code	Pass
1.1.11	The simulation shall represent the operational availability (Ao).	Inspection: Model code and date input	Fail (requirement not met due to schedule constraints)
1.1.12	The simulation shall represent the on duty time (Ton).	Inspection: Model code and date input	Fail (requirement not met due to schedule constraints)
1.1.13	The simulation shall represent the off duty time (Toff).	Inspection: Model code and date input	Fail (requirement not met due to schedule constraints)
1.1.14	The simulation shall represent the time to hunt (Thunt).		
1.1.14.1	The simulation shall represent the speed in search area for surface platforms between one and five knots.	Inspection: Model code and date input	Pass

REQ. NO.	REQUIREMENT	VERIFICATION TEST	RESULT
1.1.14.2	The simulation shall represent the speed in search area for airborne systems between 10 and 30 knots.	Inspection: Model code and date input	Pass
1.1.14.3	The simulation shall represent the number of search tracks per NM for surface platforms between 10 and 40.	Inspection: Model code and date input	Pass
1.1.14.4	The simulation shall represent the number of search tracks per NM for airborne systems between 10 and 40.	Inspection: Model code and date input	Pass
1.1.14.5	The simulation shall represent the number of passes per track for airborne systems between one and four.	Inspection: Model code and date input	Pass
1.1.15	The simulation shall represent the classification time (Tcmm, Tcmn, Tcnm, Tcnn).	Inspection: Model code and date input	Partial pass (replaced by a single parameter due to lack of data)
1.1.16	The simulation shall represent the reacquisition for identification and for neutralization time (Trmm, Trmn, Trnm, Trnn).		
1.1.16.1	The simulation shall represent the mean reacquisition and identification for surface platforms between 0.25 and one hour.	Inspection: Model code and date input	Pass
1.1.16.2	The simulation shall represent the standard deviation time for reacquisition and identification for surface platforms between 0.1 and 0.5 hours.	Inspection: Model code and date input	Pass
1.1.16.3	The simulation shall represent the mean reacquisition and identification for airborne systems between 0.5 and one hour.	Inspection: Model code and date input	Pass
1.1.16.4	The simulation shall represent the standard deviation time for reacquisition and identification for airborne systems between 0.1 and 0.5 hours.	Inspection: Model code and date input	Pass
1.1.16.5	The simulation shall represent the mean reacquisition and neutralization for surface platforms between 0.2 and 0.5 hours.	Inspection: Model code and date input	Pass
1.1.16.6	The simulation shall represent the standard deviation time for reacquisition and neutralization for surface platforms between 0.1 and 0.25 hours.	Inspection: Model code and date input	Pass
1.1.16.7	The simulation shall represent the minimum safe stand-off distance during neutralization (MCM 1) between 250 and 300 yards.	Inspection: Model code and date input	Pass
1.1.16.8	The simulation shall represent the minimum safe stand-off distance during neutralization (helicopter) between 300 and 350 yards.	Inspection: Model code and date input	Pass

REQ. NO.	REQUIREMENT	VERIFICATION TEST	RESULT
1.1.16.9	The simulation shall represent the minimum time for reacquisition for identification, airborne deployed neutralizer between 0.25 and 0.5 hours.	Inspection: Model code and date input	Pass
1.1.17	The simulation shall represent the identification time (Timm, Timn, Tinm, Tinn).	Inspection: Model code and date input	Partial pass (included in reacquisition time due to lack of data)
1.1.18	The simulation shall represent the neutralization time (Tnm, Tnn).	Inspection: Model code and date input	Partial pass (included in reacquisition time due to lack of data)
1.1.18.1	The simulation shall represent the number of neutralizers for MH-53E between zero and six.	Inspection: Model code and date input	Pass
1.1.18.2	The simulation shall represent the number of neutralizers for MH-60S between zero and four.	Inspection: Model code and date input	Pass
1.2	The simulation shall calculate the ACRS (time required to conduct the entire minehunting sequence).	Inspection: Model code and date output	Partial pass (calculated post-run from the mission time (run time) and area of SLOC)
2.0	The simulation shall model the effectiveness of each minehunting function.	Test 2: Effectiveness	Pass
2.1	The simulation shall calculate and store the effectiveness of each minehunting function.		

REQ. NO.	REQUIREMENT	VERIFICATION TEST	RESULT
2.1.1	The simulation shall represent the Probability of detection vs. lateral range (PD(y)) between 0.3 and 0.9.	Inspection: Model code and date input	Partial pass (replaced by a constant value that is consistent with the spacing between search tracks)
2.1.2	The simulation shall represent the probability of classification (Pcmm, Pcmn, Pcnm, Pcnn).		
2.1.2.1	The simulation shall represent the probability of classifying a mine as a MILCO for surface platforms between 0.5 and 0.9.	Inspection: Model code and date input	Pass
2.1.2.2	The simulation shall represent the probability of classifying a non-mine as a non-MILCO for surface platforms between 0.5 and 0.9.	Inspection: Model code and date input	Pass
2.1.2.3	The simulation shall represent the probability of classifying a mine as a MILCO for airborne systems between 0.5 and 0.9.	Inspection: Model code and date input	Pass
2.1.2.4	The simulation shall represent the probability of classifying a non-mine as a non-MILCO for airborne systems between 0.5 and 0.9.	Inspection: Model code and date input	Pass
2.1.3	The simulation shall represent the probability of reacquisition (Prmm, Prmn, Prnm, Prnn).		
2.1.3.1	The simulation shall represent the probability of reacquiring a mine as a MILCO for identification for surface platforms between 0.3 and 0.8.	Inspection: Model code and date input	Pass
2.1.3.2	The simulation shall represent the probability of reacquiring a mine for neutralization given mine was already identified as a mine for surface platforms between 0.3 and one.	Inspection: Model code and date input	Pass
2.1.3.3	The simulation shall represent the probability of not reacquiring a non-mine as a MILCO for identification for surface systems between 0.01 and 0.30.	Inspection: Model code and date input	Pass
2.1.3.4	The simulation shall represent the probability of not reacquiring a non-mine for neutralization given non-mine was already identified as a mine for surface systems between 0.01 and 0.30.	Inspection: Model code and date input	Pass
2.1.3.5	The simulation shall represent the probability of reacquiring a mine as a MILCO for identification for airborne platforms between 0.3 and 0.8.	Inspection: Model code and date input	Pass

REQ. NO.	REQUIREMENT	VERIFICATION TEST	RESULT
2.1.3.6	The simulation shall represent the probability of not reacquiring a non-mine as a MILCO for identification for airborne systems between 0.01 and 0.50.	Inspection: Model code and date input	Pass
2.1.4	The simulation shall represent the probability of identification (Pimm, Pimn, Pinm, Pinn).		
2.1.4.1	The simulation shall represent the probability of identifying a mine as a mine for surface platforms between 0.5 and one.	Inspection: Model code and date input	Pass
2.1.4.2	The simulation shall represent the probability of identifying a non-mine as a non-mine for surface platforms between 0.5 and one.	Inspection: Model code and date input	Pass
2.1.4.3	The simulation shall represent the probability of identifying a mine as a mine for airborne systems between 0.5 and one.	Inspection: Model code and date input	Pass
2.1.4.4	The simulation shall represent the probability of identifying a non-mine as a non-mine for airborne systems between 0.5 and one.	Inspection: Model code and date input	Pass
2.1.5	The simulation shall represent the probability of neutralization (Pn) between 0.5 and 0.9.	Inspection: Model code and date input	Pass
2.2	The simulation shall calculate and output the overall minehunting effectiveness in terms of the number of mines cleared, number of mines remaining, and the number of non-mines that were neutralized.	Inspection: Model code and date output	Pass
3.0	The simulation shall contain models of the minehunting sequence of events for the different configurations.		
3.1	The simulation shall represent each of the three MCM configuration's minehunting functions: search, detect, classify, identify, reacquire, and neutralize.	Inspection: Model code	Pass
3.2	The simulation shall represent the minefield size and location for use in the effectiveness and ACRS calculations.		
3.2.1	The simulation shall represent the search area.		

REQ. NO.	REQUIREMENT	VERIFICATION TEST	RESULT
3.2.1.1	The simulation shall represent the length of search area between one and 100.	Inspection: Model code and date input	Pass
3.2.1.2	The simulation shall represent the width of search area between one and 100.	Inspection: Model code and date input	Pass
3.2.1.3	The simulation shall represent the percentage of area covered by surface search (MCM 1) between zero and 100.	Inspection: Model code and date input	Pass
3.2.1.4	The simulation shall represent the percentage of area covered by surface neutralization (MCM 1) between zero and 100.	Inspection: Model code and date input	Pass
3.2.2	The simulation shall represent the staging position's coordinates for use in the ACRS and effectiveness calculations.		
3.2.2.1	The simulation shall represent the staging position—X-Coordinate between -50 and zero.	Inspection: Model code and date input	Pass
3.2.2.2	The simulation shall represent the staging position—Y-Coordinate between zero and SLOC width.	Inspection: Model code and date input	Pass
3.2.3	The simulation shall represent the number of mines between one and 1000.	Inspection: Model code and date input	Pass
3.2.4	The simulation shall represent the non-mine density for classification (λ_{cnm} between one and 1000).	Inspection: Model code and date input	Partial pass (this is represented by specifying the total number of non-mines in the target area)
3.3	The simulation shall transition the state and minehunting results of the previous function to the subsequent function IAW PEO LMW Instruction 3370.1A (2008).	Inspection: Model code	Pass
4.0	The simulation shall support setting and modifying the listed performance parameters without requiring modifying the simulation.		
4.1	The simulation shall import specified input parameters without requiring modifications to the code.	Inspection: Model code and date input	Pass

REQ. NO.	REQUIREMENT	VERIFICATION TEST	RESULT
4.2	The simulation shall support the export of the resulting effectiveness and time-to-complete parameters to a form that can be analyzed by statistical software products such as Excel and Minitab.	Inspection: Model code and date output	Pass
4.3	The simulation shall be developed in a modular method that allows for each function to be replaced.	Inspection: Model code	Pass
5.0	The simulation shall include documentation that facilitates the use of the simulation tool by future study groups.		
5.1	The simulation shall include documentation that describes the use of the code and descriptions of the input and output parameters.	Inspection: Documentation	Pass
5.2	The simulation shall include documentation that describes the code, the structure of the code, and the required inputs and outputs of each functional block.	Inspection: Documentation	Pass

All four failures were for requirements that were not met due to schedule constraints for developing the model. Consideration should be given to making these requirements a high priority if the model is developed further. All of these requirements are related to MCM system availability.

Of the six partial passes, four were requirements that could not be supported by data so a lower fidelity approach was adopted in the model. The fifth requirement that was a partial pass was the calculation of the ACRS. The model provides all of the information required to calculate the ACRS; however, the ACRS must be calculated as part of the data processing after the simulation runs have been completed. The final requirement that was a partial pass was the representation of the non-mine density in the target area. Rather than specifying a non-mine density, the total number of mines in the target area is specified.

3. Validation

One of the challenges of this modeling and simulation effort was how to represent MCM capabilities without using system-specific data. The solution was to define the MCM characteristics and performance parametrically using external inputs to the model. For this study representative values were used for these parameters but, ultimately, this will allow system-specific values to be used in an appropriate computational environment. Since validation is the measurement of how well the model and simulation represents the real world, it was impossible to perform a quantitative validation based on the representative parameter values used in this study; however, the MIW Team obtained SME feedback on the reasonableness of the results based on the input parameters to provide a cursory validation check. In this regard, as much as it was possible to perform validation, this process indicated that the models and simulations were producing credible results – both in terms of the ACRS and percent clearance. Also, in terms of the intended use of the models and simulations, these were being used in a comparative analysis of legacy and future MCM capabilities. Therefore, absolute accuracy was not required, provided the relative performance of legacy and future MCM systems was well represented.

Again, subjectively, the models and simulations appeared to meet this evaluation criterion, based on SME feedback.

I. MODELING AND SIMULATION CONCLUSION

Once the models were built and tested, they were used to evaluate the performance of the legacy and future MCM systems. The DOE approach used the input parameters as factors and the Time to Complete and Number of Mines Neutralized as the output responses for the analysis. Although the M&S development is reported in this chapter and the DOE approach is reported in Chapter VII, there was significant iteration between these two activities to ensure that the factors and responses were included in the models in a way that supported detailed analysis.

VII. DOE AND SENSITIVITY ANALYSIS

The models described in Chapter VI provided the basis for a systematic investigation of how the numerous input model parameters impacted the model outputs associated with the ACRS and percent clearance MOEs. Given the large number of model input parameters, it was important to create an experimental design that efficiently and effectively explored the input parameter ranges. Regression analysis was utilized for each configuration to analyze the sensitivity of the MOEs to the various input factors. This chapter describes which model parameters were found to be the most impactful to the MOEs based on the sensitivity analysis performed as an output of the DOE and provides a foundation for the performance analysis leading to future MCM recommendations.

A. VARIABLES OF INTEREST

The variables of interest are defined by the input parameters of the models that are associated with MCM MOPs relevant to the legacy and future configurations for the scenario of interest. Table 25 shows the relevant input model parameters and initial value ranges based on SME feedback for the legacy and future configurations.

Table 25. Input Model Parameters and DOE Factors—Initial Ranges

Input Model Parameter	Parameter Description	Legacy Range		Future Range	
		Min	Max	Min	Max
S_SrchSpeed_kt	Surface search speed	1	5	1	10
S_TurnTime_s	Surface time to turn at the end of a track	300	600	300	600
S_TransitSpd_kt	Surface transit speed from staging area to minefield	10	15	20	50
S_NumHntTrk_pNM	Surface hunting tracks per nautical mile	1	80	1	80
S_SStreamT_hr	Surface time to stream search gear	0.25	2.00	0.25	2.00
S_SRecoverT_hr	Surface time to recover search gear	0.25	2.00	0.25	2.00
S_ReplenishT_hr	Surface time to replenish	24	48	4	8
S_SortieTime_hr	Surface max sortie time	336	504	16	20
S_NumPassPerTrk	Surface passes per track	1	1	1	1
S_Pd	Surface probability of detecting a MILEC	0.30	0.90	0.30	0.90
S_Pcmm	Surface probability of classifying a mine as a MILCO	0.50	0.90	0.50	0.90
S_Pcnn	Surface probability of classifying a non-mine as a non-MILCO	0.50	0.90	0.50	0.90
S_Prmm	Surface probability of reacquiring a mine as a MILCO	0.30	0.80	0.00	0.00

Input Model Parameter	Parameter Description	Legacy Range		Future Range	
		Min	Max	Min	Max
S_Prnn	Surface probability of reacquiring a non-mine as a non-MILCO	0.01	0.30	0.00	0.00
S_Pimm	Surface probability of identifying a mine as a mine	0.50	1.00	0.00	0.00
S_Pinn	Surface probability of identifying a non-mine as a non-mine	0.50	1.00	0.00	0.00
S_Pn	Surface probability of neutralizing a mine	0.50	0.90	0.00	0.00
S_SeaFox	Surface flag indicating whether legacy model uses SeaFox	0.00	1.00	0.00	0.00
S_SeaFox_PID	Surface flag indicating percentage of Sea-Fox's using ID rounds	0.10	0.60	0.00	0.00
S_Prmmml	Surface probability of reacquiring a mine, previously identified as a mine, as a mine	0.30	1.00	0.00	0.00
S_Prnnl	Surface probability of reacquiring a non-mine, previously identified as a mine, as a mine	0.01	0.50	0.00	0.00
S_RDeployT_hr	Surface time to deploy reacquisition and identification gear	0.10	2.00	0.00	0.00
S_RRecoverT_hr	Surface time to recover reacquisition and identification gear	0.10	2.00	0.00	0.00
S_RImuT_hr	Surface mean time for reacquisition and identification	0.25	1.00	0.00	0.00
S_RIsigmaT_hr	Surface standard deviation for reacquisition and identification	0.10	0.50	0.00	0.00
S_RNmuT_hr	Surface mean time for reacquisition and neutralization	0.25	1.00	0.00	0.00
S_RNsigtmaT_hr	Surface standard deviation for reacquisition and neutralization	0.10	0.50	0.00	0.00
S_RIminT_hr	Surface minimum time for reacquisition and identification	0.25	0.25	0.00	0.00
S_RNminT_hr	Surface minimum time for reacquisition and neutralization	0.25	0.25	0.00	0.00
S_NeutSpeed_kt	Surface neutralizer speed	0.10	5.00	0.00	0.00
S_SafeDist_yd	Surface safe distance from neutralizer	250	300	0	0
A_SrchSpeed_kt	Airborne search speed	10	30	0	0
A_TurnTime_s	Airborne time to turn at the end of a track	120	240	0	0
A_TransitSpd_kt	Airborne transit speed from staging area to minefield	40	180	40	150
A_NumHntTrk_pNM	Airborne hunting tracks per nautical mile	10	40	0	0
A_SStreamT_hr	Airborne time to stream gear	0.20	0.50	0.00	0.00
A_SRecoverT_hr	Airborne time to recover gear	0.20	0.50	0.00	0.00
A_ReplenishT_hr	Airborne time to replenish neutralizers	1	2	1	2
A_SortieTime_hr	Airborne max sortie time	1	4	1	3
A_NumPassPerTrk	Airborne passes per track	1	1	0	0
A_Pd	Airborne probability of detecting a MILEC	0.30	0.90	0.00	0.00
A_Pcmm	Airborne probability of classifying a mine as a MILCO	0.50	0.90	0.00	0.00
A_Pcnn	Airborne probability of classifying a non-mine as a non-MILCO	0.50	0.90	0.00	0.00

Input Model Parameter	Parameter Description	Legacy Range		Future Range	
		Min	Max	Min	Max
A_Prmm	Airborne probability of reacquiring a mine as a MILCO	0.30	0.80	0.30	0.80
A_Prnn	Airborne probability of reacquiring a non-mine as a non-MILCO	0.01	0.30	0.01	0.30
A_Pimm	Airborne probability of identifying a mine as a mine	0.50	1.00	0.50	1.00
A_Pinn	Airborne probability of identifying a non-mine as a non-mine	0.50	1.00	0.50	1.00
A_Pn	Airborne probability of neutralizing a mine	0.50	0.90	0.50	0.90
A_NumNeut	Airborne number of neutralizers	6	6	4	4
A_Neutralizer	A flag indicating whether legacy helicopter has neutralizers	0	1	0	0
A_RDeployT_hr	Airborne time to deploy reacquisition and identification gear	0.25	0.50	0.25	0.50
A_RRecoverT_hr	Airborne time to recover reacquisition and identification gear	0.25	0.50	0.25	0.50
A_RImuT_hr	Airborne mean time for reacquisition and identification	0.50	1.00	0.50	1.00
A_RIsigmaT_hr	Airborne standard deviation for reacquisition and identification	0.10	0.50	0.10	0.50
A_RIminT_hr	Airborne minimum time for reacquisition and identification	0.25	0.25	0.25	0.25
A_NeutSpeed	Airborne neutralizer speed	0.01	5.00	0.01	5.00
A_SafeDist_yd	Airborne safe distance from neutralizer	300	350	300	350
SLOCLength_NM	SLOC length	10	10	10	10
SLOCWidth_NM	SLOC width	10	10	10	10
NumNonMines	Number of non-mines	400	400	400	400
SearchSplitYpc	Minefield split between surface and airborne for legacy parallel search	0.25	0.75	0.25	0.75
StagingXPos_NM	Staging distance from minefield (x-axis)	-10	-40	-10	-40
StagingYPos_NM	Staging distance from minefield (y-axis)	0	10	0	10
NeutSplitYpc	Minefield split between surface and airborne for legacy parallel neutralization	0.25	0.75	0.25	0.75
NumMines	Number of mines	100	100	100	100

As can be seen in Table 26, some key similarities and differences between the legacy and future systems can be inferred from the input parameters ranges, such as:

- Similarities:
 - SLOC dimensions, number of non-mines, number of mines, and surface passes per track are constant and germane to legacy and future systems.
 - Probabilistic value ranges are intentionally wide due to the classification of actual values and are germane to legacy and future systems.

- Differences:
 - The future capability does not include using the RMS for neutralization so all associated surface neutralization probabilities are set to zero.
 - The future capability does not include using the MH-60S for detection or classification so all associated airborne search probabilities are set to zero.
 - The future surface capability provided by the RMS has better transit and search speeds compared to the legacy capability of the MCM 1.
 - The legacy surface sortie time provided by the MCM 1 is longer compared to the future capability of the RMS.
 - Originally, it was believed that the legacy airborne capability provided by the MH-53E could carry six neutralizers compared to four neutralizers carried by the future MH-60S. This was corrected during the second DOE, and is discussed further in Section B.

B. DESIGN OF EXPERIMENTS

Given the large number of factors and their associated ranges, simulation optimization and ranking/selection techniques did not appear to provide practical methods for determining which input parameters impacted the output MOE metrics of the models. A nearly orthogonal-and-balanced (NOAB) design was chosen primarily based on the number of allowable input factors. The Simulation Experiments and Efficient Designs (SEED) Center for Data Farming at the NPS provided a 512-point design for exploring up to 200 discrete factors and 100 continuous factors. The DOE afforded by the SEED NOAB tool provided a design that was:

- Nearly balanced in that every factor level occurs nearly equally often (Vieira Jr. et al. 2013)
- Nearly orthogonal in that the pairwise correlation between two factors is very small (Vieira Jr. et al. 2013)

These DOE characteristics enable investigation of the effect of one factor nearly independent of the other factors (Vieira Jr. et al. 2013). The 512-point design output from the NOAB tool provided input parameters for simulation runs of the models. This method determines the effect of each variable on ACRS and percent clearance by saturating the solution space with approximately evenly spaced orthogonal (independent) data points.

This process increases the efficiency of collecting data because the solution space is evenly saturated with data points, allowing the relationship between key system inputs and outputs to be determined without analyzing every possible combination of variables, which would be nearly impossible. Figure 54 depicts the principle of solution space saturation as a method to find correlations between data points of interest.

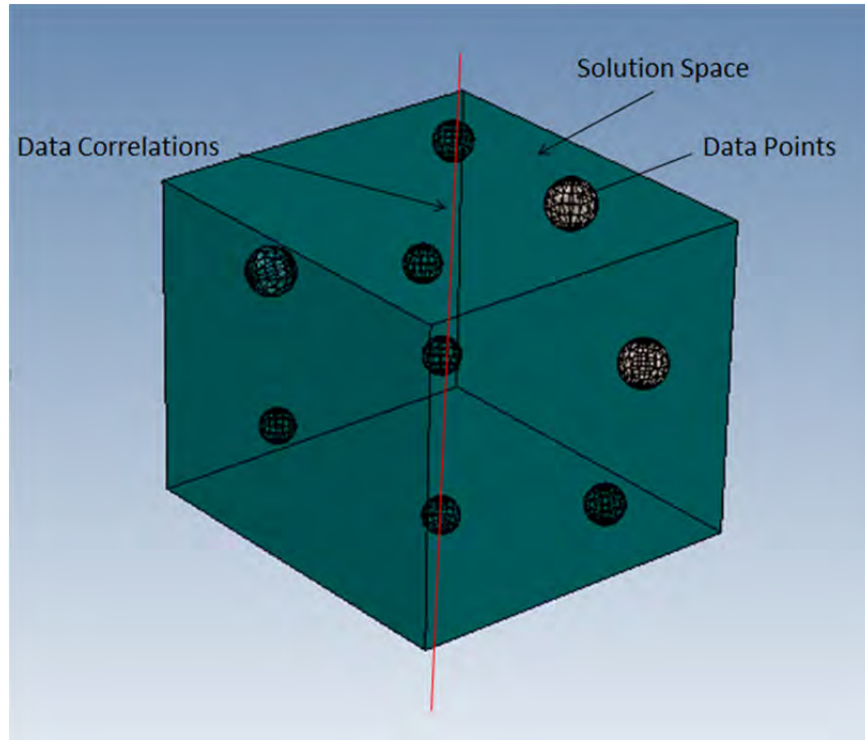

Figure 54. Figurative Solution Space Saturation: A Method to Find Data Correlations (after Vieira Jr. et al. 2013)

C. SENSITIVITY ANALYSIS

The process of determining which input variables have the biggest effect on the MOE involved using the 300 factor by 512-point design NOAB matrix, followed by a regression analysis. The NOAB matrix spreadsheet generates a random uniform distribution, from the minimum input value to the maximum value. For example, if the input variable surface probability of mine detection (S_{Pd}) varies over a range of 0.90 to 0.99, the NOAB tool generates design points evenly distributed from 0.90 to 0.99 from line one to line 512. The same process is repeated for each input variable in the NOAB matrix. The

uniformly distributed data for each input variable directly corresponds to the input variables in the ExtendSim model. The output data from the NOAB matrix was pasted into the input database of the model. The ExtendSim model utilized these input parameters to run the simulation, then generated a set of outputs that were associated with the performance of the model and resultant MOEs for the MCM scenario described in Chapter V. Once this was complete, a regression analysis was conducted to determine the linear relationships within the solution space and the sensitivity of the system output to that of the system inputs. Figure 55 shows the process used to conduct the sensitivity analysis. As seen in Figure 55, the input to the sensitivity analysis was the output from the model, which was analyzed with regression analysis to determine the input effects on the output. This process was repeated for each of the five model configurations. The regression analysis of the resultant data was evaluated using Minitab and JMP.

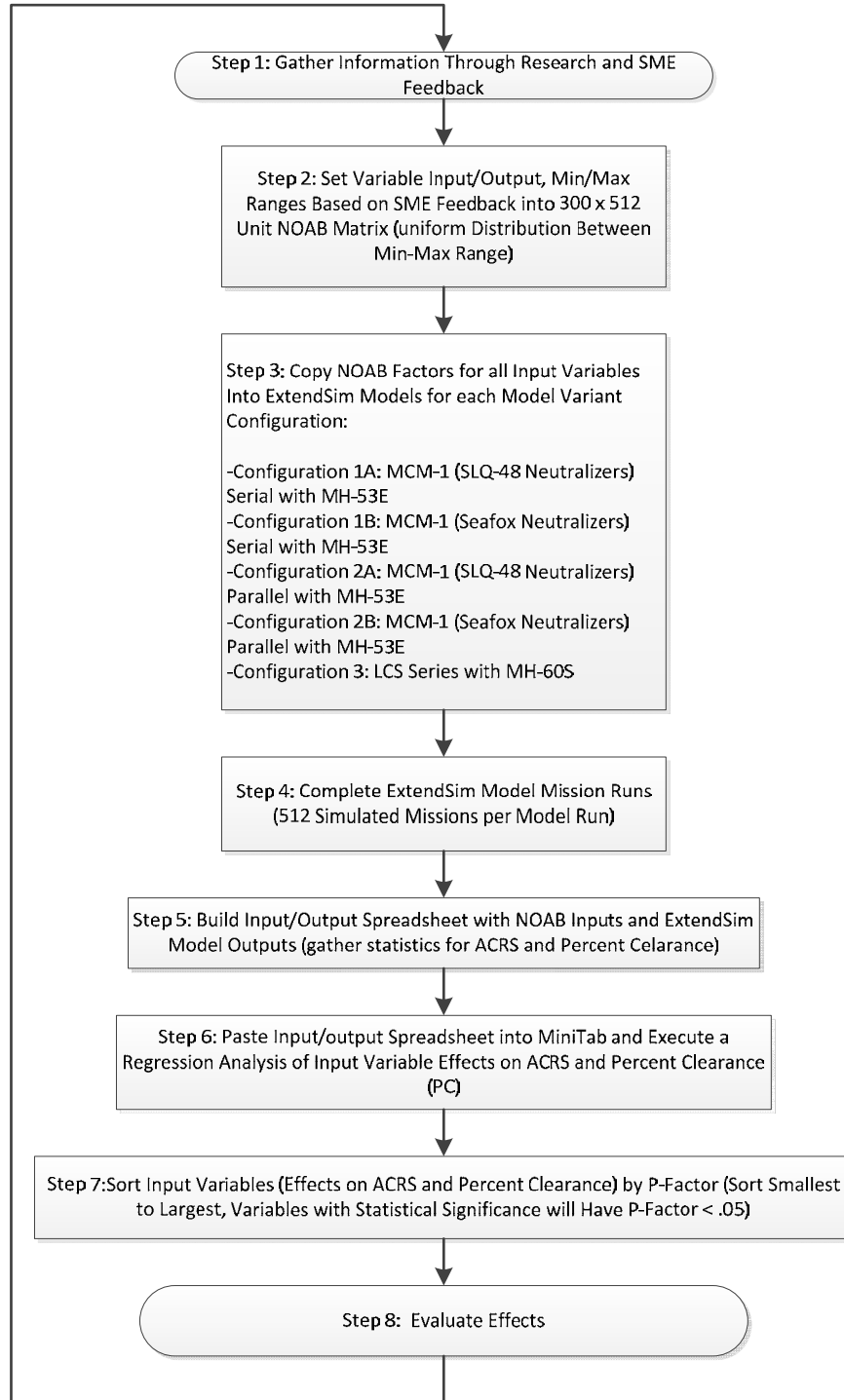

Figure 55. Sensitivity Analysis Process

The regression analysis measures the statistical significance of each input model parameter to the primary model output MOEs, in this case ACRS and percent clearance. The input model parameters were sorted by p-value in order to determine the statistical significance of each with respect to each MOE. Statistical significance, for the scope of this project, was defined as 0.05; i.e., the analysis only looked at those parameters with p-values less than or equal to 0.05.

1. Outputs of the Initial DOE

Based on the initial input ranges shown in Table 25, each model was run using the NOAB DOE and it was determined that there were some overlaps between the airborne sorties' times and distance between the staging area and the minefield. That is, the input ranges allowed for circumstances where a helicopter could not even make it to the minefield based on its speed and distance from the minefield and thereby resulting in no mines being neutralized in the case of the future systems. As a result, the input ranges were further refined.

2. Refinement of the Initial DOE

In order to eliminate the factor range inconsistencies cited above, the factor ranges were adjusted as shown in Table 26. Additionally, factor ranges were reduced based on SME feedback and educated assumptions. This resulted in the creation of a second DOE input matrix for each configuration. The changes from the initial DOE ranges, which are highlighted in green in Table 26, are:

- Minimum surface search speeds was increased from 1–5 knots to 2.5–5 knots for the legacy system and from 1–5 knots to 5–10 knots for the LCS
- Minimum airborne search speeds was increased from 10–30 knots to 15–30 knots for the legacy system
- Number of surface hunt tracks per nautical mile was fixed at 20, corresponding to 40 tracks over the 10 NM SLOC
- The future surface replenish time was reduced from 4–8 hours to 2–4 hours
- The future minimum surface sortie time was reduced from 16–20 to 10–20 hours

- Minimum surface and airborne search probabilities were increased from 0.3–0.9 to 0.7–0.9
- Minimum surface and airborne neutralize probabilities were increased from 0.5–0.9 to 0.7–0.9
- Minimum legacy airborne transit speeds were increased from 40–180 knots to 90–180 knots
- Minimum future airborne transit speeds were increased from 40–150 knots to 80–150 knots
- Airborne sortie times were fixed at four hours for the legacy systems and three for the future system
- The surface and airborne search and neutralize split percentages were refined to 0.33–0.66
- The lateral distance from the staging area to the minefield was reduced from 10–40 NM to 10–20 NM

Table 26. Input Model Parameters and DOE Factors—First Refinement

Input Model Parameter	Configuration 1A		Configuration 1B		Configuration 2A		Configuration 2B		Configuration 3	
	Min	Max	Min	Max	Min	Max	Min	Max	Min	Max
S_SrchSpeed_kt	2.50	5.00	2.50	5.00	2.50	5.00	2.50	5.00	5.00	10.00
S_TurnTime_s	300	600	300	600	300	600	300	600	300	600
S_TransitSpd_kt	10	15	10	15	10	15	10	15	20	50
S_NumHntTrk_pNM	20	20	20	20	20	20	20	20	20	20
S_SStreamT_hr	0.25	2.00	0.25	2.00	0.25	2.00	0.25	2.00	0.25	2.00
S_SRecoverT_hr	0.25	2.00	0.25	2.00	0.25	2.00	0.25	2.00	0.25	2.00
S_ReplenishT_hr	24	48	24	48	24	48	24	48	2	4
S_SortieTime_hr	336	504	336	504	336	504	336	504	10	20
S_NumPassPerTrk	1	1	1	1	1	1	1	1	1	1
S_Pd	0.70	0.90	0.70	0.90	0.70	0.90	0.70	0.90	0.70	0.90
S_Pcmm	0.70	0.90	0.70	0.90	0.70	0.90	0.70	0.90	0.70	0.90
S_Pcnn	0.70	0.90	0.70	0.90	0.70	0.90	0.70	0.90	0.70	0.90
S_Prmm	0.70	0.80	0.70	0.80	0.70	0.80	0.70	0.80	0.00	0.00
S_Prnn	0.70	0.30	0.70	0.30	0.70	0.30	0.70	0.30	0.00	0.00
S_Pimm	0.70	1.00	0.70	1.00	0.70	1.00	0.70	1.00	0.00	0.00
S_Pinn	0.70	1.00	0.70	1.00	0.70	1.00	0.70	1.00	0.00	0.00
S_Pn	0.70	0.90	0.70	0.90	0.70	0.90	0.70	0.90	0.00	0.00
S_SeaFox	0.00	0.00	0.00	1.00	0.00	0.00	0.00	1.00	0.00	0.00
S_SeaFox_PID	0.00	0.00	0.10	0.60	0.00	0.00	0.10	0.60	0.00	0.00
S_Prmm1	0.70	1.00	0.70	1.00	0.70	1.00	0.70	1.00	0.00	0.00
S_Prnn1	0.10	0.50	0.10	0.50	0.10	0.50	0.10	0.50	0.00	0.00
S_RDeployT_hr	0.10	2.00	0.10	2.00	0.10	2.00	0.10	2.00	0.00	0.00
S_RRecoverT_hr	0.10	2.00	0.10	2.00	0.10	2.00	0.10	2.00	0.00	0.00
S_RImuT_hr	0.25	1.00	0.25	1.00	0.25	1.00	0.25	1.00	0.00	0.00
S_RIsigmaT_hr	0.10	0.50	0.10	0.50	0.10	0.50	0.10	0.50	0.00	0.00
S_RNmuT_hr	0.00	0.00	0.25	1.00	0.00	0.00	0.25	1.00	0.00	0.00

Input Model Parameter	Configuration 1A		Configuration 1B		Configuration 2A		Configuration 2B		Configuration 3	
	Min	Max	Min	Max	Min	Max	Min	Max	Min	Max
S_RNsigmaT_hr	0.00	0.00	0.10	0.50	0.00	0.00	0.10	0.50	0.00	0.00
S_RIminT_hr	0.25	0.25	0.25	0.25	0.25	0.25	0.25	0.25	0.00	0.00
S_RNminT_hr	0.00	0.00	0.25	0.25	0.00	0.00	0.25	0.25	0.00	0.00
S_NeutSpeed_kt	2.50	5.00	2.50	5.00	2.50	5.00	2.50	5.00	0.00	0.00
S_SafeDist_yd	250	300	250	300	250	300	250	300	0	0
A_SrchSpeed_kt	15	30	15	30	15	30	15	30	0	0
A_TurnTime_s	120	240	120	240	120	240	120	240	0	0
A_TransitSpd_kt	90	180	90	180	90	180	90	180	80	150
A_NumHntTrk_pNM	20	20	20	20	20	20	20	20	0	0
A_SStreamT_hr	0.20	0.50	0.20	0.50	0.20	0.50	0.20	0.50	0.00	0.00
A_SRecoverT_hr	0.20	0.50	0.20	0.50	0.20	0.50	0.20	0.50	0.00	0.00
A_ReplenishT_hr	1	2	1	2	1	2	1	2	1	2
A_SortieTime_hr	4	4	4	4	4	4	4	4	3	3
A_NumPassPerTrk	1	1	1	1	1	1	1	1	0	0
A_Pd	0.70	0.90	0.70	0.90	0.70	0.90	0.70	0.90	0.00	0.00
A_Pcmm	0.70	0.90	0.70	0.90	0.70	0.90	0.70	0.90	0.00	0.00
A_Pcnn	0.70	0.90	0.70	0.90	0.70	0.90	0.70	0.90	0.00	0.00
A_Prmm	0.00	0.00	0.00	0.00	0.70	0.80	0.70	0.80	0.70	0.80
A_Prnn	0.00	0.00	0.00	0.00	0.10	0.30	0.10	0.30	0.10	0.30
A_Pimm	0.00	0.00	0.00	0.00	0.70	1.00	0.70	1.00	0.70	1.00
A_Pinn	0.00	0.00	0.00	0.00	0.70	1.00	0.70	1.00	0.70	1.00
A_Pn	0.00	0.00	0.00	0.00	0.70	0.90	0.70	0.90	0.70	0.90
A_NumNeut	0	0	0	0	6	6	6	6	4	4
A_Neutralizer	0	0	0	0	1	1	1	1	0	0
A_RDeployT_hr	0.00	0.00	0.00	0.00	0.25	0.50	0.25	0.50	0.25	0.50
A_RRecoverT_hr	0.00	0.00	0.00	0.00	0.25	0.50	0.25	0.50	0.25	0.50
A_RImuT_hr	0.00	0.00	0.00	0.00	0.25	0.50	0.25	0.50	0.25	0.50
A_RIsigmaT_hr	0.00	0.00	0.00	0.00	0.10	0.25	0.10	0.25	0.10	0.25
A_RIminT_hr	0.00	0.00	0.00	0.00	0.25	0.25	0.25	0.25	0.25	0.25
A_NeutSpeed	0.00	0.00	0.00	0.00	2.50	5.00	2.50	5.00	2.50	5.00
A_SafeDist_yd	0.00	0.00	0.00	0.00	300	350	300	350	300	350
SLOCLength_NM	10	10	10	10	10	10	10	10	10	10
SLOCWidth_NM	10	10	10	10	10	10	10	10	10	10
NumNonMines	400	400	400	400	400	400	400	400	400	400
SearchSplitYpc	0.33	0.66	0.33	0.66	0.33	0.66	0.33	0.66	0.33	0.66
StagingXPos_NM	-10	-20	-10	-20	-10	-20	-10	-20	-10	-20
StagingYPos_NM	0	10	0	10	0	10	0	10	0	10
NeutSplitYpc	0.33	0.66	0.33	0.66	0.33	0.66	0.33	0.66	0.33	0.66
NumMines	100	100	100	100	100	100	100	100	100	100

Using the modified DOEs based on these updated input parameter ranges yielded the MOE results shown in Table 27. As shown in this table, the parallel hunting operations represented in configurations 2A and 2B yield a slightly better ACRS than the other configurations, such that the 95% confidence interval surrounding the mean ACRS does

not overlap with any other configurations' confidence intervals. The percent clearance is similar across all five configurations.

Table 27. Simulation Outputs from the First DOE

DOE 1 Configuration	ACRS			Percent Clearance		
	Mean	95% Confidence Interval		Mean	95% Confidence Interval	
		Lower	Upper		Lower	Upper
Configuration 1A	4.31	4.25	4.38	0.33	0.32	0.34
Configuration 1B	4.27	4.20	4.34	0.31	0.30	0.32
Configuration 2A	5.31	5.21	5.41	0.33	0.32	0.34
Configuration 2B	5.30	5.20	5.40	0.31	0.30	0.32
Configuration 3	4.78	4.69	4.87	0.32	0.32	0.33

While the simulation results are discussed in detail in Chapter VIII, the regression analysis summarized in Table 28 indicates which factors had a statistically significant impact on the MOEs. All those factors highlighted in green indicate a p-value less than or equal to 0.05. As expected, the factors associated with time were generally found to be more impactful for the ACRS MOE, while the factors associated with the probabilities of minehunting were generally found to be more impactful for the percent clearance MOE.

Highlighted in blue in Table 28 are those factors that are not impactful to either MOE for any configuration. Model parameters showing a gray cell did not vary in the DOE and were therefore found to have a regression constant value of zero for that particular configuration. Not shown in Table 28 are those factors that were made constant for all configurations. These factors did not impact the regression analysis of the model outputs based on the first DOE:

- A_Neutralizer
- A_NumHntTrk_pNM
- A_NumNeut
- A_NumPassPerTrk
- A_RIminT_hr
- A_SortieTime_hr

- NumMines
- NumNonMines
- S_NumHntTrk_pNM
- S_NumPassPerTrk
- S_RIminT_hr
- S_RNminT_hr
- S_SeaFox
- SLOCLength_NM
- SLOCWidth_NM

Table 28. Sensitivity Analysis of Outputs from the First DOE

Input Model Parameter	Configuration 1A		Configuration 1B		Configuration 2A		Configuration 2B		Configuration 3	
	ACRS	Percent Clearance	ACRS	Percent Clearance	ACRS	Percent Clearance	ACRS	Percent Clearance	ACRS	Percent Clearance
A_NeutSpeed					0.965	0.632	0.352	0.554	0.042	0.623
A_Pcmm	0.000	0.000	0.000	0.000	0.033	0.000	0.004	0.000		
A_Pcnn	0.000	0.464	0.000	0.013	0.000	0.481	0.000	0.227		
A_Pd	0.000	0.000	0.000	0.000	0.000	0.000	0.000	0.000		
A_Pimm					0.693	0.000	0.555	0.000	0.104	0.000
A_Pinn					0.612	0.412	0.077	0.274	0.386	0.42
A_Pn					0.657	0.000	0.625	0.004	0.887	0.000
A_Prmm					0.664	0.036	0.197	0.841	0.447	0.000
A_Prnn					0.52	0.907	0.573	0.074	0.247	0.967
A_RDeployT_hr					0.863	0.412	0.566	0.485	0.008	0.359
A_ReplenishT_hr	0.609	0.484	0.291	0.726	0.826	0.368	0.799	0.736	0.027	0.478
A_RImuT_hr					0.119	0.549	0.785	0.93	0.077	0.209
A_RIsigmaT_hr					0.625	0.191	0.646	0.852	0.791	0.976
A_RRecoverT_hr					0.569	0.843	0.091	0.973	0.224	0.574
A_SafeDist_yd					0.854	0.991	0.227	0.649	0.688	0.313
A_SrchSpeed_kt	0.151	0.556	0.364	0.114	0.353	0.680	0.706	0.597		
A_SRecoverT_hr	0.112	0.447	0.082	0.638	0.781	0.739	0.493	0.544		
A_SStreamT_hr	0.009	0.203	0.207	0.229	0.302	0.725	0.333	0.582		
A_TransitSpd_kt	0.342	0.160	0.205	0.827	0.842	0.101	0.097	0.676	0.001	0.812
A_TurnTime_s	0.740	0.284	0.145	0.727	0.738	0.814	0.086	0.205		
NeutSplitYpc	0.728	0.580	0.739	0.765	0.000	0.204	0.000	0.642	0.941	0.112
S_NeutSpeed_kt	0.057	0.490	0.861	0.765	0.029	0.527	0.911	0.528		
S_Pcmm	0.026	0.000	0.148	0.000	0.671	0.000	0.147	0.000	0.957	0.000
S_Pcnn	0.038	0.794	0.007	0.847	0.000	0.712	0.000	0.153	0.000	0.818
S_Pd	0.100	0.000	0.004	0.000	0.111	0.000	0.005	0.000	0.031	0.000
S_Pimm	0.792	0.000	0.433	0.000	0.070	0.000	0.352	0.000		
S_Pinn	0.138	0.182	0.061	0.381	0.239	0.815	0.323	0.681		
S_Pn	0.878	0.000	0.895	0.000	0.819	0.000	0.439	0.000		
S_Prmm	0.391	0.000	0.639	0.000	0.910	0.000	0.091	0.000		

Input Model Parameter	Configuration 1A		Configuration 1B		Configuration 2A		Configuration 2B		Configuration 3	
	ACRS	Percent Clearance	ACRS	Percent Clearance	ACRS	Percent Clearance	ACRS	Percent Clearance	ACRS	Percent Clearance
S_Prmml	0.922	0.471	0.778	0.000	0.993	0.201	0.931	0.007		
S_Prnn	0.412	0.439	0.644	0.835	0.253	0.067	0.959	0.388		
S_Prnnl	0.009	0.659	0.050	0.884	0.003	0.709	0.022	0.747		
S_RDeployT_hr	0.000	0.715	0.000	0.566	0.000	0.919	0.000	0.821		
S_ReplenishT_hr	0.000	0.891	0.000	0.294	0.000	0.798	0.000	0.808	0.000	0.374
S_RImuT_hr	0.000	0.943	0.000	0.067	0.000	0.623	0.000	0.883		
S_RIsigmaT_hr	0.110	0.502	0.036	0.054	0.605	0.347	0.107	0.177		
S_RNmuT_hr			0.380	0.621			0.351	0.624		
S_RNsigmaT_hr			0.303	0.201			0.069	0.182		
S_RRecoverT_hr	0.000	0.912	0.000	0.731	0.000	0.650	0.000	0.439		
S_SafeDist_yd	0.554	0.523	0.653	0.724	0.436	0.614	0.500	0.062		
S_SeaFox_PID			0.243	0.002			0.001	0.021		
S_SortieTime_hr	0.000	0.219	0.000	0.190	0.000	0.893	0.000	0.551	0.000	0.765
S_SrchSpeed_kt	0.000	0.233	0.000	0.663	0.000	0.761	0.000	0.926	0.000	0.005
S_SRecoverT_hr	0.634	0.189	0.454	0.196	0.313	0.895	0.555	0.212	0.000	0.946
S_SStreamT_hr	0.157	0.552	0.278	0.022	0.895	0.869	0.037	0.107	0.000	0.204
S_TransitSpd_kt	0.902	0.805	0.788	0.09	0.815	0.409	0.232	0.244	0.000	0.393
S_TurnTime_s	0.042	0.116	0.009	0.532	0.025	0.417	0.035	0.011	0.001	0.160
SearchSplitYpc	0.000	0.579	0.000	0.627	0.000	0.051	0.000	0.242	0.071	0.385

3. Refinement of the First DOE

Based on the sensitivity results from the model outputs of the first DOE, some factors that were not found to be significant were made constant by selecting a fixed value roughly equal to the mid-point of the initial DOE range. In addition, some factors that were found to be not significant were still varied to see whether they would become significant based on other changes. Finally, a correction was made in the allowable number of airborne SeaFox neutralizers available on the MH-53E, changing the number from six to four (Brett Cordes, personal communication, 2 October 2014). This change is highlighted in green in Table 29, as it was a correction to the original and first DOE parameter values. A summary of the changes from the first DOE ranges, highlighted in blue in Table 29, are:

- Surface and airborne probabilities of reacquiring non-mines as non-mines were found to be insignificant and were made constant at 0.2
- Surface and airborne probabilities of identifying non-mines as non-mines were found to be insignificant and were made constant at 0.85
- Surface and airborne mean and standard deviation of reacquisition and neutralization times were found to be insignificant and were made constant with a mean of 0.375 hours and a standard deviation of 0.175 hours
- Surface and airborne safe stand-off distances for neutralization were found to be insignificant and were made constant at 275 yards for the surface platform and at 325 yards for the airborne platforms
- Airborne search speed and turn times were found to be insignificant and were made constant, airborne search speed was set to 22 knots and the turn times were set at 180 seconds
- The distance from the staging area to the minefield was made constant at 15 NM in the lateral direction and 5 NM in the vertical direction

Table 29. Sensitivity Analysis for Outputs of the Second DOE

Input Model Parameter	Configuration 1A		Configuration 1B		Configuration 2A		Configuration 2B		Configuration 3	
	Min	Max	Min	Max	Min	Max	Min	Max	Min	Max
S_SrchSpeed_kt	2.50	5.00	2.50	5.00	2.50	5.00	2.50	5.00	5.00	10.00
S_TurnTime_s	300	600	300	600	300	600	300	600	300	600
S_TransitSpd_kt	10	15	10	15	10	15	10	15	20	50
S_NumHntTrk_pNM	20	20	20	20	20	20	20	20	20	20

Input Model Parameter	Configuration 1A		Configuration 1B		Configuration 2A		Configuration 2B		Configuration 3	
	Min	Max	Min	Max	Min	Max	Min	Max	Min	Max
S_SSStreamT_hr	0.25	2.00	0.25	2.00	0.25	2.00	0.25	2.00	0.25	2.00
S_SRecoverT_hr	0.25	2.00	0.25	2.00	0.25	2.00	0.25	2.00	0.25	2.00
S_ReplenishT_hr	24	48	24	48	24	48	24	48	2	4
S_SortieTime_hr	336	504	336	504	336	504	336	504	10	20
S_NumPassPerTrk	1	1	1	1	1	1	1	1	1	1
S_Pd	0.70	0.90	0.70	0.90	0.70	0.90	0.70	0.90	0.70	0.90
S_Pcmm	0.70	0.90	0.70	0.90	0.70	0.90	0.70	0.90	0.70	0.90
S_Pcnn	0.70	0.90	0.70	0.90	0.70	0.90	0.70	0.90	0.70	0.90
S_Prmm	0.70	0.80	0.70	0.80	0.70	0.80	0.70	0.80	0.00	0.00
S_Prnn	0.20	0.20	0.20	0.20	0.20	0.20	0.20	0.20	0.00	0.00
S_Pimm	0.70	1.00	0.70	1.00	0.70	1.00	0.70	1.00	0.00	0.00
S_Pinn	0.85	0.85	0.85	0.85	0.85	0.85	0.85	0.85	0.00	0.00
S_Pn	0.70	0.90	0.70	0.90	0.70	0.90	0.70	0.90	0.00	0.00
S_SeaFox	0.00	0.00	0.00	1.00	0.00	0.00	0.00	1.00	0.00	0.00
S_SeaFox_PID	0.00	0.00	0.10	0.60	0.00	0.00	0.10	0.60	0.00	0.00
S_Prmmml	0.70	1.00	0.70	1.00	0.70	1.00	0.70	1.00	0.00	0.00
S_Prnnl	0.10	0.50	0.10	0.50	0.10	0.50	0.10	0.50	0.00	0.00
S_RDeployT_hr	0.10	2.00	0.10	2.00	0.10	2.00	0.10	2.00	0.00	0.00
S_RRecoverT_hr	0.10	2.00	0.10	2.00	0.10	2.00	0.10	2.00	0.00	0.00
S_RImuT_hr	0.375	0.375	0.375	0.375	0.375	0.375	0.375	0.375	0.00	0.00
S_RIsigmaT_hr	0.175	0.175	0.175	0.175	0.175	0.175	0.175	0.175	0.00	0.00
S_RNmuT_hr	0.00	0.00	0.375	0.375	0.00	0.00	0.375	0.375	0.00	0.00
S_RNsigmaT_hr	0.00	0.00	0.175	0.175	0.00	0.00	0.175	0.175	0.00	0.00
S_RIminT_hr	0.25	0.25	0.25	0.25	0.25	0.25	0.25	0.25	0.00	0.00
S_RNminT_hr	0.00	0.00	0.25	0.25	0.00	0.00	0.25	0.25	0.00	0.00
S_NeutSpeed_kt	2.50	5.00	2.50	5.00	2.50	5.00	2.50	5.00	0.00	0.00
S_SafeDist_yd	275	275	275	275	275	275	275	275	0	0
A_SrchSpeed_kt	22	22	22	22	22	22	22	22	0	0
A_TurnTime_s	180	180	180	180	180	180	180	180	0	0
A_TransitSpd_kt	90	180	90	180	90	180	90	180	80	150
A_NumHntTrk_pNM	20	20	20	20	20	20	20	20	0	0
A_SSStreamT_hr	0.20	0.50	0.20	0.50	0.20	0.50	0.20	0.50	0.00	0.00
A_SRecoverT_hr	0.20	0.50	0.20	0.50	0.20	0.50	0.20	0.50	0.00	0.00
A_ReplenishT_hr	1	2	1	2	1	2	1	2	1	2
A_SortieTime_hr	4	4	4	4	4	4	4	4	3	3
A_NumPassPerTrk	1	1	1	1	1	1	1	1	0	0
A_Pd	0.70	0.90	0.70	0.90	0.70	0.90	0.70	0.90	0.00	0.00
A_Pcmm	0.70	0.90	0.70	0.90	0.70	0.90	0.70	0.90	0.00	0.00
A_Pcnn	0.70	0.90	0.70	0.90	0.70	0.90	0.70	0.90	0.00	0.00
A_Prmm	0.00	0.00	0.00	0.00	0.70	0.80	0.70	0.80	0.70	0.80
A_Prnn	0.00	0.00	0.00	0.00	0.20	0.20	0.20	0.20	0.20	0.30
A_Pimm	0.00	0.00	0.00	0.00	0.70	1.00	0.70	1.00	0.70	1.00
A_Pinn	0.00	0.00	0.00	0.00	0.85	0.85	0.85	0.85	0.85	0.85
A_Pn	0.00	0.00	0.00	0.00	0.70	0.90	0.70	0.90	0.70	0.90
A_NumNeut	0	0	0	0	4	4	4	4	4	4
A_Neutralizer	0	0	0	0	1	1	1	1	0	0
A_RDeployT_hr	0.00	0.00	0.00	0.00	0.25	0.50	0.25	0.50	0.25	0.50
A_RRecoverT_hr	0.00	0.00	0.00	0.00	0.25	0.50	0.25	0.50	0.25	0.50

Input Model Parameter	Configura- tion 1A		Configura- tion 1B		Configura- tion 2A		Configura- tion 2B		Configura- tion 3	
	Min	Max	Min	Max	Min	Max	Min	Max	Min	Max
A_RImuT_hr	0.00	0.00	0.00	0.00	0.375	0.375	0.375	0.375	0.375	0.375
A_RIsigmaT_hr	0.00	0.00	0.00	0.00	0.175	0.175	0.175	0.175	0.175	0.175
A_RIminT_hr	0.00	0.00	0.00	0.00	0.25	0.25	0.25	0.25	0.25	0.25
A_NeutSpeed	0.00	0.00	0.00	0.00	2.50	5.00	2.50	5.00	2.50	5.00
A_SafeDist_yd	0.00	0.00	0.00	0.00	325	325	325	325	325	325
SLOCLength_NM	10	10	10	10	10	10	10	10	10	10
SLOCWidth_NM	10	10	10	10	10	10	10	10	10	10
NumNonMines	400	400	400	400	400	400	400	400	400	400
SearchSplitYpc	0.33	0.66	0.33	0.66	0.33	0.66	0.33	0.66	0.33	0.66
StagingXPos_NM	-15	-15	-15	-15	-15	-15	-15	-15	-15	-15
StagingYPos_NM	5	5	5	5	5	5	5	5	5	5
NeutSplitYpc	0.33	0.66	0.33	0.66	0.33	0.66	0.33	0.66	0.33	0.66
NumMines	100	100	100	100	100	100	100	100	100	100

Using the second DOE based on these updated input parameter ranges yielded the MOE results shown in Table 30. As expected, setting insignificant factors from the first DOE constant did not have much impact on the resultant MOE values.

Table 30. Simulation Outputs from the Second DOE

Model Configuration	ACRS						Percent Clearance					
	DOE 1			DOE 2			DOE 1			DOE 2		
	Mean	95% Confidence Interval		Mean	95% Confidence Interval		Mean	95% Confidence Interval		Mean	95% Confidence Interval	
		Lower	Upper		Lower	Upper		Lower	Upper		Lower	Upper
1A	4.31	4.24	4.38	4.32	4.25	4.39	0.33	0.32	0.34	0.33	0.32	0.34
1B	4.27	4.20	4.34	4.28	4.21	4.35	0.31	0.30	0.32	0.31	0.30	0.32
2A	5.31	5.21	5.41	5.35	5.25	5.45	0.33	0.32	0.34	0.33	0.32	0.34
2B	5.30	5.20	5.40	5.30	5.20	5.40	0.31	0.30	0.32	0.31	0.30	0.32
3	4.78	4.69	4.87	4.80	4.71	4.89	0.32	0.31	0.33	0.33	0.32	0.34

Results from the second DOE were similar to the results obtained in the first DOE. Table 31 summarizes these results and shows the impactful inputs (highlighted in green) as well as the inputs that were discovered to be not significant (highlighted in blue). Model parameters showing a gray cell did not vary in the DOE and were therefore found to have a regression constant value of zero for that particular configuration. Not shown in Table 31 are those factors that were made constant based on the results from the first DOE. The factors that did not impact the regression analysis of the model outputs based on the second DOE, in addition to those constant factors found as a result of the first DOE are:

- A_Pinn
- A_Prnn
- A_RImuT_hr
- A_RIsigmaT_hr
- A_SafeDist_yd
- A_SrchSpeed_kt
- A_TurnTime_s
- S_Pinn
- S_Prnn
- S_RImuT_hr
- S_RIsigmaT_hr
- S_RNmuT_hr
- S_RNsigmaT_hr
- S_SafeDist_yd
- StagingXPos_NM
- StagingYPos_NM

Table 31. Sensitivity Analysis for Outputs of the Second DOE

Input Model Parameter	Configuration 1A		Configuration 1B		Configuration 2A		Configuration 2B		Configuration 3	
	ACRS	Percent Clearance	ACRS	Percent Clearance	ACRS	Percent Clearance	ACRS	Percent Clearance	ACRS	Percent Clearance
A_NeutSpeed					0.178	0.145	0.758	0.42	0.069	0.797
A_Pcmm	0.001	0.000	0.006	0.000	0.039	0.000	0.033	0.000		
A_Pcnn	0.000	0.299	0.000	0.884	0.000	0.544	0.000	0.153		
A_Pd	0.000	0.000	0.000	0.000	0.000	0.000	0.000	0.000		
A_Pimm					0.774	0.000	0.055	0.000	0.035	0.000
A_Pn					0.270	0.006	0.700	0.017	0.413	0.000
A_Prmm					0.740	0.263	0.531	0.245	0.233	0.000
A_RDeployT_hr					0.996	0.816	0.674	0.018	0.001	0.748
A_ReplenishT_hr	0.753	0.766	0.654	0.245	0.885	0.641	0.995	0.055	0.186	0.129
A_RRecoverT_hr					0.502	0.488	0.515	0.196	0.650	0.354
A_SRecoverT_hr	0.033	0.620	0.050	0.837	0.338	0.902	0.446	0.008		
A_SStreamT_hr	0.196	0.788	0.696	0.449	0.358	0.820	0.791	0.356		
A_TransitSpd_kt	0.170	0.876	0.466	0.503	0.327	0.515	0.358	0.615	0.012	0.014
NeutSplitYpc	0.561	0.172	0.402	0.481	0.000	0.402	0.000	0.072	0.990	0.632
S_NeutSpeed_kt	0.100	0.057	0.118	0.306	0.065	0.060	0.173	0.210		
S_Pcmm	0.047	0.000	0.121	0.000	0.081	0.000	0.249	0.000	0.312	0.000
S_Pcnn	0.016	0.015	0.389	0.271	0.000	0.650	0.000	0.841	0.000	0.187
S_Pd	0.045	0.000	0.032	0.000	0.039	0.000	0.033	0.000	0.053	0.000
S_Pimm	0.181	0.000	0.128	0.000	0.324	0.000	0.095	0.000		
S_Pn	0.879	0.000	0.420	0.000	0.986	0.000	0.771	0.000		
S_Prmm	0.447	0.000	0.189	0.000	0.152	0.002	0.130	0.000		
S_PrmmI	0.364	0.657	0.678	0.000	0.227	0.559	0.700	0.098		
S_PrnnI	0.011	0.343	0.030	0.400	0.020	0.903	0.030	0.080		
S_RDeployT_hr	0.000	0.510	0.000	0.760	0.000	0.920	0.000	0.440		
S_ReplenishT_hr	0.000	0.613	0.000	0.650	0.000	0.549	0.000	0.600	0.000	0.258
S_RRecoverT_hr	0.000	0.142	0.000	0.207	0.000	0.131	0.000	0.760		
S_SeaFox_PID			0.461	0.000			0.000	0.022		
S_SortieTime_hr	0.000	0.259	0.000	0.298	0.000	0.494	0.000	0.484	0.000	0.834
S_SrchSpeed_kt	0.000	0.691	0.000	0.335	0.000	0.789	0.000	0.198	0.000	0.544

Input Model Parameter	Configuration 1A		Configuration 1B		Configuration 2A		Configuration 2B		Configuration 3	
	ACRS	Percent Clearance	ACRS	Percent Clearance	ACRS	Percent Clearance	ACRS	Percent Clearance	ACRS	Percent Clearance
S_SRecoverT_hr	0.826	0.722	0.427	0.560	0.579	0.051	0.252	0.849	0.000	0.041
S_SStreamT_hr	0.011	0.451	0.003	0.752	0.050	0.696	0.043	0.318	0.000	0.023
S_TransitSpd_kt	0.769	0.970	0.291	0.528	0.248	0.210	0.620	0.565	0.000	0.154
S_TurnTime_s	0.001	0.068	0.015	0.300	0.035	0.926	0.039	0.202	0.000	0.395
SearchSplitYpc	0.000	0.039	0.000	0.316	0.000	0.211	0.000	0.695	0.019	0.346

Additionally, the DOE data from the second DOE was examined for significant two-factor interactions. Due to the large number of factors and subsequent two-way interactions, the data were fed into JMP for this analysis because of its greater facility with large data sets (Paul Beery, personal communication, 1 October 2014).

All constant data were removed from consideration, and then each response variable was considered independently in JMP's least squares regression model fitting. An iterative approach was taken to the model fitting, with each model examined for goodness of fit, number of factors, residuals, and any other anomalies.

ACRS was considered first; all factors were put in for the initial analysis, and then sorted by p-value. Only those factors significant at the $\alpha = 0.10$ level were included in the second regression. The second regression also included all two-way interactions between these factors. All factors and interactions significant at the $\alpha = 0.05$ level were selected into another least squares fitting. In cases in which an interaction was significant, but one or more of its factors was not, the factors were retained despite non-significance. This was iterated until no interactions or factors had a p-value greater than 0.05, with the exception of those factors retained due to significant interaction with another factor.

An additional fit was run retaining only those factors significant at the $\alpha = 0.01$ level to examine the effect on R^2 and R^2 -adjusted. R^2 is a measure of how much of the data's variation can be explained by the model; values near one are desirable. R^2 -adjusted is the R^2 value adjusted by the number of variables such that additional variables are penalized. This enables comparison between models with different numbers of variables and rewards a simpler model with fewer variables even though it may describe less of the variation; once again, a value near one is desirable and a lower value is less desirable (Montgomery and Runger 2011, 428-9 & 472).

Table 32 contains the summary statistics of the ACRS fit. The configurations with the greatest R^2 values are highlighted in yellow, and the configurations with the greatest R^2 -adjusted values are highlighted in green.

Table 32. ACRS Fit Summary Statistics

ACRS Fit Summary		Configuration 1A	Configuration 1B	Configuration 2A	Configuration 2B	Configuration 3
First Fit (no interactions)	# Factors In	27	28	33	34	20
	# Factors (p <0.10)	16	14	14	18	14
	R ²	0.867	0.869	0.921	0.912	0.925
	R ² -adjusted	0.859	0.861	0.915	0.906	0.922
Second Fit (Two-way interactions)	# Factors In	136	105	105	171	105
	# Factors (p <0.05)	34	26	21	37	26
	R ²	0.952	0.943	0.925	0.961	0.948
	R ² -adjusted	0.935	0.928	0.906	0.941	0.935
Intermediate Fit	# Factors In	37	28	22	38	28
	# Factors (p <0.05)	32	26	20	32	23
	R ²	0.941	0.933	0.906	0.945	0.941
	R ² -adjusted	0.936	0.929	0.902	0.940	0.938
Final Fit (p <0.05)	# Factors In	35	27	21	29	22
	# Factors (p <0.05)	31	26	20	29	21
	R ²	0.940	0.933	0.905	0.942	0.939
	R ² -adjusted	0.935	0.929	0.901	0.939	0.936
Reduced Fit (Factors In have p <0.01)	# Factors In	26	22	15	25	14
	# Factors (p <0.01)	25	22	15	25	14
	R ²	0.935	0.930	0.900	0.939	0.933
	R ² -adjusted	0.931	0.927	0.897	0.936	0.931
Maximum R ²		0.952	0.943	0.925	0.961	0.948
Maximum R ² -adjusted		0.936	0.929	0.915	0.941	0.938

From the table, it can be seen that the second fitting, which included two-way interactions, uniformly resulted in the highest R² value, indicating that inclusion of two-way interactions was important to explain the variability in the model. R² values fell in the range between 0.86 and 0.97, indicating the statistical model has good explanatory power. As expected, further reduction of the number of factors resulted in lower R² values, as less of the variation was explained.

The R²-adjusted values were similar, ranging between 0.85 and 0.95. Adding in the interactions resulted in a higher R²-adjusted value, indicating that the additional explanatory power of the interactions was more valuable than the added complexity. Only

configuration 2A with four neutralizers was an exception. Further, for most configurations, the reduction of factors down to only those factors and interactions with p-values less than .05 resulted in a better R^2 -adjusted value. This is expected, as much of the variation is still explained, but fewer variables are required to do so. In a few instances this was not true; however, in all cases reduction of factors down to only those with p-values less than 0.01 still had relatively little reduction on the R^2 -adjusted value, which may indicate it is reasonable to reduce the statistical models down to these factors.

It should be noted that although the fits for ACRS had high R^2 values, they also had some faintly patterned residual plots resembling a “V” lying on its side (i.e., “<”), which indicated the need for further transformation of the data. This pattern was much more prevalent in the first stages of model fitting. Reduction in the factors included in the model appeared in most cases to minimize this behavior; however, transformations using both the log and square root were attempted to evaluate the effect of a contractile function on the residuals and fit statistics. Additionally, configuration 3 has an apparent outlier. None of the values input were out of the ordinary and there appears to be no obvious reason to remove this point beyond its anomalous deviation from expectation. It may indicate a poorly understood higher-order interaction, or the result of an unlikely event. For the sake of completeness, a fit was performed with this outlier removed to check for changes in fit and significance. Residual plots for the models with only factors significant at the $\alpha = 0.01$ level, are depicted in Figures 56–60. Figure 61 contains the residual plot of configuration 3 without the outlier.

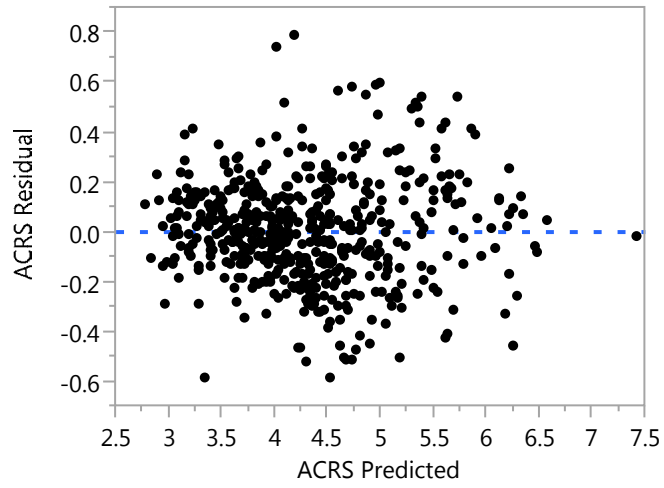

Figure 56. Residual by Predicted Plot—Configuration 1A

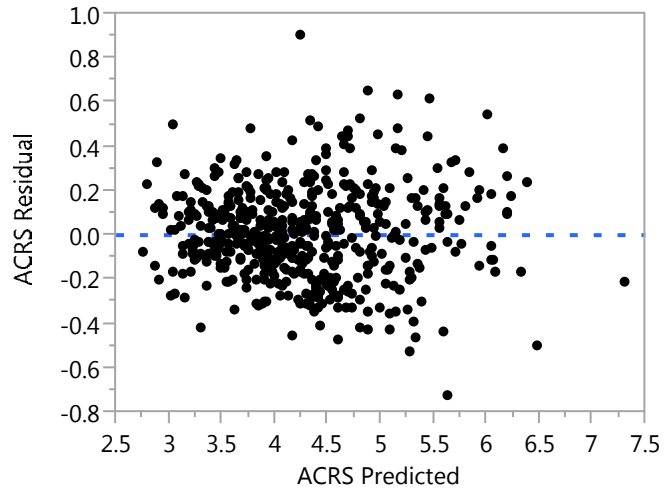

Figure 57. Residual by Predicted Plot—Configuration 1B

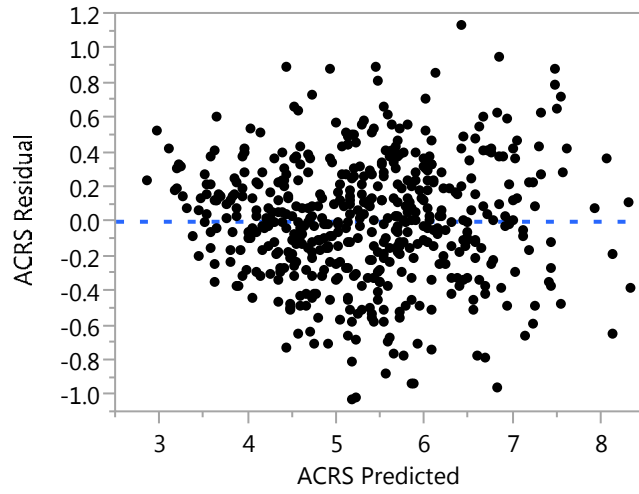

Figure 58. Residual by Predicted Plot—Configuration 2A

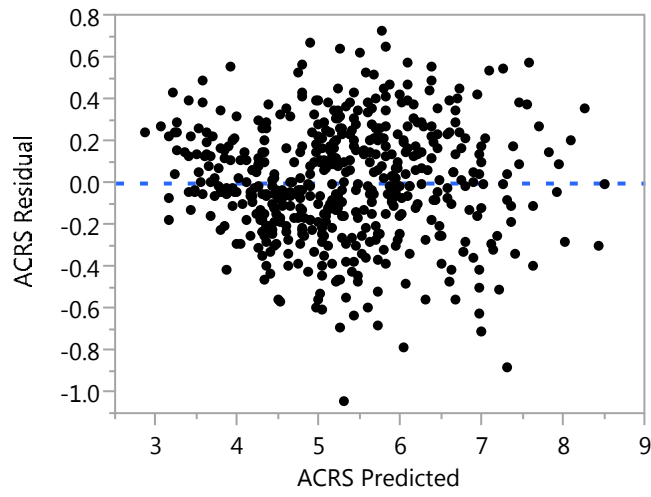

Figure 59. Residual by Predicted Plot—Configuration 2B

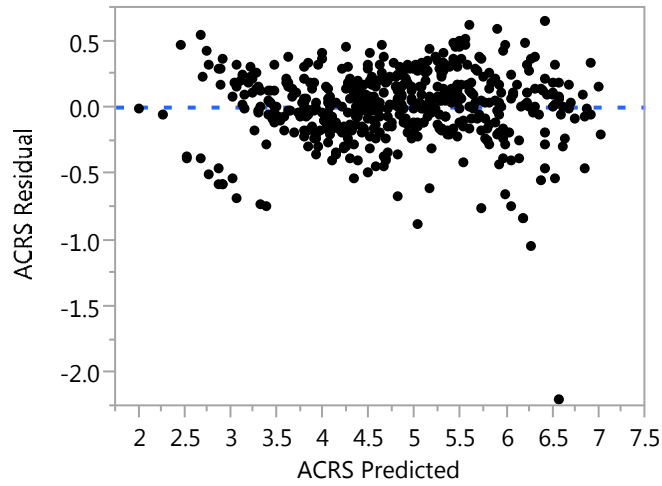

Figure 60. Residual by Predicted Plot—Configuration 3

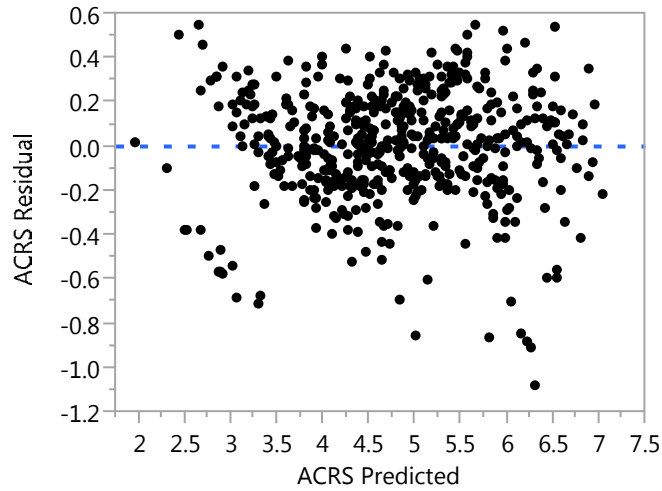

Figure 61. Residual by Predicted Plot-Configuration 3 Without Outlier

Residual plots for the log and square root transformations are included in Figures 62–67. Note that the contracted data have slightly better residual plots. For this reason, transformed versions of the ACRS were considered in later steps as well.

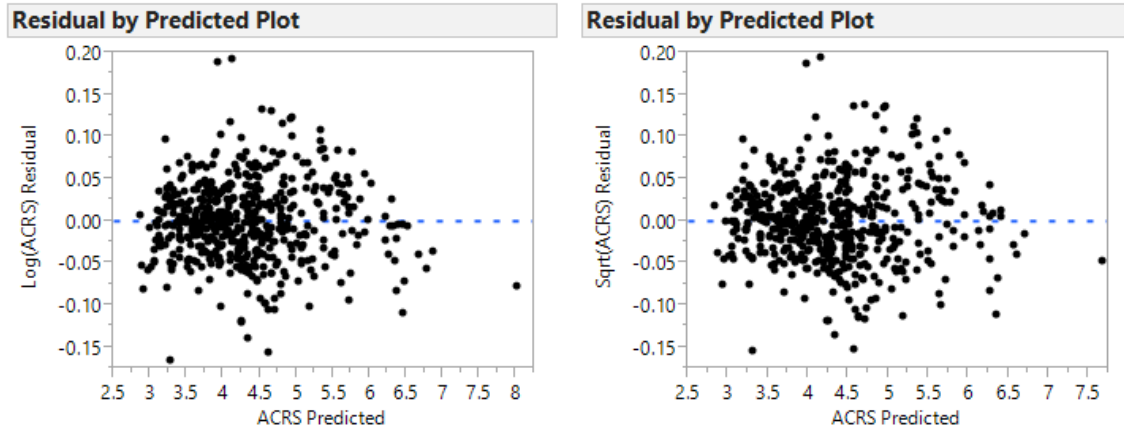

Figure 62. Configuration 1A Transformed Residuals Plot

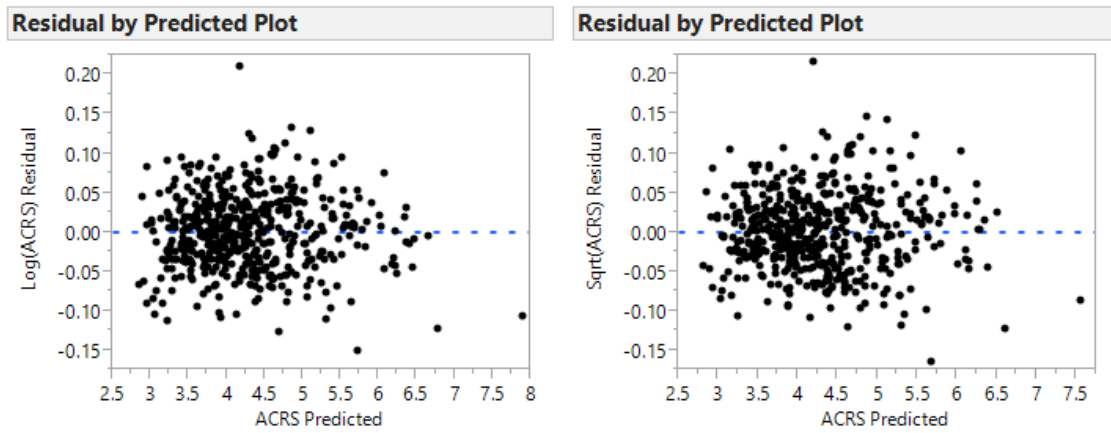

Figure 63. Configuration 1B Transformed Residuals Plot

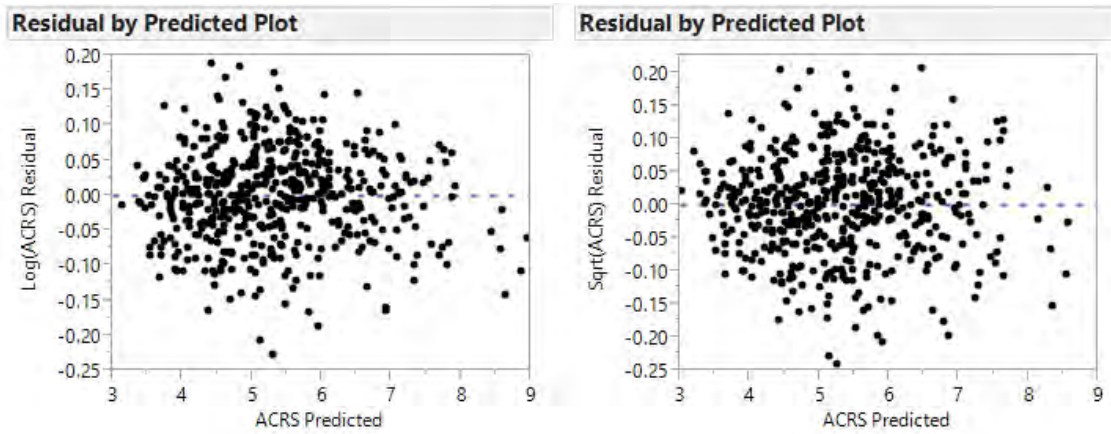

Figure 64. Configuration 2A Transformed Residuals Plot

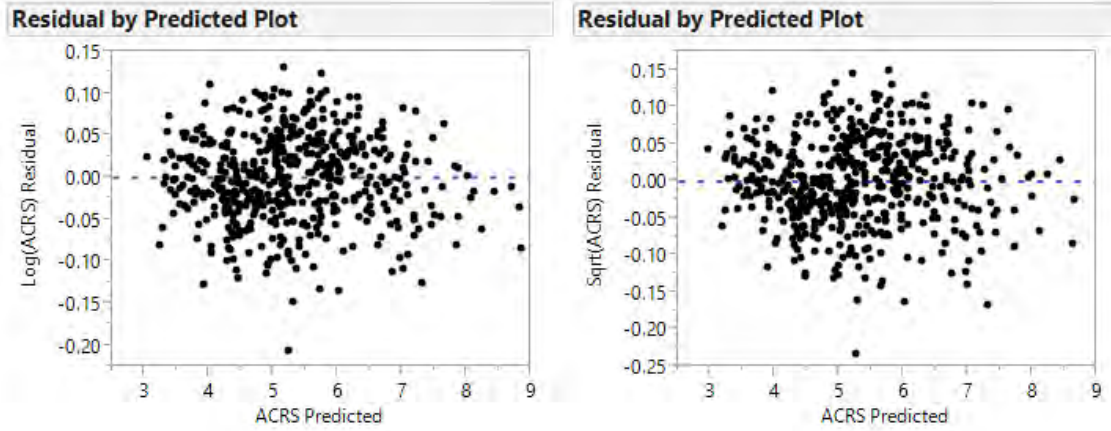

Figure 65. Configuration 2B Transformed Residuals Plot

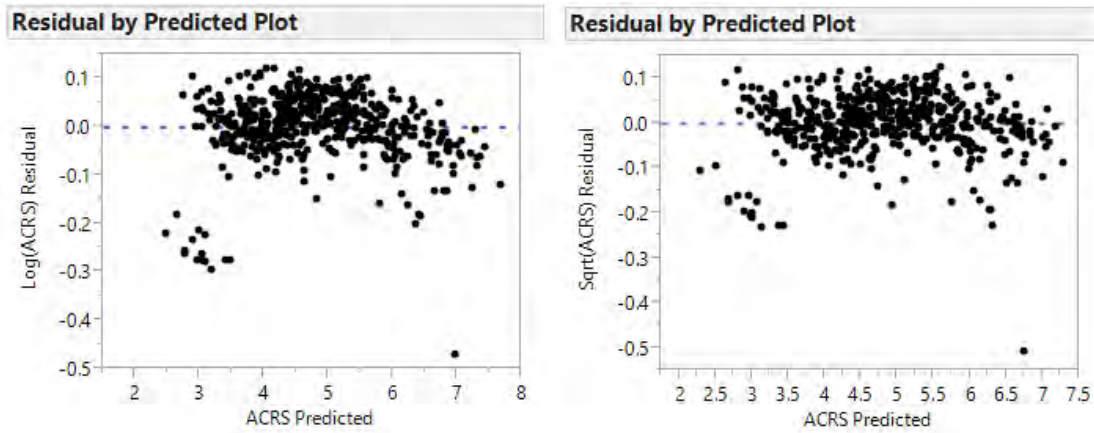

Figure 66. Configuration 3 Transformed Residuals Plot

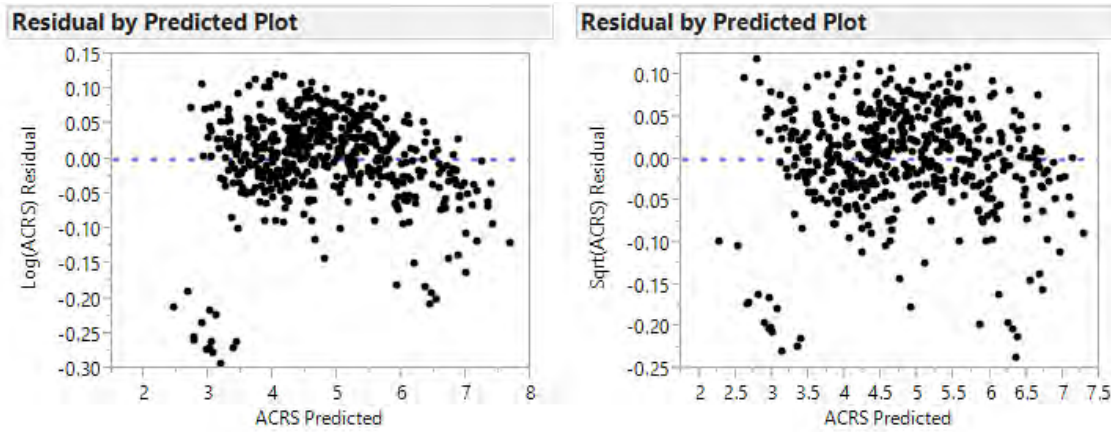

Figure 67. Configuration 3 Without Outlier Transformed Residuals Plot

Table 33 contains a list in order of decreasing statistical significance of all factors and interactions included in the $\alpha = 0.01$ model for ACRS. As shown, many of the factors are significant for all configurations.

Table 33. Factors Included in the ACRS Model Fit

Configuration 1A	Configuration 1B	Configuration 2A	Configuration 2B	Configuration 3	Configuration 3 (No Outlier)
S_SrchSpeed_kt	S_SrchSpeed_kt	S_SrchSpeed_kt	S_SrchSpeed_kt	S_SrchSpeed_kt	S_SrchSpeed_kt
S_RRecoverT_hr	S_RRecoverT_hr	SearchSplitYpc	SearchSplitYpc	S_SortieTime_hr	S_SortieTime_hr
S_RDeployT_hr	S_RDeployT_hr	S_RRecoverT_hr	S_RDeployT_hr	S_SRecoverT_hr	S_SRecoverT_hr
SearchSplitYpc	SearchSplitYpc	S_RDeployT_hr	S_RRecoverT_hr	S_SStreamT_hr	S_SStreamT_hr
A_Pcnn	A_Pcnn	A_Pcnn	NeutSplitYpc	S_ReplenishT_hr	S_ReplenishT_hr
(S_RRecoverT_hr)* (SearchSplitYpc)	A_Pd	A_Pd	A_Pcnn	S_TransitSpd_kt	S_TransitSpd_kt
A_Pd	(S_RRecoverT_hr)* (SearchSplitYpc)	S_ReplenishT_hr	S_ReplenishT_hr	(S_SStreamT_hr)* (S_SortieTime_hr)	(S_SStreamT_hr)* (S_SortieTime_hr)
(S_RDeployT_hr)* (SearchSplitYpc)	S_ReplenishT_hr	(S_RDeployT_hr)* (SearchSplitYpc)	(S_RRecoverT_hr)* (SearchSplitYpc)	(S_SrchSpeed_kt)* (S_Pcnn)	S_TurnTime_s
(S_SrchSpeed_kt)* (S_RRecoverT_hr)	(S_RDeployT_hr)* (SearchSplitYpc)	S_SortieTime_hr	(A_Pcnn)* (SearchSplitYpc)	S_Pcnn	(S_SRecoverT_hr)* (S_SortieTime_hr)
S_ReplenishT_hr	(S_SrchSpeed_kt)* (S_RRecoverT_hr)	S_Pcnn	(SearchSplitYpc)* (NeutSplitYpc)	(S_SRecoverT_hr)* (S_SortieTime_hr)	S_Pcnn
(S_SrchSpeed_kt)* (S_RDeployT_hr)	S_SortieTime_hr	(S_SrchSpeed_kt)* (S_RRecoverT_hr)	S_SortieTime_hr	S_TurnTime_s	(S_SrchSpeed_kt)* (S_Pcnn)
S_SortieTime_hr	(S_SrchSpeed_kt)* (S_RDeployT_hr)	(S_SrchSpeed_kt)* (S_RDeployT_hr)	A_Pd	A_RDeployT_hr	(S_TransitSpd_kt)* (S_SortieTime_hr)
(S_RDeployT_hr)* (S_RRecoverT_hr)	(A_Pcnn)* (SearchSplitYpc)	(S_RRecoverT_hr)* (SearchSplitYpc)	(S_RDeployT_hr)* (SearchSplitYpc)	(S_SrchSpeed_kt)* (A_RDeployT_hr)	A_RDeployT_hr
A_Pcmm	(S_RDeployT_hr)* (S_RRecoverT_hr)	(A_Pcnn)* (SearchSplitYpc)	(S_SrchSpeed_kt)* (S_RDeployT_hr)	(S_TransitSpd_kt)* (S_SortieTime_hr)	(S_SrchSpeed_kt)* (A_RDeployT_hr)
(A_Pcnn)*(SearchSplitYpc)	(S_SrchSpeed_kt)* (A_Pcnn)	(S_SrchSpeed_kt)* (S_ReplenishT_hr)	(S_SrchSpeed_kt)* (NeutSplitYpc)		
S_Pcnn	A_Pcmm		S_SeaFox_PID		
(S_SrchSpeed_kt)* (S_SortieTime_hr)	(S_SrchSpeed_kt)* (S_SortieTime_hr)		(A_Pd)* (SearchSplitYpc)		
(S_SrchSpeed_kt)*	(A_Pd)*		S_Pcnn		

Configuration 1A	Configuration 1B	Configuration 2A	Configuration 2B	Configuration 3	Configuration 3 (No Outlier)
(A_Pcnn)	(SearchSplitYpc)				
S_TurnTime_s	(S_SortieTime_hr)* (S_RRecoverT_hr)		(S_RDeployT_hr)* (NeutSplitYpc)		
(S_SStreamT_hr)* (A_Pd)	S_TurnTime_s		A_Pcmm		
(S_SrchSpeed_kt)* (A_Pd)	S_Pd		(S_SrchSpeed_kt)* (SearchSplitYpc)		
S_Pd	(A_Pcmm)* (SearchSplitYpc)		S_Pd		
(S_SortieTime_hr)* (S_RRecoverT_hr)			(S_Pcnn)* (S_SeaFox_PID)		
(S_ReplenishT_hr)* (S_RDeployT_hr)			S_Pimm		
(S_SortieTime_hr)* (S_RDeployT_hr)			(S_SeaFox_PID)* (SearchSplitYpc)		
S_SStreamT_hr					

Legend (For a full list of model parameters, see Tables 17 through 20 in Chapter VI)

A_Pcmm: Airborne probability of classifying a mine as a MILCO

A_Pcnn: Airborne probability of classifying a non-mine as a non-MILCO

A_Pd: Airborne probability of detecting a MILEC

A_RDeployT_hr: Airborne time to deploy reacquisition and identification gear

NeutSplitYpc: Minefield split between surface and airborne for legacy parallel neutralization

S_Pcnn: Surface probability of classifying a non-mine as a non-MILCO

S_RDeployT_hr: Surface time to deploy reacquisition and identification gear

S_ReplenishT_hr: Surface time to replenish

S_RRecoverT_hr: Surface time to recover reacquisition and identification gear

S_SeaFox_PID: Surface flag indicating percentage of SeaFox's using ID rounds

S_SortieTime_hr: Surface max sortie time

S_SrchSpeed_kt: Surface search speed

S_SStreamT_hr: Surface time to stream search gear

S_TransitSpd_kt: Surface transit speed from staging area to minefield

S_TurnTime_s: Surface time to turn at the end of a track

SearchSplitYpc: Minefield split between surface and airborne for legacy parallel search

The top five factors for each configuration, including transformations, are summarized in Table 34. Again, the interactions shown are significant at the $\alpha = 0.01$ level for ACRS.

Table 34. Top Five Significant Model Factors

Model Configuration	Influential Factors for		
	ACRS	Log(ACRS)	$\sqrt{\text{ACRS}}$
Configuration 1A	S_SrchSpeed_kt	S_SrchSpeed_kt	S_SrchSpeed_kt
	S_RRecoverT_hr	S_RRecoverT_hr	S_RRecoverT_hr
	S_RDeployT_hr	S_RDeployT_hr	S_RDeployT_hr
	SearchSplitYpc	SearchSplitYpc	SearchSplitYpc
	A_Pcnn	A_Pcnn	A_Pcnn
Configuration 1B	S_SrchSpeed_kt	S_SrchSpeed_kt	S_SrchSpeed_kt
	S_RRecoverT_hr	S_RRecoverT_hr	S_RRecoverT_hr
	S_RDeployT_hr	S_RDeployT_hr	S_RDeployT_hr
	SearchSplitYpc	SearchSplitYpc	SearchSplitYpc
	A_Pcnn	A_Pcnn	A_Pcnn
Configuration 2A	S_SrchSpeed_kt	S_SrchSpeed_kt	S_SrchSpeed_kt
	SearchSplitYpc	SearchSplitYpc	SearchSplitYpc
	S_RRecoverT_hr	S_RRecoverT_hr	S_RRecoverT_hr
	S_RDeployT_hr	S_RDeployT_hr	S_RDeployT_hr
	A_Pcnn	A_Pcnn	A_Pcnn
Configuration 2B	S_SrchSpeed_kt	S_SrchSpeed_kt	S_SrchSpeed_kt
	SearchSplitYpc	SearchSplitYpc	SearchSplitYpc
	S_RDeployT_hr	S_RDeployT_hr	S_RDeployT_hr
	S_RRecoverT_hr	S_RRecoverT_hr	S_RRecoverT_hr
	NeutSplitYpc	NeutSplitYpc	NeutSplitYpc
Configuration 3	S_SrchSpeed_kt	S_SrchSpeed_kt	S_SrchSpeed_kt
	S_SortieTime_hr	S_SortieTime_hr	S_SortieTime_hr
	S_SRecoverT_hr	S_SStreamT_hr	S_SRecoverT_hr
	S_SStreamT_hr	S_SRecoverT_hr	S_SStreamT_hr
	S_ReplenishT_hr	S_ReplenishT_hr	S_ReplenishT_hr
Configuration 3 (No Outlier)	S_SrchSpeed_kt	S_SrchSpeed_kt	S_SrchSpeed_kt
	S_SortieTime_hr	S_SortieTime_hr	S_SortieTime_hr
	S_SRecoverT_hr	S_SStreamT_hr	S_SRecoverT_hr
	S_SStreamT_hr	S_SRecoverT_hr	S_SRecoverT_hr
	S_ReplenishT_hr	S_ReplenishT_hr	S_ReplenishT_hr

In all cases, the top factors did not change with the transformations. In configuration 3, transformation did change the order of two factors, S_SRecoverT_hr and S_SStreamT_hr (i.e., surface time to recover reacquisition and identification gear and surface time to stream the reacquisition and identification gear, respectively), between third and fourth most significant. Given the minimal amount of impact to the significant factors and the relatively small improvements in residuals, while the transformations are understood to be slightly better statistically the conclusions provided are based off of the untransformed model. The reason for presenting conclusions based on untransformed data is due to the increased utility of reporting ACRS as opposed to the lognormal of ACRS or the square root of ACRS. Factors commonly in the top five included: surface system search speed (S_SrchSpeed_kt), surface time to recover reacquisition and identification gear (S_RRecoverT_hr), surface time to deploy reacquisition and identification gear (S_RDeployT_hr), airborne probability of classifying a non-mine as a non-MILCO (A_Pcnn), and minefield split between surface and airborne for legacy parallel search (SearchSplitYpc).

The model fitting procedure continued the same way for examination of percent clearance. Summaries of the fitting are contained in Table 35. The configurations with the greatest R^2 values are highlighted in yellow, and the configurations with the greatest R^2 -adjusted values are highlighted in green.

Table 35. Percent Clearance Fit Summary Statistics

Percent Clearance Fit Summary		Configuration 1A	Configuration 1B	Configuration 2A	Configuration 2B	Configuration 3
First Fit (no interactions)	# Factors In	27	28	33	34	20
	# Factors (p <0.10)	11	9	12	16	8
	R^2	0.599	0.519	0.452	0.415	0.573
	R^2 -adjusted	0.576	0.491	0.415	0.374	0.555
Second Fit (Two-way interactions)	# Factors In	55	45	78	136	36
	# Factors (p <0.05)	10	11	16	17	10
	R^2	0.615	0.547	0.534	0.555	0.589
	R^2 -adjusted	0.568	0.503	0.450	0.394	0.557
Intermediate Fit	# Factors In	11	11	17	20	10
	# Factors (p <0.05)	9	11	16	14	10

Percent Clearance Fit Summary		Configuration 1A	Configuration 1B	Configuration 2A	Configuration 2B	Configuration 3
	R ²	0.575	0.523	0.465	0.422	0.571
	R ² -adjusted	0.565	0.512	0.447	0.399	0.563
Final Fit (p <0.05)	# Factors In	9	11	17	13	10
	# Factors (p <0.05)	8	11	16	13	10
	R ²	0.569	0.523	0.465	0.396	0.571
	R ² -adjusted	0.561	0.512	0.447	0.380	0.563
Reduced Fit (Factors In have p <0.01)	# Factors In	9	11	12	11	5
	# Factors (p <0.01)	8	11	11	10	5
	R ²	0.569	0.523	0.443	0.382	0.550
	R ² -adjusted	0.561	0.512	0.430	0.369	0.545
Maximum R ²		0.615	0.547	0.534	0.555	0.589
Maximum R ² -adjusted		0.576	0.512	0.450	0.399	0.563

For percent clearance, the R² values are much lower than they were for ACRS, indicating a much poorer fit to the data. R² was as low as 0.38 and only as high as 0.61. R²-adjusted values were no better, ranging from 0.36–0.57. Although various transformations on the data were attempted, none were found to appreciably improve the fit. Unlike ACRS, the residuals for the percent clearance fits were not problematic, which provided no other reason to apply any transformations. It appears that percent clearance may be dependent on much higher-order interactions, for which the statistical DOE would have to be changed and additional data produced from the ExtendSim model. Table 36 contains a list, in order of decreasing statistical significance, of all factors and interactions included in the $\alpha = 0.01$ model for percent clearance.

Table 36. All Factors Included in Percent Clearance Fit Model

Configuration 1A	Configuration 1B	Configuration 2A	Configuration 2B	Configuration 3
S_Pimm	S_Pimm	S_Pimm	S_Pimm	A_Pimm
S_Pn	S_Pn	S_Pn	S_Pn	S_Pd
S_Prmm	S_PrmmI	A_Pd	S_Pd	A_Pn
S_Pd	S_Pd	S_Pd	A_Pcmm	S_Pcmm
A_Pcmm	A_Pd	S_Prmm	S_Pcmm	A_Prmm
A_Pd	S_Prmm	S_Pcmm	A_Pimm	
(A_Pcmm)*(A_Pcnn)	S_Pcmm	A_Pcmm	A_Pd	

Configuration 1A	Configuration 1B	Configuration 2A	Configuration 2B	Configuration 3
(S_Prmm)*(S_Pimm)	S_SeaFox_PID	(S_SSStreamT_hr)*(S_Prmm)	S_Prmm	
A_Pcnn	A_Pcmm	(S_Pd)*(S_Pimm)	(S_Pd)*(S_Pimm)	
	(S_Pd)*(S_PrmmI)	(S_Prmm)*(S_Pimm)	(A_Pd)*(A_Pn)	
	(S_Pimm)*(A_Pd)	S_Pcnn	A_Pn	
		S_SSStreamT_hr		

Legend (For a full list of model parameters, see Tables 17 through 20 in Chapter VI)

A_Pcmm: Airborne probability of classifying a mine as a MILCO

A_Pcnn: Airborne probability of classifying a non-mine as a non-MILCO

A_Pd: Airborne probability of detecting a MILEC

A_Pimm: Airborne probability of identifying a mine as a mine

S_Pcnn: Surface probability of classifying a non-mine as a non-MILCO

S_Pd: Surface probability of detecting a MILEC

S_Pimm: Surface probability of identifying a mine as a mine

S_Pn: Surface probability of neutralizing a mine

S_Prmm: Surface probability of reacquiring a mine as a MILCO

S_PrmmI: Surface probability of reacquiring a mine, previously identified as a mine, as a mine

S_SeaFox_PID: Surface flag indicating percentage of SeaFox's using ID rounds

S_SSStreamT_hr: Surface time to stream search gear

The top five factors for percent clearance in each configuration are summarized in Table 37. As expected, the factors related to sensor and neutralization performance were found to be most significant to the percent clearance MOE.

Table 37. Five Most Influential Factors for Percent Clearance Fit

Model Configuration	Influential Factors for Percent Clearance
Configuration 1A	S_Pimm
	S_Pn
	S_Prmm
	S_Pd
	A_Pcmm
Configuration 1B	S_Pimm
	S_Pn
	S_PrmmI
	S_Pd
	A_Pd

Model Configuration	Influential Factors for Percent Clearance
Configuration 2A	S_Pimm
	S_Pn
	A_Pd
	S_Pd
	S_Prmm
Configuration 2B	S_Pimm
	S_Pn
	S_Pd
	A_Pcmm
	S_Pcmm
Configuration 3	A_Pimm
	S_Pd
	A_Pn
	S_Pcmm
	A_Prmm

D. DESIGN OF EXPERIMENTS AND SENSITIVITY ANALYSIS SUMMARY

Using the information contained within Table 30 and Table 31 as guides, Chapter VIII explores the recommendations for improving future MCM capabilities as compared to legacy MCM capabilities. Specifically, Table 30 shows that while the future capability (configuration 3) performs better than, or as good as, the serial hunt legacy capability for ACRS and percent clearance (configurations 1A and 1B), it does not perform as well as the parallel hunt legacy capability (configurations 2A and 2B) for ACRS. The green highlighted parameters for configuration 3 in Table 31 indicate those parameters that could potentially be modified to improve the future capability.

THIS PAGE INTENTIONALLY LEFT BLANK

VIII. SYSTEM PERFORMANCE ANALYSIS

Having developed the models described in Chapter VI, and the DOE described in Chapter VII, this chapter focuses on the analysis of the data output from the model as a result of executing the DOE. The purpose of this analysis is to gain an understanding of the legacy and future MCM system capabilities. As described in Chapter VII, the evolution of the DOE took into account those factors that were found to be statistically significant for each system configuration to reduce the number of factors used as part of a regression analysis. This process provided a systematic approach to investigate how the numerous input model parameters impacted the model outputs associated with the primary system MOEs: ACRS and percent clearance. Given the large number of input parameters, or factors, it was important to create a DOE to efficiently and effectively explore the input factor ranges. Regression analysis was utilized for each configuration to analyze the sensitivity of the MOEs to the various input factors. This chapter describes which factors were found to be most impactful to the MOEs based on the sensitivity analysis performed as an output of the DOE and provides a foundation for the performance analysis leading to MCM recommendations. The results for each legacy and future MCM configurations are identified as well as potential improvements for the future MCM configuration that could produce performance equal to or better than the legacy MCM configurations.

A. BASELINE CONFIGURATIONS

Using the input parameter ranges identified in Chapter VII, the five configurations were explored based on the 512-point NOAB DOE. As described in Chapter V, four legacy configurations and one future configuration were considered based on SME feedback on relevant system compositions for the scenario under investigation. The outputs (ACRS and percent clearance) for the baseline configurations are shown in Table 38.

Table 38. Model Results for Baseline Configurations

	ACRS			Percent Clearance		
	Mean	95% Confidence Interval		Mean	95% Confidence Interval	
		Lower	Upper		Lower	Upper
Configuration 1A	4.32	4.25	4.39	0.33	0.32	0.34
Configuration 1B	4.28	4.21	4.35	0.31	0.30	0.32
Configuration 2A	5.35	5.25	5.45	0.33	0.32	0.34
Configuration 2B	5.30	5.20	5.40	0.31	0.30	0.32
Configuration 3	4.80	4.71	4.89	0.33	0.32	0.34

1. Baseline Legacy Configuration 1A

Legacy configuration 1A, representing when the MCM 1 uses a SLQ-48 for neutralization and the MH-53E is only used for detection and classification, was analyzed with 512 model runs with 65 input variables. The statistically significant input variables to the ACRS MOE are indicated in Table 39. After 512 runs of the legacy model, the mean ACRS was 4.32 with a 95 percent confidence interval ranging from 4.25–4.39, as shown in Table 38. Effectively, the 1A legacy configuration was able to cover an area of 4.32 NM² in a 24-hour period. Table 39 also shows the normalized magnitude of each factor’s effects on ACRS in order of increasing p-value.

Table 39. Input Parameters Effects on ACRS for Baseline Configuration 1A (MCM 1 and MH-53E Conducting MCM in Series)

Statistically Significant Input Parameters	Model Parameter Definition	Normalized Input Parameter Effect on ACRS	p-Value
Constant	Regression Constant	0.24	0.000
S_SrchSpeed_kt	Surface minehunter search speed	0.04	0.000
S_ReplenishT_hr	Surface minehunter time to replenish	0.00	0.000
S_SortieTime_hr	Surface minehunter maximum sortie time	0.00	0.000
S_RDeployT_hr	Surface minehunter time to deploy RI&N gear	-0.03	0.000
S_RRecoverT_hr	Surface minehunter time to recover RI&N gear	-0.03	0.000
A_Pd	Airborne minehunter probability of detecting a MILEC	-0.11	0.000
A_Pcnn	Airborne minehunter probability of classifying a non-mine a non-MILCO	0.22	0.000
SearchSplitYpc	Percentage of search area covered by the surface minehunter	-0.15	0.000
S_TurnTime_s	Surface minehunter time to turn at the end of a	0.00	0.001

Statistically Significant Input Parameters	Model Parameter Definition	Normalized Input Parameter Effect on ACRS	p-Value
	track		
A_Pcmm	Airborne minehunter probability of classifying a mine as a MILCO	-0.05	0.001
S_SStreamT_hr	Surface minehunter time to stream search gear	0.00	0.011
S_PrnnI	Surface minehunter probability of not reacquiring a non-mine as a mine, given that the non-mine has already been identified as a mine	-0.02	0.011
S_Pcnn	Surface minehunter probability of classifying a non-mine as a non-MILCO	0.03	0.016
A_SRecoverT_hr	Airborne minehunter time to recover search gear	0.02	0.033
S_Pd	Surface minehunter probability of detecting a MILEC	-0.03	0.045
S_Pcmm	Surface minehunter probability of classifying a mine as a MILCO	-0.03	0.047

The statistically significant input variables for configuration 1A to the percent clearance MOE are indicated in Table 40. After 512 runs of the legacy model, the mean percent clearance was 0.33 with a 95 percent confidence interval ranging from 0.32–0.34, as shown in Table 38. Effectively, the 1A legacy configuration was able to clear 33 percent of the mines from the SLOC. Table 40 also shows the normalized magnitude of each variable’s effects on percent clearance, in order of increasing p-value.

Table 40. Input Parameters Effects on Percent Clearance for Baseline Configuration 1A (MCM 1 and MH-53E Conducting MCM in Series)

Statistically Significant Input Parameters	Model Parameter Definition	Normalized Input Parameter Effect on Percent Clearance	p-Value
Constant	Regression constant	-0.38	0.000
S_Pd	Surface minehunter probability of detecting a MILEC	0.06	0.000
S_Pcmm	Surface minehunter probability of classifying a mine as a MILCO	0.05	0.000
S_Prmm	Surface minehunter probability of reacquiring a mine as a MILCO	0.15	0.000
S_Pimm	Surface minehunter probability of identifying a mine as a mine	0.10	0.000
S_Pn	Surface minehunter probability of neutralizing a mine	0.11	0.000
A_Pd	Airborne minehunter probability of detecting a MILEC	0.05	0.000
A_Pcmm	Airborne minehunter probability of classifying	0.06	0.000

Statistically Significant Input Parameters	Model Parameter Definition	Normalized Input Parameter Effect on Percent Clearance	p-Value
	a mine as a MILCO		
S_Pcnn	Surface minehunter probability of classifying a non-mine as a non-MILCO	-0.02	0.015
SearchSplitYpc	Percentage of search area covered by the surface minehunter	0.01	0.039

2. Baseline Legacy Configuration 1B

Legacy configuration 1B, representing when the MCM 1 uses a SeaFox for neutralization and the MH-53E is only used for detection and classification, was analyzed with 512 model runs with 65 input variables. The statistically significant input variables to the ACRS MOE as well as the normalized magnitude variable's effects on ACRS are indicated in Table 41. After the 512 runs of the legacy model, the mean ACRS was a 4.28 with a 95 percent confidence interval ranging from 4.21–4.35, as shown in Table 38. Compared to configuration 1A, configuration 1B was slightly less effective at covering a SLOC. This is primarily due to the fact that the SeaFox can utilize both an exploratory and neutralizing round, which institutes a delay due to the additional reacquisition step.

Table 41. Input Parameters Effects on ACRS for Baseline Configuration 1B (MCM1 and MH-53E Conducting MCM in Series)

Statistically Significant Input Parameters	Model Parameter Definition	Normalized Input Parameter Effect on ACRS	p-Value
Constant	Regression constant	0.29	0.000
S_SrchSpeed_kt	Surface minehunter search speed	0.04	0.000
S_ReplenishT_hr	Surface minehunter time to replenish	0.00	0.000
S_SortieTime_hr	Surface minehunter maximum sortie time	0.00	0.000
S_RDeployT_hr	Surface minehunter time to deploy RI&N gear	-0.03	0.000
S_SRecoverT_hr	Surface minehunter time to recover search gear	-0.03	0.000
A_Pd	Airborne minehunter probability of detecting a MILEC	-0.13	0.000
A_Pcnn	Airborne minehunter probability of classifying a non-mine a non-MILCO	0.22	0.000
SearchSplitYpc	Percentage of search area covered by the surface minehunter	-0.15	0.000
S_SSStreamT_hr	Surface minehunter time to stream search gear	0.00	0.008
A_Pcmm	Airborne minehunter probability of classifying a mine as a MILCO	-0.04	0.006
S_TurnTime_s	Surface minehunter time to turn at the end of a track	0.00	0.015

Statistically Significant Input Parameters	Model Parameter Definition	Normalized Input Parameter Effect on ACRS	p-Value
S_PrnnI	Surface minehunter probability of not reacquiring a non-mine as a mine, given that the non-mine has already been identified as a mine	-0.01	0.030
S_Pd	Surface minehunter probability of detecting MILEC	-0.03	0.032
A_SRecoverT_hr	Airborne minehunter time to recover search gear	0.02	0.050

The statistically significant input variables for configuration 1B to the percent clearance MOE as well as the normalized magnitude of each variable's effects on percent clearance in order of increasing p-value are indicated in Table 42. After 512 runs of the legacy model, the mean percent clearance was 0.31 with a 95 percent confidence interval ranging from 0.30–0.32, as shown in Table 38. Configuration 1B was slightly less effective at clearing a SLOC given the reacquisition step needed as part of going from a Sea-Fox exploratory round to a neutralization round. There is a chance the neutralization round would not be able to reacquire a mine and therefore there is a reduction in the overall percent clearance.

Table 42. Input Parameters Effects on Percent Clearance for Baseline Configuration 1B (MCM 1 and MH-53E Conducting MCM in Series)

Statistically Significant Input Parameters	Model Parameter Definition	Normalized Input Parameter Effect on Percent Clearance	p-Value
Constant	Regression constant	-0.39	0.000
S_Pd	Surface minehunter probability of detecting a MILEC	0.06	0.000
S_Pcmm	Surface minehunter probability of classifying a mine as a MILCO	0.05	0.000
S_Prmm	Surface minehunter probability of reacquiring a mine as a MILCO	0.12	0.000
S_Pimm	Surface minehunter probability of identifying a mine as a mine	0.10	0.000
S_Pn	Surface minehunter probability of neutralizing a mine	0.10	0.000
S_SeaFox_PID	Surface minehunter probability of using a SeaFox identification round	-0.02	0.000
S_PrmmI	Surface minehunter probability of reacquiring a mine as a mine, given that the mine has already been identified as a mine	0.04	0.000
A_Pd	Airborne minehnter probability of detecting a MILEC	0.06	0.000

Statistically Significant Input Parameters	Model Parameter Definition	Normalized Input Parameter Effect on Percent Clearance	p-Value
A_Pcmm	Airborne minehunter probability of classifying a mine as a MILCO	0.05	0.000

3. Baseline Legacy Configuration 2A

Legacy configuration 2A, representing when the MCM 1 uses a SLQ-48 for neutralization and the MH-53E uses a SeaFox in parallel, was analyzed with 512 model runs with 65 input variables. The statistically significant input variables to the ACRS MOE as well as the normalized magnitude of each variable's effects on ACRS are indicated in Table 43. After 512 runs of the legacy model, the mean ACRS was 5.35 with a 95 percent confidence interval ranging from 5.25–5.45, as shown in Table 38. Compared to configurations 1A and 1B, configuration 2A was significantly more effective at covering a SLOC. This is primarily due to the fact that the MH-53E shares the neutralization load with the MCM 1.

Table 43. Input Parameters Effects on ACRS for Baseline Configuration 2A (MCM 1 and MH-53E Conducting MCM in Parallel)

Statistically Significant Input Parameters	Model Parameter Definition	Normalized Input Parameter Effect on ACRS	p-Value
Constant	Regression constant	0.28	0.000
S_SrchSpeed_kt	Surface minehunter search speed	0.05	0.000
S_ReplenishT_hr	Surface minehunter time to replenish	0.00	0.000
S_SortieTime_hr	Surface minehunter maximum sortie time	0.00	0.000
S_Pcnn	Surface minehunter probability of classifying a non-mine as a non-MILCO	0.05	0.000
S_RDeployT_hr	Surface minehunter time to deploy reacquisition, identification, and reacquisition gear	-0.02	0.000
S_SRecoverT_hr	Surface minehunter time to recover search gear	-0.02	0.000
A_Pd	Airborne minehunter probability of detecting a MILEC	-0.09	0.000
A_Pcnn	Airborne minehunter probability of classifying a non-mine a non-MILCO	0.12	0.000
SearchSplitYpc	Percentage of search area covered by the surface minehunter	-0.29	0.000
NeutSplitYpc	Percentage of search area covered by the surface minehunter during reacquisition, identification and neutralization operations in the uncleared portion of search area	-0.10	0.000
S_TurnTime_s	Surface minehunter time to turn at the end of a track	0.00	0.039

Statistically Significant Input Parameters	Model Parameter Definition	Normalized Input Parameter Effect on ACRS	p-Value
A_TransitSpd_kt	Airborne minehunter transit speed between staging area and search area	0.00	0.045

The statistically significant input variables for configuration 2A to the percent clearance MOE, as well as the normalized magnitude of each variable’s effect on percent clearance in order of increasing p-value, are indicated in Table 44. After 512 runs of the legacy model, the mean percent clearance was 0.33 with a 95 percent confidence interval ranging from 0.32–0.34, as shown in Table 38. It appears the parallel hunting does not impact the percent clearance given the values between configurations 1A and 2A are nearly identical.

Table 44. Input Parameters Effects on Percent Clearance for Baseline Configuration 2A (MCM 1 and MH-53E Conducting MCM in Parallel)

Statistically Significant Input Variables	Model Variable Definition	Normalized Input Variable Effect on Percent Clearance	p-Value
Constant	Regression constant	-0.40	0.000
S_Pd	Surface probability of detecting a MILEC	0.06	0.000
S_Pcmm	Surface probability of classifying a mine as a MILCO	0.06	0.000
S_Pimm	Surface probability of identifying a mine as a mine	0.10	0.000
S_Pn	Surface probability of neutralizing a mine	0.11	0.000
A_Pd	Airborne probability of detecting a MILEC	0.07	0.000
A_Pcmm	Airborne probability of classifying a mine as a MILCO	0.05	0.000
A_Pimm	Airborne probability of identifying a mine as a mine	0.03	0.000
S_Prmm	Surface probability of reacquiring a mine as a MILCO	0.07	0.002
A_Pn	Airborne probability of neutralizing a mine	0.03	0.005

4. Baseline Legacy Configuration 2B

Legacy configuration 2B, representing when both the MCM 1 and MH-53E use SeaFox neutralizers, was analyzed with 512 model runs with 65 input variables. The statistically significant input variables to the ACRS MOE, as well as the normalized magni-

tude of each variable's effects on ACRS, are indicated in Table 45. After 512 runs of the legacy model, the mean ACRS was 5.30 with a 95 percent confidence interval ranging from 5.20–5.40, as shown in Table 38. Compared to configuration 2A, configuration 2B was slightly less effective at covering a SLOC for the same reason that configuration 1B was less effective than configuration 1A; that is, going from a SeaFox exploratory round to a neutralization round takes time and therefore decreases the rate of coverage.

Table 45. Input Parameters Effects on ACRS for Baseline Configuration 2B
(MCM 1 and MH-53E Conducting MCM in Parallel)

Statistically Significant Input Parameters	Model Parameter Definition	Normalized Input Parameter Effect on ACRS	p-Value
Constant	Regression constant	0.25	0.000
S_SrchSpeed_kt	Surface minehunter search speed	0.04	0.000
S_ReplenishT_hr	Surface minehunter time to replenish	0.00	0.000
S_SortieTime_hr	Surface minehunter maximum sortie time	0.00	0.000
S_Pcnn	Surface minehunter probability of classifying a non-mine as a non-MILCO	0.04	0.000
S_SeaFox_PID	Surface minehunter probability of using a SeaFox identification round	-0.02	
S_RDployT_hr	Surface minehunter time to deploy reacquisition, identification, and reacquisition gear	-0.02	0.000
S_SRecoverT_hr	Surface minehunter time to recover search gear	-0.02	0.000
A_Pd	Airborne minehunter probability of detecting a MILEC	-0.06	0.000
A_Pcnn	Airborne minehunter probability of classifying a non-mine a non-MILCO	0.13	0.000
SearchSplitYpc	Percentage of search area covered by the surface minehunter	-0.26	0.000
NeutSplitYpc	Percentage of search area covered by the surface minehunter during reacquisition, identification and neutralization operations in the uncleared portion of search area	-0.10	0.000
S_PrnnI	Surface minehunter probability of not reacquiring a non-mine as a mine, given that the non-mine has already been identified as a mine	-0.01	0.028
S_Pd	Surface minehunter probability of detecting a MILEC	-0.02	0.033
A_Pcmm	Surface minehunter probability of classifying a mine as a MILCO	-0.02	0.033
S_TurnTime_s	Surface minehunter time to turn at the end of a track	0.00	0.039
S_SStreamT_hr	Surface minehunter time to stream search gear	0.00	0.043

The statistically significant input variables for configuration 2B to the percent clearance MOE, as well as the normalized magnitude of each variable's effect on percent clearance in order of increasing p-value, are indicated in Table 46. After 512 runs of the legacy model, the mean percent clearance was 0.31 with 95 percent confidence interval ranging from 0.30–0.32, as shown in Table 38. It appears the parallel hunting does not impact the percent clearance given the values between configurations 1B and 2B are nearly identical.

Table 46. Input Parameters Effects on Percent Clearance for Baseline Configuration 2B (MCM 1 and MH-53E Conducting MCM in Parallel)

Statistically Significant Input Parameters	Model Parameter Definition	Normalized Input Parameter Effect on Percent Clearance	p-Value
Constant	Regression constant	-0.36	0.000
S_Pd	Surface minehunter probability of detecting a MILEC	0.09	0.000
S_Pcmm	Surface minehunter probability of classifying a mine as a MILCO	0.06	0.000
S_Prmm	Surface minehunter probability of reacquiring a mine as a MILCO	0.09	0.000
S_Pimm	Surface minehunter probability of identifying a mine as a mine	0.09	0.000
S_Pn	Surface minehunter probability of neutralizing a mine	0.08	0.000
A_Pd	Airborne minehunter probability of detecting a MILEC	0.05	0.000
A_Pcmm	Airborne minehunter probability of classifying a mine as a MILCO	0.07	0.000
A_Pimm	Airborne minehunter probability of identifying a mine as a mine	0.03	0.000
A_SRecoverT_hr	Airborne minehunter time to recover search gear	-0.02	0.008
A_Pn	Airborne minehunter probability of neutralizing a mine	0.03	0.017
A_RDeployT_hr	Airborne minehunter time to deploy reacquisition, identification, and reacquisition gear	-0.02	0.018
S_SeaFox_PID	Surface minehunter probability of using a Sea-Fox identification round	-0.01	0.022

5. Baseline Future Configuration 3

Future configuration 3, representing when the LCS/RMS performs the detection and classification while the MH-60S performs the neutralization, was analyzed with 512 model runs with 65 input variables. The statistically significant input variables to the ACRS MOE, as well as the normalized magnitude of each variable's effect on ACRS, are indicated in Table 47. After 512 runs of the future model, the mean ACRS was 4.80 with a 95 percent confidence interval ranging from 4.71–4.89, as shown in Table 38. This ACRS is better than the legacy serial configurations, but not as good as the legacy parallel configurations.

Table 47. Input Parameters Effects on ACRS for Baseline Configuration 3 (LCS and MH-60S Conducting MCM in Series)

Statistically Significant Input Parameters	Model Parameter Definition	Normalized Input Parameter Effect on ACRS	p-Value
S_SrchSpeed_kt	Surface minehunter search speed	0.13	0.000
S_TurnTime_s	Surface minehunter time to turn at the end of a track	0.00	0.000
S_TransitSpd_kt	Surface minehunter transit speed between staging area and minefield	0.00	0.000
S_SStreamT_hr	Surface minehunter time to stream search gear	-0.10	0.000
S_SRecoverT_hr	Surface minehunter time to recover search gear	-0.10	0.000
S_ReplenishT_hr	Surface minehunter time to replenish	-0.06	0.000
S_SortieTime_hr	Surface minehunter maximum sortie time	0.04	0.000
S_Pcnn	Surface minehunter probability of classifying a non-mine as a non-MILCO	0.28	0.000
A_RDeployT_hr	Airborne minehunter time to deploy reacquisition, identification, and reacquisition gear	-0.14	0.001
A_TransitSpd_kt	Airborne minehunter transit speed between staging area and search area	0.00	0.012
A_Pimm	Airborne minehunter probability of identifying a mine as a mine	-0.07	0.035

The statistically significant input variables for configuration 3 to the percent clearance MOE, as well as the normalized magnitude of each variable’s effects on percent clearance in order of increasing p-value, are indicated in Table 48. After 512 runs of the future model, the mean percent clearance was 0.33 with a 95 percent confidence interval ranging from 0.32–0.34, as shown in Table 38. Given that the legacy and future systems have the same performance ranges for the sensors, it is not surprising that the future percent clearance performance is similar to the legacy systems’ performance.

Table 48. Inputs Parameters Effects on Percent Clearance for Baseline Configuration 3 (LCS and MH-60S Conducting MCM in Series)

Statistically Significant Input Variables	Model Variable Definition	Normalized Input Variable Effect on Percent Clearance	p-Value
Constant	Regression constant	-0.37	0.000
S_Pd	Surface minehunter probability of detecting a MILEC	0.12	0.000
S_Pcmm	Surface minehunter probability of classifying a mine as a MILCO	0.11	0.000

Statistically Significant Input Variables	Model Variable Definition	Normalized Input Variable Effect on Percent Clearance	p-Value
A_Prmm	Airborne minehunter probability of reacquiring a mine as a MILCO	0.14	0.000
A_Pn	Airborne minehunter probability of neutralizing a mine	0.11	0.000
A_Pimm	Airborne minehunter probability of identifying a mine as a mine	0.11	0.000
A_TransitSpd_kt	Airborne minehunter transit speed between staging area and search area	0.00	0.014
S_SStreamT_hr	Surface minehunter time to stream search gear	0.00	0.023
S_SRecoverT_hr	Surface minehunter time to recover search gear	0.00	0.041

B. COMPARISON OF LEGACY AND FUTURE SYSTEMS

Table 38 provides a basis of comparing the five different configurations in terms of their MOE values. Figure 68 provides a graphical representation of how each configuration performs as compared to the other configurations.

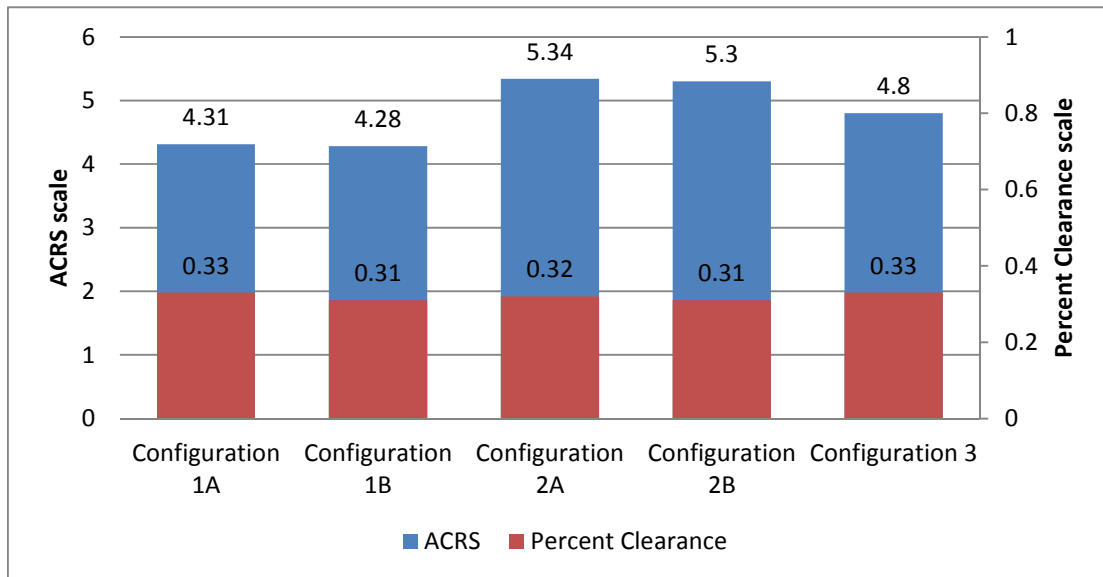

Figure 68. Baseline Configuration Performance

As can be seen in Figure 68, the percent clearance for each system configuration is very close and the baseline future system percent clearance does exceed the percent clearance value for the best performing legacy configuration (1A). With respect to ACRS, the future LCS shows a deficit of 0.54 NM² as compared to the best legacy MCM

configuration (2A). While this ACRS difference is not statistically significant (the difference is within two standard deviations), one goal was to recommend ways in which the future LCS MCM configuration can meet or exceed the best legacy MCM configuration. As part of investigating ways in which LCS ACRS performance could be improved, the significant parameters were considered, as well as their input ranges.

C. FUTURE LCS CONFIGURATION 3 IMPROVEMENTS

Based on the analysis performed as part of developing the DOE, the input variables that have a significant effect on the future LCS MCM system MOEs of ACRS and percent clearance were identified. For the LCS configuration, Table 49 indicates which factors have the greatest effect on ACRS and percent clearance.

Table 49. Descriptions of Key LCS Input Parameters Affecting the MOEs of ACRS and Percent Clearance

LCS Input Variables Sensitive to ACRS	LCS Factors Effecting ACRS	LCS Input Variables Sensitive to PC	LCS Factors Effecting PC
S_SrchSpeed_kt	Surface search speed	S_Pd	Surface minehunter probability of detecting a MILEC
S_TurnTime_s	Surface time to turn at the end of track	S_Pcmm	Surface minehunter probability of classifying a mine as a MILCO
S_TransitSpd_kt	Surface transit speed from staging area to minefield	A_Prmm	Airborne minehunter probability of reacquiring a mine as a MILCO
S_SStreamT_hr	Surface time to stream search gear	A_Pn	Airborne minehunter probability of neutralizing a mine
S_SRecoverT_hr	Surface time to recover reacquisition and identification gear	A_Pimm	Airborne minehunter probability of identifying a mine as a mine
S_ReplenishT_hr	Surface time to replenish	A_TransitSpd_kt	Airborne minehunter transit speed between staging area and search area
S_SortieTime_hr	Surface max sortie time	S_SStreamT_hr	Surface minehunter time to stream search gear
S_Pcnn	Surface probability of classifying a non-mine as a non-mine	S_SRecoverT_hr	Surface minehunter time to recover search gear
A_RDeployT_hr	Airborne time to deploy reacquisition and identification gear	A_ReplenishT_hr	Airborne minehunter time to replenish
A_TransitSpd_kt	Airborne transit speed from staging area to minefield	S_TransitSpdT_hr	Surface minehunter transit speed between staging area and search area
A_Pimm	Airborne probability of identifying a mine as a mine	S_Pcnn	Surface minehunter probability of classifying a non-mine as a non-MILCO

Once the key input variables were identified, the model was executed with adjusted values to evaluate the effects of these improved variables on the MOEs for the LCS model. Table 50 shows the experiments investigated as part of improving significant future parameters to achieve ACRS performance similar to that achieved by legacy configuration 2A. For the most part, only one or two parameters were changed while all other input parameters varied as they had in the baseline configuration results.

Table 50. Experiment Adjustments Made to the LCS Configuration 3 Model to Gauge Effects on the ACRS and Percent Clearance MOEs

Experiment	Adjustment
1	Set “A_Pimm” (Airborne minehunter probability of identifying a mine as a mine) to 0.9%, and set all other input variables to their baseline values.
2	Set “S_SStreamT_hr” (Surface minehunter time to stream search gear), and “S_SRecoverT_hr” (Surface minehunter time to recover search gear) to 0.25 hours and “A_Pimm” (Airborne minehunter probability of identifying a mine as a mine) to 0.9%, and all other factors set to their baseline values.
3	Set “S_SrchSpeed_kt” (Surface minehunter search speed) to 10 knots, and all other factors set to baseline values.
4	Set “S_SrchSpeed_kt” (Surface minehunter search speed) to 8 knots, and all other factors set to baseline values.
5	Set “A_TransitSpd_kt” (Airborne minehunter transit speed between staging area and search area) to 150-180 knots, all other factors set to baseline values.
6	Set “S_TransitSpd_kt” (Surface minehunter transit speed between staging area and search area) to 50 knots, set all other factors to baseline values.
7	Set “S_SortieTime_hr” (Surface minehunter maximum sortie time) to 24 hours, set all other factors to baseline values.
8	Set “S_SStreamT_hr” and “S_SrecoverT_hr” to 0.25 hours, and set all other factors to baseline values.
9	Set all sensor probabilities to 0.95 and set all other factors to baseline values.

The model outputs based on the experiment parameter changes show that the LCS system MOEs can be affected, in a positive way, by modifying the statistically significant input variables, as shown in Table 51. The experiments are listed in separate rows, identified by the number shown in Table 50. Each experiment row has a separate row for each MOE (ACRS and percent clearance) and listed across the tables are the summary statistics of that experiment for each particular MOE.

Table 51. Results of Experiments Conducted on LCS Model

Experiment	MOE	Average	Standard Deviation	Minimum	Maximum	Variance	Standard Error	95% Confidence Interval		Percent Change (from DOE 2 Results)
								Upper Bound	Lower Bound	
Configuration 3 Baseline	ACRS	4.782	1.04	-	-	1.08	0.05	4.86	4.71	0.00%
	Percent Clearance	0.323	0.07	-	-	0.01	0.00	0.33	0.32	0.00%
Experiment 1	ACRS	4.789	1.05	2.02	7.24	1.09	0.05	4.87	4.72	0.30%
	Percent Clearance	0.350	0.07	0.18	0.57	0.00	0.00	5.62	5.47	8.17%
Experiment 2	ACRS	5.545	0.97	3.50	7.98	0.95	0.04	5.62	5.47	15.97%
	Percent Clearance	0.342	0.06	0.17	0.52	0.00	0.00	0.35	0.34	5.69%
Experiment 3	ACRS	6.086	0.74	3.77	7.78	0.55	0.03	6.14	6.03	27.28%
	Percent Clearance	0.325	0.07	0.15	0.56	0.00	0.00	0.33	0.32	0.57%
Experiment 4	ACRS	5.124	0.65	3.51	6.54	0.42	0.03	5.17	5.08	7.16%
	Percent Clearance	0.327	0.07	0.16	0.51	0.00	0.00	0.33	0.32	1.18%
Experiment 5	ACRS	4.827	1.07	1.99	7.27	1.13	0.05	4.90	4.75	0.94%
	Percent Clearance	0.328	0.07	0.09	0.59	0.01	0.00	0.33	0.32	1.39%
Experiment 6	ACRS	4.947	1.03	2.14	7.48	1.07	0.05	5.02	4.87	3.46%
	Percent Clearance	0.324	0.07	0.17	0.55	1.01	0.00	0.33	0.32	0.07%
Experiment 7	ACRS	5.537	0.87	3.70	7.75	0.76	0.04	5.60	5.47	15.78%
	Percent Clearance	0.328	0.07	0.15	0.53	0.01	0.00	0.33	0.32	1.44%
Experiment 8	ACRS	5.530	0.96	3.48	7.76	0.93	0.04	5.60	5.46	15.65%
	Percent Clearance	0.326	0.07	0.13	0.59	0.01	0.00	0.33	0.32	0.89%
Experiment 9	ACRS	4.850	1.08	2.00	7.14	1.17	0.05	4.93	4.77	1.44%
	Percent Clearance	0.513	0.06	0.34	0.7	0.00	0.00	0.52	0.51	58.69%

The results shown in Table 51 indicate that different levels of effects can be produced, depending on the experiment that was run on the LCS model. These differences in effect on the MOEs range from a very small percent increase to significant changes in MOE outputs; because the goal was to focus on increasing the performance of the LCS system, the MIW Team focused on the experiments that positively affected ACRS and percent clearance the most.

The ACRS MOE is very sensitive to LCS characteristics tied to ship mine search speed, as the experiment that increased surface search speed to 10 knots indicated a 27.28 percent increase in ACRS. ACRS is also sensitive to time required to stream and recover the RMS as a decrease in the time to stream and recover gear increased ACRS by 15.69 percent. ACRS is also sensitive to the amount of time the RMS is able to perform its mission, or S_SortieTime, before requiring replenishment. Only one RMS was modeled during the project MBSE, based on SME feedback that “two RMS may be used in shifts for each LCS,” (Brett Cordes, personal communication, 25 September 2014). In simulating the use of RMS in shifts from the LCS, by increasing the RMS sortie time up to 24 hours improved ACRS by 15.78 percent.

With respect to increasing percent clearance for the LCS, the experiment that had the greatest effect showed that improvements to the sensors associated with detection, classification, reacquisition, and identification that increased probabilities to 0.95 resulted in an increase in percent clearance by 58.69 percent.

D. ANALYSIS CONCLUSIONS

According to the modeling, allowing the RMS to operate at its maximum surface search speed of 10 knots, reducing the RMS stream and recover time to 15 minutes, and improving the RMS sortie time to 24 hours all improved the future ACRS by over 15 percent. A 58 percent increase in percent clearance was obtained by setting all of the sensor probabilities to 0.95. These modifications were examined due to their statistical significance to the MOEs as defined in Chapter VII. Since these modifications improved the performance of the LCS MCM systems (with respect to ACRS and percent clearance) to a level comparable to or better than the legacy performance, these are recommended for

further analysis. The risks and costs associated with the operation of the legacy and future MCM systems were evaluated and are described in Chapter IX.

IX. COST AND RISK ANALYSIS

A comprehensive comparison of legacy and future MIW systems must consider cost and risk; a performance comparison alone does not identify the more cost effective option, nor does a performance comparison necessarily identify conditions that could potentially degrade or prevent system performance. A combination of performance, cost, and risk analyses is required to fully inform decision makers of how legacy MIW systems compare to future MIW systems. The overall performance of each MIW system is not just based on raw performance, as represented by resulting MOE performance, but is also based on raw performance with respect to cost. From an acquisition perspective, the concept of evaluating a system based on performance and cost can be referred to as a best value analysis. This chapter describes performance with respect to cost and risk analyses performed by the MIW Team.

A. COST ANALYSIS

The Defense Acquisition Guidebook (DAG) describes four categories of life-cycle costs (DAG Chapter 3, Section 3.1.3):

- **Research and Development (R&D) Costs.** R&D costs include costs associated with trade studies, technology development, design, fabrication, integration, and testing.
- **Investment Costs.** Investment costs include costs associated with production and deployment.
- **Operating and Support (O&S) Costs.** O&S costs include costs associated with operating, maintaining, and supporting a fielded system.
- **Mission cost associated with unit mission hourly cost and expenditure cost, associated with per unit baseline and task force size units.**

The MIW cost analysis was scoped to include only O&S costs. Other life-cycle cost categories were excluded due to manpower and time constraints. O&S cost information was obtained from the Navy Visibility and Management of Operating and Support Costs (VAMOSC) management information system as well as SME feedback. VAMOSC collects and reports historical O&S costs for US Navy and Marine Corps weapon systems. VAMOSC cost information is available by request to US government personnel

and DOD contractors in support of providing cost analysis relate services. Cost information not available from VAMOSOC, namely neutralizer costs, were estimated based upon feedback from SMEs who are technical leaders directly involved with the MIW community.

1. Cost Analysis Methodology

The MIW Team considered two approaches for comparing the cost of legacy and future MIW systems. The first approach was to compare annual O&S costs. The MCM 1 ships used for the legacy MIW system are dedicated to conducting MIW missions. Therefore, the annual O&S cost of the MCM 1 should accurately represent the annual cost of conducting MIW missions. This is not the case for the future MIW systems because the LCS ships may be used for non-MIW missions when there are no MIW missions required. For this reason, the annual O&S cost of the LCS may not accurately represent the annual cost of conducting MIW missions especially during periods requiring a low number of MIW missions.

The second approach was to compare the hourly O&S costs incurred while conducting the common mission scenario profile. This approach was selected for the cost analysis because it is a natural way to link the cost estimation with the M&S results described in Chapters VII and VIII. That is, the ACRS MOE is deterministic based on the total mission time, in hours, from the model output. In addition, the model outputs also included the number of surface and aerial neutralizers used as well as the total number of flight hours. The MIW Team deemed hourly O&S cost to be a more accurate representation of the cost of MIW because it takes into account the fact that better performance leads to less operating hours.

2. Hourly O&S Cost Estimates for MIW Systems

The naval cost database, VAMOSOC, provided O&S costs for the legacy MCM 1, MH-53E, and LHD as well as the future LCS and MH-60S. The two variants of LCS, the Freedom and Independence class, have different O&S costs but are both expected to support MIW mission modules. Note that the O&S costs associated with the LSDs that support the EOD divers were not considered given the modeled operational scenario only

considers clearing bottom mines in an environment already clear of surface and near-surface mines. The MIW Team estimated hourly O&S costs by dividing the VAMOSC annual O&S costs by 8,760, the number of hours in a year. Moreover, some helicopter manpower and operational and intermediate maintenance costs were associated with flight hours. VAMOSC provided annual O&S costs for available years in constant fiscal year 2015 (FY15) dollars.

VAMOSC O&S costs do not remain constant from year to year. The MIW Team considered creating probabilistic cost models to reflect this year-to-year variation; however, this approach was not used because VAMOSC provides too few data points for most platforms. Although it would have been preferable to use hourly cost distributions to derive the cost estimates described within this report, the MIW Team lacked sufficient information and time to develop reasonable distributional data. Therefore, the analysis used hourly O&S costs that were estimated by averaging the VAMOSC O&S costs over the range for which the corresponding data was available. Tables 52–59 show the estimated average cost per hour or flight hour for the future and legacy capabilities. Each table lists costs in four categories: manpower, maintenance, energy, and other. The manpower category contains costs associated paying personnel to operate the system. The energy category contains costs associated with the fuel and energy needed to maintain and operate the system. The maintenance category contains costs associated with the maintenance of the system, including personnel, parts, and facilities. The other category contains costs associated with training and continued product improvements.

Table 52. O&S Cost Information for the MCM 1

Cost Category	MCM 1 Annual O&S Cost ¹ (2004-2013, CY15M\$)			Estimated Average Hourly Cost ² (CY15\$)
	Minimum	Average	Maximum	
Manpower	6.85	7.37	7.84	841
Energy	0.21	0.30	0.49	34
Maintenance	4.21	5.54	8.90	632
Other	0.91	1.62	2.24	185
Total ³	12.17	14.82	19.48	1,692

1 Based on VAMOSC sample size of 10 years.

2 Average annual cost divided by 8,760 hours per year.

3 Total of minimum, average, and maximum years for each cost category. Not an actual annual cost.

Table 53. O&S Cost Information for the LHD 1

Cost Category	LHD 1 Annual O&S Cost ¹ (2004-2013, CY15M\$)			Estimated Average Hourly Cost ² (CY15\$)
	Minimum	Average	Maximum	
Manpower	80.05	88.65	92.91	10,120
Energy	16.83	23.13	27.51	2,641
Maintenance	17.19	31.69	46.26	3,618
Other	10.80	17.96	28.82	2,050
Total ³	124.87	161.43	195.50	18,428

1 Based on VAMOSC sample size of 10 years.

2 Average annual cost divided by 8,760 hours per year.

3 Total of minimum, average, and maximum years for each cost category. Not an actual annual cost.

Table 54. O&S Cost Information for the LCS 1 (Freedom Class)

Cost Category	LCS 1 Annual O&S Cost ¹ (2010-2013, CY15M\$)			Estimated Average Hourly Cost ² (CY15\$)
	Minimum	Average	Maximum	
Manpower	8.04	9.52	10.13	1,087
Energy	1.38	4.70	9.07	536
Maintenance	8.43	15.95	20.02	1,821
Other	1.57	1.87	2.26	214
Total ³	19.42	32.04	41.49	3,657

¹ Based on VAMOSC sample size of 4 years.

² Average annual cost divided by 8,760 hours per year.

³ Total of minimum, average, and maximum years for each cost category. Not an actual annual cost.

Table 55. O&S Cost information for the LCS 2 (Independence Class)

Cost Category	LCS 2 Annual O&S Cost ¹ (2011-2013, CY15M\$)			Estimated Average Hourly Cost ² (CY15\$)
	Minimum	Average	Maximum	
Manpower	9.55	9.68	9.91	1,104
Energy	2.00	2.43	2.91	277
Maintenance	4.39	10.30	16.76	1,175
Other	1.07	1.35	1.64	155
Total ³	17.00	23.75	31.21	2,711

¹ Based on VAMOSC sample size of 3 years.

² Average annual cost divided by 8,760 hours per year.

³ Total of minimum, average, and maximum years for each cost category. Not an actual annual cost.

Given some of the O&S costs for the helicopters are associated with flight hours, several cost categories were broken out to reflect an average cost based on flight hours as opposed to annual hours. Specifically, the maintenance manpower, organizational and intermediate maintenance, and fuel costs were found by dividing the associated costs by flight hours as opposed to annual hours. Depot maintenance costs were still attributed to annual hours. Organizational maintenance is categorized as maintenance able to be performed in the field during operations. Intermediate maintenance is categorized as mainte-

nance performed by trained technicians in the field, but not during operations. Depot maintenance is categorized as maintenance only performed out of the field. Manpower costs were also split between those associated with maintenance based on flight hours and those associated with operations based on annual hours.

Table 56. O&S Cost Information for the MH-53E (per flight hour)

Cost Category	MH-53 E Annual O&S Cost ¹ (2010-2013, CY15M\$)			Estimated Average Flight Cost/Hour ² (CY15\$)
	Minimum	Average	Maximum	
Manpower— Maintenance	1.68	1.91	2.08	8,598
Energy	0.41	0.49	0.56	2,211
Maintenance— Organizational	2.96	3.10	3.26	13,921
Maintenance— Intermediate	0.01	0.07	0.18	299
Total³	5.06	5.57	6.08	25,029

1 Based on VAMOSC sample size of 4 years.

2 Average annual cost divided by flight hours per year.

3 Total of minimum, average, and maximum years for each cost category. Not an actual annual cost.

Table 57. O&S Cost Information for the MH-53E (based on annual hours)

Cost Category	MH-53 E Annual O&S Cost ¹ (2010-2013, CY15M\$)			Estimated Average Non-Flight Cost/Hour ² (CY15\$)
	Minimum	Average	Maximum	
Manpower— Operations	0.96	1.05	1.13	120
Manpower— Other	0.56	0.60	0.67	69
Maintenance— Depot	0.68	0.88	1.26	100
Other	0.96	1.33	1.69	152
Total³	3.15	3.86	4.75	440

1 Based on VAMOSC sample size of 4 years.

2 Average annual cost divided by 8,760 hours per year.

3 Total of minimum, average, and maximum years for each cost category. Not an actual annual cost.

Table 58. O&S Cost Information for MH-60S (per flight hour)

Cost Category	MH-60 S Annual O&S Cost ¹ (2010-2013, CY15M\$)			Estimated Average Flight Cost/Hour ² (CY15\$)
	Minimum	Average	Maximum	
Manpower- Maintenance	1.03	1.08	1.14	3,134
Energy	0.17	0.18	0.19	526
Maintenance- Organizational	0.80	0.89	0.98	2,577
Maintenance- Intermediate	0.10	0.13	0.15	370
Total³	2.10	2.28	2.46	6,606

1 Based on VAMOSOC sample size of 4 years.

2 Average annual cost divided by flight hours per year.

3 Total of minimum, average, and maximum years for each cost category. Not an actual annual cost.

Table 59. O&S Cost Information for MH-60S (based on annual hours)

Cost Category	MH-60 S Annual O&S Cost ¹ (2010-2013, CY15M\$)			Estimated Average Non-Flight Cost/Hour ² (CY15\$)
	Minimum	Average	Maximum	
Manpower- Op- erational	0.82	0.85	0.88	97
Manpower- Other	0.27	0.29	0.30	33
Maintenance- Depot	0.13	0.13	0.14	15
Other	0.50	0.52	0.55	59
Total³	1.72	1.80	1.88	205

1 Based on VAMOSOC sample size of 4 years.

2 Average annual cost divided by 8,760 hours per year.

3 Total of minimum, average, and maximum years for each cost category. Not an actual annual cost.

3. Neutralizer Cost Estimates

VAMOSOC did not have data on all the neutralizers so estimated costs were provided based on SME feedback. Specifically, minimum, most likely, and maximum costs were provided for the Archerfish, SLQ-48, and SeaFox. Using a triangle distribution, 1,000 Monte Carlo simulations were run to generate an estimated average cost for each

neutralizer. Given the most likely value was exactly in the middle of each triangle distribution, the estimated average neutralizer cost was found to be very close to the most likely cost. Three outputs from the 1,000 Monte Carlo simulations were averaged to determine the estimated average neutralizer cost. These results are shown in Table 60. As the data from the SME indicated a symmetrical, triangular distribution, the results of the Monte-Carlo simulations produced estimates very near the most likely estimates, as would be expected. Had actual probabilistic neutralizer cost data been available, it would have been used to develop a higher confidence cost estimate.

Table 60. Neutralizer Costs

Neutralizer Type	CY15k\$			Monte Carlo Output (1000 runs)			Mean Cost (CY15\$)
	Minimum	Most Likely	Maximum	1st	2nd	3rd	
Archerfish	50.00	60.00	70.00	58.04	60.24	63.83	60,704.6
SeaFox	50.00	60.00	70.00	59.93	56.31	61.57	59,268.9
SLQ-48	9.00	10.00	11.00	9.80	10.79	10.34	10,310.5

4. Scenario Cost Estimates

To estimate the cost for each configuration to execute the scenario described in Chapter V, the model outputs for neutralizers used, total mission time, and flight time were multiplied by their associated costs and added together for each platform. The equation below describes how each configuration cost was calculated and Table 61 shows the estimated configuration costs. The table is a structure for a possible Monte-Carlo analysis. Using cost element distribution functions would produce the desired cumulative distribution functions of all the configurations, thereby indicating the confidence levels for the cost estimates.

$$\begin{aligned}
 TotalEstimatedCost = & TotalMissionHours * \left(\frac{ShipO \& S}{AnnualHours} + \frac{HelicopterO \& S}{AnnualHours} \right) \\
 & + MissionFlightHours * \left(\frac{HelicopterO \& S}{FlightHours} \right) \\
 & + NumberOfSurfaceNeutralizers * SurfaceNeutralizerCost \\
 & + NumberOfAirborneNeutralizers * AirborneNeutralizerCost
 \end{aligned} \tag{4}$$

Table 61. Estimated Configuration Costs

Configuration	Average Mission Time (hours)	Average Flight Time (hours)	Average # Surface Neutralizers	Average # Airborne Neutralizers	Total Ship O&S Cost (CY15\$M)	Total Helicopter O&S Cost (CY15\$M)	Total Neutralizer Cost (CY15\$M)	Total Estimated Cost (CY15\$M)
1A	574.31	72.26	48.56	0.00	11.56	2.06	0.50	14.12
1B	578.81	72.26	100.45	0.00	11.65	2.06	5.95	19.66
2A	469.71	124.66	36.40	32.78	9.45	3.33	2.32	15.10
2B	473.58	124.47	74.49	32.62	9.53	3.32	6.35	19.20
3 (LCS 1)	528.10	314.46	0.00	128.38	1.93	1.67	7.79	11.39
3 (LCS 2)	528.10	314.46	0.00	128.38	1.43	1.67	7.79	10.89

Table 61 shows that the estimated future configurations' costs are less than those of the legacy configurations. Although the future configurations' total ship O&S costs are much less than the legacy systems, the corresponding neutralizer cost is much greater. This difference between legacy and future neutralizer costs is significant and a consequence of being reliant on only airborne neutralizers where there is no opportunity to share the neutralization load with a surface ship and neutralizers can be wasted on non-mines. As discussed in Chapter X, gaining confidence in mine locations for achieving a threshold percent clearance could reduce the cost associated with wasted neutralizers. These cost results are based on point estimates and not cost probability distributions. Using point estimates does not cover the range of uncertainty, and therefore results in less meaningful cost estimates than using distribution functions for the cost elements would. Furthermore, it is conceivable that for what appears to be a cheaper point estimate by averaging VAMOS data, the overall probability could show otherwise. Had distribution data been available, the configurations cost performance could have shown overlap. That is, the future configuration cost could have been found to be lower than legacy configurations 90 percent of the time. Investigation into the cost driver for the overlap could provide further areas of study for improving future cost performance. For continued study, it is recommended that the cost analysis be expanded to incorporate component cost distributions to develop probabilistic cost estimates. By dividing each configuration's ACRS value by its corresponding estimated cost, a baseline ACRS performance versus cost metric is calculated as shown in Figure 69.

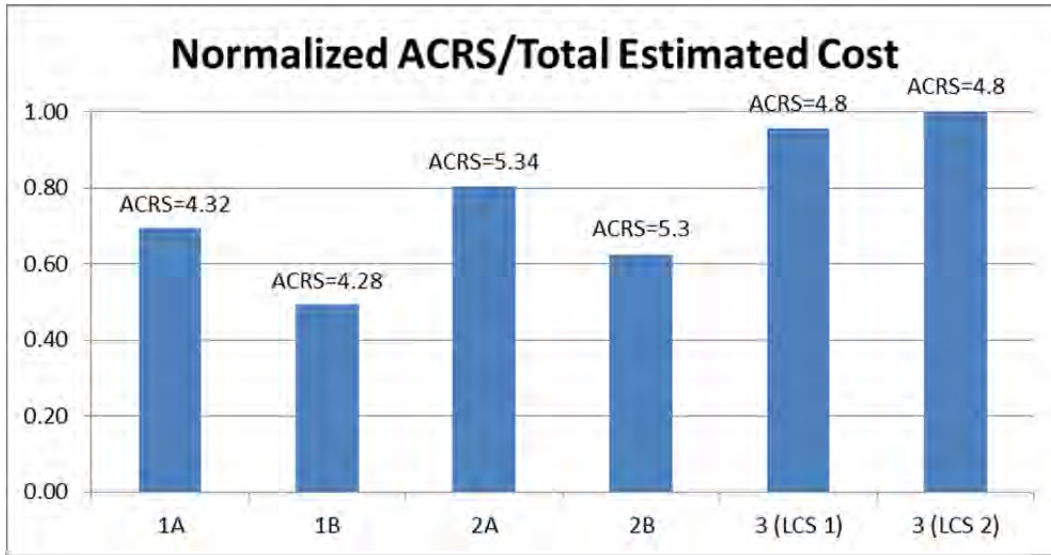

Figure 69. Baseline Configurations: Normalized ACRS vs. Total Estimated Cost

As shown in Figure 69, the future MCM capability provides the best ACRS performance per cost despite not having the best ACRS performance. Given the percent clearance values are similar for each configuration, the percent clearance per total estimated cost for each configuration shown Figure 70 mirror the cost estimates.

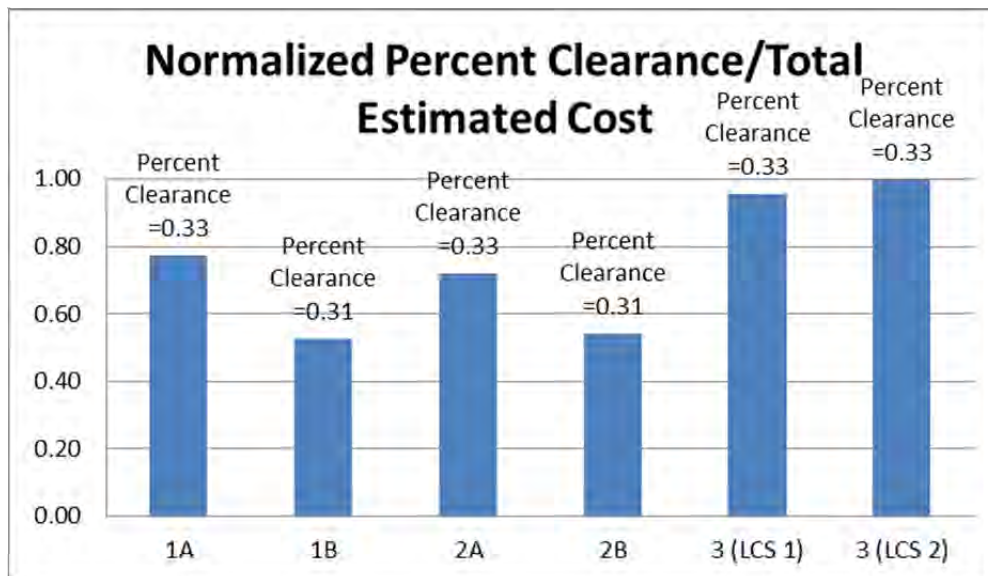

Figure 70. Baseline Configurations: Normalized Percent Clearance vs. Total Estimated Costs

5. Cost Comparison for LCS Improvements

Because ACRS showed variations between configurations while percent clearance did not, ACRS was chosen as the MOE to use as a metric for improvement. Improving the future capability as discussed in Chapter VIII provides performance per cost described in Table 62 and shown in Figure 71. As shown, maintaining a constant RMS search speed of 10 knots provides the best future ACRS performance/cost improvement. Also of note, increasing the RMS sortie time to 24 hours has the same ACRS performance/cost impact as decreasing the RMS stream and recovery time to 15 minutes.

Table 62. Estimated LCS Improvement Costs

Configuration	Average Mission Time (hours)	Average Flight Time (hours)	Average Surface Neutralizers	Average Airborne Neutralizers	Total Ship O&S Cost (CY15\$M)	Total Helicopter O&S Cost (CY15\$M)	Total Neutralizer Cost (CY15\$M)	Total Estimated Cost (CY15\$M)
3 (LCS 2) Base-line	528.10	314.46	0.00	128.38	1.43	1.67	7.79	10.89
3 (LCS 2) SSrchSpeed = 10 knots	400.81	300.60	0.00	127.76	1.09	1.57	7.76	10.41
3 (LCS 2) SSortieTime = 24 hours	444.59	296.63	0.00	127.50	1.21	1.58	7.74	10.53
3 (LCS 2) Sstream = 0.25 hours Srecover = 0.25 hours	447.92	306.03	0.00	127.76	1.21	1.58	7.76	10.55

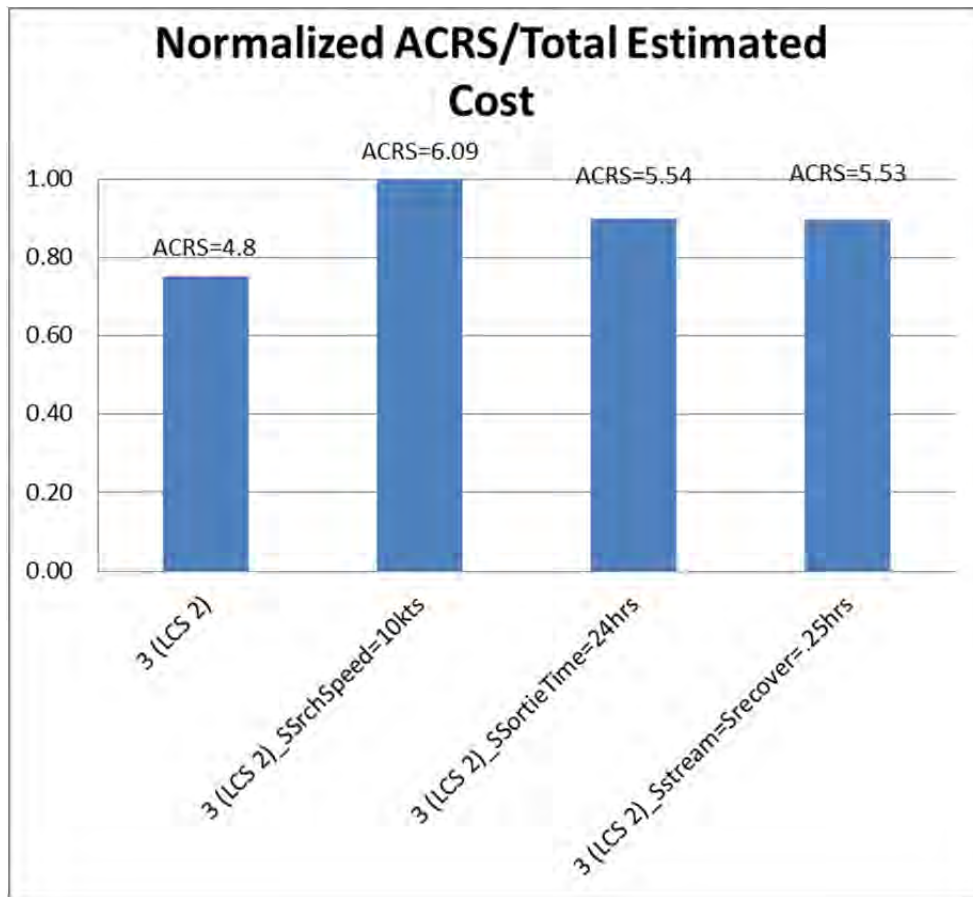

Figure 71. LCS Improvements: Normalized ACRS vs. Total Estimated Costs

Of particular relevance is the cost associated with each of the future configuration improvements. All improvements, by virtue of reducing the average mission time, reduce the total estimated future configuration cost as compared to the baseline future configuration cost. The improvement to maintain a RMS search speed of 10 knots, however, results in the best ACRS and least associated cost. The cost for this improvement is thought to be minimal given the recommended search speed is within the current operating range.

As indicated in Table 61 and Figure 69, the LCS baseline model has the highest ACRS/cost of any of the configurations, so there is trade space for the LCS model to operate at the same ACRS/cost level as the best MCM legacy model, if that is considered good enough, at less mission cost than the MCM legacy model. For example, the legacy MCM configuration 2A model had an ACRS/cost of 0.85 with an estimated mission cost

of 15.1M calendar year 2015 (CY15) dollars, while if the future LCS model operated with an ACRS/cost level of 0.85 the mission cost would be an estimated 9.68M CY15 dollars. This situation opens up some options for the LCS model to work within this trade space operating at peak performance to gain a better ACRS/cost or operating at a performance level that is as good as the legacy MCM system but at a substantial cost savings. Given available data, the analysis within this section used point estimates, as opposed to cost element distributions. It is recommended that this cost analysis be expanded to include distributional data associated with each cost element.

B. RISK ANALYSIS

While performing the analysis of MIW architectures, it was important to consider the risks associated with the operational use of one system versus the other. According to the official guidance from the DOD risk, as it relates to management of Defense systems, is "... a measure of future uncertainties in achieving program performance goals and objectives within defined cost, schedule, and performance constraints" (Under Secretary of Defense (AT&L) Senior Systems Engineer/Engineering Department 2006, 1). Risk is "something one bears and is the outcome of uncertainty" (Mun 2010, 18). Therefore, given some set of potential events whose occurrences have a stochastic nature, it is possible to attribute some estimate of likelihood (which is synonymous with probability for the purposes of risk management) and consequence to those events. This section describes the risk assessment conducted to compare the legacy MCM 1 ship and legacy MCM MH-53E helicopter to the new LCS ship, with its MH-60S helicopter and incremental MIW packages.

1. Risk Assessment Methodology

Typically, the overarching risk management process includes risk identification, analysis, mitigation planning, mitigation plan implementation, and continual tracking (Under Secretary of Defense (AT&L) SSE/ED 2006). Given the scope of this research activity, the risk management activities spanned risk identification, analysis, and mitigation planning only. The risk identification phase has been a continual activity from the start of the research activity. The identification of risks has been facilitated by a combina-

tion of several activities, including literature review, discussion with academic advisors, discussion with subject matter experts, and modeling and simulation. During risk identification activities, careful consideration was made to not confuse risks with issues. A key distinction between risks and issues, or problems, is that

If a root cause is described in the past tense, the root cause has already occurred, and hence, it is an issue that needs to be resolved, but it is not a risk. While issue management is one of the main functions of PMs, an important difference between issue management and risk management is that issue management applies resources to address and resolve current issues or problems, while risk management applies resources to mitigate future potential root causes and their consequences (Under Secretary of Defense (AT&L) SSE/ED, 2006, 1)

Therefore, the identification of risks involved examining potential events that may result in impacts to cost, schedule, and performance of MIW systems, and which have a stochastic element.

The next step in risk management is the risk analysis phase. The objective of risk analysis is to develop an analytical basis for estimates on the likelihood and consequence of each risk. For each risk, the severity of likelihood and consequence is rated on a scale with five bins, and the corresponding likelihood-consequence pair is plotted onto a two-dimensional representation of the risk, as shown in Figure 73.

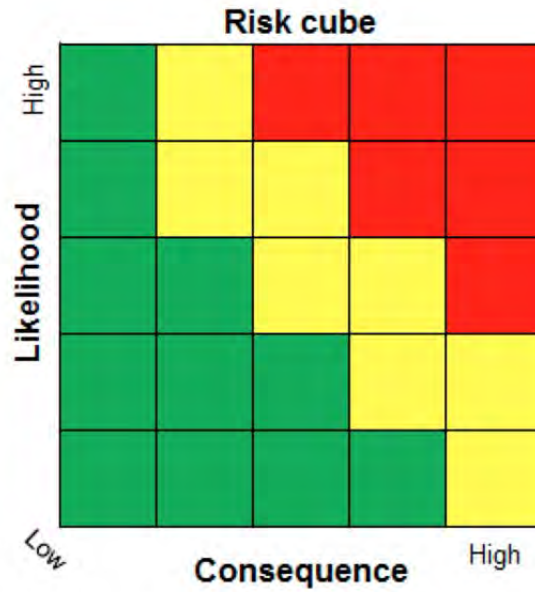

Figure 72. Sample Risk Cube (from Under Secretary of Defense (AT&L) SSE/ED, 2006, 11)

Estimates of each risk’s likelihood and consequence have been facilitated by a combination of several activities, including literature review, discussion with academic advisors, discussion with SMEs, and M&S. The assignments of likelihood and consequence have followed the guidelines provided in Table 63 and Table 64.

Table 63. Levels of Likelihood Criteria (from Under Secretary of Defense (AT&L) SSE/ED, 2006, 12)

Level	Likelihood	Probability of Occurrence
1	Not Likely	~10%
2	Low Likelihood	~30%
3	Likely	~50%
4	Highly Likely	~70%
5	Near Certainty	~90%

Table 64. Levels and Types of Consequences (from Under Secretary of Defense (AT&L) SSE/ED, 2006, 13)

Level	Technical Performance	Schedule	Cost
1	Minimal or no consequence to technical performance	Minimal or no impact	Minimal or no impact
2	Minor reduction in technical performance or supportability, can be tolerated with little or no impact on program objectives	Able to meet key dates Slip < * month(s)	Budget increase or unit production cost increases < ** (1% of budget)
3	Moderate reduction in technical performance or supportability with limited impact on program objectives	Minor schedule slip. Able to meet key milestones with no schedule float. Slip < * month(s) Sub-system slip > * month(s) plus available float	Budget increase or unit production cost increases < ** (5% of budget)
4	Significant degradation in technical performance or major shortfall in supportability, may jeopardize program success	Program critical path affected Slip < * months	Budget increase or unit production cost increase < ** (10% of budget)
5	Severe degradation in technical performance: cannot meet KPP or key technical/supportability threshold; will jeopardize program success	Cannot meet key program milestones Slip > * months	Exceeds APB threshold > ** (10% of budget)

The final step in the risk management process (for this research project) was the mitigation planning phase. According to DOD guidance,

The intent of risk mitigation planning is to answer the question “What is the program approach for addressing this potential unfavorable consequence?” One or more of these mitigation options may apply:

- Avoiding risk by eliminating the root cause and/or the consequence,
- Controlling the cause or consequence,
- Transferring the risk, and/or
- Assuming the level of risk and continuing on the current program plan. (Under Secretary of Defense (AT&L) SSE/ED, 2006, 18)

Risk mitigation planning is the activity that identifies, evaluates, and selects options to set risk at acceptable levels given program constraints and objectives. Risk mitigation planning is intended to enable program success. It includes the specifics of what should be done, when it should be accomplished, who is responsible, and the funding required to implement the risk mitigation plan. The most appropriate program approach is selected from the mitigation options listed above and documented in a risk mitigation plan. (Under Secretary of Defense (AT&L) SSE/ED, 2006, 18)

The development of plausible methods of mitigating each of the identified risks have been facilitated by the same information gathering activities used to develop the likelihood and consequence of each risk. In addition, risk mitigation strategies have also been developed based upon the MIW Team's judgment, which is informed by this study effort.

2. Legacy Option Risk Assessment

A summary of the risks identified, along with their mitigation strategies and resultant risk state post-mitigation are summarized for the legacy MIW system in Figure 74. The six identified risks are described in more detail within the figure.

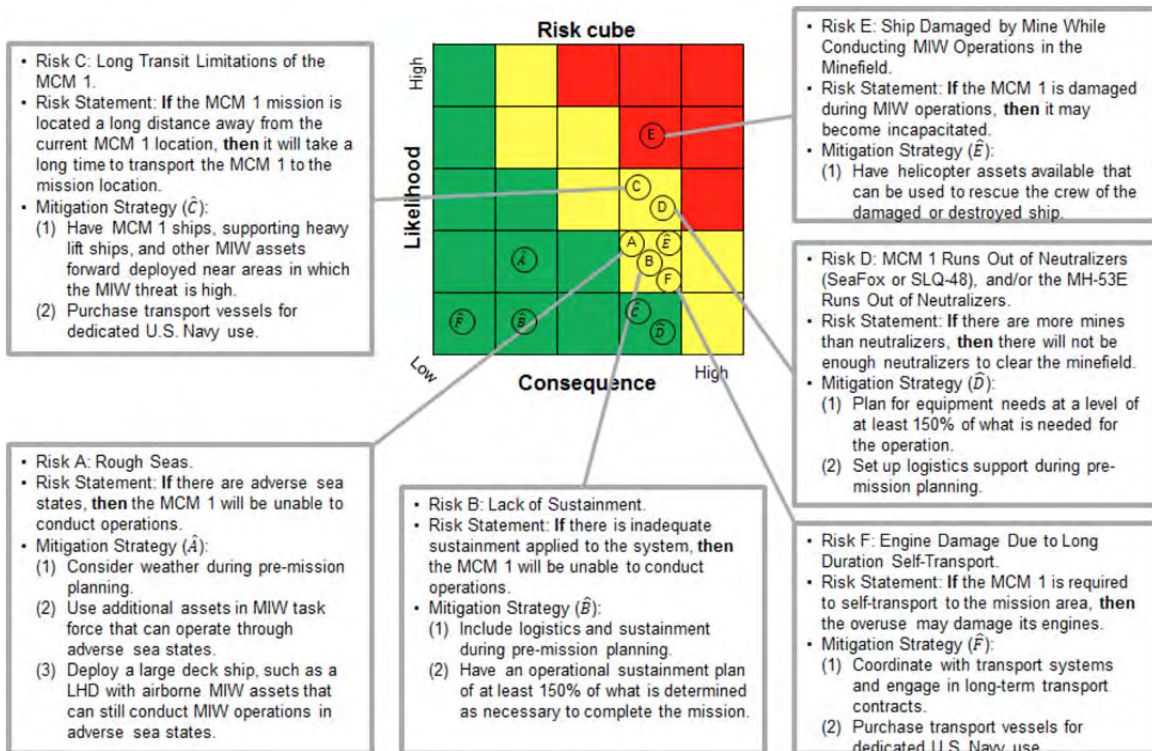

Figure 73. Risk Summary for Legacy MIW System

Risks associated with the legacy MIW system are:

- Risk A: Rough Seas.
 - **Risk Statement:** If there are adverse sea states, then the MCM 1 will be unable to conduct operations.
 - **Likelihood:** 2
 - **Rationale:** The MCM 1 is considerably smaller than the LCS and would therefore be more severely impacted by rough seas.
 - **Consequence:** 4
 - **Rationale:** The MIW mission would be delayed until the sea state permits operations to resume.
 - **Mitigation Strategy:** (1) Consider weather during pre-mission planning. (2) Use additional assets in MIW task force that can operate through adverse sea states. (3) Deploy a large deck ship, such as a LHD with airborne MIW assets that can still conduct MIW operations in adverse sea states.
 - **Post-Mitigation Likelihood/Consequence:** 2/2

- Risk B: Lack of Sustainment.
 - Risk Statement: If there is inadequate sustainment applied to the system, then the MCM 1 will be unable to conduct operations.
 - Likelihood: 2
 - **Rationale**: The MCM 1 requires considerably more manpower and equipment than the LCS and would therefore be more severely impacted by inadequate sustainment.
 - Consequence: 4
 - **Rationale**: The MIW mission would be slowed or stopped due to a lack of adequate sustainment.
 - Mitigation Strategy: (1) Include logistics and sustainment during pre-mission planning. (2) Have an operational sustainment plan of at least 150 percent of what is determined as necessary to complete the mission.
 - Post-Mitigation Likelihood/Consequence: 1/2
- Risk C: Long Transit Limitations of the MCM 1.
 - Risk Statement: If the MCM 1 mission is located a long distance away from the current MCM 1 location, then it will take a long time to transport the MCM 1 to the mission location, which would result in a significantly lower ACRS.
 - Likelihood: 3
 - **Rationale**: Most of the areas in which there is a heightened MIW threat are a long distance from the United States.
 - Consequence: 4
 - **Rationale**: If the ships are a long distance away from the MIW mission, the consequence could be that the enemy force could block vital waterways until the task force can transit to the minefield and conduct MIW operations.
 - Mitigation Strategy: (1) Have MCM 1 ships, supporting heavy lift ships, and other MIW assets forward deployed near areas in which the MIW threat is high. (2) Purchase transport vessels for dedicated U.S. Navy use.
 - Post-Mitigation Likelihood/Consequence: 1/4
- Risk D: MCM 1 Runs Out of Neutralizers (SeaFox or SLQ-48), and/or the MH-53E Runs Out of Neutralizers.

- Risk Statement: If there are more mines than neutralizers, then there will not be enough neutralizers to clear the minefield, which will degrade the percent clearance for the mission.
- Likelihood: 3
 - **Rationale**: Many mines can be laid in a very short period of time, and the MIW task force would not necessarily know how many mines are in the mine field until the MIW mission is started.
- Consequence: 4
 - **Rationale**: Without a sufficient number of neutralizers the MIW mission could stagnate or fail.
- Mitigation Strategy: (1) Plan for equipment needs at a level of at least 150 percent of what is needed for the operation. (2) Set up logistics support during pre-mission planning.
- Post-Mitigation Likelihood/Consequence: 1/4
- Risk E: Ship Damaged by Mine While Conducting MIW Operations in the Minefield.
 - Risk Statement: If the MCM 1 is damaged during MIW operations, then it may become incapacitated.
 - Likelihood: 4
 - **Rationale**: Due to the nature of the MIW mission, there is a high probability that an MCM 1 ship could be damaged or destroyed by a mine while it is conducting MIW operations.
 - Consequence: 4
 - **Rationale**: A ship being damaged or destroyed inside a mine field could change the nature of the MIW mission or even cause the mission to fail.
 - Mitigation Strategy: Have helicopter assets available that can be used to rescue the crew of the damaged or destroyed ship.
 - Post-Mitigation Likelihood/Consequence: 2/4
- Risk F: Engine Damage Due to Long Duration Self-Transport.
 - Risk Statement: If the MCM 1 is required to self-transport to the mission area, then the overuse may damage its engines.
 - Likelihood: 2

- **Rationale:** Under some circumstances the MCM 1 will be required to be engaged in long-distance self-transport to the mission area due to either transport cost or availability issues.
- Consequence: 4
- **Rationale:** In some instances the long distance self-transport will result in catastrophic engine failure.
- Mitigation Strategy: (1) Coordinate with transport systems and engage in long-term transport contracts. (2) Purchase transport vessels for dedicated U.S. Navy use.
- Post-Mitigation Likelihood/Consequence: 1/1

3. Future Option Risk Assessment

A summary of the risks identified, along with their mitigation strategies and resultant risk state post-mitigation are summarized for the legacy MIW system in Figure 75. The detailed descriptions of the four identified risks are contained with the figure.

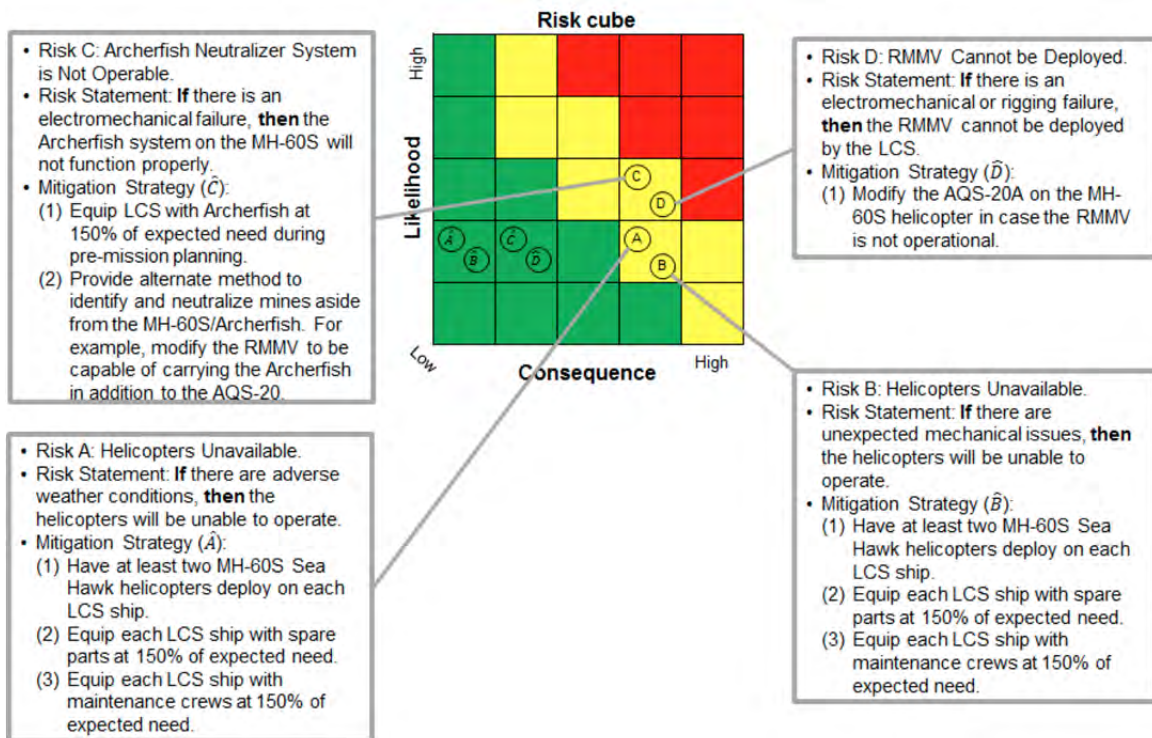

Figure 74. Risk Summary for Future MIW System

The risks associated with the future MIW system are:

- Risk A: Helicopters Unavailable.
 - Risk Statement: If there are adverse weather conditions, then the helicopters will be unable to operate.
 - Likelihood: 4
 - **Rationale**: Helicopter availability is limited due to environmental conditions.
 - Consequence: 4
 - **Rationale**: LCS would lose near surface detection and all neutralization functions until helicopters are operational again. Other neutralization assets, such as EOD divers, could be used but operations would be much slower. (Brett Cordes, personal communication, 28 July 2014)
 - Mitigation Strategy: (1) Have at least two MH-60S Sea Hawk helicopters deploy on each LCS ship. (2) Equip each LCS ship with spare parts at 150 percent of expected need. (3) Equip each LCS ship with maintenance crews at 150 percent of expected need.
 - Post-Mitigation Likelihood/Consequence: 2/1
- Risk B: Helicopters Unavailable.
 - Risk Statement: If there are unexpected mechanical issues, then the helicopters will be unable to operate.
 - Likelihood: 4
 - **Rationale**: Helicopter availability is limited due to mechanical breakdown.
 - Consequence: 4
 - **Rationale**: LCS would lose near surface detection and all neutralization functions until helicopters are operational again. Other neutralization assets, such as EOD divers, could be used but operations would be much slower. (Brett Cordes, personal communication, 28 July 2014)
 - Mitigation Strategy: (1) Have at least two MH-60S Sea Hawk helicopters deploy on each LCS ship. (2) Equip each LCS ship with spare parts at 150 percent of expected need. (3) Equip each LCS ship with maintenance crews at 150 percent of expected need.
 - Post-Mitigation Likelihood/Consequence: 2/1
- Risk C: Archerfish Neutralizer System is Not Operable.

- Risk Statement: If there is an electromechanical failure, then the Archerfish system on the MH-60S will not function properly.
- Likelihood: 3
 - **Rationale**: Because of the sea environment, electromechanical systems such as the Archerfish can fail. The Archerfish system is especially important because the Archerfish is the only mine hunting neutralization asset that is planned to be carried by the LCS MIW platform.
- Consequence: 4
 - **Rationale**: If the MIW task force is unable to neutralize the mines in the minefield the mission could stagnate while waiting for replacement systems or the mission could fail.
- Mitigation Strategy: (1) Equip LCS with Archerfish at 150 percent of expected need during pre-mission planning. (2) Provide alternate method to identify and neutralize mines aside from the MH-60S/Archerfish. For example, modify the RMMV to be capable of carrying the Archerfish in addition to the AQS-20.
- Post-Mitigation Likelihood/Consequence: 2/2
- Risk D: RMMV Cannot Be Deployed.
 - Risk Statement: If there is an electromechanical or rigging failure, then the RMMV cannot be deployed by the LCS.
 - Likelihood: 3
 - **Rationale**: The RMMV is a complex electromechanical system that has to be hoisted into position behind the ship, and then lowered into the water each time it is deployed, and hoisted up each time for recovery. There is a high probability that electromechanical failure could cause the system to fail or to not be able to be deployed.
 - Consequence: 4
 - **Rationale**: If the RMMV cannot be deployed the LCS/MIW system will lose 100 percent of its deep water detect and classify capability.
 - Mitigation Strategy: Modify the AQS-20A on the MH-60S helicopter in case the RMMV is not operational.
 - Post-Mitigation Likelihood/Consequence: 2/2

4. Risk Comparison

The risks indicated in this section pertain primarily to the operation of the legacy and future MCM systems. The risk mitigation approaches and their effects to reduce the probability of occurrence and impact on the successful completion of the MCM mission could be analyzed using the model built for this study. Possible risk studies such as studying the effect if either the surface or air-based systems are inoperable or unavailable are recommended. These additional studies could be conducted with the model built for this study with some minor modifications. Understanding the impacts of these risks may assist with planning alternative approaches or to determine when redundancy would be warranted.

C. COST AND RISK CONCLUSIONS

As studied, the MCM capability provided by the future, LCS, system provides the best cost/performance ratio over the legacy systems. Based on the point estimates used in the cost analysis, the baseline configuration that involves parallel hunting and neutralizing, as modeled in configurations 2A and 2B, has a higher ACRS value over all other configurations. Recommendations to improve the average mission hours and average flight time hours will have the largest impact on the total O&S costs and should be additionally evaluated. The recommendations to improve the performance of the LCS system (e.g. increasing the surface search speed, reducing the RMS stream and recover times, and increasing the RMS sortie time) should be evaluated further. Additionally, the costs of the configurations should be evaluated using probabilistic functions for the cost elements to produce the actual cost estimates. Developing the cost and risks associated with those improvements would be a logical extension of those improvement studies.

X. SUMMARY, CONCLUSIONS, AND RECOMMENDATIONS

The MIW Team followed a disciplined SE process from development of the project scope and requirements through ultimate development of the conclusions and recommendations included in this section. The problem statement to evaluate the effectiveness of future MCM capabilities compared to legacy MCM capabilities was derived from the stakeholders' primitive needs and objective and then refined to develop a focused, realizable set of project goals. The functional and physical architectures were developed to represent the portions of the MCM system pertinent to the study's objectives. The requirements were defined and mapped to the critical MOPs and MOEs that guided the conduct of the study. Ultimately, IAW the requirements, a simulation was built that was used to develop the analytical results used to compare the performance of the legacy and future MCM systems. Moreover, the costs and risks associated with the legacy and future systems were evaluated that added depth to the performance analysis. Finally, analysis was conducted to develop a set of recommendations for potential improvements to the future system's performance in defensive MCM operations.

Through the execution of this project, the MIW Team was able to practice the SE skills and practices learned in the NPS MSES/MSSE curriculum. Several lessons were learned and reinforced, most notably, the iterative nature of SE tasks and the importance of continued communication with the stakeholders. MBSE was used to frame the study through the modeling of the functional and physical architectures and the mapping of these elements to the requirements.

The primary research questions that guided the reviews of the literature and previous studies centered around the current and planned MCM capabilities, gaps in desired capabilities, systems and functions required or planned to provide capabilities, the CONOPS that is followed by each of the MCM platforms, and the evaluation metrics that the U.S. Navy uses to assess the effectiveness of the MCM capabilities. The research also provided the information required of the necessary functions that are performed. Additional research and discussions with the MIW SMEs provided the essential details on the physical systems that are used to conduct the MCM functions and the way in which they

are used (e.g., the CONOPS of the MCM systems) (Admiral Richard Williams III, personal communication, 11 and 25 April 2014 and 2 May 2014; LT Andrew Watts, personal communication, 10 July 2014; Brett Cordes, personal communication, 9 May 2014).

Regarding the MCM techniques and systems, this study allowed the MIW Team to develop a respectful appreciation for the complexity of MIW. This was extended to the design and development of appropriate models and simulations to represent the functional performance of the different MCM configurations. Through the M&S effort and the DOE approach described within this report, the MIW Team conducted the comparative analysis between the legacy and future MCM systems. Furthermore, these efforts allowed the team to extend the analysis to develop a set of recommendations that could potentially enhance the performance capabilities of the future MCM systems. Additionally, cost and risk analyses were performed on the planned and current platforms.

A. CAPSTONE CONCLUSIONS

Using the approved input model parameter value ranges based on MCM systems MOPs described in Chapter VII, the study found that the legacy MCM 1 configurations utilizing a parallel search approach outperformed all other configurations in the ACRS MOE while each configuration had similar mine clearance effectiveness. Table 65 contains the results, originally documented in Chapter VII.

Table 65. Summary MOE Comparison

	ACRS			Percent Clearance		
	Mean	95% Confidence Interval		Mean	95% Confidence Interval	
		Lower	Upper		Lower	Upper
Configuration 1A	4.32	4.25	4.39	0.33	0.32	0.34
Configuration 1B	4.28	4.21	4.35	0.31	0.30	0.32
Configuration 2A	5.35	5.25	5.45	0.33	0.32	0.34
Configuration 2B	5.30	5.20	5.40	0.31	0.30	0.32
Configuration 3	4.80	4.71	4.89	0.33	0.32	0.34

As shown, although the future LCS MCM capability (configuration 3) has an ACRS of approximately 10 percent over that of the best performing legacy MCM capability performing serial minehunting (configurations 1A and 1B), its ACRS is only about

90 percent of the performance of the legacy MCM capability performing parallel mine-hunting (configurations 2A and 2B).

These results make intuitive sense given the configuration and operational scenario descriptions described in Chapters IV and V, respectively. Configurations 1A, 1B, and 3 perform minehunting in a serial fashion where the AMCM and SMCM systems perform only portions of the functions required for successful MCM. In configurations 1A and 1B, the MH-53E is only used for mine detection and classification and the MCM 1 must perform all of the identification and neutralization functions. In configuration 3, it is the MH-60S that performs all of the neutralization while the RMS launched from the LCS does the detection and classification tasks. The slight advantage of configuration 3 over configurations 1A and 1B is thought to be attributed to the speed with which the detection and classification is achieved. The speed advantage of the RMS over the MCM 1 allows the mission to be completed faster, which has a direct impact on ACRS. The slight advantage of 1A over 1B is thought to be attributed to the fact that the SLQ-48 does not use an exploratory neutralization round. Configuration 1B's probabilistic chance of using an exploratory neutralization round where a MILCO identified as a mine would then require another neutralizer to be launched would take additional time and therefore reduce the ACRS. Configurations 2A and 2B perform minehunting in a parallel fashion where the AMCM and SMCM systems perform all functions required for successful MCM. The MH-53E and MCM 1 detect, classify, identify, and neutralize. This allows an area to be covered more quickly. The slight advantage of 2A over 2B is due to the same reason that 1A performs better than 1B. That is, configuration 2A uses the SLQ-48 while configuration 2B may use an exploratory neutralization round. The percent clearance results for all configurations are also not surprising. Given the sensitive nature for the probabilistic sensor performance, the same ranges were used for all configurations. The slight advantage of configurations 1A, 2A, and 3 over 1B and 2B is attributed to the extra reacquisition step required in configurations 1B and 2B when an exploratory neutralizer round is used. The extra step of trying to reacquire a mine with a live round could result in non-reacquisition and reduce the overall percent clearance.

The O&S cost per mission for the future and legacy systems are compared in Table 66. The configuration performance versus cost, shown in Figure 69 and Figure 70 from Chapter IX indicates that the future MCM configuration, despite not having the best ACRS performance, has the best overall performance versus cost based on point estimates of costs.

Table 66. Performance and O&S Cost Comparison for Baseline Configurations

Configuration	Average Mission Time (hours)	Average Flight Time (hours)	Total Ship O&S Cost (CY15\$ M)	Total Helicopter O&S Cost (CY15\$ M)	Total Neutralizer Cost (CY15\$ M)	Total Estimated Cost (CY15\$ M)
1A	574.31	72.26	11.56	2.06	0.50	14.12
1B	578.81	72.26	11.65	2.06	5.95	19.66
2A	469.71	124.66	9.45	3.33	2.32	15.10
2B	473.58	124.47	9.53	3.32	6.35	19.20
3 (LCS 1)	528.10	314.46	1.93	1.67	7.79	11.39
3 (LCS 2)	528.10	314.46	1.43	1.67	7.79	10.89

The risks associated with the configurations include multiple elements as described in Chapter IX. Primary among them is the risk to life and equipment. The legacy configurations utilize more equipment given the LHD is required to support AMCM and the manned MCM 1 must enter the minefield to conduct minehunting. The future configuration, however, requires only one minimally manned SMCM system, the LCS, in support of AMCM and utilizes the unmanned RMS for detection and classification. For these reasons, the future MCM configuration presents less risk to life and equipment for the MCM scenario considered as part of this study.

Overall, in comparing legacy to future MCM capabilities in clearing a SLOC of bottom mines, the future MCM capability has clear performance versus cost and risk advantages. The following provides recommendations for improving the ACRS and effectiveness of the LCS.

B. RECOMMENDATIONS FOR ENHANCED LCS OPERATION

Though the future MCM configuration was found to have better ACRS and percent clearance performance versus cost, the MIW Team explored several potential changes to the future MCM configuration that would improve its ACRS performance to that of the best legacy MCM configuration. Based on the impactful factors found as part of the sensitivity analysis conducted (described in Chapter VII), several experiments were performed as described in Chapter VII. It was found that the ACRS could be increased by over 15 percent through each one of the following improvements: keeping the RMS surface search speed constant at 10 knots, reducing the RMS stream and recover time to 15 minutes, and improving the RMS sortie time to 24 hours all improved the future ACRS by over 15 percent. Moreover, as shown in Chapter IX, each of these improvements for the future configuration resulted in a total estimated cost that was less than the original baseline future configuration. Figure 76 displays the normalized ACRS per total O&S cost for the baseline configurations, as well as the three recommended LCS improvements (highlighted in blue). As indicated, if only one improvement were to be chosen, the MIW Team would recommend maintaining the RMS search speed at 10 knots, as this option provided both the best performance and least mission cost. As these recommendations are based on the structure of the study described within this report, there are further analyses that are recommended in the future. These studies could not be accomplished within the study's constraints.

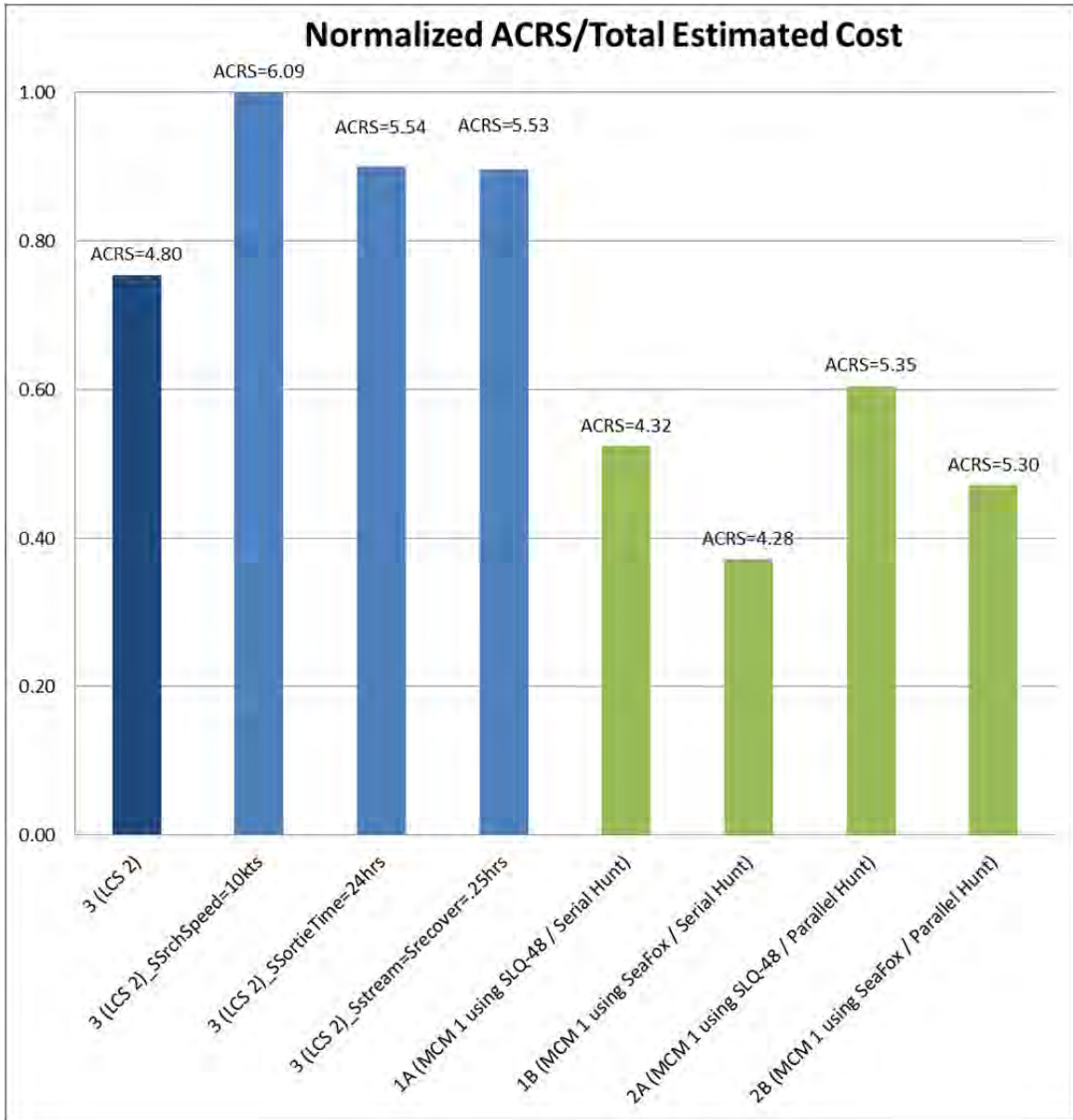

Figure 75. Comparison of Normalized ACRS per O&S Cost for Baseline and Improved LCS Configurations

C. RECOMMENDATIONS FOR FUTURE STUDIES

As part of refining this Capstone scope and performing the analyses contained within this report, the MIW Team identified several areas for future studies. Some recommendations relate to expanding the limited MCM scenario considered, other recommendations relate to potential model improvements for enhanced comparative analysis,

and additional recommendations relate to direct extensions of the research summarized in this study.

1. Expanded Operational Scenario

As discussed in Chapter V, the operational scenario considered in this report focused on clearing a SLOC of bottom mines in deep water. One of the biggest assumptions made was that all surface and near-surface mines had already been cleared. Given the differences in the legacy and future systems as well as the way in which they are deployed, it is very possible that the performance versus cost evaluation of the legacy and future capabilities could be different in a scenario that includes surface mines. It is recommended that future studies include expanded MCM missions to gain a better assessment of how the legacy and future capabilities compare for different missions.

In addition, the chosen scenario did not take into account the environmental factors or sea states. It is recommended that future studies take into account the environmental and sea state variables to obtain a more realistic result of the efficacy of the mine hunting operations. Additionally, the incorporation of different types of mines into the simulation would provide a much more realistic simulation of an actual MCM operation. Finally, investigating shallow water operations would provide another vantage point for evaluating the limitations and advantages of the current and planned MCM systems.

2. Model Improvements

The current models take as inputs a given number of mines and non-mines and goes about detecting, classifying, reacquiring, identifying, and neutralizing based on the probabilistic performance of the sensors and neutralizers until all known objects are categorized. The model does not continue based on a threshold number of objects contained in one category. It is recommended that the simulation be modified so that the minehunting operation will continue until the desired percent clearance is achieved. This is more representative of the actual MCM operation in that mine clearance activities will continue until the probability of residual mines is less than five percent. This scenario was not included in this project due to the time constraints in which the study was conducted.

The current models only simulate a single LHD, MCM 1, and MH-53E for legacy configurations and a single LCS and MH-60S for the future configuration. To further represent the actual MCM operations, it is recommended that the models be modified to represent the entire task force for both the legacy and the future MCM systems. This would provide a more realistic perspective into the performance and the cost of the employment of multiple platforms in a mine clearance operation. Again, the time constraints under which this project was accomplished did not allow for the inclusion of the multiple platforms.

As discussed in Chapter IX, the cost estimates associated with the O&S and neutralizer costs for each configuration were based on point estimates derived from VAMOS and SME feedback. Had cost distribution data been readily available, the MIW Team could have incorporated a probabilistic analysis for how each configuration performs into the cost model and investigated which cost drivers are most impactful. Future studies could improve the cost model to account for component cost distribution.

3. Study Extensions

An important element that was not addressed within this study is the impacts of the collection and transfer of intelligence data regarding the mining operations performed by the adversary. Including the factors associated with the intelligence would be an interesting and informative augmentation to the study of the length of time and effectiveness of MCM operations.

Another approach to this study that would be helpful to the MIW community is scenario-based analysis. For example, in many cases if a mine field is present the goal is to clear a path through the minefield for blue force shipping as soon as possible. For this type of scenario the minefield would be reconnoitered and its borders identified. Once the minefield borders are identified a narrow path would need to be cleared through the full length of the minefield. For example if the length and a width of the minefield is 10 NM by 10 NM respectively, a narrow path would need to be cleared, 100 meters wide by 10 NM. The two key MOEs for MIW is ACRS and percent clearance, for this type of scenario percent clearance would be the key metric to achieve. The initial goal would be to

clear the path through the minefield to a percent clearance of at least 0.95. Once this path is clear to a percent clearance of 0.95 blue force shipping can then transit through the minefield; once this goal is accomplished, the rest of the minefield can then be cleared to a percent clearance of 0.95.

The MIW Team conducted the study described within this report to compare the minehunting capabilities of the legacy and future MCM systems. Based on the two MOEs selected, ACRS and percent clearance, and using the baseline parameter values, it was found that the legacy systems operating in a parallel hunt operation outperformed the other systems. The future system did outperform the legacy systems operating in a serial mode of operation. The costs and risks associated with operating the legacy and future systems showed that the future system has a lower O&S cost per mission than the legacy configurations. Based on the sensitivity analysis, several recommendations were then provided to increase the performance of the future, LCS, system with respect to the ACRS MOE. Finally, there are logical extensions to this study that would result in data and information that may be useful for the MIW community, such as analyzing the impacts of intelligence data and analyzing different scenarios encountered during MCM operations.

THIS PAGE INTENTIONALLY LEFT BLANK

APPENDIX A. SUMMARY OF MCM HISTORY

This appendix contains an overview of the history of MCM. The details of this appendix were developed during the literature review conducted by the MIW Team.

A. WAR OF INDEPENDENCE TO FIRST WORLD WAR (1777–1918)

MIW initially developed as a means to protect shallow water channels. The U.S. first practiced MIW during the War of Independence and subsequently during the American Civil War. Even in these early years this included: free-floating contact mines; mines that could be attached directly to the hull of a ship; moored contact mines with positive buoyancy tethered to the seabed so as to lie under the surface of the water; and controlled mines remotely detonated by an observer. These types of mine threats still exist today. As with every other development in warfare, soon after mines became an effective means of waging war, methods of countering them were developed (Melia 1991).

An early success in mine countermeasure took place during the American Civil War at Mobile Bay. Union Rear Admiral David Glasgow Farragut famously led his fleet through a minefield set by Confederate forces to defend the bay. Prior to this action, however, Admiral Farragut watched the Confederate minelayers' activities closely, enabling him to determine where new mines had been laid. He also dispatched his flag lieutenant, Lieutenant John Crittenden Watson, to find a safe path through the field. Previous intelligence indicated that the mines tended to deactivate after long submersion, where "long" was on the order of the several months that most of these mines had been in place. Over many nights, Watson embarked on the task of sinking or untethering a sufficient number of mines to clear a safe path into the bay. Watson also retrieved several examples of the enemy mines for study. Lieutenant Watson's slow, painstaking, and dangerous work was one of the earliest successful attempts at MCM operations, in particular, mine-hunting. Even to the modern day, minehunting missions have many of the same elements as Watson's approach. Observing the enemy, collecting intelligence on the capabilities and weaknesses of the weapons, locating the mines, and neutralizing the threat are all critical components of modern minehunting (Naval Mine Warfare Engineering Activity

1991). By the time Farragut uttered his oft-repeated order “Damn the torpedoes! Full speed ahead!” the route he intended to sail was clear of active mines (Melia 1991, 3). In fact, the only one of his ships to be damaged in transiting into the bay had sailed outside the lane Watson had marked. However, this order has come to haunt the U.S. Navy in terms of attitudes toward MCM. Farragut’s success, partially due to the underappreciated efforts of Lieutenant Watson and partially due to both the unreliability and poor employment of mines, led most naval planners largely to dismiss the mine threat. Only periodically, when a renewed mine threat has appeared in times of war, have attitudes changed (Melia 1991). The first of these changes came when moored contact mines were used in the mining of the entrance to Port Arthur, and mining in the open sea during the Russo-Japanese war of 1904. Not only were these mines effective but the typical small minesweeping vessels used to counter mines were also rendered useless because they could not be used in open seas. This prompted the Commander in Chief, U.S. Atlantic Fleet, on the eve of the First World War, to recommend “all Atlantic Fleet destroyers be fitted out for additional duty as minesweepers” (Melia 1991, 28).

The First World War saw improvements in the technologies used to sweep mines with the speed of mine clearance being one of the important performance criteria. However, it also saw the introduction of counter-countermeasures to make mines more resistant to the various sweeping techniques. For the U.S. Navy, the First World War also saw the introduction of dedicated MCM vessels:

Attention to specific minesweeper construction began in the fall of 1916, when the Office of the Chief of Naval Operations (OPNAV) recommended new construction of light draft minesweepers ‘to be seagoing and with sufficient speed to accompany the Fleet, with power enough to sweep at a speed of ten knots, and to be classified as Fleet Sweepers’. (Melia 1991, 33–34)

The extensive mining operations by the allies in the First World War led to the need to clear these minefields (as well as some of the enemy laid minefields) at the end of hostilities with a premium on safe and quick mine clearance. This was a significant undertaking requiring a level of effort that was an order of magnitude greater than that required to lay the minefields. Mine clearance at the end of the First World War also saw

the first use of airborne MCM. The British used aircraft both to spot mines and to drop counter-mines on the minefields. Near the end of the First World War the British also developed the first influence mine. This type of mine was triggered when it “read” a ship’s magnetic signature; at that time it was thought to be “unsweepable.” However, it was not deployed in significant numbers (Melia 1991).

B. BETWEEN THE TWO WORLD WARS (1918–1938)

In the U.S., following the end of mine clearance operations after the First World War, minesweepers were laid up and the crews were disbanded. As a result, little MCM expertise remained within the active officer corps of the U.S. Navy. In addition, plans for a new minesweeper that would have included greater speed, armament, and maneuverability, were shelved. This new minesweeper would have been employed with convoy and anti-submarine patrols. Instead, mines were once again relegated to the status of a secondary threat with the perception that they could be easily countered if and when the need arose. In the U.S. Navy, MIW was not a favored career field and the lack of MCM expertise perpetuated. By the eve of WWII the MCM capabilities within the U.S. Navy had atrophied severely – both in terms of MCM ships and MIW expertise. When MCM was included in exercises it was usually simulated, which perpetuated the belief that MCM was not an area of concern. Moreover, the U.S. Navy failed to keep abreast of advances in mines and clearance methods and appeared to have forgotten the lessons learned in the First World War (Melia 1991).

C. SECOND WORLD WAR (1939–1945)

In contrast to the U.S., the British maintained an active interest in MIW as a result of their significant losses of shipping due to mines. Not only did the British develop magnetic influence mines, which could be laid on the seabed and could not be swept by conventional methods, but they also developed improved MCM (Melia 1991, 44). The Germans also continued to develop mine capabilities and by the early part of the Second World War had developed combined magnetic-acoustic influence mines with ship counting to confound influence-minesweeping techniques (Melia 1991, 46). The increasing sophistication of mines made intelligence a critical part of effective minesweeping. Alt-

though the U.S. had fallen behind in mine countermeasure capabilities, the Lend-Lease program provided a learning opportunity. Under this program, the U.S. provided minesweepers to the British to meet their specific needs. This enabled the U.S. to learn from the experience of the British and, during the period 1939-1941, the U.S. Navy restructured its MIW program. However, this rapid expansion of MIW capability in the U.S. came about in a largely uncoordinated and sometimes uncooperative way. Due to the U.S. Navy's decentralized organization, multiple agencies were involved in tackling different parts of the problem, or sometimes even competing in the same area. That significant progress was made was due mostly to the initiative and efforts of two highly motivated and competent desk officers in OPNAV—first Captain Alexander Sharp and then, in 1941, his successor Lieutenant Commander R. D. Hughes (Melia 1991, 50–51). Also, in 1942 the MIW Operational Research Group was established to study adversary tactics and develop effective MCM. The motivation to establish this group stemmed from the need to improve the interaction between civilian scientists studying MCM techniques and the naval personnel actually employing MCM methods (Melia 1991).

Allied landings in the Mediterranean theater of operations only encountered contact mines and simple magnetic influence mines that were easily countered. Nevertheless, even this MCM task caused many lessons from the First World War to be relearned in terms of planning, properly equipping the minesweepers, and controlling operations. The Normandy landings in 1944, however, exposed the allies to the pressure influence mine for the first time. The Germans had held this capability in reserve since 1940 and, while the Allies had general knowledge of the existence of this type of mine, the lack of specific intelligence meant that no effective countermeasures had been developed against it. Although there were significant losses due to mines during the Normandy landings on D-Day, 6 June 1944, it was later discovered that it was only through good fortune that some large minefields had been completely missed by the invasion fleet. Nevertheless, the variety of mines, including more sophisticated influence mines, had completely changed the nature of MCM requirements. No longer was it possible to sweep for a single type of mine. It was now necessary to locate mines and determine their exact characteristics—minehunting was now the only effective way to deal with these new types of minefields.

The experiences of Normandy spurred research efforts to develop new sweep techniques to deal with sophisticated mines, as well as new minehunting techniques to detect these types of mines (Melia 1991).

The lack of U.S. capability in MCM was apparent when, in June 1945, in preparation for the landings at Balikpapan, Dutch Borneo, U.S. minesweepers needed to clear U.S. and Allied influence mines. This was an unprecedented operation and, in the 16 days of the pre-assault sweep, the U.S. lost seven minesweepers. This was a clear indication that the U.S. was ill-prepared to deal with sophisticated mines, even those of its own making (Melia 1991).

D. POST-SECOND WORLD WAR (1946–1949)

Following the Second World War, as at the end of the First World War, there was a need to clear the Allies' own minefields. There were 25,000 influence mines in Pacific waters. After about nine months, a combined U.S. and Japanese operation had accounted for about half of the mines. The Japanese then continued alone with a smaller fleet of minesweeping vessels but, after 25 years of mine clearance, it was estimated that approximately 2,000 of the 25,000 influence mines still had not been cleared. Once again, as after the First World War, lessons went unlearned. Not only did the U.S. have considerable difficulty in clearing its own minefields following the cessation of hostilities, but the U.S. had been highly dependent on the British for their MCM technology and tactics, and the success of MCM efforts was measured by outcomes that, as in the case of the D-Day landings, were often fortuitous and not an indication of sound MCM techniques; and. This was compounded by the post-WWII demobilization of nearly all of the officers who were experienced in MCM. MCM once again became the purview of a relatively small number of active duty personnel who retained a personal interest in MCM. However, the biggest lesson missed was the need to change from low technology minesweeping to the more complex minehunting techniques required to counter the threat of influence mines (Melia 1991, 58). This required a dedicated, long-term effort to determine methods to locate and identify such mines as well as the techniques to clear them. Unfortunately, the

immediate post-war period saw the demise of plans for a new non-magnetic fleet minesweeper and there was little development in minehunting sonar capabilities (Melia 1991).

E. KOREAN CONFLICT TO VIETNAMESE CONFLICT (1950–1964)

Within five years of the end of WWII, concerns over Communist offensive mining operations in Indochina led to increased interest in MCM at the highest levels in the U.S. Navy. In April 1950, Chief of Naval Operations (CNO) Admiral Forrest P. Sherman authorized increased MCM research and development when he approved the recommendation from Navy planners for the implementation of a minehunting system. The planners' report warned "the great danger is that if mine countermeasures continue to be neglected, large wartime appropriations for countermeasures will be almost useless because the fundamental development will still have to be done first" (Melia 1991). Unfortunately, the initiative to improve MCM capabilities was once again beset by organizational challenges with disagreements between the Bureau of Ordnance and the Bureau of Ships. A Massachusetts Institute of Technology report indicated that MIW was being pursued in an "uncoordinated and unintegrated manner" and recommended the unification of MCM efforts under one organization (Melia 1991).

At the time of the invasion of the Republic of Korea (South Korea) by the Democratic People's Republic of Korea (North Korea) in June 1950, the U.S. Navy had very limited MCM assets at its disposal. In preparation for the amphibious landing at Wonsan the U.S. used "Mariner" patrol-bomber (PBM) aircraft as well as ship borne helicopters to help detect mines. Due to the known inadequacies of the U.S. MCM force, the MCM operations were augmented by 20 Japanese minesweepers. The Japanese MCM force was well practiced in dealing with influence mines as a result of their continuing efforts to clear mines from the waters around Japan that were planted during the Second World War. However, the MCM force as a whole was ill-prepared and under-equipped for the task (Melia 1991).

The first attempt to clear a channel of mines at Wonsan was abandoned when a helicopter spotted five lines of mines of unknown type ahead of the MCM force. The next day an attempt to clear another channel, led by three steel-hulled fleet minesweepers, was

continued in spite of helicopter reports of three lines of mines ahead. Within a few minutes of entering the minefield one of the minesweepers was sunk by a mine, another damaged by a mine, and the third became inoperable due to engine failure. Since land forces had already reached Wonsan on the previous day, it was decided not to take any further risks in getting the troop transports into the harbor. As a result, it took a week before the U.S. Marines finally landed at Wonsan following careful and methodical measures to locate, identify, and clear sufficient mines. In addition to airborne spotting of mines, divers were used to hunt, mark, and clear the mines (Melia 1991).

The extensive minefields comprised a carefully deployed selection of Soviet-supplied contact, magnetic, and controlled mines that had been laid with the assistance of experienced Soviet MIW officers. In this mix of mines, the contact mines were of 1904 vintage. This prompted Rear Admiral Allan E. Smith (Commander Amphibious Task Force) to inform Admiral Sherman, CNO, “[w]e have lost control of the seas to a nation without a Navy, using pre-World War I weapons, laid by vessels that were utilized at the time of the birth of Christ” (Melia 1991, 76). The conclusion drawn by the Navy from the Wonsan experience was that “adequate mine countermeasure forces with trained personnel and equipment should be provided in each fleet and should be ready for service” (Melia 1991). This should include “a sufficient mix of MCM-specific surface vessels, assisted by helicopters to mine spot in the advance, divers to detonate mines, and advanced theater-level intelligence gathering” (Melia 1991). Although there was insufficient time to introduce new equipment for MCM during the remainder of the Korean conflict, lessons learned from operations in Wonsan were employed. This included the use of airborne reconnaissance as well as increased intelligence gathering. In addition, some older MCM ships were re-commissioned and other platforms were adapted to support MCM operations. Finally, active coordination of airborne, surface, and subsurface minehunting forces was achieved (Melia 1991).

The humiliation at Wonsan finally forced the Navy as a whole to take the mine threat seriously. The Navy developed requirements for an ocean minesweeper (MSO) that could handle the threat presented by magnetic influence mines. These requirements were realized in the wooden-hulled MSO. To maximize MCM flexibility the Navy also added

coastal minesweepers (MSC), the majority of which were transferred to North Atlantic Treaty Organization (NATO) allies, as well as dedicated coastal minehunters (AMCU). In addition, MCS were developed that could carry the smaller minesweeping boats (MSB) and minesweeping launches (MSL) for use in shallow waters. In 1952, the first tests were performed using helicopters to tow standard minesweeping gear. However, this investment in MCM spurred by the lessons of Wonsan was not sustained. Within a decade, MCM initiatives started to fall victim to a tighter Navy budget as well as to the greater priority assigned to mine research in preference to MCM. Although the primary center for MCM research and development was located at Panama City, Florida, other laboratories also developed MCM technology as an adjunct to their own missions. Even though the laboratories were aligned under a single Director of Naval Laboratories in 1966, there was redundancy in some of the research, including the pursuit of approaches that had already failed in other laboratories (Melia 1991).

F. VIETNAMESE CONFLICT (1965–1973)

In the Vietnam conflict the emphasis of MCM moved to inland waterways. As a result, MCM was no longer viewed as a significant element of naval warfare. While significant advances were made in riverine MCM, this was at the expense of the ocean MCM capabilities. Indeed the MSOs had been delegated to perform the collateral task of coastal patrol and by the late 1960s were in considerable disrepair. Furthermore, the costs of the Vietnam conflict left no funds available for a plan to replace the MSOs. Attempts to refurbish and modernize the MSOs ran into financial problems with work completed on only 20% of the ships. This increased the interest in AMCM using helicopters to sweep for mines to protect the surface MCM vessels. Unlike a surface MCM vessel, the helicopter would not be vulnerable to sensitive mines. However, helicopters were not a panacea. They required considerable support, not just of the helicopters themselves but also the surface component – the sweep sled – towed by the helicopter. There were also operating restrictions on the helicopters, including weather and atmospheric conditions, as well as problems such as rotor noise triggering sensitive mines. Early helicopters in the AMCM role also suffered from overheating due to the nature of their operations (Melia 1991).

Nevertheless, shortly after Admiral Elmo R. Zumwalt became CNO in 1970, he decided to scrap the surface MCM capability, seeing it as financially unsupportable, and to replace it exclusively with an AMCM capability using helicopters. This was in spite of the lessons learned at Wonsan, which had shaped the surface MCM capability, and in spite of the fact that the exclusive use of helicopters in an AMCM role was still in the developmental phase. Nevertheless, plans proceeded and the AMCM capability was fielded and put to the test. The first test was the clearing of U.S. mines in North Vietnamese waters following the signing of the Cease-Fire Protocol in Paris in January 1973. However, these AMCM sweeps were primarily “check” sweeps. Before mining North Vietnamese waters, the U.S. knew it would ultimately have to make the mines safe. Therefore, features were built into the majority of the mines either to self-destruct or to go inert after a specified time. Also, only magnetic influence mines were used and their settings were known. Therefore, this exercise cannot be considered representative of what would be required to sweep a minefield laid by an adversary. Only one mine was triggered by the AMCM sweeps during this mine clearing operation. Perhaps of more significance, this operation was only possible with the support of surface MCM vessels, amphibious mother ships, and a strong logistics chain. The second test was the clearing of the Suez Canal following the October 1973 Arab-Israeli War. In this effort, AMCM assets swept 120 square miles of the Suez Canal in just over a month but did not activate a single mine. In comparison, a U.S.-led multi-national EOD team cleared 8,500 pieces of underwater ordnance in eight months. As in North Vietnam, the Navy declared the AMCM effort in the Suez Canal a resounding success although, once again, considerable resources were required to support the operation and its real effectiveness was unknown. The one aspect of Admiral Zumalt’s initiative that does appear to have been extremely successful was the coordination of the operations that now fell under a single two-star commander, Commander MIW Force (COMINEWARFOR) who was in charge of all MCM assets (Melia 1991).

G. POST-VIETNAMESE CONFLICT (1974–1983)

Ironically, in the new position of COMINEWARFOR, Admiral McCauley recognized the limitations of AMCM and recommended the pursuit of a balanced surface and

air MCM fleet supported by an MCM research program. However, the impression in the U.S. was that the surface MCM capability had been completely replaced by AMCM so Admiral McCauley's recommendation never gained traction. By 1975, as a result of Admiral Zumwalt's decision to move to an exclusive AMCM capability, the surface MCM capability was decimated. With the loss of the surface capability, many officer billets and the MCM career structure also vanished. The only real benefit of Admiral Zumwalt's change – a unified command structure for MCM – did not survive his successor, Admiral Holloway. The MCM responsibilities were distributed to the various fleet and force commanders and the position of COMINWARFOR was replaced by Commander MIW Command (COMINWARCOM) that performed an advisory and liaison role. The MCM capabilities that remained in the Navy after 1975 were fractured and dispersed and the Navy would be forced to improvise if faced with a serious MCM challenge. So, as in previous eras, a period was entered during which MCM capabilities would stagnate while advances continued to be made in mine capabilities. These advances in mine technologies occurred both in the Soviet Union and in the U.S. The Soviets not only developed new influence mine actuating systems but also used microprocessors to make mines more selective of their targets and they changed the appearance of mines to make them more difficult to detect visually in shallow water. Soviet rising mines moved the threat of mines into deeper water. The U.S. also developed a deep-water mine in the form of a moored mine that would release a homing torpedo (Melia 1991).

By 1976, the threat of deep-water mines led to the approval for the design of a steel-hulled, deep-MSO-hunter that would complement the shallow-water capability of the AMCM helicopters; however, political delays killed the program. The next recommendation went in the other direction with the move to an amphibious mother ship that would carry MSBs and MSLs. However, this too was not achieved. Each of these initiatives covered only a part of the required MCM spectrum that had been identified following the lessons learned from Wonsan. By 1979 the CNO, Admiral Thomas B. Hayward, called for “integrated minehunting and clearance systems on a number of different platforms at much lower cost and size” (Melia 1991). This would include a deep-ocean MCS that would replace the almost 30-year old MSOs. The MCM would include an auton-

mous MNS in the form of a remotely operated vehicle (ROV) for minehunting. To complement the MCMs, a smaller coastal minesweeper hunter (MSH) was also proposed. While waiting for decisions on this proposal, Admiral Hayward instructed COM-MINEWARCOM to develop the Craft of Opportunity Program (COOP). This would use shrimp boats that were configured for deep-water trawling, but re-equipped to operate the influence minesweeping equipment from the decommissioned MSOs and the mechanical sweep equipment from former MSCs. The COOP program would provide a reserve harbor defense program for home ports (Melia 1991).

In 1981 the Navy finally committed to a new shipbuilding program to re-equip the surface MCM forces. This would include the Avenger class deep-water MCM ships and the Cardinal class MSH ships. Unfortunately, the Navy had fallen behind its NATO allies both in fiberglass ship building technology and small-boat minesweeping systems. France, in particular, had developed sophisticated minehunting and mine-neutralizing ROVs. Nevertheless, U.S. industry had developed ROVs for the offshore oil industry. The MNS proposed for the MCM 1 ships would draw on this domestic and foreign technology to use sonar and video sensors to locate, classify, and neutralize mines. The MCM 1 would be capable of deep-water mechanical minesweeping and would also have the minehunting capabilities provided by the MNS. This would be supplemented by advanced minehunting sonar, precise integrated navigation system (PINS), and high-definition surface-search radar. The MCM 1 would be of wood-laminate design encased in fiberglass. In contrast, the Cardinal class MSH would be a fiberglass surface-effect ship using air-cushion technology for minehunting and minesweeping in coastal waters. Because the techniques for constructing MCM ships had been lost in the U.S. during the thirty years since the last major MCM ship construction program, many techniques had to be relearned and advances in fiberglass construction needed to be taken from allied nations as well as from U.S. industry. The MCM 1 ships experienced significant production delays and development of the Cardinal class MSH was eventually abandoned due to hull delamination problems. In place of the Cardinal class MSH the Navy settled on the Osprey class coastal minehunter (MHC), based on the design of an existing Italian MCM ship, Lerici. Once again, the lack of continuity of the U.S. MCM program led to the need

for reinvention and progress in a series of revolutionary steps rather than following a continuous process of evolution. At the same time that the MCM 1 and Osprey class MCH programs were getting underway, the AMCM helicopter capability was being maintained. However, this program still lacked a dedicated support ship and this made it difficult to provide training for the AMCM crews (Melia 1991).

The move to use a balanced surface and airborne MCM capability was supported by an EOD capability. The role of the EOD MCM detachments was critical in rendering mines safe and recovering them for disassembly and evaluation. This was a short turn around operation to provide information to the MCM commander to counter the minefield in question (especially if minesweeping was to be conducted with surface vessels). EOD MCM detachments also had the capability to use explosives to disable mines (Naval Mine Warfare Engineering Activity 1991).

H. MIDDLE EAST (1984–1990)

Before the new MCM and MHC ships came on line, the Middle East again became the focus of attention. In the summer of 1984 more than a dozen merchant vessels were crippled by underwater explosions in the Gulf of Suez. As part of the international response, the U.S. provided AMCM helicopters supported by amphibious transport docks (LPDs). The detachment that deployed to the Red Sea performed the first operational deployment of the towed AN/AQS-14 minehunting sonar. No mines were located so, without ground truth, the performance of the minehunting sonar was inconclusive. Repeated sweeps by the AMCM helicopters showed that the area was free of mines. However, other elements of the international forces found and cleared mines. The mines, believed to have been laid by the Libyans, included at least one type of an advanced influence mine based on a Soviet design. The ease with which this mining operation had occurred made MCM a matter of international concern. Not only were lessons relearned regarding the importance of national airborne, surface, and subsurface MCM forces, but this operation also highlighted the importance of coordinating international MCM forces. Throughout the 1980s, with the continuing war between Iran and Iraq, the Persian Gulf became littered with mines. Many of these were North Korean manufactured M-08 contact mines

from a 1908 Russian design, of which a significant number broke free of their moorings and threatened to destroy U.S. warships (Melia 1991).

To protect commercial shipping in the Persian Gulf, half of Kuwait's tanker fleet was reflagged under the American flag to enable them to be escorted by the U.S. military. On 24 July 1987, the first such convoy was steaming toward Kuwait when the supertanker SS Bridgeton hit an M-08 mine. With advanced knowledge of the route and timing of the convoy, the Iranians had mined the path. In response, the U.S. diverted considerable MCM assets to the Persian Gulf including a detachment of eight RH-53D AMCM helicopters. The AMCM helicopters were supported by a couple of amphibious assault ships (LPHs) but these ships were hard pressed to accommodate them due to the large amount of deck space required for the support equipment. Four MSBs that were also deployed to clear mines were unsuccessful in their task. However, six of the limited number of MSOs still remaining in the U.S. Navy were deployed to the Persian Gulf and were successful. Their operational use matched the role for which they had been designed—minehunting and minesweeping of established convoy routes. Minehunting was performed using sonar and industrial ROVs were used with limited success to identify MLCs. However, mine neutralization relied on EOD divers. During these operations, the MSOs only found contact mines. Nevertheless, these operations provided an opportunity for the operational testing of several minehunting and mine identification MCM initiatives. The operations also allowed an organizational structure to be put in place to coordinate both U.S. and international MCM operations. Once again, the Navy relearned the vulnerability of ships to mines and the value of properly coordinated operations. However, even with the limited use of mines employed by the Iranians, all of the Navy's MCM assets were occupied. This period of MCM activity also showed the value of preventing mine laying in the Persian Gulf, with this being both an all-Navy and joint service combat operation. Without this approach, the number of mines that needed to be cleared would have been considerably larger (Melia 1991).

I. OPERATION DESERT STORM (1991)

To provide MCM support for Operation Desert Shield, following the Iraqi invasion of Kuwait in August 1990, the first of the MCM 1 ships together with three of the remaining MSOs, were sealifted to the Persian Gulf. Once Operation Desert Storm commenced in January 1991, the U.S. MCM forces cleared a channel toward Kuwait in preparation for the amphibious assault force. However, on 18 February 1991, mines damaged two U.S. Navy warships supporting the MCM operations. The amphibious carrier Tripoli (LPH-10) struck a moored contact mine while the guided-missile cruiser Princeton (CG-59) detonated an influence mine under her keel. That these two warships had encountered mines in waters believed to be free of mines, underscored the lack of MCM capability (Melia 1991).

J. AFTER OPERATION DESERT STORM (1992–2014)

The period following Operation Desert Storm also coincided with the fall of the Soviet Union and the end of the Cold War. The nature of the threat faced by the U.S. changed significantly from a stand-off against another super power to a proliferation of smaller, but worldwide, threats that would need to be countered. In the abstract to his paper Lluy (1995) states

NATO's capability to meet these challenges will depend largely on its ability to reorient its focus toward the requirements necessary to train and maintain a first-rate MCM rapid deployment force. As a leader within NATO, the United States Navy must assume the lead in forging multinational transatlantic MCM forces capable of dealing with any global mining contingency. (1)

Following Operation Desert Storm, the U.S. Navy and Marine Corps produced a series of MIW Plans (DON 2000). The first edition was published in 1992 and was a direct response to lessons learned during Operation Desert Storm. In particular, development efforts to improve shallow water MCM operations were emphasized. In 1994 the second edition not only outlined developments in mine surveillance and reconnaissance, but also developments in remote MCM. In the third edition in 1997 the status of the previous development efforts were updated but this edition also introduced the MIW “Concept of Operations and the architecture upon which the future mine warfare capability

would be built” (4). The fourth edition of the MIW Plan published in 2000 continued to provide updates on both mining and MCM developments but went much further by building on the 1998 “Concept for Future Mine Countermeasures in Littoral Power Projection” (Marine Corps Combat Development Command and Naval Doctrine Command 1998), a concept document looking at the 2010-2015 time frame. As a result, the fourth edition of the MIW Plan also highlighted “the shift towards an organic, in-stride MCM capability” and the “Fleet Engagement Strategy, which will establish the culture needed to create the awareness, knowledge, and proficiency required to successfully ‘mainstream’ mine warfare and prepare for the uncertainties of the future” (DON 2000, 4). The fourth edition of the MIW plan claims to represent “a revolution in the naval operational art of Mine Warfare for the new millennium” (DON 2000, 4).

Nevertheless, no new surface MCM ships have been introduced into the U.S. Navy during this time period. Although it would be difficult, if not impossible, to measure how the U.S. naval MCM capabilities have changed in absolute terms, the history presented by Melia (1991) provides evidence for a subjective assessment of how MCM capabilities relative to the threat have evolved that would look something like the graph shown in Figure 77.

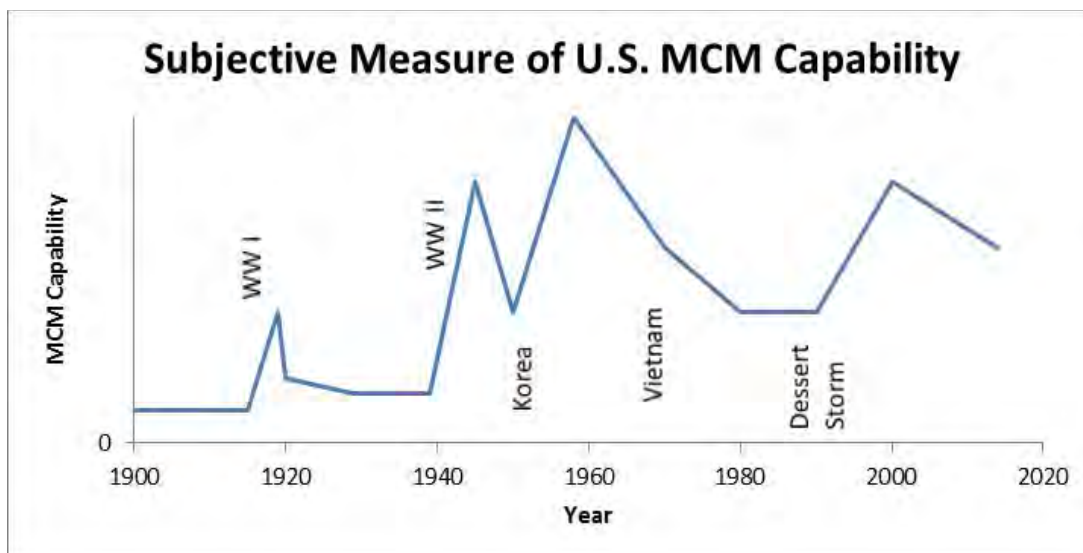

Figure 76. Change in U.S. MCM Capability Over Time (after Melia 1991)

Although Melia (1991) indicates that capabilities have generally increased during times of conflict and then decayed during time of peace, it seems that the U.S. capabilities reached a peak in the decade following the Korean War, both in terms of MCM systems and operational capability. The focus on riverine MCM during the Vietnam conflict and subsequent neglect of a surface MCM capability during the 1970s resulted in a significant decline in capability. Even though this trend was reversed, to some extent, with the introduction of the MCM 1 at the end of the 1980s—the first new MCS since the 1950s (Naval Mine Warfare Engineering Activity 1991)—that capability is now aging. The U.S. Navy will need a replacement system, currently envisioned as the LCS with the MCM Mission Package, before its MCM capability can expect to improve.

APPENDIX B. OVERVIEW OF MANA AND EXTENDSIM

This appendix presents details of MANA and ExtendSim, as evaluated by the MIW Team for use in this study. An overview and description of both modeling packages can be found in Chapter IV. This appendix includes the MIW Team's assessment of the utility of MANA and ExtendSim for this particular study (including both advantages and disadvantages), as well as recommendations for the usage of ExtendSim with respect to this study.

A. MANA OVERVIEW

This section describes the MANA software tool. It includes the advantages and disadvantages for the use of this tool in this Capstone project.

1. Evaluation for Utility in Capstone Study

The MANA software was evaluated for its utility in the capstone study at the start of the Modeling and Simulation phase. The MIW Team initially planned to use ExtendSim (Diamond 2007) based on previous experience with ExtendSim during the Capabilities Engineering course but was made aware of MANA as a possible alternative. The evaluation was relatively informal with no particular metrics. Several members of the team examined the tool, looking primarily for characteristics like applicability to the problem, ability to support probabilistic modeling, ease-of-use, ease-of-learning, and completeness of the documentation. Several advantages and disadvantages were identified and compiled regarding MANA and its suitability for use in the development and execution of the planned modeling activities, both in absolute terms and in comparison to ExtendSim. The review was based primarily on the available user documentation because the limited time that could be devoted to selecting the modeling tool precluded an extensive review including the construction of models in MANA and ExtendSim for direct comparison.

2. Advantages of MANA

MANA's greatest strengths lie in the visual aspects of the program. By default, a graphical representation of the model output is produced that can be viewed as the model executes to check for anomalous behavior to ensure the model has been built correctly. In particular, the graphical representations in MANA include icons moving on a map that facilitate an understanding of the model behavior, not just for the users of the model but also for communicating the results to stakeholders. Although ExtendSim has a 3-dimensional (3-D) animation capability, this has to be coded into the model and the team has no prior experience with this feature.

Human decision-making is an interesting feature of MANA. The model can even permit the entities involved to make mistakes or choose sub-optimal responses to stimuli. This would be invaluable in capturing the human element of MCM, in training, personality, and psychological states; however, this is not the focus of the study, and was therefore deemed not of significant value.

The genetic algorithms in MANA can help determine an optimal response to a situation, though the lack of an automated stop feature means the simulation must constantly be monitored. MANA can also model force-on-force operational scenarios in which MCM plays a role to evaluate the contributions of MCM to an overall naval operational situation; however, as neither of these are the focus of the study, they are considered of limited utility.

More useful is MANA's ability to model communications and share situational awareness between entities and units. Much of MCM relies on transferring information about mine locations and status to the different systems that operate in subsequent stages of the minehunting and minesweeping operations. Due to the focus of this study being on just the LCS and its assets as compared to the MCM 1 and its assets, this is likely to be a secondary concern; however, it would be extremely useful in modeling MCM operations in a group with other types of ships, for example, when clearing a lane for merchants or other members of a group to pass.

The MANA software also handles expendables, such as fuel and ammunition. These can also be used as stand-ins for other expendables, such as food, spare parts, alertness levels / fatigue, etc., although doing so requires using the model in ways it was not originally intended. This can be done just as easily and more explicitly in ExtendSim, however, so this benefit of MANA does not provide an advantage over ExtendSim.

3. Disadvantages of MANA

There are many areas in which MANA was found to be insufficient for use in this M&S project. First, and most significant, is the uncertainty in the underlying models and algorithms. Without confidence in the mechanics programmed into the tool, unexpected results occur, which further damages confidence. The documentation, which is of a different version than the program itself, also warns about unexpected behaviors due to problems peculiar to the model. This coupled with the lack of experience of the MIW Team increases the risk of undesirable behaviors.

To obtain the desired behaviors, it is often necessary to “trick” the model. That is, to use a parameter for an unintended use while completely ignorant of the underlying model, or to experiment with factors until the desired results emerge, without really knowing what other factor changes will do to the validity of that result. In contrast, within ExtendSim, the user constructs a specific model from primitive components to explicitly define behavior rather than manipulating the behavior of an existing model by changing model parameters.

Executing a DOE is also difficult in MANA. Although it has a multi-run capability that can be set to vary certain variables, this capability is limited, and does not allow for importing a DOE for execution. Due to the limited information on actual system performance parameters available for the study, the model being created would rely on using ranges of factors and identifying critical points and factors of relatively large statistical significance to come to conclusions. Therefore, MANA’s limited ability to effectively ingest a DOE for execution is considered a critical failing.

MANA utilizes a single built-in MOE for its modeling. This MOE is run length, which can be controlled to some extent by setting one of a number of stop criteria. Be-

cause these stop criteria are also preexisting, this leads to inadequate control of the MOE. Although the primary MOE of the MIW study was clearance time, which seems compatible with the MANA run length MOE, without the ability to make more refined choices about the identity and definition of the MOE and any criteria for triggering it, MANA is unsuitable for use.

Probabilistics in the MANA simulation are rudimentary. Using advanced mode settings; some probability distributions can be defined, such as probabilities of detecting targets at particular ranges. However, for more complicated statistics, the user cannot simply specify a distribution and the parameters that define it. The user could calculate the probabilities at each range that describe the distribution desired, so the problem is not insurmountable, but it is an inconvenience. Additionally, it is impossible to add conditionals to the probability distributions, which decreases the sensitivity and flexibility of the MANA model.

The construct of MANA is set and has predetermined steps, functions, stages, and order of these; therefore, it is not possible to insert new functions or steps. Most critically for this assessment, MANA only provides the detect and classify steps, but there is no identification step. MCM goes through several stages of detecting, classifying, identifying, reacquiring as needed, selecting appropriate responses based on the results of each stage. While it may be possible to force some behaviors into the MANA construct, it is not likely to be able to accommodate all of them.

Motion is modeled via a stair-step in MANA, with adjustments to speed to compensate for the difference between modeled track and intended track. The track itself is modeled via probabilistic methods not fully described. Additionally, there is uncertainty in the location of the players, which may be relatively small or large depending on the total size of each grid square. Maximum grid size is 1000 by 1000 squares, which means that for a mission clearing an area 20 NM by 20 NM, each square is 0.02 NM or about 40.5 yards on a side. Given probable detection and detonation ranges for many mines, this is likely inadequate resolution. For a smaller area, the problem is less pronounced, however one of the key problems in MCM is clearing large volumes of water with unknown numbers of mines. MANA appears limited in its ability to handle this problem.

Finally, the team had never handled MANA at the start of the project, so there was a learning curve that had to be addressed. While relatively simple and straightforward, the lack of familiarity and the required learning time made MANA less preferred when compared to known tools such as Excel or ExtendSim.

4. Recommendations for MANA Use

MANA was not chosen for use in this project as the primary modeling program. There were numerous technical drawbacks and the lack of user familiarity impacted the ability to work around these issues.

Despite these drawbacks, MANA does have some significant benefits, especially in communication with stakeholders and advisors. Therefore, it was recommended that a few members of the team work on attaining some level of familiarity with it to be able to spot-check certain results and create visualizations of critical findings for communication to interested parties as the study progressed.

B. EXTENDSIM DESCRIPTION

This section describes the ExtendSim software package. It also provides the results of the evaluation conducted by the MIW Team for use in this Capstone project. The detailed overview of the software is included in Chapter IV.

1. Evaluation for Utility in Capstone Study

ExtendSim is a software tool for modeling. It uses a GUI and control boxes to allow users to build simulations without having to learn any programming languages. It enables users to create simulations of some complexity, involving various pre-built functions and behaviors commonly used in modeling, such as queuing, selections, and computations. Many functions are mathematical or logical functions, allowing it to be applied to many potential modeling problems. It can implement either time-based or event-based modeling.

2. Advantages of ExtendSim

The advantages for using ExtendSim are primarily a result of the flexibility in configuration that this package allows. Many variables can be defined and included through the use of databases that allow the user to develop the values associated with each variable off-line and then copied into the input databases. This allows for more efficient running of the simulation in a batch mode, in which the values of the input parameters (variables) for every simulation run are preloaded into the database. This permits many runs to be completed without further user interaction. This feature allowed for the extensive analysis that used the factor levels defined through the DOE process.

ExtendSim also allows users to pass the model input parameters, which may be deterministic or probabilistic in nature. This was a critical feature in tool selection, due to the limitations in the source data imposed by natural variations and the classification of the real-world data. This capability in ExtendSim enabled modeling within ranges of parameters deemed reasonable by the team and the SMEs.

Additional critical capabilities of ExtendSim were the abilities to accept and output tabular data. Model parameters that traced their existence back to the physical and functional decompositions of the MCM process DOE combinations to be fed into the model through its built in database tables. The model was designed to output certain calculations of interest, particularly for performance measures, but also for troubleshooting and verification and validation (V&V) purposes. ExtendSim allows outputs to be written into data tables inside its database, which additionally makes such outputs easily importable to Minitab for statistical analysis.

3. Disadvantages of ExtendSim

ExtendSim does not have very much graphical capability. The GUI is comprised mostly of function blocks, with options to turn on an indicator that shows entities moving through processes, which is mostly used for error checking and examination of data flows. It can also generate graphical reports on results much like Excel charts. Beyond this, however, it lacks the graphical or iconic depictions that might make it more comprehensive to stakeholders or the casual user.

The MIW Team determined that ExtendSim is not specific to the types of problems it can solve; however, many more steps may be involved in producing a model that a more naval warfare-centric tool could produce natively. By contrast, this also enabled creative approaches to problem solving and a large amount of tailoring of the model to focus on specific study questions, rather than using some other tool and modifying it to suit the purposes of this study.

4. Recommendations for ExtendSim Use

ExtendSim was selected as the modeling tool for this project due primarily to the flexible way that the input parameters could be varied. Additionally, the prior experience of the MIW Team with this tool made the learning curve much more palatable, which was extremely important given that the project's timeline did not leave much time for the MIW Team to learn to use a new tool.

C. SIMULATION TOOL RECOMMENDATION

After a review of both simulation development tools, ExtendSim was selected over MANA for use in this project. There are beneficial features of MANA that do not exist within ExtendSim that may prove useful for additional MCM studies, but these did not exceed the benefits of using ExtendSim within this study.

THIS PAGE INTENTIONALLY LEFT BLANK

APPENDIX C. SIMULATION OVERVIEW

This appendix provides details on how to properly run the models and includes an overview of the input tables. Details are also provided on how to configure the models for particular legacy configurations, as well as how to configure the models for different types of simulations (repeated runs or multiple runs with varied inputs).

The model has been built using ExtendSim Version 8 and this is the version of ExtendSim that should be used to execute simulation runs. The simulation runs are set up and executed from the options under the Run menu within ExtendSim, the top portion of the Run menu is shown in Figure 78. The simulation is executed by selecting Run Simulation (the first option on the Run menu) but before this is done it is important to make sure the simulation is set up correctly. This is done by selecting the “Simulation Setup...” option from the Run menu, shown in the red box of Figure 78.

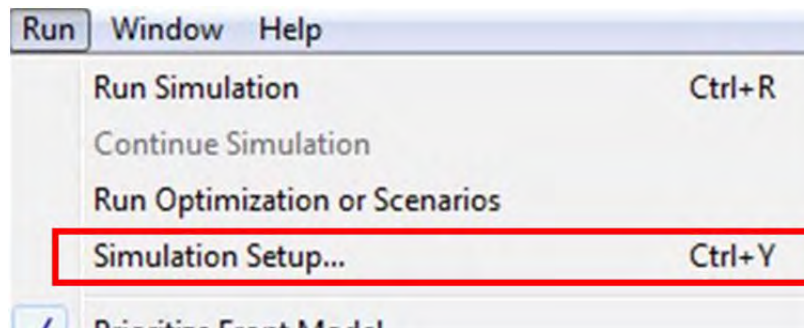

Figure 77. ExtendSim Run Menu

Under the Simulation Setup option, the Setup tab should be selected and this will appear as shown in Figure 79. Care should be taken to make sure that the data fields are set correctly, in particular; Start time, End time, Runs, and Global time units. Each of these is described in this section.

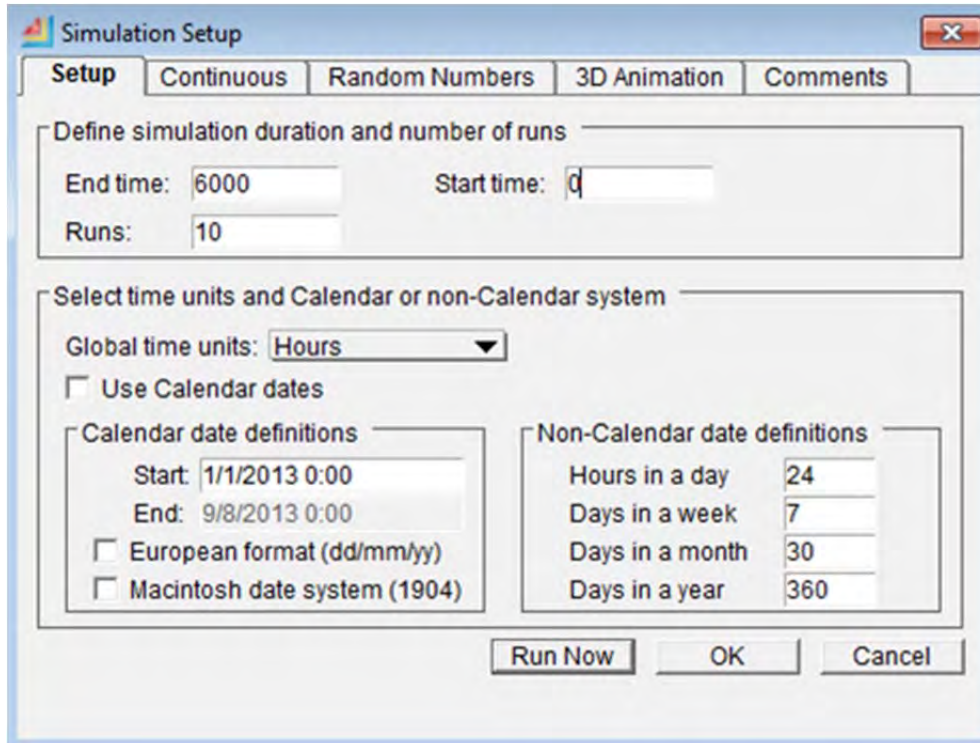

Figure 78. ExtendSim Simulation Setup Table

- Start time: This should be left at its default value of zero
- End time: This should be set to a large enough value to permit all of the targets (mines and non-mines) to be processed by the MCM systems. Some combinations of input parameter values may lead to very inefficient progress through the target area and the end time of the simulation may be reached before all of the targets in the target area have been processed. For example, this could happen with very low transit or search speeds or a high number of tracks per nautical mile, but other parameters may also have an effect. The Hunt Effectiveness output data table should be examined after running the simulation to make sure that all of the targets have been accounted for in the eleven possible output categories. The total number of mines and non-mines across the different output categories (six categories for mines and five categories for non-mines) should match the total number of mines and non-mines specified by the input parameters (note: the values of these input parameters are also written to the Hunt Effectiveness output data table).
- Runs: This should be set to the total number of runs desired. In the case of repeated runs in which the same input parameters are used for every run, this setting will determine how many times that simulation run is repeated. The model may also be used to execute multiple stacked runs where each successive run reads in the next successive row of data in the input data

tables. This would be used in a DOE in which input parameters are varied from one run to the next. For these types of simulation runs it is imperative that the number of runs specified in the runs field is matched by the equal number of rows in the input data tables.

- Global time units: For these models the global time units should be set to “Hours.”

Depending whether an ExtendSim model is going to be used for a set of repeated runs, or whether it is going to be used to execute a set of multiple different runs as part of a DOE, the model needs to be configured differently. In other words, these different run options cannot be controlled from the ExtendSim run menu, but require modifications within the model itself to structure how the input data are read into the model. For both the legacy MCM model and the future LCS model, all of the modifications occur within the block labeled Set Initial Conditions at the top-level of the model. The structure of the Set Initial Conditions block is the same for both the legacy MCM model and the future MCM model and is shown in Figure 80.



Figure 79. Structure of the Set Initial Conditions Block

Within the set initial conditions block, all the modifications occur within the Create Targets block. Again, the structure of this block is the same for both the legacy MCM model and the future MCM model and is shown in Figure 80. Within the create targets block, changes are necessary within the create non-mines, create mines, and assign attributes blocks. The configuration of these blocks for the different types of simulation will be described in the following sections. It was decided to maintain two versions of the legacy MCM model and two versions of the future MCM model. In each case one model is configured for single or repeated runs while the other is configured for DOE. The models that are configured for DOE runs include “DOE” in the model name.

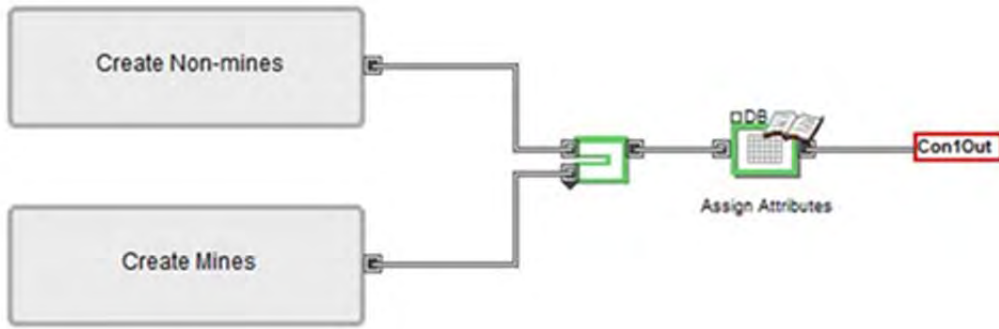

Figure 80. Structure of Create Targets Block

A. SINGLE AND REPEATED RUNS

- Configuration of Assign Attributes Block: For single and repeated runs the read data tab should be configured to always read the first record (first row) of the input data tables, as shown in the highlighted area of Figure 82.

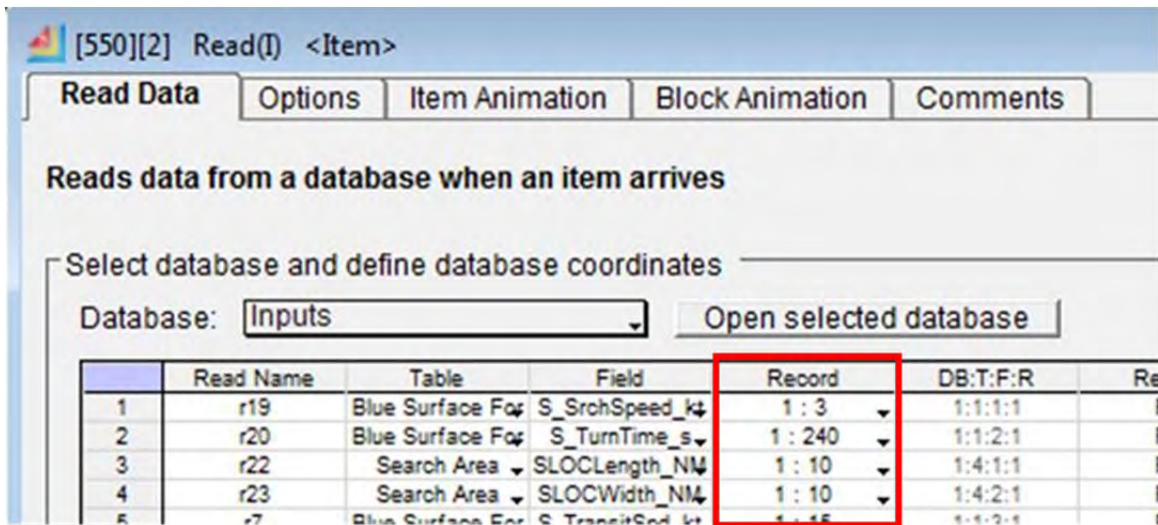

Figure 81. Assign Attributes Block, Read Data Tab—Single or Repeated Runs

- Configuration of Create Non-mines and Create Mines Blocks: Within both the create non-mines and the create mines blocks, the first component is an ExtendSim read block that is used to read in the number of non-mines and the number of mines, respectively, from the input data tables. For single and repeated runs the number of non-mines and mines only needs to be read in once. Therefore, on the options tab, the check-box “Record index

is equal to run number” should not be checked—see highlighted area in Figure 83.

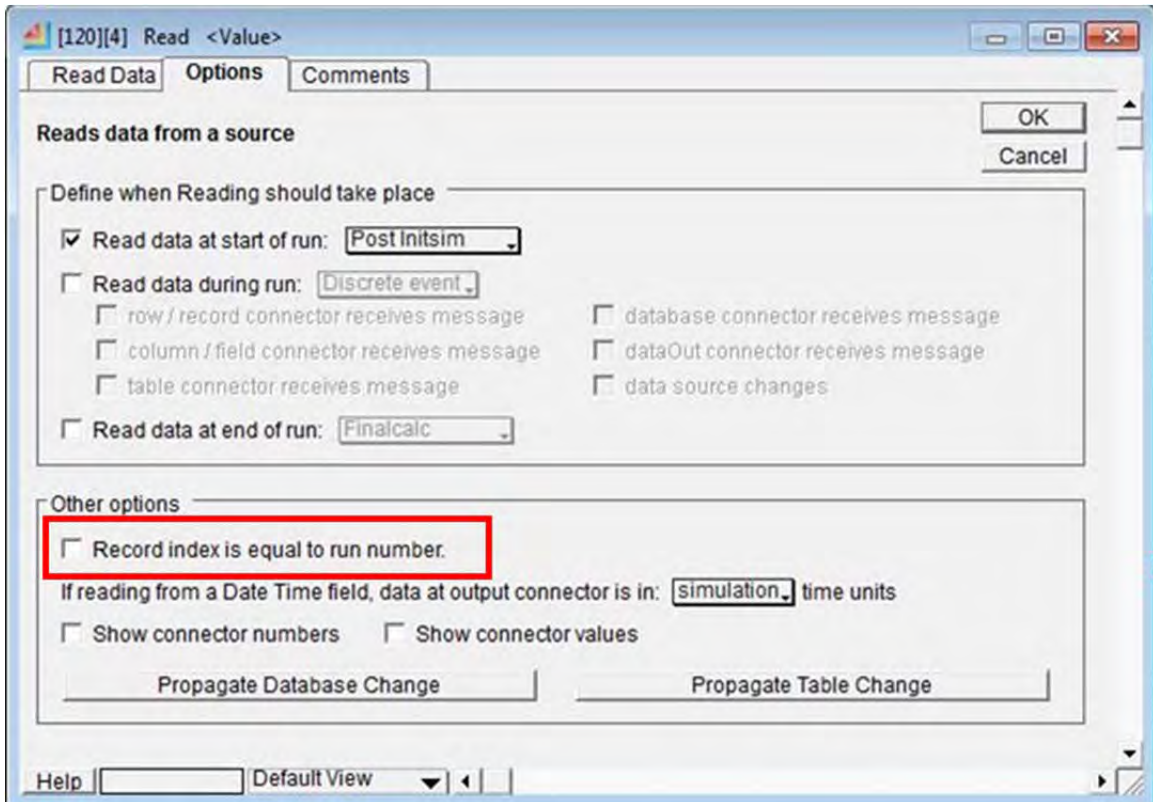

Figure 82. Read Block, Options Tab—Single or Repeated Runs

B. DESIGN OF EXPERIMENTS OR MULTIPLE RUNS

- Configuration of Assign Attributes Block: For DOE runs the read data tab should be configured to always read the record (row) of the input data tables corresponding to the current run number, as shown in the highlighted area of Figure 84. For DOE runs it is also imperative that the number of runs specified in the simulation setup option of the run menu is matched by the same number of rows in the input data tables.

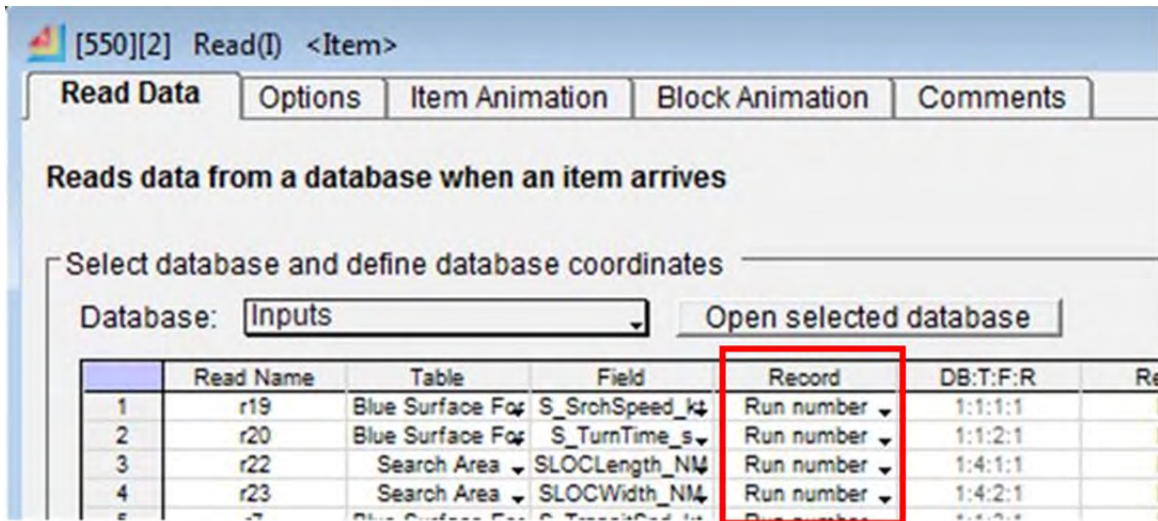

Figure 83. Assign Attributes Block, Read Data Tab—Multiple or DOE Runs

- Configuration of Create Non-mines and Create Mines Blocks: Within both the create non-mines and the create mines blocks, the first component is an ExtendSim read block that is used to read in the number of non-mines and the number of mines, respectively, from the input data tables. For DOE runs the number of non-mines and mines should be read in for each run. Therefore, on the options tab, the check-box “Record index is equal to run number” should be checked—see highlighted area in Figure 85.

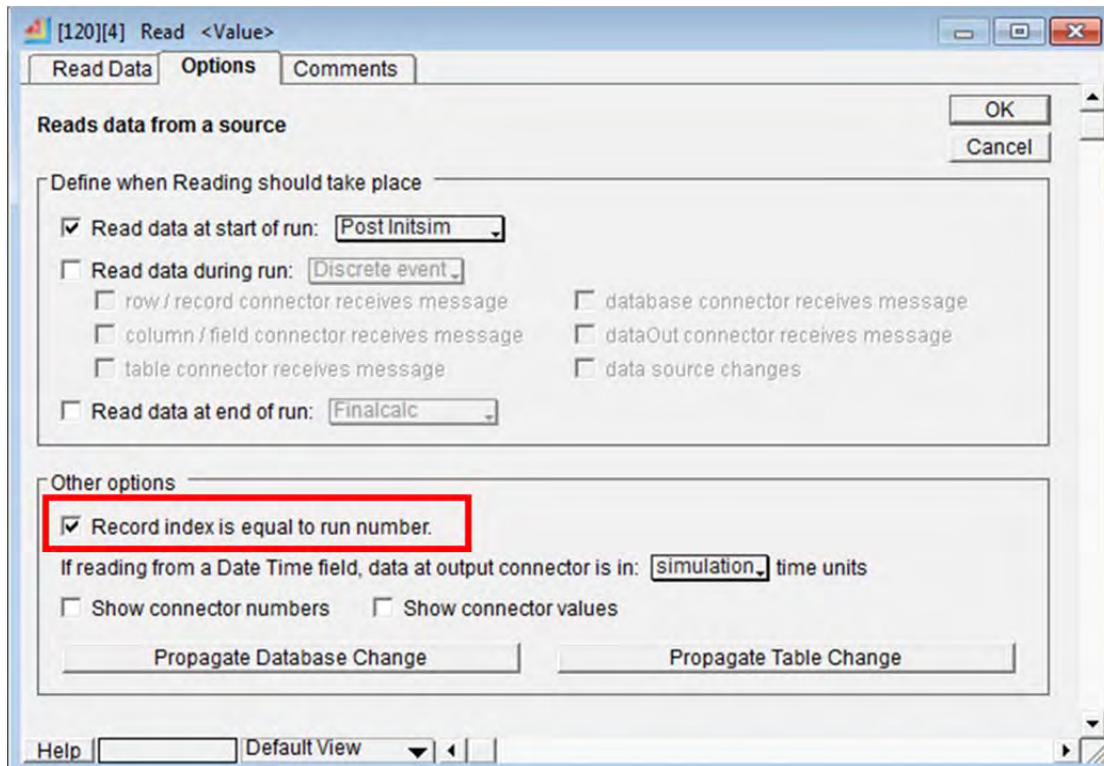

Figure 84. Read Block, Options Tab—Multiple or DOE Runs

C. SELECTING LEGACY MCM MODEL CONFIGURATIONS

Two of the input parameters are used to configure the model of the legacy MCM 1 system to represent the four possible configurations. The setting of these parameters for each of the configurations is shown in Table 67. The input parameter “A_Neutralizer” is in the Blue Airborne Force input data table and the input parameter “S_SeaFox” is in the Blue Surface Force input data table. These settings need to be present in every record (row) in the input data tables.

Table 67. Parameter Settings to Select Legacy MCM Configurations

Configuration	Description	A_Neutralizer	S_SeaFox
1A	Serial Hunt - SLQ-48	0	0
1B	Serial Hunt - SeaFox	0	1
2A	Parallel Hunt - SLQ-48	1	0
2B	Parallel Hunt - SeaFox	1	1

THIS PAGE INTENTIONALLY LEFT BLANK

APPENDIX D. SOFTWARE DESIGN DOCUMENT

As part of the model development, a SDD was written. This appendix provides the table of contents from that document. The purpose of the SDD is to provide details about how the models are configured to allow developers to make modifications to support future analysis efforts. Users of the models may also find the SDD useful to understand the underlying structure.

A. CONTACT INFORMATION

Those interested in receiving a copy of the ExtendSim Models and SDD should contact one of the following personnel:

1. Dr. Eugene Paulo
Professor
Naval Postgraduate School
Monterey, CA 93943-5000
E-mail: eppaulo@nps.edu
Voice: 831-998-2912
2. Paul Beery
Professor
Naval Postgraduate School
Monterey, CA 93943-5000
E-mail: ptbeery@nps.edu
Voice: 831-656-2956

As the SDD was intended to be a standalone document that describes the models, it includes information contained within Chapter VI and Appendix C, but expands the details to include the underlying structure and code of the models. The table of contents from the SDD is below.

B. SDD TABLE OF CONTENTS

- I. Introduction
- II. Description of Models
 - A. Model of Legacy MCM Systems
 1. Concept of Operations
 - a. First Phase of Operations
 - b. Second Phase of Operations
 2. Model Design

- 3. Model Implementation
 - a. Model Hierarchy
 - b. Module Descriptions
 - c. ModL Source Code Listings
 - B. Model of Future MCM Systems
 - 1. Concept of Operations
 - 2. Model Design
 - 3. Model Implementation
 - a. Model Hierarchy
 - b. Module Descriptions
 - c. ModL Source Code Listings
- III. Modeling Assumptions
- IV. Model Inputs
 - A. Blue Surface Force Data Table
 - B. Blue Airborne Force Data Table
 - C. Search Area Data Table
 - D. Red Force Data Table
- V. Model Internal Variables
 - A. Attributes
 - 1. Legacy MCM System Model
 - 2. Future MCM System Model
 - B. Local Variables
 - 1. Legacy MCM System Model
 - 2. Future MCM System Model
 - C. Global Variables
 - 1. General Use Global Variables
 - a. Legacy MCM System Model
 - b. Future MCM System Model
 - 2. User-Defined Global Arrays
 - a. Legacy MCM System Model
 - b. Future MCM System Model
 - D. Connector Values
 - 1. Legacy MCM System Model
 - 2. Future MCM System Model
 - E. System Variables
 - 1. Legacy MCM System Model
 - 2. Future MCM System Model
- VI. Model Outputs
 - A. Hunt Effectiveness Data Table
 - B. Target Outputs Data Table
 - C. History Blocks
- VII. Running the Simulation
 - A. Single and Repeated Runs
 - B. Design of Experiments or Multiple Runs
 - C. Selecting Legacy MCM Model Configurations

- VIII. Verification and Validation
 - A. Definitions
 - B. Verification
 - C. Validation

THIS PAGE INTENTIONALLY LEFT BLANK

LIST OF REFERENCES

- Ailes, John. 2011 November 9. "LCS Mission Modules." [https://acc.dau.mil/adl/en-US/484353/file/61420/LCS Mission Modules.pptx](https://acc.dau.mil/adl/en-US/484353/file/61420/LCS%20Mission%20Modules.pptx)
- Alperen, Martin J. 2011. *Critical Infrastructure Protection, in Foundations of Homeland Security: Law and Policy*, John Wiley & Sons, Inc., Hoboken, NJ, USA.
- Amador, Brian. 2011. "US Navy Funding Goals for Future Mine Warfare Capability." Presented at the 16th Annual Expeditionary Warfare Conference, Wyndham Bay Point Hotel, Panama City, FL, October 24.
<http://www.dtic.mil/ndia/2011expwar/MondayAmador.pdf>.
- Bahr, James D. 2007. "Damn! The Torpedoes: Coping with Mine Warfare in the Joint Maritime Environment." PhD diss., Naval War College.
<http://www.dtic.mil/dtic/tr/fulltext/u2/a470742.pdf>.
- Blanchard, Benjamin S., and Wolter J. Fabrycky. 2011. *Systems Engineering and Analysis*. Upper Saddle River, NJ: Pearson.
- Broughton, Buzz, and Jay Burdon. 1998, May. "The Revolution of Mine Countermeasures." *Proceedings Magazine* 124(5).
<http://www.usni.org/magazines/proceedings/1998-05/revolution-mine-countermeasures>.
- Buede, Dennis M. 2000. *The Engineering Design of Systems: Models and Methods*. New York: Wiley.
- Committee for Mine Warfare Assessment. 2001. *Naval Mine Warfare, Operational and Technical Challenges for Naval Forces*. Washington, DC: National Academy Press. http://www.nap.edu/catalog.php?record_id=10176.
- Craggs, Ryan. 2013. "USS Guardian Shipwreck: Navy Ship Removed From Philippines Reef." *The Huffington Post*, March 31.
http://www.huffingtonpost.com/2013/03/31/uss-guardian-shipwreck-navy-ship-removed-philippines-reef_n_2988694.html.
- Crisp, Harry E. 2007. "Systems Engineering Vision 2020." Technical paper no. INCOSE-TP-2004-004-02. 2.03 ed. International Council on Systems Engineering.
https://www.incose.org/ProductsPubs/pdf/SEVision2020_20071003_v2_03.pdf
- Department of the Navy. 2000. *U.S. Naval Mine Warfare Plan, Programs for the New Millennium*, edited by Adm. Jay L. Johnson and General James L. Jones. Washington, DC: Department of the Navy.

- Diamond, Bob. 2007. "ExtendSim User Guide, Version 7." Rep. ExtendSim User Guide, Version 7. San Jose, CA: Imagine That Inc.
- . 2010. *Navy Warfare Publication: Naval Mine Warfare* Vol. 1. NWP 3-15. Norfolk, VA: Navy Warfare Development Command.
- Erickson, Andrew S., Lyle J. Goldstein, and William S. Murray. 2009, June. "Chinese Mine Warfare: A PLA Navy 'Assassin's Mace' Capability." Naval War College, China Maritime Studies. http://www.usnwc.edu/Research---Gaming/China-Maritime-Studies-Institute/Publications/documents/CMS3_Mine-Warfare.aspx
- Griner, Joel T. 1997. "The Paradigm of Naval Mine Countermeasures: A Study in Stagnation." Master's thesis, United States Marine Corps, Command and Staff College, Marine Corps University. <http://www.dtic.mil/dtic/tr/fulltext/u2/a529191.pdf>
- INCOSE, 2010. *Systems Engineering Handbook: A Guide for System Life Cycle Processes and Activities*. Edited by Cecilia Haskins, Kevin Forsberg, Michael Krueger, David Walden, and R. Douglas Hamelin. Publication no. INCOSE-TP-2003-002-03.2. Version 3.2. INCOSE.
- Lluy, Paul A. 1995. "Mine Warfare; An Old Threat Presents New Challenges for NATO's Post-Cold War Navies." Master's thesis, Naval Post Graduate School, Monterey, CA. <http://www.dtic.mil/get-tr-doc/pdf?AD=ADA305846>
- Marine Corps Combat Development Command and Naval Doctrine Command. 1998, May 1. *Concept for Future Naval Mine Countermeasures in Littoral Power Projection: a 21st Century Warfighting Concept*. <http://www.globalsecurity.org/military/library/policy/usmc/mcm.pdf>
- McIntosh, Gregory C., David P. Galligan, Mark A. Anderson, and Michael K. Lauren. 2007, May. *MANA (Map Aware Non-uniform Automata) Version 4 User Manual*. New Zealand: Defence Technology Agency.
- Melia, Tamara M. 1991. *Damn the Torpedoes: A Short History of U.S. Naval Mine Countermeasures 1777-1991*. Vol. 4. Contributions to Naval History. Washington, DC: Naval Historical Center, Department of the Navy. <http://edocs.nps.edu/dodpubs/topic/general/DamnTorpedoesWhole.pdf>
- MIW C4ISR. 2001, July 25. "Mine Warfare C4ISR." Presented C4I Ship Modernization and D-30 Process IT-21. http://www.minwara.org/Meetings/2001_07/C4ISR%20minwara%2001CDR.ppt
- Mohammed, Nabil, Ali Munassar, and A. Govardhan. 2010, September. "A Comparison Between Five Models Of Software Engineering." International Journal of Computer Science Issues, Vol. 7(5). <http://www.ijcsi.org/papers/7-5-94-101.pdf>

- Montgomery, Douglas C., and George C. Runger. 2011. *Applied Statistics and Probability for Engineers*. Fifth ed. Hoboken, NJ: Wiley.
- Mun, Johnathan. 2010. *Modeling Risk Applying Monte Carlo Risk Simulation, Strategic Real Options, Stochastic Forecasting, and Portfolio Optimization*. Hoboken, NJ: Wiley.
- “N81 Alignment Warfare Sponsor Briefing.” 2006, January 5.
http://www.ndia.org/Divisions/Divisions/StrikeLandAttackAndAirDefense/Documents/Content/ContentGroups/Divisions1/Strike,_Land_Attack_and_Air_Defense/N81_Alignment_Brief_to_Warfare_Sponsors.pdf
- National Geographic Channel. 2014. “USS Freedom and USS Independence New Warships” <http://www.youtube.com/watch?v=3-EPWLuzhuY>
- Naval Mine Warfare Engineering Activity, 1991. *U.S. Navy Mine Countermeasures Familiarizer*. Yorktown, VA: U.S. Navy.
- Naval Sea Systems Command. n.d.-a. “Affiliated Program Executive Offices.”
<http://www.navsea.navy.mil/Organization/PEO.aspx>
- . n.d.-b. “Naval Surface Warfare Center Panama City Division—Mission & Vision Statements.”
<http://www.navsea.navy.mil/nswc/panamacity/pages/mission.aspx>
- . n.d.-c. “NSWC Carderock Division.”
<http://www.navsea.navy.mil/nswc/carderock/default.aspx>
- . n.d.-d. “Team Ships.” <http://www.navsea.navy.mil/teamships/default.aspx>
- Naval Sea Systems Command Office of Corporate Communication. n.d. “Mine Countermeasures Ship—MCM”, Washington D.C. 20376. Accessed June 1.
<http://www.public.navy.mil/surfor/pages/MineCountermeasuresShips.aspx>
- “OPNAV N95.” 2013. <https://www.dawnbreaker.com/portals/phase3/opnav-resource-sponsors/opnav-n9/opnav-n95/>
- “OPNAV N96.” 2013. <https://www.dawnbreaker.com/portals/phase3/ponav-resource-sponsors/opnav-n9/n96/>
- O'Rourke, Ronald. 2014, April 14. “Navy Littoral Combat Ship (LCS) Program: Background and Issues for Congress.” Rep. Washington, DC: Congressional Research Service. <http://www.hsdl.org/?view&did=752325>
- PMS 495 Mine Warfare Program. 2008. “PMS495 Annual Report FY08.”
http://s3images.coroflot.com/user_files/individual_files/292769_oRG6RrRZBK6dEexpa04uSQje6.pdf

- Program Executive Office Littoral and Mine Warfare. 2008, November 14. *Standard Mine Warfare Measures of Effectiveness and Measures of Performance*. PEO LMW Instruction 3370.1A, Washington DC: Department of the Navy.
- . 2009. *21st Century U.S. Navy Mine Warfare—Ensuring Global Access and Commerce*. http://www.navy.mil/n85/miw_primer-june2009.pdf
- . 2010. “Program Executive Office Littoral & Mine Warfare, Annual Report FY2010.” http://www.navsea.navy.mil/nswc/dahlgren/ET/LCS/annual_report_2010.pdf
- Program Executive Office Littoral Combat Ships Public Affairs. 2013, December 12. “LCS Remote Minehunting System Completes Developmental Testing.” <http://www.public.navy.mil/surfor/lcsron1/Pages/LCSRemoteMinehuntingSystemCompletesDevelopmentalTesting.aspx>
- Rabirot, Jon. 2011. “US Military Enters New Generation of Sea Mine Warfare.” *Stars and Stripes*, May 9. <http://www.stripes.com/news/u-s-military-enters-new-generation-of-sea-mine-warfare-1.143170>
- Robert S. Strauss Center, The. 2008, August. “Straight of Hormuz: Geography.” <https://strausscenter.org/hormuz/geography.html>
- Secretary of Defense. 2014, March 4. *Quadrennial Defense Review 2014*. Department of Defense, Washington, DC. http://www.defense.gov/pubs/2014_Quadrennial_Defense_Review.pdf
- Secretary of the Navy. n.d. “PEO Littoral Combat Ships.” <http://www.secnav.navy.mil/rda/Pages/PEOLCS.aspx>
- Scott, Zane. 2011. *Model Based Systems Engineering*. Proceedings of APCOSE, Vitech Corporation. http://www.incose.org/chesapek/Docs/2011/Presentations/2011_09_17_Model-Based_SystemsEngineeringPublicSlides.pdf
- Sikder, Faisal. 2009. “Software Development Life Cycle (SDLC) Waterfall Model.” <http://faisalsikder.wordpress.com/2009/12/18/software-development-life-cycle-sdlc-waterfall-model/>
- Truver, Scott C. 2008. “Mines and Underwater IEDs in U.S. Ports and Waterways.” *Naval War College Review* 61(1):106–127. <https://www.usnwc.edu/getattachment/a18d6281-269c-4e7a-910c-220a02bd2cd8/Mines-and-Underwater-IEDs-in-U-S-Ports-and-Waterwa>
- . 2012. “Taking Mines Seriously, Mine Warfare in China's Near Seas.” *Naval War College Review* 65(2):30-66.

- <http://www.usnwc.edu/getattachment/19669a3b-6795-406c-8924-106d7a5adb93/Taking-Mines-Seriously--Mine-Warfare-in-China-s-Ne.aspx>
- Under Secretary of Defense (AT&L). 2006. *Risk Management Guide for DOD Acquisition*. Washington, DC. Under Secretary of Defense (AT&L). August.
<http://www.acq.osd.mil/se/docs/2006-RM-Guide-4Aug06-final-version.pdf>
- . 2009. *Modeling and Simulation (M&S) Verification, Validation, and Accreditation (VV&A)*. DOD Instruction 5000.61. Washington, DC: Under Secretary of Defense (AT&L), December 9.
<http://www.dtic.mil/whs/directives/corres/pdf/500061p.pdf>
- U.S. Government Accountability Office. 2013. *Significant Investments in the Littoral Combat Ship Continue Amid Substantial Unknowns About Capabilities, Use, and Cost*. Vol. GAO-13-530.
- U.S. Joint Chiefs of Staff. 2010. *Department of Defense Dictionary of Military and Associated Terms*. Joint Publication 1–02.
http://www.dtic.mil/doctrine/new_pubs/jp1_02.pdf.
- . 2011. *Barriers, Obstacles, and Mine Warfare for Joint Operations*. Joint Publication 3-15. http://www.dtic.mil/doctrine/new_pubs/jp3_15.pdf.
- Vieira Jr., H. Sanchez, S.M., Kienitz, K.H., and M.C.N. Belderrain. 2013. “Efficient, Nearly Orthogonal-and-Balanced, Mixed Designs; an Effective Way to Conduct Trade-Off Analyses via Simulation.” *Journal of Simulation* 7:264-275.
doi:10.1057/jos.2013.14.

THIS PAGE INTENTIONALLY LEFT BLANK

INITIAL DISTRIBUTION LIST

1. Defense Technical Information Center
Ft. Belvoir, Virginia
2. Dudley Knox Library
Naval Postgraduate School
Monterey, California