

# Status of the diode research programme at AWE

J O' Malley<sup>a</sup>, J Maenchen<sup>b</sup>, G Cooperstein<sup>c</sup>

<sup>a</sup>Advanced AGEX Group, AWE Aldermaston, Berkshire, RG7 4PR, UK

<sup>b</sup>Sandia National Laboratories, Albuquerque, New Mexico, 87185-1193 USA

<sup>c</sup>Naval Research Laboratory, Washington D.C. 20375

## Abstract

A summary of the status of diode research at the UK Atomic Weapons Establishment (AWE) is presented. AWE has a requirement to develop intense (1000R at 1m), fast duration (50ns) Bremsstrahlung x-ray sources from small areas (<2mm diameter uniformly filled disc equivalent) at high peak energies (>10MeV). These sources are required to provide high quality transmission radiographic images through thick (hundreds of grams/cm<sup>2</sup> of lead equivalent density x thickness), high atomic number, explosively driven metal systems in a proposed new hydrodynamics research facility. In order to deliver such sources in a cost-effective manner an extensive research programme is being conducted at AWE to increase the current density at which high-energy electron beams can be focussed in electron beam diodes in such flash radiographic sources.

The work on improvements to pulsed power facilities and diagnostics at AWE is described in terms of the development of high quality research facilities for high and low impedance diode development. In addition, an overview of the status and direction of research programmes at AWE to look at four diode technologies is presented. Those diode technologies are immersed Bz diode development, paraxial diode development and both self-magnetic and rod-pinch diode development.

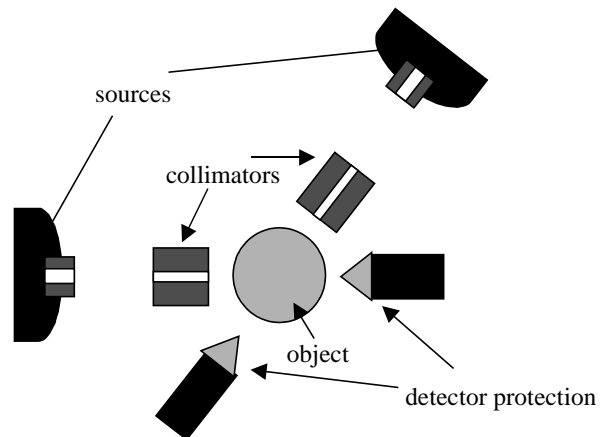
## I. INTRODUCTION TO HYDRODYNAMIC EXPERIMENTATION

In the Comprehensive Test Ban Treaty era above ground experimentation (AGEX) represents the main method by which the UK nuclear deterrent is underwritten. A critical part of the operation of a nuclear warhead is the assembly of a subcritical shell of fissile material into a critical assembly by the use of high explosives. One of the most important types of AGEX experiment is a core punch (CP) experiment. The CP experiment is a method used to investigate this explosively driven hydrodynamic phase of the warhead operation.

In a CP experiment a mock up of the warhead is manufactured with fissile material replaced by an inert simulant. This device is then detonated under remote control within specially designed explosive containment buildings called firing chambers. During the experiment a very brief, intense, collimated flash of high energy x-rays are used to take a snapshot of the implosion (see Fig. 1). From the resulting image, measurements of the dynamic

configuration and density distribution of the components in the device are inferred. These are then compared with calculations of the hydrodynamic operation of the weapon as part of the science based stockpile stewardship programme at AWE.

The CP experiment poses several unique challenges to radiography. The object under investigation is extremely opaque to x-rays. It is both dense and of high atomic number and therefore is equivalent to many tens of cm of lead in terms of transmission to 3-5MeV photons. The object density distribution is also rapidly moving (~several kms<sup>-1</sup>) and therefore a 50ns flash of x-rays is typically used. Finally, the experiment is an explosive experiment; therefore the x-ray source, detectors and facilities must be protected against explosive blast and fragmentation attack.



**Figure 1. Schematic plan of a twin axis core punch experiment**

AWE currently uses Moguls D and E as twin flash radiographic sources for such experiments as shown in Fig. 2 [1]. These machines operate at 7MV and 8MV peak energy Bremsstrahlung (PEB) respectively delivering doses of 150R (D) and 400R (E) at 1m in 50ns from 5mm uniformly filled disk equivalent source sizes.

In addition to the CP experiment a diverse variety of 'thin' object radiography is performed in which a few microns to a few mm thickness of explosively driven lead equivalent material is interrogated. In such experiments Bremsstrahlung sources with peak energies of 1-6MeV are typically used, depending on the experimental objectives. Lower energies are used than in CP experiments in order to achieve high contrast for small areal mass differences in the object of interest and in

## Report Documentation Page

*Form Approved  
OMB No. 0704-0188*

Public reporting burden for the collection of information is estimated to average 1 hour per response, including the time for reviewing instructions, searching existing data sources, gathering and maintaining the data needed, and completing and reviewing the collection of information. Send comments regarding this burden estimate or any other aspect of this collection of information, including suggestions for reducing this burden, to Washington Headquarters Services, Directorate for Information Operations and Reports, 1215 Jefferson Davis Highway, Suite 1204, Arlington VA 22202-4302. Respondents should be aware that notwithstanding any other provision of law, no person shall be subject to a penalty for failing to comply with a collection of information if it does not display a currently valid OMB control number.

1. REPORT DATE <b>JUN 2003</b>	2. REPORT TYPE <b>N/A</b>	3. DATES COVERED <b>-</b>			
4. TITLE AND SUBTITLE <b>Status of the diode research programme at AWE</b>		5a. CONTRACT NUMBER			
		5b. GRANT NUMBER			
		5c. PROGRAM ELEMENT NUMBER			
6. AUTHOR(S)		5d. PROJECT NUMBER			
		5e. TASK NUMBER			
		5f. WORK UNIT NUMBER			
7. PERFORMING ORGANIZATION NAME(S) AND ADDRESS(ES) <b>Advanced AGEX Group, AWE Aldermaston, Berkshire, RG7 4PR, UK</b>		8. PERFORMING ORGANIZATION REPORT NUMBER			
9. SPONSORING/MONITORING AGENCY NAME(S) AND ADDRESS(ES)		10. SPONSOR/MONITOR'S ACRONYM(S)			
		11. SPONSOR/MONITOR'S REPORT NUMBER(S)			
12. DISTRIBUTION/AVAILABILITY STATEMENT <b>Approved for public release, distribution unlimited</b>					
13. SUPPLEMENTARY NOTES <b>See also ADM002371. 2013 IEEE Pulsed Power Conference, Digest of Technical Papers 1976-2013, and Abstracts of the 2013 IEEE International Conference on Plasma Science. IEEE International Pulsed Power Conference (19th). Held in San Francisco, CA on 16-21 June 2013. U.S. Government or Federal Purpose Rights License, The original document contains color images.</b>					
14. ABSTRACT <b>A summary of the status of diode research at the UK Atomic Weapons Establishment (AWE) is presented. AWE has a requirement to develop intense (1000R at 1m), fast duration (50ns) Bremsstrahlung x-ray sources from small areas (&lt;2mm diameter uniformly filled disc equivalent) at high peak energies (&gt;10MeV). These sources are required to provide high quality transmission radiographic images through thick (hundreds of grams/cm2 of lead equivalent density x thickness), high atomic number, explosively driven metal systems in a proposed new hydrodynamics research facility. In order to deliver such sources in a cost-effective manner an extensive research programme is being conducted at AWE to increase the current density at which high-energy electron beams can be focussed in electron beam diodes in such flash radiographic sources. The work on improvements to pulsed power facilities and diagnostics at AWE is described in terms of the development of high quality research facilities for high and low impedance diode development. In addition, an overview of the status and direction of research programmes at AWE to look at four diode technologies is presented. Those diode technologies are immersed Bz diode development, paraxial diode development and both self-magnetic and rod-pinch diode development.</b>					
15. SUBJECT TERMS					
16. SECURITY CLASSIFICATION OF:			17. LIMITATION OF ABSTRACT <b>SAR</b>	18. NUMBER OF PAGES <b>8</b>	19a. NAME OF RESPONSIBLE PERSON
a. REPORT <b>unclassified</b>	b. ABSTRACT <b>unclassified</b>	c. THIS PAGE <b>unclassified</b>			



order to minimise blurring in detector systems. Importantly, such ‘moderate energy sources’ are also used because a small source size is required to maximise image resolution. The diode technology used to convert the electron beam to photons can reliably produce small (~1mm uniformly filled disk equivalent) sources from few MV electron beams with tens to hundreds of kA currents, but at higher voltages and similar currents source sizes are typically significantly larger.



Figure 2. Photograph of twin axis AWE core punch facility showing Mogul D and Mogul E

## II. THE HYDRODYNAMICS RESEARCH FACILITY (HRF) AT AWE

A new hydrodynamics research facility will be built in 2008/2009 in order to achieve a set of requirements established by the design community at AWE for stockpile stewardship in the 21<sup>st</sup> century. The facility will be built in phases, the first phase being a new, multi-axis CP facility within which more accurate measurements of material interfaces and densities will be made. Later, modernisation of existing firing chambers incorporating ‘thin object’ radiography will also be completed. It is intended that an improved overall hydrodynamic strategy will be delivered in ~ 2012.

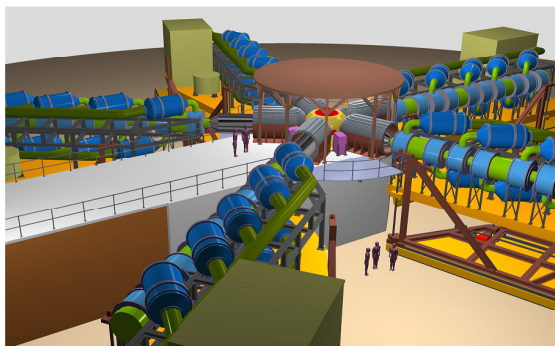


Figure 3. Artist’s impression of the HRF multi-axis core punch radiographic facility.

## III. RADIOGRAPHIC SYSTEM OPTIMISATION AND THE DIODE ZONE

In order to deliver the required improvements in interface location and density measurement in the HRF improvement throughout the radiographic chain is required. Consideration must be given to the source, doses and spot sizes, the protection systems and the detector used in the core punch experiment.

Simple partial differential analysis techniques have been used to estimate uncertainties in the required measurements due to radiographic parameters of the system such as the dose of the radiographic sources used, the system resolution, the scattered x-ray flux contaminating the images and the three dimensionality of the object. This technique has identified a plausible progressive route to meeting the design community requirements, which involves delivering a short term and long term specification for the HRF CP facility.

Table 4 shows these specifications which include a three axis, 600R, 5mm source capability in the short term (2008/9) being upgraded to a long-term capability of five 1000R, 2mm sources by 2012.

	Present (AWE) capability	Short term (AWE) capability	Long term (AWE) capability
Number of views	2	3	5
Dose (R @ m)	400	600	1000
Spot size (mm)	7	5	2
Accuracy of scatter measurements	15%	10%	2%
Detector ( $f_c$ , QE)	Film (0.4, 0.1)	Film (0.4, 0.1)	ARM (0.3,0.3) (Gate-able detector)
Source to object (cm)	120	120	120
Object to detector (cm)	60	60	60

Table 4. Table of HRF specifications

A number of research programmes are in place to examine some of the assumptions behind the progressive CP improvement strategy suggested by the simple uncertainty estimation techniques. These include: a detailed investigation of how three dimensional reconstruction accuracies improve with number and orientation of radiographic views; a study of how scatter sources increase with multiple views and how well Monte Carlo techniques can be used to characterise these scatter sources for removal in the core punch analysis process; and development of new detector systems for the HRF.

The other important area of work is in confirming the delivery of the improved source specifications required by the strategy. In particular, the delivery of 1000R doses from 2mm uniformly filled disk source sizes using inductive voltage adder (IVA) pulsed power driver technology is considered to be a significant risk in attaining the desired long-term HRF performance.

The only current radiograph sources which come close to the long-term HRF requirements are the excellent LANL DARHT [2] and CEA AIRIX linear induction accelerator (LIA) machines. These deliver several hundred R in 50ns from 2mm UFD source sizes. Both

these machines focus relatively low currents of 2-3kA at high voltages (19MV) to achieve high dose, small source size configurations, however they are expensive in terms of current UK affordability at ~\$100M per machine. The UK is investing in IVA technology which operates at 14MeV and 100kA. This is more cost effective to the UK at ~\$15M per view, but the increased current means control of the electron beam to achieve a small source size is more problematic and currently beyond any existing source capability.

In order to alleviate the risk in achieving the long-term HRF source requirements a study has been conducted to look at the trade off in core punch radiographic performance with dose and spot size of the source. Information theory techniques used by Fellget and Linfoot and developed for radiography by Watson have been further enhanced at AWE to include the effects of scattered x-rays and detector variances (see Figure 4) [3]. The figures of merit represent the amount of information in terms of bits per pixel in the object plane contained in each image taken with the associated specifications.

$$\log_2 \left[ 1 + \frac{8 \times 10^6 PT D Q_{eff}}{C_1^2 \sqrt{\frac{8 \times 10^6 T D Q_{eff}}{C_1^2} \left( 1 + \frac{0.2}{((M-1)C_1 - 0.4)^2} \right) + 8 \times 10^6 (n-1) G M^2 + 480 M^2}} \right]$$

Scatter glows (G) from other (n-1) x-ray sources

Small angle Compton scatter from explosive protection materials

variance in detector

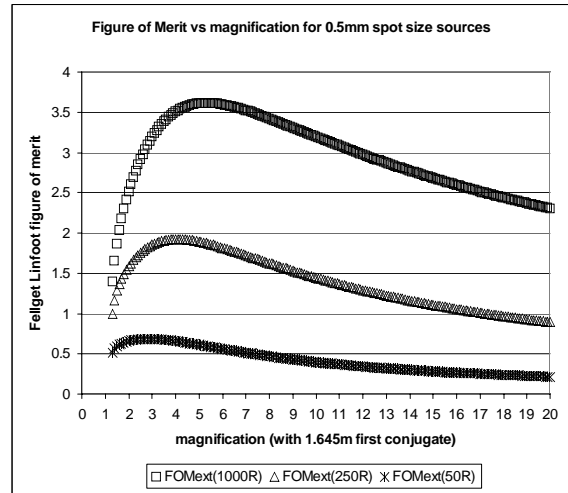
**Figure 4. The improved AWE information theory based figure of merit.**

P= pixel size at object in mm, T = transmission of the object, D = dose in R at 1m from the source,  $Q_{eff}$  = quantum efficiency of detector at zero frequency, M = experimental magnification,  $C_1$  = first conjugate (source to object) distance in m, n= number of machines, G= scatter cross talk or 'glow' in R per source measured at the detector, S = spot size of source in mm,  $f_c$ = frequency at which detector MTF is 50% in  $mm^{-1}$ , V= velocity of motion of object masses in  $mm\mu s^{-1}$ , W = temporal width of x-ray source in  $\mu s$

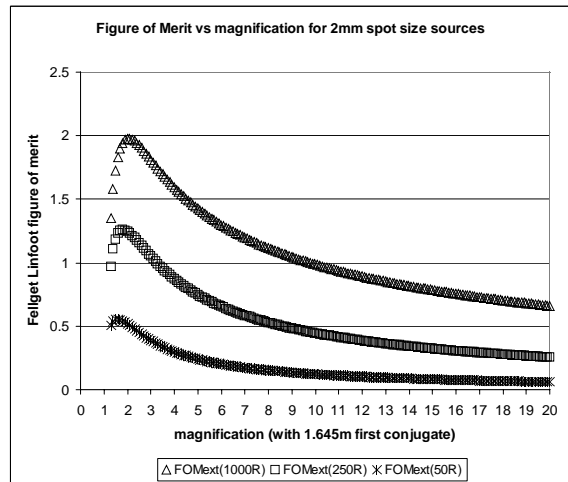
In outline, such techniques are based on recognition that two aspects of radiography are important to achieve a high quality image. The first is to have a high system resolution measured back in the plane of the object being investigated. The second is to have a good signal to noise ratio in the statistics of the recorded photon flux measured back to that passing through the object.

Figures 5a and 5b show the modified AWE figure of merit vs. dose and magnification for 0.5mm and 2mm sized sources respectively. It can be seen that 250R 0.5mm sized sources have the same amount of

information per object plane pixel (2 bits) as the 1000R 2mm sized HRF sources. Such a trade off can be extended and a zone of dose and spot size established to meet HRF goals as shown in Fig. 6.

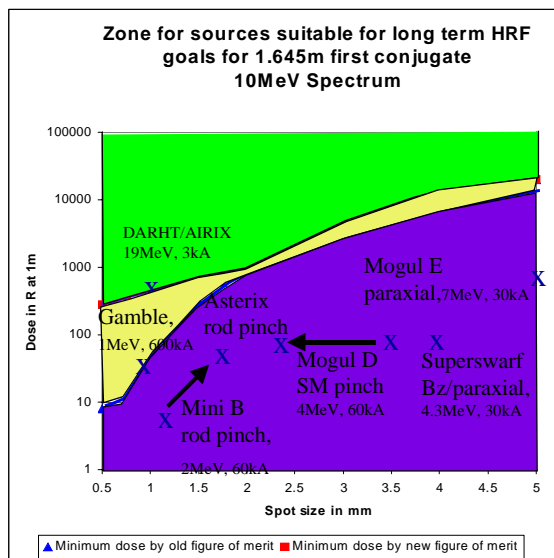


**Figure 5a. Radiographic figure of merit vs. magnification for 0.5mm spot sized sources with gamma camera detectors ( $f_c=0.3$ ,  $Q_{eff}=0.3$ )**



**Figure 5b. Radiographic figure of merit vs. magnification for 2mm spot sized sources with gamma camera detectors ( $f_c=0.3$ ,  $Q_{eff}=0.3$ )**

There are three regions to the diode zone shown in Fig. 6. In the bottom region, even ignoring image degradation due to scattered photons and small detector backgrounds the diodes would not deliver the same amount of information as 1000R dose, 2mm spot size long term HRF sources and are therefore deemed unsuitable. In the top region, even including these effects the diodes give at least the same amount of information as the long-term HRF sources and are therefore deemed suitable diode candidates. In the intermediate zone it is possible that by working on reducing scattered x-ray backgrounds and detector variances such sources might meet long term HRF goals.



**Figure 6. The zone of diode performance to meet long term HRF goals for a 1.645m first conjugate distance and 10MeV spectrum.**

The diode zone can be used to assess current diode technology with respect to long term HRF requirements and also to chart the progress in source development towards those requirements.

#### IV. OVERVIEW OF THE COLLABORATIVE DIODE RESEARCH PROGRAMME

There has been continuous evolution and improvement in diode performance for flash radiographic applications since the inception of such techniques in the early 1970s [1,4]. The past 18 months however has seen an increased focus and pace to research activity compatible with delivery of sources suitable for use in the long term. In particular, AWE has been collaborating with Sandia National Laboratories (SNL) and Naval Research Laboratory (NRL), Washington.

Four candidate diode technologies have been identified with potential to meet long term HRF goals. The diode technologies are based on the paraxial diode [1], the immersed Bz diode [5], the self magnetic pinch diode [6,7] and the rod-pinch diode [8,9]. These diodes will be discussed in sections V to VIII.

Three main issues have been highlighted as vital in the further improvement to diode technology. Firstly, it is important that machine pre-pulse and vacuum is assessed with respect to its impact on diode operation and that

drivers conducting diode research minimise the impact of pre-pulse and vacuum on diode performance. Secondly, improved diagnostics must be developed and implemented on experimental diode research to interrogate plasma and electron beam distributions for comparison with theoretical predictions of diode behavior. Thirdly, calculation must be used in conjunction with experiment to understand diode operation. The current code of choice is the large Scale Plasma (LSP) code developed by Mission Research Corporation (MRC) [10,11]. The limitations of such codes must be understood and the codes improved to provide platforms to calculate the physics relevant in diode operation.

AWE is working on these three issues as part of the collaborative diode programme.

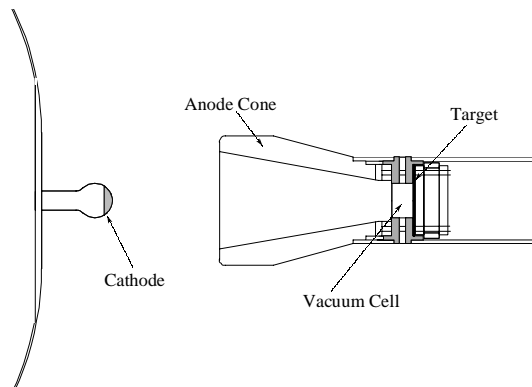
A new diode research facility is planned at AWE in which pre-pulse suppression and improved vacuum systems will be fitted to the EMU and Eros single pulse forming line (SPFL) machines in a common laboratory. EMU will operate at around 8MV and drive ~ 150 ohm, high impedance diode candidates [12]. Eros will operate at around 6MV and drive ~ 40 ohm, low impedance diode candidates. Both machines will incorporate optical ports near the diode region of the machine to facilitate a range of interferometric diagnostics.

AWE is working with NRL and SNL to incorporate improved plasma diagnostics at the diode research facility. Multi-beam heterodyne interferometry is recommended to study the paraxial diode and high sensitivity interferometry recommended for the immersed Bz and pinch diode concepts. In general there is a requirement to image plasma densities in the  $10^{13}$ - $10^{19}$ cm<sup>-3</sup> regime. AWE is also developing a new 2D time resolved spot measurement technique using five 3ns gating MCPs coupled to CCDs imaging fast organic scintillators.

AWE is also working closely with SNL, NRL, MRC and others in the use of LSP to model diode concepts and to validate the use of the code for this application [13].

#### V. PARAXIAL DIODE RESEARCH: STATUS AND HOPES

The paraxial diode has been reliably used on single pulsed forming line (SPFL) drivers for flash radiographic applications to deliver doses of up to 400R at 1m (8MeV PEB) in 50ns from a 4.5mm spot size on Mogul E at AWE [1]. On lower voltage sources such as the Superswarf driver at AWE, doses of 70R at 1m (4.3MeV PEB) are obtained from a similar source size [1]. Figure 7 shows a schematic of the geometry.



**Figure 7. Schematic of typical vacuum cell paraxial diode configuration**

In a paraxial diode a low density gas cell is used to provide an electrically and magnetically neutralised region for electron beam propagation and hence facilitate ballistic focussing of the electron beam.

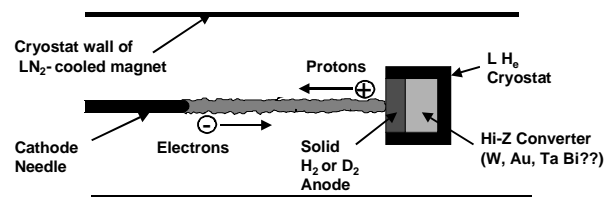
Recent experimental work has included the successful application of paraxial diode technology to IVA drivers on the RITS 3 machine at Sandia and measurements of gas cell plasma densities on the Gamble II driver by NRL using interferometric diagnostics [14]. The RITS 3 experimental data at 4MeV has shown that there appears to be no significant problems in use of the paraxial diode on IVA drivers with fast risetime voltage pulses (compared to SPFL drivers previously used) and have also been useful in investigating MITL current shedding in conjunction with this radiographic diode. The Gamble experiments have pioneered the application of sophisticated diagnostics to paraxial technology and are an important step in learning more about paraxial diode operation.

Theoretical work has also intensified in recent months on paraxial diode technology with studies at AWE, MRC, SNL and NRL. The current status of understanding suggests that the paraxial diode, whilst electrically neutralised in the gas cell, is not magnetically neutralised with electrons undergoing betatron focusing. A possible route to improved paraxial performance is suggested as the use of fully ionised gas cells within which more force free conditions should be possible for the electron beam. Some of the limitations in the use of LSP to calculate the dynamics of the gas cell at 1- 100 torr pressures with current densities of  $10\text{-}100\text{kAcm}^{-2}$  have also been identified and are being investigated [15,16].

## VI. IMMERSSED BZ DIODE RESEARCH: STAUS AND HOPES

The immersed Bz diode uses a large external solenoidal magnetic field to constrain electron emission from a cathode needle along field lines until they impinge upon a conversion target to generate x rays.

Several experimental programmes have investigated the performance of the BZ diode. These include investigations on the Hermes and Sabre IVA drivers at SNL [5] and studies on Superswarf SPFL drivers at AWE [1,17]. The immersed Bz diode can produce similar performance to paraxial diodes on the Superswarf machines at 4.3MeV PEB, delivering  $\sim 60\text{R}$  from a 4.5mm source size using 25T magnetic fields and 2-3 mm cathode needle diameters. Increased magnetic field or reduced cathode diameter however does not reduce the effective source size.



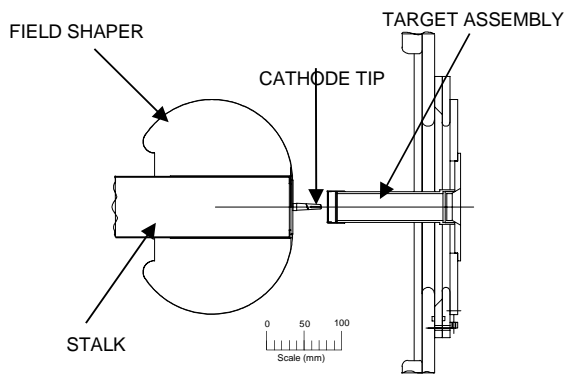
**Figure 8. Artist's impression of a cryogenic, solid hydrogen immersed Bz concept diode**

Recent calculational work has suggested that immersed Bz performance is limited by an instability arising from the interaction between electron beam, ion current from the anode and external magnetic field known as an ion hose instability. The ion hose instability causes the electron beam in the diode to undergo helical orbits and thus increases the time averaged spot size. Heavy ions emitted from the target can strip to charge states greater than unity due to ion-ion collisions resulting in premature impedance collapse.

An engineering design has been established by SNL for a solid hydrogen target immersed Bz concept in which a plug of solid hydrogen or deuterium is deposited between electron beam and conversion target to act as a barrier between electron beam and any heavy target ions which may be formed in diode operation and to limit backstreaming ion currents to the proton species only [18]. Figure 8 illustrates such a concept. Calculations suggests that the amplitude of instability between proton and electron beams will be significantly reduced and that such a cryogenic concept may produce HRF quality sources with 40-60T. Split magnet hardware has also been manufactured and will shortly be tested on the RITS machine at SNL in order to allow better diagnostic access to the BZ diode to benchmark calculational models of the concepts. NRL are working with SNL to provide such enhanced diagnostic capabilities [19].

## VII. SELF MAGNETIC PINCH DIODE RESEARCH: STATUS AND HOPES

Figure 9 shows the geometry of a self magnetic pinch diode. Here a hollow electron beam is emitted from a cathode and generates target plasma which produces electrostatic neutralisation of the electron beam and hence enables the self magnetic field of the electron beam to pinch electrons to a tight focus.



**Figure 9. Schematic of typical self magnetic pinch diode configuration**

SM pinch diodes have been routinely used at AWE for thin object radiography on the Mini B 2.2MV SPFL machines. Doses of 12R at 1m are produced from source sizes of 2.7mm. Until recently SM pinch diodes were largely rejected for CP radiography due to concerns as to how hot the electron beam generating Bremsstrahlung was on the target with pinch angles between 40 and 60 degrees.

Recently experiments at AWE on the Mogul D and Eros machines [6,7] and at SNL on the RITS 3 machine have re-examined SM pinch performance up to 4MV. Doses of up to 80R at 1m from a 2.8mm spot size have been obtained on Mogul D at AWE.

Increased effort has also been applied to the calculation of both the detailed operation of the pinch using LSP and also in calculation of the resultant radiographic spectrum of such a source using the Monte Carlo n-particle transport code (MCNP) [6].

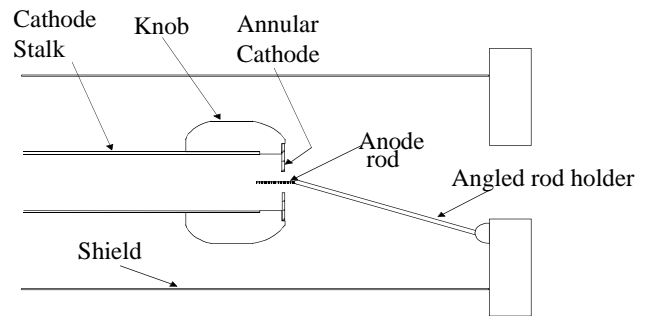
The experimental and calculational programmes to date have suggested significant progress in the SM pinch performance and calculational extrapolations to higher voltage indicate that HRF quality sources (1000R, 2mm) may be possible at 10MV with 160A of pinch current and that the effectiveness of the associated spectrum would be suitable for CP applications. Further scaling work on the SM pinch diode and optimisation of the hardware is planned on Eros at AWE and the Mercury IVA at NRL.

## VIII. ROD-PINCH DIODE RESEARCH: STATUS AND HOPES

The operation of a rod-pinch diode is similar to the operation of a self-magnetic pinch diode, however the geometry differs. Using a positive polarity driver an annular cathode surrounds a positive needle anode and in the pinching mechanism electrons are focused on the tip of the needle to generate a small source. The LANL Cygnus IVA source uses a rod-pinch diode to produce 4R at 1m from a 1.2mm spot size at 2.25MV with superb reproducibility for thin object radiographic applications.

Recently the rod-pinch has also been investigated at higher voltages experimentally [20,21]. Rod-pinch experiments on Asterix in positive polarity have obtained 45R from a sub 2mm source size at 6MV.

The rod-pinch diode has also delivered 20R from a 2.2mm spot size at 4MV on Mogul D at AWE in negative polarity. One geometry for a negative polarity rod-pinch is shown in Fig. 10 using a bent anode rod to reduce attenuation by the rod material to the x-ray beam on axis from the machine. An alternative design negative rod-pinch has also been developed at AWE and tested on the Mini B and Mogul D SPFL machines at 2-4MeV (PEB).



**Figure 10. Artists impression of typical negative polarity rod-pinch diode configuration**

Experiments on Asterix by CEA, DGA, SNL and NRL at AWE on Mini B have also measured the polar distribution of radiation from the diode. LSP calculations have attempted to model the rod-pinch and comparisons between experimental and calculational polar dose distributions at Asterix and Mini B have been made by NRL [22]. This work has suggested that whilst the forward dose from a positive polarity rod-pinch does not increase rapidly with driver voltage beyond 6MV, the radiation at 180 degrees to the machines nominal beam axis is enhanced at high voltages and predicts HRF performance at 10-12MV from a negative polarity rod-pinch diode.

Further calculational and experimental studies at NRL have highlighted possible additional rod-pinch performance enhancements by elimination of light ion plasmas [23]. Heated rod schemes are being used to study this.

## IX. OPPORTUNITIES FOR 'THIN OBJECT' RADIOGRAPHY

In addition to the utility of high voltage, small sources sizes for CP radiography the concept of a small high intensity source offers some opportunities for thin object radiography at AWE.

Current HRF concepts consider the use of additional experimental firing chambers to facilitate thin object radiography due to incompatibility between CP and thin object radiographic driver requirements. In principle a high energy (e.g. 14MeV PEB) spectrum will deliver a high flux of soft photons, which are suitable to provide

both the fluxes and the contrast, required by thin object applications. By the use of thin detector systems detector blur due to secondary electron energy spread within the detector from the higher energy components of such a spectrum can be reduced and therefore, in conjunction with a small source, a high radiographic resolution could be achieved. This generates the possibility to add functionality to the CP facility with potential resultant cost savings.

## X. CONCLUSIONS

A collaborative diode research programme has been established to deliver the equivalent radiographic performance of 1000R, <2mm source size machines using IVA technology. Four diode concepts are being investigated and show potential for such applications.

## XI. REFERENCES

- [1] A. R. Birrel, R. D. Edwards, T. J. Goldsack, and M. A. Sinclair, "New Developments in Paraxial Radiographic Diode Technology for Focusing Intense Relativistic Electron Beams," *IEEE Trans. Plasma Sci.* **28**, 1660-1663, 2001.
- [2] M. J. Burns et al, "Status of the Dual Axis Radiographic Hydrodynamics Test (DARHT) Facility", 14<sup>th</sup> International Conference on High-Power Particle Beams, June 23-28, 2002, pp. 139-143.
- [3] J. O' Malley, "Optimisation of diode performance for deep penetration flash radiographic applications at AWE", 14<sup>th</sup> International Conference on High-Power Particle Beams, June 23-28, 2002, pp. 163-166.
- [4] J. E. Maenchen, K. Hahn, M. Kincy, D. Kitterman, R. Lucero, P.R. Menge, I. Molina, C. Olson, D. C. Rovang, R. D. Fulton, R. Carlson, J. Smith, D. Martinson, C. Droemer, R. Gignac, T. Helvin, E. Ormand, F. Wilkins, D. R. Welch, B. V. Oliver, D. V. Rose, V. Bailey, P. Corcoran, D. L. Johnson, I. D. Smith, D. Weidenheimer, G. Cooperstein, R. Comisso, D. Mosher, S. Stephanakis, J. Schumer, S. Swanekamp, F. Young, T. J. Goldsack, G. M. Cooper, A. G. Pearce, M. A. Phillips, M. A. Sinclair, K. J. Thomas, M. Williamson, S. Cordova, R. Woodring and E. Schamiloglu, "Intense Electron Beam Sources for Flash Radiography", 14<sup>th</sup> International Conference on High-Power Particle Beams, June 23-28, 2002, pp. 117-123.
- [5] J. E. Maenchen, S. Cordova, J. Gustwiller, D. L. Johnson, I. Molina, C. Olson, S. Rosenthal, D. Rovang, B. Oliver, D. Welch, V. Bailey, I. Smith, D. Droemer, E. Hunt, G. MacLeod, and L. Woo, "Inductive Voltage Adder Driven X-Ray Sources for Hydrodynamic Radiography," in *Proceedings of the 12<sup>th</sup> IEEE International Pulsed Power Conference*, edited by C. Stallings and H. Kirbie, Monterey, California, June 27-30, 1999, IEEE Cat. No. 99CH36358, (Institute of Electrical and Electronic Engineers, Piscataway, NJ, 1999), p. 279-282.
- [6] I. Crotch, J. Threadgold, M. Sinclair and A. Pearce, "Self Magnetic Pinch Diode Experiments at AWE", W1-8, these proceedings.
- [7] J. Threadgold, I. Crotch and S. Clough, "2-D LSP Simulations of the Self Magnetic Pinch Diode", TP-06, these proceedings.
- [8] G. Cooperstein, J. R. Boller, R. J. Comisso, D. H. Hinshelwood, D. Mosher, P. F. Ottinger, J. C. Schumer, S. J. Stephanakis, S. B. Swanekamp, B. V. Weber, and F. C. Young, "Theoretical Modeling and Experimental Characterization of a Rod-Pinch Diode," *Phys. Plasmas*, vol. 8, no. 10, pp. 4618-4636, October 2001.
- [9] R. J. Comisso, G. Cooperstein, D. D. Hinshelwood, D. Mosher, P. F. Ottinger, S. J. Stephanakis, S. B. Swanekamp, B. V. Weber, and F. C. Young, "Experimental evaluation of a megavolt rod-pinch diode as a radiography source", *IEEE Trans. Plasma Sci.* **30**, 338-351, 2002.
- [10] D. R. Welch, D. V. Rose, B. V. Oliver, and R. E. Clark, "Simulation techniques for heavy ion fusion chamber transport," *Nucl. Instrum. Methods Phys. Res. A* **464**, 134-139 (2001).
- [11] LSP is a software product of Mission Research Corporation, Albuquerque, NM 87110 (<http://www.mrcabq.com>).
- [12] M. A. Sinclair, T. F. Bryant, and A. Stevens, "EMU, A New 10MV Electron Beam Machine at AWE", M6-4, these proceedings.
- [13] S. Strasburg, D. D. Hinshelwood, J. W. Schumer, D. Mosher, and P. F. Ottinger "Strongly-perturbed non-equilibrium gas physics model for the paraxial diode transport cell," these proceedings.
- [14] D. D. Hinshelwood, D. P. Murphy, P. F. Ottinger, D. M. Ponce, "Electron-beam transport studies for radiographic applications," these proceedings.
- [15] D. R. Welch, D. V. Rose, B. V. Oliver, E. Schamiloglu, K. Hahn, and J. E. Maenchen, "Transport of a relativistic electron beam in gas and plasma-filled focusing cells for x-ray radiography," submitted to *Phys. Plasmas* (2003).
- [16] S. Strasburg, D. D. Hinshelwood, J. W. Schumer, D. Mosher, P. F. Ottinger, "Strongly-Perturbed Non-Equilibrium Gas Physics Model for the Paraxial Diode Transport Cell", TP-05, these proceedings.

[17] G. M. Cooper et al, "Recent Immersed Bz X-ray Diode Experiments", 14<sup>th</sup> International Conference on High-Power Particle Beams, June 23-28, 2002, pp. 155-159.

[18] D. C. Rovang, D. Welch, H. Ives, D. L. Johnson, M. Kincy, B. Lesch, J. Maenchen, P. Menge, I. Molina, B. Oliver, C. Olson, C. Swenson, and D. VanDeValde, "Status and plans for the next generation manetically immersed diodes on RITS," in the Proc. 14th Intl. Conf. High-Power Particle Beams, T. A. Mehlhorn and M. A. Sweeney, eds. (American Institute of Physics, CP650, 2002), p.127-130.

[19] D. M. Ponce, D. Phipps, D. D. Hinshelwood, and B. V. Weber, "Spatial and time resolved interferometry for plasma filled rod pinch diodes," these proceedings.

[20] F. C. Young, R. J. Commisso, R. J. Allen, D. Mosher, S. B. Swanekamp, G. Cooperstein, F. Bayol, P. Charre, A. Garrigues, C. Gonzales, F. Pompier, and R. Vezinet, "Rod-pinch diode operation at 2 to 4 MV for high resolution pulsed radiography," Phys. Plasma, 9, 4815-4818, (2002).

[21] R. J. Commisso, F. C. Young, R. J. Allen, D. Mosher, S. B. Swanekamp, G. Cooperstein, C. Vermare, J. Delvaux, Y. Horde, E. Merle, R. Nicolas, D. Nore, O. Pierret, Y. R. Rosol, Y. Tailleux, L. Veron, F. Bayol, A. Garrigues, C. Delbos, G. Nicot, B. V. Oliver, D. V. Rose, D. Rovang, D. L. Johnson, J. Maenchen, and K. Prestwich, "Overview of the 6-MV, rod-pinch experiment on Asterix," these proceedings.

[22] S. B. Swanekamp, R. J. Allen, R. J. Commisso, G. Cooperstein, D. Mosher, F. C. Young, C. Vermare, J. Delvaux, Y. Horde, E. Merle, R. Nicolas, D. Nore, O. Pierret, Y. R. Rosol, Y. Tailleux, L. Veron, F. Bayol, A. Garrigues, C. Delbos, B. V. Oliver, D. V. Rose, and J. Maenchen, "Angular dose variations from 4-6 MV rod-pinch experiments on the Asterix pulsed-power generator," these proceedings.

[23] D. D. Hinshelwood, G. Cooperstein, D. Mosher, P. F. Ottinger, J. W. Schumer, S. J. Stephanakis, S. B. Swanekamp, B. V. Weber, and F. C. Young, "Improvement in rod-pinch diode performance with anode heating," in the Proceedings of the 14<sup>th</sup> International Conference on High-Power Particle Beams (Albuquerque, NM, June 2002), p. 203-206.

Particular thanks to D. V. Rose (MRC) and P. F. Ottinger (NRL) for their helpful comments in the writing of this paper.

Sandia (SNL) is a multiprogram laboratory operated by Sandia Corporation, a Lockheed Martin Company, for the United States Department of Energy's National Nuclear Security Administration under contract DE-AC04-94AL85000.

© Crown Copyright (2003)

"This document is of United Kingdom origin and contains proprietary information which is the property of the Secretary of State for Defence. It is furnished in confidence and may not be copied, used or disclosed in whole or in part without prior written consent of the Director Commercial 2, Defence Procurement Agency, Ash 2b, MailPoint 88, Ministry of Defence, Abbey Wood, Bristol, BS34 8JH, England".

## XII. ACKNOWLEDGEMENTS

The material presented in this paper has been the result of the work of many researchers at AWE, SNL, NRL, MRC, Titan PSD, LANL, CEA, DGA and Bechtel.