

FEB 12 1947

ARR No. 4H30

NATIONAL ADVISORY COMMITTEE FOR AERONAUTICS

# WARTIME REPORT

ORIGINALLY ISSUED

November 1944 as  
Advance Restricted Report 4H30

TANK TESTS ON THE RESISTANCE AND PORPOISING CHARACTERISTICS OF  
THREE FLYING-BOAT HULL MODELS EQUIPPED WITH PLANING FLAPS

By F. W. S. Locke, Jr., and Jean A. Barklie  
Stevens Institute of Technology

NACA LIBRARY  
LANGLEY MEMORIAL AERONAUTICAL  
LABORATORY  
Langley Field, Va.

# NACA

WASHINGTON

NACA WARTIME REPORTS are reprints of papers originally issued to provide rapid distribution of advance research results to an authorized group requiring them for the war effort. They were previously held under a security status but are now unclassified. Some of these reports were not technically edited. All have been reproduced without change in order to expedite general distribution.

NACA ARR No. 4H30

## NATIONAL ADVISORY COMMITTEE FOR AERONAUTICS

## ADVANCE RESTRICTED REPORT

TANK TESTS ON THE RESISTANCE AND PORPOISING CHARACTERISTICS OF  
THREE FLYING-BOAT HULL MODELS EQUIPPED WITH PLANING FLAPS

By F. W. S. Locke, Jr. and Jean A. Barklie

## SUMMARY

This report presents the results of exploratory model experiments on the resistance and porpoising characteristics of flying-boat hulls equipped with retractable planing flaps. The experiments were made in the course of an investigation which had the twofold objective of developing a flap-hull combination which would have:

1. With the flap extended, hump-resistance characteristics at least equal to those of the selected reference ship, the XPB2M-1 flying boat.
2. With the flap retracted, much better upper-limit porpoising characteristics at planing speeds.

Both of the above objectives have been realized with a planing flap attached to the afterbody, about two beams abaft the main step of hulls which have high upper limits of stability with no flap. Three combinations of hull and afterbody flap, together with possible operating procedures, are suggested as having practical possibilities. These are discussed on pages 11 to 15.

With the first two combinations, the hump resistance is about equal to the corresponding value for the XPB2M-1 flying boat, and the peak of the curve of lower limits of stability is lower. By retracting the flap as soon as planing is established, upper-limit porpoising is eliminated.

The above advantages of planing flaps when attached to the afterbody were not obtained when the planing flaps were attached to the forebody. Forebody flaps were found to have harmful effects on the hump resistance. They lowered to a very appreciable extent the lower limit of stability at moderate and high planing speeds, but had little effect on the position of either the peak of the lower-limit curve, or the upper-limit curve.

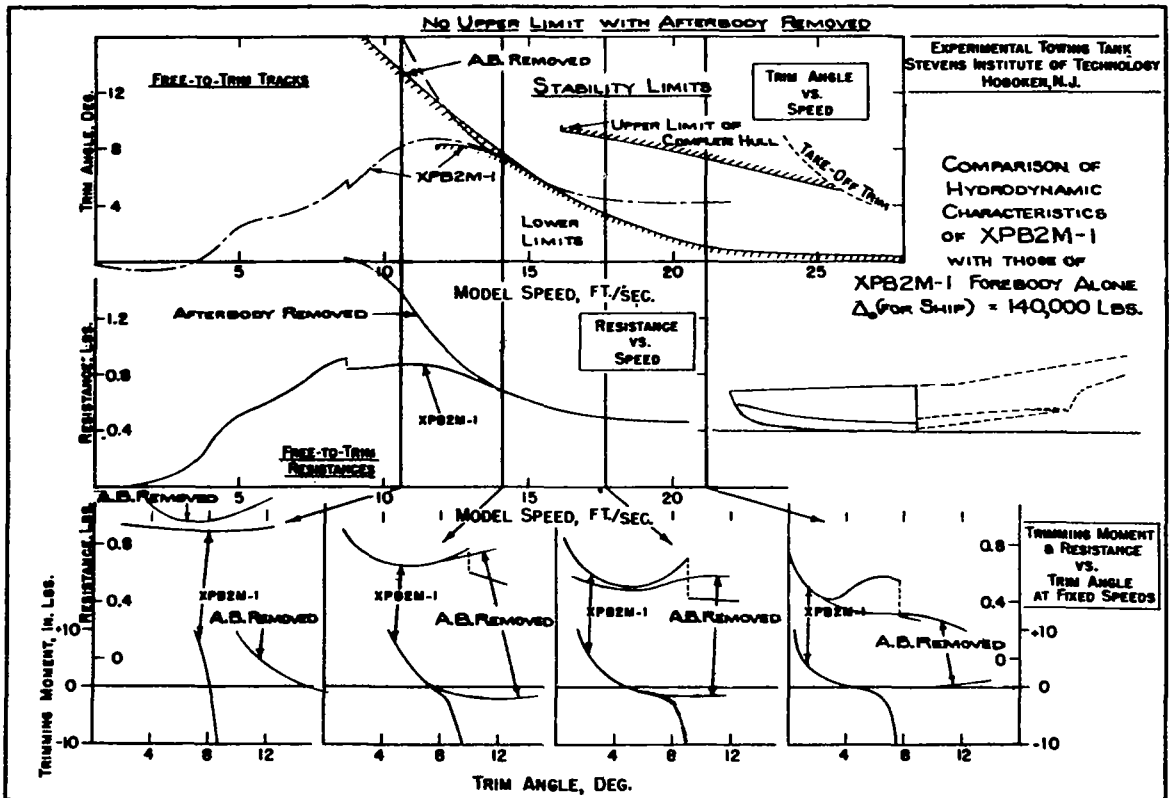
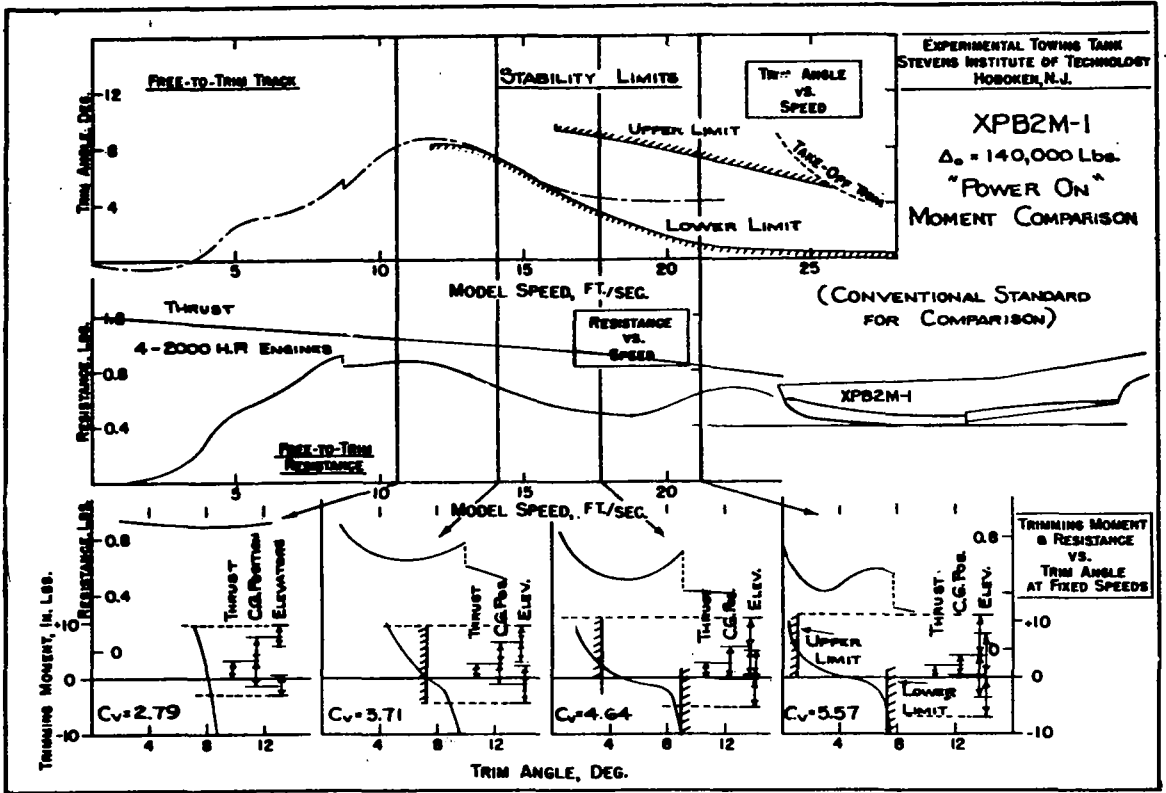

## INTRODUCTION

A study of previous model tests of certain flying-boat hull designs, made both with the complete hull and with the forebody alone, suggested possibilities for improved performance by the use of auxiliary trim-control devices operative at speeds up to a little above the hump speed.

The upper chart on the opposite page shows the resistance and porpoising characteristics of a conventional flying boat, the XPB2M-1, as determined at this Tank (reference 1), and the relation of these characteristics to estimated aerodynamic control moments, thrusts, and so forth.

It will be seen from this chart that:

- (a) The hump resistance is less than the available thrust. Therefore, take-off is possible.
- (b) The available control moments, over most of the range of planing speeds, are sufficient to permit holding the trim between the basic porpoising limits. Therefore, take-off substantially free of porpoising should be possible under ordinary operating conditions.
- (c) The trim angles for optimum resistances at high planing speeds lie between the basic porpoising limits. Therefore, trims which are desirable from the point of view of resistance do not involve porpoising.

Thus, the hydrodynamic characteristics exhibit no major defects. On the other hand, they cannot be said to provide sufficient margins, even for the indicated gross load, and without considering higher loadings. In particular:

- (a) The hump resistance is close to the available thrust.
- (b) The range of stable trim angles is narrow (i.e., the range between the basic porpoising limits).
- (c) There is a short range of planing speeds just above the hump within which the trim cannot readily be held above the lower porpoising limit. This range may be especially important in practice because, in accelerated take-off, the trim may be falling from its peak value at the hump, thus providing an initial disturbance to help induce porpoising.

The lower chart on the opposite page is a comparison of some of the hydrodynamic characteristics for the complete hull, with corresponding characteristics obtained for the forebody alone, under otherwise identical conditions (reference 2). This comparison reveals at once that the afterbody is useful only during the lower speeds of the take-off run and that its presence at higher speeds is entirely detrimental. It is clear that the afterbody,

- (a) At rest and at "displacement" speeds, provides flotation,
- (b) At moderate speeds, up to the hump, controls trim and resistance, and prevents lower-limit porpoising,
- (c) At high, planing speeds, is the direct cause of upper-limit porpoising and somewhat increased resistances. (It may also be the cause of poor landing characteristics. as is known from other work.)

The chart suggests that the forebody - essentially a stepless, V-bottom, planing boat with the center of gravity far aft - is the main hull, and that, at planing speeds, it is entirely self-sufficient and needs no help from the afterbody. From this point of view, the afterbody is really an appendage, the function of which is to provide lifting force and nosing-down moment until true planing of the main hull has been established. If the afterbody performed this function adequately and without undesirable consequences, it would constitute a satisfactory solution of the problem of trim control. But its performance is neither adequate nor without undesirable consequences; in other words, it has not reduced the hump resistance to a matter of secondary importance and it has introduced upper-limit porpoising.

Evidence exists (reference 2) to show that, in general, alterations to the afterbody form which cause a reduction in the hump resistance tend also to lower the upper limit of stability, and that alterations which raise the upper limit of stability tend also to increase the hump resistance. It appears, then, that the design of the afterbody is governed by two very antagonistic considerations, and that neither is very well satisfied in acceptable conventional hulls. There may be exceptions to this general rule, and better afterbody forms with respect to both considerations should be sought. However, the outlook for large improvements is not sufficiently promising to justify disregarding other directions of attack which may suggest themselves.

The fact that, for best results, the afterbody ought to be much more effective at moderate speeds and much less effective at high speeds naturally suggests some sort of adjustment with speed. It is obviously impossible to consider an adjustable afterbody bottom - however desirable that might be. It seems possible, however, to consider the use of retractable flaps - or, more strictly, planing surfaces - which, applied to a hull having an afterbody sufficiently ineffective to eliminate upper-limit porpoising as a practical consideration at high speeds, would produce the effectiveness at hump speeds needed to suppress lower-limit porpoising and to reduce the hump resistance.

The objective of the work considered in this report was to develop a flap-and-hull combination having,

- (a) With the flap extended, less maximum resistance than the XPB2M-1 hull in the region of the hump, in combination with,

- (b) A sufficiently low peak of the lower porpoising limit to eliminate the probability of this type of porpoising in the region where the peak occurs (near the hump), and
- (c) With the flap retracted, upper limit porpoising at trim angles well above the normal operating range at all speeds in the planing range.

Wind tunnel investigations have suggested (reference 3) that the present conventional type of afterbody contributes a large part of the excess aerodynamic drag of flying-boat hulls as compared with landplane fuselages. It has just been pointed out that the conventional type of afterbody has undesirable hydrodynamic characteristics. Therefore, the logical ultimate objective of a comprehensive study of flaps should be to develop a flap capable of performing all of the useful hydrodynamic functions of the conventional afterbody, and capable of being retracted into an afterbody which has low aerodynamic drag. Such an afterbody would presumably have neither chines nor projecting planing bottom.

The work here considered was conducted under the sponsorship of, and with the financial assistance of, the National Advisory Committee for Aeronautics.

#### DEVELOPMENT OF INVESTIGATION

Three models were used in the present investigation. The first, No. 339-7, was used in a previous project (reference 2). The other two, Nos. 408-1 and 522-1, were designed specifically for this investigation.

Various designs and locations of flaps were tested, both on the afterbody and on the forebody and with various angles of attack and sternpost angles. The various angles are defined in the following sketch.

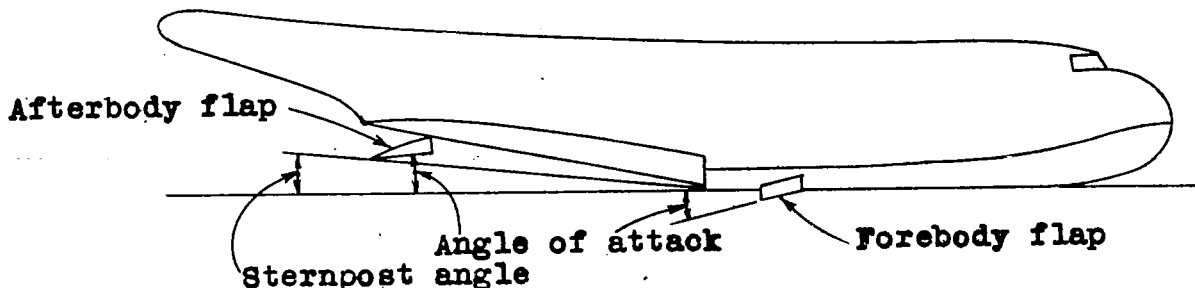

It was pointed out in the Introduction that a suitable null for use with flaps should have an afterbody sufficiently ineffective to eliminate difficulty with upper-limit porpoising at high speeds. Since Model 339-7 (body plans and profile shown on pp. 19 and 20, respectively) fulfilled this requirement - upper-limit porpoising occurring only at very high trim angles (reference 2) - it was selected for the first trials with flaps. This model has the hull lines of the XPB2M-1, but the afterbody angle is raised from 7 to 12 degrees. The alteration, which left the step height unchanged, was accomplished by rotating the afterbody about the point of intersection of the afterbody keel with the main step. Increasing the afterbody angle raised the upper porpoising limit to well above that of the normal hull, but it also raised the peak of the lower-limit curve, and greatly increased the hump resistance. It was hoped that, by attaching a flap, both the hump resistance and the peak of the lower-limit curve might be materially lowered while, by retracting the flap at higher speeds, the high upper limit could be retained.

The first flap tested (p. 27) was attached to the forebody of this hull and was set at an angle of attack of  $10^{\circ}$  relative to the forebody keel. This flap, designated as F1, was investigated, in combination with the hull, for specific free-to-trim resistance at three longitudinal locations, and for porpoising at two of these locations. At all locations tried, it caused large increases in hump resistance and had practically no effect on the peak of the lower-limit curve. At moderate and high planing speeds, it very markedly lowered the lower limit, but this was not considered of importance in view of other disadvantages.

The extremely high hump resistance found with forebody flap F1 on Model 339-7 indicated the improbability that sufficient improvements could be effected to make forebody flaps practical. It was therefore thought advisable to place more emphasis on afterbody planing flaps in all further experiments. A new model was accordingly built which included provision for testing flaps in a wide variety of locations on the afterbody. The afterbody of the new model was made about 40% longer than that of the reference ship, so that the effect of the longitudinal flap location could be fully explored. At the same time, the afterbody angle was raised from  $12^{\circ}$  to  $14^{\circ}$  to give better insurance against upper-limit porpoising at high speeds. The step height was left unaltered at 5% of the beam. The resulting model, which retained the forebody of the XPB2M-1, was designated No. 408-1 (pp. 19 and 20 show body plans and profile).

Two forebody flaps (F2 and F3, see pp. 29 and 31) were tested with this model in an effort to improve upon the very high hump resistances. However, the hump resistances were still so high that the investigation of forebody flaps was discontinued at this point.

Five afterbody flaps (A1 through A5, see pp. 33 to 43) were tested on Model 408-1. The first two flaps (A1 and A2) were investigated at one longitudinal location to determine how much flap area would be required to give reasonably low resistances in the hump region. The first flap, A1, was located beneath the sternpost of the hull, and had a triangular shape so that it would closely fit the afterbody bottom of the hull when

retracted. The hump resistance with this flap was very high. It was thought that if the area of the flap were increased, the running trim angles, and consequently the resistance, might be lowered. Therefore, the next flap, A2, was larger. The increased area had some beneficial effect upon the hump resistance, but the sharply pointed trailing edge of this flap was apparently the cause of a very rapid trim oscillation - or "chattering" - not previously found. It was hoped that the latter would be eliminated if the sharply pointed trailing edge of the flap were cut off. The third flap, A3, was designed from this point of view. It was located at about the same longitudinal position as the first two afterbody flaps, but its area was intermediate between them, and its after end was squared off. The reduction of area did not appreciably harm the resistance, and the "chattering" was eliminated.

The hump resistance was far from satisfactory with any of these three afterbody flaps - A1, A2, or A3. However, it appeared from observations of the tests that the high peak in the resistance curve at the hump might be caused by the forebody roach wetting the afterbody bottom ahead of the flap. So a new flap, A4, was constructed, having approximately the same area as flap A3, but located much farther forward - quite near the step. In this position, however, the roach built up by the flap wet the afterbody, and the resistance remained high. A fifth flap, A5, again of about the same area, was then located halfway between the previous two flap locations. It was hoped that this flap would be far enough forward to prevent the forebody roach from striking the afterbody ahead of the flap, and at the same time far enough aft to prevent the flap roach from striking the afterbody aft of the flap. The tests supported the reasoning, for neither roach struck the afterbody, and the resistance in the vicinity of the hump was very much improved.

Now that a reasonably good size and location for the flap had been found, attention was focused on two rather objectionable features of Model 408-1 which were evident when it was used in conjunction with afterbody flaps. These were: (1) the unusually high pre-hump resistances; (2) the fact that the model dove with many of the flaps when they were adjusted to low sternpost angles. It was thought that these two objections might be overcome in a hull of somewhat different design, while retaining the good points of the 408 flap-hull combinations.

The high afterbody angle of Model 408-1 was rather extreme; it was thought that a moderate reduction might lower the pre-hump resistances by impeding the flow of water to the upper surface of the flaps. Consequently, the afterbody angle of a new model, No. 522-1 (body plans and profile on pp. 19 and 20) was reduced to  $9^{\circ}$ . Also, since the best longitudinal location for the flap found in the case of the Model 408-1 had been about in the middle of its afterbody length, there did not seem to be any reason for extending the afterbody of the new model farther aft. Accordingly, Model 522-1 was designed to have an afterbody length 60% of that of Model 408-1 - a little shorter than the afterbody of Model 339-7. A flap located at the rear of the afterbody of Model 522-1 is the same number of inches aft of the main step as a flap at the optimum longitudinal location determined on Model 408-1. The length of the forebody of the new model was made 18% longer than that of Model 408-1 in an effort to overcome the objection to diving mentioned above.

The new model, Model 522-1, equipped with flaps, accomplished the desired results; the pre-hump resistances of every combination were lower than any flap-hull combination tried with Model 408-1 and, although diving with low sternpost angles was not entirely suppressed, the tendency to dive was much reduced. In addition, some reduction of true hump resistance was accomplished.

From the standpoint of air drag, Model 522-1 would probably be a more practical design than Model 408-1 because of the exaggerated afterbody angle and length of the latter. (See references 3 and 4.)

Note: The development of the program of testing for this investigation is described in more detail in three unpublished progress reports by the Experimental Towing Tank, Stevens Institute of Technology. Copies of these reports are on file at the National Advisory Committee for Aeronautics, Washington, D. C.

#### PROCEDURE

The broad nature of the problems involved in the use of flaps indicated that, in an initial investigation of the sort considered in this report, emphasis should be put on exploring the possibilities of a fairly large number of flap applications in brief fashion rather than on detailed studies of a few flap applications. For this reason, the tests on each individual flap-hull combination were much restricted in scope, and only those tests which permit direct comparison with the characteristics of a specific flying boat, the XPB2M-1, are included here.

The resistance tests were made with the same apparatus as that used for the 1/30-scale models comprising modifications of the XPB2M-1 flying boat in reference 2, and were conducted in the same manner. This means that the loadings were in accordance with the test particulars given on page 18, except that a parabolic curve ( $C_{\Delta_0} = 0.89$ ) was used. A few of the early tests were made with somewhat different loadings, but the results have been transposed by the method described in reference 5 to be consistent with all of the later data.

The porpoising tests were made with the same apparatus used for the 1/30-scale models comprising modifications of the XPB2M-1 flying boat in reference 2, and were conducted in the same manner.

## RESULTS

The results of all the tests are given on pages 23 to 50. The test data as obtained from the model tests are plotted on the type of summary chart used in reference 2. Besides showing the effect of changes of settings of certain of the flaps, these charts permit direct comparison of the hydrodynamic characteristics considered for each case with those of the XPB2M-1 model selected as a reference. Comparisons between different flap arrangements can be obtained by comparing the various sheets.

Each chart gives the following information:

1. On trim angle vs. speed grid
  - (a) Stability limits (for  $2^\circ$  oscillation)
  - (b) Free-to-trim track\*
  - (c) Take-off trim tracks
2. On resistance vs. speed grid

Free-to-trim resistances

In addition to the above-mentioned data, a profile view of the model is given which shows the relation of flap and flap setting to the hull. Opposite each chart is a page giving additional pertinent information on the test as well as a brief discussion of the results.

The results of tests with afterbody flaps suggest at least three ways in which such flaps might be applied in a practical design. The best flap-hull combination tested to date in each category has been selected to illustrate these three ways. These are discussed individually on pages 11, 13, and 15, with charts on corresponding facing pages.

---

\*The trim track corresponding to resultant aerodynamic moments about the center of gravity equal to zero, as obtained by interpolation. The track is for the hull alone (plus flaps where used), not for the complete airplane.

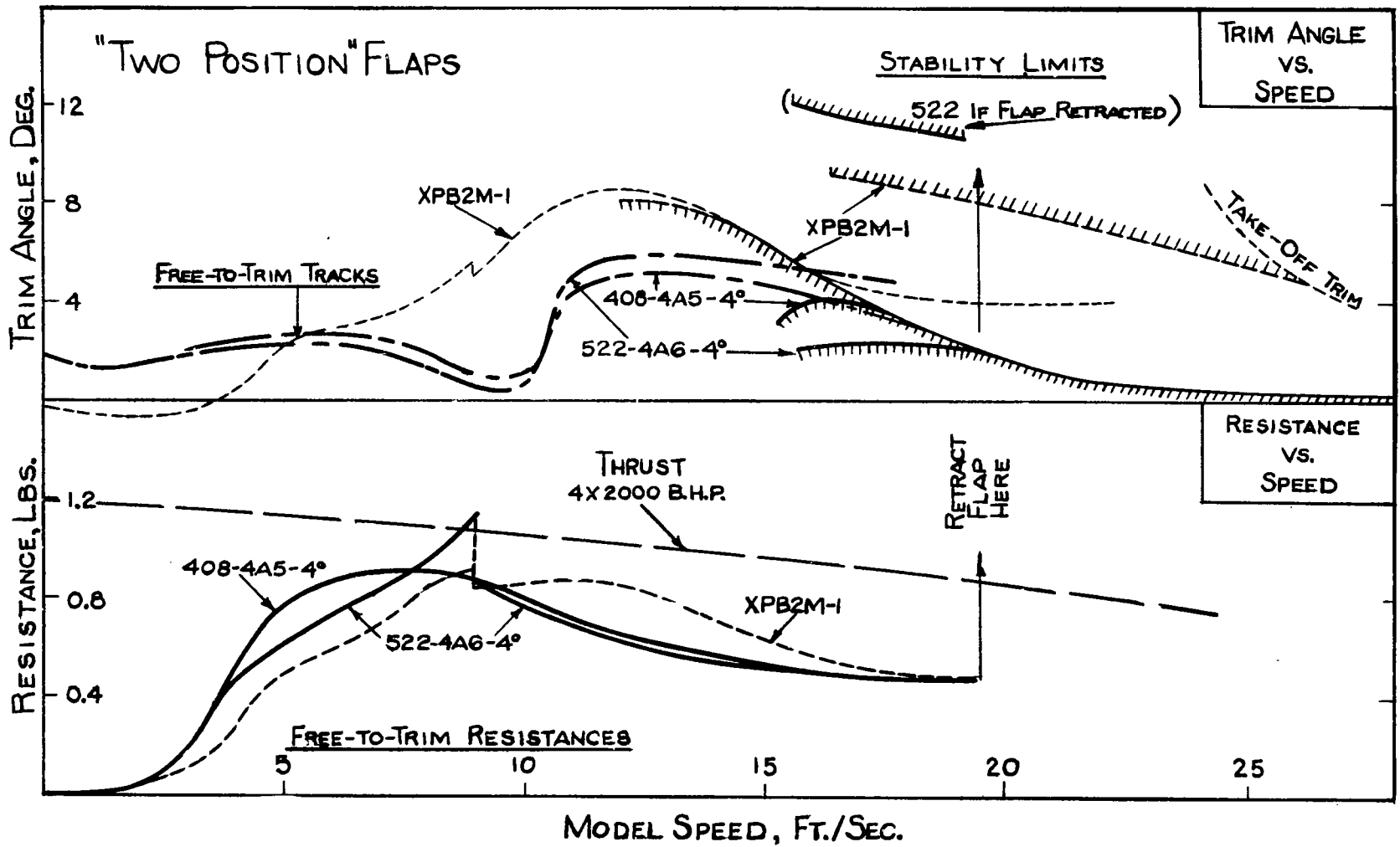

Resistance and Porpoising Characteristics of an arrangement of Flap and Hull for each of Models 408-1 and 522-1, compared with the characteristics of the XPB2M-1 Model. These are the best cases for each model when limited to a fixed-position flap up to speeds of 19 feet per second and the flaps thereafter retracted.

Note: Upper-limit porpoising will occur above 19 feet per second if the flaps are not retracted.

"Two-Position" Flap.- The opposite page shows the characteristics for two arrangements involving the use of a flap fixed at one angle of attack and one sternpost angle until the planing range is reached, at which time it is retracted. The best case with each of Models 408 and 522 is shown.

Take-off is possible with 408-4A5-4°\*, but not with 522-4A6-4° without more power because of a high local peak in the resistance curve at about 9 feet per second. It is thought, however, that this peak might be reduced very considerably by curving the leading edge of the flap upward slightly, since the high-resistance peak is apparently caused by water passing over the top of the flap. Such a change is not likely to harm the resistance at other speeds, and if the peak were reduced, 522-4A6-4° would be somewhat superior to 408-4A5-4° because of the better location of its free-to-trim track, its much lower peak for lower-limit porpoising and its lower resistance at other speeds.

Although the trim angle would reach very low values if the flap were fixed at a single position until well within the planing range, it remains low for only a very short speed range in the vicinity of 10 feet per second, where use of the flap is contemplated.

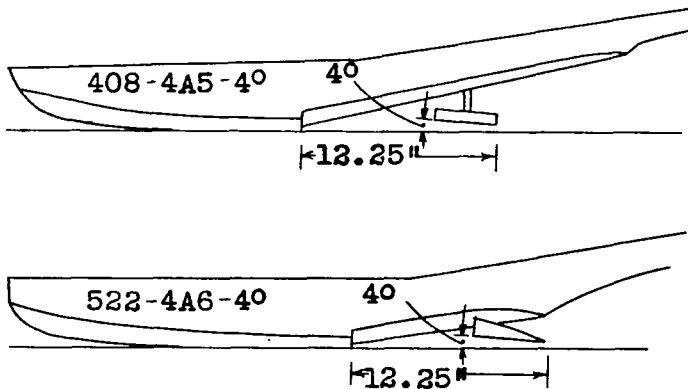

---

\*Model 408-1, angle of attack 4°, afterbody flap A5 and sternpost angle 4°.

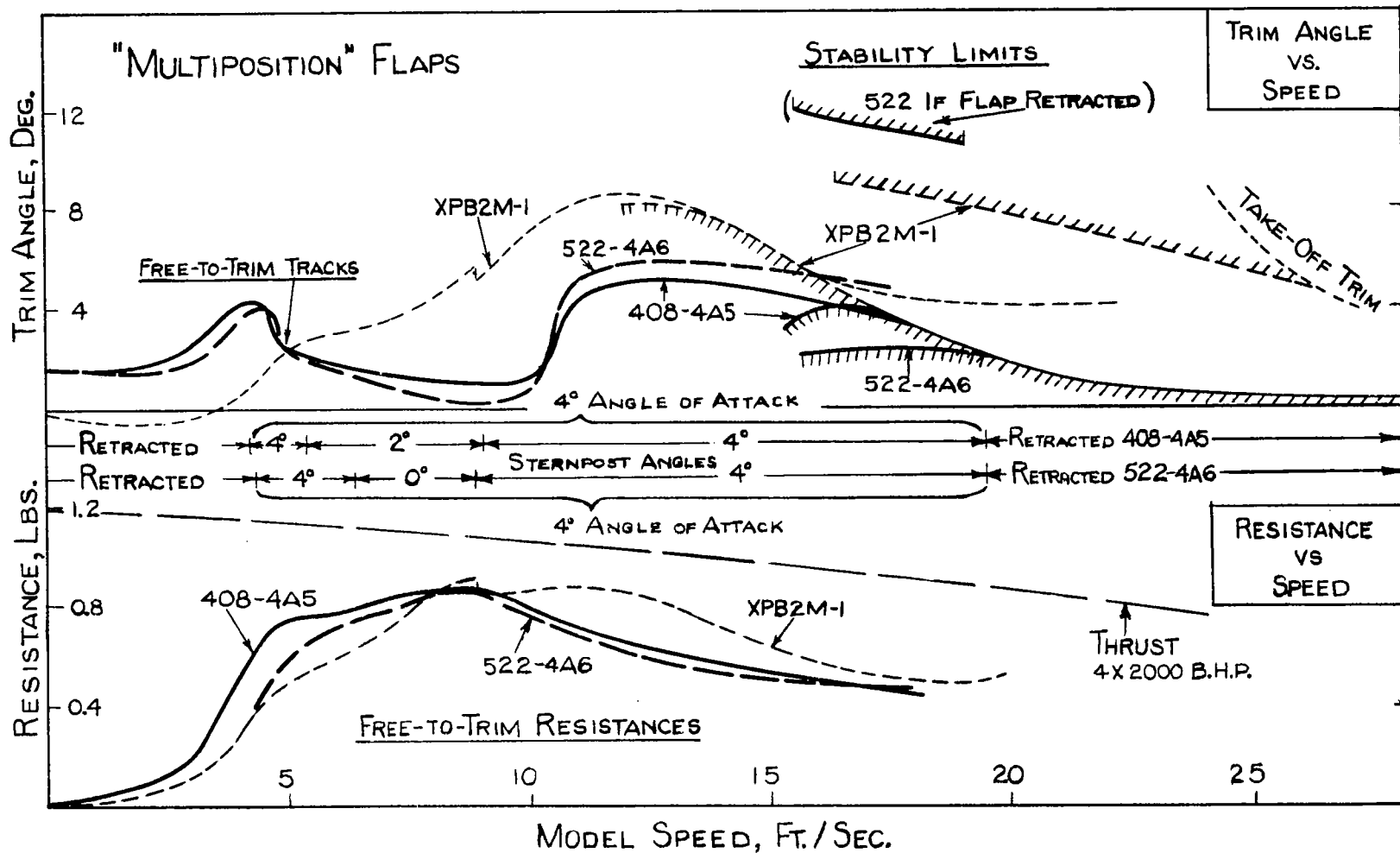

Resistance and Porpoising Characteristics of an arrangement of Flap and Hull for each of Models 408-1 and 522-1, compared with the characteristics of the XPB2M-1 Model. In these arrangements, the flap is retracted up to about 4 feet per second - then, with a 4° angle of attack, set at various sternpost angles up to about 19 feet per second, after which it is retracted. This method gives the optimum resistance over the whole speed range.

"Multi-Position" Flap.- The opposite page shows the best results obtainable if the sternpost angle of the flap is adjusted with changes of speed as indicated - the angle of attack of the flaps remaining fixed, however, as before. The sternpost angle is adjusted to obtain the best resistances throughout the speed range up to, and just beyond, the hump. The flap is completely retracted in the planing range just before the speed at which upper-limit porpoising would commence with the flap down.

Of the two models, 522-4A6 has the better resistance characteristics over the entire speed range, even better than the hull of the normal XPB2M-1. A further advantage of 522-4A6 is that the free-to-trim track with the flap down passes well above the peak of the lower limit and hence there would be no danger of lower-limit porpoising in this region. A disadvantage common to both models is that at speeds between 5 and 10 feet per second, the trims are quite low and the bow spray in rough water might be quite bad, though this is no more serious than in the "two-position" cases, page 11.

The resistance characteristics of both of the flap-hull combinations, used in this manner, are somewhat better than those of the "two-position" cases. Neither of the "multi-position" flap cases has the high local peak at about 9 feet per second; both have lower resistances between 5 and 8 feet per second. On the other hand, the "multi-position" plan has two obvious disadvantages compared to the "two-position" plan. The mechanism required to move the flap up and down in the presence of comparatively large water loads on the flap at hump speeds would probably weigh considerably more than if the mechanism were merely required to retract the flap in the planing range. Secondly, the adjustment would require the constant attention of a crew member to insure proper setting at each speed. Therefore, while the "multi-position" flap is a little more attractive from the hydrodynamic viewpoint, it is probably less desirable than the "two-position" flap from the viewpoint of practicability.

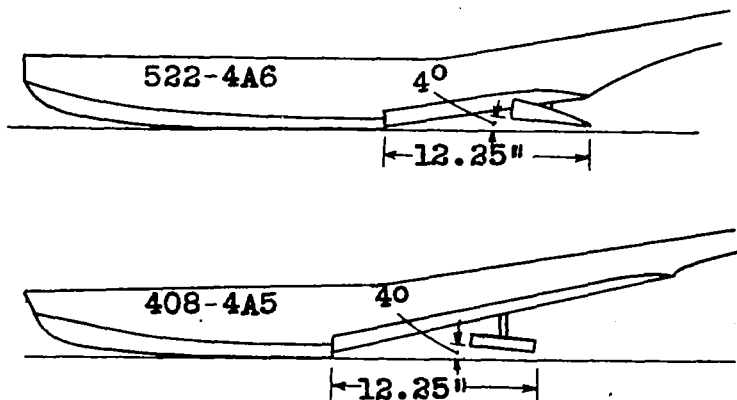

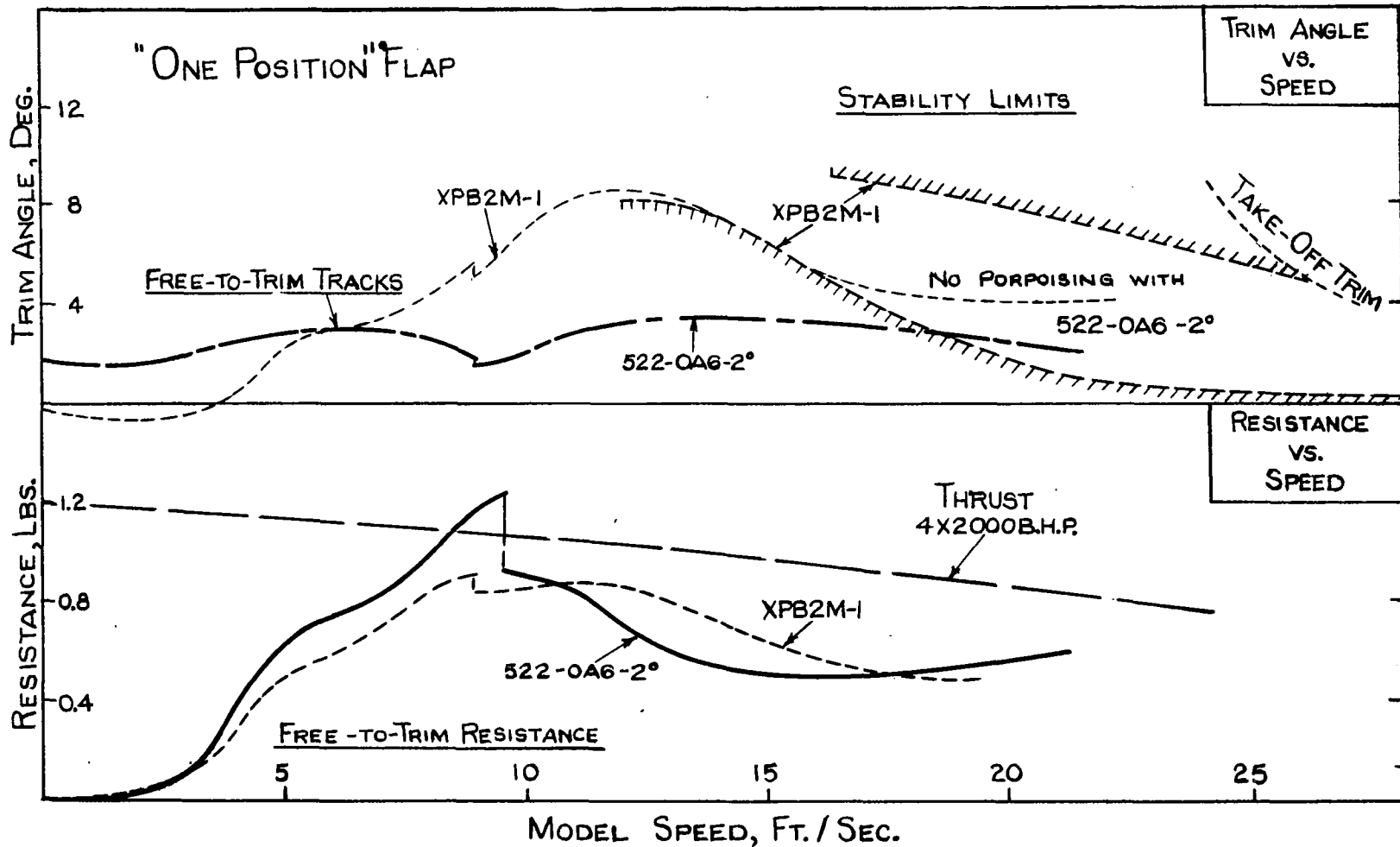

Resistance and Porpoising Characteristics of 522-OA6-2° with flap fixed at one position throughout take-off run, compared with characteristics of XPB2M-1 Model. This combination neither dives nor porpoises.

"One-Position" Flap.- A third way of using an afterbody flap, whereby the flap is left at one fixed position until the flying boat is air-borne, as shown on the opposite page. Of the various flap-hull combinations tried, the only one which can be considered suitable for this plan is 522-OA6-2°. In this combination with the flap set at a sternpost angle of about 2°, both upper- and lower-limit porpoising are suppressed and, because of the lengthened forebody of Model 522 the low trim angles do not result in diving. Sternpost angles greater than 4° do not accomplish the purpose of eliminating porpoising and are therefore not considered here.

This case, with a 2° sternpost angle, has a higher hump resistance peak than the similar peak for the best "two-position" case for Model 522; presumably, however, this might be corrected in the same way as previously suggested - by a small change in the leading edge of the flap. Also, at about 100 feet per second, the resistance starts to increase; if the resistance had been investigated at higher speeds it might have been found too high to permit take-off with the available power.

The flap could be retracted after the flying boat is air-borne, and the mechanism to do this would probably not need to be very heavy. Another possibility is that the flap could be jettisoned, and thus save not only the weight of any retracting mechanism but also of the flap itself. A third suggestion is that the flap could be permanently attached to the hull and left there, though wind tunnel tests might well show this to be undesirable.

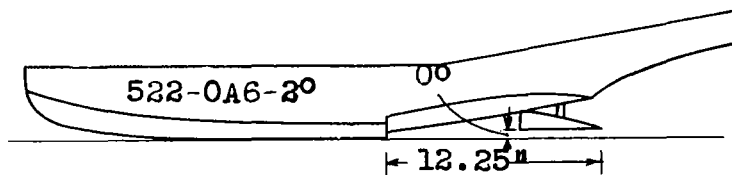

#### FURTHER DEVELOPMENTS

Because of its very high afterbody angle, Model 408-1 would probably have excessive aerodynamic drag, and on this account it is not considered suitable for further work.

The afterbody flaps on Model 522-1, which are retracted in the planing range, seem to offer the greatest possibilities for further development. However, before they could be considered for adoption in a practical design, the pre-hump peaks of their resistance curves would have to be materially reduced. At the same time, bow spray in rough water and the main spray characteristics ought to be investigated. It is not believed that the landing characteristics are likely to offer any great problem since the flap would be left retracted throughout the landing maneuver. The resistance and porpoising characteristics obtained to date are sufficiently encouraging to warrant further work along the lines mentioned.

The "one-position" flap on Model 522-1 offers some possibility for further improvement, although at the present stage of its development it has little to recommend its use in a practical design. Its hump resistances are too high, and it is impossible to predict what kind of landing characteristics would be obtained if it were found undesirable to jettison the flap or unnecessary to retract the flap for aerodynamic reasons. Because of the very low trim angles at high speeds, the possibility of broaching might become a ruling consideration and certainly should be investigated before undertaking any further work with this type of flap. If, however, the directional stability were found reasonably satisfactory, then further work might profitably be undertaken.

Whether the flap is retracted in the planing range or in flight, further work must be done to determine the contribution of the flap to the total water-borne load supported by the flap-hull combination. Preliminary experiments on flaps having poor resistance characteristics indicated that about 30% of the total water-borne load may be supported by the flap for a short range of speeds near the hump. Inasmuch as this is about 20 tons for a flying boat of the size of the XPB2M-1, it seems likely that the flap and its mechanism will be quite heavy; this may turn out to be the factor controlling whether or not flaps can successfully be applied to practical flying boats.

The ultimate objective of the flap investigation is to develop a flap that will serve the useful hydrodynamic functions of the afterbody of a flying-boat hull and will retract into an afterbody which is better aerodynamically than are present-day afterbodies. The advantages to be gained if this were accomplished appear great enough to justify further investigations of retractable planing flaps, even though present results indicate that considerable work may be necessary before flaps can be termed practicable.

Note: Since the investigations on forebody flaps (reported here) were made, a report has been published (reference 6) on the use of a retractable planing flap, instead of a fixed step, on a seaplane. The primary purpose of this flap was to enable the step height to be varied during the run up to take-off, so as to combine the low hump resistance which is associated with low step height with the low resistance and good stability characteristics at higher speeds which are associated with high step heights.

## CONCLUSIONS

The following conclusions may be drawn from the results of the tests made to date:

1. There is little to recommend the use of forebody flaps of the types tested in view of the fact that their hump trims, hump resistances, and peaks of the lower trim-limit-of-stability curves are much higher than those of the XPB2M-1 model. However, it should be noted that, for the forms tested, the lower limit is appreciably lowered at speeds above the peak and, at moderate and high planing speeds, the position of the upper limit is about  $4^\circ$  above that of the XPB2M-1.

2. It appears to be possible, with certain combinations of hulls and afterbody flaps, to produce resistance and porpoising characteristics which are equal to, or better than, those of the XPB2M-1 model. In particular, certain combinations (pp. 11 to 15) have been tested which, in comparison with the XPB2M-1 model, have

- (a) About the same resistance characteristics
- (b) General absence of upper-limit porpoising
- (c) Lower trim limits of stability considerably below practicable free-to-trim tracks

Experimental Towing Tank,  
Stevens Institute of Technology,  
Hoboken, N. J., August 30, 1944.

#### REFERENCES

1. Davidson, Kenneth S. M., and Locke, F. W. S., Jr.: Some Analyses of Systematic Experiments on the Resistance and Porpoising Characteristics of Flying-Boat Hulls. NACA ARR No. 3106, 1943.
2. Davidson, Kenneth S. M., and Locke, F. W. S., Jr.: Some Systematic Model Experiments on the Porpoising Characteristics of Flying-Boat Hulls. NACA ARR No. 3F12, 1943.
3. Parkinson, John B., Olson, Roland E., Draley, Eugene C., and Luoma, Arvo A.: Aerodynamic and Hydrodynamic Tests of a Family of Models of Flying-Boat Hulls Derived from a Streamline Body - NACA Model 84 Series. NACA ARR No. 3I15, 1943.
4. Hartman, Edwin P.: The Aerodynamic Drag of Flying-Boat Hull Models as Measured in the NACA 20-Foot Wind Tunnel - I. NACA TN No. 525, 1935.
5. Locke, F. W. S., Jr.: General Resistance Tests on Flying-Boat Hull Models. NACA ARR No. 4B19, 1944.
6. Benson, James M., and Lina, Lindsay J.: The Use of a Retractable Planing Flap Instead of a Fixed Step on a Seaplane. NACA ARR No. 3E31, 1943.

PARTICULARS AND SPECIFICATIONS (Normal)	Full size	Model			
Navy Designation	XPB2M-1				
Martin Model No.	170				
Martin Drawing No.	R240078				
Stevens Model No.				339-1	
Scale	1			1/30	
Dimensions					
Beam at main step, in.	162			5.40	
Angle between forebody keel and base line, deg	2.0			*2.0	
Angle between afterbody keel and base line, deg	5.0			5.0	
Height of main step at keel, in.	8.1			0.27	
Center of gravity forward of main step (26.58 percent M.A.C.), in.	70			2.33	
Center of gravity above base line, in.	146.7			4.89	
Gross weight, $\Delta$ , lb	140,000			5.19 f.w.	
Load coefficient, $C_{\Delta}$ (sea water)	0.89				
Moment of inertia in pitch, slug-ft <sup>2</sup>	$1.366 \times 10^6$				
lb-in. <sup>2</sup>	$6.328 \times 10^9$			260	
Wing area, $S$ , sq ft	3683			4.092	
Mean aerodynamic chord, M.A.C., in.	249			8.30	
Horizontal tail area, sq ft	508			0.565	
Distance, center of gravity to 35 percent M.A.C. horizontal tail (tail length), ft	63.6			2.12	
Ratios $\frac{\text{Full-size}}{\text{Model}}$					
Of speed, $\lambda^{1/2}$	5.477				
Of length, $\lambda$	$3.0 \times 10$				
Of area, $\lambda^2$	$9.0 \times 10^2$				
Of volume, $\lambda^3$	$27.0 \times 10^3$				
Of moment, $\lambda^4$	$81.0 \times 10^4$				
Of moment of inertia, $\lambda^5$	$243.0 \times 10^5$				
Aerodynamic characteristics					
$C_L$ at $\tau = 5^\circ$ (relative to base line, flaps $30^\circ$ )	1.585			1.585	
$dC_L/d\alpha$	0.1045			0.1045	
$dC_{M_{CG}}/d\alpha_{BL} = dC_{M_{CG}}/d\tau$ (av.)	0.0150			0.0150	
$dM/dq$ ,** lb ft sec/radian	$8020 \times v$			$9.90 \times 10^{-5} v$	
Get-away speed, fps	130			23.74	
Get-away $C_L$	1.890			1.890	
Get-away $\tau$ , deg	8.8			8.8	
Model dimensions					
Beam at main step, in.	5.40	5.40	5.40	5.40	
Angle between forebody keel and base line, deg*	2.0	2.0	2.0	2.0	
Angle between afterbody keel and base line, deg	5.0	10.0	12.0	7.0	
Forebody length, in.	18.60	18.60	18.60	21.43	
Afterbody length	14.85	14.85	20.25	12.25	
Step height, in.	0.27	0.27	0.27	0.27	
Hull length/beam ratio	6.19	6.19	7.19	6.24	
Forebody length/beam ratio	3.44	3.44	3.44	3.97	
Afterbody length/beam ratio	2.75	2.75	3.75	2.27	

\* All trim angles measured relative to the base line.

\*\* Contribution of horizontal tail surface only.

# BODY PLANS OF MODELS

SCALE:  $\frac{2}{5}$  OF MODEL SIZE

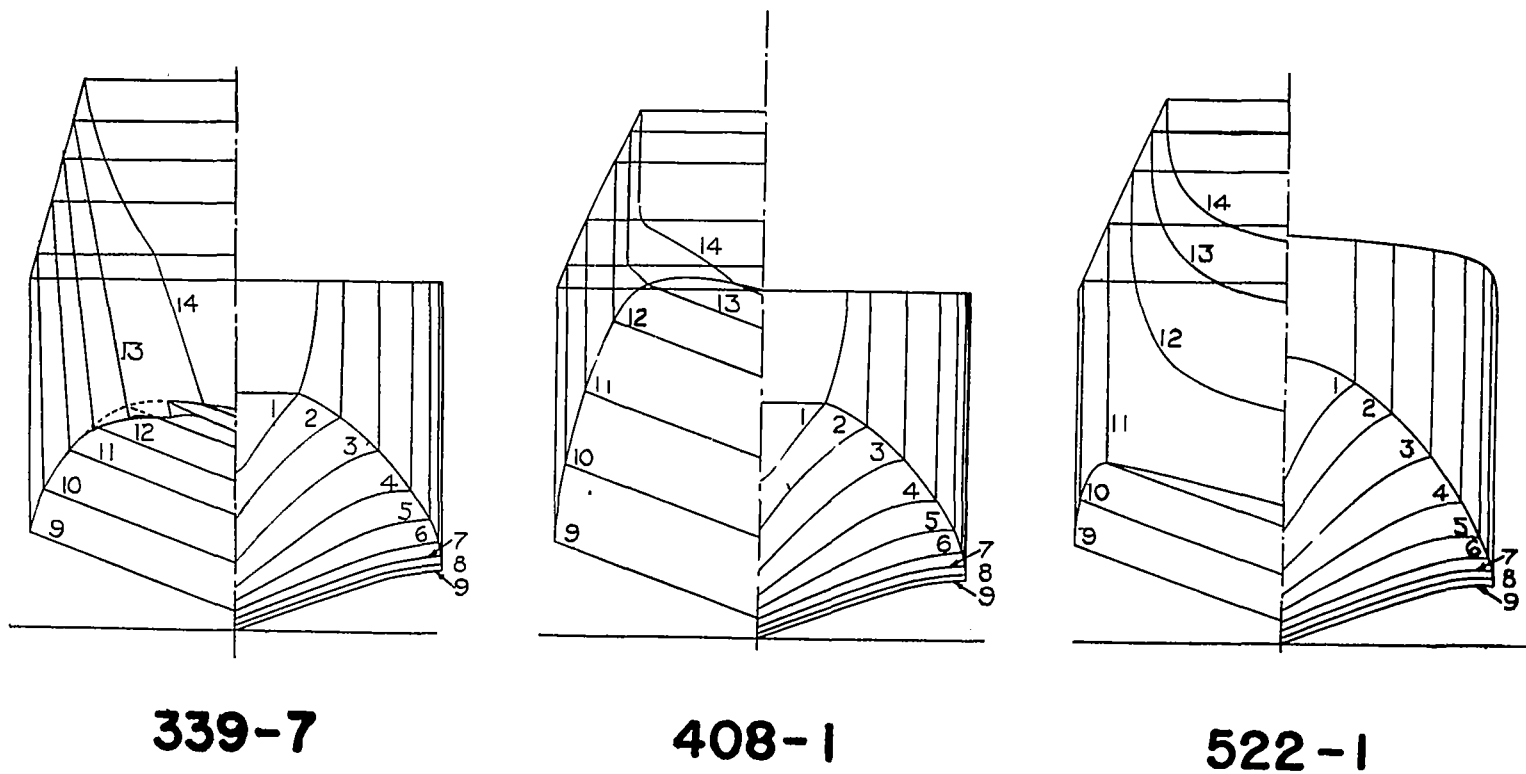
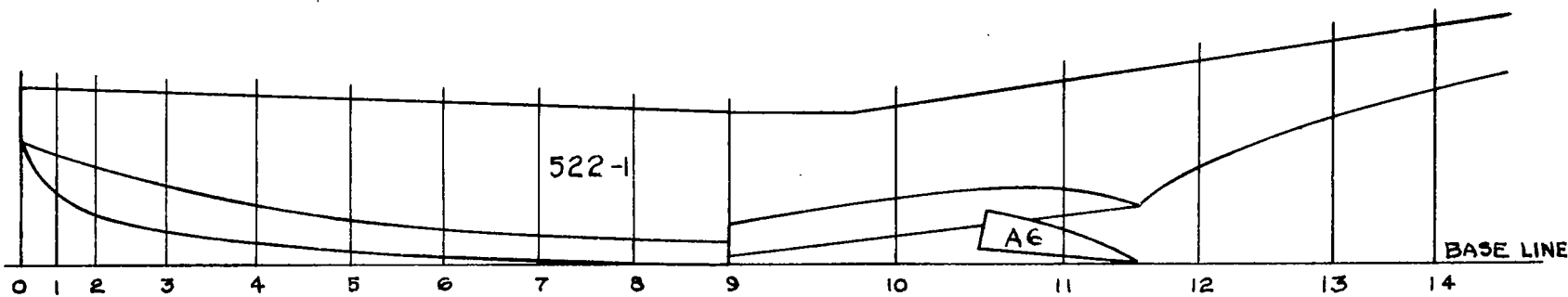
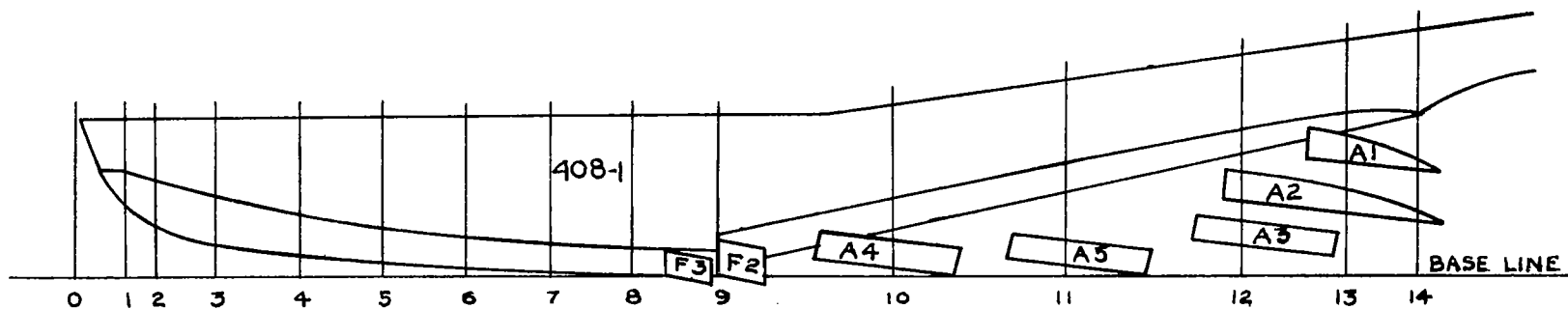
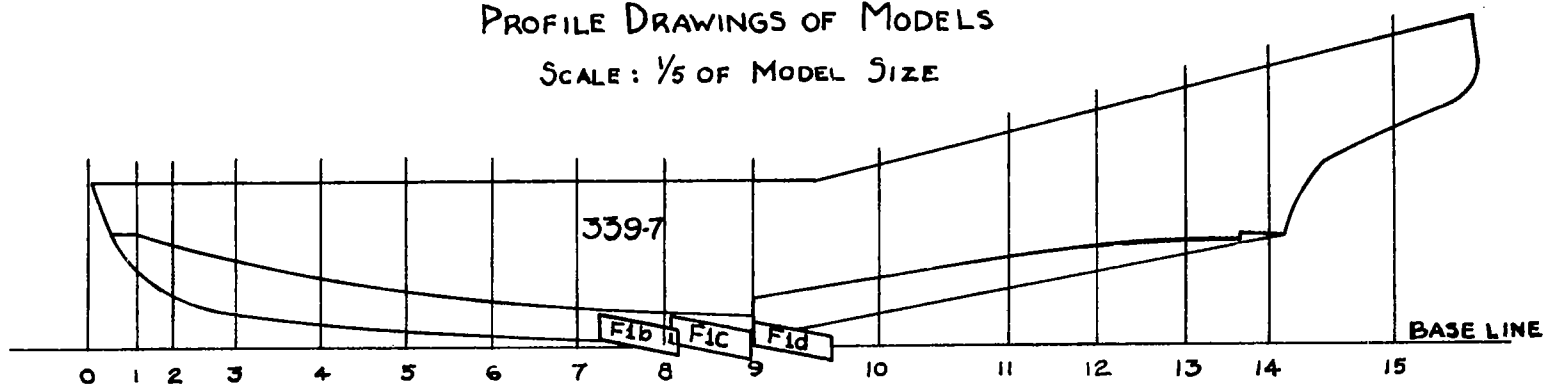

Figure 1

PROFILE DRAWINGS OF MODELS

SCALE: 1/5 OF MODEL SIZE

80  
FIG. 2



NACA ARR NO. 4H30

THE RELATIVE LONGITUDINAL LOCATIONS OF THE VARIOUS FLAPS ARE SHOWN  
Figure 2 ONLY ONE FLAP USED AT A TIME

### PLANVIEW OF FOREBODY FLAPS

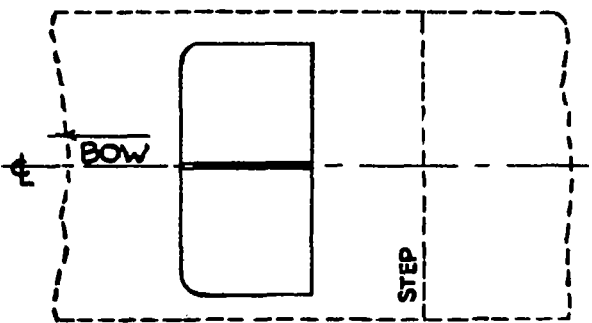

339-7-F1b

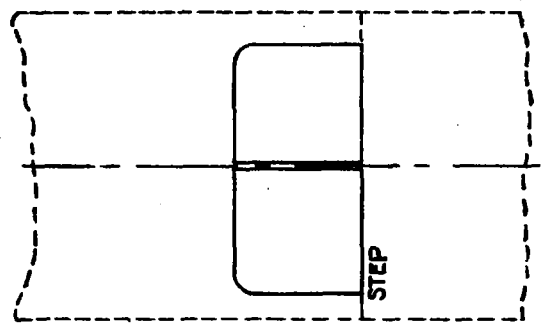

339-7-F1c

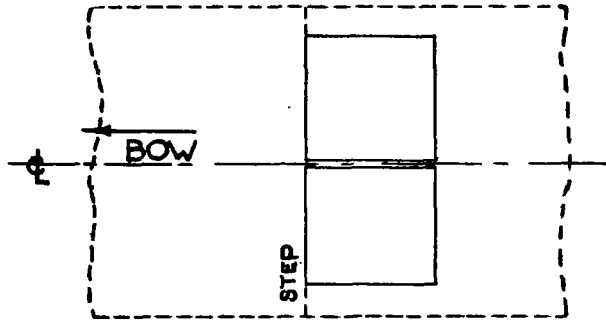

339-7-F1d

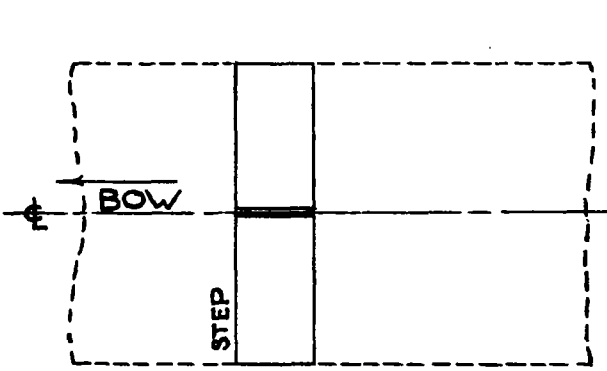

408-F2

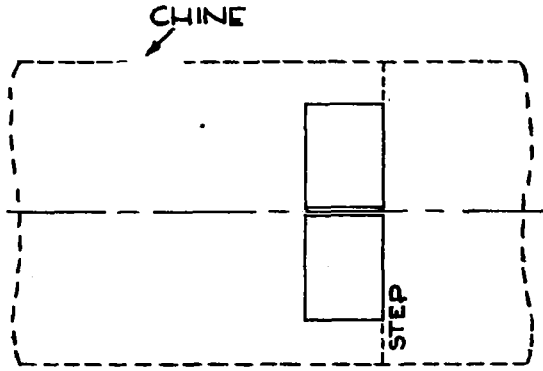

408-F3

Figure 3

# PLAN VIEW OF AFTERBODY FLAPS

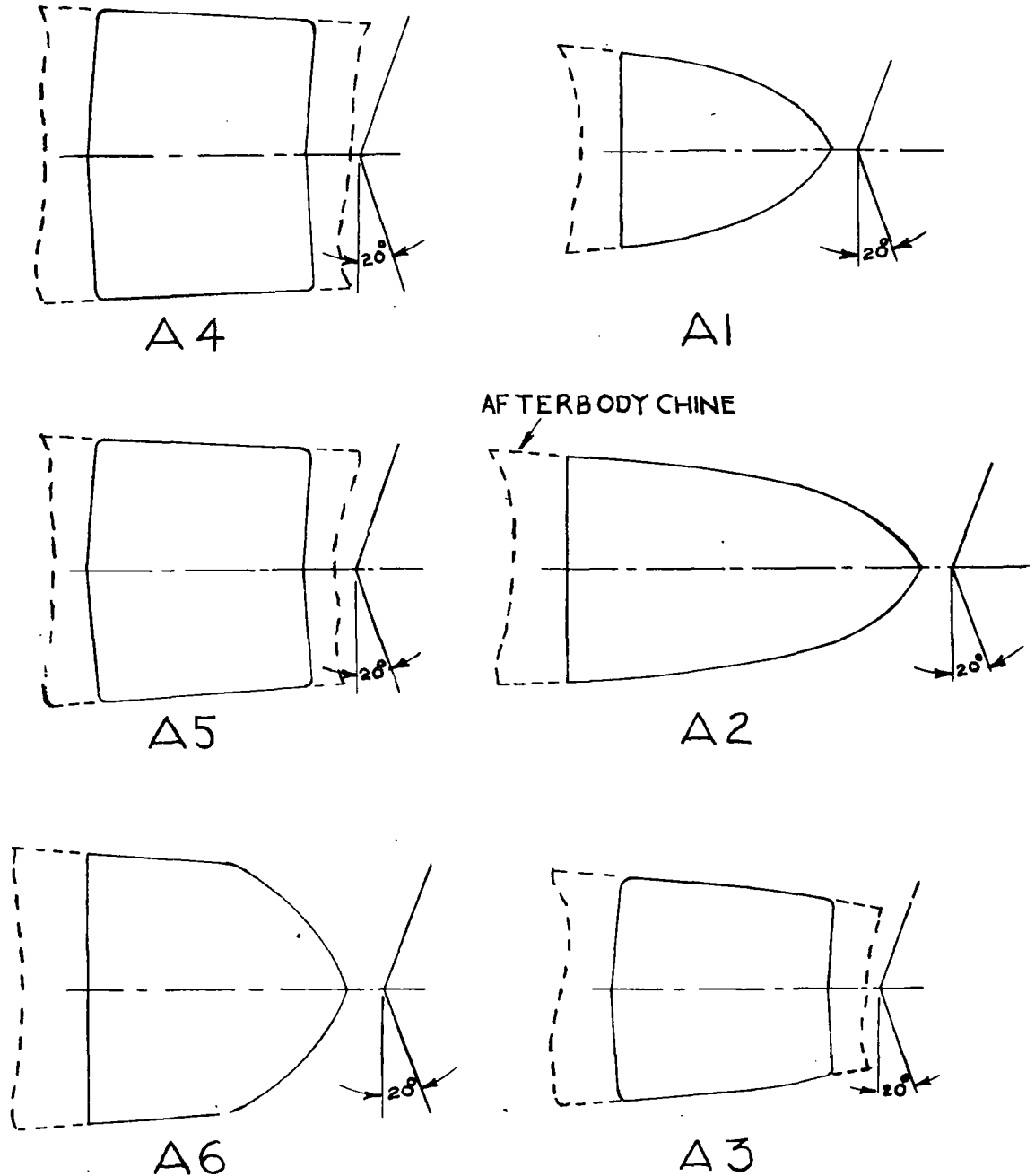

FLAPS ARE DESIGNED TO FIT FLUSH TO BOTTOM OF HULL  
WHEN RETRACTED.  
Figure 4

## DETAILED RESULTS

The results of the tests are given on the following pages, and are presented on the same type of chart as was used in reference 1. Each chart permits direct comparison of the hydrodynamic characteristics of the case considered with the reference flying boat, the XPB2M-1.

Resistances are based on a "parabolic" unloading curve corresponding to the normal particulars of the XPB2M-1 with a static load coefficient,  $C_{\Delta_0} = 0.89$ .

The page opposite gives the bare-hull hydrodynamic characteristics of the three models used in this investigation. The three models were designed to eliminate difficulty from upper-limit porpoising. (See page 19 for body plans.)

### Porpoising

Both the upper limits and the peaks of the lower limits are at higher trim angles than those of the XPB2M-1 model in all three of the models with flaps retracted. The first, Model 339-7, has the highest lower-limit peak. Although its upper limit is at very high trim angles, the speed at which it starts is very close to the peak of the lower limit, so that the stable range of trim at that speed is quite narrow.

No upper limit was found for Model 408, the second flap model; either it doesn't exist or it is beyond the range of moments generally used in testing at this Tank. The peak of the lower limit of Model 408 is at a somewhat lower speed and lies between that of Models 339-7 and 522.

The upper limit of Model 522, the last flap model, lies halfway between the upper limits of Model 339-7 and that of the XPB2M-1; it starts at about the same speed as the upper limit of the XPB2M-1 and does not appear to go all the way to getaway. The peak of the lower limit of Model 522 occurs at approximately the same speed as that of the XPB2M-1; the trim angle at which it occurs is approximately the same as that of Model 408.

### Resistance

The hump resistances of all three flap models are substantially higher than that of the XPB2M-1. Although they intertwine, the three curves follow each other quite closely.

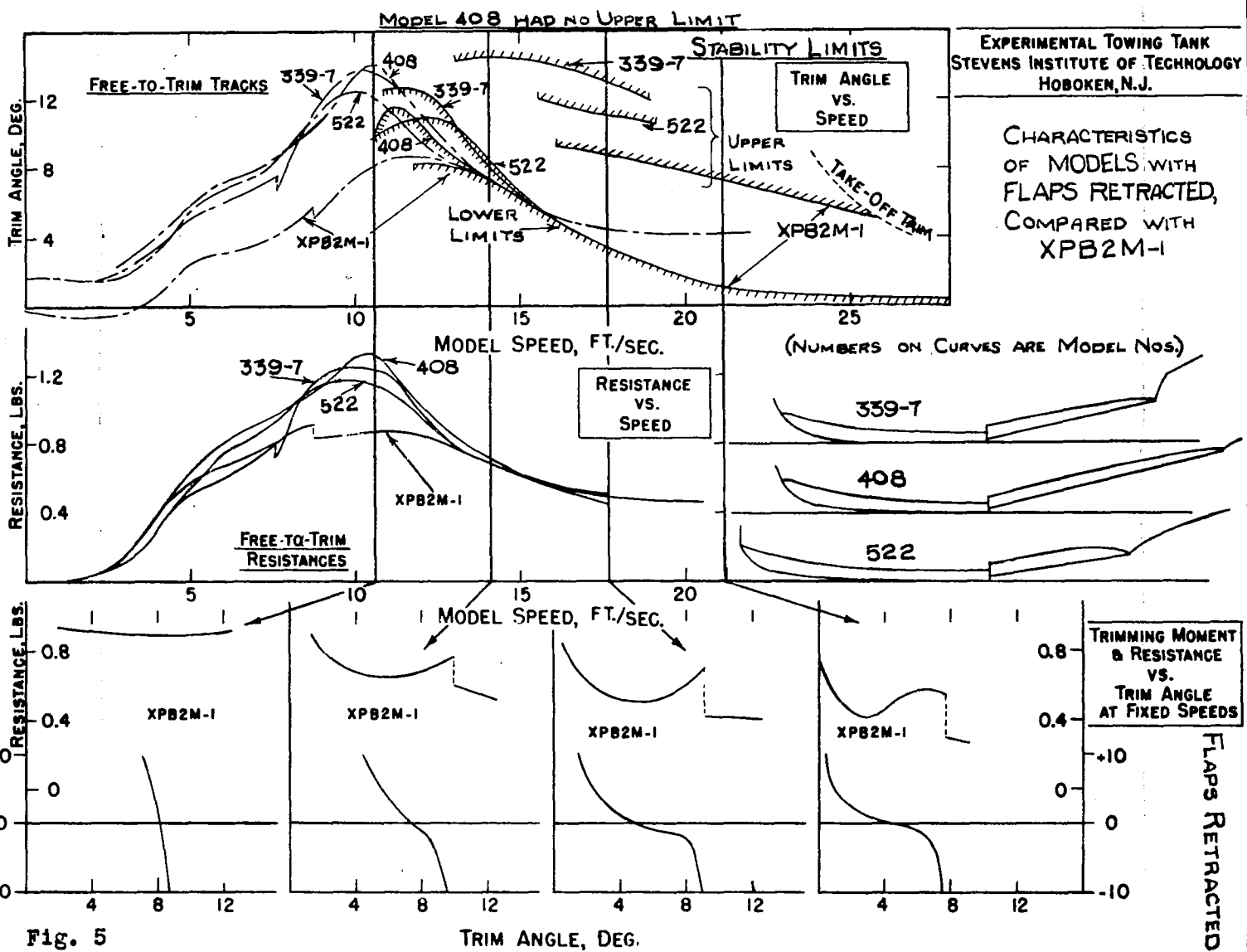

Fig. 5

TRIM ANGLE, DEG.

FIG. 5

Forebody flaps F1 were two inches square and were independently hinged to the forebody at their leading edge, one on each side of the keel. Three longitudinal locations were considered; leading edges four inches forward of the step, two inches forward of the step, and at the step, (designated respectively F1b, F1c, and F1d). All three locations were tested for resistance; only the first two for porpoising.

### Porpoising

For flap positions b and c there was:

1. little or no improvement of the undesirably high peaks of the free-to-trim track and lower-limit peak exhibited by the bare model.
2. a marked lowering of the lower-limit at speeds above the peak of the lower limit.

For position b there was no upper limit up to  $17^\circ$  of trim.

For position c the upper limit was about the same as for the model bare, about  $4^\circ$  above that for the XPB2M-1 model.

### Resistance

For all three flap positions the hump resistance was higher than that of the bare model - approaching twice that of the XPB2M-1.

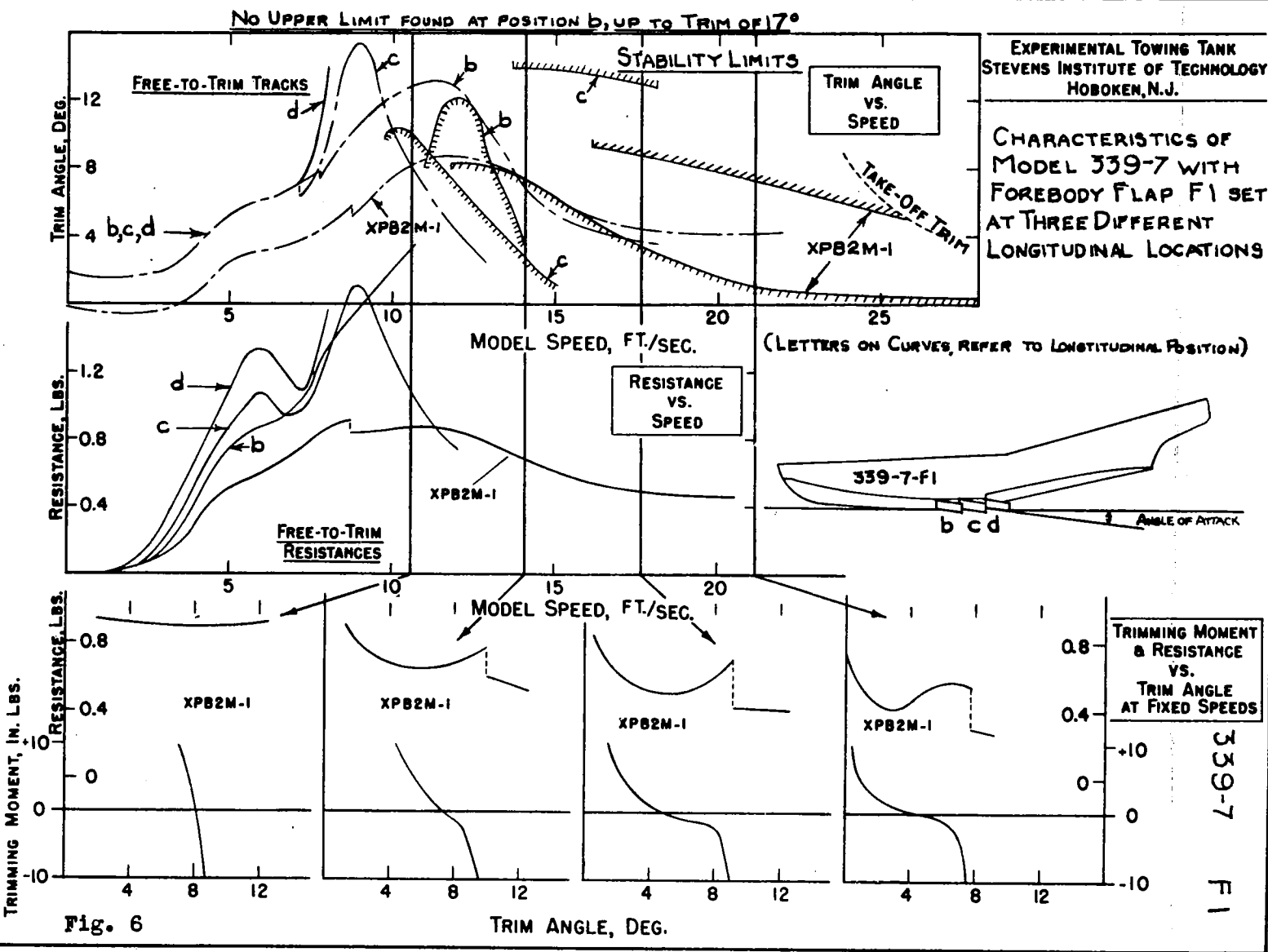

Fig. 6

TRIM ANGLE, DEG.

Fig. 6

Forebody flaps F2 differ from F1 flaps in that they are 1.35 inches long by 2.82 inches wide instead of 2.00 inches square. The leading edge is hinged at the main step. Tests were made for resistance at three angles of attack,  $0^\circ$ ,  $5^\circ$ , and  $10^\circ$ .

#### Porpoising

No tests were made.

#### Resistance

For all cases tested, the hump resistance is considerably higher than that of the XPB2M-1 model although at speeds above the hump the resistances drop sharply, those of the high angles of attack becoming lower than the XPB2M-1 resistance.



Forebody flaps F3 had the same length as F2 but the width was 2.00 inches instead of 2.82. The flaps were hinged at a distance of 1.35 inches forward of the main step so that the trailing edge was adjacent to the step when retracted. Tests were made for resistance at three angles of attack,  $5^\circ$ ,  $10^\circ$ , and  $15^\circ$ .

#### Porpoising

No tests were made.

#### Resistance

This flap arrangement had hump resistances somewhat lower than those of the F2 flap arrangement although still quite a bit higher than that of the XPB2M-1 model. Again, for speeds above the hump, the resistance tended to be lower than that of the XPB2M-1.

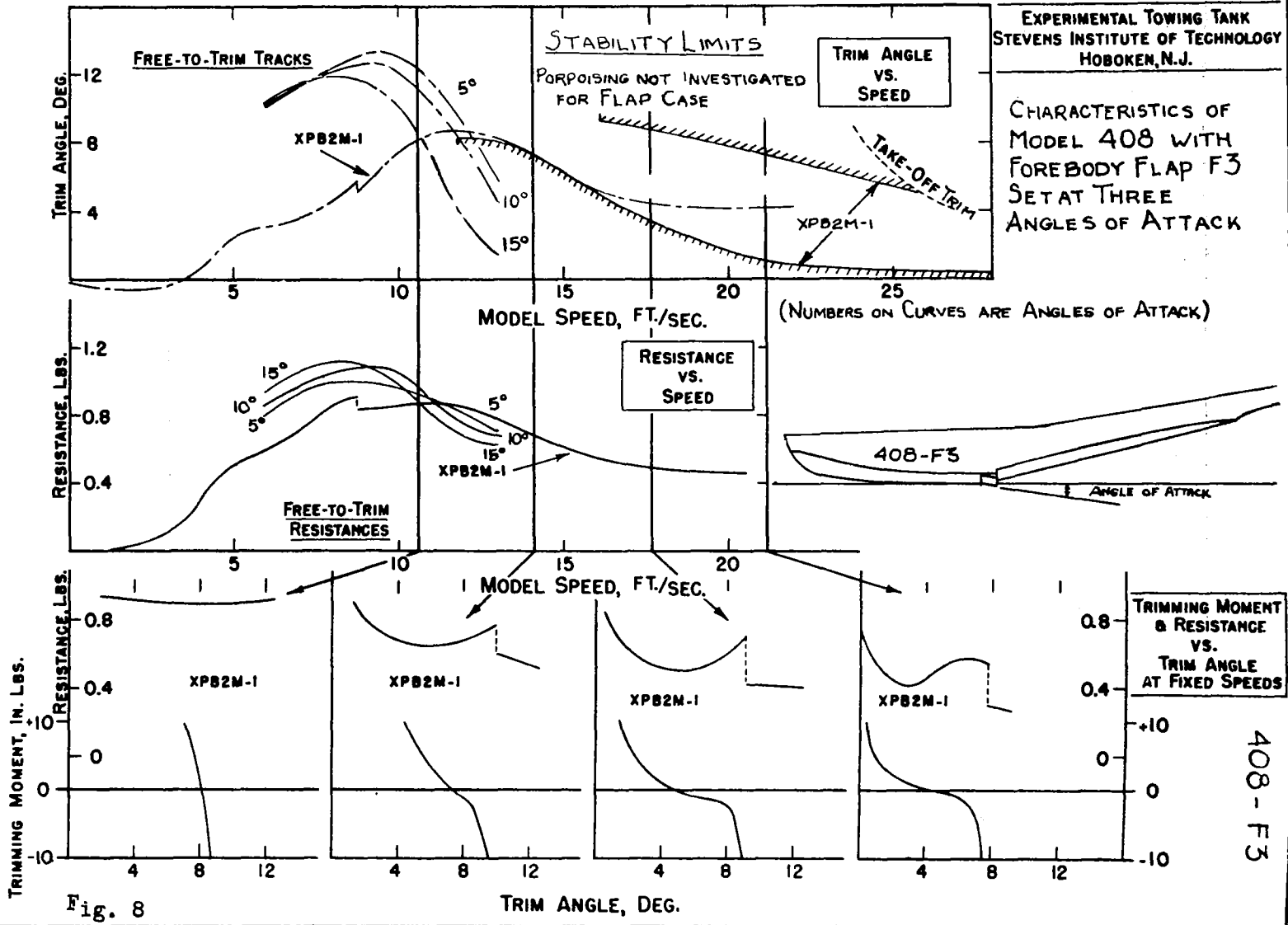

Fig. 8

This first afterbody flap, A1, was 4 inches long with a shape such that it could retract flush to the afterbody bottom. The pointed trailing edge in the retracted position is adjacent to the sternpost. The flap was mounted so that adjustment could be made both to the angle of attack and the sternpost angle. Tests were made for resistance for various sternpost angles, all with an angle of attack of  $4^\circ$ .

#### Porpoising

No tests were made.

#### Resistance

Of the four sternpost angles tested,  $4^\circ$ ,  $6^\circ$ ,  $8^\circ$ , and  $10^\circ$ , the  $8^\circ$  case had the lowest hump resistance but this was about 50% higher than that of the XPB2M-1 model.

EXPERIMENTAL TOWING TANK  
STEVENS INSTITUTE OF TECHNOLOGY  
HOBOKEN, N.J.

CHARACTERISTICS OF  
MODEL 408 WITH  
AFTERBODY FLAP A1  
SET AT 4° ANGLE OF  
ATTACK AND VARIOUS  
STERNPOST ANGLES

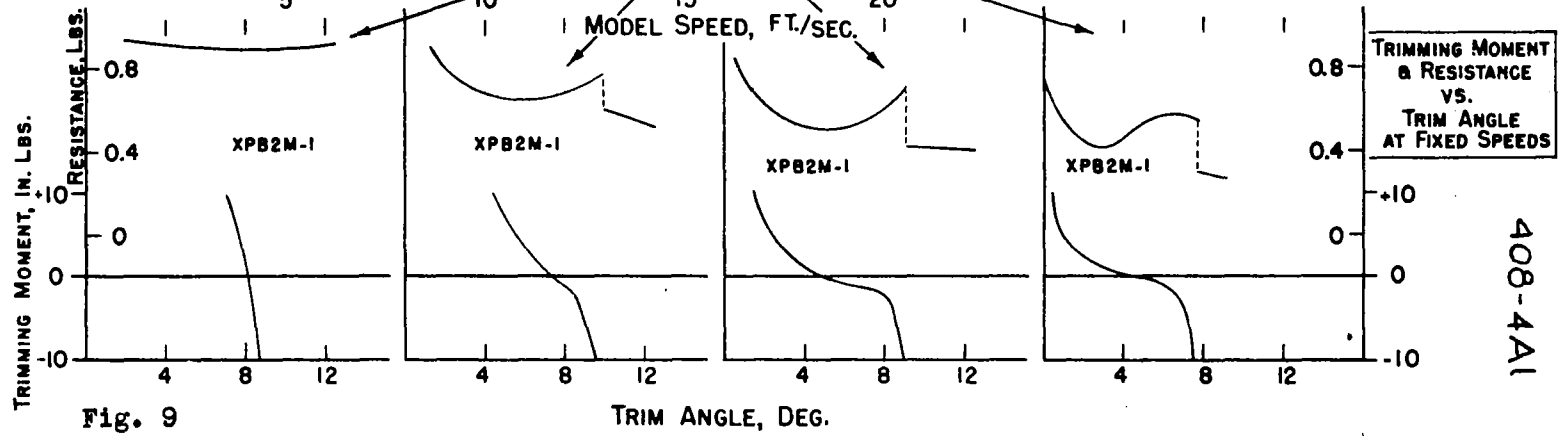
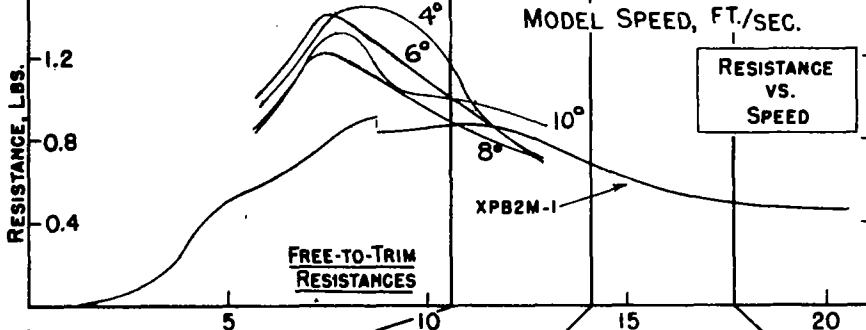
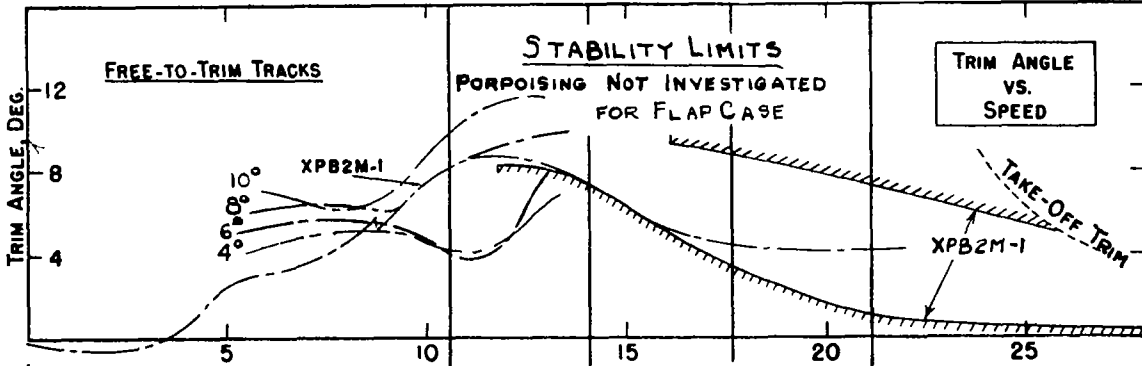
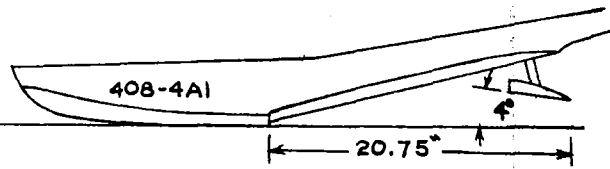

Fig. 9

FIG. 9

This afterbody flap, A2, was made 6.65 inches long instead of the 4 inches of the previous one. It was also laid out so that it would retract flush with the afterbody and with the trailing point adjacent to the sternpost. Adjustments could be made to the angle of attack and to the sternpost angle. Tests were made for resistance only, for various sternpost angles with the angle of attack  $4^\circ$  in all cases.

#### Porpoising

No tests were made.

#### Resistance

Increases of sternpost angle resulted in decreases in hump resistance -  $10^\circ$  having a peak about 20% higher than the hump resistance of the XPB2M-1 model. There appeared to be a crossover, however, at about 11 feet per second, resulting in increased resistances for higher sternpost angles.

Above 10 feet per second this combination exhibited a tendency to "chatter" - a very rapid trim oscillation of about  $1/2^\circ$  amplitude.

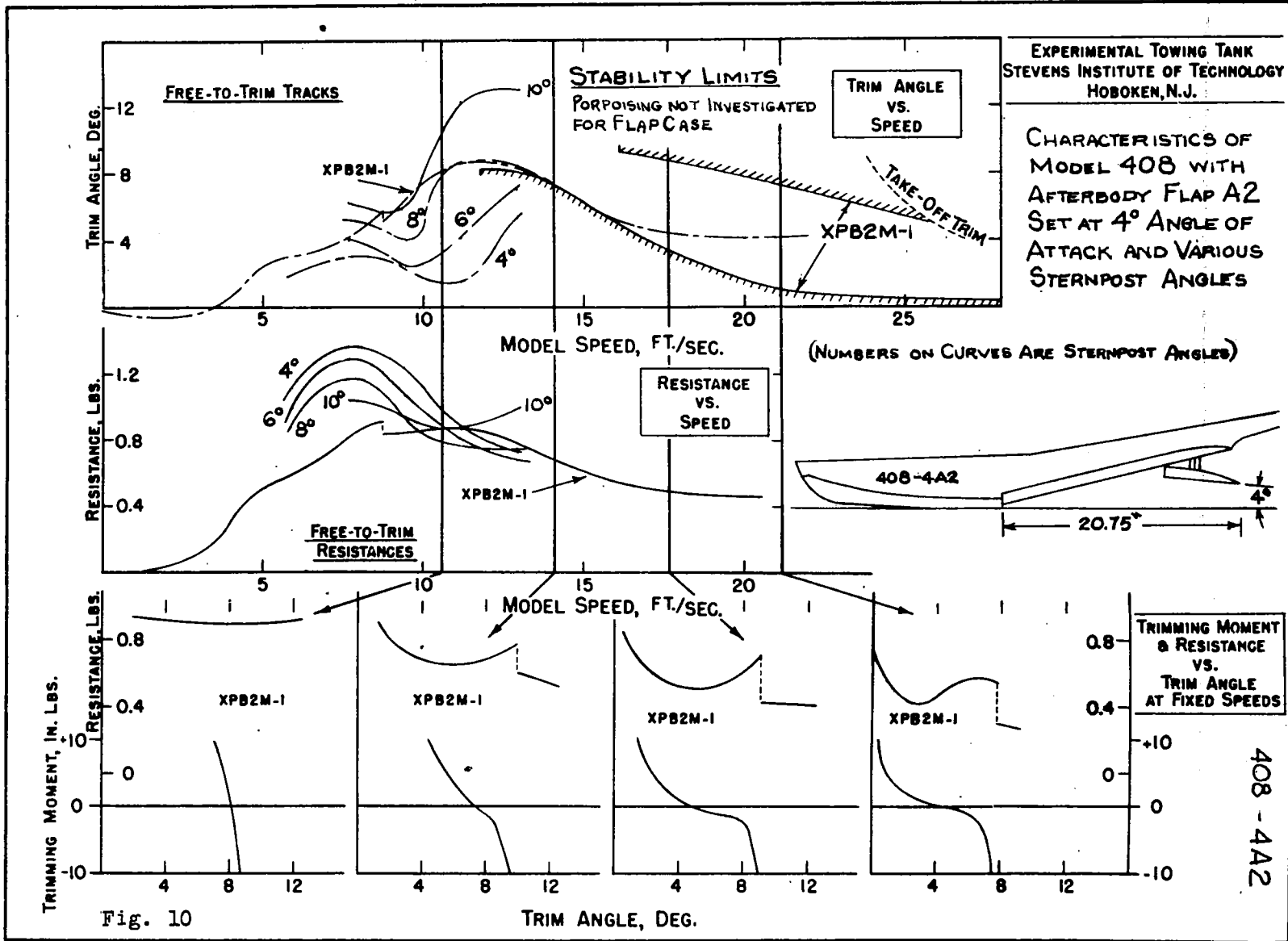

Fig. 10

Fig. 10

Flap A3 differs from Flap A2 by the omission of the after-end which was thought to be responsible for the chattering exhibited by the tests with the Flap A2 combination. Porpoising was investigated because resistances were more promising. As before, the angle of attack was held constant at  $4^\circ$  and the sternpost angle varied.

Additional porpoising tests were run with the flap free to move vertically against a spring.

#### Porpoising

Decreasing the sternpost angle reduced the peak of the lower trim-limit of stability, but also lowered the free-to-trim track in all cases to a position below the lower limit peak. The upper trim limits of stability also were lowered with decreases in sternpost angles, in most cases to lower than the XPB2M-1 upper limit.

It was not possible to obtain lower limits for sternpost angles of  $2^\circ$  and  $4^\circ$  as the model dove.

Allowing the flap to move vertically increased the amplitude of the porpoising considerably but did not appreciably alter either the speed range or trim range of porpoising.

#### Resistance

The hump resistance for all of the cases tested were considerably higher than that of the XPB2M-1 model. At speeds above the hump there appeared to be some improvement in resistance.

The chattering exhibited by the previous flap was absent in this case.



Flap A4 had about the same area as A3. It was mounted far forward on the afterbody in order to correct the bad feature found with A3, namely, the main-step roach hitting the afterbody forward of the flap and washing over the flap.

### Porpoising

The porpoising characteristics for this case are not very different than those for the A3 flap combination. The peak of the lower limit is slightly lower than that of the XPB2M-1 but the free-to-trim track is also down. The upper limits are low but short in speed range.

Special porpoising tests were also made of this case with the flap free to move vertically against a spring. For these tests there was no increase in the amplitude of the porpoising, although the range of speeds over which porpoising occurred was increased. It appeared from these special tests of flaps A3 and A4 that there was no advantage in allowing vertical motion of the flap.

### Resistance

The hump and pre-hump resistances are all high, about twice that of the XPB2M-1.

Moving the flap forward successfully took care of the roach from the main step but the roach of the flap now hit the afterbody just forward of the sternpost.



Flap A5 had about the same area as flaps A3 and A4. It was located about half way between the positions of those two flaps in the hope that it would be far enough forward so that the main step roach would not wash over the top of it and far enough aft so that its own roach would not hit the afterbody. Tests were made for both resistance and porpoising at two angles of attack and at various sternpost angles.

$$\underline{\text{ANGLE OF ATTACK} = 0^{\circ}}$$

#### Porpoising

The lower sternpost angles show some promise. The peak of the lower limit has been reduced to well below that of the XPB2M-1 model. While the upper limits are low their speed range is high enough in speed to allow time, in an actual take-off, for retracting the flap, before upper-limit porpoising starts. There is neither upper- nor lower-limit porpoising with 2° sternpost angle, although there is a tendency toward diving.

#### Resistance

Reduction in sternpost angle reduces the hump resistance to about that of the XPB2M-1. The hump is at a lower speed and the pre-hump resistances are higher.

The difficulties experienced with the roaches in the tests of the previous flaps were absent for this present case.

NO UPPER OR LOWER LIMIT FOR POISING FOUND AT 2° BUT DIVING AT POSITIVE MOMENTS

EXPERIMENTAL TOWING TANK  
STEVENS INSTITUTE OF TECHNOLOGY  
HOBOKEN, N.J.

CHARACTERISTICS OF  
MODEL 408 WITH  
AFTERBODY FLAP A5  
SET AT 0° ANGLE OF  
ATTACK AND VARIOUS  
STERNPOST ANGLES

NACA ARR No. 4H30

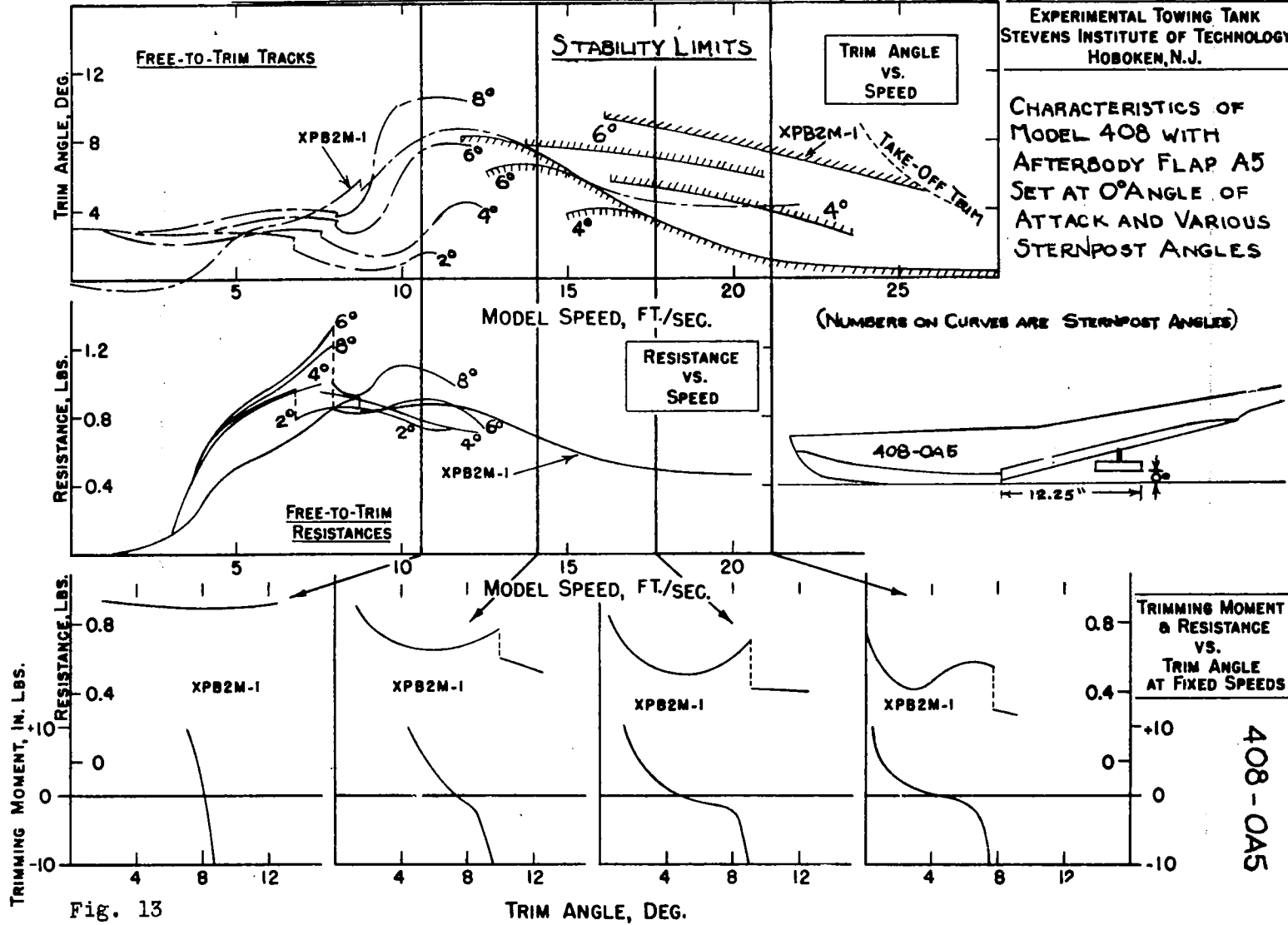

Fig. 13

ANGLE OF ATTACK = 4°Porpoising

Increasing the angle of attack had little effect on the lower limit. The start of upper-limit porpoising was delayed by about three feet per second. This case begins to open up some possibility of improvement of porpoising by retracting the flap at about 17 or 18 feet per second. The only difficulty is that the free-to-trim track still passes slightly below the peak of the lower limit and that there is some tendency toward diving for low sternpost angles.

Resistance

This is the first flap-hull combination exhibiting practical resistance characteristics. The resistance hump is shifted down in speed causing higher resistance than the XPB2M-1 up to eight feet per second, and lower beyond that. The reduction of resistance at the upper speed end is about equal to the increase at the lower end.

EXPERIMENTAL TOWING TANK  
STEVENS INSTITUTE OF TECHNOLOGY  
HOBOKEN, N.J.

CHARACTERISTICS OF  
MODEL 408 WITH  
AFTERBODY FLAP A5  
SET AT 4° ANGLE OF  
ATTACK AND VARIOUS  
STERNPOST ANGLES

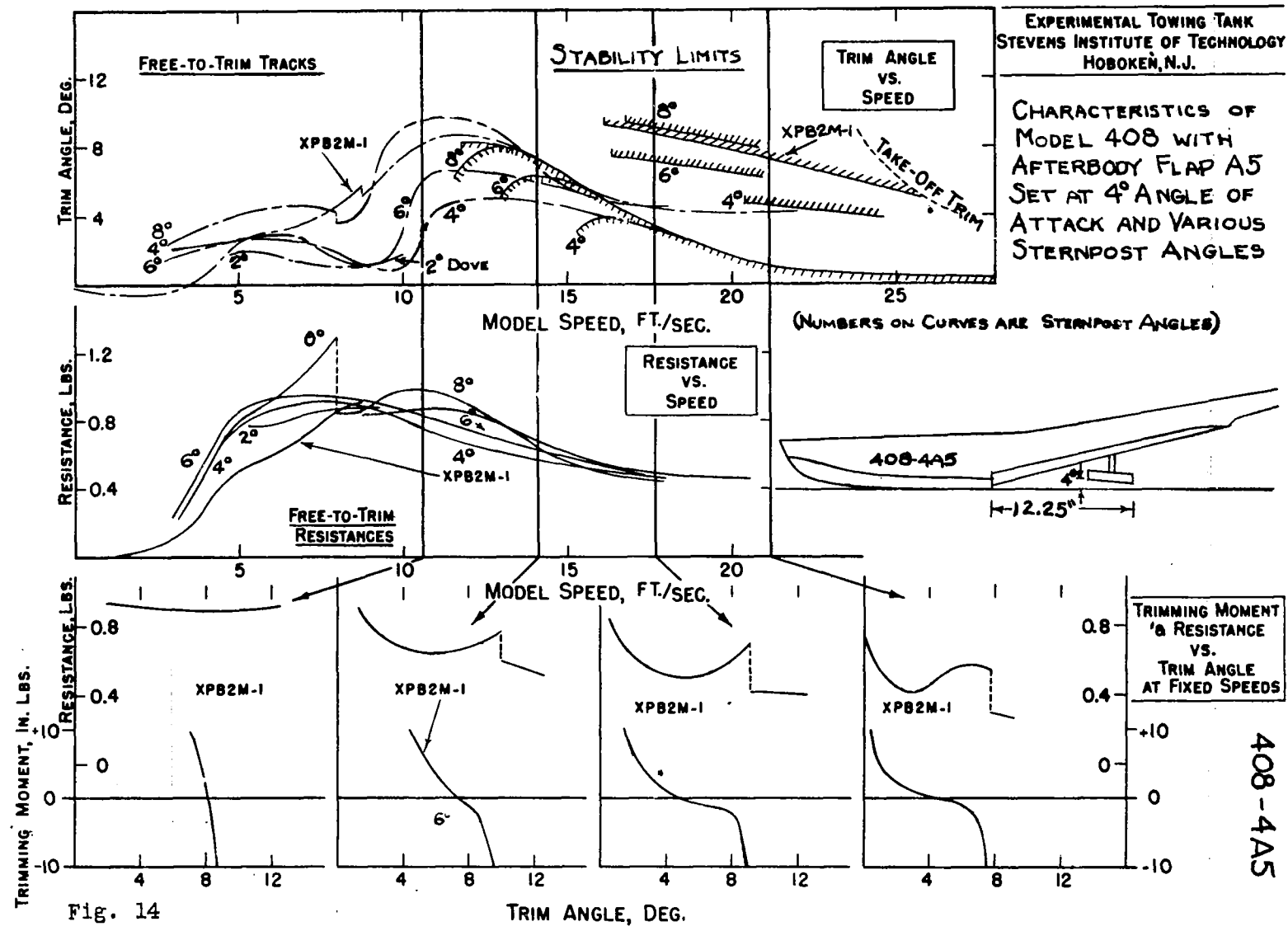

408-4A5

Fig. 14

Fig. 14

Flap A6 had about the same area as the previous three flaps (used on Model 408). Its distance from the step was the same as that of flap A5 used with Model 408.

Tests were made for both resistance and porpoising at three angles of attack with various sternpost angles.

$$\underline{\text{ANGLE OF ATTACK} = 0^\circ}$$

### Porpoising

The peak of the lower-limit curve was lowered markedly with decrease of sternpost angle. No lower limit was found with  $2^\circ$  sternpost angle. The free-to-trim track still passes slightly below the peak of the lower limit curve.

For  $6^\circ$  sternpost angle, the upper limit is about two degrees lower than for the XPB2M-1 and starts at about three feet per second lower speed. No upper limit was found for  $2^\circ$  and  $4^\circ$  sternpost angles.

### Diving

No diving tendency at any of the four sternpost angles tested.

### Resistance

Resistances are about comparable to those of the XPB2M-1, although there is a sharp local peak.

No UPPER OR LOWER LIMIT PORPOISING FOUND AT 0° AND 2° AND NO DIVING

EXPERIMENTAL TOWING TANK  
STEVENS INSTITUTE OF TECHNOLOGY  
HOBOKEN, N.J.

CHARACTERISTICS OF  
MODEL 522 WITH  
AFTERBODY FLAP A6  
SET AT 0° ANGLE OF  
ATTACK AND VARIOUS  
STERNPOST ANGLES

NACA ARR No. 4H30

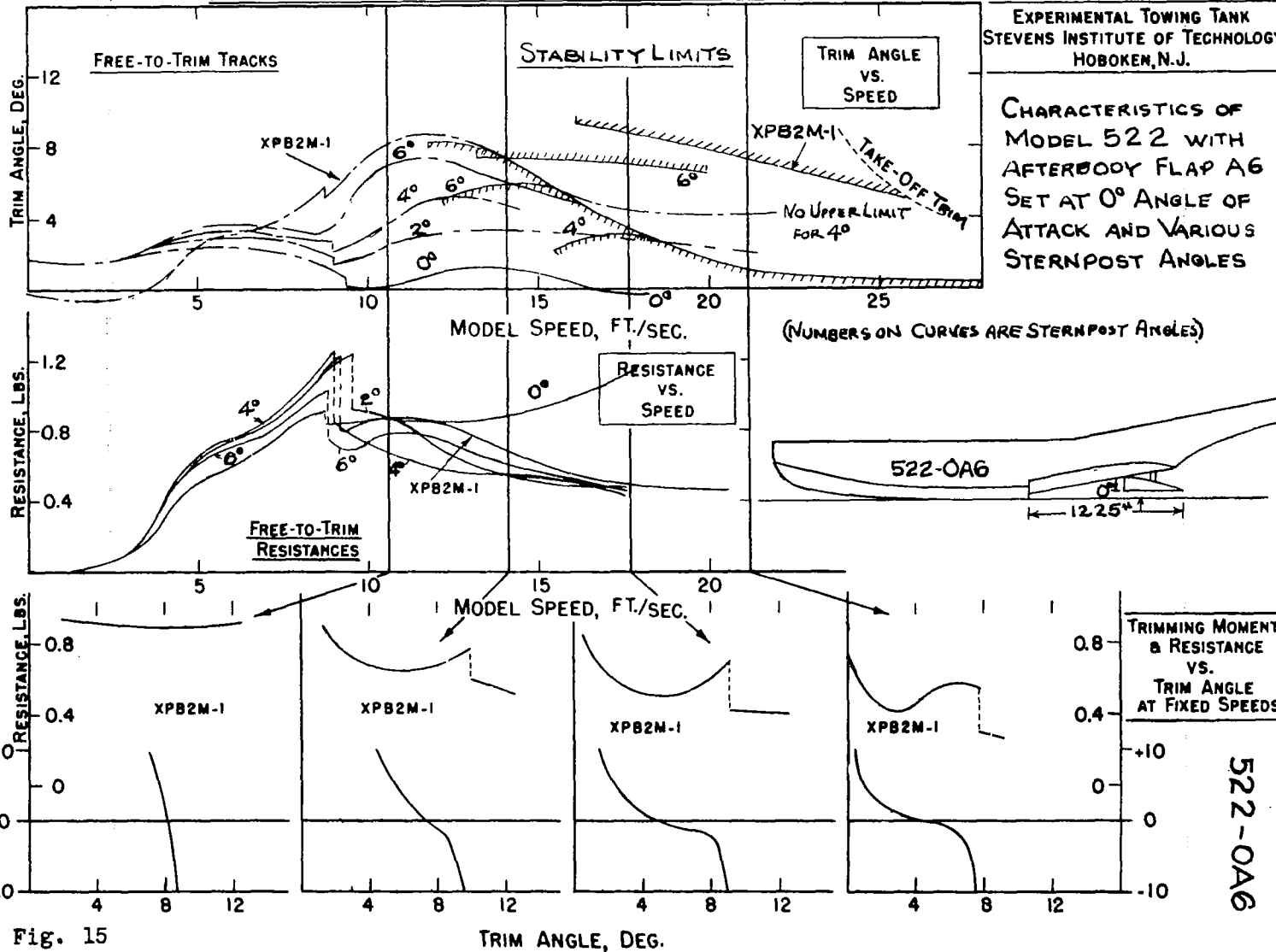

Fig. 15

522-OA6

Fig. 15

ANGLE OF ATTACK = 4°

For this angle of attack tests were made only at sternpost angles of 0°, 2°, and 4°.

Porpoising

The increase in angle of attack lowered very slightly the peak of the lower limit for 4° sternpost angle. The most important effect was that the free-to-trim track was well above the lower limit. There was no lower-limit porpoising for sternpost angles of 0° and 2°.

The increase in angle of attack brought out upper-limit porpoising with 4° sternpost angle for a short range of speeds, but high enough in speed to be eliminated by retracting the flap. There was no upper limit porpoising for sternpost angles of 0° and 2°.

Diving

There was some diving tendency for the low sternpost angles.

Resistance

The change in angle of attack had little effect on the resistance characteristics. Compared to the XPB2M-1, the resistances for the 4° sternpost angle are the most favorable.

NO UPPER OR LOWER LIMIT FORPOISING FOUND AT 0° AND 2°, BUT SOME DIVING

EXPERIMENTAL TOWING TANK  
STEVENS INSTITUTE OF TECHNOLOGY  
HOBOKEN, N.J.

CHARACTERISTICS OF  
MODEL 522 WITH  
AFTERBODY FLAP A6  
SET AT 4° ANGLE OF  
ATTACK AND VARIOUS  
STERNPOST ANGLES

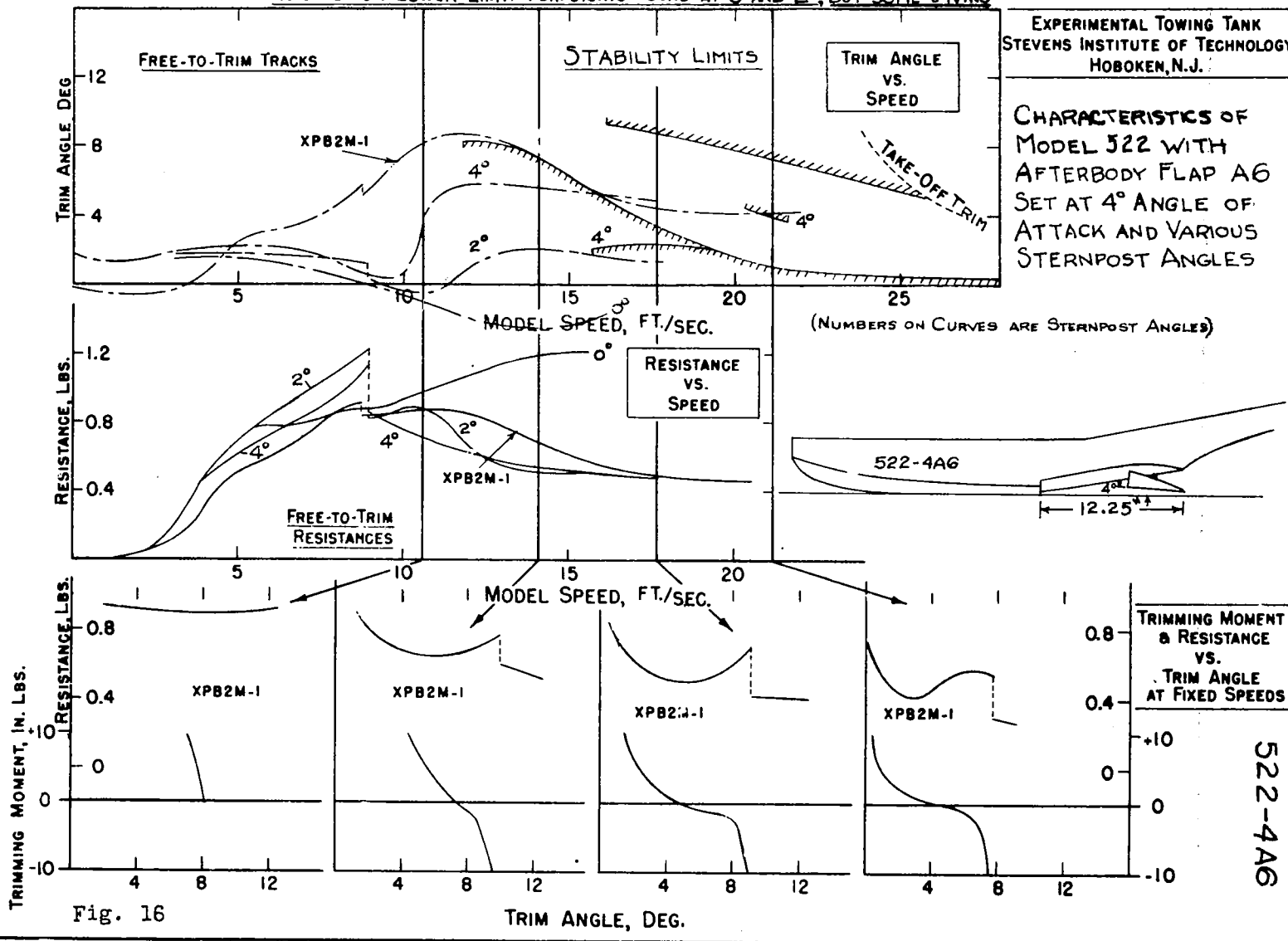

Fig. 16

TRIM ANGLE, DEG.

522-4A6

Fig. 16

ANGLE OF ATTACK = 8°

For this angle of attack tests were made for porpoising at sternpost angles of 0°, 2° and 3°.

Porpoising

There was no porpoising for 0° and 2° sternpost angles.

Diving

There was diving in all cases.

Resistance

The increase in angle of attack eliminated the high local peak in the resistance curves. The average resistances were somewhat higher.

NO UPPER OR LOWER LIMIT FOR POISING FOUND AT 0° OR 2°, BUT A LOT OF DIVING

EXPERIMENTAL TOWING TANK  
STEVENS INSTITUTE OF TECHNOLOGY  
HOBOKEN, N.J.

CHARACTERISTICS OF  
MODEL 522 WITH  
AFTERBODY FLAP A6  
SET AT 8° ANGLE OF  
ATTACK AND VARIOUS  
STERNPOST ANGLES

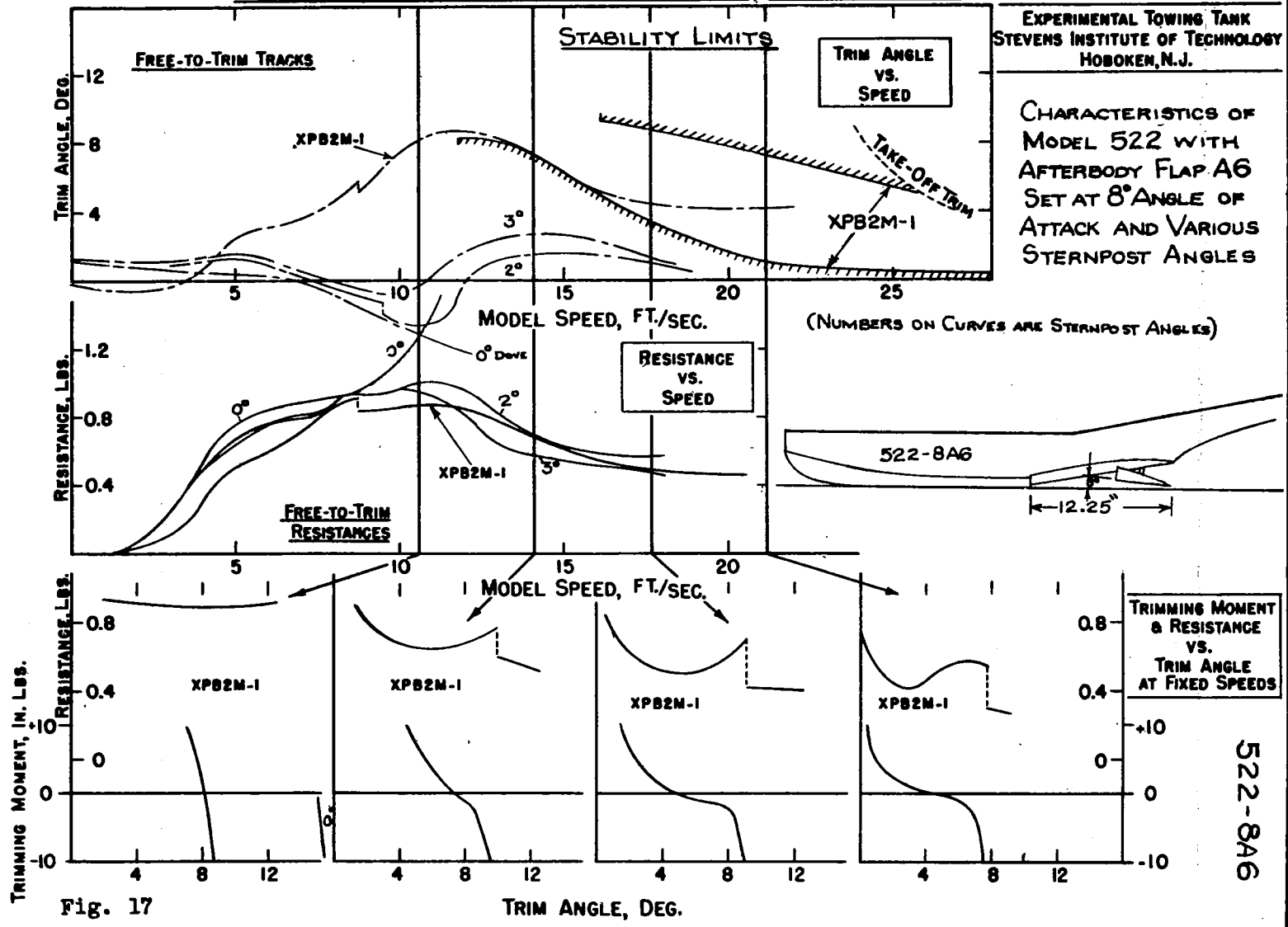

Fig. 17

522-8A6

Fig. 17

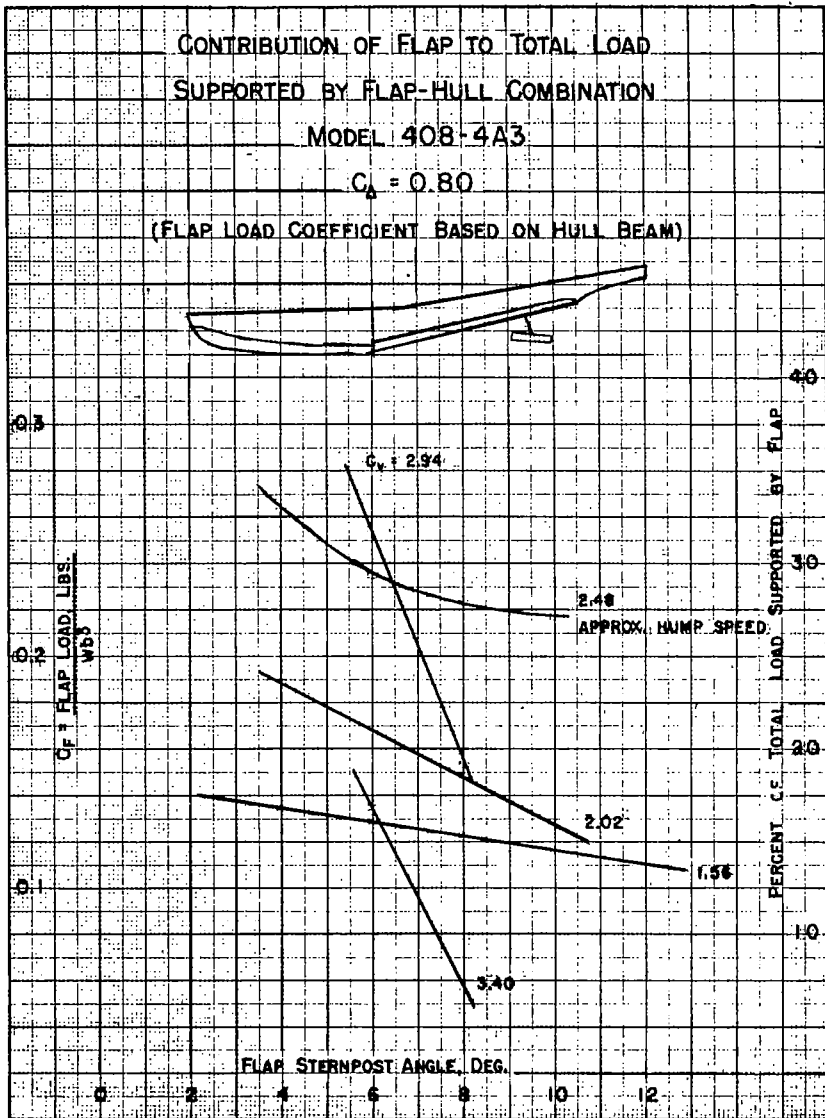

Figure 18

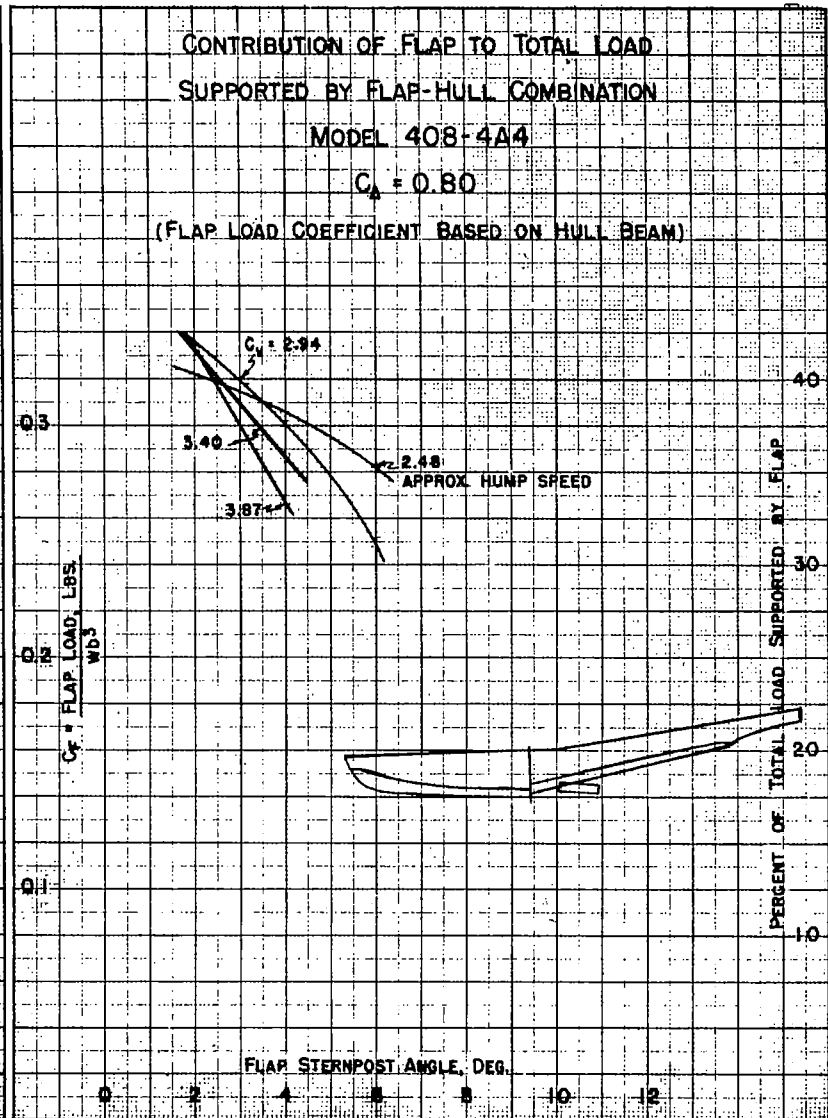

Figure 19

In order to obtain some idea of the forces involved in the operation of a flap, Model No.408-1 was equipped with a dynamometer to measure the load on the flap. The above charts give the results of these tests made over a range of speed and sternpost angle with flaps A3 and A4.

**TITLE:** Tank Tests on the Resistance and Porpoising Characteristics of Three Flying-Boat Hull Models Equipped with Planing Flaps

**AUTHOR(S):** Locke, F. W. S.; Barklie, J. A.

**ORIGINATING AGENCY:** Stevens Institute of Technology, Hoboken, N. J.

**PUBLISHED BY:** National Advisory Committee for Aeronautics, Washington, D. C.

ATI- 7986

REVISION  
(None)

ORIG. AGENCY NO.  
(None)

PUBLISHING AGENCY NO.  
ARR-4H30

DATE	DOC. CLASS.	COUNTRY	LANGUAGE	PAGES	ILLUSTRATIONS
Nov '44	Unclass.	U.S.	Eng.	50	diagrs, graphs, drwgs

**ABSTRACT:**

Experiments were made to develop flap-hull combination which, with flap extended, would have hump-resistance characteristics equal to those of XPB2M-1 flying boat and, with flap retracted, would have much better upper-limit porpoising characteristics at planing speeds. Report presents results of exploratory model experiments. Objectives were realized with planing flap attached to afterbody, about two beams abaft main steps of hulls which have upper limits of stability with no flap. Three flap-hull combinations are suggested and discussed.

**DISTRIBUTION:** Request copies of this report only from Publishing Agency

**DIVISION:** Water-Borne Aircraft (21)  
**SECTION:** Performance (B)

**SUBJECT HEADINGS:** XPB2M-1 - Tank tests (99459.46);  
Flying boats - Porpoising stability (4175B)

**ATI SHEET NO.:** R-21-B-5