

UNCLASSIFIED

AD NUMBER

ADB002100

LIMITATION CHANGES

TO:

Approved for public release; distribution is unlimited.

FROM:

Distribution authorized to U.S. Gov't. agencies only; Test and Evaluation; JAN 1975. Other requests shall be referred to Defense Advanced Research Projects Agency, ARPA-TIO, 1400 Wilson Blvd, Arlington, VA 22209.

AUTHORITY

darpa per dtic form 55

THIS PAGE IS UNCLASSIFIED

UNCLASSIFIED

AD NUMBER

ADB002100

CLASSIFICATION CHANGES

TO: UNCLASSIFIED

FROM: CONFIDENTIAL

LIMITATION CHANGES

TO:

Distribution authorized to U.S. Gov't. agencies only; Test and Evaluation; JAN 1975. Other requests shall be referred to Defense Advanced Research Projects Agency, ARPA-TIO, 1400 Wilson Blvd, Arlington, VA 22209.

FROM:

Distribution: Further dissemination only as directed by Defense Advanced Research Projects Agency, Washington, DC 20301, JUN 1969, or higher DoD authority.

AUTHORITY

DARPA dtd 27 Jan 1975, per document marking;
darpa ltr, 17 Jun 1975

THIS PAGE IS UNCLASSIFIED

AD-B002100-L

1

**BACKGROUND MEASUREMENTS
MADE ABOVE FIVE KILOMETERS:
A SURVEY OF THE LITERATURE (U)**

JOHN W. BOYSE
NORMAN R. DITTMAR
FRANK D. FARLEY

June 1969



BACKGROUND ANALYSIS CENTER
INFRARED AND OPTICAL SENSOR LABORATORY
Willow Run Laboratories
THE INSTITUTE OF SCIENCE AND TECHNOLOGY

Sponsored by the Advanced Research Projects Agency,
Department of Defense, Washington, D. C., under Con-
tract SD-91 and published under ARPA Contract DAHC-
15-67-C-0062

[REDACTED]
[REDACTED]
[REDACTED]
[REDACTED]

DDC
RECEIVED
FEB 10 1975
D

NOTICES

Unclassified

Sponsorship. The work reported herein was conducted by the Willow Run Laboratories of the Institute of Science and Technology for the Advanced Research Projects Agency under Contract SD-91; the report was prepared under ARPA Contract DAHC-15-67-C-0062. Contracts and grants to The University of Michigan for the support of sponsored research are administered through the Office of the Vice-President for Research.

This report has been classified Confidential by the Advanced Research Projects Agency on the basis of the many classified references. Each section and subsection is, as indicated, Unclassified by itself.

Distribution. Initial distribution of this report has been approved by ARPA and is indicated at the end of this report.

Final Disposition. After this document has served its purpose, military organizations may destroy it in accordance with applicable directives; Department of Defense contractors may destroy it in accordance with the provisions of the Industrial Security Manual for Safeguarding Classified Information. Please do not return it to the Willow Run Laboratories.

[REDACTED]

THIS DOCUMENT HAS BEEN DOWNGRADED
TO "UNCLASSIFIED" 27 JAN 1975
Per Director, ARPA/TIO

6054-16-X

BACKGROUND MEASUREMENTS MADE ABOVE FIVE KILOMETERS: A SURVEY OF THE LITERATURE (U)

JOHN W. BOYSE
NORMAN R. DITTMAR
FRANK D. FARLEY

June 1969

[REDACTED]

[REDACTED]

Distribution Limited to U. S. Government
Organizations Only T&E JAN 1975
Other requests for this document must be
referred to ARPA/TIO, 1400 Wilson Blvd.
Arlington, VA 22209

Background Analysis Center
Infrared and Optical Sensor Laboratory
Willow Run Laboratories
THE INSTITUTE OF SCIENCE AND TECHNOLOGY
THE UNIVERSITY OF MICHIGAN
Ann Arbor, Michigan

Downgraded at 3 Year Intervals; Declassified after 12 Years. DOD Dir 520010

[REDACTED]

DDC
RECEIVED
FEB 10 1975
D

UNCLASSIFIED

WILLOW RUN LABORATORIES

PREFACE *Unclassified*

The Background Analysis Center was established at the Willow Run Laboratories of the Institute of Science and Technology within the Infrared and Optical Sensor Laboratory under Contract SD-91 with the Advanced Research Projects Agency. The Center's functions were to collect and review pertinent documents, store and analyze background data, and investigate background discrimination techniques. While the survey reported herein was being conducted, the level of effort at the Center was reduced, and activity was shifted to the Ballistic Missile Research Analysis Center (BAMIRAC) of the Infrared Physics Laboratory, where publication of reports has continued under Contract DAHC-15-67-C-0062, ARPA Order No. 236.

This report is a review of measurements of infrared backgrounds. An attempt has been made to make a comprehensive survey of the unclassified literature on downlooking measurements current to about the beginning of 1967. Some samples of uplooking measurements, including solar spectra, have also been included.

This report has been classified Confidential by the Advanced Research Projects Agency on the basis of the many classified references. Each section and subsection is, as indicated, Unclassified by itself.

UNCLASSIFIED

UNCLASSIFIED

WILLOW RUN LABORATORIES

ABSTRACT

Unclassified

This report reviews background measurements made from altitudes of 5 km or higher up to 1967. Optical backgrounds of all types, including solar spectra, have been considered. The review of each experiment includes information on the instruments used, spectral and spatial information, and information on the method of data collection and on the kind, format, and availability of the data obtained.

UNCLASSIFIED

UNCLASSIFIED

WILLOW RUN LABORATORIES

CONTENTS *Unclassified*

Prefaceiii
Abstract	v
List of Figures	x
List of Tables	xi
1. Introduction	1
2. Indexes	2
2.1. Chart Index	2
2.2. Subject Index	7
2.3. Author Index	9
2.4. Wavelength Index	12
3. The Infrared, Visible, and Ultraviolet Background Structure As Seen from Above15
3.1. Introduction	15
3.2. "High-Altitude Background Studies": D. G. Murcray and Others	15
3.3. The "Flight Data" Series: D. G. Murcray	20
3.4. Measurements of Infrared and Visible Radiation On Balloon Flights At an Altitude of 34 km: Bartman, Chaney, and Others	26
3.5. Spectral Properties of High-Altitude Clouds: A. D. Little, Incorporated	28
3.6. Thermal Radiance Properties of Clouds: F. R. Valovcin and D. R. Fitzgerald	34
3.7. A Spectral Radiance Study of Terrain and Clouds: Emerson Electric	36
3.8. The Aerospace Infrared Four-Color Experiment	39
3.9. The Aerospace Ultraviolet Experiment	42
3.10. The Spectral Background Radiance from a Discoverer Satellite: L. C. Block and Others	44
3.11. The TIROS Weather Satellites	46
3.12. Nimbus I	51
3.13. Transit 1A, 1B, and 2A Satellites	61
3.14. TASCAN Infrared-Mapper Experiment	62
3.15. The T-BIRD Series of Rocket Probes	64
3.16. The BIRA 01 and BIRA 02 Experiments	67
3.17. Airborne Infrared-Radiation Measurements at the Royal Aircraft Establishment: Brown, Chamberlain, and Hughes	74
3.18. Background Data from an Investigation of Ultraviolet Surveillance Technique: Northrop Space Laboratories	75
3.19. ICBM Cloud Photographs	79
3.20. Mercury Spacecraft MA-8	80
3.21. U-2 Cloud Photographs	82
3.22. A Cloud Map Made With the Stereonephograph	83
3.23. Vanguard II Satellite	84
3.24. Infrared Intensity of the Daylight Sky: Hughes Aircraft Company	86
4. Earth Reflectance and Albedo Determinations	87
4.1. Introduction	87
4.2. A Spectral Reflectance Study of Terrain: U. R. Barnett and J. D. Sigler	88

UNCLASSIFIED

WILLOW RUN LABORATORIES

4.3. An Albedo Measurement Obtained with a Pyrheliometer: Shackleton and Quirk	90
4.4. Ultraviolet Apparent Reflectance and Albedo of the Earth from High Altitudes: Band and Block	91
5. Horizon Profiles	93
5.1. Introduction	93
5.2. The Horizon at 1.5 μ and the Thermal Region: D. G. Murcray and Others	94
5.3. The Horizon at 6.25, 9.6, 10.8, and 14.8 μ : Persky	96
5.4. Measurement of 15- μ Horizon Radiance from a Satellite: Eastman Kodak Company	97
5.5. The Terrestrial Night Horizon and Sky at 4.3 μ : HITAB-TRIS Rocket Probes	101
5.6. Infrared Horizon Measurements from a Near-Orbiting Rocket Probe: R. Anthony and V. N. Smiley	103
5.7. The Ultraviolet, Visible, and Infrared Horizon from a Rocket Probe: Langley Research Center	106
5.8. The Total Infrared Flux Horizon: Ovrebo and Beardsley	108
5.9. The Flux Gradient of the Horizon: Bieber and Clark	108
5.10. The Photometric Horizon: Hoffleit and Bechtol	110
6. Atmospheric Flux Measurements	112
6.1. Introduction	112
6.2. The Spectral Flux of the Atmosphere At Night: John Strong and R. C. White	112
6.3. The Atmospheric Infrared Spectral Flux: Persky	115
6.4. Radiosonde Measurements at Thule, Greenland: Fenn and Weickmann	117
6.5. Medium-Altitude Flux Measurement Over Trinidad	118
6.6. Explorer VII Satellite	119
6.7. Spectral Irradiance of the Earth: Ball Brothers	120
6.8. Atmospheric Optical Measurements Over Western Florida: Boileau	122
6.9. An Early Measurement of the Flux of Infrared Radiation in the Atmosphere: Houghton and Brewer	124
6.10. Earth Radiation Measurements by Interferometer from a High-Altitude Balloon: L. W. Chaney	126
7. Selected Extraterrestrial Backgrounds	129
7.1. Introduction	129
7.2. Early Photoelectric Measurements of Sky Brightness	130
7.3. The Brightness of the Atmosphere at High Altitudes: N. L. Barr	133
7.4. The Radiance of the Sky at High Altitudes: Newkirk and Eddy	134
7.5. Air Glow Spectra: Noxon and Jones	135
7.6. Direct Photometric Measurements of Particles Producing Visible Auroras: C. E. McIlwain	136
7.7. Ultraviolet Radiation in the Night Sky: Kupperian and Others	138
7.8. The Celestial Background: Nortronics	139
8. Selected High-Altitude Solar Spectra	142
8.1. Introduction	142
8.2. The Infrared Solar Spectrum: T. D. Moss and Others	143
8.3. Solar Radiation Measurements: D. G. Murcray	144

UNCLASSIFIED

UNCLASSIFIED

WILLOW RUN LABORATORIES

8.4. Solar Spectra and Atmospheric Absorption Measurements by CARDE of Canada: Cumming, Fjarlie, and Hampson	147
8.5. Further Solar Measurements by CARDE of Canada: Cumming, Fjarlie, and Hampson	149
8.6. The Ultraviolet Solar Spectrum: F. S. Johnson and Others	150
Distribution List154

UNCLASSIFIED

WILLOW RUN LABORATORIES

FIGURES *Unclassified*

1. Distribution of Radiometric Data by Wavelength	12
2. Distribution of Spectrometric Data by Wavelength	14
3. Distribution of Solar Spectra by Wavelength	14
4. Relative Transmission vs. Wavelength for Five Filters	17
5. Field of View of the Radiometer	18
6. Individual Transmission Curves for Filters in the Filter Wheel of the Radiometer	22
7. Individual Transmission Curves for Filters in the Filter Wheel of the Ultraviolet Radiometer	23
8. Configuration of the Instrument Bay of the Aircraft	29
9. Optical Configuration of the Spectrometer	30
10. Overall Spectral Response Curves	31
11. Route Over Which Measurements of Radiance Were Made from the Air. . .	37
12. Transmission Curves for Filters in the Filter Wheel of the Radiometer	38
13. Configurations of Detectors Used in the Four-Color Experiment	40
14. Spectral Responses of Aerospace Ultraviolet Radiometers	43
15. Effective Spectral Responses of TIROS Radiometer Channels vs. Wavelength	48
16. The Nimbus I Spacecraft	52
17. Schematic of the Optical System of the Nimbus I HRIR	53
18. Nimbus I AVCS and APT Television Coverage	54
19. Scan Pattern of the Nimbus I HRIR System	55
20. Nimbus Program Data Flow	56
21. Ground System for Handling Nimbus Data	57
22. Gridding Subsystem of Nimbus Data-Handling System	58
23. Relative Cell-Filter Response for TASCAN	63
24. Filter Curves for Detectors in T-BIRD 10	66
25. The BIRA 01 Color-Wheel Radiometer System	69
26. Spectral Response of the BIRA 01 Color-Wheel Radiometer	70
27. Spectral Response of the BIRA 01 Ultraviolet Radiometer	72
28. The BIRA 01 Scan Pattern	72
29. Optical Design of the Ultraviolet Spectrometer Used in the Northrop Investigation of Ultraviolet Surveillance Technique	76
30. Spectral Response of the Photomultiplier (No. CL1125) of the Spectrometer Used in the Northrop Investigation of Ultraviolet Surveillance Technique	77
31. Spectral Transmission of Optical Components in Mercury Spacecraft . . .	81

UNCLASSIFIED

UNCLASSIFIED

WILLOW RUN LABORATORIES

32. Transmission Curves for Infrared Filters 1 and 5 of the Radiometer Filter Wheel Used in Studying the Horizon At 15 μ and the Thermal Region	95
33. Optical System of the Eastman Kodak Radiometer	98
34. Spectral Response Curves for Three Filters in the Kodak Satellite	99
35. Typical System Spectral Response for a TRIS 4.3- μ Radiometer	102
36. Spectral Transmission Curves of Filters Used in Infrared-Horizon Measurements vs. Wavelength	105
37. The Relative Angular Response Function of the Optics-Detector System Used in Infrared-Horizon Measurement vs. the Angle from the Optical Axis	106
38. Filter Transmission Curve from Flux-Gradient Measurements	109
39. Field of View of the I-4T Interferometer Spectrometer	116
40. Filter-Phototube Spectral Response	123
41. Albedo Measurements	131
42. Transmission Curves for Interference Filters Used in Early Photoelectric Measurements of Sky Brightness	131
43. Spectral Response of the 1P21 Photomultiplier Tube	137
44. Cross Sections of the Nortronics Photometers	140
45. Spectral Response Curves of the Nortronics Photometers	141

TABLES *Unclassified*

I. Comparative Characteristics of Instruments Used in Measurements of Infrared and Visible Radiation	27
II. Flights of TIROS Satellites	46
III. Spatial Parameters of the TIROS Camera Systems	49
IV. Orbital Characteristics of Two Transit Satellites	61
V. Flight Details of T-BIRD Probes	65
VI. Detectors Used in RAE Radiation Measurements	74
VII. Characteristics of the Four-Channel Compound Radiometer Used in the Langley Research Center Rocket Probe	107
VIII. Filters Governing MRIR Bands in TIROS and Nimbus Satellites	127
IX. High-Altitude Experiments Involving Ultraviolet Solar Spectra	151

UNCLASSIFIED

WILLOW RUN LABORATORIES

BACKGROUND MEASUREMENTS MADE ABOVE FIVE KILOMETERS: A SURVEY OF THE LITERATURE (U)

1 INTRODUCTION *Unclassified*

This report surveys available optical background measurements made by various agencies and reported up to 1967. The backgrounds considered are primarily those seen when looking down at the earth and its atmosphere. Most of these measurements were made at altitudes greater than 10 km. In addition, horizon measurements, total hemisphere irradiance measurements, sky brightness measurements, and solar spectrum measurements are included. An extensive search has been made of the literature, and workers in the field have been contacted in an effort to make the survey as complete as possible.

The purpose of this survey is to help the system designer find among the available measurements those that are useful for his particular purpose. It is felt that a simple listing of the agencies that have made measurements would not be useful to many researchers because the individual with a hypothesis to test or a design parameter to estimate needs to know whether a particular set of data contains the information he may require. This survey should enable the reader to determine whether the information he desires is available by informing him of the important parameters in each experiment. If the reader is interested in a particular experiment, he can refer directly to the review of that experiment in sections 3 through 8. If, on the other hand, he is interested in a particular parameter without reference to any specific experiment, he can consult the indexes for this information. This report will probably be most useful to nonspecialists in the field of background measurements, although specialists should also find it a convenient reference.

The authors have followed the basic outline shown below in preparing the reviews of background measurement programs.

- I. Instrument description and platform
 - A. Platform, time, date, location, and maximum altitude
 - B. Brief description of instruments used
 - C. Spectral information
 - D. Spatial information
 - E. Data recording procedures

UNCLASSIFIED

UNCLASSIFIED

WILLOW RUN LABORATORIES

II. Data: a description of the format, quality, and availability of the data obtained

The references cited in this survey were drawn from numerous sources. Therefore, users wishing to retrieve the reference documents may not, in general, expect to be served by any ordinary library or single government service. Rather, some knowledge of the various possible supply agencies is needed for each referenced document.

2 INDEXES *Unclassified*

The reviews in this report are indexed in four ways: in chart form, by subject, by author, and by wavelength. The chart index has been prepared for quick and easy reference to experiments by specific parameters. This index also provides an alphabetical corporate-author listing. The key to the symbols used in this chart is given below.

2.1. (U) CHART INDEX

Chart Index Key

Instrument

- C Camera or other image-forming device
- R Radiometer
- S Spectrometer

Platform

- A Aircraft
- B Balloon
- R Rocket or missile
- S Satellite

Scan Pattern







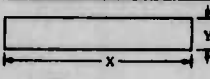

- A Azimuth
- C Complex: scan pattern too complicated to be described easily
- E Elevation
- F Fixed: instrument held in one position relative to a balloon
- H Horizon: scan across horizon
- L Linear: instrument fixed with respect to platform and platform moving linearly
- R Raster

UNCLASSIFIED

UNCLASSIFIED

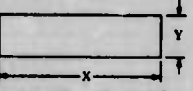
WILLOW RUN LABORATORIES



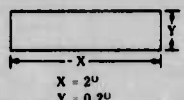





CHART INDEX

Section	Corporate Author and Date of Experiment	Nature of Measurement	Instrument	Spectral Information	Platform	Maximum Altitude	Spatial Resolution and Shape of Field of View	Scan Pattern	Approximate Precision
3.8	Aerospace Corporation (1962)	Absolute radiance at nadir and horizon	R	1.4 μ 1.8 μ 2.2 μ 2.7 μ	S	344 km	 X = 25 mrad. Y = 2.5 mrad	L	+ 10%
3.9	Aerospace Corporation (1962)	Absolute radiance at nadir and horizon	R	0.255 μ	S	593 km	Nadir: X = 10 mrad.  horizon: all azimuth -15° to 0° elevation	L	—
4.4	Air Force Cambridge Research Laboratories (1965)	Spectral reflectance	S	0.24 to 0.28 μ	A	60 km	Not given	A	—
3.10	Air Force Cambridge Research Laboratories (1962)	Absolute spectral radiance at nadir	S	1.8 to 15 μ ; $\Delta\nu = 40 \text{ cm}^{-1}$	S	617 km	 X = 15°	L	+ 50%
5.8	Aircraft Radiation Laboratory WADC (1949-1950)	Relative radiation across horizon	R	Wideband infrared	A	7 km	Not given	II	—
7.2	American Geophysical Union (1964-1951)	Sky brightness	R	0.428 μ 0.472 μ 0.567 μ 0.615 μ 0.428 μ 0.559 μ 0.42 to 0.59 μ	R	—	5.50° 	—	—
6.4	Army Signal Research and Development Laboratories (1959)	Net upward flux	R	Wideband infrared	B	33 km	Hemisphere	F	+ 15%
3.5	Arthur D. Little, Inc. (1963-1964)	Absolute spectral radiance	S	2.3 to 3.8 μ ; $\Delta\lambda = 0.01 \mu$ to 0.1 μ	A	21 km	 X 2.30° 1.38° 2.30° Y 0.46° 0.46° 0.09°	L, A	+ 22%
6.7	Ball Brothers (1961)	Spectral irradiance	S	4.5 to 40 μ	B	4.1 to 36 cm	Not given	E	—
5.10	Ballistic Research Laboratories (1954-1955)	Horizon photographs	C	0.80 μ peak sensitivity	B	24 km	—	—	—
3.6	Barnes Engineering Co. (1962)	Thermal radiance of clouds	R	7.5 to 13.5 μ	A	—	 2°	L	—
6.3	Block Associates, Inc. (1962)	Absolute spectral radiance at nadir	S	5 to 15 μ ; $\Delta\nu = 40 \text{ cm}^{-1}$	B	16 km	 X = 7° or 15°	F	—
5.3	Block Engineering, Inc. (1963)	Horizon radiance	S	6.5 μ ; 9.6 μ ; 10.8 μ ; 14.8 μ ; $\Delta\nu = 20 \text{ cm}^{-1}$	B	18 km	Not given	R	—
8.4	CARDE of Canada	Solar spectrum	S	1 to 3 μ	A	12 km	Narrow field of view, fixed on sun	L	—
8.5	CARDE of Canada (1959)	Solar spectra, atmospheric emission	S	Solar: 2.4 μ to 5.2 μ ; emission: 2 to 8 μ	B	30 km	Conical field of view: half-angle = 5°	F	—
8.3	University of Denver (1955-1956)	Solar spectrum	S	0.5 to 4.5 μ	B	22 km	Narrow field of view, fixed on sun	F	—
3.2	Denver Research Institute (1958-1959)	Absolute radiance	R	Ultraviolet, visible infrared; five filters cover 1.3 to 40 μ	B	27 km	 X = 0.5°	A, E	+ 10%

UNCLASSIFIED

UNCLASSIFIED









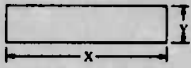

WILLOW RUN LABORATORIES

Section	Corporate Author and Date of Experiment	Nature of Measurement	Instrument	Spectral Information	Platform	Maximum Altitude	Spatial Resolution and Shape of Field of View	Scan Pattern	Approximate Precision
5.2	Denver Research Institute (1959)	Horizon structure	R	1.30 to 1.85 μ 7.0 - . . . μ	B	27 km	 0.5 ⁰	H	—
3.3	Denver Research Institute (1961-1962)	Absolute radiance	R	Four filters cover 0.25 to 0.45 μ ; nine filters cover 1.8 to 5.0 μ	B	30 km	 X = 1.5 mrad	A, E	—
5.4	Eastman Kodak Co. (1962)	Horizon radiance	R	Three filters centered at 15 μ	S	150 km	 X = 2 ⁰ Y = 0.2 ⁰	A, E	—
3.7	Emeraon Electric Manufacturing Co. (1961-1962)	Absolute radiance at nadir	R	0.35 μ 0.45 μ 0.58 μ 0.85 μ 0.8 μ 1.02 μ 1.82 μ 2.0 to 2.6 μ	A	6 km	 X = 6.9 ⁰	L	—
5.6	General Dynamics Astronautics (1961(?))	Horizon radiance	R	2.7 μ 3.5 μ 4.3 μ 4.7 μ 8.3 μ	R	241 km	 X = 0.21 ⁰	H	—
3.19	General Electric Co. (1959)	Cloud photographs	C	Viable	R	1295 km	—	—	—
7.4	High Altitude Observatory Boulder, Colorado (1960)	Sky brightness	R, S	Viable spectrum	B	24 km	—	F	—
3.22	W. E. Howell Associates, Inc. (1960)	Three-dimensional cloud maps	C	Viable	A	15 km	—	—	—
3.24	Hughes Aircraft Co. (1947)	Sky brightness	R	S-2 response 0.74 to 1.05 μ	A	10 km	Contax field of view: roughly 10 ⁰	E	Moderate precision
6.2	Johns Hopkins University (1956-1961)	Absolute spectral radiance at nadir and at +60 ⁰ elevation	S	6.3 to 30 μ ; $\Delta\lambda = 0.1$ at 10 μ	B	30 km	Not given	F, E	—
5.7	Langley Research Center (1961)	Horizon profile	R	Four channels in ultraviolet, visible, and infrared; 0.23 to 25 μ	R	300 to 500 km	Approximately 0.5 ⁰ x 0.5 ⁰	H	± 30%
3.23	Meteorological Satellite Laboratory (1962)	Photographs of earth and horizon	C	Six filters cover 0.38 to 0.72 μ	S	272 km	—	—	—
3.4	The University of Michigan (1962)	Testing TIROS instruments	R	TIROS 5.8 to 88 μ 7.5 to 13 to 5 μ 0.2 to 8.0 μ 7.5 to 30.8 μ 0.55 to 75 μ	B	34 km	 5 ⁰	C	—
			R	MNIR 8.5 to 70 μ 10.0 to 11.4 μ 0.2 to 4.0 μ 5.0 to 30.1 μ 0.55 to 0.35 μ	—	34 km	 2.85 ⁰	C	—
			S	I-4T 8 to 16.5 μ	—	34 km	 15 ⁰	C	—
			S	S-G-4 0.4 to 1.05 μ	—	34 km	 0.25 ⁰	C	—

UNCLASSIFIED





UNCLASSIFIED

WILLOW RUN LABORATORIES

Section	Corporate Author and Date of Experiment	Nature of Measurement	Instrument	Spectral Information	Platform	Maximum Altitude	Spatial Resolution and Shape of Field of View	Scan Pattern	Approximate Precision
6.10	The University of Michigan (1963)	Spectral flux	R	TIRCS 5.8 to 6.8 μ 7.5 to 13.5 μ 0.2 to 6.0 μ 7.5 to 30 μ 0.55 to 75 μ	B	34 km		C	—
			R	Nimbus 6.5 to 70 μ 10.0 to 11.0 μ 0.2 to 4.0 μ 5.0 to 30.0 μ 0.55 to 0.85 μ	—	—		C	—
			S	6 to 16.7 μ	—	—		C	—
3.23	National Aeronautics and Space Administration (Vanguard II) (1959)	Infrared cloud mapping	R	0.75 μ	S	500 km	Conical field of view: half-angle = 1.1 $^{\circ}$	A	—
3.12	National Aeronautics and Space Administration (Nimbus I) (1964)	Visible and infrared pictures of cloud patterns, global coverage	R, C	Radiometer: 3.5 to 4.1 μ ; vidicon camera: visible range	S	423 to 933 km	 Wide angle field of view: 800 lines per frame. X = 108 $^{\circ}$, Y = 36.5 $^{\circ}$	R	+ 5 f
3.11	National Aeronautics and Space Administration (Tiros) (1960-1963)	Absolute radiance and cloud pictures	R, C	Camera: peak sensitivity 0.7 to 0.9 μ ; radiometers: 6 to 6.5 μ , 8 to 12 μ , 0.2 to 6 μ , 8 to 30 μ , 0.55 to 0.75 μ , widerband infrared	S	972 km	 X = 5 $^{\circ}$, except for wideband infrared where X = 50 $^{\circ}$	C	—
7.3	Naval Medical Research Institute (1951-1952)	Sky brightness	R	Human eye response	A	15 km	 X = 20'	A, E	—
3.14	Naval Ordnance Test Station (TASCAN) (1960)	Radiance map	R	2.16 to 2.73 μ	R	102 km	 X = 10 mrad	R	—
3.15	Naval Ordnance Test Station (T-BIRD) (1962-1963)	Multispectral radiance in two dimensions	R	1.9 μ 2.2 μ 2.7 μ 4.3 μ 6.7 μ	R	64 km	 X = 23 mrad	R	—
3.13	Naval Ordnance Test Station (Transit 2A) (1960)	Radiance map	R	1.85 to 2.73 μ	S	1064 km	 X = 6 mrad	R	—
3.16	Naval Ordnance Test Station (BIRA 01) (1964)	Daytime cloud radiance and reflectance	R	Nine filter on wheel: 2.34 μ 2.56 μ 2.68 μ 2.71 μ 2.94 μ 3.30 μ 3.65 μ 4.30 μ 4.75 μ	R	50 km	 X = 5 mrad	E	+ 15 f
5.5	Naval Ordnance Test Station (1963)	Horizon profile	R	2.2 μ 2.7 μ 4.3 μ 0.27 μ	R	40 km		C	50 f

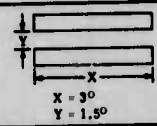
UNCLASSIFIED

WILLOW RUN LABORATORIES

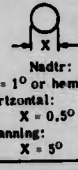
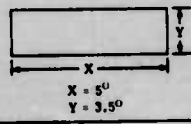
Section	Corporate Author and Date of Experiment	Nature of Measurement	Instrument	Spectral Information	Platform	Maximum Altitude	Spatial Resolution and Shape of Field of View	Scan Pattern	Approximate Precision
8.6	Naval Research Laboratory (1946-1960)	Solar spectra	S	0.21 to 0.35 μ	R	70 km	Not given	F	---
3.16	Northrop Space Laboratories (1963)	Ultraviolet radiance	S	0.005 to 0.10 μ	A	92 km		A	---
5.9	Naval Research Laboratory (1949)	Horizon radiance and gradient	R	> 3 μ	A	9 km		H	---
7.7	Naval Research Laboratory (1955)	Nighttime ultraviolet	R	0.104 to 0.135 μ 0.122 to 0.135 μ	R	146 km		C	---
7.8	Northrop Division, Northrop Corp. (1964)	Sky brightness	R	Visible spectrum	R	20 to 200 km	Broad field of view	L	---
6.9	University of Oxford (1953-1954)	Atmospheric flux	R	1 to 30 μ	A	11 km		L	---
4.2	Radiation, Inc. (1957)	Spectral reflectance	S	0.4 to 3.0 μ	A	6 km	Hemisphere	L	---
4.3	University of Rhode Island (1954)	Albedo measurements	R	Wideband infrared	B	30 km	Hemisphere	F	---
3.17	Royal Aircraft Establishment (England) (1961-1962)	Reflected sunlight from clouds	R	Two filters cover 2 to 5 μ	A	12 km		A, E	---
8.2	Royal Aircraft Establishment (England; T. S. Moss) (1957-1960)	Solar spectrum	S	1.0 to 6.5 μ	A	16 km	Narrow field of view, fixed on sun	L	High precision
7.5	University of Saskatchewan (1960)	Air-glow spectra	S	1.6 to 3.7 μ	B	7.5 km	Narrow field of view	F	$\pm 50\%$
6.8	Scripps Institute of Oceanography (1957)	Absolute radiance	R	Red, green, blue, human eye	A	6 km		A, E, L	---
3.21	Stanford Research Institute (1960-1962)	Cloud photographs	C	Visible	A	20 km	---	---	---
7.6	State University of Iowa (1958)	Measurements of visible aurora	R	0.32 to 0.53 μ	R	120 km		C	---
6.6	University of Wisconsin (1959) (Explorer VII)	Radiation balance of earth	R	Wideband infrared	B	1100 km	Hemisphere	L	---
6.5	Woods Hole Oceanographic Institute (1962(?))	Total infrared flux	R	Blackbody response	A	5 km	Broad field of view	L	---

UNCLASSIFIED

UNCLASSIFIED

WILLOW RUN LABORATORIES

2.2. (U) SUBJECT INDEX

Subject	Section
Aerospace "Four-color experiment"	3.8
Aircraft platform	3.5, 3.6, 3.7, 3.17, 3.18, 3.21, 3.22, 3.34, 4.2, 4.4, 5.8, 5.9, 6.5, 6.8, 6.9, 7.3, 8.2, 8.4
Air glow	7.5
Albedo determinations	3.9, 3.18, 4.3, 4.4, 6.6
Atmospheric	
Absorption	8.3, 8.4
Emission	6.2, 6.3, 6.4, 6.9, 7.6, 7.7, 8.5
Transmission	8.5
Aurora	7.6
Balloon platform	3.2, 3.3, 3.4, 4.3, 5.2, 5.3, 5.10, 6.2, 6.3, 6.4, 6.7, 6.10, 7.4, 7.5, 8.3, 8.5
BIRA 01 and BIRA 02	3.16
Clouds	
Distributions	3.6, 3.11, 3.12, 3.19, 3.21, 3.22, 3.23
Radiance	3.4, 3.5, 3.6, 3.7, 3.8, 3.9, 3.13, 3.14, 3.16, 3.18, 3.20, 5.8, 6.9
Reflectance	3.5, 3.18
Data	
Photographic	
Visible	3.6, 3.7, 3.11, 3.12, 3.16, 3.19, 3.20, 3.21, 3.22
Infrared	3.13, 5.10
Radiometric (radiance)	
Altitude dependent (radiance as a function of altitude)	5.4, 5.5, 6.2, 6.4, 6.5, 7.2, 7.3, 7.6
Azimuth dependent	3.2, 3.3, 3.11, 3.16, 3.17, 7.3
Elevation-angle dependent	3.2, 3.3, 3.5, 3.11, 3.16, 5.8, 7.3
Geographical variation	3.7, 3.10, 3.11, 3.12, 5.4
Horizon profile	3.2, 5.2, 5.4, 5.5, 5.6, 5.7, 5.8, 5.9, 5.10
Isoradiance plots	3.2
Radiance gradient	3.2, 3.3, 3.6, 6.2, 6.9
Scattering-angle dependent	3.3, 3.5, 3.9, 7.3
Two-dimensional*	3.2, 3.3, 3.11, 3.12, 3.13, 3.14, 3.15
Spectrometric (spectral radiance)	
Altitude dependent	4.2, 6.2, 6.3, 6.7, 7.5, 8.3, 8.5
Elevation-angle dependent	6.7, 6.10
Horizon profile	5.3
Scattering-angle dependent	3.7

*Data are potentially usable for reconstruction of a two-dimensional radiance map.

UNCLASSIFIED

UNCLASSIFIED

WILLOW RUN LABORATORIES

Statistically analyzed	
Cloud dimensions, probability distribution	3.21
Cloud and terrain spectra, averaged	3.5, 3.7
Radiance levels	
False-alarm probability	3.5
Joint distribution (multispectral)	3.8, 3.15
Means and deviations from means	3.3, 3.8, 5.4
Probability distribution	3.3, 3.7, 3.8, 5.7
Radiance gradients, probability distribution	3.2, 3.3, 3.8
Detectors	
Arrayed	3.6, 5.4, 5.9
Cooled	3.3, 3.5, 3.16, 3.17, 5.6, 8.5
Ion chamber	7.7
Photoconductive	3.3, 3.7, 3.8, 3.13, 3.15, 3.16, 3.23, 5.6, 5.7, 8.2, 8.3, 8.4, 8.5
Photocell	3.24, 7.8
Photomultiplier	3.3, 3.16, 3.18, 4.2, 5.7, 6.8, 7.3, 7.6
Pyreheliometer	4.3
Thermistor or bolometer	3.2, 3.10, 4.2, 5.4, 5.7, 6.3, 6.4, 6.5, 6.6, 6.10
Thermocouple or thermopile	5.8, 5.9, 6.2
Explorer VII	6.6
Filters: see figure 1	
Flux measurements	3.24, 5.8, 6.2, 6.3, 6.4, 6.5, 6.6, 6.8
HITAB- TRIS	5.5
High-resolution spectroscopy*	3.10, 5.3, 8.2
Horizon discontinuities	3.2, 3.3, 3.20, 5.2, 5.3, 5.4, 5.5, 5.6, 5.7, 5.8, 5.9, 5.10
Meteorological phenomena	
Viewed in infrared	3.11, 3.12
Viewed in visible	3.11, 3.12
Missile platform: see <u>Rocket platform</u>	
Nighttime measurements	
Aurora	7.6
Radiance	3.12, 5.5, 5.9, 6.2, 6.3, 6.4, 7.5, 7.8
Nimbus I	3.12, 6.10
Ozone emission	8.6
Photography	
Infrared	3.13, 5.10
Visible	3.6, 3.7, 3.11, 3.12, 3.16, 3.19, 3.20, 3.21, 3.22
Probability distribution of radiance values	3.3, 3.8, 5.7

*Resolution is on the order of 0.03 μ or better.

UNCLASSIFIED

WILLOW RUN LABORATORIES

Reflectance	
Cloud	3.5, 3.18
Terrain	3.5, 4.2, 4.4
Rocket platform	3.14, 3.15, 3.16, 3.19, 5.5, 5.6, 5.7, 7.2, 7.6, 7.7, 7.8, 8.6
Satellite platform	3.8, 3.9, 3.10, 3.11, 3.12, 3.13, 3.23, 5.4, 6.6
Scattering-angle correlated data	3.3, 3.5, 3.16, 3.18, 7.3, 7.4, 7.8
Sea backgrounds	3.11, 3.12, 4.2, 7.3
Sky brightness	3.24, 7.2, 7.3, 7.4, 7.8
Solar spectra: see figure 3	
Spectral response	
Cameras: see <u>Photography</u>	
Photomultipliers: see figure 1	
Radiometers: see figure 1	
Spectrometers: see figure 2	
Spectral scanning: see figure 2	
Statistical analysis: see <u>Data, Statistically analyzed</u>	
T-BIRD	3.15
TASCAN	3.14
Terrain measurements	3.7, 3.12, 4.2, 4.4
TIROS	3.4, 3.8, 3.11, 6.10
Transit 1A, 1B, and 2A	3.13
Ultraviolet measurements	3.2, 3.3, 3.16, 3.18, 4.4, 5.7, 7.7, 8.6
Vanguard II	3.23
Vidicons, visible	3.11, 3.12

2.3. (U) AUTHOR INDEX

Author	Section	Author	Section
Alder, J. E.	3.21	Bechtol, T. R.	5.10
Anthony, R.	5.6	Bieber, C. F.	5.9
Band, H. E.	4.4	Blackmer, R. H., Jr.	3.21
Bandeen, W. R.	3.11	Blau, H. H.	3.5
Barnett, V. R.	4.2	Block, L. C.	3.10, 4.4
Barr, N. L.	7.3	Bolleau, A. R.	6.8
Bartman, F. L.	3.4	Born, J.	5.1
Baum, C. C.	3.24	Brewer, A. W.	6.9
Beardsley, N. F.	5.8	Brooks, J. N.	3.2, 5.2

UNCLASSIFIED

UNCLASSIFIED

WILLOW RUN LABORATORIES

Author	Section	Author	Section
Brown, D. R.	3.17	Hughes, N. D. P.	3.17
Burdett, G. L.	3.12	Johnson, F. S.	8.6
Byram, E. T.	7.7	Jones, V.	7.5
Chamberlain, J. P.	3.17	King, J. I. F.	3.19
Chaney, L. W.	3.4, 3.6, 6.10	Klass, P. J.	3.12
Clark, H. L.	5.9	Kupperain, J. E.	7.7
Clarke, D. B.	6.5	Landrum, B. L.	3.18
Coblentz, W. W.	7.2	Lienesch, J. H.	3.11
Collinge, J.	5.4	Loh, L. T.	6.10
Conover, J. H.	3.19	Lovett, J. J.	3.10
Cumming, C.	8.4, 8.5	Lowe, N.	3.14
Darling, E. M., Jr.	3.12	Luckiesh, M.	7.2
Davis, J. F.	3.11	Mayfield, E. B.	3.9
Davis, P. A.	3.11	Mc Ilwain, C. E.	7.6
Dittmar, N. R.	3.16	Mc Kee, J. B.	5.7
Doolittle, R. C.	3.11	Meloy, G. E.	3.8, 3.9
Duncan, J.	5.1	Michaels, J. V.	3.12
Eddy, J. A.	7.4	Miley, H. A.	7.2
Ekrem, R. T.	6.7	Moore, D. K.	3.13, 3.14, 3.16
Espinola, R. P.	3.5	Moss, T. S.	8.2
Fenn, R. W.	6.4	Murcray, D. G.	3.2, 3.3, 5.2, 8.3
Fitzgerald, D. R.	3.6	Nelgner, H. D.	3.7
Fjarlie, E. J.	8.4	Newkirk, G. A.	7.4
Friedman, R. M.	3.8, 3.9	Noxon, J. F.	7.5
Fritz, S.	3.23	Oppel, G.	5.1
Fujita, T.	3.11	Ovrebo, P. J.	5.8
Gates, D. W.	8.3	Parent, R. J.	6.6
Goldberg, I. L.	3.12, 6.10	Persky, M. J.	5.3, 6.3
Goldslak, L.	3.12	Press, H.	3.12
Hampson	8.4	Purcell, J. D.	8.6
Hanel, R. A.	3.11, 3.23	Pyle, R. L.	3.11
Haynie, W.	5.4	Quirk, A. L.	4.3
Hoffleit, D.	5.10	Rao, K. P.	3.11
Houghton, J. T.	6.9, 8.2	Rawcliffe, R. D.	3.8, 3.9
Howell, W. E.	3.22	Reifenstein, E. C., III	3.5
Hoyem, J. A.	3.15, 5.5	Sadler, J. C.	3.19

UNCLASSIFIED

WILLOW RUN LABORATORIES

Author	Section	Author	Section
Samuelson, R. E.	3.11	Vachon, D. N.	3.19
Serebreny, S. M.	3.21	Valovcin, F. R.	3.6
Shackleton, H. R.	4.3	Vestine, E. H.	7.2
Shapiro, R.	3.12	Viezee, W.	3.11
Sigler, J. D.	4.2	Von Thuna, P. C.	3.5
Smiley, V. N.	5.6	Wark, D. Q.	3.11
Smith, C. P.	3.16	Weickman, H. K.	6.4
Smith, R. B.	3.12	Weinstein, M.	6.6
Soules, S. D.	3.20	Wessely, H. W.	3.8
St. George, F. B.	3.13, 3.15	Wexler, R.	3.11
Stair, R.	7.2	White, F. E.	3.2
Stampfl, R. A.	3.11, 3.12	White, R. C.	6.2
Strange, I.	3.11	White, R. W.	6.2
Strong, J.	6.2	Wilkins, G. A.	3.14, 5.5
Stroud, W. G.	3.11, 6.10	Williams, R. L.	3.8
Suomi, V. E.	6.6	Wilson, N. L.	8.6
Teele, R. P.	7.2	Winston, J. S.	3.11
Thompson, J. R.	3.7	Wolfe, W.	5.1
Townsend, M. R.	3.11	Yamamoto, G.	3.11
Tousey, R.	8.6	Zachor, A. S.	3.10

UNCLASSIFIED

2.4. (U) WAVELENGTH INDEX

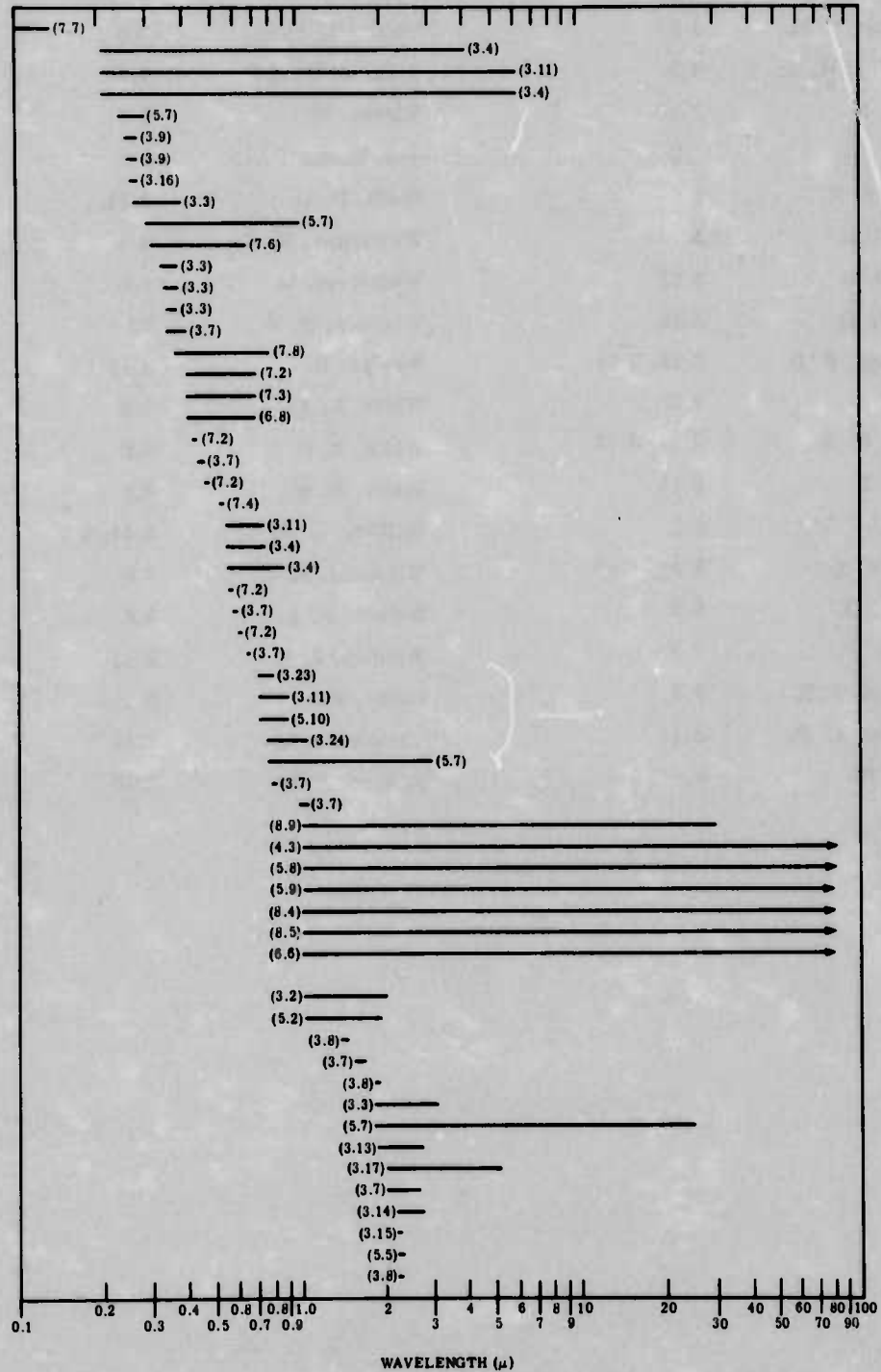

FIGURE 1. DISTRIBUTION OF RADIOMETRIC DATA BY WAVELENGTH. The width of the line indicates the nominal system response. The number in parentheses is that of the relevant review.

Unclassified

UNCLASSIFIED

WILLOW RUN LABORATORIES

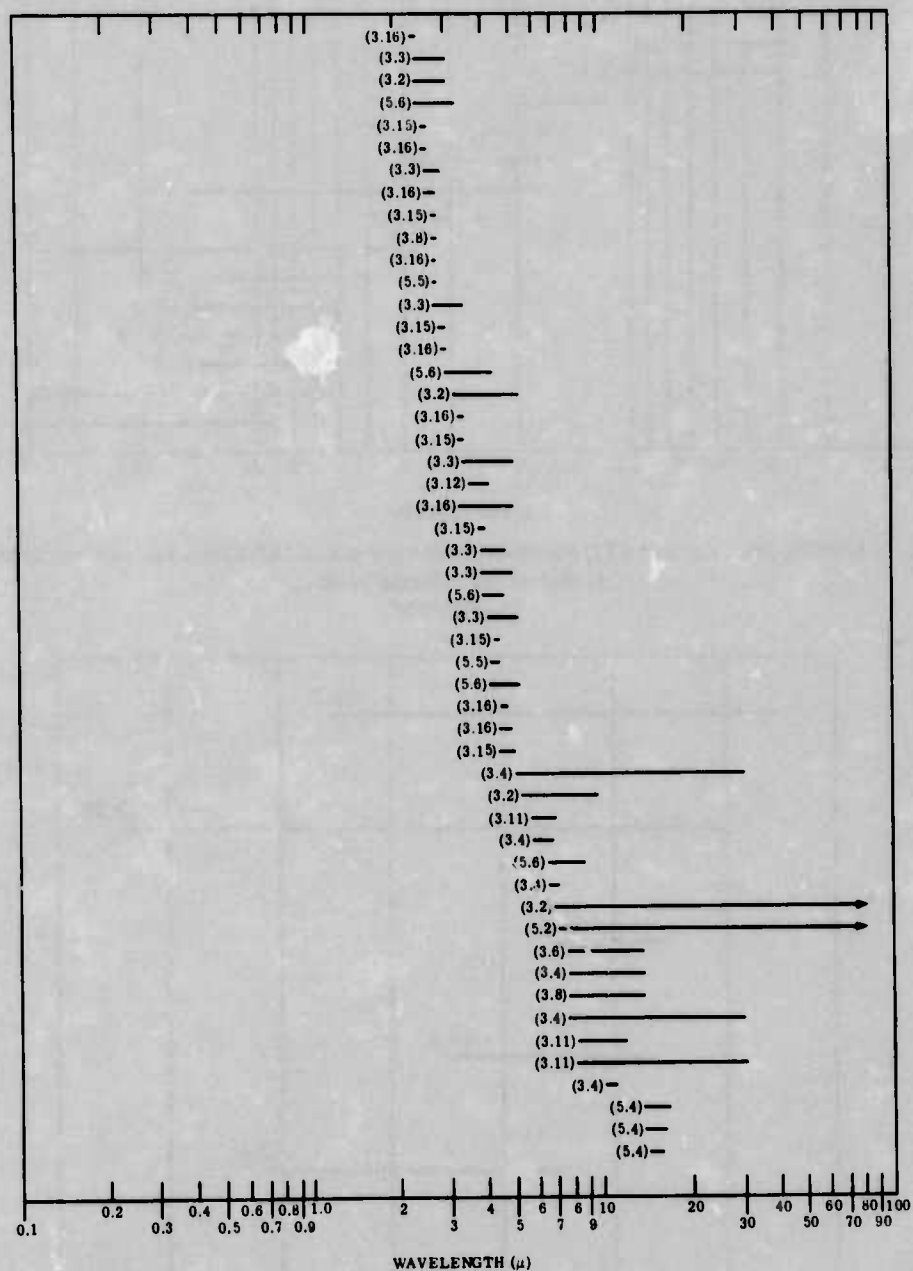

FIGURE 1. DISTRIBUTION OF RADIOMETRIC DATA BY WAVELENGTH. The width of the line indicates the nominal system response. The number in parentheses is that of the relevant review. (Continued)

Unclassified

UNCLASSIFIED

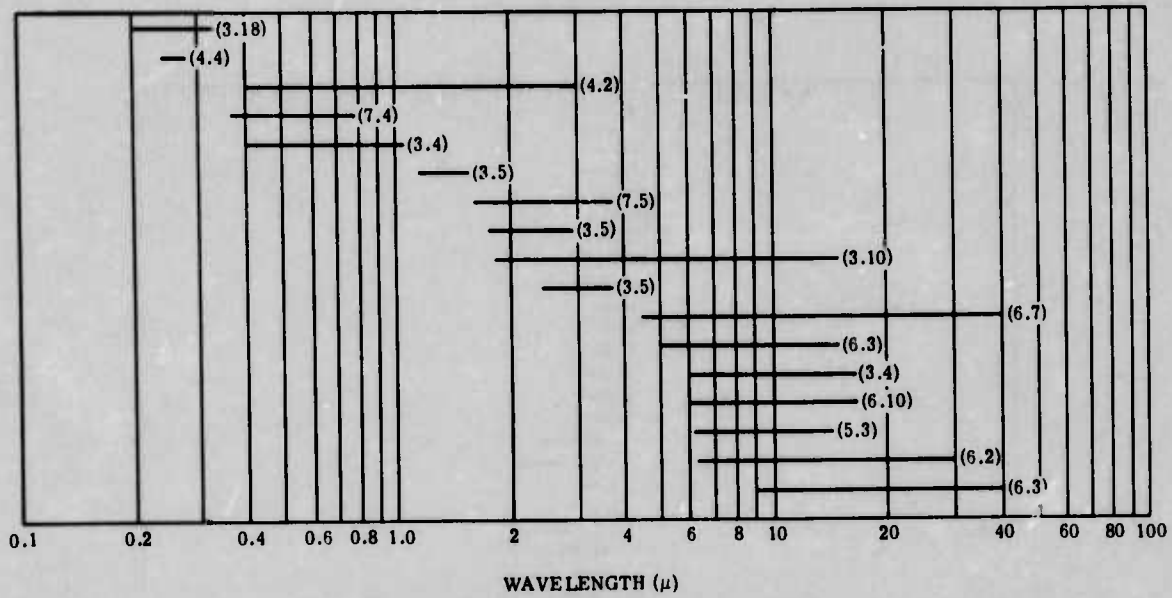

FIGURE 2. DISTRIBUTION OF SPECTROMETRIC DATA BY WAVELENGTH. The number in parentheses is that of the relevant review.
Unclassified

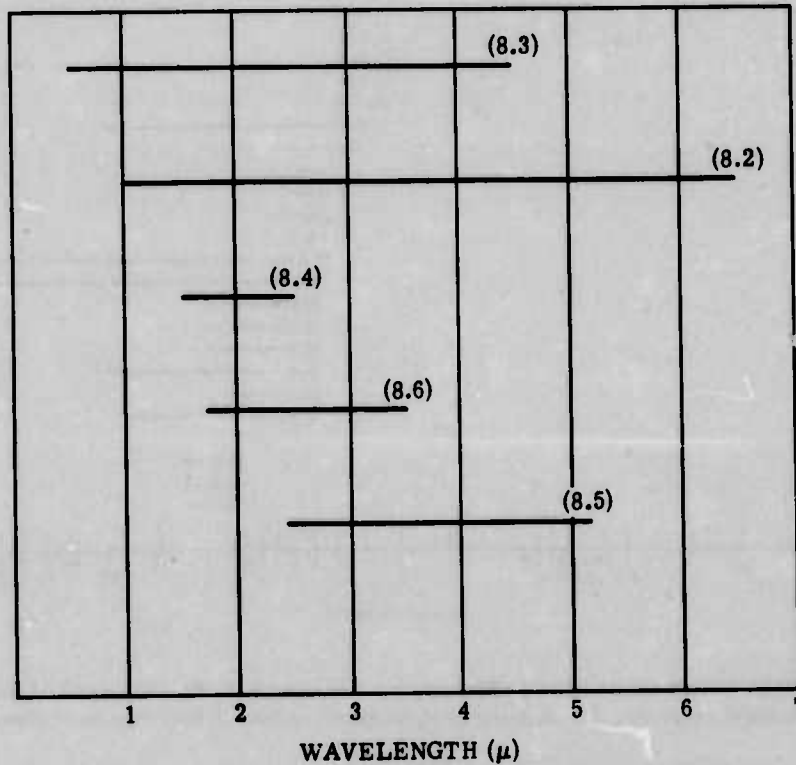

FIGURE 3. DISTRIBUTION OF SOLAR SPECTRA BY WAVELENGTH. The number in parentheses is that of the relevant review.
Unclassified

UNCLASSIFIED

WILLOW RUN LABORATORIES

3

THE INFRARED, VISIBLE, AND ULTRAVIOLET BACKGROUND STRUCTURE AS SEEN FROM ABOVE

Unclassified

3.1. (U) INTRODUCTION

In this section, we review experiments pertaining directly to the optical background structure of the earth and atmosphere under various conditions, as seen from above. Data pertaining to the optical background structure have been produced by (1) experiments concerned solely with the nature of the structure, (2) experiments concerned with a certain aspect of the structure (such as clouds), and (3) meteorological experiments not directly concerned with radiance structure but yielding information on it as a byproduct of the primary results. Experiments falling in these three categories are reviewed in sections 3.2 through 3.24.

3.2. (U) "HIGH-ALTITUDE BACKGROUND STUDIES": D. G. MURCRAY AND OTHERS

I. Instrument Description and Platform

A. General

An ongoing study of the spatial and spectral structure of the infrared background of the earth was initiated in 1958 with the "High Altitude Background Studies" series of balloon flights under the supervision of D. G. Murcray. Spatial scanning and multispectral filtering provided radiance data representing the infrared background as seen from all look angles and over a wide spectral range.

The balloons were launched in generally clear weather over Holloman Air Force Base, New Mexico. Nine missions were carried out, over the period of 8 July 1958 to 9 September 1959. Data were largely recorded while the balloons were at their peak altitudes (in the vicinity of 80,000 ft).

This work was conducted under the auspices of the University of Denver under and Air Force contract.

B. Instrumentation: Calibration

A modified Barnes R-8B1 8-in. radiometer was used. This instrument has been described completely in the first quarterly engineering report (referenced at the end of this section). Cassegrainian optics, an optical chopper wheel, and a filter wheel were components of the optical system. The chopping speed was generally 80 Hz. The detector was a 2.5- by 2.5-mm thermistor bolometer detector with a KRS-5 window.

UNCLASSIFIED

UNCLASSIFIED

WILLOW RUN LABORATORIES

The radiometer was calibrated by the near-extended-source method by means of a Barnes 12-in.-aperture source. In flight, the radiometer looked near to the zenith every 10 min, affording a periodic location of the effective zero level of radiance. Changes in responsivity were followed by a built-in blackbody reference source whose temperature was allowed to vary with the ambient temperature but was accurately monitored.

The field-of-view structure was also measured (cf. referenced sixth quarterly engineering report). This was done by moving an incandescent bulb across the radiometer's field of view at a range of 340 ft.

Auxiliary instrumentation included look-angle-sensing magnetometers, power supplies, recording equipment, and various package transducers (see below). Also, one of the chief modifications of the radiometer entailed the addition of an ultraviolet channel. The ultraviolet channel, however, has not been discussed and will, therefore, not be considered in this review.

C. Spectral Information

Five filters covered a broad infrared range peaked from 1.5μ to beyond 10μ (see fig. 4).

D. Spatial Information

The field of view of the radiometer was 0.5° by 0.5° square (see fig. 5).

In flight, the spatial scan was as follows. The radiometer axis looked at a fixed angle of 10° below the horizontal. A plane mirror was placed in the aperture of the radiometer, deflecting the optic axis through an angle of 80° . The mirror was then rotated, resulting in a conical scan of 160° at the apex. The spin rate of the mirror was 2 rpm. In addition, the radiometer assembly advanced in azimuth 15° at the end of each mirror scan.

E. Data Recording Procedure

The radiometer completed a scanning cycle every 5 min. At the end of the azimuthal excursion, the filter wheel advanced one position. The complete data recording cycle lasted 1 h.

The output from the radiometer and all ancillary information were converted to digital form and stored on a seven-channel digital magnetic tape recorder on the balloon. Recording speeds of 1 in./s and 2.5 in./s were used; the packing

UNCLASSIFIED

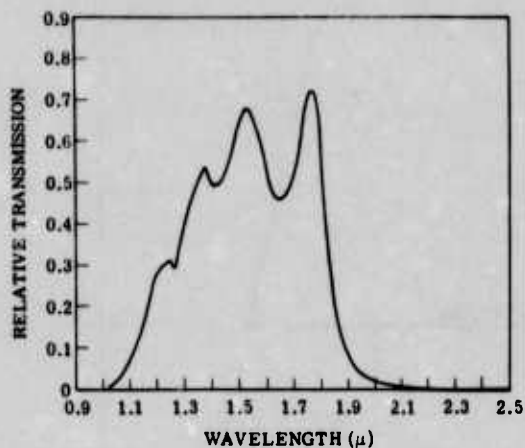

(a) Filter 1

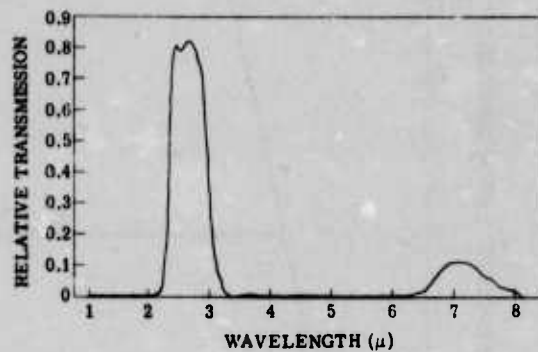

(b) Filter 2

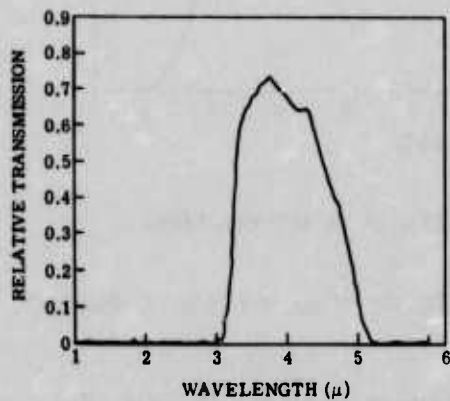

(c) Filter 3

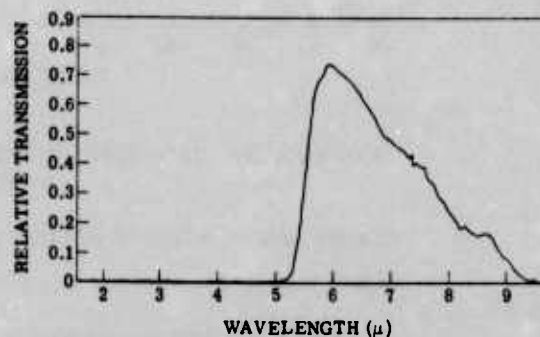

(d) Filter 4

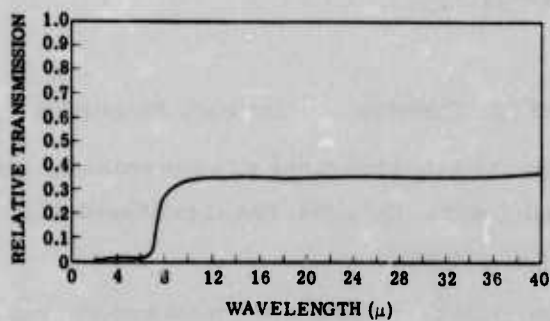

(e) Filter 5

FIGURE 4. RELATIVE TRANSMISSION VS. WAVELENGTH FOR FIVE FILTERS. D. G. Murcra, 1959. Unclassified

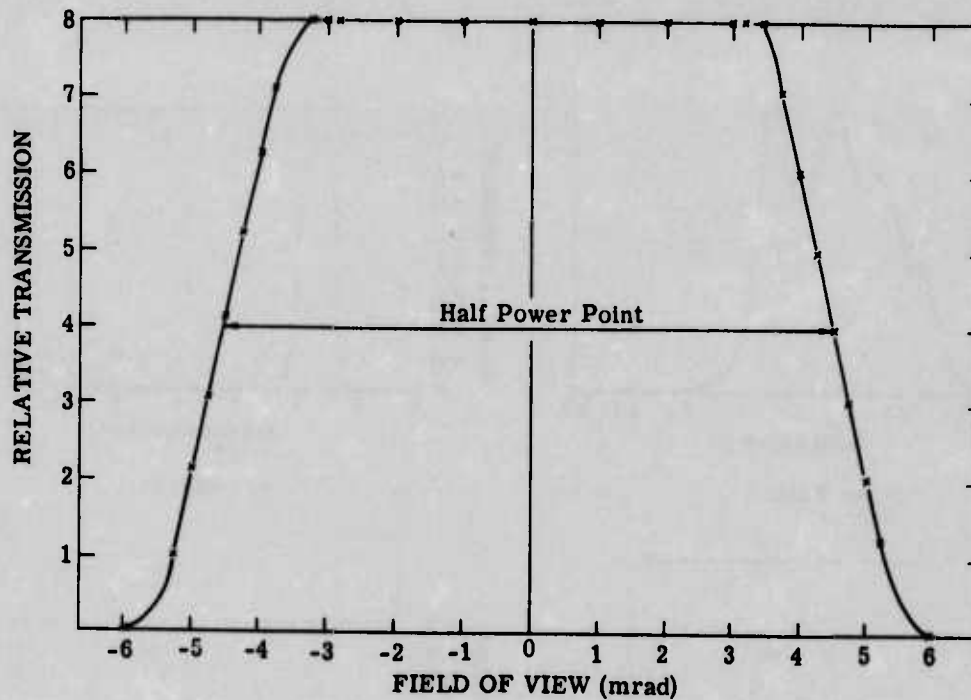

FIGURE 5. FIELD OF VIEW OF THE RADIOMETER. D. G. Murcray, 1959.
Unclassified

density was in excess of 500 bits per inch. The sampling rate of the radiometer signal was 20 per second.

The entire instrumentation package was recovered after each flight. The package temperature was monitored at three localities within the gondola and sent by telemetry to ground.

II. Data

A. Signal Processing: Correlation to Ancillary Parameters

The output from the radiometer was synchronously demodulated immediately after preamplification. The signal was then filtered, converted to digital form, and stored on the recorder.

The signal from the magnetometer potentiometer was recorded simultaneously with the radiance data, thus insuring correlation of radiance to look-angle information. Cloud information and radiometer responsivity variations, on the other hand, were acquired separately.

UNCLASSIFIED

WILLOW RUN LABORATORIES

B. Data Reduction

Digital computer facilities were available for the data reduction by the Denver Research Institute. The tabulated radiance values and correlated look angles were a direct output of the program. Reduction beyond this stage was evidently done by hand.

C. Prepared Data

Data have been prepared and published by the University of Denver workers in the reports referenced at the end of this review. The following have been presented in the final report and the special report no. 1.

- (1) Isoradiance plots that show the radiance as a function of elevation and azimuth angle
- (2) Plots that show the distribution of radiance with elevation
- (3) Graphs that present the distribution of $\frac{dN}{d\theta}$ with elevation (where θ is the elevation angle)
- (4) Graphs that present radiance as a function of elevation angle near the horizon

D. Data Format

The flight tape was ten-channel digital magnetic tape compatible with the Burroughs Datatron Model 205 Computer.

The output from this (radiance values and look angles) was on a paper-tape format for use on a "flexowriter."

E. Experimental Error

The uncertainty in the radiance values can be taken to be $0.2 \text{ mW/cm}^2\text{-sr}$. The look angles were generally known within 2° .

REFERENCES Unclassified

- D. G. Murcay et al., High Altitude Background Studies (Final Report), Denver Research Institute, University of Denver, Denver, Colo., November 1960, AD 246 867.
- D. G. Murcay et al., Infrared Background Radiation as Measured From 85,000 ft. (Special Report No. 1), Denver Research Institute, University of Denver, Denver, Colo., 1959, AD 241 889.

UNCLASSIFIED

UNCLASSIFIED

WILLOW RUN LABORATORIES

D. G. Murcray, F. E. White, and J. N. Brooks, High Altitude Background Studies (First Quarterly Engineering Report), Denver Research Institute, University of Denver, Denver, Colo., August 1957, AD 141 815.

D. G. Murcray, F. E. White, and J. N. Brooks, High Altitude Background Studies (Second Quarterly Engineering Report), Denver Research Institute, University of Denver, Denver, Colo., November 1957.

D. G. Murcray, F. E. White, and J. N. Brooks, High Altitude Background Studies (Third Quarterly Engineering Report), Denver Research Institute, University of Denver, Denver, Colo., February 1958.

D. G. Murcray, F. E. White, and J. N. Brooks, High Altitude Background Studies (Fourth Quarterly Engineering Report), Denver Research Institute, University of Denver, Denver, Colo., May 1958.

D. G. Murcray, F. E. White, and J. N. Brooks, High Altitude Background Studies (Fifth Quarterly Engineering Report), Denver Research Institute, University of Denver, Denver, Colo., August 1958.

D. G. Murcray, F. E. White, and J. N. Brooks, High Altitude Background Studies (Sixth Quarterly Engineering Report), Denver Research Institute, University of Denver, Denver, Colo., December 1958, AD 221 627.

D. G. Murcray, F. E. White, and J. N. Brooks, High Altitude Background Studies (Seventh Quarterly Engineering Report), Denver Research Institute, University of Denver, Denver, Colo., March 1959.

D. G. Murcray, F. E. White, and J. N. Brooks, High Altitude Background Studies (Eighth Quarterly Engineering Report), Denver Research Institute, University of Denver, Denver, Colo., June 1959, AD 221 629.

3.3. (U) THE "FLIGHT DATA" SERIES: D. G. MURCRAY

I. Instrument Description and Platform

A. General

The "Flight Data" series of radiometric measurements made from a balloon was a program similar to the earlier "High Altitude Background Studies," also under the direction of D. G. Murcray. Improved radiometry, narrower filters, and a revised form of data presentation were used in this later series, resulting in data characteristics fundamentally different from those of the previous program. In addition, ultraviolet data were successfully retrieved and analyzed. In all, this program has yielded on the order of 10^7 radiance values for a wide range of insolation angles, viewing angles, cloud conditions, and spectral bands.

Fourteen launchings were carried out between March 1961 and March 1963. The balloons were launched from Fort Wainwright, Alaska, Holloman Air Force Base, New Mexico, and Faribault, Minnesota. Several types of cloud cover were encountered during the flights.

UNCLASSIFIED

UNCLASSIFIED

WILLOW RUN LABORATORIES

This research program was supported by the Aeronautical Systems Division of the United States Air Force Systems Command, through the Denver Research Institute.

B. Instrumentation: Calibration

A modified Barnes 8-in. radiometer was used. This instrument employed Cassegrainian optics, optical chopping at 80 Hz, a 12-position filter wheel, and a photoconductive detector. The detector was an InSb unit, 0.40 mm square and liquid-oxygen cooled.

The radiometer was calibrated using a 72-in.-long blackened aluminum cylinder having a 12-in. diameter as the source. The near-extended-source method was used.

Auxiliary instrumentation included look-angle magnetometers, data recording instrumentation, and a 28-V battery pack.

An ultraviolet radiometer was boresighted with the main radiometer. The ultraviolet radiometer was a photomultiplier device which utilized multiple filtering and optical chopping.

The instrumentation is described here as in the final report (referenced at the end of this section). Some changes took place in the course of the program (see especially Balloon Flight on 9 April and 23 May, also referenced).

C. Spectral Information

The radiometer filter wheel accepted 11 filters and a blank. The filters covered the spectral region from 1.8 to 5.0 μ . The individual response curves are given in figure 6.

The ultraviolet radiometer also employed a filter wheel. The filters in the wheel covered the range from 2500 \AA to 3900 \AA ; the individual transmission curves are given in figure 7.

D. Spatial Information

Both elevation and azimuth scans were made. On flights 1 through 3, scanning was in the form of a cone with an apex angle of 160° and an axis of 10° below the horizontal. While this cone was being traced out, an azimuth scan was also being made. For the remainder of the flights, azimuth scanning was carried out at several discrete elevation angles (see below).

UNCLASSIFIED

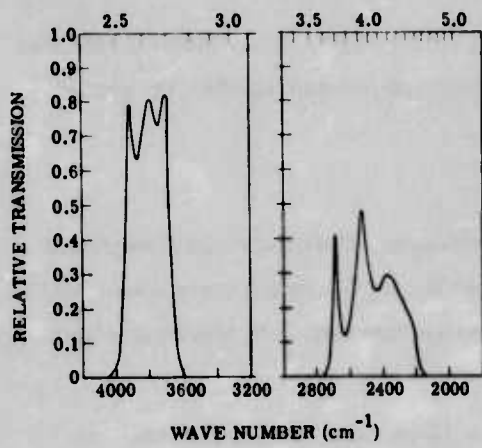

(a) Filter 1

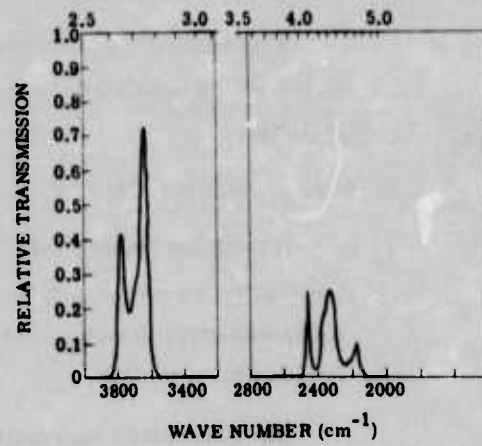

(b) Filter 2

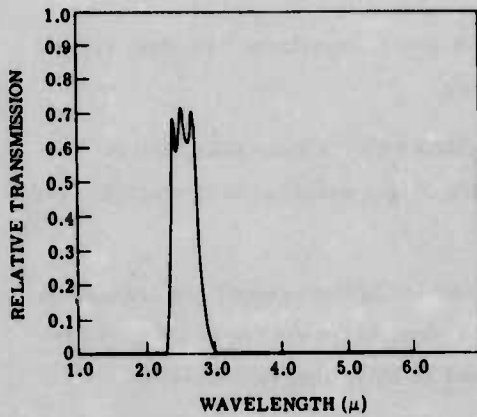

(c) Filter 3

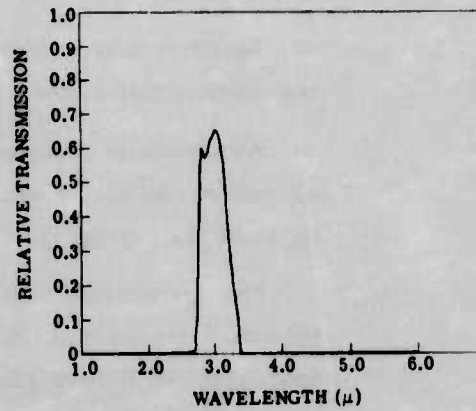

(d) Filter 4

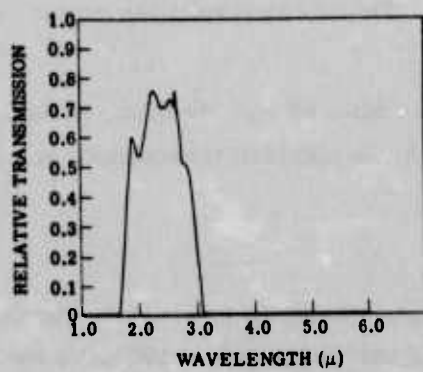

(e) Filter 5

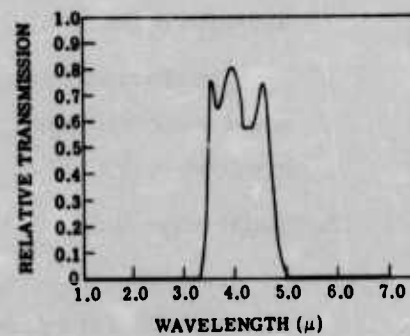

(f) Filter 8

FIGURE 6. INDIVIDUAL TRANSMISSION CURVES FOR FILTERS IN THE FILTER WHEEL OF THE ULTRA-VIOLET RADIOMETER. D. G. Murcray, 1959.

Unclassified

UNCLASSIFIED

WILLOW RUN LABORATORIES

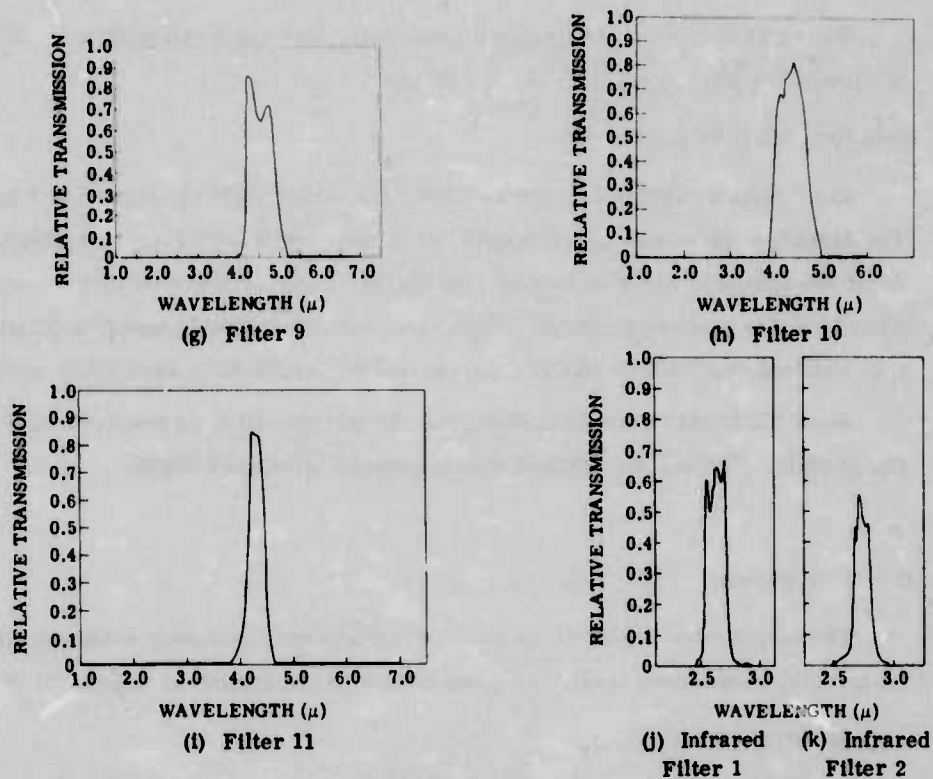

FIGURE 6. INDIVIDUAL TRANSMISSION CURVES FOR FILTERS IN THE FILTER WHEEL OF THE ULTRAVIOLET RADIOMETER. D. G. Murcra, 1959. (Continued)
Unclassified

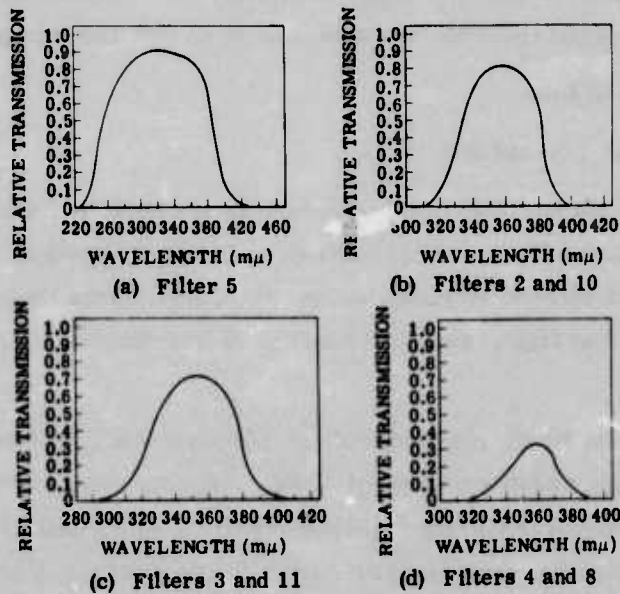

FIGURE 7. INDIVIDUAL TRANSMISSION CURVES FOR FILTERS IN THE FILTER WHEEL OF THE ULTRAVIOLET RADIOMETER.
D. G. Murcra, 1959.
Unclassified

UNCLASSIFIED

UNCLASSIFIED

WILLOW RUN LABORATORIES

The field of view of the infrared radiometer was 1.3 mrad square. The field of view of the ultraviolet unit was not stated.

E. Data Recording Procedure

In its final configuration, the radiometer scanned 180° in azimuth in 1 min. The elevation angle was then changed and the next azimuthal scan completed. After the complete cycle of four or five elevation angles, the next filter was positioned and the process repeated. Combined with the sampling speed of 50 Hz, this resulted in a total of 15,000 radiance values for the time each filter was in.

After digitization, the radiometer signal was recorded on magnetic tape on the gondola. The balloon gondola was recovered after each flight.

II. Data

A. Signal Processing

The output from the infrared radiometer was synchronously detected, filtered, clamped to a reference level, and passed through the analog-to-digital converter.

B. Data Analysis

As mentioned above, the radiometer signals were first digitized and then recorded on magnetic tape. Upon retrieval, the flight tape was played into the University of Denver's digital computer, where preliminary data reduction was done. Final reduction was then done on an IBM 7090 computer.

C. Prepared Data

(1) Infrared data

In the first five flight reports, data are shown in the form of a distribution or cumulative distribution of radiance and radiance gradient (with respect to elevation) at different elevation angles. Graphs also show the radiance as a function of scattering angle. Ancillary information includes the time, date, and balloon altitude.

Data for the remainder of the flights are shown in tabular form. These tables show the root-mean-square and mean radiance as functions of viewing angle and sun azimuth or viewing angle and scattering angle. Ancillary information here includes time, date, cloud conditions, balloon altitude, insolation angle, and the number of observations on which each radiance value is based.

UNCLASSIFIED

WILLOW RUN LABORATORIES

(2) Ultraviolet data

Ultraviolet data are only presented in flight reports 3 through 5, although ultraviolet data were obtained on several of the other flights also. The form of presentation has been similar to that of the infrared data.

D. Data Format

The format for the raw voltage data was 1-mil by 0.5-in. magnetic tape on 3600 ft reels.

The radlance values were evidently stored on tape compatible with the IBM 7090 computer. These data amount to over 10^7 radlance values.

E. Experimental Error

Exact error statements were not available for this writing.

It is also noteworthy that the descriptions of the cloud deck were somewhat vague. Therefore, close correlation of the data with the structure of the background scene is probably not possible.

REFERENCES Unclassified

- D. G. Murcray, Radiance of the Earth in Selected Wavelength Intervals as Observed From High Altitudes (Final Report), Report No. 2149, Denver Research Institute, University of Denver, Denver, Colo., March 1964, AD 437 632.
- D. G. Murcray et al., Balloon Flight of 2 March 1961, Flight Data Report No. 1, Denver Research Institute, University of Denver, Denver, Colo., May 1961.
- D. G. Murcray et al., Balloon Flight of 29 January 1962, Flight Data Report No. 2, Denver Research Institute, University of Denver, Denver, Colo., May 1962.
- D. G. Murcray et al., Balloon Flight of 21 March 1962, Flight Data Report No. 3, Denver Research Institute, University of Denver, Denver, Colo., September 1962.
- D. G. Murcray et al., Balloon Flight of 9 April and 23 May 1962, Flight Data Report No. 4, Denver Research Institute, University of Denver, Denver, Colo., December 1962.
- D. G. Murcray et al., Balloon Flight of 5 July 1962, Flight Data Report No. 5, Denver Research Institute, University of Denver, Denver, Colo., March 1963.
- D. G. Murcray et al., Balloon Flight of 14 July 1962, Flight Data Report No. 6, Denver Research Institute, University of Denver, Denver, Colo., April 1963.
- D. G. Murcray et al., Balloon Flight of 16 July 1962, Flight Data Report No. 7, Denver Research Institute, University of Denver, Denver, Colo., May 1963.
- D. G. Murcray et al., Balloon Flight of 28 August 1962, Flight Data Report No. 8, Denver Research Institute, University of Denver, Denver, Colo., July 1963.
- D. G. Murcray et al., Balloon Flight of 23 October 1962, Flight Data Report No. 9, Denver Research Institute, University of Denver, Denver, Colo., August 1963.

UNCLASSIFIED

UNCLASSIFIED

WILLOW RUN LABORATORIES

D. G. Murcraey et al., Balloon Flight of 29 October 1962, Flight Data Report No. 10, Denver Research Institute, University of Denver, Denver, Colo., September 1963.

D. G. Murcraey et al., Balloon Flight, Flight Data Report No. 11, Denver Research Institute, University of Denver, Denver, Colo., October 1963.

3.4. (U) MEASUREMENTS OF INFRARED AND VISIBLE RADIATION ON BALLOON FLIGHTS AT AN ALTITUDE OF 34 KM: BARTMAN, CHANEY, AND OTHERS

I. Instrument Description and Platform

A. General

In support of the meteorological satellite program of NASA, tests of the radiometric instrumentation have been carried out by various independent agencies. In two high-altitude balloon flights, the TIROS-Nimbus "medium resolution infrared radiometers" (MRIR's) have been tested against an interferometer, direct earth surface temperature measurements, and each other. We describe the resultant data here.

Two balloon flights were made, both beginning in the early morning hours and returning data for the rest of the day. The flights took place on 2 June 1962 and 26 June 1963. Both balloons dwelled at an altitude of about 112,000 ft. The launch site was Sioux Falls, South Dakota.

B, C, D. Instrumentation and Spatial and Spectral Information

The instrumentation was changed somewhat between flights 1 and 2. The essential characteristics are summarized in table I.

The infrared instruments were boresighted; they looked downward at a fixed nadir angle of 30° . The spectrophotometer looked straight down. The azimuthal angle was apparently left to vary at random. Two 70-mm cameras photographed the scenes.

E. Data Recording Procedure

The data were collected by FM/FM telemetry. The format for the interferometer data was analog, on magnetic tape. The format for the other data was not stated.

II. Data

All the data were expressed in terms of equivalent blackbody temperature rather than radiance. The prepared data have been presented in graphical form, as follows (see referenced report by Bartman et al., pp. 387 - 392).

UNCLASSIFIED

UNCLASSIFIED

WILLOW RUN LABORATORIES

- (1) Equivalent blackbody temperature of various cloud scenes (see below)
- (2) Equivalent blackbody temperature vs. scattering angle (0.2 - 6 μ , 0.55 - 0.75 μ)
- (3) Comparison of radiometer measurements from TIROS IV and the balloon-borne TIROS over selected coincident scenes

The following cloud scenes were viewed: low stratus, cirrus, stratocumulus, cirrus over stratocumulus, cumulo-nimbus, and high cumulus.

The blackbody temperatures were always given to three significant figures.

TABLE I. COMPARATIVE CHARACTERISTICS OF INSTRUMENTS USED IN MEASUREMENTS OF INFRARED AND VISIBLE RADIATION
Unclassified

<u>Instrument</u>	<u>Nominal Spectral Bandwidth (μ)</u>	<u>Field Of View (degrees)</u>	<u>Flight</u>
TIROS MRIR	Channel I: 5.8 to 6.8 II: 7.5 to 13.5 III: 0.2 to 6.0 IV: 7.5 to 30 V: 0.55 to 0.75	5, conical	1 and 2
Nimbus MRIR	Channel I: 6.5 to 7.0 II: 10.0 to 11.0 III: 0.2 to 4.0 IV: 5.0 to 30.0 V: 0.55 to 0.85	2.85, conical	2
Block I-4T interferometer	6 to 16.5 at 0.5 μ	15, conical	2
Perkin-Elmer S-G4 spectrophotometer	0.4 to 1.05	2.5 by 0.25	2

REFERENCES Unclassified

F. L. Bartman et al., "Infrared and Visible Radiation Measurements on High Altitude Balloon Flights at 34-km Altitude," Proceedings of the Third Symposium on the Remote Sensing of Environment, Report No. 4864-9-X, Institute of Science and Technology, The University of Michigan, Ann Arbor, February 1965, AD 614 052, pp. 377-392.

UNCLASSIFIED

UNCLASSIFIED

WILLOW RUN LABORATORIES

3.5. (U) SPECTRAL PROPERTIES OF HIGH-ALTITUDE CLOUDS: A. D. LITTLE, INCORPORATED

I. Instrument Description and Platform

A. General

Under the sponsorship of the Advanced Research Projects Agency, A. D. Little, Inc. has completed an experimental study of the infrared spectral radiance of sunlit clouds. The apparatus was installed in a U-2 jet aircraft and flown in a series of approximately 50 flights over various portions of the continental United States. The period over which measurements were made extended from January 1963 through 1964.

This work has yielded a considerable volume of data pertaining to the infrared properties of a variety of clouds with respect to cloud type, cloud altitude, scattering angle, and insolation angle.

B. Instrumentation: Calibration

A modified Perkin-Elmer rapid-scan grating spectrophotometer was used. By means of a flip mirror, the instrument effectively compared radiation from clouds or terrain below the aircraft to sunlight falling on a diffuser plate mounted in the upper skin of the aircraft. Components included Dahl-Kirkham foreoptics and a photoconductive detector (see fig. 8). Ge:Cu, InSb, and PbS detectors were available for interchangeable use; the PbS detector was used in most cases, however. The detector unit was liquid-nitrogen cooled.

Other instrumentation used to record ancillary information included the following:

- (1) A visible radiometer with a 60° field of view and a 0.4- to 0.8- μ spectral response
- (2) Probes that measured the electric potential gradient in the vicinity of the aircraft
- (3) A device that measured aircraft pitch, roll, and yaw
- (4) A data camera from which sun position, time, bearing, and data-synchronization information could be obtained
- (5) A 70-mm tracker camera with a field of view of 42° in the forward direction by 180° in the lateral direction
- (6) A camera with a 15° field of view boresighted with the spectrometer

UNCLASSIFIED

WILLOW RUN LABORATORIES

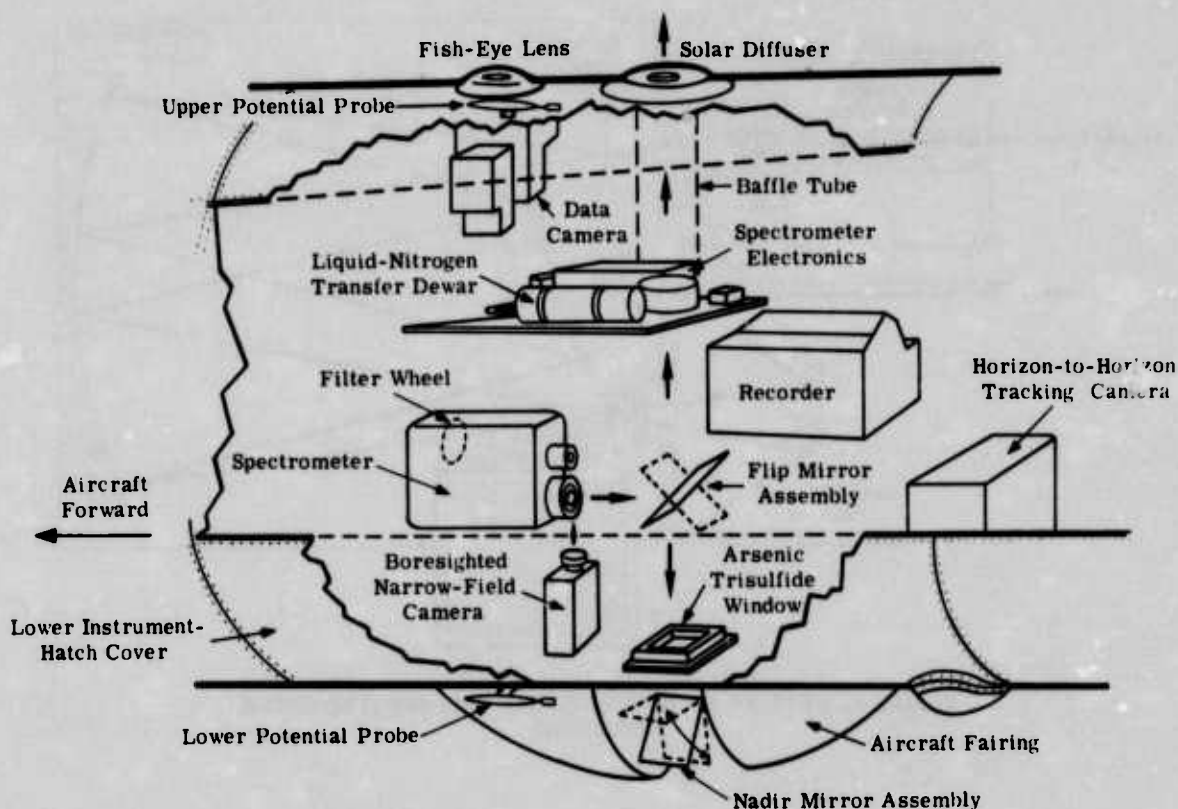

FIGURE 8. CONFIGURATION OF THE INSTRUMENT BAY OF THE AIRCRAFT
Unclassified

A diagram of the instrument configuration is given in figure 9.

The spectrometer was calibrated in wavelength by means of the high order spectra from a cw gas laser at a fundamental wavelength of 0.632μ . Several marker pulses were positioned throughout the spectral scan so that spectral calibration was maintained throughout each spectral scan. Amplitude calibration was carried out by the field-flooded method, using a blackbody of known temperature.

C. Spectral Information

The spectrometer scanned from 1.15 to 1.55μ or 1.75 to 2.90μ or 2.4 to 3.7μ , depending upon the slit used. Likewise, spectral resolution ranged from 0.01 to 0.1μ , depending on the slit used. The spectral scan rate ranged from 15 to $150 \text{ sec}/\mu$.

Spectral order isolation filters were used, resulting in the overall spectral response curves given in figure 10.

UNCLASSIFIED

UNCLASSIFIED

WILLOW RUN LABORATORIES

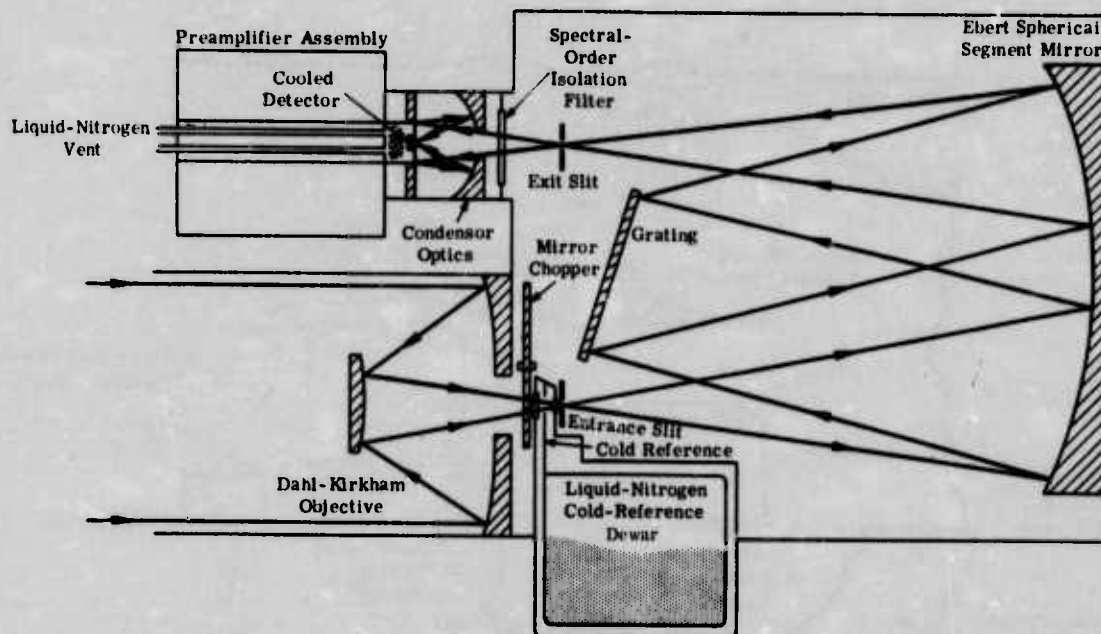

FIGURE 9. OPTICAL CONFIGURATION OF THE SPECTROMETER
Unclassified

D. Spatial Information

The spatial scan was in all cases provided by the forward motion of the aircraft. Two basic scanning modes were used. In the first mode, the optic axis of the spectrometer was directed straight downward (fixed at nadir), and the aircraft flew at an altitude of about 10 km over a variable flight path. In the second mode, the spectrometer looked out the side of the aircraft at a fixed 80° nadir angle and flew in a hexagonal path about the cloud deck of interest. The latter mode was used approximately one-third of the time. In both cases, the spectrometer looked upward from time to time to record the irradiance from the solar diffuser above. The flip mirror was placed in the solar-viewing position ten percent of the time.

The field of view of the spectrometer was 0.46° by 2.30° , 0.09° by 2.30° , or 0.46° by 1.38° , depending upon the slit used.

The geographic position of the aircraft was not satisfactorily monitored during the experimental work. Therefore, correlation of the aircraft coordinates with the

UNCLASSIFIED

UNCLASSIFIED

WILLOW RUN LABORATORIES

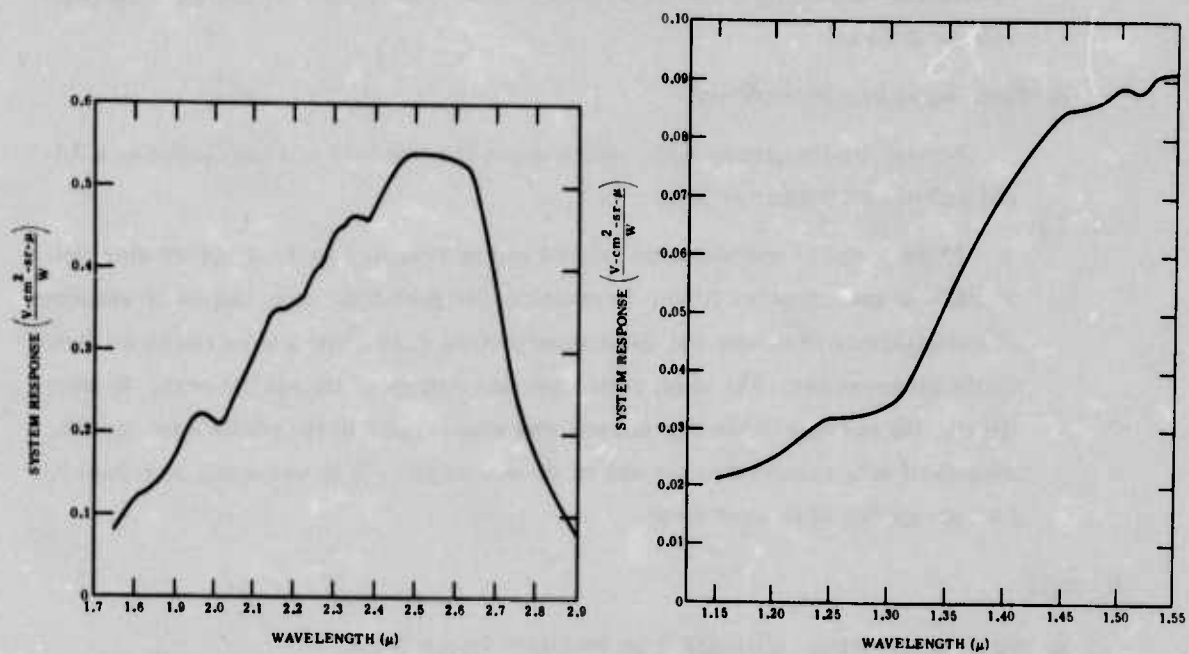

(a) Spectrometer Response Coefficient: 1.75 to 2.90 μ ; Filter 5, Grating 2 (1st order). (b) Spectrometer Response Coefficient: 1.15 to 1.55 μ ; Filter 4b, Grating 2 (2nd order).

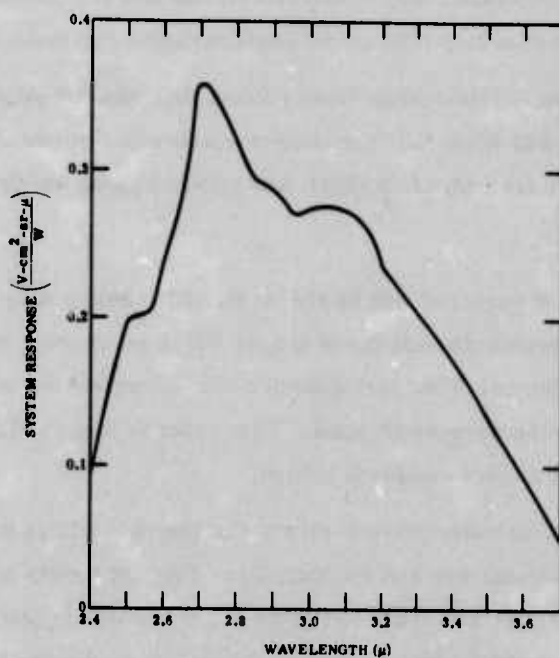

(c) Spectrometer Response Coefficient: 2.40 to 3.70 μ ; Filter 1, Grating 1 (2nd order).

FIGURE 10. OVERALL SPECTRAL RESPONSE CURVES. PbS detectors with narrow slits.
Unclassified

UNCLASSIFIED

UNCLASSIFIED

WILLOW RUN LABORATORIES

data had to be derived from the tracker-camera photographs by means of identifiable landmarks.

E. Data Recording Procedures

Except for the photographic information, the raw data were recorded on a 36-channel oscillographic recorder.

Many possible combinations existed among scanning mode, spectrometer slit width, and spectrometer filter. In practice, the particular combination or sequence of combinations of modes was determined before each flight and stored on an automatic programmer. The pilot, of course, had control of the spatial scan. In later flights, the position of the flip-mirror was also subject to the pilot's control. The amount of data recorded in any one mode was more or less uniformly distributed, i.e., all nodes were used some.

II. Data

A. Signal Processing: Correlation to Ancillary Parameters

In the final system configuration, the output from the spectrometer detector was amplified, synchronously demodulated, and filtered before being recorded. The output was then recorded on the oscillographic recorder.

Correlation of information from photographs and the pilot's log with the oscillographic data was achieved by a counter marker which was entered simultaneously into the camera frames, strip chart, and pilot's logging cards.

B. Data Analysis

The spectra were reduced by the A. D. Little workers by means of a semi-automatic electromechanical curve tracer which produced a regular analog curve of spectral radiance. This analog device also corrected for zero level shift and nonlinearity in the wavelength scale. This process was used in the preparation of the published data (see section D below).

In addition, an independent treatment of the raw data is presently taking place at the Institute of Science and Technology of The University of Michigan. Of the total flight data, the data from 15 flights (1400 suitable spectra) were found to be suitable for detailed analysis. These data have been digitized in their entirety for further analysis.

UNCLASSIFIED

UNCLASSIFIED

WILLOW RUN LABORATORIES

C. Data Format

As mentioned above, the spectra were first converted to analog curves of spectral radiance. The format for these was a regular photographic oscillograph-type strip chart.

The digitized data have been recorded on magnetic tape. The tapes are intended to be played back on an Amperex FR-100 FM instrumentation recorder at 3.75 in./sec. The tapes each carry 7 channels of data; from 8 to 11 spectra are recorded per track. There are 19 reels of tape with 1209 linear and 122 nonlinear spectra.

D. Data Published in Report

- (1) Graphs of averaged spectra for different types of clouds, with supplementary information to indicate the conditions under which the data were taken
- (2) Comparative graphs of the spectral profiles of various clouds and terrain
- (3) Graph of diffuse reflectance of various clouds and terrain
- (4) Graph of relative scattering vs. scattering angle at various wavelengths around 2.5μ .
- (5) Graph illustrating how various composite cloud backgrounds synthesize

Information recorded with the spectrometer data included time, radiance from directly below the aircraft, pitch, roll, and yaw of the aircraft, sun angle, potential gradient in the vicinity of aircraft, wide-angle photographic data, and photographs from the camera boresighted with the spectrometer (see references by Blau and by Blau and Espinola).

E. Error Statements

The overall experimental error in the radiance values has been estimated to be ± 25 percent.

REFERENCES Unclassified

- H. H. Blau et al., Infrared Spectral Properties of High-Altitude Clouds, Technical Report No. 2, Arthur D. Little, Inc., Cambridge, Mass., December 1963.
- H. H. Blau and R. P. Espinola, Infrared Spectral Properties of High Altitude Clouds, Arthur D. Little, Inc., Cambridge, Mass., June 1965.

UNCLASSIFIED

UNCLASSIFIED

WILLOW RUN LABORATORIES

E. C. Reifenstein III and H. H. Blau, Report of First Year's Accomplishment and Second-Year Program Under Contract Nonr-3556(00), Arthur D. Little, Inc., Cambridge, Mass., June 1962.

E. C. Reifenstein III, P. C. von Thuna, and H. H. Blau, Jr., Near Infrared Background Clutter and Atmospheric Transmission: Instrumentation, Report No. SSD-TDR-63-146, Arthur D. Little, Inc., Cambridge, Mass., May 1963.

3.6. (U) THERMAL RADIANCE PROPERTIES OF CLOUDS: F. R. VALOVICIN AND D. R. FITZGERALD

I. Instrument Description and Platform

A. General

Since 1962, workers at the Air Force Cambridge Research Laboratories (AFCRL) have flown a U-2 aircraft over various types of cloud structures to obtain simultaneous infrared and photographic data. The U-2 was instrumented to take photographs of clouds in the visible region and measure the effective temperature variation based upon radiometric measurements in the 8- to 13- μ region.

A moderate amount of data has been gathered over the period from 1962 through 1966. The data analysis has been directed chiefly toward the meteorological implications of the measurements.

B. Instrumentation

A Barnes infrared radiation thermometer, model 14-311, was used in conjunction with a 70-mm aerial camera.

The method of radiometer calibration was not discussed in the reference.

C. Spectral Information

The spectral passband of the radiometer was governed by filters passing radiation between 7.5 and 13.5 μ .

The camera was sensitive in the visible region.

D. Spatial Information

The radiometer's field of view was approximately 2° by 2° , resulting in a subtended cloud patch of 35 ft by 35 ft at a range of 1,000 ft.

The field of view of the camera was 42° by 180° , the longer dimension being perpendicular to the direction of flight.

Scanning motion for the instruments has not been discussed but is assumed to have been provided only by the forward motion of the aircraft.

UNCLASSIFIED

UNCLASSIFIED

WILLOW RUN LABORATORIES

E. Data Recording Procedure

The data recording procedure has not been discussed in detail and appears to have varied with the type of synoptic situation being studied. The data rate in one instance was 1 data point every 15 sec.

In some instances, actual cloud-top and base altitudes were measured by flying through clouds making detailed observations.

II. Data

A. Reduction and Analysis

The radiometric data were analyzed to provide effective blackbody temperatures. Correlation of temperature values with cloud type and altitude was, in general, satisfactorily achieved.

B. Prepared Data

Summary data appear in the paper presented at the Third Symposium on Remote Sensing of Environment. Composite photographs with radiance profile or mean temperature are presented for several cloud structures; also included are:

- (1) Frequency distribution of cloud-top temperatures taken during five flights (table, p. 164)
- (2) Temperature structure in and over cirrus clouds (graphs, pp. 170-172)

C. Error Statements

A nominal precision of $\pm 3^{\circ}\text{C}$ has been attributed to the measurements, corresponding to a 5-percent error in emissivity calculations.

REFERENCES Unclassified

L. W. Chaney, "Earth Radiation Measurements by Interferometer from a High Altitude Balloon," Proceedings of the Third Symposium on Remote Sensing of Environment, Report No. 4864-9-X, Institute of Science and Technology, The University of Michigan, Ann Arbor, February 1965.

D. R. Fitzgerald and F. R. Valovcin, "High Altitude Observations of the Development of a Tornado Producing Thunderstorm," presented at the Conference on Physics and Dynamics of Clouds, Chicago, Ill., March 1964.

Instruction Manual for Model 14-310, Portable Radiation Thermometer, Barnes Engineering Co., Stanford, Conn., 1961.

TIROS III Radiation Data Users' Manual, Goddard Space Flight Center, Greenbelt, Md., August 1962.

UNCLASSIFIED

UNCLASSIFIED

WILLOW RUN LABORATORIES

3.7. (U) A SPECTRAL RADIANCE STUDY OF TERRAIN AND CLOUDS: EMERSON ELECTRIC

I. Instrument Description and Platform

A. General

Emerson Electric Manufacturing Company has conducted a series of airborne radiometric measurements in which the radiance structure of a wide variety of terrain and cloud backgrounds was observed from moderate altitudes by a down-looking radiometer. The radiometer employed a rotating color wheel which governed the system's spectral response in eight regions ranging from 0.35μ to 2.6μ . The platform for the measurements was a B-25 aircraft; the altitude of measurement varied between 1,000 and 20,000 ft. The measurements were made in 1961 and 1962. (See figure 11.)

The data evolved from this program may be characterized as visible and near-infrared radiance data indicating the gross statistical structure of radiance over the continental United States. In comparison with the results of similar works, these data are perhaps most notable for the statistical methods applied in their preparation.

B. Instrumentation

The radiometer used a temperature-controlled PbS detector and a filter wheel containing eight filters. Incoming radiation was chopped at 225 Hz. A 70-mm P-2 camera and a 16-mm gun camera were boresighted with the radiometer and generally were triggered once for each revolution of the filter wheel. The procedure used in calibrating the radiometer was not known at the time of this writing.

C. Spectral Information

Seven narrowband filters had responses centered at 0.35, 0.45, 0.58, 0.65, 0.80, 1.02, and 1.62μ . The eighth filter had a response of 2.0 to 2.6μ . Exact filter transmission curves are given in figure 12.

D. Spatial Information

The radiometer looked straight down with a circular field of view of 6.9° . At an altitude of 15,000 ft, this gave a ground patch of approximately 0.07 sq nmi.

E. Data Recording Procedures

Radiometer output was printed on paper tape in digital form. The filter wheel could rotate at either 3.5 or 7 rpm, so that the maximum sample rate was 7 per

UNCLASSIFIED

WILLOW RUN LABORATORIES

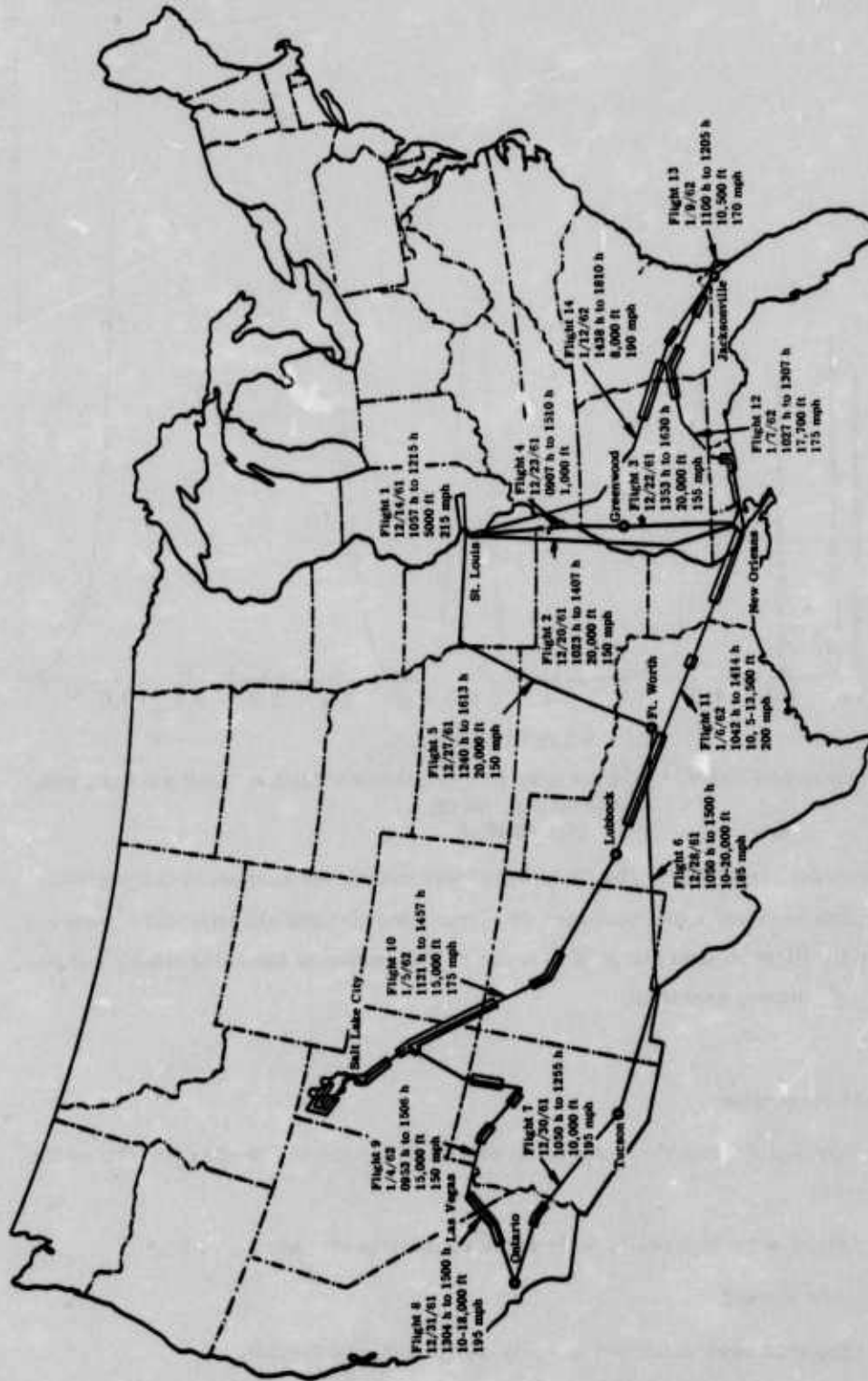

FIGURE 11. ROUTE OVER WHICH MEASUREMENTS OF RADIANCE WERE MADE FROM THE AIR
Unclassified

UNCLASSIFIED

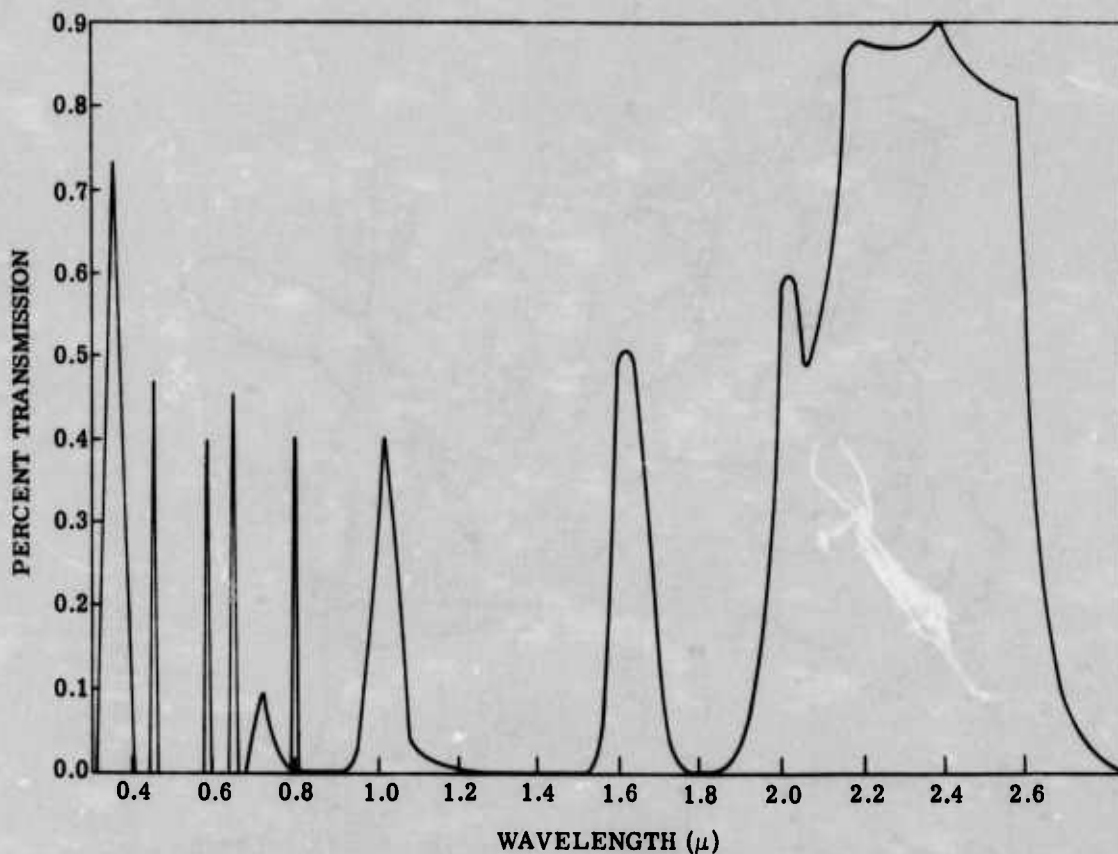

FIGURE 12. TRANSMISSION CURVES FOR FILTERS IN THE FILTER WHEEL OF THE RADIOMETER.
Emerson Electric Co.
Unclassified

minute for each filter. The filter wheel was sometimes stopped in one position, and data were recorded continuously. Some, and perhaps all, data were recorded with the flight number, time of day, mode of operation of the filter wheel, and photograph number specified.

II. Data

A. Signal Processing

The signal from the radiometer was amplified and fed to the recorder on the aircraft.

There were apparently no in-flight calibration checks.

B. Raw-Data Format

The data were recorded digitally on a paper-tape format.

UNCLASSIFIED

WILLOW RUN LABORATORIES

C. Data Analysis: Prepared Data

The analysis performed by the Emerson workers was directed chiefly toward the distribution of radiance values. Also, the spectral emissivities of various types of terrain were computed.

The following prepared data appear in the Emerson report:

- (1) "Spectral Radiance Distribution" (number of data points per radiance increment) for each filter for each of seven types of terrain (bar graphs, pp. 13-148)
- (2) "Spectral Radiance Comparison" of various types of terrain (pp. 157-167)

REFERENCE Unclassified

H. D. Nelgner and J. R. Thompson, Airborne Spectral Radiance Measurements of Terrain and Clouds, Report No. 1323, Emerson Electric Manufacturing Co., St. Louis, April 1962.

3.8. (U) THE AEROSPACE INFRARED FOUR-COLOR EXPERIMENT

I. Instrument Description and Platform

A. General

The platform was an Agena vehicle. The satellite was launched on 14 December 1962. The apogee was 344 km, the perigee was 174 km, and the inclination of the orbit was 71° .

The satellite carried a four-channel radiometer which measured radiance in the 1.4-, 1.8-, 2.2-, and 2.7- μ regions simultaneously. The resultant data were therefore amenable to joint radiance analyses between selected channel pairs. Approximately 10^5 radiance values per channel were produced by the experiment.

B. Instrumentation

The radiometer used four uncooled PbS detectors. Narrowband interference filters were cemented to the detectors to obtain the spectral regions of interest. The incident radiation, which was chopped at 600 Hz, was focused on the detectors by an aspherical silicon lens.

UNCLASSIFIED

C. Spectral Information

Radiation intensity was measured in four narrow bands centered at 1.4, 1.8, 2.2, and 2.7 μ .

D. Spatial Information

The satellite was stabilized so that the detectors always looked at the nadir. The field of view for each detector was 2.5 by 25 mrad, which gave a ground patch of 0.8 by 8 km when the satellite was at a 320-km altitude. Detector configuration and scan direction are given in figure 13. The satellite speed was approximately 4 mi/sec, so that less than a second elapsed between the time the first and last detectors saw the same ground patch.

E. Data Recording Procedures

Data were collected by telemetry. In view of the size of the ground patch and the satellite's velocity, eight samples were measured per second per channel. Data were recorded in the form of plots of voltage vs. time that could be calibrated directly in terms of radiance.

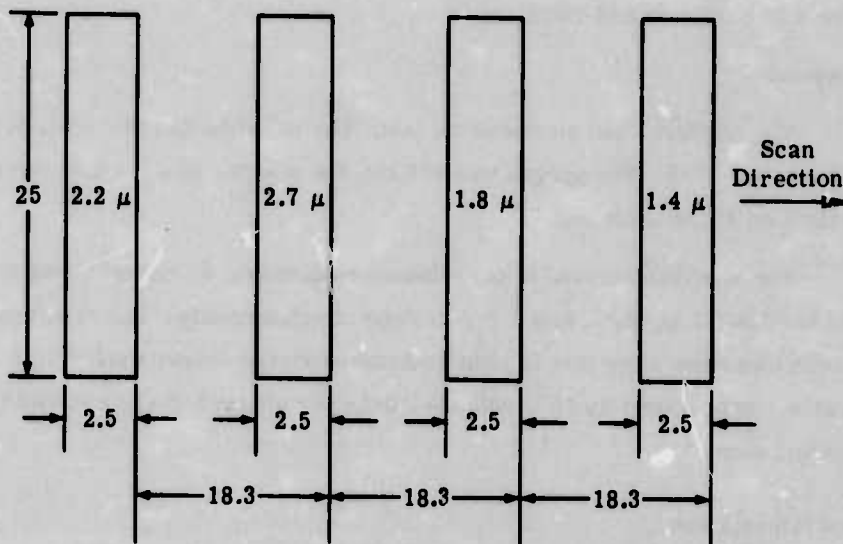

FIGURE 13. CONFIGURATIONS OF DETECTORS USED IN THE FOUR-COLOR EXPERIMENT. All dimensions in milliradians.

Unclassified

UNCLASSIFIED

WILLOW RUN LABORATORIES

II. Data

A. Data Reduction and Analysis

The Aerospace workers reduced and analyzed the data. A discussion of the philosophy of the several types of analyses is given in the referenced report by H. W. Wessely.

B. Prepared Data

In the referenced report by Friedman a table is presented that gives background radiance as a function of longitude and latitude. Samples of the records of voltage vs. time obtained at one of the tracking stations are also given. Graphs show correlation between two spectral bands and correlation of radiance with sun angle. Graphs are presented of the cumulative radiance and radiance-difference probability distributions in each of the spectral regions. One graph presents the cumulative radiance probability as a function of insolation angle. In each spectral region, the radiance vs. insolation angle and the root-mean-square radiance vs. mean radiance as a function of insolation angle are plotted. A comparison is made between calculated and observed mean radiance in the 2.7- μ region. Spectral joint-amplitude distribution plots are given for the 2.7- vs. 1.8- μ and 2.7- vs. 2.2- μ spectral regions.

Good data were received only during the daylight hours. About 150,000 data points per channel were received during portions of 10 of the first 14 orbits. Some information on cloud cover was collected by a TIROS satellite.

C. Experimental Error

Data obtained in the 1.8-, 2.2-, and 2.7- μ spectral regions are probably accurate to within 10 percent. Because of a light leak in the 1.4- μ filter, the data for this channel may be in error by as much as a factor of 3.

A second similar experiment was performed at a later date. Direct inquiries can be made to Dr. R. Douglas Rawcliffe, Aerospace Corporation, El Segundo, California.

REFERENCES Unclassified

R. M. Friedman, Satellite Measurements of the Near Infrared Background Radiations from the Earth, Report No. TDR-69(2260-52), TN-1, Aerospace Corporation, El Segundo, California, September 1962.

UNCLASSIFIED

UNCLASSIFIED

WILLOW RUN LABORATORIES

R. D. Rawcliffe, G. E. Meloy, and R. L. Williams, Satellite Infrared Background Experiment (U), Report No. TDR-169(3260-52), TN-1, Aerospace Corporation, El Segundo, California, July 1963 (CONFIDENTIAL).

H. W. Wessely, Satellite Infrared Background Experiment Data Analysis (U), Report No. TDR-269(4710-29)-1, Aerospace Corporation, El Segundo, California, June 1964 (CONFIDENTIAL).

3.9. (U) THE AEROSPACE ULTRAVIOLET EXPERIMENT

I. Instrument Description and Platform

A. General

Under the sponsorship of the air force, two satellites were launched carrying ultraviolet-radiation experiments prepared by the Space Physics Laboratory of Aerospace Corporation. The first was launched on 15 May 1962 into a polar orbit with an apogee of 650 km and a perigee of 298 km. The second was launched in late July 1962 at an inclination of 70.3° with a perigee of 205 km and an apogee of 393 km.

B. Instrumentation: Calibration

A dual ultraviolet radiometer was used. The radiometer channel was composed of a simple objective lens, a triple-section filter, and a fourteen-stage photomultiplier with a CeTe photocathode. The albedo channel was composed of a unidirectional blackened sensor followed by a quartz light pipe followed by a similar photomultiplier detector.

The radiometer was calibrated using a National Bureau of Standards tungsten source. In-flight calibration was maintained by means of a built-in calibration lamp. The calibration techniques used were not described.

C. Spectral Information

Because the experiment was planned around the Hartley absorption band of ozone, the filters were designed to give a peak transmission near 2550 Å. Spectral transmission curves are given in figure 14.

D. Spatial Information

In orbit, the satellite was stabilized to the nadir. The radiometer looked to the nadir at all times with a circular 10-mrad field of view; this gave a ground patch 2 mi in diameter at a satellite altitude of 200 mi. The albedo channel accepted backscattered solar radiation from a wide field of view below the satellite.

UNCLASSIFIED

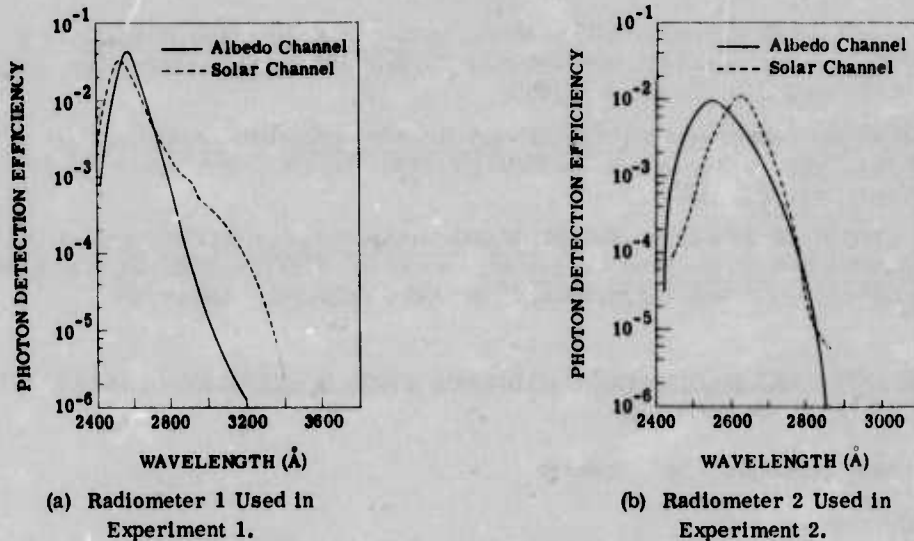

FIGURE 14. SPECTRAL RESPONSES OF AEROSPACE ULTRAVIOLET RADIOMETERS
Unclassified

E. Data Acquisition

Data were stored on analog tape aboard the satellite and then telemetered to tracking stations. During readout, real-time data were also obtained. The radiometer channel was sampled 3 times per second, and the albedo channel was sampled 12 times per second.

II. Data

A. Raw Data

Data were obtained from only six orbits; the rest were degraded because of telemetry noise.

B. Prepared Data

The report dated 26 July 1963 gives $2 \times 10^{-5} \text{ W/cm}^2\text{-sr-}\mu$ for the value of the scattered solar irradiance as observed by the nadir radiometer. The sun angle for this measurement was 49° .

C. Experimental Error

Noise degradation led to an uncertainty of ± 15 percent in the radiance values.

UNCLASSIFIED

WILLOW RUN LABORATORIES

REFERENCES

Unclassified

R. M. Friedman, R. D. Rawcliffe, and G. E. Meloy, Radiance of the Upper Atmosphere in the Middle Ultraviolet, Report No. TDR-169(3260-50), TN-4, Space Physics Laboratory, Aerospace Corporation, El Segundo, California, July 1963.

E. B. Mayfield et al., Experiment and Preliminary Results of Satellite Determinations of the Albedo in the Near Ultraviolet, Report No. TDR-169(3260-50), TN-2, Aerospace Corporation, El Segundo, California, May 1963.

E. B. Mayfield and R. M. Friedman, Satellite Measurement Program to Determine Ozone Concentration and Albedo in the Near Ultraviolet, Report No. TDR-169(2260-50), TN-2, Space Physics Laboratory, Aerospace Corporation, El Segundo, California, August 1962.

3.10. (U) THE SPECTRAL BACKGROUND RADIANCE FROM A DISCOVERER SATELLITE: L. C. BLOCK AND OTHERS

I. Instrument Description and Platform

A. General

The platform was an air force satellite launched on 17 September 1962. It obtained useful data for approximately one week.

B. Instrumentation

The instrument was a Block Associates 16-T interferometer spectrometer that utilized a bolometer detector. A thermistor monitored the bolometer's temperature. The interferometer's output was the differential radiance between the target and the detector.

C. Spectral Information

The interferometer spectrometer was sensitive in the region between 1.8μ and 15μ with a spectral resolution of 0.4μ at 10μ , but data were reduced only in the region between 6 and 15μ . The instrument completed one interferogram per second.

D. Spatial Information

The 15° circular field of view always looked in the direction of the nadir. At a satellite altitude of 200 mi, this produced a ground patch 50 mi in diameter. The satellite progressed at 8 km/sec along the orbital path.

E. Data Recording Procedures

Data were obtained by telemetry only in real time when the telemetry output was within receiving distance of one of the tracking stations. The output of the

UNCLASSIFIED

WILLOW RUN LABORATORIES

interferometer, the thermistor output, and real-time values were recorded by telemetry.

II. Data

A. Prepared Data

Several 6- to 15- μ spectral radiance curves (microns-watts-centimeters⁻²-steradians⁻¹-microns⁻¹) that were determined from data obtained over the United States and Canada are given in the references. The time (from which the location can be inferred) of each spectral measurement is given; the meteorological conditions reported at the time of these measurements are also given. The conditions given are temperature, relative humidity, pressure, and ozone density. Time histories of radiance observed at several discrete wavelengths are also given.

Several spectrograms of differential radiance are given, but these are of limited usefulness because no calibration corrections have been made. Several graphs of differential radiance at one wavelength vs. time are also given, but, again, no calibration corrections have been made.

No other data from this flight have been analyzed. The telemetry records still exist, and a low-priority effort is being made to reduce more of the data.

B. Experimental Error

Because of limitations on the interferometer's in-flight controls and calibrations, an upper limit on errors in absolute radiance was set at 50 percent with the larger errors occurring toward the shorter wavelengths.

REFERENCES

Unclassified

L. C. Block and J. J. Lovett, "Infrared Background Spectral Radiation Measurements From On Board a Discoverer Satellite (UNCLASSIFIED paper)," Proc. IRIS, Vol. 8, No. 1, January 1963, (SECRET), pp. 95-104.

L. C. Block and A. S. Zachor, "Inflight Satellite Measurements of Infrared Spectral Radiance of the Earth," Appl. Opt., Vol. 3, No. 2, February 1964, pp. 209-214.

UNCLASSIFIED

UNCLASSIFIED

WILLOW RUN LABORATORIES

3.11. (U) THE TIROS WEATHER SATELLITES

I. Instrument Description and Platform

A. General

The satellites TIROS I to VIII were launched as shown in table II. Each satellite was spin-stabilized with a spin rate of about 10 rpm.

TABLE II. FLIGHTS OF TIROS SATELLITES
Unclassified

<u>Designation</u>	<u>Date</u>	<u>Apogee (mi)</u>	<u>Perigee (mi)</u>	<u>Inclination (degrees)</u>
I	1 April 60	468	430	48.3
II	23 November 60	452	387	48.5
III	12 July 61	506	461	47.8
IV	8 February 62	525	441	48.3
V	19 June 62	604	367	58.1
VI	18 September 62	444	423	58.2
VII	19 June 63	401	388	58.2
VIII	21 December 63	463	440	58.5

B. Instrumentation

All TIROS satellites contained cameras with optical axes parallel to the spin axis of the satellite. Vidicon systems were used. A wide-angle camera was carried on all TIROS satellites, a narrow-angle camera was carried on TIROS I and II, and a medium-angle camera was carried on TIROS V to VIII.

Infrared-radiation sensors were carried aboard TIROS II to IV. All three of these satellites carried a five-channel scanning radiometer. This scanning radiometer had its optical axis oriented at an angle of 45° with respect to the satellite's spin axis. An optical chopper switched the optical axis of the radiometer back and forth between two diametrically opposed directions so that radiation from the earth was measured by using space as a zero reference. Each of these three satellites also carried a non-scanning radiometer. TIROS II and IV also carried radiation sensors of the type used on Explorer VII. These consisted of hemispheres with a field of view limited only by the horizon of the earth as seen from the satellite.

UNCLASSIFIED

WILLOW RUN LABORATORIES

C. Spectral Information

All the camera systems had a peak spectral sensitivity in the 0.7- to 0.9- μ range.

The 5-channel radiometer measured radiation in the spectral bands 0.55 to 0.75 μ , 0.2 to 6 μ , 8 to 12 μ , and 8 to 30 μ . Spectral response curves for these channels are shown in figure 15.

The low-resolution radiometer contained two detectors. The black detector responded to radiation in the region from the visible to the far infrared, and the white detector responded to wavelengths greater than 3 μ . The third radiometer had both a black detector and a white detector, with the short wavelength cutoff of the white detector being about 4 μ .

D. Spatial Information

The spatial parameters of the camera systems are shown in table III.

The 5-channel radiometer had a field of view of 5°. The scan pattern is quite complicated because of the satellite spin, the orbital advance, and the constantly changing angle between the spin axis and the nadir.

The low-resolution radiometer had a 50° field of view with its optical axis parallel to the spin axis. The third radiometer had a field of view limited only by the earth's horizon as seen by the satellite.

E. Data Recording Procedures

Data were either telemetered to ground tracking stations in real time or analog taped and telemetered upon command. The picture data transmitted from the satellite are simultaneously recorded on magnetic tape and displayed on a kinescope. Each picture on the kinescope is photographed. Radiometer data are recorded on analog tape.

II. Data

A. Raw-Data Format: Reduced Data

(1) Photographic

All of the usable picture sequences transmitted by the TIROS satellites are being stored on 100-ft reels of 35-mm microfilm. Copies of these can be purchased from the National Weather Records Center, Asheville, North

UNCLASSIFIED

WILLOW RUN LABORATORIES

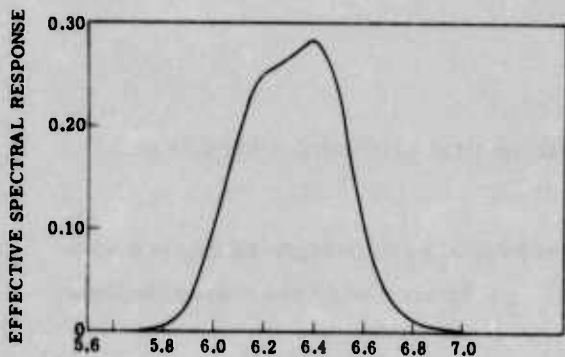

(a) Channel 1

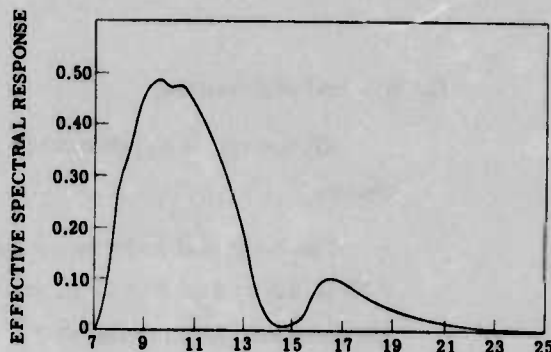

(b) Channel 2

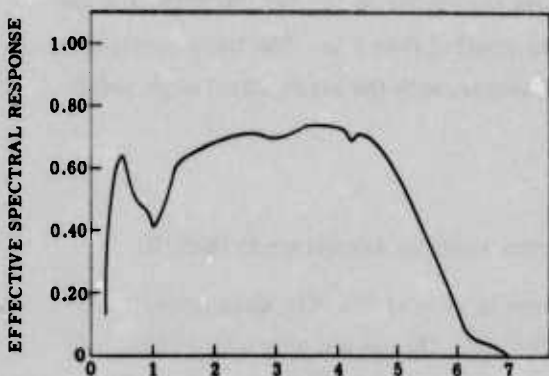

(c) Channel 3

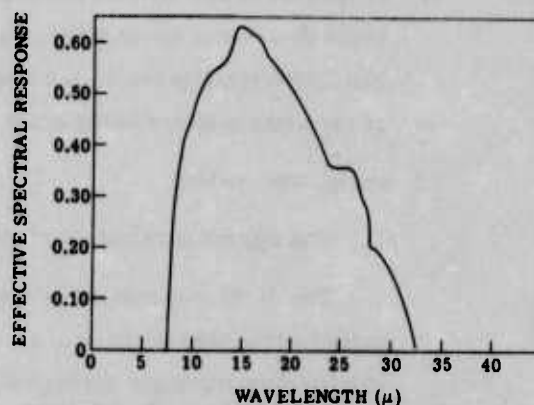

(d) Channel 4. Does not include constant value over 7- to 35-μ region of RRS-5 lens.

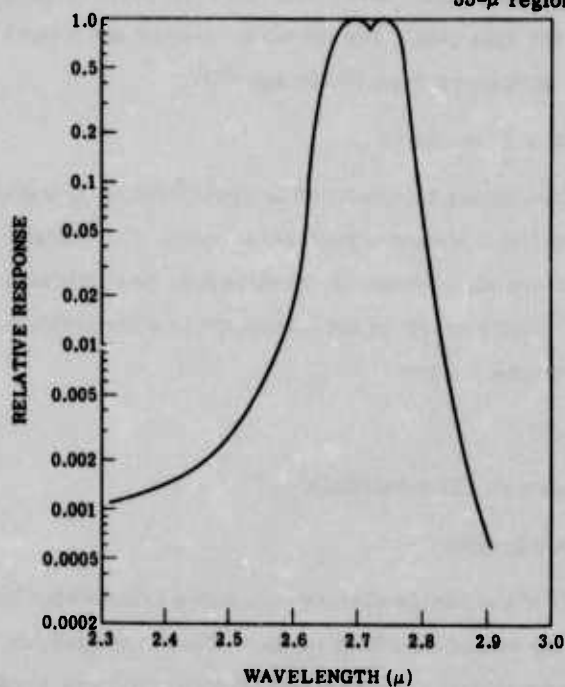

(e) Channel 5

FIGURE 15. EFFECTIVE SPECTRAL RESPONSES OF TIROS RADIOMETER CHANNELS VS. WAVELENGTH

Unclassified

UNCLASSIFIED

WILLOW RUN LABORATORIES

TABLE III. SPATIAL PARAMETERS OF
THE TIROS CAMERA SYSTEMS

<u>Camera</u>	Unclassified	
	<u>Field of View (degrees)</u>	<u>Resolution (km)</u>
Wide angle	104	2.5-3
Medium angle	80	2
Narrow angle	12.7	0.3-0.8

Carolina. The pictures can be identified by orbit pass number and frame number. Listings and maps show the geographical areas covered by each orbit. Each TIROS has returned a large number of pictures; e.g., TIROS I returned nearly 3000 pictures. Pictures could be taken only in the daytime.

(2) Infrared

A large amount of radiation data has been obtained from the TIROS satellites. Infrared data from the five-channel medium-resolution radiometer have been processed to produce a final-meteorological-radiation (FMR) tape for each TIROS satellite. This binary tape for use on a computer locates each radiation datum point by latitude, longitude, nadir angle, azimuth angle, and time. The radiation intensity is given in terms of watts per square meter. These FMR tapes may be obtained from the National Weather Records Center.

B. Prepared Data

(1) Photographic

Large numbers of photographs have been published in the references cited. Among other things, these photographs have been compared with more conventional observations of terrain features, ice cover, and cloud cover. The vidicon system was designed to give information on cloud cover and does this very well.

(2) Infrared

Data from the five-channel radiometer usually appear as radiation maps which give either radiant emittance (watts per square meter) or an equivalent blackbody temperature. This is the blackbody temperature that would produce the same radiometer response as the scene being viewed. In several reports, this data is compared with conventional meteorological data.

UNCLASSIFIED

UNCLASSIFIED

WILLOW RUN LABORATORIES

C. Experimental Error

(1) Photographic

There is generally good contrast between clouds and the earth's surface. The brightest and darkest objects exceeded the dynamic range of the system and appear as either white or black, respectively; however, the intensity of most objects was such that they appear as gray.

(2) Infrared

Response degradation in all channels of the five-channel radiometer began shortly after launch on all TIROS satellites that carried this radiometer. However, approximate corrections have been computed and can be applied to the data to correct for this degradation.

REFERENCES

Unclassified

- W. R. Bandeen, Tiros II Radiation Data Users' Manual, Goddard Space Flight Center, Greenbelt, Md., May 1961.
- W. R. Bandeen, R. E. Samuelson, and I. Strange, Tiros III Radiation Data Users' Manual Supplement, Goddard Space Flight Center, Greenbelt, Md., December 1963.
- Catalogue of Meteorological Satellite Data - Tiros I Television Cloud Photography, U. S. Department of Commerce, Weather Bureau, Washington, D. C., 1961.
- J. F. Davis, R. A. Hanel, R. A. Stampfl, M. G. Strange, and M. R. Townsend, Telemetering Infrared Data From the Tiros Meteorological Satellites, Technical Note D-1293, Goddard Space Flight Center, Greenbelt, Md., August 1962.
- R. C. Doolittle, Calibration of Image Distortion in Tiros Wide Angle Photography, Report No. 15, Meteorological Satellite Laboratory, U. S. Department of Commerce, Weather Bureau, Washington, D. C., July 1963.
- T. Fujita, A Technique for Precise Analysis for Satellite Data; Volume I - Photogrammetry, Report No. 14, Meteorological Satellite Laboratory, U. S. Department of Commerce, Weather Bureau, Washington, D. C., January 1963.
- R. A. Hanel and D. Q. Wark, "Tiros II Radiation Experiment and Its Physical Significance," J. Opt. Soc. Am., Vol. 51, No. 12, December 1961.
- R. L. Pyle, Documentation for Tiros IV Television Data, Report No. 16, Meteorological Satellite Laboratory, U. S. Department of Commerce, Weather Bureau, Washington, D. C., May 1963.
- Reduction and Use of Data Obtained by Tiros Meteorological Satellites, Technical Note No. 49, World Meteorological Organization, 1963.
- W. G. Stroud, Final Report on the Tiros I Meteorological Satellite System, Goddard Space Flight Center, Greenbelt, Md., 1962.
- The Availability of Radiation Data From the Tiros II, III, IV, and VII Meteorological Satellites, NASA-TM-X-54741, Goddard Space Flight Center, Greenbelt, Md., 1963.

UNCLASSIFIED

WILLOW RUN LABORATORIES

Tiros IV Radiation Data Catalog and Users' Manual, Goddard Space Flight Center, Greenbelt, Md., December 1963.

Tiros II Radiation Data Catalog, Goddard Space Flight Center, Greenbelt, Md., August 1961.

Tiros III Radiation Data Catalog, Goddard Space Flight Center, Greenbelt, Md., December 1962.

Tiros VII Radiation Data Catalog and Users' Manual, Vol. 2, Goddard Space Flight Center, Greenbelt, Md., December 1964.

W. Viezee and P. A. Davis, Analysis and Interpretation of Daytime Radiation Data From Tiros III, Orbit 4, AFCRL-64-34, Stanford Research Institute, Menlo Park, Calif., January 1964.

W. Viezee and P. A. Davis, Preliminary Examination of Daytime Radiation Data From Tiros III Over Cloudy Regions, AFCRL-63-860, Stanford Research Institute, Menlo Park, Calif., August 1963.

D. Q. Wark, Application to Radiation Processes in the Atmosphere, U. S. Weather Bureau, Washington, D. C., 1960.

D. Q. Wark, G. Yamamoto, and J. Lienesch, Infrared Flux and Surface Temperature Determinations from Tiros Radiometer Measurements, Report No. 10, U. S. Department of Commerce, Weather Bureau, Washington, D. C., August 1962.

D. Q. Wark, G. Yamamoto, and J. H. Lienesch, "Methods of Estimating Infrared Flux and Surface Temperature from Meteorological Satellites," J. Atmos. Sci., Vol. 19, September 1962.

R. Wexler, "Infrared and Visual Radiation Measurements from Tiros III," Appl. Opt., Vol. 3, No. 2, February 1964.

R. Wexler, Interpretation of Tiros II Radiation Measurements, Report No. AFCRL-6-638, Allied Research Associates, Inc., Boston, Mass., April 1961.

J. S. Winston and R. P. Rao, "Temporal and Spatial Variations in the Planetary-Scale Outgoing Long-Wave Radiation as Derived from Tiros II Measurements," Monthly Weather Rev., Vol. 91, October-December 1963, pp. 641-657.

3.12. (U) NIMBUS I

I. Instrument Description and Platform

A. General

Nimbus I is a meteorological satellite, the first in the series of second-generation meteorological satellites launched under the supervision of the National Aeronautics and Space Administration (NASA). The Nimbus program may be thought of as an outgrowth of the well known TIROS program which provided the world's first effective meteorological data from satellites.

Nimbus I was instrumented to provide detailed descriptions of cloud cover and terrain both day and night on a global basis.

The satellite was launched into orbit on 28 August 1964 at 08:52:00 universal time. It failed to achieve the desired orbit height of 575 mi, but assumed an ellip-

UNCLASSIFIED

tical orbit with a 578-mi apogee and a 252 mi perigee. The satellite returned usable data for 26 days; after that the power failed.

B. Instrumentation (cf. referenced report by Stampfl and fig. 16)

Three major radiation-sensing systems were used; an advanced vidicon-camera system (AVCS), an automatic picture-transmission system (APT), and a high-resolution-infrared-radiometer system (HRIR) (cf. referenced NASA Facts).

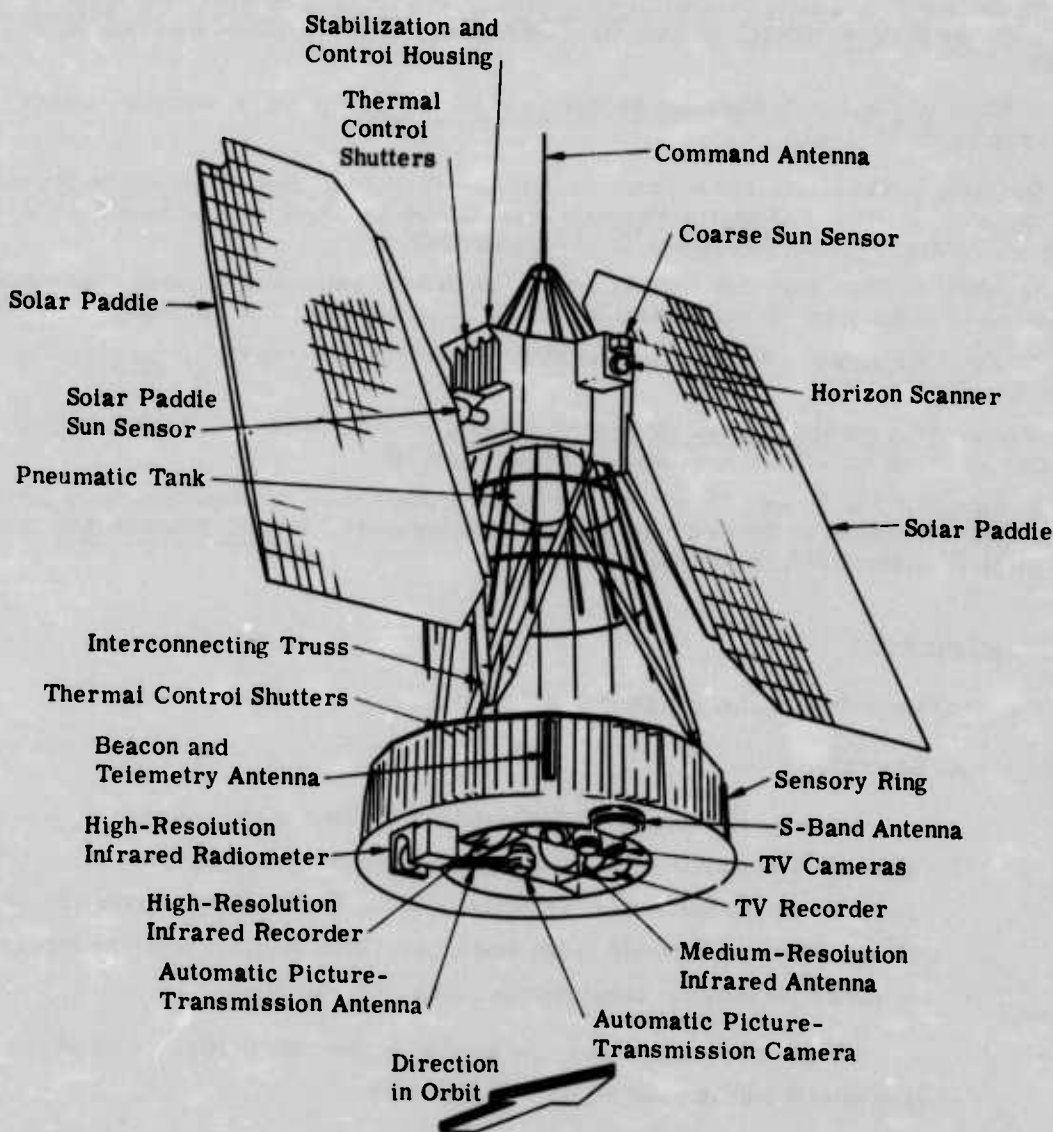

FIGURE 16. THE NIMBUS I SPACECRAFT. Press and Michaels, 1963.
Unclassified

UNCLASSIFIED

WILLOW RUN LABORATORIES

The vidicon-camera system consisted of three vidicon cameras with 17-mm lenses, a 4-track tape recorder, and an S-band transmitter. The cameras employed vidicons having 800 scan lines per inch. The pictures from the AVCS were stored on magnetic tape and played back on command.

The automatic picture-transmission system was similar to the AVCS system but employed a single high-retention camera-recorder unit which was able to hold single images for 200 sec. During this time, the image was slowly read and transmitted back to earth. Here a 5.7-mm $f/1.8$ Tegea kinoptic wide-angle lens provided wide coverage for the single camera. This was also an 800-scan-line system. Also included in the APT module were an electromechanical shutter mechanism, switching circuitry, and an FM transmitter at 136.5 Mc.

The HRIR system aboard Nimbus I was an improved infrared radiometer system capable of transmitting high-resolution infrared photographs in facsimile form. The radiometer employed the 4-in. Cassegrainian optical system illustrated in figure 17. The detector was PbSe, cooled and stabilized to -74°C , by a totally passive radiation-cooled apparatus. Auxiliary equipment for the HRIR included an FM modulator and tape recorder. As with the AVCS system, the HRIR images were first recorded and then transmitted back to earth on command over the S-band telemeter.

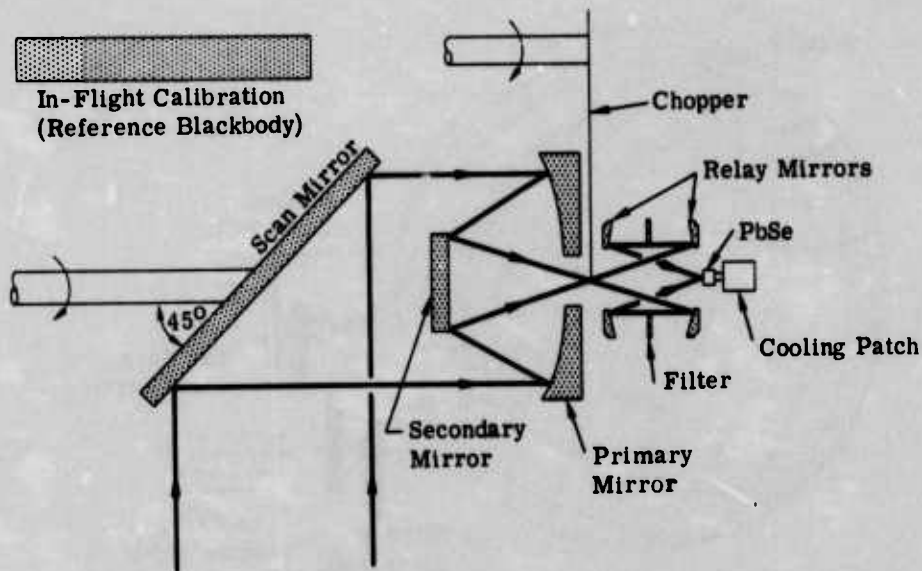

FIGURE 17. SCHEMATIC OF THE OPTICAL SYSTEM OF THE NIMBUS I HRIR. Goldberg, 1962.
Unclassified

Although planned at certain stages of development, system redundancy could not be used on Nimbus I. A MRIR (similar to the TIROS MRIR) was also planned for Nimbus I but left off because of restrictions on the weight of the payload.

C. Spectral Information

The AVCS and APT systems were both sensitive in the visible range. The exact spectral-response characteristics of these systems have not been given, however.

The HRIR was sensitive in the 3.5- to 4.1- μ window region. The exact response characteristics were not given.

D. Spatial Information (cf. referenced report by Goldberg)

The spatial scan patterns are best explained by the diagrams (figs. 18 and 19).

The AVCS cameras, covered an area of the earth that measured 420 by 1575 nmi and was oriented as shown in figure 18. The vidicons registered an image every 91 sec, resulting in a 5-percent overlap between successive frames. The field of view of each camera was 37°; the spatial resolution was about 0.5 mi at the surface of the earth directly below the satellite.

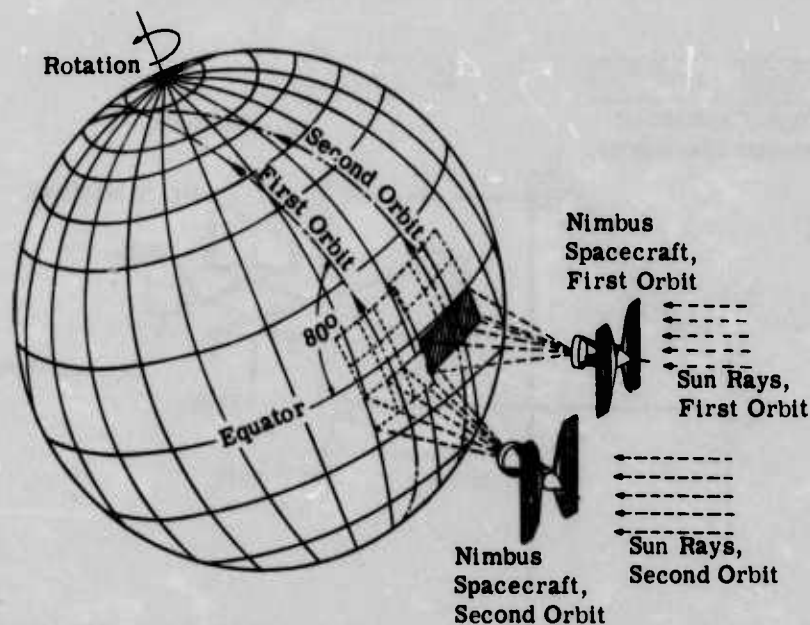

FIGURE 18. NIMBUS I AVCS AND APT TELEVISION COVERAGE.
Press and Michaels, 1963.
Unclassified

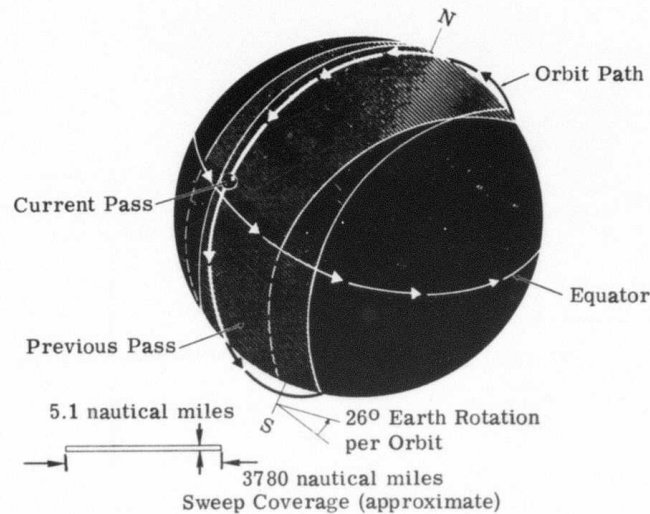

FIGURE 19. SCAN PATTERN OF THE NIMBUS I HRIR SYSTEM. Nimbus Weather Satellite Scheduled for Launch, 1964.
Unclassified

The APT camera (fig. 18) looked straight down and provided roughly the same coverage as the three AVCS cameras because of its wide angle lens. The field of view was 108° . The APT system was also an 800-scan line system and, therefore, at nadir, provided the same 0.5-mi resolution as the AVCS cameras at nadir.

The HRIR spatial scan was a raster scan achieved by means of a rotating plane mirror at the aperture (see figs. 16, 17, and 19). Raster advance was produced by the motion of the satellite along its path. The field of view was approximately conical with an 8.5-mrad apex angle, corresponding at nadir to a resolution element of about 4 mi at the earth's surface. The period of scan was 1.33 sec, corresponding to the generation of 2408 lines for each pass over the dark side of the earth.

E. Data Recording Procedure (cf. referenced reports, Phase II Nimbus Data-Handling System, and Nimbus Weather Satellite Scheduled for Launch)

The center for all Nimbus communication activity is the Nimbus Technical Control Center of Goddard Space Flight Center. The basic concept of the data

UNCLASSIFIED

WILLOW RUN LABORATORIES

acquisition complex is best illustrated by figure 20. While the data-acquisition system has been described as the Nimbus program data acquisition system, it will be described here with particular reference to the Nimbus I vehicle.

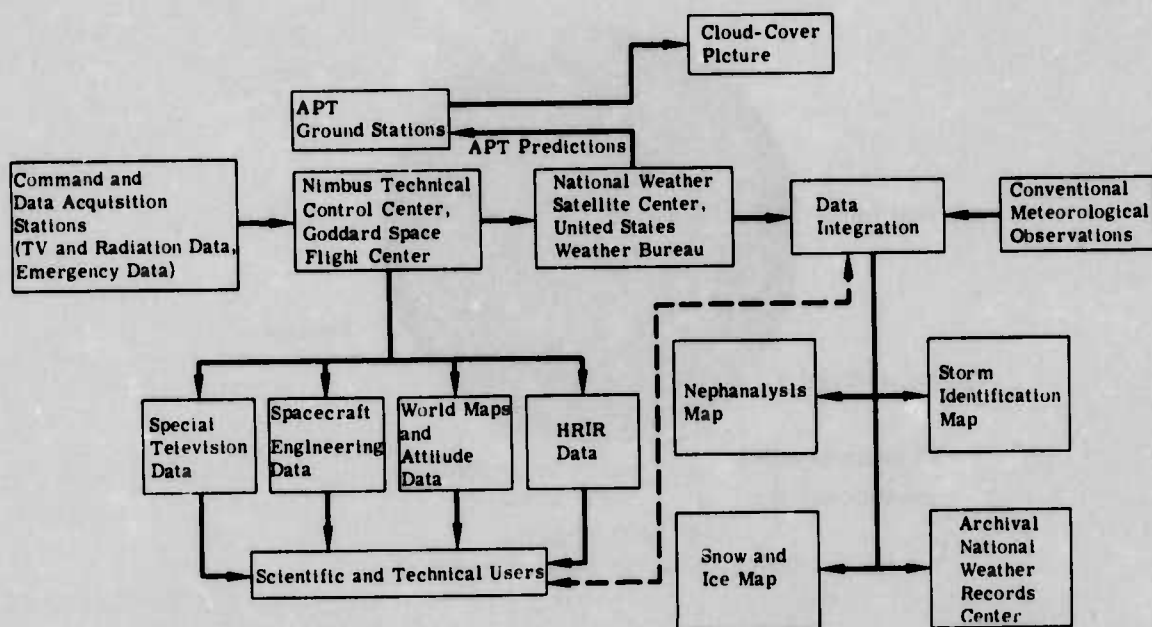

FIGURE 20. NIMBUS PROGRAM DATA FLOW. Nimbus Weather Satellite Scheduled for Launch, 1964.
Unclassified

Separate telemetry links are used for the APT instrumentation and the AVCS-HRIR instrumentation. In general, the APT system provides almost instantaneous facsimile reproductions of the image seen by the APT camera, the telemetry link being maintained directly from the satellite to the user. A typical ground station manufactured by Fairchild-Straton, Inc. is composed of a manually tracking 13-dB helix antenna, a commercially available radio receiver, and a standard facsimile machine (cf. referenced report on Phase II Nimbus Data-Handling System). The APT telemetry system is of the PCM/AM type and operates at 136.5 Mc. It is also through this system that most of the ancillary sensor information is transmitted. The Nimbus APT system serves all institutions, both public and private, with the facilities to process the APT signal.

The AVCS-HRIR systems form the television subsystem. The telemetry for this system is of the frequency-divided FM/FM type, in which the signals from the AVCS vidicons and the HRIR radiometer are FM-modulated, mixed, and transmitted over an S-band FM transmitter at 1707.5 Mc.

UNCLASSIFIED

UNCLASSIFIED

WILLOW RUN LABORATORIES

The initial ground acquisition for Nimbus data is completely handled by one of two similar receiving stations at Gilmore Creek, Alaska, and Rosman, North Carolina. The data received at Gilmore is immediately processed by the Nimbus data-handling system (fig. 21) and transmitted by microwave to Goddard. The data received at Rosman is immediately transmitted to Goddard in raw form (cf. reference on Nimbus Weather Satellite Scheduled for Launch). The U. S. Weather Bureau's National Weather Satellite Center "analyses, disseminates, and archives" the cloud data used for operational meteorological purposes.

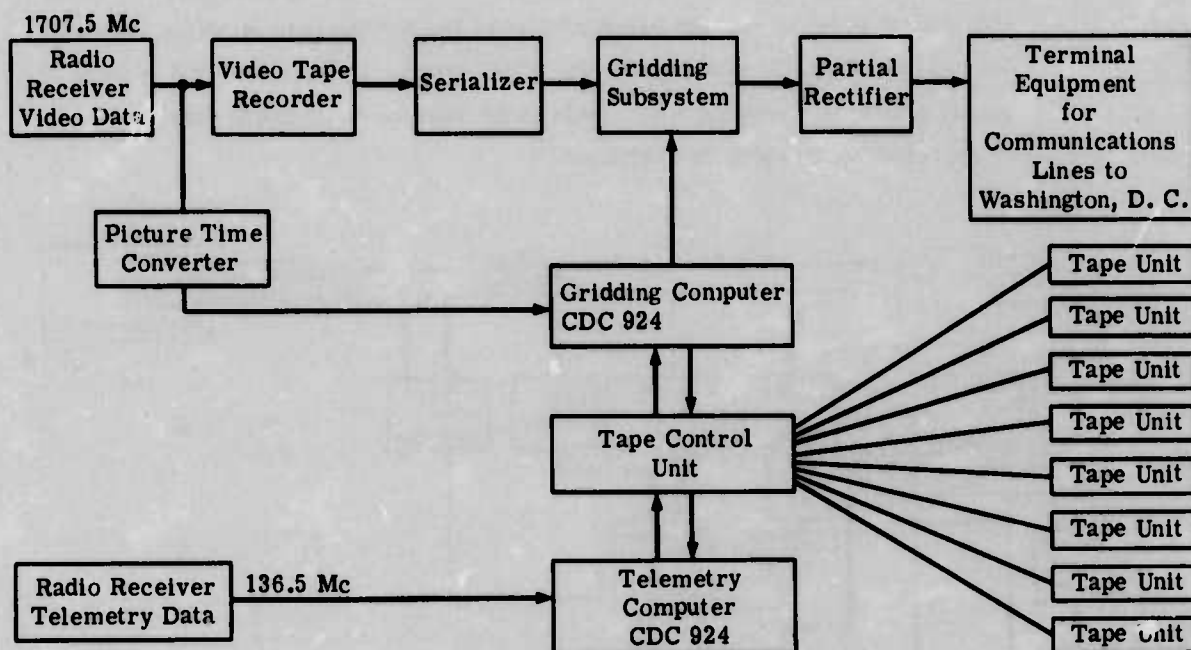

FIGURE 21. SYSTEM ON THE GROUND FOR HANDLING NIMBUS DATA
Unclassified

II. The Data

A. Data Analysis

One of the objectives of the Nimbus I flight was to process the weather information as close to real time as possible. For stations possessing the APT data-processing facility (as described above), the information is in the form of a facsimile photograph. The cloud formations seen by the APT vidicon are in the hands of users within 10 min. Fifty-seven APT receiving stations have been listed by

UNCLASSIFIED

WILLOW RUN LABORATORIES

NASA in the referenced Nimbus I Users' Catalog: AVCS and APT. Of these, 6 are with NASA, 24 are with the armed services, 12 are with the U. S. Weather Bureau, 9 are international participants, and 6 are privately owned. It will be noted that, except for the ancillary information link from NASA to APT stations, these stations are completely independent (fig. 20).

The chief problem involved in AVCS and HRIR picture processing is that of establishing an exact geographical correlation to the picture, i.e., picture gridding. This process is described in detail in the referenced report, Phase II Nimbus Data-Handling System, and is summarized by figure 22. Picture gridding for the AVCS and HRIR data is carried out automatically by the Nimbus data-handling system described in Phase II Nimbus Data-Handling System. Users interested in detailed photogrammetric techniques applicable to the Nimbus AVCS/HRIR data are referred to the referenced report by Goldslak.

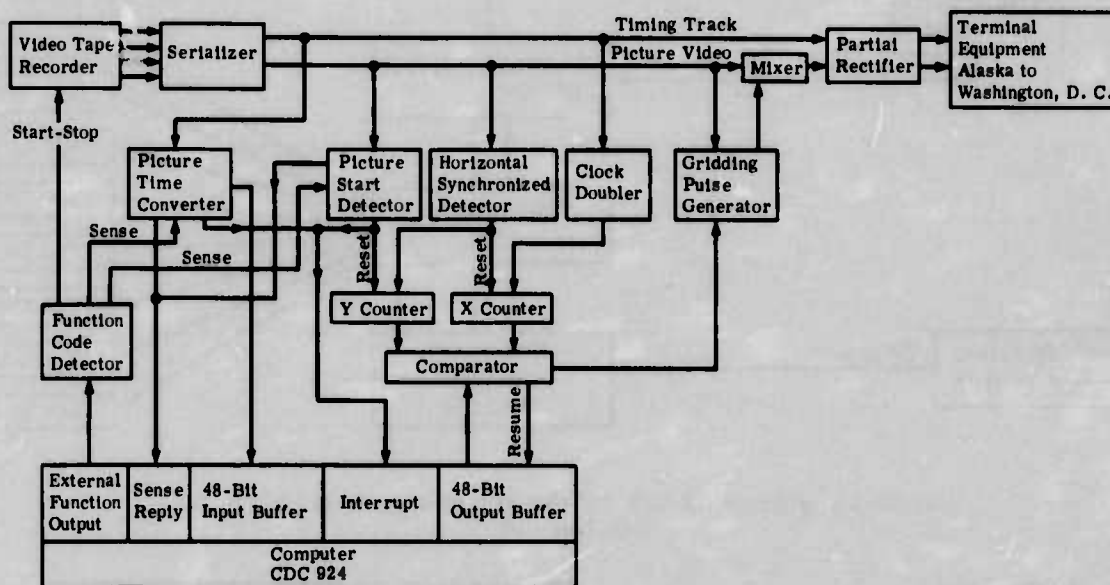

FIGURE 22. GRIDDING SYBSYSTEM OF NIMBUS DATA-HANDLING SYSTEM
Unclassified

Although the major emphasis has been on meteorological information, a limited amount of HRIR data has also been processed for actual radiance values. This is selected from nighttime looks only. It is our understanding that this radiance data has been digitized and is stored at the National Weather Records Center, Federal

UNCLASSIFIED

WILLOW RUN LABORATORIES

Office Building, Asheville, North Carolina. With the radiance values are stored look-angle and satellite-position coordinates. The format is presumably Fortran.*

B. Prepared Data

In general, the source of all prepared picture data from Nimbus is the National Weather Records Center. As the starting point for any potential use of this data, the procurement of the appropriate data users' manual published by NASA is recommended (cf. referenced Nimbus I Users' Catalog: AVCS and APT and Nimbus I High Resolution Radiation Data Catalog and Users' Manual).

The Nimbus I pictures have been stored in the following formats:

- (1) Microfilm film sheets
- (2) Film Rolls (35-mm film in both positive and negative form)

All inquiries should be addressed to the

National Weather Records Center
U. S. Weather Bureau
Federal Building
Asheville, North Carolina 28801

An indication of how the data is to be used has been specifically requested (cf. referenced Nimbus I Users' Catalog).

The users' manuals (cf. referenced Nimbus Spacecraft Development, Nimbus Users' Catalog and Nimbus I High Resolution Radiation Data Catalog) themselves contain interesting presentations of meteorological phenomena as seen by Nimbus I.

Apparently Nimbus has been little emphasized as a source of actual radiance data. As mentioned above, the HRIR radiometer operating in the 3.4- to 4.2- μ band was the only infrared radiometer aboard Nimbus I, and only selected data from nighttime looks have been digitized. Inquiries concerning this data may also be made to the address given above.

Nimbus II, also had an additional medium-resolution, five-channel radiometer similar to the radiometer used in the TIROS vehicles.

C. Error Statements

The Nimbus attitude-control system exhibited a stability of about $\pm 1^\circ$ in pitch, roll, and yaw. This corresponds to a gross location error of about 16 km at nadir.

*Based upon a telephone conversation with Mr. Albert, National Weather Satellite Center, Suitland, Maryland on 11 August 1965.

UNCLASSIFIED

UNCLASSIFIED

WILLOW RUN LABORATORIES

This, of course, implies a possible error of 16 km in the placement of the grid on any given frame (cf. Nimbus I High Resolution Radiation Data Catalog and Users' Manual, p. 19).

The radiometer was calibrated by the field-flooded extended-source method by the use of a blackbody source for which the temperature was accurately known. Although numerical estimates of precision have not been given, the numbers involved are stated to at least two significant figures. In addition, the system exhibited excellent long-term stability (see Nimbus I High Resolution Data Catalog and Users' Manual, p. 16). In view of the number of significant figures and the demonstrated repeatability of measurement, it seems reasonable to assume an overall calibration error not exceeding five percent for all HRIR radlance data.

REFERENCES Unclassified

- G. L. Burdett and R. Shapiro, Nimbus Advance Vidicon Camera Subsystem, NASA N63-18618, Goddard Space Flight Center, Greenbelt, Md., 1963.
- E. M. Darling, Jr., An Analysis of Errors in the Geographic Referencing of Nimbus Cloud Pictures, NASA TN D-2137, Goddard Space Flight Center, Greenbelt, Md., January 1964.
- I. L. Goldberg, Nimbus Radiometry, NASA N63-18617, Goddard Space Flight Center, Greenbelt, Md., 1962.
- L. Goldslak and R. B. Smith, Nimbus Backup Gridding: AVCS and HRIR, Technical Report No. 1, Contract No. NAS 5-3253, ARACON Geophysics Company, Concord, Mass., January 1964.
- P. J. Klass, Nimbus Will Test Electrostatic Camera, Radio Corporation of America's Astro-Electronics Division, Greenbelt, Md., 1961.
- NASA Facts, Vol. II, No. 7, 1965.
- Nimbus I High Resolution Radiation Data Catalog and Users' Manual, Goddard Space Flight Center, Greenbelt, Md., January 1965.
- Nimbus I Users' Catalog: AVCS and APT, Goddard Space Flight Center, Greenbelt, Md., and ARACON Geophysics Company, Concord, Mass., March 1965.
- Nimbus Weather Satellite Scheduled for Launch, NASA, Washington, D. C., August 1964.
- Phase II Nimbus Data-Handling System, Stanford Research Institute, Menlo Park, Calif., January 1963.
- H. Press and J. V. Michaels, Nimbus Spacecraft Development, Goddard Space Flight Center, Greenbelt, Md., April 1963.
- R. A. Stampfl, The Nimbus Spacecraft and Its Communication System as of September 1961, NASA TN D-1422, Goddard Space Flight Center, Greenbelt, Md., January 1963.

UNCLASSIFIED

WILLOW RUN LABORATORIES

3.13. (U) TRANSIT 1A, 1B, AND 2A SATELLITES

I. Instrument Description and Platform

A. General

The U. S. Naval Ordnance Test Station (NOTS) at China Lake, California, designed and constructed an infrared terrestrial scanner which was flown as an auxiliary experiment on Transit 1A, 1B, and 2A navigational satellites. The object of the experiment was to obtain background data in the 2- to 3- μ range. Only the Transit 2A experiment yielded quantitative radiance values.

Orbital characteristics of the satellites are shown in table IV.

TABLE IV. ORBITAL CHARACTERISTICS OF TWO TRANSIT SATELLITES
Unclassified

	<u>Date of Launch</u>	<u>Apogee (km)</u>	<u>Perigee (km)</u>
Transit 1B	13 April 1960	—	—
Transit 2A	22 June 1960	1064	622

B. Instrumentation

The scanner contained a telescope, an uncooled PbS detector with a filter, and a detector amplifier. Detector dimensions were 0.5 mm by 0.5 mm.

The unit was calibrated using the far-point-source method.

C. Spectral Information

The interference filter's 50-percent response points were at 1.85 and 2.73 μ .

D. Spatial Information

The field of view was 6 mrad at the half-power points with the telescope focused for plane-parallel rays. Field-of-view response curves are given in the report. The scanner looked in a direction perpendicular to the satellite's spin axis. The spin provided the scan, and the orbital advance provided the raster. The telescope scanned a strip about 3 mi wide, and the satellite advanced about 6 mi between scans.

UNCLASSIFIED

UNCLASSIFIED

WILLOW RUN LABORATORIES

E. Data Recording Procedures

The data were telemetered to eight tracking stations.

II. Data

A. Raw-Data Format

From a telephone conversation with Mr. George Wilkins, it was ascertained that the data in analog tape form are still available at NOTS, but none have been analyzed.

B. Prepared Data

The only data given in the report are contained in an infrared picture.

REFERENCE Unclassified

D. K. Moore and F. B. St. George, Infrared Terrestrial Backgrounds Scanner (U), TD 2627, NOTS, China Lake, Calif., March 1961 (SECRET).

3.14. (U) TASCAN INFRARED-MAPPER EXPERIMENT

I. Instrument Description and Platform

A. General

TASCAN was a rocket-borne infrared scanner developed to produce data suitable for the direct reproduction of a two-dimensional radiance map of the infrared background structure as seen from missile altitudes. The experiments have yielded data sufficient for the construction of several two-dimensional radiance maps of the background seen in the 2.5- μ region. The data were suitable only for qualitative analysis.

The vehicle was a two-stage Terrier-Asp I rocket. Four were fired between June and October 1960. The maximum altitude was approximately 55 nmi. The last rocket was shot over the ocean off the California coast, and the data from this flight are given in the report.

B. Instrumentation

The TASCAN infrared scanner was composed of an infrared telescope, an amplifier, and a telemetry system.

UNCLASSIFIED

WILLOW RUN LABORATORIES

The instrument was calibrated by means of a Barnes blackbody source. The far-point-source method was used.

C. Spectral Information

The half-power points for the system were at 2.16 and 2.73 μ . The relative spectral response is given in figure 23.

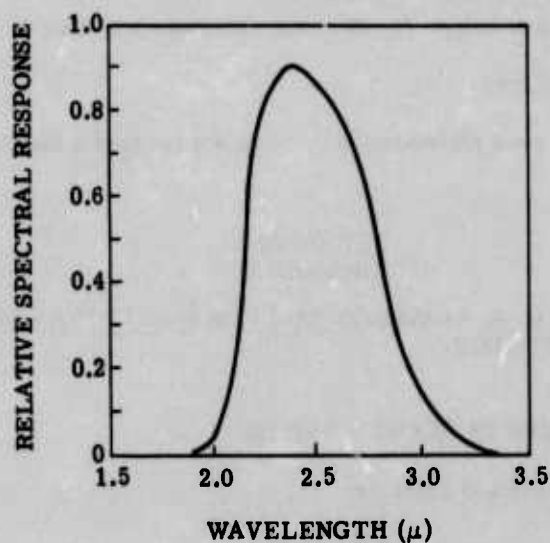

FIGURE 23. RELATIVE CELL-FILTER RESPONSE
FOR TASCAN
Unclassified

D. Spatial Information

The field of view was 10 mrad by 10 mrad. The payload had a spin of 3 r/sec with the spin axis almost parallel to the surface of the earth. The trajectory was very shallow. Since the telescope looked in a direction perpendicular to the spin axis, the spin provided the scan, and the trajectory advance provided the raster.

E. Data Recording Procedure

Data were acquired by telemetry.

II. Data

A. Data Reduction

The raw-data format was analog magnetic tape. The signal was demodulated by means of a frequency discriminator and modulated the Z axis of an oscilloscope

UNCLASSIFIED

UNCLASSIFIED

WILLOW RUN LABORATORIES

to produce the infrared map directly. The CRT readout was then photographed. The data were also subjected to analysis for radiance values.

B. Prepared Data

Thirteen photographs were produced as described above. Samples of these appear in the NOTS report.

Data amounting to 111 samples were reduced for a probability distribution of relative radiance values (p. 12 of the referenced NOTS report).

C. Experimental Error

The data were estimated to have an accuracy of a factor of 2.

REFERENCE Unclassified

D. K. Moore, N. Lowe, and G. A. Wilkins, Infrared Data from TASCAN (U), NOTS, China Lake, Calif., June 1961 (CONFIDENTIAL).

3.15. (U) THE T-BIRD SERIES OF ROCKET PROBES

I. Instrument Description and Platform

A. General

T-BIRD, an acronym for terrestrial background infrared detection, is the designation given to a series of rocket-probe experiments carried out by NOTS. The signal processing from the T-BIRD radiometer has been similar to that used in the Transit II-A and TASCAN experiments (see secs. 3.13 and 3.14) in that two-dimensional facsimile reproductions of the scene were automatically generated.

The spinning motion of the vehicle provided a line scan of the earth from horizon to horizon. The forward advance of the vehicle transformed the line scans into a raster scan (for details, see sec. D). The resulting signal could be reconstructed on the face of an oscilloscope in a manner similar to conventional television.

The T-BIRD probes were carried aloft by Terrier-Asp vehicles launched from Eglin Air Force Base, Florida. Ten launchings were carried out, four of which yielded satisfactory radiance data. All of the probes were launched on a due-south trajectory and reached peak altitudes of approximately 64 km. Other flight details appear in table V.

UNCLASSIFIED

WILLOW RUN LABORATORIES

TABLE V. FLIGHT DETAILS OF T-BIRD PROBES
Unclassified

<u>Flight Number</u>	<u>Date</u>	<u>Time (EST)</u>
T-BIRD 03	2 February 62	1330
T-BIRD 04	5 April 62	1200
T-BIRD 10	17 January 63	1322
T-BIRD 09	16 October 63	1145

B. Instrumentation

Three detectors in a linear array were used in the radiometers. On T-BIRD 03 and T-BIRD 04, all three detectors were uncooled PbS and were placed in a single radiometer. On T-BIRD 09 and T-BIRD 10, two PbS detectors were placed in one radiometer as before, and a PbSe liquid-nitrogen-cooled detector was used in a second radiometer. Incoming radiation was optically chopped and filtered.

The radiometer was calibrated for responsivity by means of a commercial blackbody source. A field-stopped-irradiance method was used.

C. Spectral Information

On T-BIRD 03 and T-BIRD 04, the radiometers were peaked in the 1.9-, 2.2-, and 2.7- μ bands. On T-BIRD 09 and T-BIRD 10, the 1.9- μ band was replaced by the 6.7- and 4.3- μ bands respectively. On T-BIRD 03 and T-BIRD 04, the bandwidth was around 0.05 μ for all channels. On T-BIRD 09 and T-BIRD 10, the bandwidths were approximately 0.05 μ at 2.2 μ , 0.12 μ at 2.7 μ , 0.43 μ at 6.7 μ , and 0.09 μ at 4.3 μ . The filter-transmission curves are given in figure 24.

The spectral response of each radiometer was determined by using a scanning spectrometer, in a purged, dry, nitrogen environment. The off-band rejection capabilities of the filters were also checked in this calibration.

D. Spatial Information

The radiometers looked in a direction perpendicular to the axis of the vehicle so that the combined spin and trajectory advance provided complete ground coverage. The field of view of each detector was 23 mrad by 23 mrad, and the detectors

UNCLASSIFIED

UNCLASSIFIED

WILLOW RUN LABORATORIES

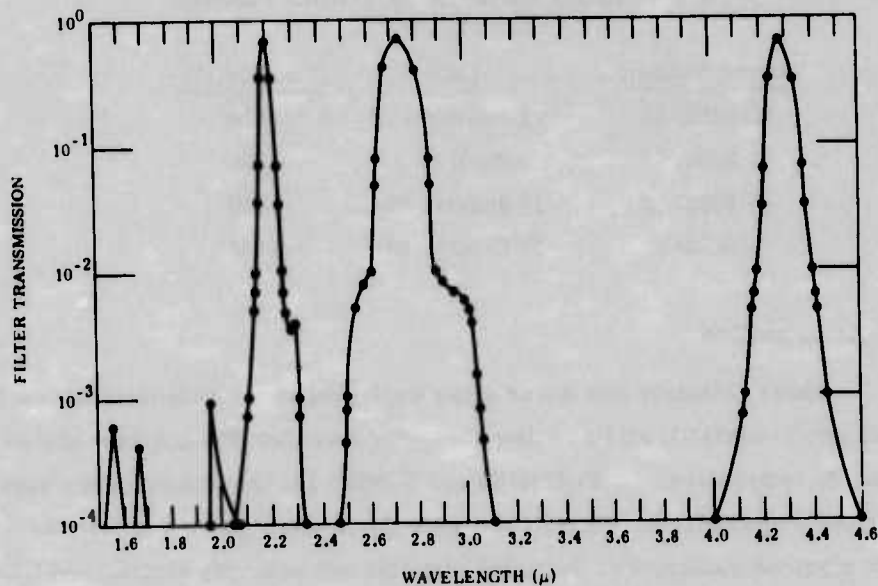

FIGURE 24. FILTER CURVES FOR DETECTORS IN T-BIRD 10
Unclassified

were arranged in line so that they followed one another as the vehicle spun. None of the vehicles spun precisely as planned.

E. Data Acquisition

The data were transmitted to earth by an FM/FM telemetry system.

II. Data

A. Signal Processing

A limited amount of the data output was used to generate a two-dimensional oscilloscope reproduction of the scene as viewed in the various spectral regions. The readout was photographed, and samples of the photographs have been presented (see below).

In addition, the raw signal has been digitized for analysis leading to data on actual radiance.

B. Data Analysis

The two-dimensional photographic reproductions mentioned above were carried out by personnel of NOTS.

UNCLASSIFIED

WILLOW RUN LABORATORIES

The digitized data is being analyzed by The University of Michigan's Institute of Science and Technology. Here the analysis has involved multispectral statistical distributions of radiance levels and radiance differences between adjacent view fields.

C. Prepared Data

Representative photographs portraying the background scene as viewed in the various wavelength regions have been presented in the referenced report by St. George.

Results of the statistical analyses have not yet been published.

D. Error

The responsivity calibration was felt to have a probable error of approximately 15 percent. The probable error applicable to the reduced data is 20 percent, except for data in which noise degradation occurred. This applies chiefly to the 2.7- μ data.

REFERENCES Unclassified

J. Hoyem et al., NOTS - Michigan T-BIRD Reports: T-BIRD 10, T-BIRD 04, Report No. 6054-3-T, Willow Run Laboratories, The Institute of Science and Technology, Ann Arbor, May 1967, AD 814 844.

F. B. St. George, Project T-BIRD, Report No. TP-3651, NOTS, China Lake, Calif., November 1965.

Target Radiation and Background Measurement Study (U), Volume II, Report No. S-1336, Aeronutronic Division of Ford Motor Company, Newport Beach, Calif., August 1961 (SECRET).

3.16. (U) THE BIRA 01 AND BIRA 02 EXPERIMENTS

I. Instrument Description and Platform

A. General

The BIRA series of missile flights, another in the HITAB Program under ARPA Order No. 243-61, is designed to measure background radiation by using high-altitude missile probes. Specifically, the BIRA series has been designed to provide information on the spectral radiance structure of clouds by gathering background radiance data under conditions of dense cloud cover. The experimental

UNCLASSIFIED

UNCLASSIFIED

WILLOW RUN LABORATORIES

work has been done by the NOTS, and the data analysis has been the responsibility of The University of Michigan's Institute of Science and Technology (IST).

The BIRA payloads were instrumented in both the infrared and ultraviolet. The infrared device was a color-wheel radiometer (CWR) possessing filters in nine bands which covered the range from 2.3μ to 4.9μ . The ultraviolet radiometer (UVR) was filtered at 2665 \AA .

The BIRA experiments have produced 10^3 infrared radiance values for each filter and 10^3 ultraviolet radiance values. There was a significant amount of noise degradation in the $2.9\text{-}\mu$ and $2.7\text{-}\mu$ channels, however.

The BIRA 01 missile was launched from the White Sands Missile Range on 16 March 1964 at 1929:03 GMT. The nominal flight path was due north. The peak of the trajectory was 188 km.

BIRA 02 was launched from the NASA Wallops Island Test Site in October 1964 at 1822:00 GMT. The flight path was 116° east. The peak of the trajectory was 133 km.

B. Instrumentation

The CWR, the UVR, and a camera comprised the optical instrumentation significant to this review. The three instruments were accurately boresighted.

The CWR employed Cassegrainian collecting optics. The optical path then followed with a Ge ultraviolet-suppression filter, a highly polished chopper wheel, the filter wheel with nine filters and one blank, and finally the detector unit. The detector was PbSe, liquid-nitrogen cooled, potted in SrTi, and had a sapphire window. The chopping rate for the CWR was 1066 Hz. The instrument is illustrated in figure 25. The BIRA 02 CWR was the same unit flown in the BIRA 01 experiment but had a new detector unit and, therefore, required an independent calibration.

The BIRA-01 UVR utilized refractive collecting optics, a multi-segment chopping wheel, a bulk-absorption optical filter, and a photomultiplier detector. The chopping speed was 30 per second. The boresight camera was a Millikan DBM-3 16-mm camera. This unit had recording capacity sufficient to obtain photographs of the scene continuously throughout the operational part of the missile flight at a rate of eight frames per second. The recovery of the photographic data relied upon the recovery of the film after the impact of the instrument package at the end of the flight.

UNCLASSIFIED

WILLOW RUN LABORATORIES

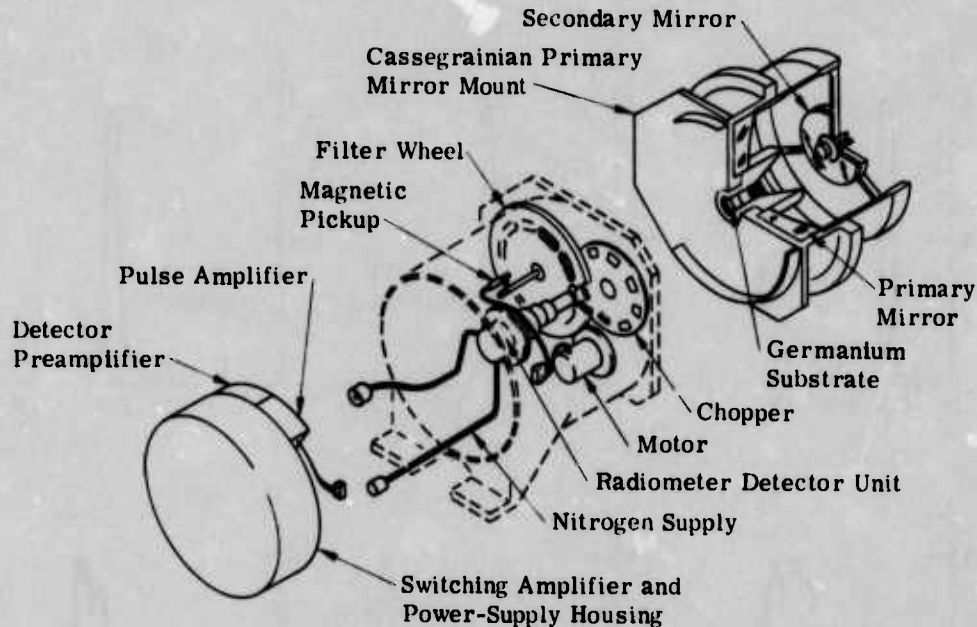

FIGURE 25. THE BIRA 01 COLOR-WHEEL RADIOMETER SYSTEM
Unclassified

Also included in the BIRA instrumentation were a long-wavelength radiometer and a rapid-scan interferometer. The radiometer failed to produce valuable data in both BIRA 01 and BIRA 02. The interferometer signal presented a difficult problem in that the signal was composed of a mixture of frequencies attributable to both spatial and spectral variations. The analysis of this data has thus far been deemed unduly difficult to warrant any effort.

Special jigs, stands, and environmental test chambers assembled for the HITAB radiometer calibrations were available for the BIRA instrument calibrations. Responsivity calibrations were carried out before and after the BIRA 01 flight and before the BIRA 02 flight. The CWR was calibrated by a field-stopped far-point-source method; the UVR was calibrated using an aperture-irradiance method.

C. Spectral Information

The CWR covered the 2.3- to 4.9- μ range with nine filters. The system spectral response for each filter is given by figure 26. The UVR passed radiation in the 2555- to 2777- \AA region as shown in figure 27.

UNCLASSIFIED

UNCLASSIFIED

WILLOW RUN LABORATORIES

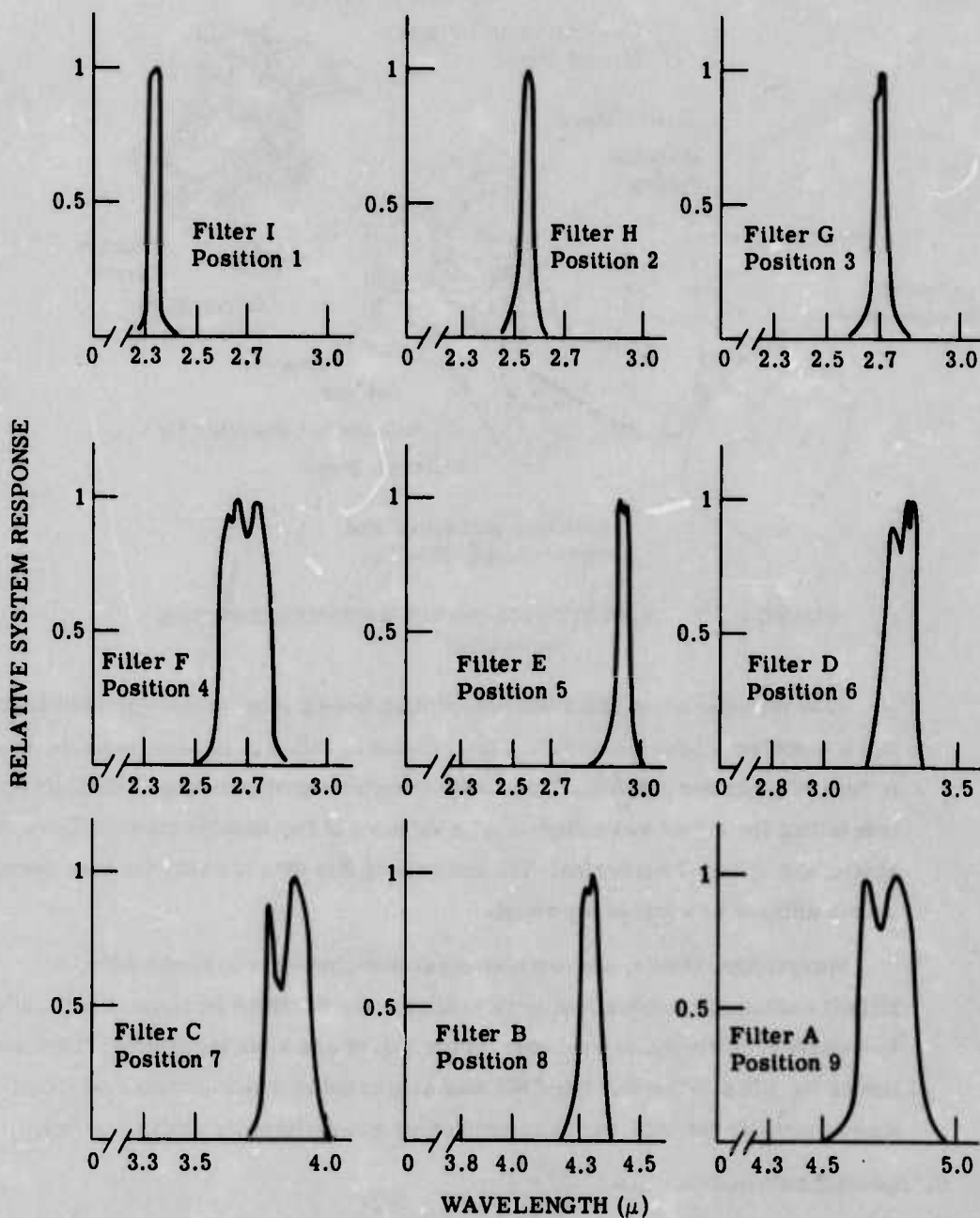

FIGURE 26. SPECTRAL RESPONSE OF THE BIRA 01 COLOR-WHEEL RADIOMETER
Unclassified

UNCLASSIFIED

WILLOW RUN LABORATORIES

D. Spatial Information

The field of view of the CWR was approximately square and subtended an angle of 5×5 mrad (0.3° by 0.3°). The field of view of the UVR was approximately conical and had a 6 mrad apex angle. Field-of-view, response-contour maps were generated during the calibration.

The scanning motion of the radiometers covered the hemisphere beneath the missile as shown in figure 28. The optic axis scanned in a vertical plane through a total of 180° . At the end of the scan, the azimuthal angle was shifted by a fixed amount. The next 180° elevation scan then followed. The period of scan was about 50 sec. There were to be five such scans.

In the actual mission performance, the attitude control system (ACS) and scanning mechanism deviated somewhat from the planned sequence. However, correlation of the look angles with the radiance data was achieved to the extent that the look angles at any instant were known within $\pm 2^\circ$.

E. Data Recording Procedure

The data were collected by telemetry and recorded both on a standard 12-in. strip chart and on analog tape. The radiometers employed ac coupled amplifiers.

II. Data

A. Raw-Data Format

Early in the reduction of the BIRA 01 data, it became apparent that digitization of the radiance data was desirable because the internal emission (N_R) of the radiometer was sometimes greater than the incoming signal, making an algebraic sign determination necessary. Thus the analog tapes for BIRA 01 and BIRA 02 were converted to a digital format by the NODAC facility of NOTS, becoming raw-data tapes CHT-48 and CHT-49, respectively. Only the CWR signal was so recorded; the UVR signal had to be read directly from the strip chart.

B. Data Reduction

The CWR and UVR data has been reduced at the IST. The responses of the CWR and the UVR were nearly linear, making it possible to convert signal to radiance by using a single responsivity for each filter position.

Programs in IBM 7090 Fortran were written to carry out the necessary tasks, including noise-correction subroutines. The final output was radiance as a function

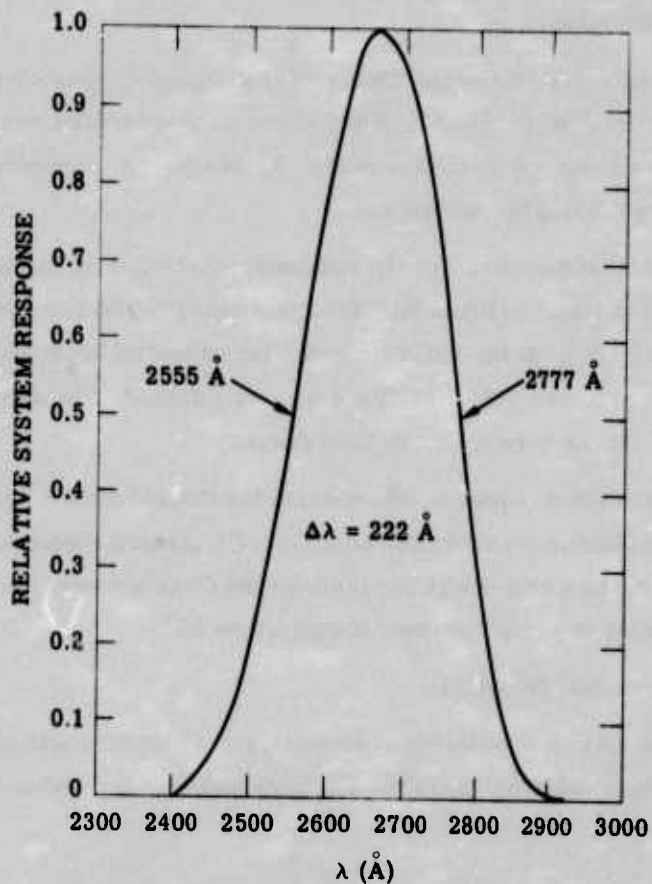

FIGURE 27. SPECTRAL RESPONSE OF THE BIRA 01 ULTRAVIOLET RADIOMETER
Unclassified

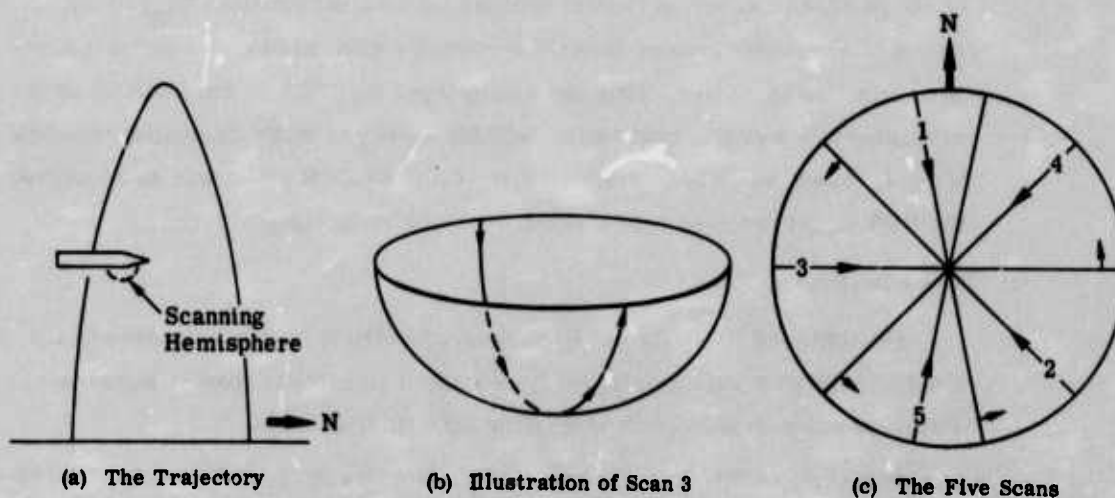

FIGURE 28. THE BIRA 01 SCAN PATTERN
Unclassified

UNCLASSIFIED

WILLOW RUN LABORATORIES

of time for each filter. The look angles and sun angles were expressed analytically in terms of time, thus giving radiance as a function of these angles as well.

C. Data Analysis

With proper qualifications, all channels of the BIRA CWR and UVR generated data suitable for analysis throughout the time of measurement. (See sections on "Prepared Data" and "Experimental Error," below.)

D. Prepared Data

Statistical analysis similar to that used in several other cognate programs has been carried out by IST workers. Probability distributions of radiance values, radiance differences, and crossing-time distributions have been confined to the channel 3 (2.7 μ) data; a joint-frequency-scattering diagram between the channel 4 (2.7 μ) and channel 9 (4.7 μ) data has also been prepared. These data appear in the final reports, IST numbers 6054-7-T and 6054-8-T, referenced herein.

E. Experimental Error

The root-square error in the CWR calibration has been estimated to be

$$\sqrt{11.5^2 + 12.6^2 + 3.0^2} \approx 17$$

In the equation above, the indicated percentages are the errors in the determination of the aperture irradiance, the field of view, and the output voltage, respectively.

The look-angle uncertainties have been estimated to be $\pm 2^\circ$ for the instrument relative azimuth and $\pm 2^\circ$ for the instrument elevation angle.

The signal-to-noise ratio (SNR) was high throughout the flight. For the most part, it appears to have been approximately 20 dB. There was, however, considerable degradation in the BIRA 01 data because of a burst-type noise, and white noise also added to the uncertainty in the low-signal (2.5 μ , 2.7 μ , and 2.9 μ) channels in both experiments. The exact error statements appear in the technical reports 6054-7-T and 6054-8-T.

REFERENCES Unclassified

N. R. Dittmar et al., The BIRA 01 Experiment, Report No. 6054-7-T, Willow Run Laboratories, The Institute of Science and Technology, Ann Arbor, July 1968.

N. R. Dittmar et al., The BIRA 02 Experiment, Report No. 6054-8-T, Willow Run Laboratories, The Institute of Science and Technology, Ann Arbor, March 1968.

UNCLASSIFIED

UNCLASSIFIED

WILLOW RUN LABORATORIES

HITAB Summary Report Prepared for 26 June TABSTONE Meeting (U), NOTS, China Lake, Calif., June 1962 (CONFIDENTIAL).

D. K. Moore, Fourth Technical Summary Report: HITAB (TABSTONE) Rocket Probe Program (U), TP3609, NOTS, China Lake, Calif., November 1964 (CONFIDENTIAL).

C. P. Smith, Third Technical Summary Report: HITAB (TABSTONE) Rocket Probe Program (U), TP3275, NOTS, China Lake, Calif., June 1963 (CONFIDENTIAL).

3.17. (U) AIRBORNE INFRARED-RADIATION MEASUREMENTS AT THE ROYAL AIRCRAFT ESTABLISHMENT: BROWN, CHAMBERLAIN, AND HUGHES

I. Instrumentation and Platform

A. General

A limited amount of cloud-reflectance data was obtained in a series of airborne measurements performed by the Royal Aircraft Establishment (RAE) of England. The reflectance measurements were made in conjunction with atmospheric-transmission and pyrotechnic-emission measurements.

Because the spatial field of view was broad, and the spectral resolution was rather broad (see below), the radiance data is representative of gross radiance structure but not suitable for detailed spatial or spectral analysis.

The platform was an RAE Comet aircraft. The peak altitude was 12 km. Several flights were made over the period of June 1961 to August 1962.

B, C. Instrumentation and Spectral Information

A radiometer was used, with interchangeable detectors as shown in table VI. Also, two cameras were used to photograph the scene.

TABLE VI. DETECTORS USED IN RAE RADIATION MEASUREMENTS
Unclassified

<u>Filter</u>	<u>Detector</u>	<u>Spectral Response (μ)</u>
Ge	PbS	1.8 to 3.0
PbS	liquid-air-cooled PbTe	3.3 to 5.2

D. Spatial Information

The size of the field of view is not given although it is stated that the response was approximately uniform over a field of 4° (circular). The radiometer looked

UNCLASSIFIED

WILLOW RUN LABORATORIES

out the side of the aircraft, and its look angle could be varied manually by an operator.

E. Data Recording Procedures

To measure the sunlight reflected from cloud tops, the plane first flew in a square pattern above the cloud and then in circular patterns at increased angles of bank. In this way, radiation from all azimuth angles and elevation angles down to 15° from the nadir could be covered.

The output from the radiometer was continuously recorded, and the photographs were correlated with the radiometer output.

II. Prepared Data

One graph is presented that shows the reflected sunlight (absolute radiance) from a cloud top as a function of elevation angle in the north-south direction. The sun angle is also given.

More measurements of the sunlight reflected from cloud tops were made by flying the pattern outlined above. Sun angle, cloud-top altitude, aircraft altitude, and time of day were recorded with these measurements, but these data are not presented.

REFERENCE Unclassified

D. R. Brown, J. P. Chamberlain, and N. D. P. Hughes, Airborne Infra-Red Radiation Measurements at the Royal Aircraft Establishment (U), RAD 830, Royal Aircraft Establishment, Farnborough, England, March 1963, AD 337 521 (SECRET).

3.18. (U) BACKGROUND DATA FROM AN INVESTIGATION OF ULTRAVIOLET SURVEILLANCE TECHNIQUE: NORTHROP SPACE LABORATORIES

I. Instrument Description and Platform

A. General

An X-15 platform has been used to obtain ultraviolet-radiance data and to determine the ultraviolet albedo from 300,000-ft altitudes. Two successful missions were flown, one on 18 June 1963 and one on 22 August 1963. This work was conducted for the Air Force Avionics Laboratory under contract AF 33(657)-8367.

UNCLASSIFIED

UNCLASSIFIED

WILLOW RUN LABORATORIES

B. Instrumentation

A scanning ultraviolet spectrometer was used. The manufacturer was the Barnes Engineering Company.

The optical design was of the so-called Czerny-Turner type. See figure 29 for a diagram of the system.

Spectral scanning was done by moving the exit slit through the diffracted field. A traveling Mylar endless tape having slits of three different widths was used. The slits were spaced along the tape in such a way that an exit slit was always traveling across the field.

Calibration of the spectrometer involved first calibrating the photomultiplier detector and then calibrating the whole system. For the detector calibration, a National Bureau of Standards lamp was used in conjunction with a monochromator and an achromat, the respective spectral transmission of which were known. The system was in turn calibrated with a Bausch and Lomb hydrogen-arc lamp.

A potentiometer was coupled with the slit-tape mechanism so that the wavelength setting was known in terms of a corresponding output voltage.

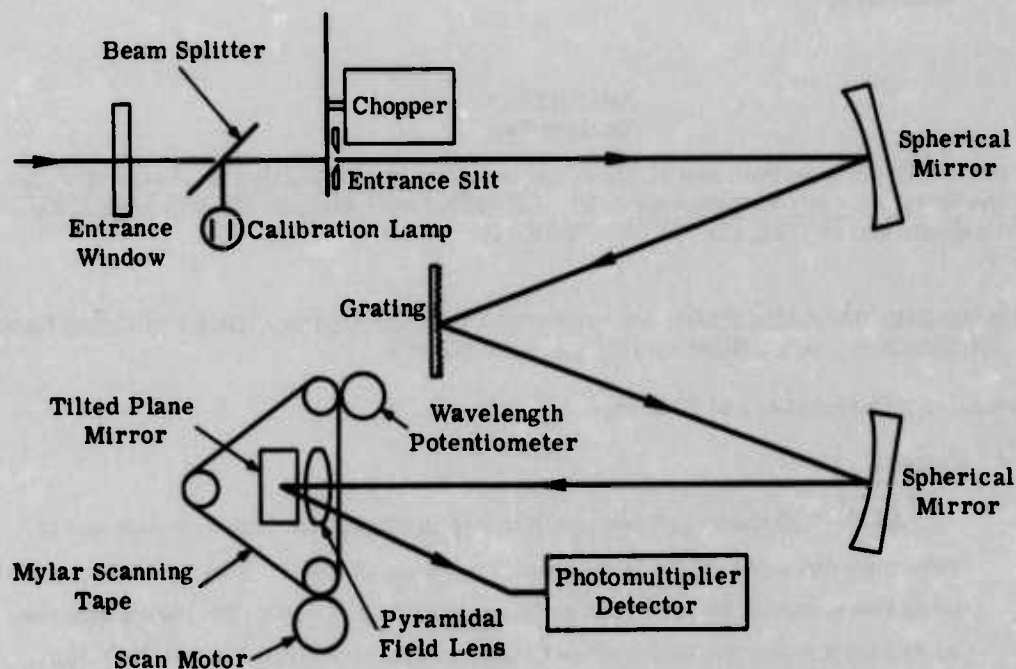

FIGURE 29. OPTICAL DESIGN OF THE ULTRAVIOLET SPECTROMETER USED IN THE NORTHROP INVESTIGATION OF ULTRAVIOLET SURVEILLANCE TECHNIQUE. Landrum et al., 1964.
Unclassified

UNCLASSIFIED

WILLOW RUN LABORATORIES

The spectral resolution for each of the three exit-slit geometries was found by observing the increment in wavelength over which the spectrometer would respond to the 0.2536- μ Hg line.

C. Spectral Information

The spectral response of the spectrometer is given by figure 30. The spectral resolution varied from 0.005 μ to 0.18 μ , depending upon the exit-slit width (the slit in the Mylar tape).

D. Spatial Information

The field of view was about 5⁰ square.

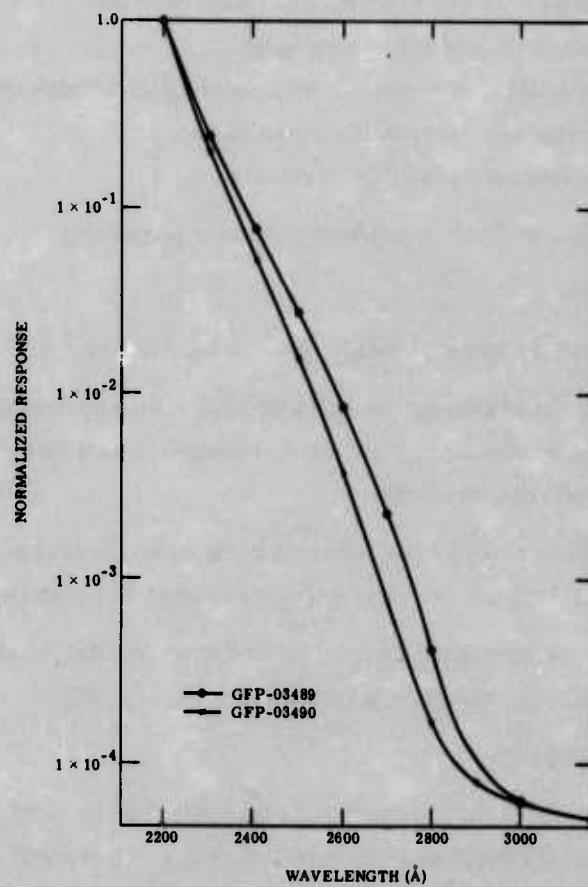

FIGURE 30. SPECTRAL RESPONSE OF THE PHOTOMULTIPLIER (No. CL1125) OF THE SPECTROMETER USED IN THE NORTHROP INVESTIGATION OF ULTRAVIOLET SURVEILLANCE TECHNIQUE.

Landrum et al., 1964.

Unclassified

UNCLASSIFIED

UNCLASSIFIED

WILLOW RUN LABORATORIES

E. Data Recording Procedures

The data were recorded aboard the X-15. The spectrometer output and the corresponding look-angle information were recorded separately as functions of time. Correlation to physical information was therefore satisfactory.

The raw-data format was not stated.

II. Data

A. Data Processing

The data from the X-15 flights were processed in the following steps:

- (1) Recording of spectrometer output vs. time
- (2) Recording of look-angle and altitude information vs. time
- (3) Transfer of signal outputs to radiance values
- (4) Computation of scattering angle
- (5) Correlation of radiance and scattering angle with spatial information
- (6) Computation of radiance mean values
- (7) General interpretation of results

Steps 3, 4, 5, and 6 above involved computer processing.

B. Prepared Data

Prepared for and included in the Landrum report are:

- (1) Graphs of average background ultraviolet spectral radiance (watts/square centimeter-steradians-microns vs. wavelength from 0.22 to 0.30 μ) for look angles from 8° to 48° (pp. 224-249)
- (2) Graph of theoretical spectral background (p. 228) after Green (Proc. IRIS, Vol. 6, No. 1) and the Geophysics Corporation of America (work not cited)
- (3) Graph comparing theoretical and experimental results of several workers on scattered solar radiance from 0.20 to 0.33 μ (p. 229)

C. Experimental Error

The entrance-slit assembly became loose during the 22 August 1963 flight, and the entrance-slit width was therefore changed to an uncertain degree.

The SNR was also somewhat low in this flight.

Numerical precision estimates were not given.

UNCLASSIFIED

UNCLASSIFIED

WILLOW RUN LABORATORIES

D. Program Continuation

A similar program was planned by the Nortronics workers under contract AF 33(615)-1483. The status of this program was not known at the time of this writing. References known to be available are given below.

REFERENCE Unclassified

B. L. Landrum et al., An Investigation of Ultraviolet Surveillance Techniques (U) (Final Report), Northrop Space Laboratories, Hawthorne, Calif., February 1964, AD 347 667 (SECRET).

3.19. (U) ICBM CLOUD PHOTOGRAPHS

I. Instrument Description and Platform

A. General

These cloud photographs were taken from ICBM nose cones between altitudes of 100 and 700 nmi. The Thor and Atlas test flights on which the photographs were taken were made between May and August 1959.

B. Instrumentation

The best data were obtained on the Atlas flight of 24 August; on this flight, a 16-mm camera was used.

C. Spectral Information

The camera operated in the visible portion of the spectrum.

D. Spatial Information

The camera's field of view was approximately 90° diagonally across the frame. On the 24 August flight, the camera was aimed downward at angles between 16° and 26° from the horizontal throughout most of the flight.

E. Data Recording Procedures

The film rate was 2.5 frames per second. The film was recovered from the nose cone after the flight.

II. Data

A. Data Published in Reports

Several cloud photographs are presented, some of which are correlated with weather charts.

UNCLASSIFIED

UNCLASSIFIED

WILLOW RUN LABORATORIES

REFERENCES Unclassified

- J. H. Conover and J. C. Sadler, "Major Cloud Patterns as Seen From Altitudes of 250 to 850 Miles — Preliminary Results," Bull. Am. Meteorol. Soc., Vol. 41, No. 6, June 1960.
- D. N. Vachon and J. I. F. King, High Altitude Cloud Photography From Ballistic Missiles, Report No. R 595D471, Aerosciences Laboratory, General Electric Missile and Space Vehicle Department, Philadelphia, December 1959, AD 229 971.

3.20. (U) MERCURY SPACECRAFT MA-8

I. Instrument Description and Platform

A. General

The photographs were taken from Mercury Spacecraft MA-8 by Walter M. Schirra, Jr., on 3 October 1962. All pictures were taken at altitudes between 134 and 147 nmi.

B. Instrumentation

A Hasselblad Model 500-C hand-held camera was used with experimental black and white film.

C. Spectral Information

The film's response extended from 0.38 to 0.72 μ , but filters were used on the camera so that photographs could be taken in several regions of the visible spectrum. Spectral transmittance curves for these filters and other optical components are given in figure 31.

D. Spatial Information

The field of view of the camera was 35.3° by 35.3°.

E. Data Recording Procedures

The roll of film used for the photographs was developed after the flight.

II. Data

A. Data Published in Report

The 13 pictures taken by the astronaut are all published. Each photograph is divided into six sections; a different filter was used in each section. The photographs show the earth and the horizon.

In addition, microdensitometer traces are given for one of the photographs. These show the variations in film density in a direction perpendicular to the hori-

UNCLASSIFIED

UNCLASSIFIED

WILLOW RUN LABORATORIES

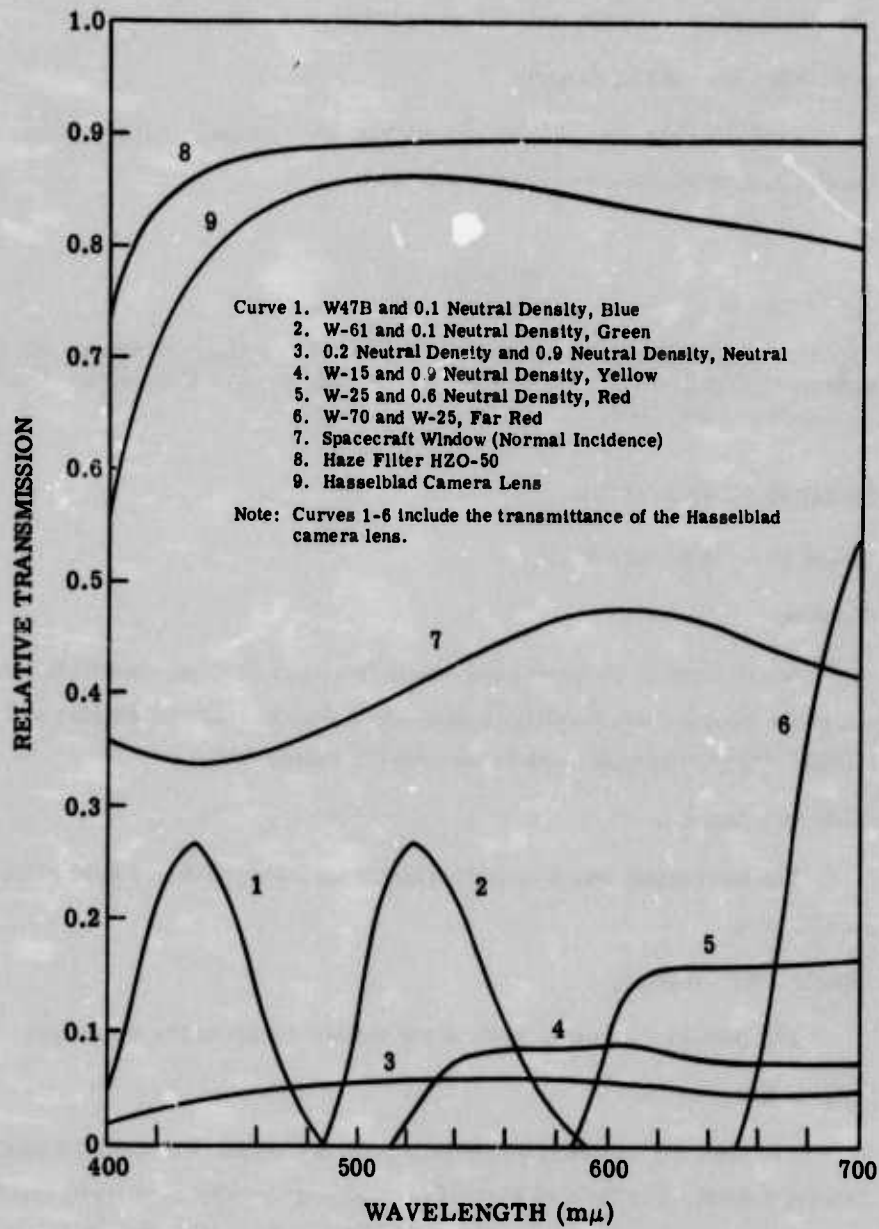

FIGURE 31. SPECTRAL TRANSMISSION OF OPTICAL COMPONENTS IN MERCURY SPACECRAFT. Mercury photographs.
Unclassified

UNCLASSIFIED

WILLOW RUN LABORATORIES

zon for each of the six filters. A calibration curve is given so that these density readings can be converted to values of relative brightness.

B. Data Not Published in Report

Microdensitometer measurements have been made on all the photographs, but only those mentioned above were published.

REFERENCE Unclassified

S. D. Soules, Spectral Reflectance Photograph of the Earth from Mercury Spacecraft MA-8, Report No. 2, Meteorological Satellite Laboratory, U. S. Department of Commerce, Weather Bureau, Washington, D. C., November 1963.

3.21. (U) U-2 CLOUD PHOTOGRAPHS

I. Instrument Description and Platform

A. General

A U-2 aircraft photographed clouds from altitudes between 50,000 and 65,000 ft on 28 May, 2 June, 3 June, 28 July, and 5 August 1960 and 28 May and 29 May 1962. All photographs were taken over the United States.

B. Instrumentation

The instrument was a camera which used 70-mm film. Each frame was about 10 in. long.

C. Spectral Information

The photographs were taken in the visible region of the spectrum.

D. Spatial Information

The spatial resolution of the camera is not given. The camera was pointed straight down. The field of view of each photograph extended from horizon to horizon in the direction perpendicular to the flight path. At 50,000 ft, this provided a coverage of about 180 nmi to either side of the aircraft's flight path. In the direction of the flight path, the ground patch varied in width from about 7 mi directly under the plane to about 100 mi at the horizon. The photography rate provided continuous coverage along the flight path.

UNCLASSIFIED

WILLOW RUN LABORATORIES

E. Data Recording Procedures

A photograph was taken once every 32 sec.

II. Data

A. Data Published in Reports

Cloud photographs are presented with supporting data on meteorological conditions, ground contour, and aircraft location. The distributions of length, width, height, and spacing and of the relationships between these parameters are analyzed. The relationship of cloud size to total sky cover is computed. The variation of cloud appearance with the angle of view is considered. A graph presents the distribution of altitudes of tops of thunderstorms.

B. Data Not Published in Reports

Many more photographs have been taken than are presented in the reports.

REFERENCES

Unclassified

R. H. Blackmer, Jr., Statistical Distribution of Cumulus Clouds from U-2 Photographs, Technical Report No. 1, Stanford Research Institute, Menlo Park, California, November 1962.

R. H. Blackmer, Jr., and J. E. Alder, Statistics of Cumuliform Clouds from U-2 Photographs, Stanford Research Institute, Menlo Park, California, May 1963.

R. H. Blackmer, Jr., and S. M. Serebreny, Dimensions and Distributions of Cumulus Clouds as Shown by U-2 Photographs, Scientific Report No. 4, Stanford Research Institute, Menlo Park, California, July 1962.

S. M. Serebreny and R. H. Blackmer, Jr., An Investigation to Establish the True Nature of Cloud Cover, Scientific Report No. 2, Stanford Research Institute, Menlo Park, California, June 1961.

S. M. Serebreny and R. H. Blackmer, Jr., Patterns of Cloud Cover Shown by U-2 Photography, Scientific Report No. 3, Stanford Research Institute, Menlo Park, California, March 1962.

3.22. (U) A CLOUD MAP MADE WITH THE STEREONEPHOGRAPH

I. Instrument Description and Platform

A. General

The only data presented were taken on 19 May 1960 from an airplane at an altitude of 50,000 ft.

UNCLASSIFIED

UNCLASSIFIED

WILLOW RUN LABORATORIES

B. Instrumentation

A wide-angle camera took conventional cloud photographs, pairs of which were later processed by the stereonephograph to provide a three-dimensional cloud map.

C. Spectral Information

The instruments operated in the visible spectrum.

D. Spatial Information

The camera's field of view covered the region from the horizon to the nadir to the horizon in a direction perpendicular to the flight path of the aircraft.

E. Data Recording Procedures

The aerial photographs taken were later processed with the stereonephograph. This is a manual process in which an operator views the photographs through an optical device and then manipulates a stylus to produce the three-dimensional map.

II. Data

A. Data Published in Report

One cloud map made with the stereonephograph is presented.

B. Data Not Published in Report

More cloud maps were produced, but their availability is not indicated.

REFERENCE Unclassified

W. E. Howell, The Stereonephograph: A Device to Map Cloudscapes From Aerial Photographs, AFCRL TR 61-895, W. E. Howell Associates, Inc., Lexington, Mass., October 1961, AD 268 690.

3.23. (U) VANGUARD II SATELLITE

I. Instrument Description and Platform

A. General

Vanguard II was designed to record a crude picture of the earth's cloud cover in order to locate major storms. It was, in this sense, the first weather satellite. It was launched on 17 February 1959. The orbit of the satellite was not as planned; it went into a 2064- by 350-mi elliptical orbit rather than the intended 300-mi orbit (see the referenced article by Fritz). The effective life (battery life) of the satellite was two weeks.

UNCLASSIFIED

WILLOW RUN LABORATORIES

B. Instrumentation (cf. the referenced article by Hanel in "Electronics").

A dual radiometer was used; the two fields of view were diametrically opposed so that only one showed the earth at a given time. The radiometer employed PbS detectors, the outputs of which were connected so that a signal on the first increased the output while a signal on the second decreased the output. Also included in the instrumentation were a signal recorder, a command receiver, and a 1-W single-sideband transmitter at 108.3 Mc.

C. Spectral Information

The spectral response, governed by a filter, was 0.7 to 0.8 μ .

D. Spatial Information

The detector axis was at an angle of 45° to the spin axis; the field of view was 1.1°. The scan pattern, therefore, was a conical section subtended at the earth (straight down) by an annulus about 10 mi thick.

E. Data Recording Procedures

The data were collected by telemetry.

II. Data

Because of the deviation of the satellite from the planned orbit, it was not possible to view the scanned cloud pattern directly on an oscilloscope readout (see the referenced article by Fritz, p. 144). The quality and availability of the Vanguard II data were not indicated in the referenced material.

REFERENCES

Unclassified

S. Fritz, "On Observing the Atmosphere from Satellites, I: Cloud Observations," Weatherwise, August 1959, p. 139.

R. A. Hanel et al., An Earth Satellite Instrumentation for Cloud Measurements, U. S. Army Signal Engineering Laboratories, Ft. Monmouth, N. J., 1959.

R. A. Hanel et al., "The Satellite Vanguard II: Cloud Cover Experiment," IRE Trans. Military Electron., Vol. ME-4, 1960, pp. 245-247.

R. A. Hanel et al., "Tracking Earth's Weather," Electronics, Vol. 32, 1959, pp. 44-49.

UNCLASSIFIED

WILLOW RUN LABORATORIES

3.24. (U) INFRARED INTENSITY OF THE DAYLIGHT SKY: HUGHES AIRCRAFT COMPANY

I. Instrument Description and Platform

A. General

Measurements of the absolute radiance of the sky were taken from an A-26 aircraft at various altitudes up to 30,000 ft and at various aspect angles. Flights were made over California on 3 January 1947 and 3 April 1947 in the clearest possible weather conditions. The referenced report states that "this work is considered necessary as a basis for determining the minimum altitude above sea level at which a given spectral type star could be observed in the daylight by a particular optical and electronic system."

B. Instrumentation

The flux measurements were made with an RCA 921 infrared-sensitive gas photocell having an S-2 response. The optics for this consisted of a tube 2 in. in diameter with an objective lens of a focal length of 8.5 in. followed by a gelatin low-pass filter for removing the visible wavelengths.

Instrumentation on the second flight also included three broad-view, pinhole infrared cameras. The center camera looked to the zenith, while the two side cameras looked toward the horizon. These showed the character of the surrounding sky as well as a second method for obtaining absolute radiance values.

C. Spectral Information

The radiometer was sensitive from 0.74 μ to 1.05 μ .

D. Spatial Information

The orientation of the radiometer varied in azimuth according to the azimuth of the airplane and in zenith distance according to the setting of a manually operated mechanism. No periodic spatial scan was used.

E. Data Recording Procedures

The method of data collection was not given in the referenced report.

UNCLASSIFIED

WILLOW RUN LABORATORIES

II. Data

A. Data Analysis

The altitude and heading of the aircraft and the orientation of the radiometer were recorded. Complete correlation of related parameters was achieved by simultaneous recording.

The field of view of the radiometer was not given in the referenced report. The field of the center camera was 60° to either side of the zenith; the side cameras included the horizon to 10° past the zenith. The SNR was also not specified.

The system was periodically calibrated in flight with a small, low-voltage incandescent lamp. The lamp was calibrated by using two comparative methods described on p. 13 of the referenced report.

B. Prepared Data

The following are included in the referenced report:

- (1) Measured infrared flux vs. zenith distance at 90° to the left and 189° and 90° to the right of the sun azimuth. (See figures 3 through 6 of the referenced report.)
- (2) Infrared flux of the zenith vs. pressure (photoelectric units vs. 200 to 660 mm of mercury). (See figures 7 and 8 of the referenced report.)

REFERENCE Unclassified

C. C. Baum, Infrared Intensity of the Daylight Sky, Technical Memorandum 154, Hughes Aircraft Company, Electronics Department, Culver City, Calif., May 1947.

⁴ EARTH REFLECTANCE AND ALBEDO DETERMINATIONS Unclassified

4.1. (U) INTRODUCTION

Few experiments have been carried out at high altitudes in which reflectance or spectral reflectance was the directly measured quantity. The BIRA 01 and BIRA 02 (cf. sec. 3.16) ex-

UNCLASSIFIED

UNCLASSIFIED

WILLOW RUN LABORATORIES

periments initially were intended to provide reflectance data but were actually conducted to provide radiance values; the A. D. Little spectrometer (3.5) looked upward and downward, but the data were not suitable for a spectral-reflectance determination; the Royal Aircraft Establishment (RAE) measurements on clouds (3.17) were also absolute radiometric measurements in the first instance. The experiment done by Radiation, Inc., is the only work reviewed herein in which the instrument directly compared the incident and reflected radiance.

The albedo of an object or background is defined as its reflectance in the visible, i.e., its instantaneous spectral reflectance integrated over the visible wavelengths. The last two experiments discussed in this section involve this type of reflectance.

4.2. (U) A SPECTRAL REFLECTANCE STUDY OF TERRAIN: * U. R. BARNETT AND J. D. SIGLER

I. Instrument Description and Platform

A. General

The primary purpose of this program was to evaluate the Perkin-Elmer model 108 rapid-scan spectrometer for airborne use. A secondary objective, useful also in reaching the first objective, was to measure the earth's reflectance at various altitudes and over various terrains.

A Boeing 247-D aircraft was used. The program included earth-reflectance measurements in the visible and near infrared (0.4 to 3.0 μ) as a function of height up to approximately 20,000 ft over land and water and to approximately 13,000 ft over snow. Data were gathered between 2 February 1957 and 3 March 1957. All measurements were taken with the sun directly overhead. Land and water measurements were taken in Florida. Snow measurements were taken in Minnesota.

B. Instrumentation

A Perkin-Elmer model 108 rapid-scan spectrometer was used. This unit consisted of four main components: monochromator and detector, electronics, recorder, and power supply. The monochromator was a double-pass Littrow system. The collecting optics were interchangeable to provide a field of view of either 45°, 10°, or 3°. The detector was a 1P21 photomultiplier tube for the 0.3 to 0.5 μ region and a PbS photoresistive detector for the 0.5 to 2.5 μ region. A

*This work was sponsored by the Air Force Cambridge Research Center under Contract AF 19(604)-1917.

UNCLASSIFIED

WILLOW RUN LABORATORIES

thermistor detector was tried for longer wavelengths but was found to lack sufficient sensitivity.

Other instrumentation included a Dumont 304A oscilloscope and camera for the recording of data and a 35-mm camera which took pictures of the spectrometer's downward field of view.

C. Spectral Information

Spectral data were taken from 0.4 to 3 μ . This spectrum was scanned 15 times per second. The spectral resolution of the instrument was not given.

The spectrometer was spectrally calibrated with reference to known absorption bands of the atmosphere, a didymium filter, and a polystyrene sample.

D. Spatial Information

The spectrometer looked alternately straight up or straight down. The field of view was the entire upper or entire lower hemisphere, and the response to energy from a particular direction was proportional to the cosine of the zenith or nadir angle.

E. Data Recording Procedure

The spectrometer first looked up, and data were taken for about 20 successive spectral scans. The spectrometer then looked down for the same number of scans, usually less than 2 min after looking up.

The spectrometer output was displayed on an oscilloscope; this display was photographed on 35-mm film. Correlation to aircraft position and target-field characteristics (the sky and terrain below) was achieved by simultaneous recording of the detector's output, the airplane's altitude, and the photograph.

II. Data

A. Prepared Data

The following data were prepared and included in the final report:

(1) Graphs of spectral reflectance over land, water, and snow at various altitudes from 500 ft to 19,400 ft (percent reflectance vs. wavelength from 0.3 to 3.0 μ) (pp. 49-66 in the referenced report)

(2) Graphs of the spectral emission of terrain and sky (radiance in relative units vs. wavelength)

UNCLASSIFIED

UNCLASSIFIED

WILLOW RUN LABORATORIES

(3) Additional tables of similar data showing the results of several individual trials

B. Error Statements

A study of the spectral reflectance curves obtained showed that there was "considerable scatter" in the results. Distinct positive trends were found, however, and are discussed in detail on pages 25 and 31 in the referenced report. Numerical precision estimates were not given.

REFERENCE Unclassified

J. D. Sigler, Airborne Rapid Scan Spectrometer and Earth Reflectance Measurements as a Function of Altitude (Final Report), Radiation, Inc., Instrumentation Division, Orlando, Fla., July 1957.

4.3. (U) AN ALBEDO MEASUREMENT OBTAINED WITH A PYRHELIOMETER: SHACKLETON AND QUIRK

I. Instrument Description and Platform

A. General

In 1947, a contract* was negotiated between the University of Rhode Island and the Air Force Cambridge Research Laboratories (AFCLR), the primary purpose of which was the designing and building of an apparatus to determine the insolation at high altitudes using a rocket platform. In the initial phase, high-altitude balloons were used, and on two of the balloon flights, an albedo determination was made. The balloons were launched in 1954 during the daylight hours.

B. Instrumentation

The instrument used was a 50-junction Eppley global pyrliometer. In addition to this, two cameras photographed the terrain and clouds.

C. Spectral Information

No spectral information was given. The experiment was designed to measure the total radiation incident on the pyrliometer.

*U. S. Air Force Contract AF 19(122)-249.

UNCLASSIFIED

WILLOW RUN LABORATORIES

D. Spatial Information

The instrument was oriented downward and had a field of view that extended to the horizon in all directions.

E. Data Recording Procedure

A microammeter attached to the pyrheliometer was photographed every 30 sec during the flight.

II. Data

A. Prepared Data

The data were presented graphically in the referenced second scientific report.

B. Experimental Error

The data were submitted for qualitative use only.

REFERENCES Unclassified

H. R. Shackleton and A. L. Quirk, A Contribution to the Measurements of the Earth's Albedo, Scientific Report No. 3, Contract AF 19(122)-249, University of Rhode Island, Kingston, R. I., July 1955.

H. R. Shackleton and A. L. Quirk, Total Solar Radiation Measurements in the Upper Atmosphere by Balloon-Borne Pyrheliometers, Scientific Report No. 2, Contract AF 19(122)-249, University of Rhode Island, Kingston, R. I., June 1955.

4.4. (U) ULTRAVIOLET APPARENT REFLECTANCE AND ALBEDO OF THE EARTH FROM HIGH ALTITUDES: BAND AND BLOCK

I. Instrumentation and Platform

A. General

The AFCRL has conducted a series of measurements from X-15 rocket aircraft. The objectives of the work were to obtain spectral-irradiance data related to the earth's spectral reflectance and albedo and also to investigate radiation characteristics of the rocket exhaust plume.

The results discussed here are from several flights, one of which took place on 2 May 1963 over California and Nevada. The altitude of measurement was approximately 200,000 ft. Measurements were made in the ultraviolet only.

UNCLASSIFIED

UNCLASSIFIED

WILLOW RUN LABORATORIES

In general, the data yielded by this program were a medium volume of infrared, visible, and ultraviolet irradiance values obtained from high altitudes under clear daytime conditions and over desert terrain.

B. Instrumentation

A dual-channel Block* Ebert-type grating spectrometer was used. Details on this instrument and auxiliary instrumentation were not given by our references. Likewise, calibration information was not available for this writing.

C. Spectral Description

The instrumentation was capable of accepting radiation in the 0.24 to 2.7- μ band. Only the ultraviolet data have been processed, however. Spectral scanning was achieved by rocking the grating. The spectral resolution has not been given.

D. Spatial Information

The spectrometer looked to the rear from the aircraft with the optic axis depressed a fixed 30° from the aircraft's longitudinal axis. Spatial advance was, therefore, determined by the aircraft's motion. The field of view of the spectrometer was not given.

In the 2 May 1963 flight, the heading of the aircraft was 191° 48' during the data-taking portion of the flight. The altitude and azimuth angles were recorded every 2 sec. The sun angle was

$$\phi = 48^{\circ} 5' \pm 1^{\circ} \text{ (elevation)}$$

$$\psi = 109^{\circ} 54' \pm 1^{\circ} \text{ (azimuth)}$$

E. Data Acquisition

The irradiance data and the aircraft-position data were presumably both recorded aboard the aircraft and telemetered to the earth.

II. Data

A. Data Analysis

The primary data gave spectral irradiance as a function of aircraft position and attitude. The following considerations apply to the 2 May 1963 data:

*Block Engineering Company, Cambridge, Massachusetts.

UNCLASSIFIED

WILLOW RUN LABORATORIES

- (1) Data were recorded from $T = 80$ sec to $T = 280$ sec.
- (2) The scattering angle was computed at 2-sec intervals by computer.
- (3) Only the data on the ultraviolet were analyzed; the spectrum was partitioned with centers at 0.24μ , 0.26μ , and 0.28μ .
- (4) Apparent ground reflectance (A) and atmospheric optical density (T) were computed for 95 data points, resulting in 4465 (A, T) pairs. These were computed by using "applicable" scattering and attenuation laws. (See the reference.)
- (5) Atmospheric ozone absorption was evidently not fully accounted for in the calculations.

B. Prepared Data

Scatter diagrams of ground reflectance vs. atmospheric optical thickness at each wavelength are presented in the reference.

REFERENCE Unclassified

H. E. Band and L. C. Block, Spectral Reflectance and Albedo Measurements of the Earth from High Altitudes, Report No. 65-674, AFCRL, Bedford, Mass., September 1965.

5 HORIZON PROFILES Unclassified

5.1. (U) INTRODUCTION

The horizon may be roughly defined as the elevation angle at which the radiance from the earth-atmosphere interface seems to diminish or change in some specified way.

The elevation angle locating the horizon depends on the wavelength at which it is viewed and on synoptic conditions such as cloud cover or atmospheric temperature. Hence, the horizon may be specified by the wavelength utilized in the viewing process, but cannot be completely characterized in this way.

Exactly what criteria are used to specify the horizon's location depends upon the nature of the application. A general discussion of the several facets of horizon sensing and its applications appears in the referenced report.

The background radiance structure in the vicinity of the horizon has been the subject of several investigations in which the primary goal has been to arrive at horizon radiance data.

UNCLASSIFIED

UNCLASSIFIED

WILLOW RUN LABORATORIES

The remainder of section 5 is devoted to these. However, a number of other experiments have yielded horizon data in addition to the primary data. For example, horizon crossings were made in the Murcray (cf. secs. 3.2 and 3.3), Nimbus (3.12), T-BIRD (3.15), and BIRA (3.16) experiments, and the data from these are generally suitable for analysis with regard to structure of the horizon.

REFERENCE Unclassified

J. Born, J. Duncan, G. Oppel, and W. Wolfe, Infrared Horizon Sensors, Report No. 2389-80-T, Institute of Science and Technology, The University of Michigan, Ann Arbor, April 1965, AD 466 289.

5.2. (U) THE HORIZON AT 1.5 μ AND THE THERMAL REGION: D. G. MURCRAY AND OTHERS

I. Instrument Description and Platform

A. General

The "High Altitude Backgrounds Studies" series of radiometric measurements made from a balloon (see sec. 3.2) made use of a spatially scanning radiometer which included the horizon in its scan. Thus, a considerable portion of the infrared data from that program represented the radiance structure of the horizon as seen from 87,000 ft.

The analysis for horizon profile information has been carried out by the original investigators, D. G. Murcray and collaborators, of The University of Denver. The data used were from the balloon flights of 5 May 1959 and 8 May 1959.

B. Instrumentation

A modified Barnes R-8B1 radiometer was used.

C. Spectral Information

The radiometer employed a six-position filter wheel. Only the data from the 1.5 μ and thermal filters have been analyzed for horizon radiance, however. The transmission curves for these filters are given in figure 32.

D. Spatial Information

The spatial scan of the radiometer was such that the horizon was scanned at a rate of two crossings per minute. The azimuth angle was advanced so that an angle of 180° was covered in 5 min. The field of view of the radiometer was 0.5° by 0.5° square.

UNCLASSIFIED

WILLOW RUN LABORATORIES

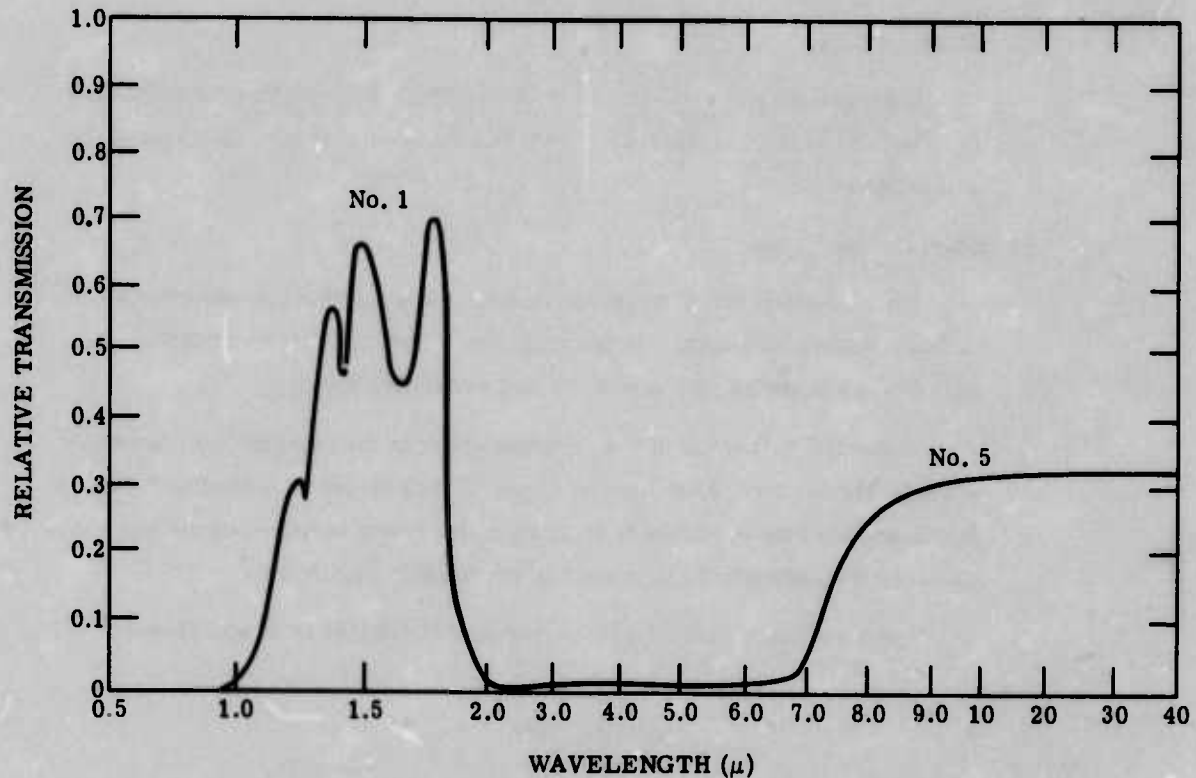

FIGURE 32. TRANSMISSION CURVES FOR INFRARED FILTERS 1 AND 5 OF THE RADIOMETER FILTER WHEEL USED IN STUDYING THE HORIZON AT 15 μ AND THE THERMAL REGION
Unclassified

E. Data Recording Procedure

The radiance, look-angle, and other ancillary data were stored on digital magnetic tape on the gondola. The sampling rate for the radiometer signal was 20 samples per second.

II. Data

A. Signal Processing and Data Reduction

(See section 3.2.)

B. Data Analysis

As mentioned above, the horizon data was subsidiary data from the complete "High Altitude Background Studies" program. The procedure followed in extracting and processing the horizon data has not been described in detail.

UNCLASSIFIED

UNCLASSIFIED

WILLOW RUN LABORATORIES

C. Prepared Data

Averaged plots of radiance vs. distance from the geometric horizon have been presented in the reference. Plots for each filter at various times of day are included.

D. Experimental Error

The significant error in the horizon data was the error in the determination of the elevation look angle. In the analysis, it was possible to discard data gathered while the balloon structure was oscillating heavily.

Numerical estimates of the probable error in the analyzed data were not stated. The location of the apparent horizon was therefore uncertain by an unknown combination of platform oscillation and actual variation of the horizon radiance with azimuthal angle and meteorological conditions.

The uncertainty in the radiance levels is estimated to be ± 25 percent.

REFERENCE Unclassified

D. G. Murcay and J. N. Brooks, Radiance of the Earth's Horizon as Viewed from 27 Kilometers, Denver Research Institute, University of Denver, Denver, Colo., 1959.

5.3. (U) THE HORIZON AT 6.25, 9.6, 10.8, AND 14.8 μ : PERSKY

I. Instrument Description and Platform

A. General

A single high-altitude balloon-borne experiment was conducted by M. J. Persky on 28 August 1963. The purpose of the experiment was to observe the horizon from outside the atmosphere. The project failed to fulfill its objective because the balloon burst before it reached peak altitude. Some data were produced, however, in the vicinity of 58,000 ft just before the balloon failure.

B. Instrumentation

An interferometer spectrometer was used. Other instrumentation included magnetic aspect sensors and a 16-mm camera boresighted with the spectrometer.

UNCLASSIFIED

WILLOW RUN LABORATORIES

C. Spectral Information

Radiance was measured at 6.25, 9.6, 10.8, and 14.8 μ . Spectral resolution was 20 cm^{-1} .

D. Spatial Information

The instrument scanned across the horizon.

E. Data Recording Procedure

Data were telemetered to a receiving station on the ground.

II. Data

A graph of absolute radiance as a function of elevation angle (-7° to $+7^{\circ}$) in each of the four spectral regions is given in the Persky report. These data were taken at a 58,000 ft altitude, just before the balloon burst.

REFERENCE Unclassified

M. J. Persky, Infrared Horizon Studies, AFCRL-64-210, Block Engineering, Inc., Cambridge, Mass., December 1963.

5.4. (U) MEASUREMENT OF 15- μ HORIZON RADIANCE FROM A SATELLITE: EASTMAN KODAK COMPANY

I. Instrument Description and Platform

A. General

The 15- μ horizon radiance was measured on a global basis in early December 1962 when data were successfully retrieved from a satellite-borne radiometer system designed by the Eastman Kodak Company. The data from 45 orbits were reduced, analyzed, and compared with theoretical calculations based upon an available model of the atmosphere.

B. Instrumentation

Two similar radiometers were used, both dual-channel units capable of accepting radiation in two wavelength channels slightly separated spatially. (See fig. 33.) The detectors were 0.2- by 2-mm thermistor bolometers. The filters

UNCLASSIFIED

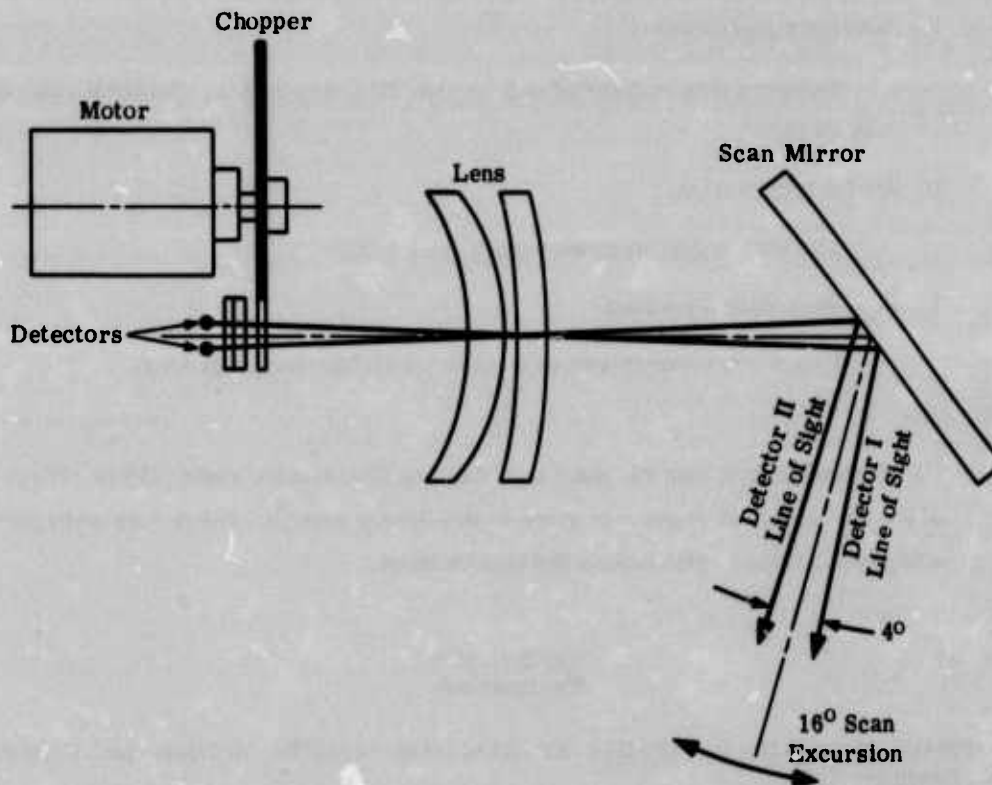

FIGURE 33. OPTICAL SYSTEM OF THE EASTMAN KODAK RADIOMETER
Unclassified

were placed in the entrance aperture as illustrated. The chopping speed was 130 Hz.

The radiometers were calibrated by scanning a blackened copper target and determining the output as a function of target temperature. The responsivity of each channel was then found by multiplying the appropriate spectral transmittance function by the target emission, assumed to be that of a greybody of emissivity equal to 0.83.

C. Spectral Information

All four channels had passbands centered near 15μ . The side-looking radiometer had a 14.0 - to 15.2 - μ (1 - μ width) response in one channel and a 13.7 - to 15.6 - μ (2 - μ width) response in the other. The forward-looking radiometer had responses from 13.7 - to 15.6 - μ (same 2 - μ width) and from 13.6 - to 16.5 - μ (3 - μ width) in its two channels. System-spectral-response curves for the three filters used are shown in figure 34.

UNCLASSIFIED

WILLOW RUN LABORATORIES

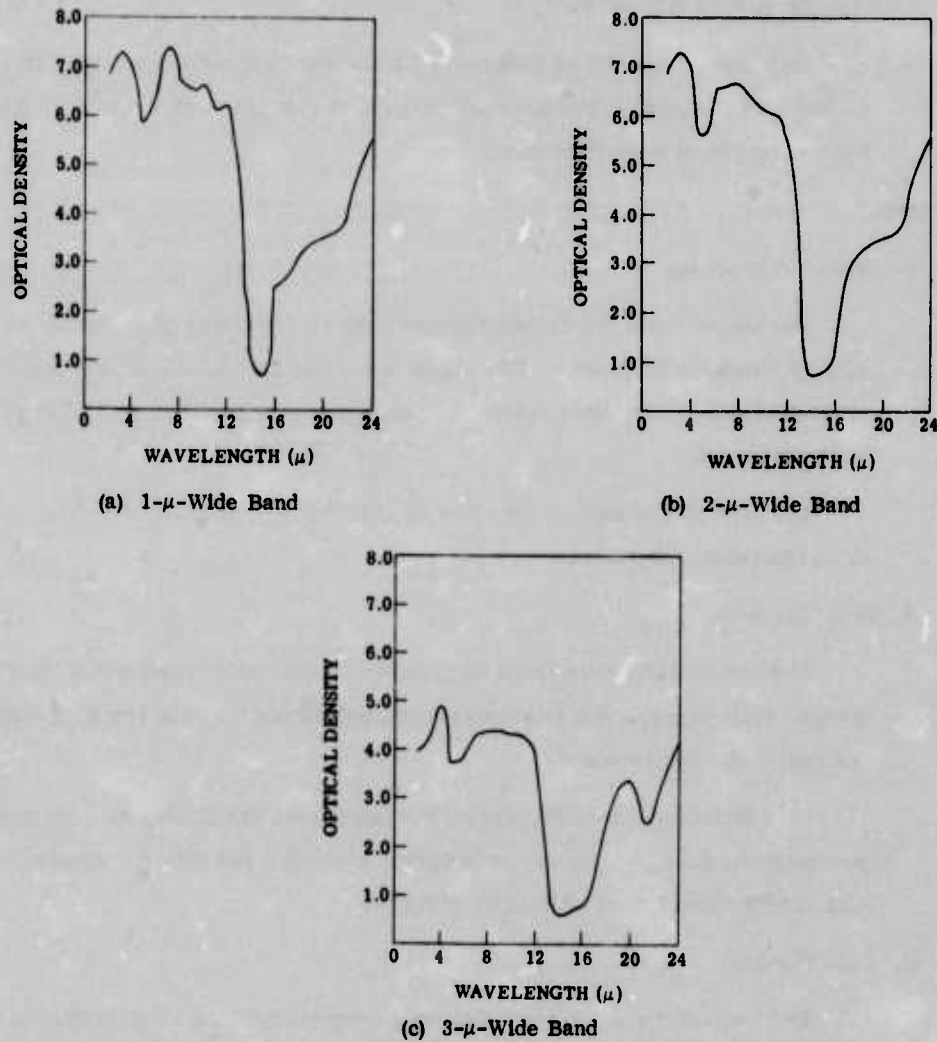

FIGURE 34. SPECTRAL-RESPONSE CURVES FOR THREE FILTERS IN THE KODAK SATELLITE
Unclassified

D. Spatial Information

The satellite was evidently stabilized in orbit. One radiometer looked forward to the horizon; the other looked out the side to the horizon.

The field of view of the radiometers (each channel) was 0.2° perpendicular to the horizon and 2° parallel to the horizon.

The radiometers scanned linearly, perpendicular to the horizon, and over a total of 16° . Scanning rate was $2.5^\circ/\text{sec}$.

UNCLASSIFIED

UNCLASSIFIED

WILLOW RUN LABORATORIES

E. Data Recording Procedure

Data were acquired by telemetry. Data were recorded on a tape recorder on the satellite and played back during ground contact so that radiance data from the entire orbits were retrieved.

II. Data

A. Signal Processing

The output from the detector preamplifiers consisted of a carrier at the 130-Hz chopping frequency. The signal was amplified by an automatically programmed gain-switching amplifier. The signal was rectified and filtered before being recorded.

The effective sampling rate was 48, 128, or 147 samples per scan, depending upon the radiometer channel.

B. Data Analysis

The radiometric data from 45 ground contacts were received by Eastman Kodak. Half of these had been decommutated directly by the tracking station; the rest were left in raw form.

Data reduction involved reading voltages from the analog records and key punching the data onto cards. A program analyzing the data for radiance values was then written for an IBM 1620 computer.

C. Data Format

The raw data were recorded on an analog strip chart. As mentioned above, half of this was decommutated and half was not. A portion of the data was punched on cards compatible with the IBM 1620 computer. Data prepared by Eastman Kodak have been published in the form of graphs.

D. Prepared Data (cf. the referenced report)

Graphs present the radiant emittance as a function of latitude (65°N to 65°S) for each of the four channels. Each point on these graphs represents the mean value for 12 to 20 samples. Values of average radiant emittance for passes during the day and the night are tabulated for each of the four channels. A graph illustrates the horizon profile in terms of relative radiance vs. elevation angle.

UNCLASSIFIED

WILLOW RUN LABORATORIES

E. Error Statements

The SNR was approximately 10:1 except during certain periods of low signal.

One of the radiometers suffered from electronic interference for which compensation is necessary (cf. p. 42 of the referenced report).

REFERENCE Unclassified

J. Collinge and W. Haynie, Measurement of 15-Micron Horizon Radiance From a Satellite, Report No. EK/ARD ED-995, Eastman Kodak Company, Apparatus and Optical Division, Rochester, N. Y., March 1963, AD 437 804.

5.5. (U) THE TERRESTRIAL NIGHT HORIZON AND SKY AT 4.3 μ : HITAB-TRIS ROCKET PROBES

I. Instrument Description and Platform

A. General

The TRIS series of rocket probes is another in the HITAB program of ARPA. The TRIS mission was not primarily intended to obtain information on background radiance (see sec. 3.16). However, radiance data suitable for qualitative analysis were obtained and have been reduced for this purpose by personnel of the Naval Ordnance Test Station at China Lake, California.

Several vehicles in the TRIS series have been launched; five of these returned valid background data. Three of these launchings were at night, and the vehicles were instrumented to measure radiance in the 4.3- μ band.

<u>Flight Designation</u>	<u>Launching Site</u>	<u>Date</u>
TRIS-06	Atlantic Missile Range	2 April 1963
TRIS-08	Atlantic Missile Range	28 May 1963
TRIS-11	Pacific Missile Range	24 August 1963

The data from these have been analyzed and related to the altitude distribution of temperature, density and emittance of the atmosphere and horizon at 4.3 μ . In particular, the radiance profile of the horizon was investigated on the basis of the data.

B. Instrumentation

The TRIS instrumentation included infrared radiometers peaked at 2.2, 2.7, and 4.3 μ and an ultraviolet radiometer at 2700 Å. Details concerning the radiom-

UNCLASSIFIED

UNCLASSIFIED

WILLOW RUN LABORATORIES

eters appear in the referenced report by Wilkins. Only the 4.3- μ radiometer is pertinent to this review.

Amplitude calibration of the radiometer was achieved by irradiating the aperture with radiation projected from a blackbody source through an off-axis paraboloid mirror. To complete this calibration, the field-of-view response function was determined.

C. Spectral Description

The system spectral response for the 4.3- μ radiometer is shown in figure 35. Spectral calibration was done at NOTS facilities with an uncertainty in wavelength of 0.002 μ .

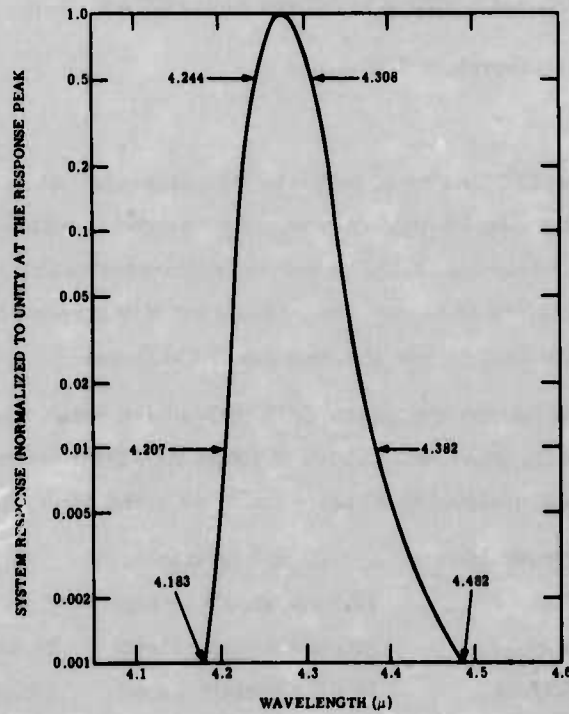

FIGURE 35. TYPICAL SYSTEM SPECTRAL RESPONSE FOR A TRIS 4.3- μ RADIOMETER. Wilkins and Hoyem; the response curve actually plotted is for the TRIS-08 experiment.
Unclassified

D. Spatial Information

The spatial scan was provided by the combined spin and forward motion of the rocket. The radiometers looked straight out the side of the rocket.

UNCLASSIFIED

UNCLASSIFIED

WILLOW RUN LABORATORIES

The field of view of the radiometer was 5° by 5° . As mentioned above, the structure of the field of view was also measured.

E. Data Acquisition

The data were recorded by telemetry. This will not be described here.

II. Data

A. Data Analysis

The radiance data were analyzed with respect to a model of the CO_2 atmosphere in which the major $4.3\text{-}\mu$ CO_2 emission occurs in a well-defined layer around an altitude of 40 km. The opacity, effective altitude, and blackbody temperature of such a surface were then derived from the data.

B. Prepared Data

The following graphs were prepared.

- (1) The $4.3\text{-}\mu$ nighttime horizon-radiance profile
- (2) Radiance as a function of altitude
- (3) Angular separation of the limits of the horizon as a function of altitude
- (4) Temperature at which CO_2 radiates as a blackbody vs. altitude
- (5) CO_2 $4.3\text{-}\mu$ emittance vs. altitude

The qualitative nature of the data analysis has been stressed. A probable error of ± 50 percent can be applied to the radiance values.

REFERENCE Unclassified

G. A. Wilkins and J. A. Hoyem, The Terrestrial Night Horizon and Sky, TP3578, NOTS, China Lake, Calif., AD 446 436.

5.6. (U) INFRARED HORIZON MEASUREMENTS FROM A NEAR-ORBITING ROCKET PROBE:
R. ANTHONY AND V. N. SMILEY

I. Instrument Description and Platform

A. General

The platform was an Atlas missile from which data were collected at altitudes ranging from 250,000 to 790,000 ft.

UNCLASSIFIED

UNCLASSIFIED

WILLOW RUN LABORATORIES

B. Instrumentation

The radiometer used a liquid-nitrogen-cooled PbSe detector. The detectivity (D^*) of these detectors is given and shows a long wavelength cutoff around 6.5μ . A 5-in. Cassegrainian telescope was used in the optics for the system.

C. Spectral Information

Moderately narrowband filters were used in the 2.7-, 3.5-, 4.3-, 4.7-, and $6.3\text{-}\mu$ bands. Spectral transmission curves for these filters are shown in figure 36.

D. Spatial Information

The radiometer's field of view was 0.21° (circular) with a 10° vertical reciprocating scan that crossed the horizon. Response over the field of view is given in figure 37.

E. Data Recording Procedures

Data were collected by telemetry.

II. Data

A. Data Published in Report

Samples of the telemetry record in the different spectral regions are presented to show the horizon discontinuities. One graph shows a comparison of the smoothed horizon gradients in the 4.3- and $4.7\text{-}\mu$ regions.

III. Data Reliability

The data are mainly of qualitative interest as the signal was very noisy and the precise relationship of the optic axis to the geometric horizon is not known.

REFERENCES

Unclassified

- R. Anthony and V. N. Smiley, Infrared Horizon Measurements from Near-Orbiting Altitudes, AFCRL 62-1001, General Dynamics/Astronautics, San Diego, Calif., August 1962, AD 288 648.
- V. N. Smiley, Rocket-Borne IR Scanning Radiometer for High Altitude Radiation Measurements, AFCRL 62-431, General Dynamics/Astronautics, San Diego, Calif., April 1962.

UNCLASSIFIED

WILLOW RUN LABORATORIES

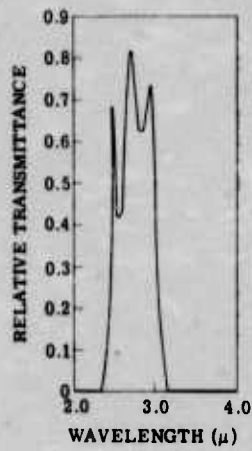

(a) Filter 1

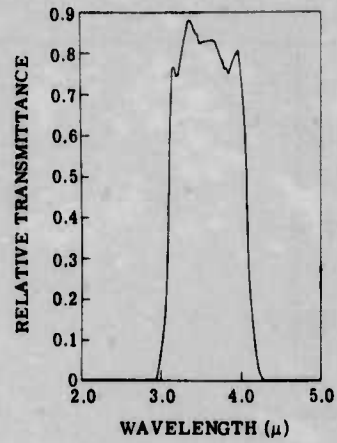

(b) Filter 2

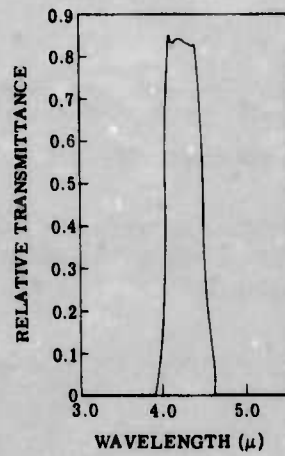

(c) Filter 3

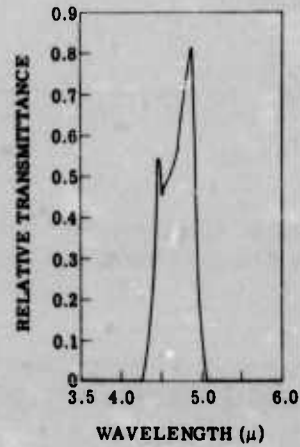

(d) Filter 4

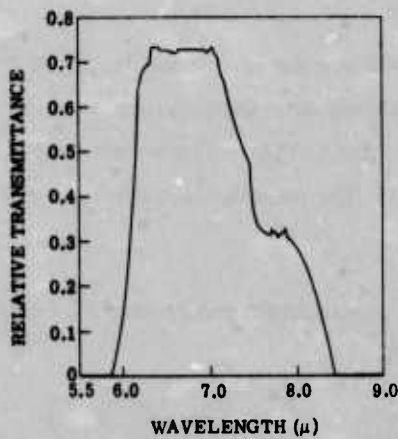

(e) Filter 5

FIGURE 36. SPECTRAL TRANSMISSION CURVES OF FILTERS USED IN INFRARED-HORIZON MEASUREMENTS VS. WAVELENGTH. Anthony and Smiley, 1962.
Unclassified

UNCLASSIFIED

UNCLASSIFIED

WILLOW RUN LABORATORIES

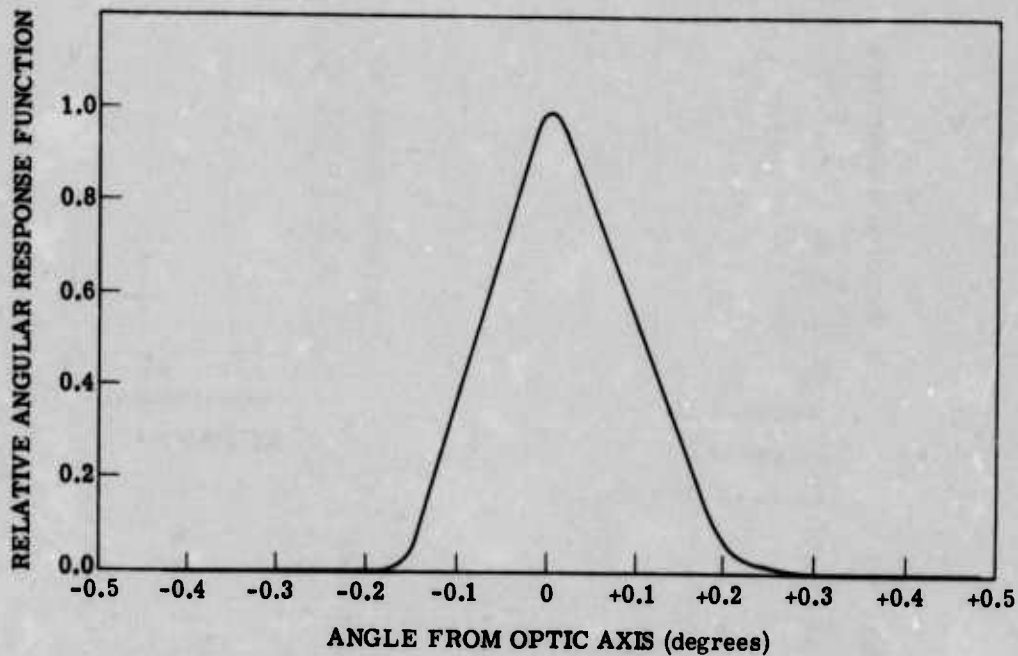

FIGURE 37. THE RELATIVE ANGULAR RESPONSE FUNCTION OF THE OPTICS-DETECTOR SYSTEM USED IN INFRARED-HORIZON MEASUREMENTS VS. THE ANGLE FROM THE OPTICAL AXIS. Anthony and Smiley, 1962.
Unclassified

5.7. (U) THE ULTRAVIOLET, VISIBLE, AND INFRARED HORIZON FROM A ROCKET PROBE: LANGLEY RESEARCH CENTER

I. Instrument Description and Platform

A. General

The platform was a Javelin rocket launched from Wallop's Island, Virginia. High-resolution radiometric measurements of the horizon were made from altitudes between 300 and 610 km. The rocket was launched on 17 November 1961, at 11:06 a.m. EST. The direction of flight was due east.

B. Instrumentation

A four-channel compound radiometer was used. Its characteristics are given by table VII.

C. Spectral Information

Exact spectral curves were not given.

UNCLASSIFIED

WILLOW RUN LABORATORIES

TABLE VII. CHARACTERISTICS OF THE FOUR-CHANNEL COMPOUND RADIOMETER
USED IN THE LANGLEY RESEARCH CENTER ROCKET PROBE

	Channel 1	Unclassified Channel 2	Channel 3	Channel 4
Band	0.23 μ to 0.29 μ	0.29 μ to 1.0 μ	0.75 μ to 3.0 μ	1.8 μ to 25 μ
Focal length	25.4 cm	25.4 cm	25.4 cm	7.60 cm
Aperture	7.60-cm diameter	7.60-cm diameter	7.60-cm diameter	7.60-cm diameter
Detector	Photomultiplier	PbS, 1 mm by 1 mm	PbS, 1 mm by 1 mm	Thermistor bolometer 1 mm by 1 mm
Filter	Composite	Standard color filter	Standard color filter	1-mm germanium filter
Field of view	0.22 ^o by 0.22 ^o	0.22 ^o by 0.22 ^o	0.22 ^o by 0.22 ^o	0.75 ^o by 0.75 ^o

D. Spatial Information

The optic axis of the radiometer was at 65^o with respect to the rear of the rocket. The vehicle's spin rate decreased from 400 rpm to 300 rpm during flight (rather than the intended, constant 40-rpm spin).

The attitude of the rocket was nearly horizontal during the time of observation. The altitude of the rocket was determined by radar.

E. Data Recording Procedure

Data were collected by a standard FM-FM telemetry system.

II. Data

Sample telemetry readouts contrasting the responses of the four channels during the horizon crossing are presented in the referenced report. The probability distributions of radiance values for the horizon were also prepared. Such graphs were made for each of the four spectral ranges.

The precision of a single measurement was felt to be about ± 30 percent.

REFERENCE Unclassified

J. B. McKee et al., Radiometric Observations of the Earth's Horizon from Altitudes Between 300 and 600 Kilometers, NASA TN D-2528, Langley Research Center, Hampton, Virginia, December 1964, AD 203 575.

UNCLASSIFIED

UNCLASSIFIED

WILLOW RUN LABORATORIES

5.8. (U) THE TOTAL INFRARED-FLUX HORIZON: OVREBO AND BEARDSLEY

I. Instrument Description and Platform

A. General

B-17 aircraft were used for this experiment at altitudes up to 22,000 ft. All data presented were taken between March 1949 and April 1950.

B. Instrumentation

A radiometer which employed a thermocouple detector was used.

C. Spectral Information

The bandwidth was evidently limited only by the response of the thermocouple so that radiation was measured over a very wide infrared spectral region.

D. Spatial Information

The field of view is not given but was evidently quite narrow in the direction perpendicular to the horizon. The radiometer scanned from 5° below the horizon to 20° above the horizon.

E. Data Recording Procedures

None were stated.

II. Data

Graphs present the relative radiation as a function of zenith angle for several altitudes. Date, time, and temperature are given as ancillary information. Some information on the cloud cover is also given.

REFERENCE Unclassified

P. J. Ovrebo and N. F. Beardsley, Observations of the Variations of the Total Infrared Radiation from the Sky Near the Horizon, Report No. 6578, Aircraft Radiation Laboratory, Wright Air Development Center, Dayton, O., December 1951, AD 158 422.

5.9. (U) THE FLUX GRADIENT OF THE HORIZON: BIEBER AND CLARK

I. Instrument Description and Platform

A. General

A B-29 aircraft was used in measurements of the infrared radiance gradient of the horizon. Flights were made at altitudes from 2200 to 30,000 ft. Two flights were carried out in daylight and one at night, beginning on 22 April 1949.

UNCLASSIFIED

WILLOW RUN LABORATORIES

B. Instrumentation

A radiometer was used for the measurements. This employed an $f/0.67$, 3-in.-diameter catadioptric optical system of the mirror-meniscus type. The detector was a double thermopile, so arranged that its output was related to the spatial flux gradient of the field viewed. A system sensitivity of $0.2 \text{ V}/\mu\text{W}$ was achieved.

The entire system was calibrated by placing a black water tank of variable temperature in the field of view of the radiometer. In flight, a calibrating voltage was switched in with the chopped thermopile signal to compensate for variations in system gain.

C. Spectral Information

A filter was used to block radiation with wavelengths shorter than 3μ . The transmission curve for this filter is shown in figure 38.

D. Spatial Information

The field of view of each thermopile was 0.75° vertically by 3° horizontally. There was a 0.75° vertical spacing between the two fields of view. The device scanned vertically through a total angle of 16.5° at a rate of 20 scans per minute.

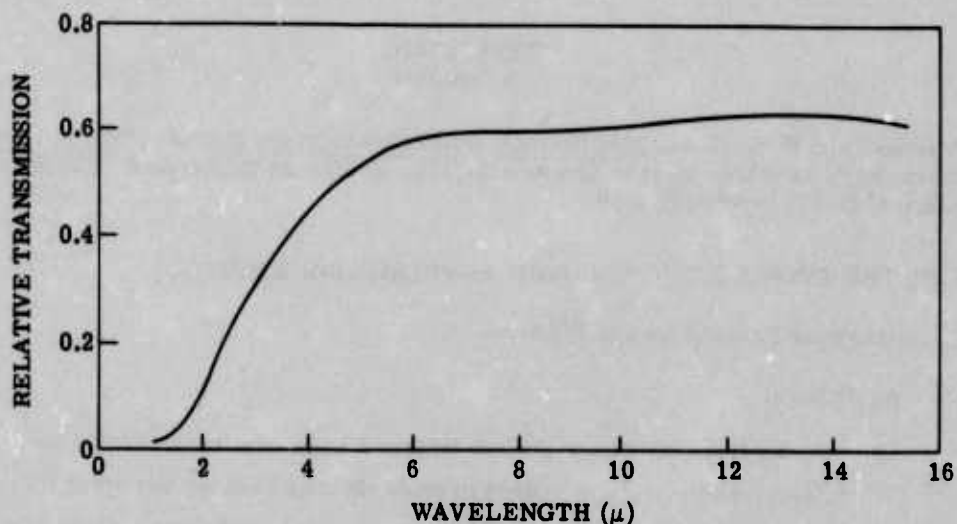

FIGURE 38. FILTER TRANSMISSION CURVE FROM FLUX-GRADIENT MEASUREMENTS.
Bieber and Clark, 1963.
Unclassified

UNCLASSIFIED

UNCLASSIFIED

WILLOW RUN LABORATORIES

E. Data Recording Procedure

The signal from the detector system was amplified by a low-noise chopper amplifier and recorded on board by a Brush two-channel recorder.

The following parameters were recorded in flight

- (1) Absolute radiance received from sky and land background
- (2) Thermal gradient of the field
- (3) Ambient temperature of the thermopile
- (4) Cloud cover and other meteorological conditions
- (5) Sun angle
- (6) Time
- (7) Altitude of aircraft
- (8) Heading of aircraft

II. Data

Graphs of relative radiance vs. elevation angle were prepared and are included in the report. Similar graphs of thermal gradient vs. elevation angle (apparent radiation temperature or temperature gradient vs. degrees from the horizon) are also given. Also, a graph showing the dependence of error in horizon location upon the spatial resolution of the radiometer is included.

REFERENCE Unclassified

C. F. Bieber and H. L. Clark, The Thermal Discontinuity at the Horizon Observed from High Altitudes, Navy Research Section, Science Division, Reference Department, Library of Congress, Washington, D. C., September 1963.

5.10. (U) THE PHOTOMETRIC HORIZON: HOFFLEIT AND BECHTOL

I. Instrument Description and Platform

A. General

A series of 14 high-altitude balloon flights have been carried out in which infrared photography was used to study the nature of the horizon with respect to observation altitude, land mass, meteorological conditions, and, in particular, azimuth variation at peak altitude. The measurements were made over the White Sands Proving Ground from 1953 through 1955.

UNCLASSIFIED

WILLOW RUN LABORATORIES

B. Instrumentation

The primary instrument was a custom-built horizon camera which used eight lenses to photograph the horizon simultaneously in eight spaced azimuthal directions. The camera took approximately ten pictures per hour.

The camera was calibrated sensitometrically, i.e., the relation between input irradiance and film exposure density was found. This was done in the laboratory with a custom-built source employing an aged 100-W lamp. In this way, the relation between input irradiance and exposure density was found in several steps covering the range of expected intensities.

C. Spectral Information

Eastman Kodak high-speed infrared film, which has a peak sensitivity at 0.80μ , was used in the camera. A Wratten 89 B filter was used to remove visual wavelengths completely.

D. Spatial Information

The frame size of each of the eight pictures was 3 in. by 3 in., and the size of the field of view was 33° by 33° .

E. Data Recording Procedures

Photographic data were obtained from the balloon's gondola after it was parachuted to the ground.

II. Data

A. Data Reduction

In order to study the variations in sky brightness near the horizon, microdensitometer tracings were made along strips of film perpendicular to the image of the horizon. Such tracings were made for flights 1, 5A, 5B, 6B, 7A, and 7B.

In addition, where a complete sequence of frames occurred in such a way that 360° of azimuth were covered in a short time, it was possible to construct lines of constant sky brightness (isophotes) along the apparent horizon.

B. Prepared Data

The reduced data listed below, which were prepared as described above, appear in the Hoffleit report referenced:

UNCLASSIFIED

UNCLASSIFIED

WILLOW RUN LABORATORIES

- (1) Graphs of sky-intensity amplitude vs. camera number (azimuth angle) (pp. 82 and 83)
- (2) Graphs of intensity gradient vs. camera number (azimuth angle) (pp. 84 through 86)
- (3) Graphs of elevation of lines of constant sky intensity as a function of azimuth angle (pp. 87 through 89)

No such data were presented in the Bechtol report.

C. Experimental Error

The data indicated an achieved capability of locating the horizon to an uncertainty not exceeding $\pm 0.10^\circ$.

REFERENCES Unclassified

T. R. Bechtol, An Optical Method for Studying the Earth's Haze Horizon from High Altitudes, Memo. No. 1163, Ballistic Research Laboratories, Aberdeen Proving Ground, Md., August 1953.

D. Hoffleit, A Study of Photometric Horizons Photographed from High Altitude Balloons, Memo. No. 1164, Ballistic Research Laboratories, Aberdeen Proving Ground, Md., August 1958.

6

ATMOSPHERIC FLUX MEASUREMENTS

Unclassified

6.1. (U) INTRODUCTION

A substantial number of infrared background experiments have been concerned with the net flux of radiation emanating from the earth and atmosphere. Those have not dealt with spatial structure. Therefore, the data involved are essentially irradiance data.

Both radiometric and spectrometric flux measurements have been made. All have been in the infrared except for the visible flux measurements by Boileau (sec. 6.8).

6.2. (U) THE SPECTRAL FLUX OF THE ATMOSPHERE AT NIGHT: JOHN STRONG AND R. C. WHITE

I. Instrument Description and Platform

A. General

The net upward infrared spectral flux and flux gradient were measured in a series of nighttime balloon-borne experiments carried out under the auspices of the Johns Hopkins University for the Air Force Cambridge Research Center.

UNCLASSIFIED

WILLOW RUN LABORATORIES

Nine balloons were launched near Holloman Air Force Base, New Mexico, between 4 October 1956 and 21 August 1961. The maximum altitude was 100,000 ft.

B. Instrumentation

An Ebert-type grating spectrometer was used. The detector was a 1-mm by 5-mm thermopile.

Two blackbodies, one kept at the temperature of dry ice (to be called "dry") and the other at the temperature of melting ice (to be called "wet") were used for calibration.

C. Spectral Information

Spectral resolution was around 0.1μ at 10μ . In all flights except the first, filtering was used to separate the first-, second-, and third-order spectra. The spectral region covered was from 6.3 to 30μ , although individual flights did not cover this whole range.

D. Spatial Information

On the first flight, the spectrometer looked straight down, and incoming radiation was chopped by a mica chopper. On all succeeding flights, chopping action was such that the spectrometer looked alternately up, then down, then at the wet, and then at the dry blackbodies (not necessarily in this sequence, however). The spectrometer looked up and down at elevation angles of $\pm 60^\circ$.

E. Data Recording Procedures

On all flights, data were recorded on photographic film. This film showed the amplitude of oscillation of a galvanometer; this amplitude was proportional to the chopped radiance difference.

II. Data

On the first flight, two spectra were obtained, but, since no filtering was done, it was difficult to separate the first-, second-, and third-order spectra (cf. reference of 1 October 1957).

From the 26 November and 10 December flights, the following data are presented:

- (1) Table of differential (up minus down) spectral radiance from 8 to 26μ
- (2) Several differential spectra that show galvanometer deflection vs. wavelength.

UNCLASSIFIED

UNCLASSIFIED

WILLOW RUN LABORATORIES

- (3) Plots, at specific wavelengths from 9 to 23.2 μ , with the altitude as the abscissa and the ratio of the differential spectral radiance as a function of altitude as the ordinate (cf. reference of 7 October 1958).

From the two 6 March 1959 and the 29 April 1959 flights, the following data are presented:

- (1) Tables showing the differential radiant emittance over several wavelength intervals as a function of altitude
- (2) Several spectra showing galvanometer deflection as a function of wavelength
- (3) Graphs of differential radiant emittance vs. altitude in several spectral intervals

The 6 May 1959 flight was a failure (cf. reference of 15 October 1959).

From the 8 March 1960 balloon flight, graphs are shown of differential radiant emittance in several spectral intervals as a function of altitude (cf. reference of 1 February 1961).

From the 21 August 1961 flight, the following data are presented:

- (1) All raw data in the form of the original photographic record
- (2) Typical spectra showing wavelength vs. galvanometer deflection
- (3) Graphs for specific altitudes showing differential spectral radiant emittance of blackbodies (wet minus up and wet minus down) from 8 to 24 μ
- (4) Differential radiant emittance in consecutive 1- μ wavelength intervals as a function of altitude (cf. references of August 1961 and 19 April 1963)

REFERENCES Unclassified

J. Strong, Balloon Observations of Earth Radiations in the Infrared, AFCRC TR-57-238, Johns Hopkins University, Laboratory of Astrophysics and Physical Meteorology, Baltimore, Md., October 1957, AD 133 847.

J. Strong, Balloon Observations of Earth Radiations in the Infrared - II, AFCRC TN-58-608, Johns Hopkins University, Laboratory of Astrophysics and Physical Meteorology, Baltimore, Md., October 1958.

J. Strong, Balloon Observations of Earth Radiations in the Infrared - III, AFCRC TN-59-294, Johns Hopkins University, Laboratory of Astrophysics and Physical Meteorology, Baltimore, Md., October 1959.

R. C. White, Measurement of Infrared Spectral Components Flowing Upward and Downward in the Atmosphere, AFCRL 63-495, Johns Hopkins University, Laboratory of Astrophysics and Physical Meteorology, Baltimore, Md., April 1963, AD 409 690.

UNCLASSIFIED

WILLOW RUN LABORATORIES

R. C. White, Report on Raw Data of the Balloon Flight of August 21, 22, 1961, Johns Hopkins University, Laboratory of Astrophysics and Physical Meteorology, Baltimore, Md., August 1961, AD 266 948.

R. C. White and J. Strong, Sky Radiations from the Balloon Flight of March 8, 1960, AFCRL-450, Johns Hopkins University, Laboratory of Astrophysics and Physical Meteorology, Baltimore, Md., February 1961.

6.3. (U) THE ATMOSPHERIC INFRARED SPECTRAL FLUX: PERSKY

I. Instrument Description and Platform

A. General

High-altitude balloons were used to measure upward and downward infrared spectral flux at various altitudes. Flights were conducted on 5 April 1962 at 3:48 a.m. MST and 2 August 1962 at 1:27 a.m. MST from Holloman Air Force Base, New Mexico.

From the standpoint of instrument design, these experiments were particularly valuable in that the performance of three different spectrometers was compared in the course of the measurements.

B. Instrumentation

On the first flight (5 April 1962), a Block Associates I-4T interferometer spectrometer and a Perkin-Elmer (P.E.) Model 21 spectrometer were used; on the second flight (2 August 1962), Block Associates I-4T and I-4TC spectrometers were used. Thermistor bolometer detectors were used throughout.

The I-4T was calibrated by comparing its signal at the frequency in question (provided by a monochromatic source) with that of a Golay pneumatic detector that was not wavelength selective. The absorption bands of polystyrene were used to obtain the wavelength vs. frequency calibration, and the spectral response determination was then done by an independent firm. This determination was later compared with a spectral response calibration carried out at the University of Denver. In-flight calibration was also carried out. A small reference black-body was used.

C. Spectral Information

The I-4T interferometer scanned the spectrum from 5 to 15 μ while the I-4TC covered the spectrum from 9 to 40 μ . The effective time taken to scan the spectrum was 12 sec; the spectral resolution was in the neighborhood of 40 cm^{-1} .

UNCLASSIFIED

UNCLASSIFIED

WILLOW RUN LABORATORIES

D. Spatial Information

On the first flight, the instruments both looked to the nadir. On the second flight, the I-4T looked alternately at the nadir and at a zenith distance of 30° while the I-4TC looked continuously at the nadir.

The respective fields of view were as follows:

I-4T	15°	conical
I-4TC	15°	conical
P.E. 21	7°	conical

Figure 39 gives the exact field-of-view response for the I-4T.

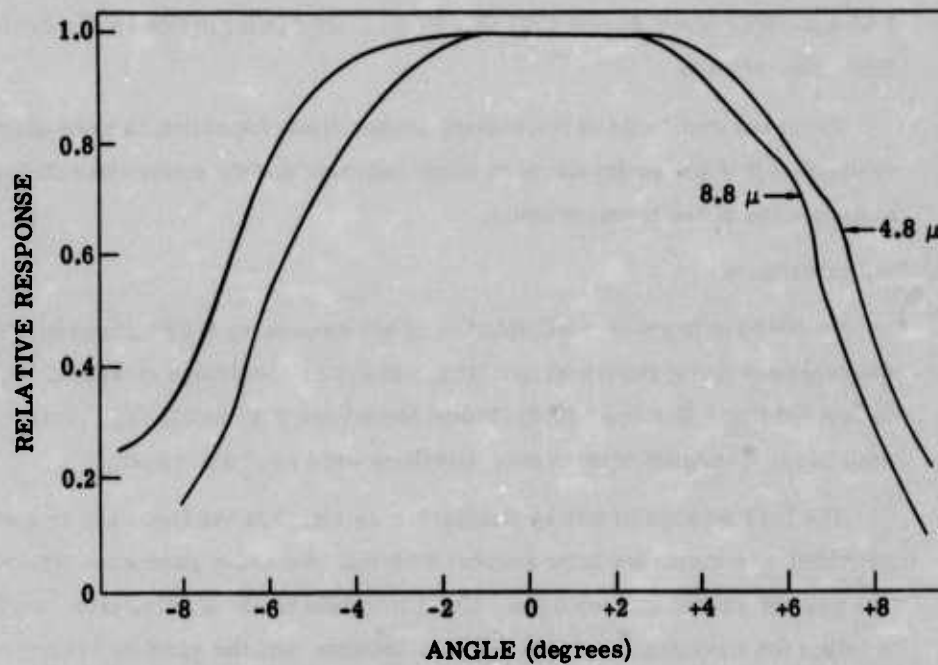

FIGURE 39. FIELD OF VIEW OF THE I-4T INTERFEROMETER SPECTROMETER
Unclassified

E. Data Recording Procedure

All measurements were monitored continuously by a ten-channel air force FM/FM telemetry unit. The interferograms from the interferometers were recorded on a Magnecord 728 tape recorder for further processing.

UNCLASSIFIED

WILLOW RUN LABORATORIES

II. Data

The output from the data reduction program was upward and downward spectral radiance as a function of altitude. The data have been presented graphically in the Persky report.

REFERENCE Unclassified

M. J. Persky, Atmospheric Infrared Optics-Flux Measurements, AFCRL 63-439, Block Associates, Inc., Cambridge, Mass., May 1963, AD 411 820.

6.4. (U) RADIOSONDE MEASUREMENTS AT THULE, GREENLAND: FENN AND WEICKMANN

I. Instrument Description and Platform

A. General

Two radiosonde flights were made at night on 14 and 15 February 1959 at Thule, Greenland. Data were recorded up to about 33 km on the first flight and 18 km on the second flight.

B. Instrumentation

The instrument consisted of two pairs of horizontally orientated, blackened plates whose temperatures were monitored by thermistors; two of the plates faced upward and two faced downward. Other instruments measured temperature, pressure, and humidity.

C. Spectral Information

Because this instrument was designed to measure the net outgoing radiation flux, infrared radiation was measured over a very wide band of wavelengths.

D. Spatial Information

Since the individual sensors consisted of flat plates, they evidently received radiation from an entire hemisphere.

E. Data Recording Procedures

Data were telemetered to the ground.

II. Data

Graphs present the absolute net radiation flux as a function of altitude for each of the two flights. Air temperature, hourly temperature change, and cloud-cover

UNCLASSIFIED

UNCLASSIFIED

WILLOW RUN LABORATORIES

information are also given. A third graph presents this same information as recorded at Fort Monmouth, New Jersey, on 12 November 1959.

The uncertainty in the flux measurement was approximately 15 percent.

REFERENCE Unclassified

R. W. Fenn and H. K. Weickmann, "Atmospheric Net Radiation during Winter in the Thule Area, Greenland," J. Geophys. Res., Vol. 65, No. 11, November 1960, pp. 3651-3656.

6.5. (U) MEDIUM-ALTITUDE FLUX MEASUREMENT OVER TRINIDAD

I. Instrument Description and Platform

A. General

Six airplane flights were made over the waters east of Trinidad to measure the net upward radiation flux. The measurements were made between sunrise and sunset; the altitude of the aircraft ranged from 200 to 16,000 ft.

B. Instrumentation

A wideband radiometer was mounted on the wing of the aircraft. Upward- and downward-looking sensors measured the longwave radiation by means of thermistors which had a long time constant (25 sec to reach 66 percent of final value).

C. Spectral Information

Longwave radiative flux was measured. The ultimate goal of these measurements was direct determination of the heat budget of the earth. Therefore, a very wide band was involved.

D. Spatial Information

No field-of-view response was given. Because the radiometer was attached rigidly to the wing, and the time constant of the thermistors was so long, the radiometer averaged the flux received over a distance of about 4 mi. Two sensors looked up and two looked down. The airplane maintained level flight at altitudes ranging from 200 to 16,000 ft.

II. Data

Upward, downward, and net radiation in langley per minute is given for various altitudes. Some cloud information is given with the data.

UNCLASSIFIED

WILLOW RUN LABORATORIES

REFERENCE Unclassified

D. B. Clarke, "Radiation Measurements with an Airborne Radiometer over the Ocean East of Trinidad," J. Geophys. Res., Vol. 68, No. 1, January 1963.

6.6. (U) EXPLORER SATELLITE

I. Instrument Description and Platform

A. General

The Explorer VII satellite was launched on 13 October 1959; it attained an apogee of 1100 km and a perigee of 550 km. The satellite carried a total-flux radiometer which yielded data useful in the study of the heat balance of the earth.

B. Instrumentation

The detectors were four thermistors inside four hollow metal spheres. A white sphere responded primarily to longwave radiation while a black sphere responded to all radiation. The other two spheres were shaded so that the direct solar radiation could be separated from the reflected solar radiation.

C. Spectral Information

No exact spectral information is given in the references cited, but very wide bands were involved since the experiment was designed to measure the radiation balance of the earth.

D. Spatial Information

At an altitude of 700 km, the satellite viewed a circle on earth that had a radius of 2855 km.

E. Data Recording Procedure

The data were collected by telemetry. Because no recording apparatus was used on the satellite, only real-time data were obtained at the tracking stations.

II. Data

A. Prepared Data

Maps are presented that show the radiation loss of a portion of the earth in langleys per minute.

UNCLASSIFIED

UNCLASSIFIED

WILLOW RUN LABORATORIES

B. Analyzed Data

The data from Explorer VII have been analyzed somewhat for application to meteorological phenomena. (See especially the Weinstein reference.)

REFERENCES Unclassified

R. J. Parent et al., Instrumentation for a Thermal Radiation Budget Satellite, University of Wisconsin, Madison, Wls., 1959.

V. E. Suomi and R. J. Parent, Satellite Instrumentation for Measurement of the Thermal Radiation Budget of the Earth, University of Wisconsin, Madison, Wls., 1959.

M. Weinstein and V. E. Suomi, "Analysis of Satellite Infrared Radiation Measurements on a Synoptic Scale," Monthly Weather Rev., Vol. 89, No. 11, November 1961, pp. 419-428.

6.7. (U) SPECTRAL IRRADIANCE OF THE EARTH: BALL BROTHERS

I. Instrument Description and Platform

A. General

A limited amount of irradiance data were obtained from a series of balloon flights over Holloman Air Force Base during a program similar to that described in the earlier work of John Strong that was reviewed in section 6.2. The Ball Brothers flights were made in the morning.

B. Instrumentation

A modified Perkin-Elmer Model 99 spectrometer was used. The modifications were such that the instrument was converted to a dual-beam null-seeking device in which the irradiance from a reference source was attenuated until it was the same as the incoming irradiance.

The spectrometer was a double-pass Walsh-type prism spectrometer. The detector was a thermistor bolometer of special low bias voltage (30 V); it had a built-in KRS-5 window.

Responsivity calibration of the spectrometer was carried out at 10°C intervals by means of a blackbody source. Spectral calibration apparently was not done (cf. referenced report).

C. Spectral Information

The spectrometer scanned the 4.5- to 40- μ region in two segments.

UNCLASSIFIED

WILLOW RUN LABORATORIES

<u>Spectral Range (μ)</u>	<u>Prism</u>	<u>Mid-Range Spectral Slit Width (μ)</u>
4.5 to 14	NaCl	0.6
14 to 40	CeI	4.0

The spectrum was digitized with a spacing of approximately 12 per micron.

D. Spatial Information

The spectrometer looked alternately at elevation angles of $+65^{\circ}$ and -65° . The azimuthal motion was not described.

The field of view of the spectrometer was not specified.

E. Data Recording Procedure

The data were recorded aboard the balloon's gondola on a paper-punch recorder.

The spectrometer system was controlled by a programmed sequence controller. With the spectrometer at a fixed wavelength, the target's energy was received and time allotted for the photometric comparator's electronic servo to reach the null position. The paper tape was then punched with the servo position and with instructions for the readout device to get set for the next data point. The spectrometer then advanced to the next wavelength setting, and the process repeated.

II. Data

A. Signal Processing and Correlation with Ancillary Parameters

The signal from the bolometer was amplified, synchronously demodulated, and then low-pass filtered.

The time, package and ambient temperatures, and spectral scan number appeared on an instrument panel and were photographed periodically. The altitude of the instrument, water-vapor gradient, temperature gradient, and geographic position were also known.

B. Reduced Data

Sample graphs of spectral irradiance at $+65^{\circ}$ and -65° elevation are presented in the referenced report. The altitude goes from 4.1 to 36 km.

UNCLASSIFIED

UNCLASSIFIED

WILLOW RUN LABORATORIES

C. Data Format

As mentioned above, the reduced data have been presented graphically. The raw data were punched on a paper-tape format compatible with the Bendix G-15 digital computer.

D. Errors

The 323°K reference blackbody was stable to $\pm 1^\circ\text{K}$. The error in irradiance was a function of the irradiance level. In general, it was on the order of an equivalent uncertainty in the target temperature of $\pm 10^\circ\text{C}$ (cf. the referenced report pp. 32, 33). There was also a considerable amount of electrical interference from the auxiliary equipment.

REFERENCE Unclassified

R. T. Ekrem et al., Final Report: Irradiation Measurements of the Earth's Atmosphere in the 5 to 40 Micron Spectral Region at High Altitudes, SR 61-2, Ball Brothers Research Corp., Boulder, Colorado, March 1961, AD 255 062.

6.8. (U) ATMOSPHERIC OPTICAL MEASUREMENTS OVER WESTERN FLORIDA: BOILEAU

I. Instrument Description and Platform

A. General

The aircraft used was an air force XB-29 which took off from Eglin Air Force Base, Florida, at 0917 h EST on 16 May 1957. Measurements were made north of Eglin Air Force Base at altitudes up to 20,000 ft.

B. Instrumentation

The measuring instruments consisted of several telephotometers which utilized photomultiplier tubes. Four different filters could be interchanged by the operator, and a parabolic mirror was used to focus radiation on the phototube.

C. Spectral Information

The system response when the photopic filter was used was approximately that of the human eye. Three more filters gave responses to red, green, or blue radiation. The data obtained with the green filter were not reduced because there was no significant difference between them and the data obtained with the photopic filter. System spectral response curves for the four filters are given in figure 40.

UNCLASSIFIED

WILLOW RUN LABORATORIES

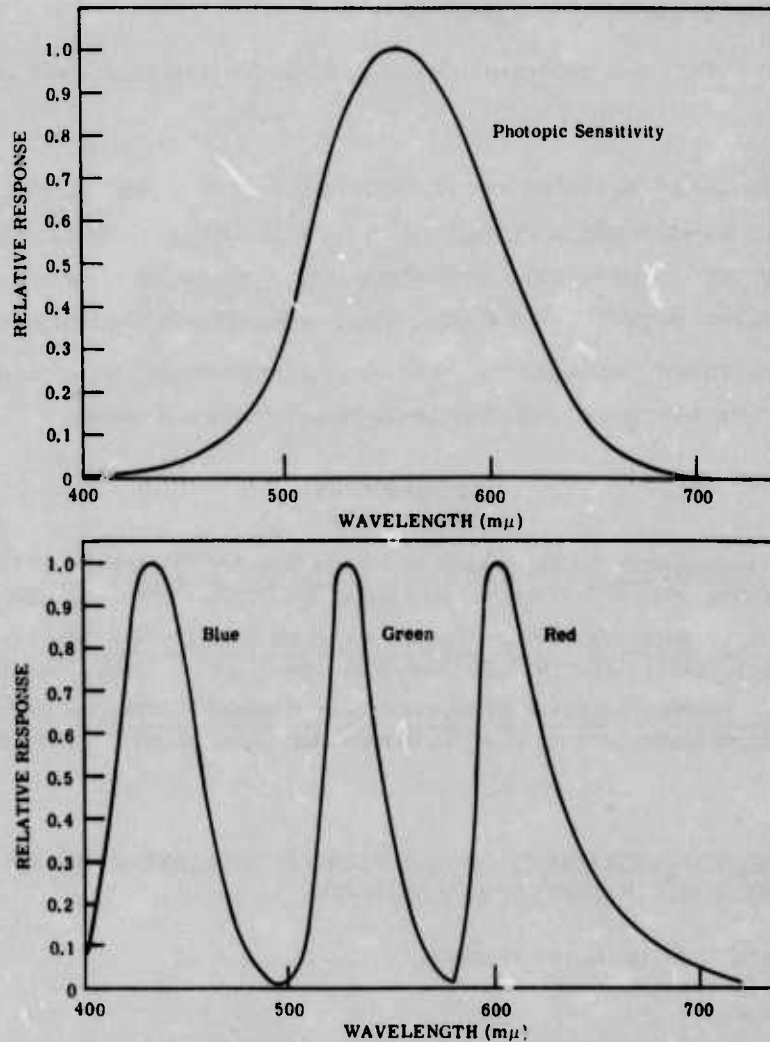

FIGURE 40. FILTER-PHOTOTUBE SPECTRAL RESPONSE. Boileau, 1960.
Unclassified

D. Spatial Information

One of the telephotometers looked continuously at the nadir with a 1° circular field of view. Another looked at the nadir but accepted radiation from the entire lower hemisphere in an amount approximately proportional to the cosine of the angle of incidence. A third looked in a horizontal direction with a circular field of view of 0.5° . The fourth had a circular field of view of 5° . This instrument scanned from 2.5° above the horizontal through the nadir to 2.5° above the opposite horizontal. During the scan, the azimuth angle changed by 10° . The scan repeated until the azimuth angle had gone through 180° .

UNCLASSIFIED

UNCLASSIFIED

WILLOW RUN LABORATORIES

E. Data Recording Procedures

Data were recorded on Sanborn Recorder strip charts and later digitized.

II. Data

Graphs of the radiance or luminance vs. altitude at particular zenith and azimuth angles are presented in the referenced reports. Also presented are the irradiance or illuminance from the lower hemisphere and the luminance or radiance from the nadir vs. altitude at particular azimuth angles and vs. azimuth angle at particular altitudes.

Ancillary information included time, sun azimuth and elevation, temperature profile, haze description, and color photographs of haze and clouds.

REFERENCES Unclassified

- A. R. Boileau, Atmospheric Optical Measurements in Western Florida, NS 714-100, Scripps Institute of Oceanography, University of California, San Diego, Calif., April 1960, AD 251 828.
- A. R. Boileau, Atmospheric Optical Measurements in Western Florida, NS 714-100, Scripps Institute of Oceanography, University of California, San Diego 52, Calif., June 1960, AD 251 827.
- A. R. Boileau, Atmospheric Optical Measurements in Western Florida, NS 714-100, Scripps Institute of Oceanography, University of California, San Diego 52, Calif., November 1960, AD 246 323.

6.9. (U) AN EARLY MEASUREMENT OF THE FLUX OF INFRARED RADIATION IN THE ATMOSPHERE: HOUGHTON AND BREWER

I. Instrument Description and Platform

A. General

The heat balance of the troposphere was studied experimentally at the University of Oxford in 1953 and 1954. Thermal flux and flux gradient were measured as a function of altitude by an airborne radiometer at altitudes up to 37,000 ft.

The measurements were made at night in generally clear weather. The main flights were made in August 1953, January 1954, and July 1954.

B. Instrumentation

A custom-built radiometer was used. The instrument was a total-flux device employing a flake bolometer in an evacuated chamber. The entrance window was KRS-5 (thallium bromo-iodide).

UNCLASSIFIED

WILLOW RUN LABORATORIES

The instrument was calibrated in vacuo with a blackbody source that varied in temperature from 20°K to room temperature.

C. Spectral Information

The instrument had broad response extending to about 30 μ .

D. Spatial Information

Both the upward and downward flux were measured by radiometers centered at the zenith and the nadir. The field of view was rather broad, perhaps 20°.

E. Data Recording Procedure

The data were recorded manually. A reading was taken every 3,000 ft, except in the presence of a cloud where the density of points was increased.

II. Data

A. Data Analysis

The radiance data have been expressed in terms of the effective emissivity of the atmosphere and clouds.

The flux-gradient data have been expressed in terms of equivalent cooling rate.

B. Prepared Data

Graphs that summarize the flux and flux-gradient profile of the atmosphere have been presented in the reference.

C. Ancillary Data

The cloud types encountered were stratocumulus and cirrus. The temperature and humidity were recorded during the flights.

REFERENCE Unclassified

A. W. Brewer and J. T. Houghton, "Some Measurements of the Flux of IR Radiation in the Atmosphere," Proc. Roy. Soc. (London), Vol. A236, 1956, pp. 175-186.

UNCLASSIFIED

UNCLASSIFIED

WILLOW RUN LABORATORIES

6.10. (U) EARTH RADIATION MEASUREMENTS BY INTERFEROMETER FROM A HIGH-ALTITUDE BALLOON: L. W. CHANEY

I. Instrument Description and Platform

A. General

The High Altitude Engineering Laboratory of The University of Michigan measured the earth's spectral flux in the thermal infrared region. The platform was a balloon launched in the early morning from a site near Sioux Falls, South Dakota, on 26 June 1963. Data were recorded throughout the day under a variety of meteorological conditions. The balloon reached a peak altitude of 112,000 ft.

This work was conducted in support of the meteorological satellite program of NASA. Earlier work (the balloon flight of 2 June 1962 described in section 3.4) tested the radiometers used on the TIROS and Nimbus Satellites. The experiment described here was an extension of the radiometer test program; it included for the first time the interferometer experiment. This review is concerned with the interferometer data.

B. Instrumentation

A modified Block I-4 series interferometer spectrometer was used. The TIROS and Nimbus medium-resolution infrared radiometers (MRIR's) were also on board. In this way, a direct comparison of the relative performance of the three systems was provided.

The Block I-4 interferometer is a Michelson interferometer employing a bolometer detector and a loudspeaker-coil mechanism for the spectral scan.

For this experiment, the interferometer was modified for tighter package-temperature regulation and modified in other details to make it compatible with overall instrumentation in the gondola. The details of the interferometer package are given in the referenced report by Chaney and Loh.

The interferometer was calibrated in wavelength by three independent methods; first, by using reference filters, second, by comparison with a Perkin-Elmer 13-U spectrometer, and, third, by comparison with the spectrum of polystyrene. The instrument was calibrated in amplitude by a "frying pan" blackbody in the 3- to 7- μ region and by a conical blackbody apparatus for longer wavelengths. These calibration procedures are described in the referenced report by Chaney and Loh.

UNCLASSIFIED

WILLOW RUN LABORATORIES

The TIROS and Nimbus high-resolution infrared radiometers (HRIR) are five-band filter radiometers and also employ bolometer detectors. Complete descriptions of these instruments appear in the referenced reports by Stroud and Goldberg.

There was also a camera on board; it was not described. A Perkin-Elmer ES-G4 visible spectrophotometer was also mentioned, but the data from this, if any, were not discussed.

C. Spectral Information

The useful spectral response of the interferometer extended from 6.0μ to 16.7μ at a nominal resolution of 50 cm^{-1} (about 0.5μ). In the analysis, the interferometer data was treated "as though it [the interferometer] were a 31-channel radiometer," the spectrum being divided into 31 regions.

The MRIR bands were governed by filters as shown in table VIII.

D. Spatial Information

The spectrometer and the two radiometers were boresighted and looked at a constant nadir angle of 30° . This was the smallest angle which would allow the the space-viewing optics of the radiometers to see past the balloon structure. The azimuth angle apparently was left to vary at random.

The balloon reached its peak altitude at 7:00 a.m. CST, so that the bulk of the data were recorded in the vicinity of 100,000 ft.

TABLE VIII. FILTERS GOVERNING
MRIR BANDS IN TIROS AND NIMBUS
SATELLITES
Unclassified

Filter	Nominal Bandwidth (μ)	
	TIROS	Nimbus
1	5.8 to 6.8	6.5 to 7.0
2	7.5 to 13.5	10.0 to 11.0
3	0.2 to 6.0	0.2 to 4.0
4	7.5 to 30.0	5.0 to 30.0
5	0.55 to 0.75	0.55 to 0.85

UNCLASSIFIED

UNCLASSIFIED

WILLOW RUN LABORATORIES

The fields of view of the radiometers and the interferometer were approximately conical with the apex angles shown below.

Nimbus MRIR	2.85°
TIROS MRIR	5°
Block I-4T interferometer spectrometer	15°

E. Data Recording Procedure

The outputs from the interferometer and the radiometers were telemetered to earth. The format for the raw data was analog on magnetic tape.

II. Data

A. Data Analysis

The output from an interferometer is related to the required spectrum by a Fourier transform. An effective way to compute the Fourier transform of the output is therefore necessary for successful data reduction.

The interferograms were analyzed as follows. A series of 34 consecutive interferograms were extracted from the working tape and recorded on a magnetic-loop tape recorder in a continuous loop. This was played back at an increased speed, resulting in a periodic function of the interferograms suitable for direct wave analysis on a wave analyzer. In this way, the effective noise, probable error, and time of analysis were all reduced in relation to analyses performed upon single interferograms.

The reduced data took the form of equivalent blackbody temperature as a function of wavelength. A total of 38 reduced spectra were produced, covering a period of about 12 h. Each spectrum was based upon 17 sec of observation. Spectra were produced at an average rate of one every 19 min.

The data from the TIROS and Nimbus radiometers were compared with the interferometer data as follows. The equivalent blackbody temperatures were converted to spectral radiance and multiplied by the appropriate filter function. The resulting function was integrated to obtain radiance. The equivalent blackbody temperature was then obtained from the radiometer calibration curve.

B. Ancillary Data

The sky was clear for the first half of the flight. A period of transition followed, after which a deck of high cumulus clouds filled the scene.

UNCLASSIFIED

UNCLASSIFIED

WILLOW RUN LABORATORIES

C. Prepared Data

The 38 reduced spectra have been tabulated in their entirety and appear in the referenced report by Chaney. Representative photographs of the three basic cloud conditions are included.

The results obtained by the interferometer, the TIROS and Nimbus radiometers, and direct surface measurements have been compared, and they have been found essentially to agree (cf. the referenced report by Chaney, p. 239).

D. Error Statements

Sources of error in the interferometer data have been discussed in the referenced report by Chaney and Loh. The probable error in the temperature determinations varied from $\pm 1^{\circ}$ to $\pm 10^{\circ}$.

The corresponding error in the TIROS and Nimbus radiometers is not stated, but is assumed to be comparable or lower.

REFERENCES Unclassified

L. W. Chaney, "Earth Radiation Measurements by Interferometer from a High Altitude Balloon," Proceedings of the Third Symposium on the Remote Sensing of Environment, Report No. 4864-9-X, Institute of Science and Technology, The University of Michigan, Ann Arbor, February 1965, AD 614 032.

L. W. Chaney and L. T. Loh, An Infrared Interference Spectrometer — Its Evaluation, Test, and Calibration, Report No. CR-61, NASA, Washington, D. C., June 1964.

I. L. Goldberg, Nimbus Radiometry, Report No. N63-18617, Goddard Space Flight Center, Greenbelt, Md., 1962.

W. G. Stroud, Final Report on the TIROS I Meteorological Satellite System, Report No. TR R-131, Goddard Space Flight Center, Greenbelt, Md., 1962.

7

SELECTED EXTRATERRESTRIAL BACKGROUNDS

Unclassified

7.1. (U) INTRODUCTION

"Extraterrestrial" backgrounds will be defined here as those viewed essentially above the horizon and from high altitudes. These include the sun-illuminated upper atmosphere, the air-glow at night, the aurora, and the celestial background. Several experiments pertaining to these kinds of backgrounds are reviewed in this section. This chapter has not been intended as a complete survey as have the previous sections.

UNCLASSIFIED

UNCLASSIFIED

WILLOW RUN LABORATORIES

7.2. (U) EARLY PHOTOELECTRIC MEASUREMENTS OF SKY BRIGHTNESS

I. Instrument Description and Platform

A. General

The earliest high-altitude measurements of the brightness of the daytime sky known to us are those of M. Luckiesh, who made photometric measurements from an airplane in 1919. He allegedly made measurements up to 6 km (cf. the referenced article by Miley et al.). Between that time and World War II, there supposedly were a number of similar measurements made from airplanes and balloons. The information from these is somewhat obscure, however, and seems to have little significance today.

After 1946, a number of high-altitude photoelectric measurements were made from rockets. The results of several of these have been drawn together by Miley, Cullington, and Bedinger (cf. the referenced article by Miley et al.). We shall consider these works here.

The objective of these experiments was to measure the light of the sky at selected wavelengths and as a function of altitude.

B, C, D. Instrumentation and Spectral and Spatial Information

Rocket flights were made as follows:

(1) On 21 November 1946, a V-2 rocket carried two pairs of RCA type 929 (S4 response) phototubes, one pair filtered for blue light (Wratten no. 47), and the other pair looking in the opposite direction and filtered for green light (Wratten no. 61). Another pair of phototubes (type 92S with S1 response) and a single 926 tube (S3 response) were used with no filters. The phototubes looked out the side of the V-2 warhead. The respective fields of view were evidently rather wide.

(2) On 8 December 1947, a V-2 rocket carried twelve 931 A photomultiplier tubes. Five pairs looked out the side and were filtered at peaks of 0.428μ , 0.472μ , 0.567μ , and 0.615μ . The other two were diametrically opposed and measured the albedo of the earth in the visible range (see fig. 41). The respective fields of view were evidently rather wide.

(3) On 31 August 1950, there was another V-2 flight, similar to the one above. The photomultiplier tubes were changed to 1P21's, and the filters were peaked at 0.426μ and 0.559μ only. The spectral response curves were given for these

UNCLASSIFIED

WILLOW RUN LABORATORIES

filters and are shown in figure 42. The field of view was conical with a 2.75° half-angle.

(4) On 25 July 1951, an Aerobee rocket was fitted with a color-wheel photometer having eight filters and a grain-of-wheat lamp in the ninth position for calibration. Five of the eight filters, all in the 0.42- to $0.59\text{-}\mu$ region, gave signals too large to be measured. A boresighted camera was also included on this flight, and the pictures were successfully recovered.

E. Data Recording Procedure

The data were collected by telemetry, except for the photographs, which were evidently recovered.

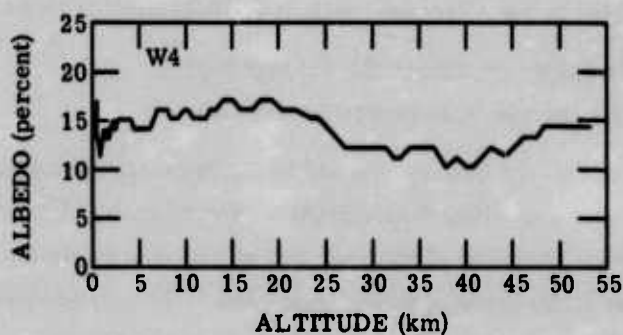

FIGURE 41. ALBEDO MEASUREMENTS. Miley, 1953.

Unclassified

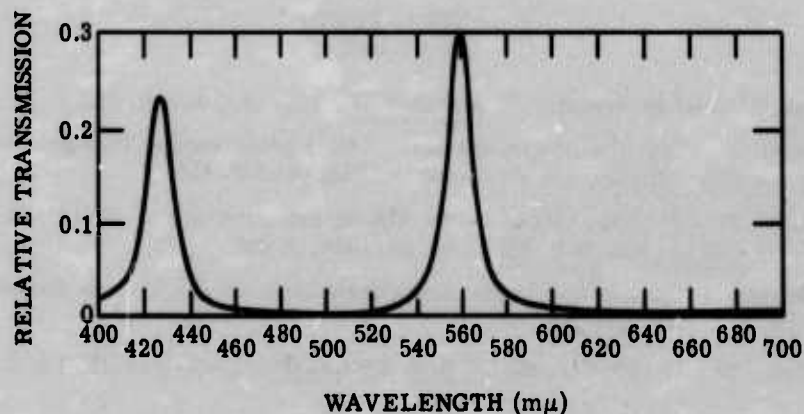

FIGURE 42. TRANSMISSION CURVES FOR INTERFERENCE FILTERS USED IN EARLY PHOTOELECTRIC MEASUREMENTS OF SKY BRIGHTNESS. Miley, 1953.

Unclassified

UNCLASSIFIED

UNCLASSIFIED

WILLOW RUN LABORATORIES

II. Data

A. Data Analysis

The amplitude of the signal was calibrated by the use of National Bureau of Standards calibrated lamps. It is not clear whether this was always carried out throughout each flight.

The altitude of the rockets was generally unstable in the ballistic portion of the trajectory. Spatial correlation apparently was achieved, however.

Attitude angle vs. time is reported for the 1950 flight only.

B. Prepared Data

Included in the referenced article by Miley are the following:

- (1) Intensity vs. altitude for all four flights
- (2) Photograph of a cloud taken at 70 km

In general, the intensity caused by Rayleigh scattering was found to drop off exponentially with altitude as expected. The intensity of "day glow" (defined as the radiation in excess of Rayleigh scattering) was established to be about 10,000 times that of the corresponding "night glow." This anomalously high radiation was found to remain about constant from 40 km to 130 km.

It is also notable that a cloud was seen at about 70 km.

REFERENCES Unclassified

- M. Luckiesh, "Aerial Photometry," Astrophys. J., Vol. 49, 1919, p. 122.
- H. A. Miley et al., "Day-Sky Brightness Measured by Rocketborne Photoelectric Photometers," Trans. Am. Geophys. Union, Vol. 34, October 1953, pp. 680-695.
- R. Stair and W. W. Coblenz, "Radiometric Measurements of Ultraviolet Solar Intensities in the Stratosphere," J. Res. Nat. Bur. Std., Vol. 20, 1936, p. 185.
- R. P. Teele, Insolation, Earth, and Sky Brightness, National Geographic Society, Stratosphere Series, No. 2, 1936, pp. 133-138.
- E. H. Vestine, "Noctilucent Clouds," J. Roy. Astron. Soc. Can., Vol. 20, No. 3, 1934, pp. 249-317.

UNCLASSIFIED

WILLOW RUN LABORATORIES

7.3. (U) THE BRIGHTNESS OF THE ATMOSPHERE AT HIGH ALTITUDES: N. L. BARR

I. Instrument Description and Platform

A. General

An F2H aircraft carrying a photometer made a series of flights between 29 August 1951 and 6 February 1952 at a maximum altitude of 50,000 ft. All data were taken over water or the junction of land and water near Churchill, Manitoba, or Corpus Christi, Texas.

B. Instrumentation

The photometer utilized a 931A photomultiplier tube and a telescope objective to focus the radiation on the tube. The photomultiplier output was amplified and then recorded on an oscillograph.

C. Spectral Information

The photomultiplier-filter combination provided a spectral response that closely approximated the response of the human eye.

D. Spatial Information

The photometer's field of view was limited to 20 min of arc. The plane flew at certain discrete altitudes ranging from 15,000 to 50,000 ft. At each altitude, the photometer looked at discrete zenith angles ranging from 0° to 180° , and, at each zenith angle, the bearing from the sun was varied from 0° to 180° in steps of 15° .

E. Data Recording Procedures

The data were recorded on an oscillogram for all bearings and altitudes in a period of about 1.2 h for each run.

II. Data

The following reduced data appear in the report by N. L. Barr:

- (1) Brightness (foot-lamberts) as a function of zenith angle (tables)
- (2) Brightness vs. scattering angle (graphs)
- (3) Brightness vs. azimuth angle (graphs)

UNCLASSIFIED

UNCLASSIFIED

WILLOW RUN LABORATORIES

The date, time, latitude, longitude, pressure, air temperature, sun's azimuth and altitude, dew point, and aircraft altitude were satisfactorily correlated with these data.

REFERENCE Unclassified

N. L. Barr, Brightness of the Atmosphere, Report No. 001-05 6.07.01, Naval Medical Research Institute, National Naval Medical Center, Bethesda, Md., March 1953.

7.4. (U) THE RADIANCE OF THE SKY AT HIGH ALTITUDES: NEWKIRK AND EDDY

I. Instrument Description and Platform

A. General

Under the auspices of the High Altitude Observatory in Boulder, Colorado, two balloon flights were made in which photometric and spectrophotometric measurements of the sky's light were carried out. The results from the more successful flight of 3 October 1960, have been given and are reviewed here. This flight went to an altitude of 80,000 ft.

B, C, D. Instrumentation and Spectral and Spatial Information

The sky radiances were recorded in three ways.

(1) Photoelectrically, by means of a photoelectric photometer peaked at 0.52μ and measuring at a scattering angle of 10.3° only.

(2) Spectrographically, by means of a film-recording spectrograph covering the region from 0.37 to 0.79μ with the measured scattering angle varied from 1.7° to 2.8° .

(3) Photographically, by means of a camera filtered to receive the light component perpendicular to the plane of scattering with spectral response peaked at 0.44μ and the measured scattering angle varied from 9.6° to 57.8° .

E. Data Recording Procedure

None was stated.

II. Data

A. Data Analysis

Both the spectrograph and the photoelectric photometer recorded absolute radiance values.

UNCLASSIFIED

UNCLASSIFIED

WILLOW RUN LABORATORIES

B. Prepared Data

Published in the Newkirk paper were graphs of radiance and spectral radiance vs. altitude at various scattering angles.

REFERENCE Unclassified

G. A. Newkirk, J. A. Eddy, "Daytime Sky Radiance from Forty to Eighty Thousand Feet," Nature, Vol. 194, No. 4829, May 1962, pp. 638-641.

7.5. (U) AIR GLOW SPECTRA: NOXON AND JONES

I. Instrumentation and Platform

A. General

This was a single balloon flight from Quebec on 27 April 1960. Measurements of the glow of the night air were made by using a custom-built spectrometer.

B. Instrumentation

The spectrometer employed a 64-mm by 64-mm plane diffraction grating with 300 lines per millimeter. The detector was liquid-oxygen-cooled PbS. Minimum detectable brightness was about 2×10^{-8} W/(cm²-sr- μ) at a spectral slit width of 0.07 μ .

C. Spectral Information

The spectrometer scanned from 1.6 to 3.7 μ . Wavelengths shorter than 2.0 μ were removed by a Ge filter at the slit entrance.

The spectrum was scanned by driving the grating with a reciprocating cam mechanism. The period of scan was 80 sec.

D. Spatial Information

The line of sight of the spectrometer was fixed at 75° from the zenith. The azimuthal angle was allowed to vary freely with the motion of the balloon.

The spatial resolution was not given. However, the angular length of the detector may be inferred to be 0.1 rad.

E. Data Recording Procedure

The data were telemetered to the ground continuously.

UNCLASSIFIED

UNCLASSIFIED

WILLOW RUN LABORATORIES

II. Data

A. Data Reduction

Since the altitude was the only significant spatial parameter, no complex transfer function was needed.

The method of calibrating the spectrometer was not stated.

The SNR was not specified, except that above 7.5 km the telemetry became inoperative because of noise.

The temperature of the detector and the ambient temperature and pressure were monitored during the flight. Other physical parameters apparently were not.

B. Prepared Data

Included in the Noxon article are the following graphs:

- (1) Relative radiance vs. wavelength, taken at the ground and at 7.5 km
- (2) Comparison of synthetic with observed spectral radiance at various altitudes. (The synthetic model cited is that of Chamberlain and Smith.)

The maximum spectral radiance measured was about $1 \times 10^{-6} \text{ W}/(\text{cm}^2 \text{-sr-}\mu)$ at 3.6μ .

REFERENCE Unclassified

J. F. Noxon and V. Jones, "A Balloon-Borne Spectrometer for the Study of the Airglow Beyond 2.0μ ," Can. J. Phys., Vol. 39, 1961, pp. 1120-1129.

7.6. (U) DIRECT PHOTOMETRIC MEASUREMENTS OF PARTICLES PRODUCING VISIBLE AURORAS: C. E. MCILWAIN

I. Instrument Description and Platform

A. General

Two Nike-Cajun rockets were fired from Fort Churchill, Canada, primarily in order to measure the particles that produce visible auroras. These rockets were fired in the morning on 22 and 25 February 1958 during visible auroras. Each reached an altitude of approximately 120 km.

UNCLASSIFIED

UNCLASSIFIED

WILLOW RUN LABORATORIES

B. Instrumentation

One of the instruments carried aboard the rocket was a visible photometer utilizing an RCA 1P21 photomultiplier tube. The other instruments carried were a proton detector, an electron detector, and a Geiger tube.

C. Spectral Information

The spectral response was determined by the response of the RCA 1P21 photomultiplier. This response is shown in figure 43.

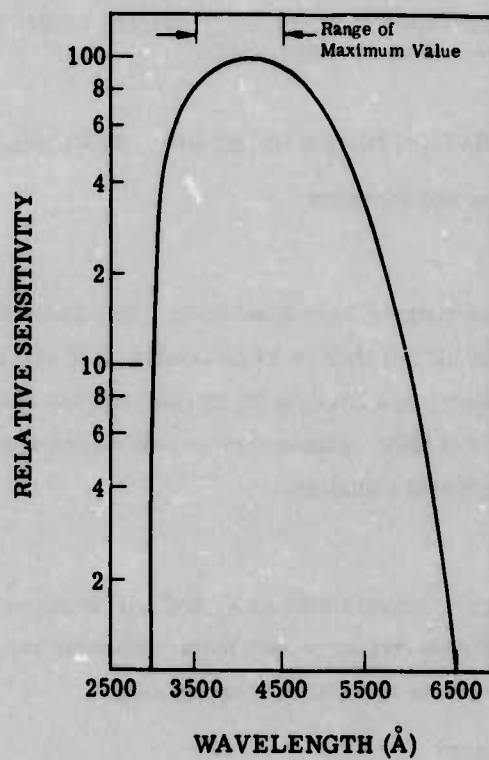

FIGURE 43. SPECTRAL RESPONSE OF THE
1P21 PHOTOMULTIPLIER TUBE
Unclassified

D. Spatial Information

The field of view was 3.5° by 5° ; it was perpendicular to the rocket axis.

E. Data Recording Procedure

The data were collected by telemetry.

UNCLASSIFIED

UNCLASSIFIED

WILLOW RUN LABORATORIES

II. Data

From the graphs given in the report, one can determine the absolute intensity of light above and below the rocket as a function of altitude, the difference in light intensity in the north and south, and the fraction of total auroral light produced below the rocket as a function of altitude. The report describes the type of aurora occurring at the time of each flight.

REFERENCE Unclassified

C. E. McIlwain, "Direct Measurement of Particles Producing Visible Auroras," J. Geophys. Res., Vol. 65, No. 9, September 1960, pp. 2727-2747.

7.7. (U) ULTRAVIOLET RADIATION IN THE NIGHT SKY: KUPPERIAN AND OTHERS

I. Instrument Description and Platform

A. General

Two Aerobee rockets were fired from White Sands Proving Grounds. The first was fired at 0200 h MST on 17 November 1955 and reached an altitude of 105 km. The second was fired on 28 March 1957 and reached its peak altitude of 146 km at 2156 h MST. Photometric measurements were made of the far-ultraviolet background radiation.

B. Instrumentation

NO-filled ion chambers with CaF_2 and LiF windows were used to detect the radiation. Measurements were also made with a visible photometer; this output was used to determine the rocket orientation.

C. Spectral Information

Each rocket contained instruments sensitive in the regions from 1040 to 1350 Å and from 1225 to 1350 Å. These limits were defined by the transmission of the window materials and the ionization potential of NO.

D. Spatial Information

The detectors were mounted with their optical axes perpendicular to the rocket axis. The spin and change of orientation of the rocket provided the scan. The circular field of view of these instruments was either 0.1 or 0.3 sr.

UNCLASSIFIED

WILLOW RUN LABORATORIES

E. Data Recording Procedure

Data were collected by telemetry.

II. Data

A photograph of the telemetry record was published for both the first and second flights (cf. the referenced report by Byram). No calibration information is given on these, however. Values of the upward flux are given in units of $\text{ergs-centimeters}^{-2}$ - seconds^{-1} - steradians^{-1} for the two wavelength regions considered.

REFERENCES Unclassified

E. T. Byram et al., Far Ultraviolet Radiation in the Night Sky, U. S. Naval Research Laboratory, Washington, D. C., 1955.

J. E. Kupperian et al., "Extreme Ultraviolet Radiation in the Night Sky," Ann. Geophys., Vol. 14, No. 3, July-September 1958.

J. E. Kupperian et al., "Far Ultraviolet Radiation in the Night Sky," Planetary Space Sci., Vol. 1, 1959, pp. 3-6.

7.8. (U) THE CELESTIAL BACKGROUND: NORTRONICS

I. Instrumentation and Platform

A. General

Spectrophotometers operating in the visible have been flown on board several missiles in order to obtain information on the celestial background as seen from the missiles. The objective of these measurements was to provide data for the development of a stellar-inertial guidance system for space vehicles.

The program was divided into two phases. During Phase I, the qualitative spectral and spatial features of the background were determined. During Phase II, these features were examined in greater detail. Three successful flights were made:

- (1) FTM 437, 26 February 1964, nighttime flight with Phase I instrumentation
- (2) FTM 440, 13 March 1964, daytime flight with Phase II instrumentation
- (3) FTM 442, 20 March 1964, daytime flight with Phase I instrumentation

The measurements were taken between 20 km and 200 km. This work was done in conjunction with the Autonetics Division of North American Aviation.

UNCLASSIFIED

UNCLASSIFIED

WILLOW RUN LABORATORIES

B. Instrumentation

Photometers with CdS photocells (RCA No. 4425) and multilayer interference filters custom made by Spectrolab were used. Diagrams of the photometers are given in figure 44.

C. Spectral Information

The Phase I photometer had four channels peaked at 0.52μ , 0.56μ , 0.59μ , and 0.60μ . The Phase II photometer had ten channels equally spaced over the band from 0.36μ to 0.76μ . The effective spectral resolution was therefore about 0.05μ . The spectral response curves are given in figure 45.

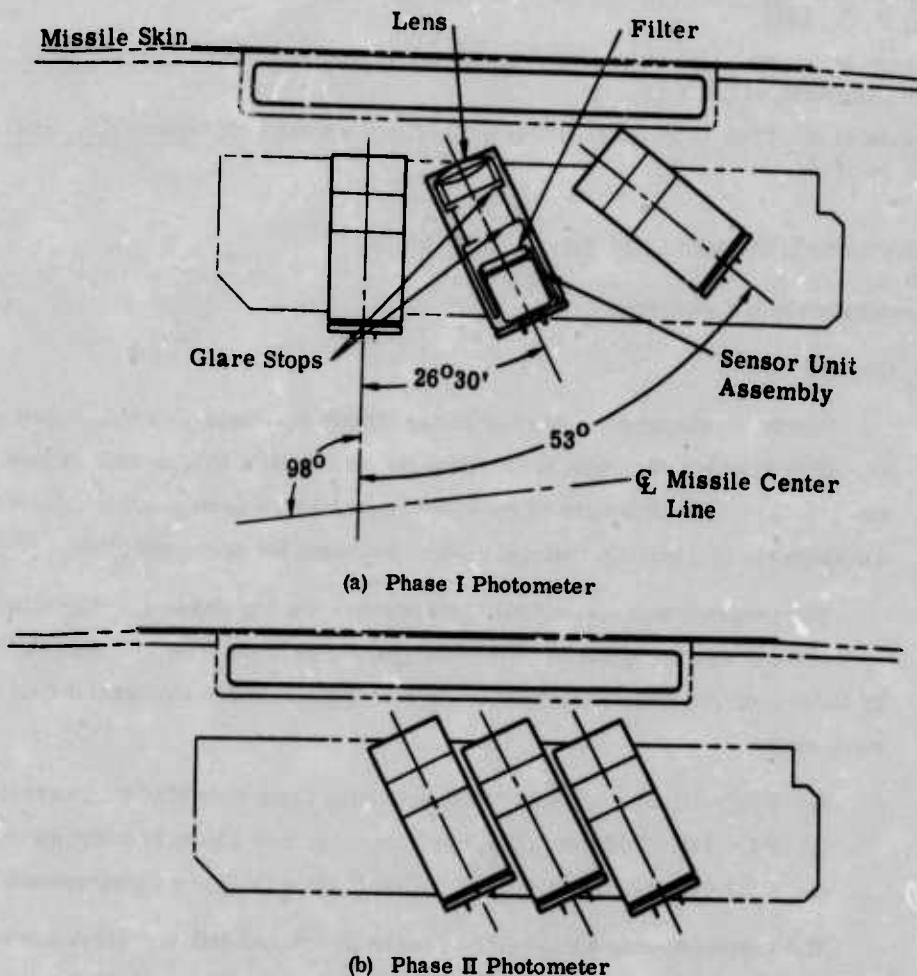
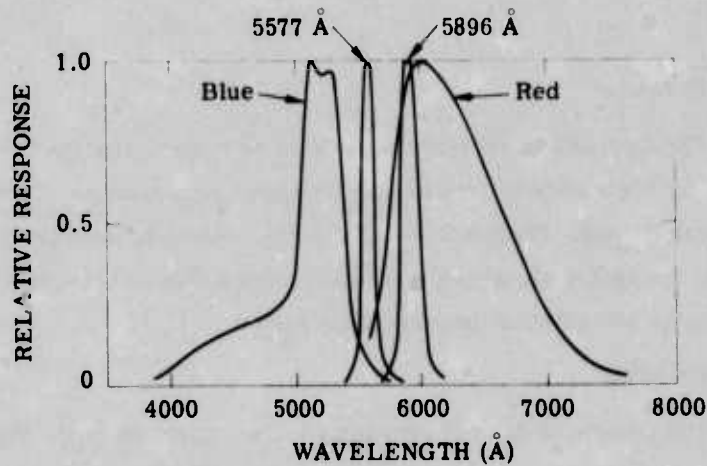

FIGURE 44. CROSS SECTIONS OF THE NORTHRONICS PHOTOMETERS
Unclassified

UNCLASSIFIED

UNCLASSIFIED

WILLOW RUN LABORATORIES



(a) Phase I

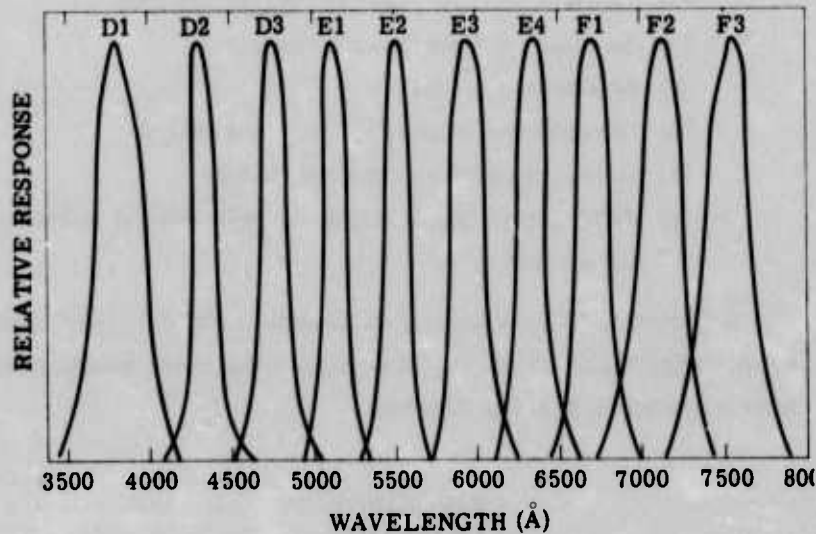

(b) Phase II

FIGURE 45. SPECTRAL RESPONSE CURVES OF PHOTOMETERS
Unclassified

D. Spatial Information

The photometers looked out the side of the upper part of the missile. The altitude of the missile during flight was not discussed, but the sample data given indicate that pitch, yaw, and roll were known to two significant figures. However, the reported radiance data were not correlated to spatial information.

E. Data Recording Procedure

The data were collected by telemetry.

UNCLASSIFIED

UNCLASSIFIED

WILLOW RUN LABORATORIES

II. Data

A. Data Reduction

The raw-data flight tapes were secured by the Autonetics Division and then given to Nortronics for reduction. Computer programs were written in 7090 Fortran format. Programs relating signal voltage to brightness and signal voltage to the look angle of the photometer were written. Complete listings of these programs are given in the referenced report.

B. Prepared Data

The results of the measurements are summarized in the report.

The following graphs are presented:

- (1) Radiance vs. wavelength at various altitudes
- (2) Radiance vs. time for each channel
- (3) Brightness vs. time
- (4) Effective temperature vs. time and altitude
- (5) Scattering angle vs. time and altitude
- (6) Ratio of narrowband brightness to broadband brightness vs. time and altitude

Sustained radiation backgrounds as high as 600 ft-L were consistently measured during the program. From previous background measurements, sky brightness less than 50 ft-L was expected.

REFERENCE Unclassified

High Altitude Sky Brightness Measurement Program (U), NORT 64-220, Northrop Corporation, Nortronics Division, Palos Verde Peninsula, California, May 1964, AD 604 032 (CONFIDENTIAL).

8

SELECTED HIGH-ALTITUDE SOLAR SPECTRA

Unclassified

8.1. (U) INTRODUCTION

Solar spectra have been recorded by various agencies for a variety of purposes. In the experiments reviewed herein, infrared solar spectra have been recorded during high-altitude transmission measurements (Murcray), for detailed knowledge of the structure of the spectrum

UNCLASSIFIED

WILLOW RUN LABORATORIES

in the infrared (T. S. Moss and C. Cumming), in the ultraviolet (F. S. Johnson). Perhaps the most extensive compilation of data has been provided by the work of T. S. Moss.

The experiments reviewed in this section are only representative of the total available in the field. Measurements in the visible spectrum are not presented in this document.

8.2. (U) THE INFRARED SOLAR SPECTRUM: T. S. MOSS AND OTHERS

I. Instrumentation and Platform

A. General

A large volume of solar data was produced over the period from 19 December 1957 to 24 May 1960 during a series of 98 flights over England to record high-resolution solar spectra. The altitude of measurement was up to 49,000 ft from an aircraft platform.

B. Instrumentation

The spectral measurements were taken using a custom-built grating spectrometer. This consisted of a sun-following optical mechanism, a preliminary prism spectrometer of calcium fluoride (CaF) followed by a 4- by 3-in. grating with 7500 lines per inch. Photoconductive detectors were used.

C. Spectral Information

Three spectral regions were scanned:

- (1) 1 to 3 μ (PbS detector)
- (2) 3 to 5.2 μ (PbTe detector)
- (3) 5 to 6.5 μ (PbSe detector, cooled)

A Ge: Au detector was also used for a limited number of measurements. The spectral resolution was on the order of 1 to 3 cm^{-1} or approximately 0.003 μ .

D. Spatial Information

The optic axis of the spectrometer was directed toward the sun at all times. Accurate tracking of the sun was achieved by using an automatic sun follower.

E. Data Recording Procedure

The output from the detector was recorded on a potentiometer recorder and on a multichannel galvanometer film recorder. The scanning rate was once every several minutes.

UNCLASSIFIED

UNCLASSIFIED

WILLOW RUN LABORATORIES

II. Data

A. Data Analysis

The significant parameters were altitude and instrument orientation (same as sun angle). These were both recorded with the spectral measurements.

The temperature of various parts of the instrumentation was monitored. Atmospheric conditions, the method of calibration, and the SNR's were not specified.

B. Prepared Data

The referenced report by Houghton et al. gives an extensive set of tables and associated graphs of solar spectra obtained by the Houghton group and six other agencies. These cover the region from 9716.5 cm^{-1} to 1543.3 cm^{-1} ($1.2 \mu - 6.5 \mu$). The referenced report by Moss gives solar, methane, and CO spectra from a 25,000-ft altitude. The radiance values for all the above data are relative.

In the large number of flights made, no serious inconsistencies in the data were noted, which implies high repeatability. It is also noteworthy that the spectrometer clearly resolved the isotopic absorption band attributable to $\text{C}^{13}(\text{O}^{16})_2$.

REFERENCES Unclassified

J. T. Houghton et al., "An Atlas of the Infrared Solar Spectrum from 1 to 6.5μ Observed from a High Altitude Aircraft," Phil. Trans. Roy. Soc. London, Vol. 254, No. 1037, November 1961, pp. 47-123.

T. S. Moss, Atmospheric Transmission Measurements Using An Airborne Grating Spectrometer, Royal Aircraft Establishment, Farnborough, Hants, England, 1950.

8.3. (U) SOLAR RADIATION MEASUREMENTS: D. G. MURCRAY

I. Instrument Description and Platform

A. General

Two high-altitude balloon flights took place in the Denver, Colorado, area on 22 June 1955 and 3 August 1956. The clear weather was exploited to obtain measurements of the variation of effective solar radiance with air mass. Data were recorded at maximum altitudes of 70,000 ft and 65,000 ft, respectively.

UNCLASSIFIED

WILLOW RUN LABORATORIES

B. Instrumentation

A custom-built Littrow spectrometer was used. For the 22 June 1955 flight, a PbS detector with a quartz prism was used; for the 3 August 1956 flight, a PbSe detector with a LiF prism was used. The spectrometer was fixed on the sun by a sun-following mechanism.

C. Spectral Information

The spectral region from 0.5μ to 2.7μ was scanned on the first flight. The far end extended to 4.5μ on the second flight. Spectral resolutions were not stated.

The period of scan was 1 min.

D. Spatial Information

The sun follower maintained the optic axis of the spectrometer to within 0.25° of the sun.

E. Data Recording Procedure

The raw data were recorded on 35-mm film by a film-recording galvanometer. Ambient pressure and the performance of the sun follower were monitored by telemetry.

II. Data

A. Data Analysis

Since the balloon remained over a fixed geographical location throughout, only the altitude and the sun angle were necessary for spatial correlation. These presumably were recorded. The cloud cover was also described, but the atmospheric composition was not.

B. Prepared Data

The referenced report by Murcraay is the final report under the contract. No quantitative data is given in this report. However, the following remarks are made regarding the measurements:

(1) "The data which were obtained (22 June 1955) indicated that the CO_2 was uniformly distributed up to at least 70,000 feet."

UNCLASSIFIED

UNCLASSIFIED

WILLOW RUN LABORATORIES

(2) "Wisps of cirrus and cirrostratus, probably ice crystal clouds at 22,000 feet or greater above the Earth's surface transmitted between 90 and 100% at 1.6 μ . A typical cirrus overcast of 10/10 at 22,000 feet and -45°C resulted in an average transmission of 74% with a maximum of 85% and a minimum of 61%." "On days when the cloud cover was composed of two layers, one of altocumulus at 16,000 feet and a cirrostratus layer at 25,000 feet, the transmission factors varied between 25% and 89% at 1.6 μ . Altostratus at 16,000 gave an average transmission of 3.5%."

(3) "Preliminary results indicate that the transmittance was independent of wavelength." (This refers to measurements at 1.6, 3.5, 5.3, 8.3, and 10.4 μ .)

The referenced report by Gates et al. is a scientific paper describing the results of the 22 June 1955 flight only. This report contains a graph of relative radiance vs. wavelength (0.5 to 2.5 μ), for altitudes from 13,500 to 102,000 ft. This data is compared with the theory and laboratory data of Howard, Burch, and Williams.

The data have been summarized in the following empirical formula

$$\int A_{\nu} d\nu = 0.44\omega^{1/2} \frac{0.43}{p}$$

where p = pressure

A_{ν} = spectral absorption

ω = concentration of the species (CO_2 or H_2O)

This "is remarkably close to the evaluation determined by Howard, Burch, and Williams for the laboratory data."

REFERENCES Unclassified

D. G. Murcray, Study of the Near Infrared Solar and Terrestrial Radiation as a Function of Altitude Above the Earth's Surface, AFCRL-TR-57-266, The University of Denver, Denver, Colo., February 1957, AD 117 170.

D. W. Gates et al., "Near Infrared Solar Radiation Measurements by a Balloon to an Altitude of 100,000 Feet," J. Opt. Soc. Am., Vol. 48, No. 12, December 1958, pp. 1010-1016.

UNCLASSIFIED

WILLOW RUN LABORATORIES

8.4. (U) SOLAR SPECTRA AND ATMOSPHERIC ABSORPTION MEASUREMENTS BY CARDE OF CANADA: CUMMING, FJARLIE, AND HAMPSON

I. Instrument Description and Platform

A. General

This work was a contribution of the Canadian Armament Research and Development Establishment (CARDE). The work considered here had no project name and will therefore be referred to as the "1958 CARDE solar measurements." On 12 November 1958, 77 spectral scans were completed in a single flight on 12 November 1958, over Quebec, Canada.

B. Instrumentation

A Perkin-Elmer Model-108 spectrometer was used in conjunction with a sun follower built by the De Havilland Aircraft Company. The spectrometer used a LiF prism and a Kodak-Ektron PbS detector. The instrumentation also included radar range equipment for locating the aircraft geographically and an oscillographic recorder.

C. Spectral Information

The spectrometer was fixed on the sun throughout. Spectral scanning took place around at a center wavelength of 2.0μ . The range of scan was not stated.

D. Spatial Information

The pitch, roll, and yaw rates and the heading and altitude of the aircraft were monitored continuously. In addition, the sunseeker angles and sunseeker tracking error were monitored. The spatial resolution and the scan pattern were not given.

E. Data Recording Procedure

The output from the detector was recorded on the oscillograph readout aboard the airplane.

II. Data

A. Data Analysis

As mentioned above, 77 scans were completed. The raw data appeared as detector output vs. time. The corresponding solar elevation angles were calculated from 1958 ephemeris data.

UNCLASSIFIED

UNCLASSIFIED

WILLOW RUN LABORATORIES

The sun angle and ambient temperature were monitored continuously. Cloud cover and atmospheric composition, however, were not recorded. The complex transfer function and the calibration procedure were not given.

B. Prepared Data

From certain of the raw data, the percentage of absorption vs. wave number was calculated point by point. Prepared for and included in the referenced report by Cumming and Fjarlie were the following:

- (1) A table of integrated absorptions for CO₂ and H₂O bands near 2 μ (table III, p. 3) and corresponding graph (fig. 3, p. 10)
- (2) Typical ground-level solar spectra as observed with airborne instrumentation (relative detector output from about 1 μ to 3 μ)

The measurements were compared with theoretical results, particularly those of Howard, Burch, and Williams (1956). The results of the experiment were found to fit the Howard-Burch-Williams semi-empirical formula

$$\int A_{\nu} d\nu = 0.492 w^{1/2} (p + \rho)^{0.390}$$

where p = partial pressure of CO₂ (millimeters of Hg)

ρ = total atmospheric pressure (millimeters of Hg)

w = CO₂ density (atmospheres-centimeters⁻¹)

The authors conclude: "It is suggested that the large differences observed in the water vapor content of the stratosphere are primarily seasonal rather than geographical (see the referenced report by Cumming, p. 6)."

REFERENCES Unclassified

C. Cumming and E. J. Fjarlie, Atmospheric Absorption Near Two Microns in the Solar Spectrum at 40,000 Feet, Report No. TM 246/59, CARDE, Valcartier, Quebec, April 1959, AD 217 985.

Hampson et al., Infrared Measurement at 45,000 Feet Altitudes, 1: Aircraft Experimental Equipment and Programme (U), CARDE, Valcartier, Quebec, February 1958 (CONFIDENTIAL).

UNCLASSIFIED

WILLOW RUN LABORATORIES

8.5. (U) FURTHER SOLAR MEASUREMENTS BY CARDE OF CANADA: CUMMING, FJARLIE, AND HAMPSON

I. Instrumentation

A. General

Three balloon flights in which solar spectra were measured in conjunction with a determination of atmospheric transmission and emission were made over Canada. The flights took place on 4 June 1959, 14 August 1959, and 22 October 1959. The measurements were made at sunrise.

B. Instrumentation

A grating spectrometer was used. The grating was 6 in. by 6 in. and had 0.004-in. line spacing. The detector was an RCA Victor gold-doped unit cooled by liquid nitrogen.

C. Spectral Information

The solar spectra covered the 2.4- to 4- μ band, the 2.8- to 4.4- μ band, and the 4.0- to 5.2- μ band, respectively. In addition, an atmospheric emission spectra from 2 to 8 μ was recorded. The spectral slit width was 0.2 μ .

D. Spatial Information

The zenith angle was nominally 85°. The azimuth angle was not stated. The field of view was conical with a 5° half-angle.

E. Data Recording Procedure

The data were collected by telemetry.

II. Data

A. Data Analysis

Data were taken every 100 sec during the flight. Spatial correlation was trivial, as the spectrometer was apparently fixed on the sun throughout. Ambient temperature was also recorded throughout. No other physical information was treated.

UNCLASSIFIED

UNCLASSIFIED

WILLOW RUN LABORATORIES

B. Prepared Data

Graphs were prepared and appear in the referenced report as follows:

- (1) Solar spectra as seen from altitudes between 270 and 40,000 ft (12 graphs)
- (2) Atmospheric emission spectra as seen from altitudes between 0 and 90,000 ft just before and just after dawn (5 graphs)

C. Conclusions

The concentration of "precipitable centimeters" of water vapor in the zenith above 40,000 ft has tentatively been found to be slightly lower than that reported by British and American workers.

REFERENCE Unclassified

C. Cumming et al., High Altitude Infrared Transmission and Emission Measurements, Report No. 288/59, CARDE, Valcartier, Quebec, November 1959, AD 314 351.

8.6. (U) THE ULTRAVIOLET SOLAR SPECTRUM: F. S. JOHNSON AND OTHERS

I. Instrument Description and Platform

A. General

High-altitude solar research was not possible until the development of rockets capable of carrying instrument payloads to heights above the tropopause. The first ultraviolet solar spectrum obtained by using such a rocket was recorded by the Naval Research Laboratory of the United States on 10 October 1946. The ultraviolet data from these experiments has been of value in determining the composition of the upper atmosphere, the heat balance in the atmosphere, and the structure of the sun's ultraviolet emission.

In this review, we shall summarize the characteristics of a series of ultraviolet solar measurements taken since the experiment of 10 October 1946. All of the works considered here were carried out under the auspices of the Naval Research Laboratory, Washington, D. C. V-2, Aerobee-High, and Viking research rockets were employed.

B, C, D. Instrumentation and Spectral and Spatial Information

This material appears in table IX.

TABLE IX. HIGH-ALTITUDE EXPERIMENTS INVOLVING ULTRAVIOLET SOLAR SPECTRA
Unclassified

Date of Launch	Instrument	Spectral Range (Å)	Resolution (Å)	Reference
10 August 1946	Aluminum-grating spectrograph	1700 to 2100		<u>Solar Research, Measurements of the Vertical Distribution, The Ultraviolet Spectrum</u>
2 April 1948	Aluminum-grating spectrograph	2100 to 3500		<u>The Ultraviolet Spectrum</u>
2 May 1948	Aluminum-grating spectrograph	2800 to 3000		<u>Measurements of the Vertical Distribution</u>
14 June 1949	Aluminum-grating spectrograph	2100 to 3500	0.6	<u>Direct Measurement, The Ultraviolet Spectrum, High-Altitude Diurnal Temperature Changes</u>
9 February 1950	Aluminum-grating spectrograph	2800 to 3500	0.6	<u>The Ultraviolet Spectrum</u>
3 September 1952	Aluminum-grating spectrograph	2800 to 3000	0.6	<u>The Ultraviolet Spectrum</u>
15 December 1952	Aluminum-grating spectrograph	1850 to 2700	0.8	<u>The Ultraviolet Spectrum, A Revised Analysis</u>
13 March 1959	Filtered camera	1215.67 $^1\text{H Lyman-}\alpha$ line	0.7	<u>Solar Research</u>
19 May 1960	High-resolution spectrograph	1215.67	0.04	<u>Solar Research</u>

UNCLASSIFIED

WILLOW RUN LABORATORIES

The aluminum-grating spectrograph mentioned in table IX was a two-in-one unit. The optic axis of one of them was fixed on the sun by a sun-seeking mechanism.

The grating was concave, ruled at 15,000 lines per inch and used at near-normal incidence. Eastman 103-0 film was used; it was ultraviolet sensitized with a coating of fluorescent lacquer.

In general, the spectral range in which usable data has been obtained from these experiments has extended from 2100 Å to 3400 Å at a resolution of 0.8 Å. Measurements down to 500 Å were made, but with decreased resolution.

The spectrometer was, at least in one instance, calibrated by using a "controlled carbon arc." (cf. Direct Measurement, p. 160).

E. Data Acquisition

The data in all cases consisted of spectra recorded on film that was recoverable from the rocket after the flight.

The data rate was as high as 1.2 photographs per second.

II. Data

A. Data Analysis

Up through the 1952 flight, the spectrograph films were analyzed by using a Leeds and Northrup microphotometer densitometer in conjunction with the empirical spectral radiance of a carbon arc. (cf. A Revised Analysis, p. 592).

The camera photographs of 1959 have been studied with respect to the composition and temperature of the sun's atmosphere. As mentioned above, the 19 April 1960 experiment yielded a high-resolution contour of the ${}_1\text{H}^1$ Lyman line. From these data, the density of hydrogen between the earth and the sun was determined, and the temperature of hydrogen on the sun was estimated to be between 1,000 and 2,000°K. (cf. Solar Research, p. 448).

B. Reduced and Prepared Data

In general, the spectrographic data have been used to determine the ozone distribution of the earth's atmosphere, the composition of the earth's atmosphere, and the composition and temperature of constituent elements of the sun.

UNCLASSIFIED

WILLOW RUN LABORATORIES

For additional information about these aspects of the data, appropriate references can be selected by title from the reference list included at the end of this review.

C. Error Statements

In general, the precision of the spectrographic measurements was felt to be sufficiently high so that variations in the data from different flights could be attributed to real variations in meteorological factors involved. (cf. Studies of the Ozone Layers, p. 192).

Also, the total atmospheric ozone above the New Mexico region has been, typically, 2 ± 0.20 mm of ozone. (cf. Studies of the Ozone Layer, p. 195).

REFERENCES Unclassified

- F. S. Johnson, "High-Altitude Diurnal Temperature Changes Due to Ozone Absorption," Bull. Am. Meteorol. Soc., Vol. 34, No. 3, March 1953, pp. 106-110.
- F. S. Johnson et al., "Direct Measurements of the Vertical Distribution of Atmospheric Ozone to 70 Kilometers Altitude," J. Geophys. Res., Vol. 57, No. 2, June 1952, pp. 157-176.
- F. S. Johnson et al., The Ultraviolet Spectrum of the Sun, U. S. Naval Research Laboratory, Washington, D. C.
- F. S. Johnson, J. D. Purcell, and R. Tousey, "Measurements of the Vertical Distribution of Atmospheric Ozone From Rockets," J. Geophys. Res., Vol. 56, No. 4, December 1951, pp. 583-955.
- F. S. Johnson, J. D. Purcell, and R. Tousey, Studies of the Ozone Layer Above New Mexico, U. S. Naval Research Laboratory, Washington, D. C., 1952.
- R. Tousey, "Solar Research from Rockets," Science, Vol. 134, No. 3477, August 1961, pp. 441-448.
- N. L. Wilson et al., "A Revised Analysis of the Solar Spectrum From 2990 to 2635 Å," Astrophys. J., Vol. 119, No. 3, May 1954.

UNCLASSIFIED

UNCLASSIFIED

WILLOW RUN LABORATORIES

DISTRIBUTION LIST

<u>Copy No.</u>	<u>Addressee</u>	<u>Copy No.</u>	<u>Addressee</u>
1-8	Advanced Research Projects Agency Washington, D. C. 20301 (1) ATTN: Dr. E. Rechin (2) ATTN: Dr. D. E. Mann (3) ATTN: Dr. J. P. Wade (4) ATTN: Mr. Kent Kresa (5) ATTN: Lt. Col. R. Dowe (8) ATTN: TIO	27	<u>U. S. AIR FORCE</u> Assistant Secretary of the Air Force (R&D) Pentagon Room 4E988 Washington, D. C. 20330
7-14	OSD—DDR&E Washington, D. C. 20301 (7) ATTN: Hon. John S. Foster Pentagon Room 3E1014 (8) ATTN: Assistant Director (DS) Pentagon Room 3D138 (9) ATTN: Assistant Director (RSGS) Pentagon Room 3E144 (10) ATTN: Assistant Director (IREW) Pentagon Room 3E120 (11) ATTN: Mr. C. McLain (SW) Pentagon Room 3E131 (12) ATTN: Mr. R. S. Sargent (DS) Pentagon Room 3D136 (13) ATTN: Deputy Director (S&SS) Pentagon Room 3E130 (14) ATTN: Assistant Director (SW) Pentagon Room 3E130	28	Headquarters USAF Pentagon Room 5D340 Washington, D. C. 20330 ATTN: Lt. Col. R. R. Moore (AFRDS)
	<u>U. S. ARMY</u>	29	Headquarters, USAF Pentagon Room 5D186 Washington, D. C. 20330 ATTN: Lt. Col. C. M. Waespy (AFRDS)
15	Assistant Secretary of the Army (R&D) Pentagon Room 3E390 Washington, D. C. 20350	30	Headquarters, USAF Pentagon Room 4D348 Washington, D. C. 20330 ATTN: Col. Curtis L. Scoville (AFRDD)
16-19	Department of the Army Army Ballistic Missile Defense Agency Commonwealth Building 1320 Wilson Boulevard Arlington, Virginia 22209 (16) ATTN: Dr. J. Gilstein (17) ATTN: Mr. A. Gold (18) ATTN: Dr. R. Norling (19) ATTN: Dr. John P. Penhune	31	Headquarters, USAF Washington, D. C. 20330 ATTN: AFRDDF—Lt. Col. Lewis
20	Department of the Army (OCRD) Pentagon Room 3E427 Washington, D. C. 20310 ATTN: Lt. Col. James Workman	32	Headquarters, USAF Pentagon Room 5E373 Washington, D. C. 20330 ATTN: Brig. Gen. W. R. Hedrick, Jr. Director of Space
21	Commanding General U. S. Army Sentinel Systems Command Redstone Arsenal, Alabama 35809 ATTN: SENS-C-Y	33	Air Force Systems Command Andrews Air Force Base Washington, D. C. 20331 ATTN: Lt. Col. J. I. Kendrick (SCLSB)
22	U. S. Army Sentinel System Office 206 N. Washington St. Alexandria, Virginia 22314 ATTN: Dr. Charles Johnson	34	Headquarters O. A. R. Architectural Building 1400 Wilson Boulevard Arlington, Virginia 22209 ATTN: Lt. Col. Thomas Jackson
23	NIKE-X Project Development Office P. O. Box 1500 West Station Huntsville, Alabama 35809 ATTN: Mr. Boyd C. Wooten, Jr.	35	Commander Air Force Western Test Range Vandenberg Air Force Base, California 93437 ATTN: Brig. Gen. C. J. Kronauer
24	Commanding General U. S. Army Missile Command Redstone Arsenal, Alabama 35809 ATTN: AMSM—RNS (Roy Bowen)	36-38	Commander Space and Missile Systems Organization Norton Air Force Base, California 92409 (36) ATTN: Brig. Gen. Robert Duffy, SMY (37) ATTN: Maj. Leon A. Borsvold, SMYSA (38) ATTN: Col. John Toomay, SMYSA
	<u>U. S. NAVY</u>	39	Commander Space and Missile Systems Organization Air Force Unit P. O. Los Angeles, California 90045 ATTN: Maj. William H. Hartung (SMASD)
25	Chief of Naval Operations Pentagon Room 5D568 Washington, D. C. 20350 ATTN: OP-972	40	Air Force Avionics Laboratory Wright Patterson AFB, Ohio 45433 ATTN: Mr. Luther H. Meuser
28	U. S. Naval Research Laboratory Washington, D. C. 20390 ATTN: D. P. McNutt (Code 7126)	41-43	Air Force Cambridge Research Laboratory L. G. Hanscom Field Bedford, Massachusetts 01731 (41) ATTN: Mr. John Garing (42) ATTN: Mr. R. Walker (43) ATTN: Mr. Alva Stair
			<u>OTHER GOVERNMENT</u>
		44	Defense Atomic Support Agency Atmospheric Effects Division Thomas Building 2020 14th Street, North Arlington, Virginia 22201 ATTN: Lt. Col. H. C. Fitz, Jr.

UNCLASSIFIED

WILLOW RUN LABORATORIES

<u>Copy No.</u>	<u>Addressee</u>	<u>Copy No.</u>	<u>Addressee</u>
45	Headquarters National Aeronautics and Space Administration Washington, D. C. 20548 ATTN: Mr. T. Michaels (Code REG)	61	University of Denver Denver Research Institute P. O. Box 8766 Denver, Colorado 80201 ATTN: David G. Murcray
46	NASA Langley Research Center Building 1298 M S 494 Hampton, Virginia 23385 ATTN: John A. Dodgen	62	General Electric Company Room 466, CSP, HMED Syracuse, New York 13206 ATTN: Mr. Burton Brown
47	National Bureau of Standards Meteorology Division Washington, D. C. 20234 ATTN: Mr. John C. Schleiter	63	General Electric Company Tempo Division 735 State Street Santa Barbara, California 93101 ATTN: Dr. Roy Hendricks
	CONTRACTORS		
48	University of Arizona Department of Astronomy Tucson, Arizona 85721 ATTN: Dr. A. B. Meinel	64-65	General Electric Company Missile and Space Vehicle Division P. O. Box 8555 Philadelphia, Pennsylvania 19101 (64) ATTN: James C. Burns (65) ATTN: T. R. Riethof
49	Aerospace Corporation Building 2 - Room 2310 Box 1306 1111 East Mill Street San Bernardino, California 92402 ATTN: Mr. Harold W. Robinson, Jr.	66-69	General Research Corporation P. O. Box 3587 Santa Barbara, California 93105 (66) ATTN: Dr. D. Luck (67) ATTN: Mr. B. Frederic (68) ATTN: Mr. V. Stull (69) ATTN: Mr. A. J. Kluge
50	Aerospace Corporation P. O. Box 95085 Los Angeles, California 90045 ATTN: Ivan Bekey	70	Honeywell, Incorporated 500 Washington Avenue, South Hopkins, Minnesota 55343 ATTN: Joseph Titus
51	Aerofel-General Corporation P. O. Box 296 Azusa, California 91702 ATTN: J. A. Jamieson	71	Honeywell, Incorporated Honeywell Radiation Center 2 Forbes Road Lexington, Massachusetts 02173 ATTN: William Wolfe
52	AVCO-Everett Research Laboratory 2385 Revere Beach Parkway Everett, Massachusetts 02149 ATTN: Michael H. Smolrich	72	Hughes Aircraft Company Centlinea and Teale Culver City, California 90230 ATTN: George F. Aroyan
53	Block Engineering 19 Blackstone Street Cambridge, Massachusetts 02139 ATTN: Patrick Friel	73-79	Institute for Defense Analyses 400 Army Navy Drive Arlington, Virginia 22202 (73) ATTN: Dr. E. Bauer (74) ATTN: Mr. C. Lerch (75) ATTN: Mr. W. VanZeeeland (76) ATTN: Dr. H. Wolfhard (77) ATTN: Dr. R. Turner (78) ATTN: Dr. J. Thomson (79) ATTN: Dr. A. J. Milton
54	Block Engineering LEPCO Division 459 South Main Street Logan, Utah 84321 ATTN: Claire Wyal	80	Lockheed Company Missile and Space Division 1111 Lockheed Way Sunnyvale, California 94088 ATTN: Robert E. Meyerott
55-56	Boeing Company P. O. Box 3707 Seattle, Washington 98124 (55) ATTN: Dr. Richard Montgomery (56) ATTN: Mr. George Thacker	81	Los Alamos Scientific Laboratory P. O. Box 1663 Los Alamos, New Mexico 87544 ATTN: Dr. Donald Kerr
57	Brown Engineering Research Park Sparkman Drive Huntsville, Alabama 35609 ATTN: Harry J. Watson	82-86	Massachusetts Institute of Technology Lincoln Laboratory P. O. Box 73 Lexington, Massachusetts 02173 (82) ATTN: Dr. M. A. Herlin (83) ATTN: Mr. R. J. Keyes (84) ATTN: Dr. S. Edelberg (85) ATTN: Mr. Robert Croper (86) ATTN: Mr. Eugene Cotton
58	Bell Telephone Laboratories, Incorporated Whippany, New Jersey 07981 ATTN: Dr. Kenneth B. McAfee		
59	University of California Institute for Pure and Applied Physical Sciences LaJolla, California 92037 ATTN: Dr. Sol. S. Penner		
60	University of California Department of Physics Santa Barbara, California 93108 ATTN: Prof. M. P. Broida		

UNCLASSIFIED

UNCLASSIFIED

WILLOW RUN LABORATORIES

<u>Copy No.</u>	<u>Addressee</u>	<u>Copy No.</u>	<u>Addressee</u>
87	The University of Michigan Infrared Information Analysis Center P. O. Box 618 Ann Arbor, Michigan 48107 ATTN: Dr. Thomas Limperia	96	RAND Corporation 1700 Main Street Santa Monica, California 90406 ATTN: Richard Hundley
88-92	The University of Michigan P. O. Box 618 Ann Arbor, Michigan 48107 (88) ATTN: George J. Zissis (89) ATTN: Richard Jamron (90) ATTN: Richard R. Legault (91) ATTN: Roy J. Nichols (92) ATTN: Robert Boggess	97	Riverside Research Institute 632 East 125th Street New York, New York 10027 ATTN: TOM Lihrary
93	McDonnell-Douglas Corporation 3000 Ocean Park Boulevard Santa Monica, California 90408 ATTN: David M. Karnea	98	Sperry-RAND Corporation Sperry-Gyroscope Division M/S H-1 Great Neck, New York 11020 ATTN: Irving Roth
94	North American Rockwell, Corporation Autonettes Division 3370 Miraloma Avenue Anahelm, California 92803 ATTN: Irvin H. Swift	99	Texas Instruments, Incorporated P. O. Box 5012 Dallas, Texas 75222 ATTN: Dr. R. O. Waganak
95	Phileo-Ford Company Ford Road Newport Beach, California 92663 ATTN: Darrell E. Burch	100	Utah State University Electrodynamics Laboratories Logan, Utah 84321 ATTN: Doran Baker
		101	Wayne State University Detroit, Michigan 48202 ATTN: Dr. Alex Thompson

UNCLASSIFIED

Security Classification

DOCUMENT CONTROL DATA - R & D

(Security classification of title, body of abstract and indexing annotation must be entered when the overall report is classified)

1. ORIGINATING ACTIVITY (Corporate author) Willow Run Laboratories, Institute of Science and Technology, The University of Michigan, Ann Arbor		2a. REPORT SECURITY CLASSIFICATION Confidential	
		2b. GROUP [Redacted]	
3. REPORT TITLE BACKGROUND MEASUREMENTS MADE ABOVE FIVE KILOMETERS: A SURVEY OF THE LITERATURE (U)			
4. DESCRIPTIVE NOTES (Type of report and inclusive dates)			
5. AUTHOR(S) (First name, middle initial, last name) Boyse, John W. Dittmar, Norman R. Farley, Frank D.			
6. REPORT DATE June 1969		7a. TOTAL NO. OF PAGES xi + 156	7b. NO. OF REFS 164
8a. CONTRACT OR GRANT NO. SD-91 and DAHC-15-67-C-0062		8a. ORIGINATOR'S REPORT NUMBER(S) 6054-16-X	
8b. PROJECT NO.		8b. OTHER REPORT NO(S) (Any other numbers that may be assigned this report)	
c.			
d.			
10. DISTRIBUTION STATEMENT In addition to security requirements which apply to this document and report, it may be further distributed to the holder only with specific prior approval. ARP. TI			
11. SUPPLEMENTARY NOTES		12. SPONSORING MILITARY ACTIVITY Advanced Research Projects Agency Department of Defense Washington, D. C.	
13. ABSTRACT This report reviews background measurements made from altitudes of 5 km or higher up to 1967. Optical backgrounds of all types, including solar spectra, have been considered. The review of each experiment includes information on the instruments used, spectral and spatial information, and information on the method of data collection and on the kind, format, and availability of the data obtained. (U)			

14 KEY WORDS	LINK A		LINK B		LINK C	
	ROLE	WT	ROLE	WT	ROLE	WT
Optical backgrounds Spectra Spectrum analyzers Radiometers Data recording Data analysis Spacecraft Clouds Horizon Earth Sun						