

UNCLASSIFIED

AD NUMBER

ADB003236

LIMITATION CHANGES

TO:

Approved for public release; distribution is unlimited.

FROM:

Distribution authorized to U.S. Gov't. agencies only; Test and Evaluation; FEB 1975. Other requests shall be referred to Air Force Flight Dynamics Laboratory, Wright-Patterson AFB, OH 45433.

AUTHORITY

AFWAL ltr dtd 18 Mar 1985

THIS PAGE IS UNCLASSIFIED

ADB003236 OFFICIAL FILE

AFFDL-TR-74-81

**VIBRATION AND ACOUSTIC ENVIRONMENT
OF OH-6A HELICOPTER CONFIGURED WITH AND
USING THE XM-27 ARMAMENT SYSTEM**

TECHNICAL REPORT AFFDL-TR-74-81

FEBRUARY 1975

Distribution limited to U.S. Government agencies only; test and evaluation; statement applied February 1975. Other requirements for this document must be referred to the Air Force Flight Dynamics Laboratory (FY), Wright-Patterson Air Force Base, Ohio 45433.

20080815 144

**AIR FORCE FLIGHT DYNAMICS LABORATORY
AIR FORCE SYSTEMS COMMAND
WRIGHT-PATTERSON AIR FORCE BASE, OHIO 45433**

NOTICE

When Government drawings, specifications, or other data are used for any purpose other than in connection with a definitely related Government procurement operation, the United States Government thereby incurs no responsibility nor any obligation whatsoever; and the fact that the government may have formulated, furnished, or in any way supplied the said drawings, specifications, or other data, is not to be regarded by implication or otherwise as in any manner licensing the holder or any other person or corporation, or conveying any rights or permission to manufacture, use, or sell any patented invention that may in any way be related thereto.

This technical report has been reviewed and is approved for publication.

PHYLLIS G. BOLDS
Project Monitor

FOR THE COMMANDER

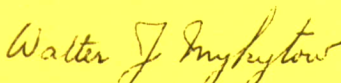
WALTER J. MYKYTOW
Ass't. for Research and Technology
Vehicle Dynamics Division

Copies of this report should not be returned unless return is required by security considerations, contractual obligations, or notice on a specific document.

UNCLASSIFIED

SECURITY CLASSIFICATION OF THIS PAGE (When Data Entered)

| REPORT DOCUMENTATION PAGE | | READ INSTRUCTIONS BEFORE COMPLETING FORM |
|---|-----------------------|---|
| 1. REPORT NUMBER AFFDL-TR-74-81 | 2. GOVT ACCESSION NO. | 3. RECIPIENT'S CATALOG NUMBER |
| 4. TITLE (and Subtitle) VIBRATION AND ACOUSTIC ENVIRONMENT OF OH-6A HELICOPTER CONFIGURED WITH AND USING THE XM-27 ARMAMENT SYSTEM | | 5. TYPE OF REPORT & PERIOD COVERED |
| | | 6. PERFORMING ORG. REPORT NUMBER |
| 7. AUTHOR(s) Virgil C. McIntosh Phyllis G. Bolts | | 8. CONTRACT OR GRANT NUMBER(s) |
| 9. PERFORMING ORGANIZATION NAME AND ADDRESS Air Force Flight Dynamics Laboratory Wright-Patterson Air Force Base, Ohio 45433 | | 10. PROGRAM ELEMENT, PROJECT, TASK AREA & WORK UNIT NUMBERS 62201F/147201 003 |
| 11. CONTROLLING OFFICE NAME AND ADDRESS AFFDL/FYT Wright-Patterson Air Force Base, Ohio 45433 | | 12. REPORT DATE February 1975 |
| | | 13. NUMBER OF PAGES 218 |
| 14. MONITORING AGENCY NAME & ADDRESS (if different from Controlling Office) | | 15. SECURITY CLASS. (of this report) Unclassified |
| | | 15a. DECLASSIFICATION/DOWNGRADING SCHEDULE |
| 16. DISTRIBUTION STATEMENT (of this Report) Distribution limited to U. S. Government Agencies only; test and evaluation; statement applied Feb 1975. Other requirements for this document must be referred to the Air Force Flight Dynamics Laboratory (FY), Wright-Patterson Air Force Base, Ohio 45433. | | |
| 17. DISTRIBUTION STATEMENT (of the abstract entered in Block 20, if different from Report) | | |
| 18. SUPPLEMENTARY NOTES This effort was planned and conducted jointly by AFFDL/FYT and the Mechanical Engineering Command (ECOM), Fort Monmouth, New Jersey. | | |
| 19. KEY WORDS (Continue on reverse side if necessary and identify by block number) Helicopter Vibration Gunfire Vibration Vibration Acoustics | | |
| 20. ABSTRACT (Continue on reverse side if necessary and identify by block number) Vibration and acoustic measurements were made on an OH-6A helicopter equipped with a XM-27 armament system to determine the vibration and acoustic environment throughout the vehicle. Tape recordings from 60 accelerometers and 11 micro- phones were made during all flight conditions including gunfire. Spectrum anal- yses were performed to obtain vibratory double amplitude (DA), acceleration power spectral density (PSD), and sound pressure level (SPL), versus frequency. | | |

UNCLASSIFIED

SECURITY CLASSIFICATION OF THIS PAGE(When Data Entered)

20. Abstract Contd

Amplitude probability density (APD) plots are included. Measured vibration and acoustic data are compared with military standards and specification requirements.

UNCLASSIFIED

SECURITY CLASSIFICATION OF THIS PAGE(When Data Entered)

FOREWORD

This effort was planned and conducted jointly by the Dynamics Technology Applications Branch, Vehicle Dynamics Division, Air Force Flight Dynamics Laboratory (AFFDL), Wright-Patterson AFB, Ohio, and the Mechanical Engineering Support Services Department, R&D Directorate, U. S. Army Electronics Command (ECOM), Fort Monmouth, New Jersey.

The investigation was conducted under Air Force Flight Dynamics Laboratory Project 1472, Dynamic Measurement and Analysis Technology for Military Vehicles, Task 1472-01, Dynamic Testing of Flight Vehicles, Work Unit 1472-01-003, Vibration and Acoustic Studies on Helicopters; and under internal U. S. Army Electronics Command, Engineering Support Services Department R&D DA Task No. 1H6 34301 D244 05 01, Airborne Shock and Vibration Study Program.

The helicopter was provided by the 55th U. S. Army Aviation Battalion, 3rd Corps, Fort Hood, Texas. The helicopter was piloted by Lt. Arthur Smaagaard, D Troop, 1st Calvary, at Fort Hood, Texas.

This report was submitted by the authors in February 1974.

AD B003236

TABLE OF CONTENTS

| SECTION | PAGE |
|---|------|
| I INTRODUCTION | 1 |
| II VEHICLE DESCRIPTION, INSTRUMENTATION, FLIGHT MEASUREMENT PROCEDURES, DATA REDUCTION AND PRESENTATION | 2 |
| 1. Vehicle Description | 2 |
| 2. Instrumentation | 2 |
| 3. Flight Measurement Procedures | 4 |
| 4. Data Reduction Procedures | 4 |
| 5. Data Presentation | 7 |
| III RESULTS | 9 |
| 1. General | 9 |
| 2. Vibration without Gunfire | 9 |
| 3. Vibration with Gunfire | 11 |
| 4. Sound Pressure Levels without Gunfire | 12 |
| 5. Sound Pressure Levels with Gunfire | 13 |
| 6. Amplitude Probability Density | 13 |
| IV CONCLUSIONS | 15 |
| V RECOMMENDATIONS | 17 |
| REFERENCES | 18 |

LIST OF ILLUSTRATIONS

| FIGURE | PAGE |
|---|------|
| 1. OH-6A Helicopter, S/N12954, with XM-27 Armament | 25 |
| 2. OH-6A Helicopter, S/N 12954, with XM-27 Armament - Doors Off | 26 |
| 3. Flight Instrumentation | 27 |
| 4. Piezoelectric Accelerometer Locations | 28 |
| 5. Low Frequency Accelerometer Locations | 29 |
| 6. Microphone Locations | 30 |
| 7. Piezoelectric Accelerometers, Instrument Panel, Right Side, Sta. 44, PUID's 5, 6, 7 | 31 |
| 8. Piezoelectric Accelerometers, Instrument Pedestal, Center Sta. 56, PUID's 8, 9, 10 | 32 |
| 9. Piezoelectric Accelerometers, Left Engine Mount Interface, Sta. 121, PUID's 13, 14, 15 | 33 |
| 10. Piezoelectric Accelerometers, Electronic Compartment, Left Side, AN/ARC-54, Sta. 62, PUID's 17, 18, 19 | 34 |
| 11. Piezoelectric Accelerometers, Left Side, AN/ARC-54, Sta. 58, PUID's 20, 21, 22 | 35 |
| 12. Piezoelectric Accelerometers, Tail Section, Center, Sta. 220, PUID's 25, 26, 27 | 36 |
| 13. Piezoelectric Accelerometers, Electronic Compartment, Right Side, AN/ARC-51 Sta. 62, PUID's 29, 30, 31 | 37 |
| 14. Piezoelectric Accelerometers, Electronic Compartment, Right Side, AN/ARC-51 Sta. 55, PUID's 32, 33, 34 | 38 |
| 15. Piezoelectric Accelerometers, Cabin Floor Left Side, Sta. 110, PUID's 41, 42, 43 | 39 |
| 16. Piezoelectric Accelerometers, Cabin Floor Right Side, Sta. 110, PUID's 44, 45, 46 | 40 |
| 17. Piezoelectric Accelerometers, XM-27 Armament Mount, Sta. 92, PUID's 53, 54, 55 | 41 |
| 18. Piezoelectric Accelerometers, ADF Antenna Interface, Sta. 69, PUID's 65, 66, 67 | 42 |

LIST OF ILLUSTRATIONS (Contd)

| FIGURE | PAGE |
|---|------|
| 19. Low Frequency Accelerometers, Instrument Panel, Left Side, Sta. 43, PUID's 4, 16, 28 | 43 |
| 20. Low Frequency Accelerometer, Lateral, Instrument Panel Base, Left Side, Sta. 39, PUID 40 | 44 |
| 21. Low Frequency Accelerometer, Vertical, Instrument Panel Base, Left Side, Sta. 39, PUID 49 | 45 |
| 22. Low Frequency Accelerometers, Cabin Floor, Right Side, Sta. 90, PUID's 50, 61 | 46 |
| 23. Low Frequency Accelerometers, Fuselage-Tail Section Interface, Sta. 130, PUID's 51, 63 | 47 |
| 24. Low Frequency Accelerometer, Cabin Floor, Left Side, Sta. 90, PUID 59 | 48 |
| 25. Microphone, Cabin Firewall, Right Side, Sta. 122, PUID 12 | 49 |
| 26. Microphone, Cabin Firewall, Left Side, Sta. 122, PUID 24 | 50 |
| 27. Microphone, Electronics Compartment, Right Side, Sta. 66, PUID 36 | 51 |
| 28. Microphone, Pilot's Helmet, Right Side, Sta. 72, PUID 48 | 52 |
| 29. Microphone, Copilot's Helmet, Left Side, Sta. 72, PUID 60 | 53 |
| 30. Microphone, Top of Fuselage, Outside, Sta. 27, PUID 68 | 54 |
| 31. Microphone, XM-27 Armament Gun Pod, Sta. 90, PUID 69 | 55 |
| 32. Microphone, Top of Fuselage, Outside, Sta. 165, PUID 70 | 56 |
| 33. Microphone, Top of Fuselage, Outside, Sta. 200, PUID 71 | 57 |
| 34. Nose Section and Cockpit, without Gunfire | 58 |
| 35. Passenger Compartment, without Gunfire | 59 |

LIST OF ILLUSTRATIONS (Contd)

| FIGURE | PAGE |
|---|------|
| 36. Engine - Transmission Compartment, without Gunfire | 60 |
| 37. Tail Boom, without Gunfire | 61 |
| 38. Nose Section and Cockpit, with Gunfire | 62 |
| 39. Passenger Compartment, with Gunfire | 63 |
| 40. Engine-Transmission Compartment, with Gunfire | 64 |
| 41. Tail Boom, with Gunfire | 65 |
| 42. Vertical, Lateral, and Fore and Aft, Main Rotor Transmission Interface, Right Rear Support, Sta. 108, without Gunfire | 66 |
| 43. Vertical, Lateral, and Fore and Aft, Instrument Panel, Right Side, Sta. 44, without Gunfire | 67 |
| 44. Vertical, Lateral, and Fore and Aft, Instrument Pedestal, Center, Sta. 56, without Gunfire | 68 |
| 45. Vertical, Lateral, and Fore and Aft, Cabin Floor, Center, Sta. 88, without Gunfire | 69 |
| 46. Vertical, Lateral and Fore and Aft, Left Engine Mount, Interface, Sta. 121, without Gunfire | 70 |
| 47. Vertical, Lateral, and Fore and Aft, Electronics Comp., Left Side, AN/ARC-54, Sta. 62, without Gunfire | 71 |
| 48. Vertical, Lateral, and Fore and Aft, Electronics Comp., Left Side, AN/ARC-54, Sta. 58, without Gunfire | 72 |
| 49. Vertical, Lateral and Fore and Aft, Tail Section, Center, Sta. 220, without Gunfire | 73 |
| 50. Vertical, Lateral, and Fore and Aft, Electronics Comp., Right Side, AN/ARC-51, Sta. 62, without Gunfire | 74 |
| 51. Vertical, Lateral, and Fore and Aft, Electronics Comp., Right Side, AN/ARC-51, Sta. 55, without Gunfire | 75 |
| 52. Vertical, Lateral and Fore and Aft, Tail Section Near 90° Gear Box, Sta. 273, without Gunfire | 76 |
| 53. Vertical, Lateral, and Fore and Aft, Cabin Floor, Left Side, Sta. 110, without Gunfire | 77 |

LIST OF ILLUSTRATIONS (Contd)

| FIGURE | PAGE |
|---|------|
| 54. Vertical, Lateral, and Fore and Aft, Cabin Floor, Right Side, Sta. 110, without Gunfire | 78 |
| 55. Vertical, Lateral, and Fore and Aft, XM-27 Armament Mount, Sta. 92, without Gunfire | 79 |
| 56. Vertical, Lateral, and Fore and Aft, Directional Gyro Shelf, Left Side, Sta. 70, without Gunfire | 80 |
| 57. Vertical, Lateral, and Fore and Aft, ADF Antenna Interface Sta. 69 without Gunfire | 81 |
| 58. Vertical, Lateral, and Fore and Aft, Instrument Panel, Left Side, Sta. 43, without Gunfire | 82 |
| 59. Vertical and Lateral, Instrument Panel Base, Left Side, Sta. 39, without Gunfire | 83 |
| 60. Vertical and Lateral, Cabin Floor, Right Side, Sta. 90, without Gunfire | 84 |
| 61. Vertical and Lateral, Fuselage-Tail Section Interface, Sta. 130, without Gunfire | 85 |
| 62. Vertical and Lateral, Tail Section, Near 90° Gear Box, Sta. 273, without Gunfire | 86 |
| 63. Vertical, Cabin Floor, Left Side, Sta. 90, without Gunfire | 87 |
| 64. Vertical, Lateral and Fore and Aft, Main Rotor Transmission Interface, Right Rear Support, Sta. 108, with Gunfire | 88 |
| 65. Vertical, Lateral, and Fore and Aft, Instrument Panel, Right Side, Sta. 44, with Gunfire | 89 |
| 66. Vertical, Lateral, and Fore and Aft, Instrument Pedestal, Center, Sta. 56, with Gunfire | 90 |
| 67. Vertical, Lateral, and Fore and Aft, Cabin Floor, Center Sta. 88, with Gunfire | 91 |
| 68. Vertical, Lateral and Fore and Aft, Left Engine Mount Interface, Sta. 121, with Gunfire | 92 |

LIST OF ILLUSTRATIONS (Contd)

| FIGURE | PAGE |
|---|------|
| 69. Vertical, Lateral and Fore and Aft, Electronics Comp., Left Side, AN/ARC-54, Sta. 62, with Gunfire | 93 |
| 70. Vertical, Lateral, and Fore and Aft, Electronics Comp., Left Side, AN/ARC-54, Sta. 58, with Gunfire | 94 |
| 71. Vertical, Lateral, and Fore and Aft, Tail Section, Center, Sta., 220, with Gunfire | 95 |
| 72. Vertical, Lateral, and Fore and Aft, Electronics Comp., Right Side, AN/ARC-51, Sta. 62, with Gunfire | 96 |
| 73. Vertical, Lateral, and Fore and Aft, Electronics Comp., Right Side, AN/ARC-51, Sta. 55, with Gunfire | 97 |
| 74. Vertical, Lateral, and Fore and Aft, Tail Section Near 90° Gear Box, Sta. 273, with Gunfire | 98 |
| 75. Vertical, Lateral, and Fore and Aft, Cabin Floor, Left Side, Sta. 110, with Gunfire | 99 |
| 76. Vertical, Lateral, and Fore and Aft, Cabin Floor, Right Side, Sta. 110, with Gunfire | 100 |
| 77. Vertical, Lateral, and Fore and Aft, XM-27 Armament Mount, Sta. 92, with Gunfire | 101 |
| 78. Vertical, Lateral, and Fore and Aft, Directional Gyro Shelf, Left Side, Sta. 70, with Gunfire | 102 |
| 79. Vertical, Lateral, and Fore and Aft, ADF Antenna Interface, Sta. 69, with Gunfire | 103 |
| 80. Vertical, Lateral, and Fore and Aft, Instrument Panel, Left Side, Sta. 43, with Gunfire | 104 |
| 81. Vertical and Lateral, Instrument Panel Base, Left Side, Sta. 39, with Gunfire | 105 |
| 82. Vertical and Lateral, Cabin Floor, Right Side, Sta. 90, with Gunfire | 106 |
| 83. Vertical and Lateral, Fuselage-Tail Section Interface, Sta. 130, with Gunfire | 107 |
| 84. Vertical and Lateral, Tail Section, Near 90° Gear Box, Sta. 273, with Gunfire | 108 |

LIST OF ILLUSTRATIONS (Contd)

| FIGURE | PAGE |
|---|------|
| 85. Vertical, Cabin Floor, Left Side, Sta. 90, with Gunfire | 109 |
| 86. Vertical, Lateral, and Fore and Aft, Main Rotor Transmission Interface, Right Rear Support, Sta. 108, without Gunfire | 110 |
| 87. Vertical, Lateral, and Fore and Aft, Instrument Panel, Right Side, Sta. 44, without Gunfire | 111 |
| 88. Vertical, Lateral, and Fore and Aft, Instrument Pedestal, Center, Sta. 56, without Gunfire | 112 |
| 89. Vertical, Lateral, and Fore and Aft, Cabin Floor, Center, Sta. 88, without Gunfire | 113 |
| 90. Vertical, Lateral, and Fore and Aft, Left Engine Mount Interface, Sta. 121, without Gunfire | 114 |
| 91. Vertical, Lateral, and Fore and Aft, Electronics Comp., Left Side, AN/ARC-54, Sta. 62, without Gunfire | 115 |
| 92. Vertical, Lateral, and Fore and Aft, Electronics Comp., Left Side, AN/ARC-54, Sta. 58, without Gunfire | 116 |
| 93. Vertical, Lateral, and Fore and Aft, Tail Section, Center, Sta. 220, without Gunfire | 117 |
| 94. Vertical, Lateral, and Fore and Aft, Electronics Comp., Right Side, AN/ARC-51, Sta. 62, without Gunfire | 118 |
| 95. Vertical, Lateral and Fore and Aft, Electronics Comp., Right Side, AN/ARC-51, Sta. 55, without Gunfire | 119 |
| 96. Vertical, Lateral, and Fore and Aft, Tail Section Near 90° Gear Box, Sta. 273, without Gunfire | 120 |
| 97. Vertical, Lateral, and Fore and Aft, Cabin Floor, Left Side, Sta. 110, without Gunfire | 121 |
| 98. Vertical, Lateral, and Fore and Aft, Cabin Floor, Right Side, Sta. 110, without Gunfire | 122 |

LIST OF ILLUSTRATIONS (Contd)

| FIGURE | PAGE |
|---|------|
| 99. Vertical, Lateral, and Fore and Aft, XM-27 Armament Mount, Sta. 92, without Gunfire | 123 |
| 100. Vertical, Lateral and Fore and Aft, Directional Gyro Shelf, Left Side, Sta. 70, without Gunfire | 124 |
| 101. Vertical, Lateral, and Fore and Aft, ADF Antenna Interface, Sta. 69, without Gunfire | 125 |
| 102. Vertical, Lateral and Fore and Aft, Instrument Panel, Left Side, Sta. 43, without Gunfire | 126 |
| 103. Vertical and Lateral, Instrument Panel Base, Left Side, Sta. 39, without Gunfire | 127 |
| 104. Vertical and Lateral, Cabin Floor, Right Side, Sta. 90, without Gunfire | 128 |
| 105. Vertical and Lateral, Fuselage-Tail Section Interface, Sta. 130, without Gunfire | 129 |
| 106. Vertical and Lateral, Tail Section, Near 90° Gear Box, Sta. 273, without Gunfire | 130 |
| 107. Vertical, Cabin Floor, Left Side, Sta. 90, without Gunfire | 131 |
| 108. Vertical, Lateral, and Fore and Aft, Main Rotor Transmission Interface, Right Rear Support, Sta. 108, with Gunfire | 132 |
| 109. Vertical, Lateral, and Fore and Aft, Instrument Panel, Right Side, Sta. 44, with Gunfire | 133 |
| 110. Vertical, Lateral, and Fore and Aft, Instrument Pedestal Center, Sta. 56, with Gunfire | 134 |
| 111. Vertical, Lateral, and Fore and Aft, Cabin Floor, Center, Sta. 88, with Gunfire | 135 |
| 112. Vertical, Lateral, and Fore and Aft, Left Engine Mount Interface, Sta. 121, with Gunfire | 136 |
| 113. Vertical, Lateral, and Fore and Aft, Electronics Comp., Left Side, AN/ARC-54, Sta. 62, with Gunfire | 137 |
| 114. Vertical, Lateral, and Fore and Aft, Electronics Comp., Left Side, AN/ARC-54, Sta. 58, with Gunfire | 138 |

LIST OF ILLUSTRATIONS (Contd)

| FIGURE | PAGE |
|---|------|
| 115. Vertical, Lateral, and Fore and Aft, Tail Section Center, Sta. 220, with Gunfire | 139 |
| 116. Vertical, Lateral, and Fore and Aft, Electronics Comp., Right Side, AN/ARC-51, Sta. 62, with Gunfire | 140 |
| 117. Vertical, Lateral, and Fore and Aft, Electronics Comp., Right Side, AN/ARC-51, Sta. 55, with Gunfire | 141 |
| 118. Vertical, Lateral, and Fore and Aft, Tail Section Near 90° Gear Box, Sta. 273, with Gunfire | 142 |
| 119. Vertical, Lateral, and Fore and Aft, Cabin Floor, Left Side, Sta. 110, with Gunfire | 143 |
| 120. Vertical, Lateral and Fore and Aft, Cabin Floor, Right Side, Sta. 110, with Gunfire | 144 |
| 121. Vertical, Lateral, and Fore and Aft, XM-27 Armament Mount, Sta. 92, with Gunfire | 145 |
| 122. Vertical, Lateral, and Fore and Aft, Directional Gyro Shelf, Left Side, Sta. 70, with Gunfire | 146 |
| 123. Vertical, Lateral, and Fore and Aft, ADF Antenna Interface, Sta. 69, with Gunfire | 147 |
| 124. Vertical, Lateral, and Fore and Aft, Instrument Panel, Left Side, Sta. 43, with Gunfire | 148 |
| 125. Vertical, Lateral, Instrument Panel Base, Left Side, Sta. 39, with Gunfire | 149 |
| 126. Vertical and Lateral, Cabin Floor, Right Side, Sta. 90, with Gunfire | 150 |
| 127. Vertical, and Lateral, Fuselage-tail Section Interface, Sta. 130, with Gunfire | 151 |
| 128. Vertical and Lateral, Tail Section, Near 90° Gear Box, Sta. 273, with Gunfire | 152 |
| 129. Vertical, Cabin Floor, Left Side, Sta. 90, with Gunfire | 153 |
| 130. Cabin Firewall, Right Side, Sta. 122, without Gunfire | 154 |

LIST OF ILLUSTRATIONS (Contd)

| FIGURE | PAGE |
|--|------|
| 131. Cabin Firewall, Left Side, Sta. 122, without Gunfire | 155 |
| 132. Electronics Comp., Right Side, Sta. 66, without Gunfire | 156 |
| 133. Pilot's Helmet, Right Side, Sta. 72, without Gunfire | 157 |
| 134. Copilot's Helmet, Left Side, Sta. 72, without Gunfire | 158 |
| 135. Nose Tip, Outside, Sta. 27, without Gunfire | 159 |
| 136. XM-27 Armament Gun Pod, Sta. 90, without Gunfire | 160 |
| 137. Top of Fuselage, Outside, Sta. 165, without Gunfire | 161 |
| 138. Top of Fuselage, Outside, Sta. 200, without Gunfire | 162 |
| 139. Top of Fuselage, Outside, Sta. 243, without Gunfire | 163 |
| 140. Cabin Firewall, Right Side, Sta. 122, with Gunfire | 164 |
| 141. Cabin Firewall, Left Side, Sta. 122, with Gunfire | 165 |
| 142. Electronics Comp., Right Side, Sta. 66, with Gunfire | 166 |
| 143. Pilot's Helmet, Right Side, Sta. 72, with Gunfire | 167 |
| 144. Nose Tip, Outside, Sta. 27, with Gunfire | 168 |
| 145. XM-27 Armament Gun Pod, Sta. 90, with Gunfire | 169 |
| 146. Top of Fuselage, Outside, Sta. 165, with Gunfire | 170 |
| 147. Top of Fuselage, Outside, Sta. 200, with Gunfire | 171 |
| 148. Top of Fuselage, Outside, Sta. 243, with Gunfire | 172 |
| 149. Nose Section and Cockpit, without Gunfire | 173 |
| 150. Passenger Compartment, without Gunfire | 174 |
| 151. Engine-Transmission Compartment, without Gunfire | 175 |
| 152. Tail Boom, without Gunfire | 176 |
| 153. Nose Section and Cockpit, with Gunfire | 177 |
| 154. Passenger Compartment, with Gunfire | 178 |

LIST OF ILLUSTRATIONS (Contd)

| FIGURE | PAGE |
|--|------|
| 155. Engine-Transmission Compartment, with Gunfire | 179 |
| 156. Tail Boom, with Gunfire | 180 |
| 157. Entire Helicopter, without Gunfire | 181 |
| 158. Entire Helicopter, with Gunfire | 182 |
| 159. Entire Helicopter, without Gunfire | 183 |
| 160. Entire Helicopter, with Gunfire | 184 |
| 161. Sinusoidal Input | 185 |
| 162. Random Gaussian Input | 186 |
| 163. Ratio of Random to Sinusoidal Component of 1:1 | 187 |
| 164. Ratio of Random to Sinusoidal Component of 1:2 | 188 |
| 165. Ratio of Random to Sinusoidal Component of 1:5 | 189 |
| 166. Acceleration APD in Electronics Compartment during Attack Maneuver, Vertical, 32 Hz Band | 190 |
| 167. Acceleration APD in Electronics Compartment during Attack Maneuver, Vertical, 64 Hz Band | 191 |
| 168. Acceleration APD in Electronics Compartment during Attack Maneuver, Vertical, 200 Hz Band | 192 |
| 169. Acceleration APD in Electronics Compartment during Attack Maneuver, Vertical, 382 Hz Band | 193 |
| 170. Acceleration APD in Electronics Compartment during Attack Maneuver, Vertical, 590 Hz Band | 194 |
| 171. Acceleration APD in Electronics Compartment during Gunfire, Vertical, 31 Hz Band | 195 |
| 172. Acceleration APD in Electronics Compartment during Gunfire, Vertical, 67 Hz Band | 196 |
| 173. Acceleration APD in Electronics Compartment during Gunfire, Vertical, 200 Hz Band | 197 |

LIST OF ILLUSTRATIONS (Contd)

| FIGURE | | PAGE |
|--------|---|------|
| 174. | Acceleration APD in Electronics Compartment during Gunfire, Vertical, 386 Hz Band | 198 |
| 175. | Acceleration APD in Electronics Compartment during Gunfire, Vertical, 700 Hz Band | 199 |

LIST OF TABLES

| TABLE | PAGE |
|--|------|
| I Honeywell Model 9050 Analyzer Characteristics | 5 |
| II Pickup Locations and Descriptions | 19 |
| III Flight Test Conditions | 22 |
| IV Flight Conditions Selected for Data Reduction | 23 |

SUMMARY

Vibration and acoustic measurements were made on an OH-6A helicopter equipped with and using the XM-27 Armament system to determine the vibration and acoustic environment throughout the vehicle. Tape recordings from 60 accelerometers and 11 microphones were made during all flight conditions including gunfire. Spectrum analyses were performed to obtain vibratory double amplitude (DA), acceleration power spectral density (PSD), and sound pressure level (SPL) versus frequency. Also, amplitude probability density (APD) plots are included. Measured vibration and acoustic data are compared with military standards and specification requirements.

SECTION I
INTRODUCTION

This report presents OH-6A Helicopter vibration and acoustic data obtained from the second of three flight surveys planned jointly by the Air Force Flight Dynamics Laboratory and the U. S. Army Electronics Command. The first in the series of helicopter vibration and acoustic study reports was AFFDL-TR-73-160, "Vibration and Acoustic Environment of the UH-1C Helicopter Configured With and Using M-5 and XM-21 Armament," February 1974. The third report is a complete acoustic and vibration survey of the AH-1G helicopter to be published in 1975. The objectives of the helicopter study programs are to obtain vibration, acoustic, and shock data suitable for (1) establishing realistic test methodologies, (2) developing and verifying vibration prediction methods applicable to rotor powered aircraft, (3) updating specifications, and (4) obtaining human acoustic environmental data.

SECTION II

VEHICLE DESCRIPTION, INSTRUMENTATION, FLIGHT MEASUREMENT PROCEDURES, DATA REDUCTION & PRESENTATION

1. VEHICLE DESCRIPTION

The OH-6A is a single-engine, four-place, helicopter manufactured by the Hughes Tool Company. Primary missions of this helicopter are visual observation, target acquisition, reconnaissance, and command control. When equipped with the XM-27 armament subsystem, it is capable of defense against ground based fire from automatic weapons and small arms. It is powered by an ALLISON T63-A-5A turbine engine rated at shaft horsepower (shp) at 600 (100%) rpm. Its maximum gross weight is 2400 pounds. The diameters of the four-bladed main rotor and the two-bladed tail rotor are 26 feet, 4 inches and 4 feet, 3 inches, respectively. Under rated power the main rotor operates at 475 rpm and the tail rotor at 3020 rpm. The fundamental frequencies of the main and tail rotors are 32 Hz and 100.6 Hz, respectively. Helicopter Serial No. 12954 used for this flight test program was equipped with the XM-27 armament subsystem consisting of a GAU 28/A 7.62 millimeter machine gun capable of firing rates of 2000 or 4000 rounds per minute. Photographs of the helicopter with doors on, and doors off, are shown in Figures 1 and 2.

2. INSTRUMENTATION

The flight instrumentation consisted of (1) 48 Endevco Corporation 2200 series piezoelectric accelerometers, (2) 12 Gulton Industries Model LA550203 low frequency accelerometers, (3) 11 Gulton Industries Model 229507 crystal microphones, (4) a 12-channel, 6-position selector switch, (5) a low frequency accelerometer attenuator box, (6) a 13-channel signal conditioning unit containing Fairchild Model ADO-24 operational amplifiers with external circuitry for continuously adjustable gain, (7) a voice microphone, (8) a magnetic sensor for indicating main rotor position and speed and (9) a 14-channel Genisco Inc. Model 10-110 tape recorder utilizing 30 ips tape speed and 54K Hz center frequency FM record amplifiers. Figure 3 shows the data recording system installed in the passenger compartment of the helicopter.

The 48 piezoelectric accelerometers were mounted at 16 points of interest, in groups of three, and oriented to sense vibration along the three major axes of the helicopter. Low frequency accelerometers were mounted on the instrument panel, right and left side of the cabin floor, fuselage-tail section interface, and tail boom. Microphones were mounted externally along the longitudinal axis and on the upper surface of the helicopter to sense blade passage excitation, externally on the armament mount, and internally on the pilot's and copilot's helmets, rear cabin bulkhead, and avionics compartment. A complete listing of all pickup locations, types, and identification numbers is contained in Table II. Figures 4, 5, and 6 are aircraft drawings showing the locations of piezoelectric accelerometers, low frequency accelerometers, and microphones, respectively. Figures 7-33 are photographs of pickup installations. All pickups were calibrated in the laboratory using the same cables, connections, and mounting brackets used during flight measurements. Accelerometer calibrations were conducted using a Calidyne Model 182 vibration exciter and an Unholtz-Dickie Model 610 RMG Dial-A-Gain vibration monitor. A General Radio Type 1552B sound level calibrator driven by a General Radio Type 1307A oscillator was used for calibrating the Gulton microphones. The frequency responses of the three types of pickups are summarized as follows:

Endevco Accelerometers: Flat within $\pm 5\%$ from 2-6000 Hz

Gulton Microphones: Flat within ± 2 dB from 2-6000 Hz and within ± 3 dB to 10K Hz

Low Frequency Accelerometers: Flat within $\pm 5\%$ from 0-60 Hz, and within ± 3 dB to 160 Hz

The accuracy limitations of the flight measurement system are due to error contributions from transducers, signal conditioning equipment, and tape recorder. The maximum error of any one of these elements is unlikely to exceed $\pm 5\%$ of full scale output. A reasonable estimate of the maximum likely overall error is the root-mean-square of the errors of the three contributors or $\pm 8.7\%$ of full scale output.

3. FLIGHT MEASUREMENT PROCEDURES

A total of four flights were conducted to obtain vibration and acoustic data. Measurements were made during all normal flight conditions with the cabin doors installed at a gross weight of 2300 pounds. Normal flight conditions included ground runup, takeoff, climb, level flight at various speeds and altitudes, hover, descent, autorotation, combat approach to landing, turns, sideward flight, and rearward flight. Measurements also were made with the cabin doors removed to simulate combat environment during level flight at 40, 80, and 100 knots IAS at 500 and 5000 feet altitude, and during combat approach maneuvers at maximum speed and rate of descent.

Measurements were made during gunfire at 2000 and 4000 rounds per minute with the doors installed and with the doors removed. Recordings were made with the gun deflected downward 20° or with the helicopter in a 20° dive. Table III contains a summary of flight test conditions.

For each flight condition, a 12-channel data sample of 20 seconds duration was generally recorded for each of the six selector switch positions. Thus, the output of each of the transducers was generally recorded for each flight condition. Flight conditions and aircraft performance parameters were recorded on a voice channel. Recorded information included altitude, airspeed, rate of climb or descent, pitch angle, roll angle, engine speed, main rotor speed, torque pressure, fuel weight, outside air temperature, and tail pipe temperature. The output from the rotor speed/position pickup was superimposed on the voice channel.

4. DATA REDUCTION PROCEDURES

In view of the very large amount of flight data gathered and other high priority work load, it was decided to screen the data and analyze only those records required to adequately define the amplitude range of the helicopter vibration and acoustic environment. This screening process involved playing back all records on a Honeywell Model 3170 tape

record/reproduce system and measuring the overall RMS levels on Bruel & Kjaer (B&K) Type 2305 level recorders. Data samples necessary to establish maximum, minimum, and average levels, and to indicate variation in environmental levels with flight parameters, were selected and analyzed in detail. Flight conditions selected for data analysis are described in Table IV.

Five-second loops of flight recordings were dubbed from the tape reels using the Honeywell record/reproduce system. Exceptions to this were that loops of gunfire tapes were of shorter duration due to the three-second firing limit of the gun. Piezoelectric and low frequency accelerometer data were played back on a Honeywell loop machine and analyzed on a Honeywell Model 9050, six-channel automatic wave analyzer. Performance characteristics of this analyzer were adjusted as follows:

TABLE I
HONEYWELL MODEL 9050 ANALYZER CHARACTERISTICS

| Effective Bandwidth (Hz) | Frequency Range (Hz) | True Averaging Time (Sec) | Scan Rate (Hz/sec) |
|--------------------------|----------------------|---------------------------|--------------------|
| 3 | 0-160 | 5 | 0.2 |
| 15 | 0-500 | 4.4 | 1.6 |
| 35 | 501-1000 | 2.0 | 7.0 |
| 75 | 1001-6000 | 1.0 | 22 |

The analyzer characteristics listed for the three Hz effective bandwidth were used for analyzing low frequency accelerometer data only. The analyzer produced transducer voltage levels versus frequency on six modified Brown strip-chart recorders in the frequency range of 0-6000 Hz. Data points were manually extracted at each frequency marker (each 20 Hz from 0 to 400 Hz; each 50 Hz from 401 to 1000 Hz; each 100 Hz from 1001 to 2000 Hz; and each 200 Hz from 2001 to 6000 Hz). Significant peaks in the spectrum also were tabulated.

The microphone data were analyzed on one-third octave B&K Type 2111 audio frequency spectrometers. Spectrometer outputs were recorded on B&K Type 2305 level recorders. Controls on the level recorders were set to obtain rms outputs and averaging time of 2.5 seconds. Data points from the level recorder charts were tabulated for each one-third octave in the frequency range of 12.5 to 10,000 Hz.

The tabulated voltage levels and frequencies from the spectrum analyzers and other identifying information were punched into IBM data cards. Corresponding decks of master cards containing descriptive information on pickup identification and sensitivity, flight conditions and vibration sources also were produced. The IBM card information together with formulas for computing double amplitude in inches, acceleration in g units, power spectral density in g^2/Hz and sound pressure level in decibels (re 0.0002 dynes/cm²) were fed to an IBM 7094 computer. Plot tapes were then generated by the computer which were used with a Calcomp Model 563 automatic plotter to obtain plots of double amplitude, power spectral density or sound pressure level versus frequency.

Amplitude probability density (APD) analyses of selected accelerometer outputs were conducted with a Gulon Industries statistical analyzer. The statistical analyzer controls were adjusted to obtain an amplitude range of ± 3 standard deviation units, a smoothing time constant of three seconds, and a scanning time of 450 seconds. The analog outputs of the analyzer (probability density and amplitude) were plotted on a Mosley Model 2DR-2, X-Y recorder. APD plots of both overall and narrowband filtered acceleration signals were obtained. Narrowband filtering was accomplished with a Spectral Dynamics SD-101A analyzer. Filter bandwidths of 5, 10, and 20 Hz were used in the frequency range of 5 to 100, 101 to 200, and 201 to 6000 Hz, respectively.

5. DATA PRESENTATION

Each frequency spectrum plot in this report portrays a summary of vibration or acoustic levels measured under various flight conditions by all transducers in one group, in one zone, or on the entire helicopter. Each group plot summarizes the data from either (1) a group of three piezoelectric accelerometers measuring vertical, lateral, and fore and aft vibration, (2) a group of one to three low frequency accelerometers, or (3) one microphone. Zone plots cover the (1) nose section and cockpit, (2) passenger compartment, (3) engine-transmission compartment, and (4) tail section.

Vibration data are presented in two forms: (1) double amplitude (DA) versus frequency, and (2) power spectral density (PSD) versus frequency. Low frequency and piezoelectric accelerometer data are plotted in the frequency ranges of 5 to 160 Hz and 5 to 6000 Hz, respectively. Sound pressure level (SPL) in db re 0.0002 dynes/cm² is plotted in one-third octave bands in the frequency range of 12.5 to 10,000 Hz. Percentile type plots are used for portraying all spectrum information. Each of these plots contains curves encompassing 99% and 90% of the data as well as curves for maximum, average, and minimum levels. For plotting purposes, the vibration spectrum is divided in frequency bands approximately one-third octave wide. In those instances where there are less than 100 data points in a frequency band, the maximum and the 99% level are plotted at the same point. If there are less than ten data points in a frequency band, the 90% level also coincides with the maximum.

Both double amplitude and power spectral density plots, with and without gunfire, have been prepared for each accelerometer. However, since there are a total of 236 of these plots, and since most recipients of the report would not require this data, plots for individual accelerometers are not included in this report. Organizations having a requirement for these plots may obtain copies by a special request to the Air Force Flight Dynamics Laboratory, (Attn: FYT), Wright-Patterson AFB, Ohio 45433, or from the U. S. Army Electronics Command (Attn: AMSEL-RD-GDM), Fort Monmouth, New Jersey.

AFFDL-TR-74-81

Separate plots are made for all flight conditions except gunfire and for gunfire. A summary of the various types of plots and corresponding figure numbers is contained in the latter part of the List of Illustrations.

SECTION III
RESULTS

1. GENERAL

In the following discussion of results, reference is made to vibration amplitudes in various frequency bands. These vibration amplitudes obviously are dependent on analyzer bandwidths. In applying these data to the development of test criteria, the bandwidths defined in Section II.4 of this report should be considered. Also the predominantly random nature of the vibration at frequencies above approximately 200 Hz should influence test criteria derived from these data.

2. VIBRATION WITHOUT GUNFIRE

Zone plots of double amplitude versus frequency (Figures 34-37) were compared with the sinusoidal vibration test curve, for equipment designed for helicopters, from MIL-STD-810B, Reference 1 (Figure 514-1, Curve M). This test curve was drawn on a transparent overlay and used to examine the DA plots. No consideration is given to time compression or fatigue testing techniques. This curve also is shown in Figure 34 which illustrates vibration amplitudes without gunfire in the nose section and cockpit of the helicopter where most of the electronic equipment is located.

Inspection of Figures 34-37 shows that the bulk of the data falls below the test curve in the frequency range below 500 Hz. Exceptions are listed as follows:

a. Figure 34, Nose Section and Cockpit: 0.12 inch DA at 10 Hz and 3g at 35 Hz.

b. Figure 36, Engine-transmission Compartment: 0.14 inch DA at 10 Hz, 3g at 30 Hz, and 4g at 40 Hz.

c. Figure 37, Tail Boom: 0.95 inch DA at 10 Hz, 3 to 4g at 20 to 50 Hz, and 6 to 10g at 150 to 400 Hz.

These figures also show that vibration amplitudes are much higher in the engine-transmission and tail boom areas than in the forward areas of the helicopter. It should be noted that although the MIL-STD-810B test curve extends to only 500 Hz, significant vibration exists at frequencies up to 5000 Hz. For example, Figure 35 indicates 2g from 700 to 900 Hz and 4g at 5000 Hz.

Figures 42-63 are group plots of DA versus frequency for each accelerometer location. These plots were inspected to obtain maximum amplitudes occurring in areas where electronic equipment is located. These maximum amplitudes are well below the MIL-STD-810B test curve except at 10 Hz where the test curve is exceeded slightly. Above 500 Hz (beyond the test curve) amplitudes are below 2g in electronic equipment areas.

In Figures 60 and 63, the vibration amplitudes obtained from low frequency accelerometers located on the cabin floor are compared with the maximum vibration requirements of MIL-H-8501A, Reference 2, Paragraph 3.7.1(C), for personnel stations in helicopters. The maximum amplitudes permitted by Paragraph 3.7.1(C) of MIL-H-8501A are 0.3g at frequencies below 44 Hz and 0.003 inch double amplitude at frequencies above 44 Hz. These amplitudes are exceeded on the OH-6A cabin floor in the frequency range of 18 to 55 Hz. Figure 60 for the right side of the cabin floor shows 1.2g at 35 Hz, 0.4g at 45 Hz, and 0.6g at 55 Hz. Figure 63 for the left side of the cabin floor indicates 0.5g at 18 Hz and 0.7g at 35 Hz. Otherwise vibration levels fall below MIL-H-8501A requirements.

A summary of vibration levels occurring on the entire helicopter for all flight conditions except gunfire is shown in the DA plot of Figure 156. This figure indicates maximum amplitudes near 5g at frequencies up to 200 Hz, and amplitudes near 10g at frequencies between 200 and 5000 Hz. A maximum amplitude of 50g is indicated at 5000 Hz.

The 99% curve (curve which includes 99% of the measured points) never exceeds 5g; the 90% curve is generally below 1g; and the average curve is generally below 0.5g.

The PSD group plots for flight conditions without gunfire are included in Figures 86-107. Seven of these 22 figures indicate maximum levels greater than $1g^2/Hz$, eight indicate levels between 0.1 and $1g^2/Hz$ and seven are below $0.1g^2/Hz$. Zone plots for PSD's without gunfire are shown in Figures 148-151 and the PSD summary plot for the complete helicopter is contained in Figure 158. These plots may be used to quickly determine levels that may occur in the various zones of the aircraft.

3. VIBRATION WITH GUNFIRE

Figures 38-41 are zone plots of DA versus frequency with gunfire. Comparison of these plots with those without gunfire (Figures 34-37) illustrate that amplitudes are much higher with gunfire at all locations except the tail boom. For example, Figure 34 for the nose section and cockpit without gunfire, indicates maximum amplitudes between 0.3 and 3g in the frequency range of 30 to 1000 Hz. Figure 38 for the same zone with gunfire indicates amplitudes ranging from 2 to 20g in the same frequency range. Group plots of DA versus frequency (Figures 64-85) also show much higher amplitudes during gunfire for all locations except the tail boom. The increase in vibration amplitudes from gunfire is greatest in the electronics compartment on the left side of the aircraft. This increase is illustrated by comparing Figures 47 and 48 for flight conditions without gunfire with Figures 69 and 70 for gunfire conditions. For example, Figure 47 indicates a maximum of 0.6g at 44 Hz while Figure 69 for the same location with gunfire indicates 20g at the same frequency. This location is on light structure and slightly forward of the minigun where high level gunfire vibration was expected. Comparison of PSD zone plots with gunfire (Figures 156-159) and PSD group plots with gunfire (Figures 108-219) with corresponding plots without gunfire (Figures 152-155 and 86-107) also show a large increase in vibration amplitudes except for positions on the tail boom.

4. SOUND PRESSURE LEVELS WITHOUT GUNFIRE

Figures 130-138 are sound pressure (SPL) plots without gunfire. The levels measured in the cabin area were compared with the requirements of MIL-A-8806A, Table IIIA, Reference 3 (for maximum continuous power), which applies to occupied spaces in aircraft where personnel must wear helmets. MIL-A-8806A requirements are specified in octave bands, while data in this report are presented in one-third octave bands. It was necessary to reduce the MIL-A-8806A levels by 4.8 db to obtain equivalent one-third octave band levels for making direct comparisons of specification levels with plotted data. These reduced levels are superimposed on Figures 134 and 135 for the pilot's and copilot's helmets. These figures illustrate that MIL-A-8806A levels are exceeded at the pilot's helmet by 2 to 5 db in frequency bands of 31.5, 100, 160, and 400 Hz, and by as much as 12 db at frequency bands above 1600 Hz. At the copilot's helmet, MIL-A-8806A levels are exceeded by 2 to 4 db at frequency bands of 31.5, 400 and 1600 Hz, and by as much as 10 db at frequencies above 1600 Hz. The revision to MIL-A-8806A, Reference 4, (MIL-S-008806B(USAF), Curve F) permits higher levels in occupied areas than those permitted by MIL-A-8806A. These higher levels exceed essentially all sound pressure levels measured at the pilot's and copilot's helmets without gunfire.

Figure 132 shows SPL's measured internally in the forward electronics compartment. One-third octave levels in this compartment are below 120 db and the maximum overall level is approximately 122 db. Since MIL-STD-810B, Reference 1, states that acoustic qualification tests should not be required for equipment installed where overall sound levels are below 130 db, acoustic tests do not appear to be justified by the "no gunfire" environment in the electronic equipment compartment.

Figures 134-138 are SPL plots from external microphones located on the nose tip, XM-27 armament pod, and on top of the fuselage. Maximum SPL levels for each of these locations occur in the 31.5 Hz frequency band (blade passage frequency), and levels range from 135 to 142 db. Overall levels at these locations range from 138 to 146 db.

5. SOUND PRESSURE LEVELS WITH GUNFIRE

Plots of SPL versus frequency with gunfire are contained in Figures 139-147. Figure 142 for the pilot's helmet shows that the spectrum peaks in the one-third octave band of 40 Hz at a level of 138 db, and the overall level is 144 db.

Figure 141 for the electronics compartment with gunfire illustrates one-third octave levels of approximately 135 db at frequencies of 100 and 500 Hz, and an overall level of approximately 140 db is indicated. According to MIL-STD-810B, acoustic qualification tests might be appropriate for acoustically sensitive equipment where noise levels are this high.

Sound pressure levels measured externally during gunfire are shown in Figures 143-147. Comparison of these levels with those shown in Figures 134-138 (without gunfire) show that the levels at the nose tip and armament pod are as much as 30 db higher during gunfire in the frequency range above 31.5 Hz. At locations farther aft on the fuselage, gunfire effects are less pronounced and levels do not increase greatly with gunfire. For example, comparison of Figure 147 with Figure 138 (Sta. 243) shows that maximum spectrum levels with gunfire are approximately the same as those obtained without gunfire.

6. AMPLITUDE PROBABILITY DENSITY

Knowledge of the relative amplitudes of sinusoidal and random components of flight vibration environment is necessary for the development of appropriate vibration testing criteria. The shapes of amplitude probability density (APD) plots of flight vibration are utilized to evaluate the sinusoidal versus random content of measured vibration. Standard APD plots of sinusoidal, random, and mixtures of sinusoidal and random signals were first prepared to illustrate shapes of APD curves for a wide range of mixtures. The characteristic shapes for a sine wave and for a random Gaussian signal are illustrated in Figures 161 and 162, respectively. Plots also were prepared for a mixture of a

100 Hz sine wave and a random signal having a flat spectrum from 20 to 1000 Hz. Figures 162-165 show that the random component must be reduced to less than the sinusoidal component before the shape of the APD plot differs appreciably from that for a pure random plot. The random component was reduced to one-fifth that of the sinusoidal component before the shape of the APD plot appeared to be more sinusoidal than random. Thus, the APD plot is a sensitive indicator of the presence of random components, but it is a relatively insensitive indicator of sinusoidal components.

Figures 166-175 are APD plots of vibration measured in the forward electronics compartment or on the cabin floor during an attack maneuver at 110 knots or during gunfire at 4000 rounds per minute. APD plots also were obtained for other locations and flight conditions, but since they duplicate the results illustrated in the above figures, they are not included herein. Comparison of the APD plots of Figures 166-175 with the mixed sinusoidal and random plots shows that the OH-6A vibration is predominantly sinusoidal in frequency bands up to 200 Hz. Vibration generally is more nearly random than sinusoidal in frequency bands above 200 Hz. These statements are true for all flight conditions, including gunfire.

SECTION IV
CONCLUSIONS

In the frequency range of 5 to 500 Hz for flight conditions without gunfire, vibration levels on the OH-6A helicopter in areas where electronic equipment is mounted generally are below the applicable sinusoidal vibration test curve of MIL-STD-810B (Reference 1).

Significant vibration occurs throughout the OH-6A helicopter in the frequency range of 500 to 5000 Hz. This frequency range is well beyond the 500 Hz upper limit of the test curve of MIL-STD-810B for helicopter equipment.

The vibration levels specified in MIL-H-8501A, Paragraph 3.7.1(C) for personnel stations in helicopters are exceeded during flight conditions without gunfire on the OH-6A cabin floor in the frequency range of 18 to 55 Hz. However, levels generally are below 1g.

OH-6A vibration levels increase considerably during gunfire at all locations except the tail boom. The greatest increase occurs forward of the minigun in the left side of the electronics compartment. In the 44 Hz frequency band at this location, the vibration level increases from 0.6g to 20g as the gun is fired.

Sound pressure levels without gunfire in the OH-6A cabin exceed levels specified in MIL-A-8806A, Table III, by 2 to 12 db in several frequency bands. However, these levels rarely exceed those specified by a revision to this specification, MIL-S-008806B(USAF), Reference 4, Curve F. Sound pressure levels increase during gunfire in the cabin area by as much as 30 db in some frequency bands.

Sound pressure levels without gunfire in equipment compartments are too low to cause significant equipment problems. Gunfire induced sound pressure levels (140 db, overall) could cause malfunctions of acoustically sensitive equipment.

AFFDL-TR-74-81

In frequency bands below 200 Hz, both with and without gunfire, OH-6A vibration is predominantly sinusoidal. In frequency bands above 200 Hz, vibration is more random than sinusoidal.

SECTION V
RECOMMENDATIONS

New vibration test criteria for helicopter equipment should be developed from the data analyses presented in this report. Separate sinusoidal vibration tests, at frequencies below approximately 200 Hz are recommended for different zones, as it is unrealistic to design and test all equipment according to data from the worst zone when particular equipment items will be installed in a milder vibration environment. These sinusoidal vibration tests should provide for dwell testing at blade passage frequencies and their harmonics. Since the data show that the helicopter vibration environment above 200 Hz is predominantly random, a random vibration test should be developed for the high frequencies. Also, separate tests should be developed for the gunfire vibration condition since the magnitudes of this type of vibration are significantly greater in severity than the regular flight vibration.

REFERENCES

1. "Military Standard Environmental Test Methods," MIL-STD-810B, Notice-1, October 1969.
2. "Helicopter Flying and Ground Handling Quantities; General Requirement for MIL-H-8501A," November 1961.
3. "Military General Specification for Sound Pressure Levels in Aircraft," MIL-H-8806A, July 1966.
4. "Military General Specification for Sound Pressure Levels in Aircraft," MIL-S-00806B (USAF), September 1970.

TABLE II
 PICKUP LOCATIONS AND DESCRIPTIONS

| PUID | Pickup Type | Direction | Location Description |
|------|-------------|-----------|---|
| 1 | Piezo | F&A | Main Rotor transmission Interface, Right Rear Support, Sta. 108 |
| 2 | Accel | Lat | |
| 3 | | Vert | |
| 5 | Piezo | F&A | Instrument Panel, Right Side, Sta. 44 |
| 6 | Accel | Lat | |
| 7 | | Vert | |
| 8 | Piezo | F&A | Instrument Pedestal, Center Sta. 56 |
| 9 | Accel | Lat | |
| 10 | | Vert | |
| 11 | Piezo | Lat | Cabin Floor, Center, Sta. 88 |
| 23 | Accel | F&A | |
| 62 | | Vert | |
| 13 | Piezo | F&A | Left Engine Mount Interface, Sta. 121 |
| 14 | Accel | Lat | |
| 15 | | Vert | |
| 17 | Piezo | F&A | Electronics Comp., Left Side AN/ARC-54, Sta. 62 |
| 18 | Accel | Lat | |
| 19 | | Vert | |
| 20 | Piezo | F&A | Electronics Comp., Left Side AN/ARC-54, Sta. 58 |
| 21 | Accel | Lat | |
| 22 | | Vert | |
| 25 | Piezo | F&A | Tail Section, Center, Sta. 220 |
| 26 | Accel | Lat | |
| 27 | | Vert | |
| 29 | Piezo | F&A | Electronics Comp., Right Side, AN/ARC-51, Sta. 62 |
| 30 | Accel | Lat | |
| 31 | | Vert | |
| 32 | Piezo | F&A | Electronics Comp., Right Side, AN/ARC-51, Sta. 55 |
| 33 | Accel | Lat | |
| 34 | | Vert | |
| 37 | Piezo | F&A | Tail Section Near 90° Gear Box, Sta. 273 |
| 38 | Accel | Lat | |
| 39 | | Vert | |

TABLE II (Contd)

| PUID | Pickup Type | Direction | Location Description |
|----------------|----------------------|--------------------|---|
| 41 42 43 | Piezo Accel | F&A Lat Vert | Cabin Floor, Left Side, Sta. 110 |
| 44 45 46 | Piezo Accel | F&A Lat Vert | Cabin Floor, Right Side, Sta. 110 |
| 53 54 55 | Piezo Accel | F&A Lat Vert | XM-27 Armament Mount, Sta. 92 |
| 56 57 58 | Piezo Accel | F&A Lat Vert | Directional Gyro Shelf, Left Side, Sta. 70 |
| 65 66 67 | Piezo Accel | F&A Lat Vert | ADF Antenna Interface, Sta. 69 |
| 4 16 28 | Low Freq Accel | Vert Lat F&A | Instrument Panel, Left Side, Sta. 43 |
| 40 49 | Low Freq Accel | Lat Vert | Instrument Panel Base, Left Side, Sta. 39 |
| 50 61 | Low Freq Accel | Vert Lat | Cabin Floor, Right Side, Sta. 90 |
| 51 63 | Low Freq Accel | Vert Lat | Fuselage-Tail Section Interface, Sta. 130 |
| 52 64 | Low Freq Accel | Vert Lat | Tail Section, Near 90° Gear Box, Sta. 280 |
| 59 | Low Freq Accel | Vert | Cabin Floor, Left Side, Sta. 90 |
| 12 | Piezo Microphone | Diaph up | Cabin Firewall, Right Side, Sta. 122 |
| 24 | Piezo Microphone | Diaph up | Cabin Firewall, Left Side, Sta. 122 |
| 35 | Piezo Microphone | Diaph up | Electronics Comp., Left Side, Sta. 66 |

TABLE II (Contd)

| PUID | Pickup Type | Direction | Location Description |
|------|---------------------|-------------------|---|
| 36 | Piezo Microphone | Diaph up | Electronics Comp., Right Side, Sta. 66 |
| 48 | Piezo Microphone | Diaph Forward | Pilot's Helment, Right Side, Sta. 72 |
| 60 | Piezo Microphone | Diaph Foreward | Copilot's Helmet, Left Side, Sta. 72 |
| 68 | Piezo Microphone | Diaph up | Nose Tip, Outside, Sta. 27 |
| 69 | Piezo Microphone | Diaph Forward | XM-27 Armament Gun Pod, Sta. 90 |
| 70 | Piezo Microphone | Diaph up | Top of Fuselage, Outside, Sta. 165 |
| 71 | Piezo Microphone | Diaph up | Top of Fuselage, Outside, Sta. 200 |
| 72 | Piezo Microphone | Diaph up | Top of Fuselage, Outside, Sta. 273 |

TABLE III
FLIGHT TEST CONDITIONS

| Condition | IAS (Knots) | Altitude (Feet) |
|--|----------------|--------------------|
| Ground Runup, 300-500 RPM | 0 | 0 |
| Taxi | 10 | 10 |
| Take-off | 0-35 | 0-500 |
| Hover | 0 | 0-5000 |
| Climb | 35-70 | 0-5000 |
| Level Flight, doors on and doors off | 20-120 | 8000-0 |
| Turn, right & left, 30°- 60° | 45-60 | 8000-500 |
| Autorotation and flare | 55-70 | 8000-0 |
| Standard descent | 58 | 4000-0 |
| Combat Approach, swing & spiral | 90-120 | 5000-0 |
| Sideward flight, right & left | 10 | 10 |
| Rearward flight | 5-10 | 500 |
| Attack maneuver | 110 | 500 |
| Gunfire, 2000 & 4000 rounds/min., 20° gun angle with 0° dive angle, 0° dive angle with 20° gun angle, 20° dive angle with doors off | 60-110 | 800-500 |
| Landing | 0 | 0 |

TABLE IV
 FLIGHT CONDITIONS SELECTED FOR DATA REDUCTION

| Condition | IAS (Knots) | Altitude (Feet) | PUID's |
|-------------------------|----------------|--------------------|--------|
| Ground Runup, 330 rpm | 0 | 0 | All |
| Ground Runup, 480 rpm | 0 | 0 | All |
| Hover in ground effects | 0 | 0-10 | All |
| Take-off, vertical | 0 | 0-500 | All |
| Level flight | 20 | 500 | All |
| Level flight | 20 | 5000 | All |
| Level flight | 20 | 8000 | All |
| Level flight | 40 | 500 | All |
| Level flight, doors off | 40 | 500 | All |
| Level flight | 40 | 5000 | All |
| Level flight | 40 | 8000 | All |
| Level flight | 60 | 500 | 49-60 |
| Level flight | 60 | 5000 | 49-60 |
| Level flight | 60 | 8000 | 49-60 |
| Level flight | 100 | 500 | All |
| Level flight, doors off | 100 | 500 | All |
| Level flight | 100 | 5000 | All |
| Level flight | 100 | 8000 | All |
| Level flight | 120 | 500 | All |
| Level flight | 110 | 5000 | All |
| Climb | 35 | 300-700 | All |
| Right turn, 30° | 55 | 500 | All |
| Right turn, 55° | 60 | 500 | All |
| Left turn, 30° | 55 | 500 | All |
| Left turn, 60° | 50 | 500 | All |
| Autorotation | 68 | 4000-0 | All |

TABLE IV (Contd)

| Condition | IAS (Knots) | Altitude (Feet) | PUID's |
|---|----------------|--------------------|--------|
| Standard descent | 58 | 4000-0 | All |
| Combat approach, swing | 120 | 2500-0 | All |
| Combat approach, spiral | 100 | 5000-0 | All |
| Combat approach, spiral, doors off | 98 | 5000-0 | All |
| Attack maneuver | 110 | 500 | All |
| Gunfire, 2000 rounds/min., 20° gun angle | 110 | 500 | All |
| Gunfire, 4000 rounds/min., 20° gun angle | 110 | 500 | All |
| Gunfire, 2000 rounds/min, 20° gun angle | 60 | 500 | 49-60 |
| Gunfire, 4000 rounds/min, 20° gun angle | 60 | 500 | 49-60 |
| Gunfire, 2000 rounds/min, 20° dive angle | 110 | 800-500 | All |
| Gunfire, 4000 rounds/min., 20° dive angle | 110 | 800-500 | 1-36 |
| Gunfire, 2000 rounds/min., 20° dive angle, doors off | 110 | 800-500 | All |
| Gunfire, 4000 rounds/min., 20° dive angle, doors off | 110 | 800-500 | 1-12 |

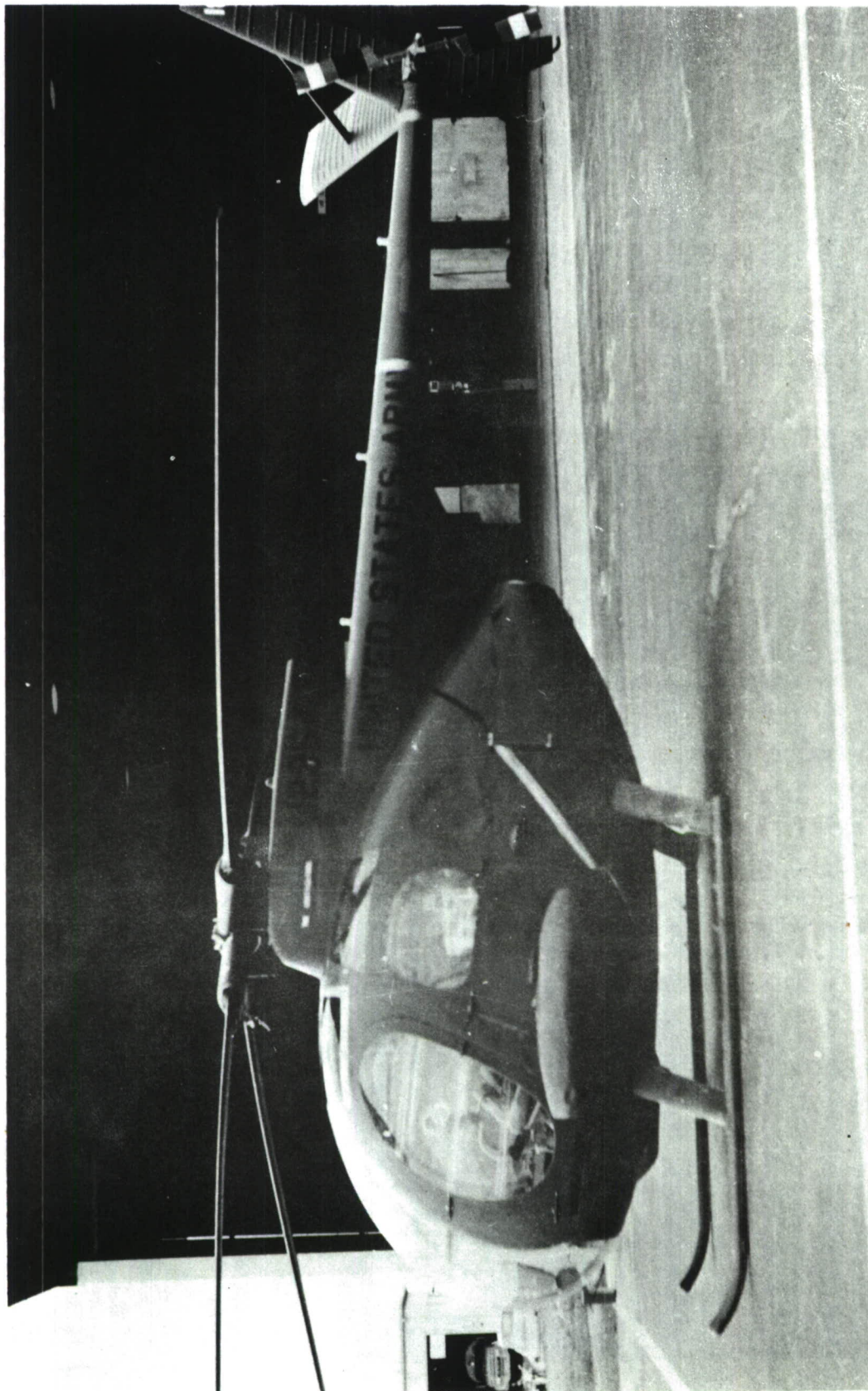

Figure 1. OH-6A Helicopter, S/N12954, with XM-27 Armament

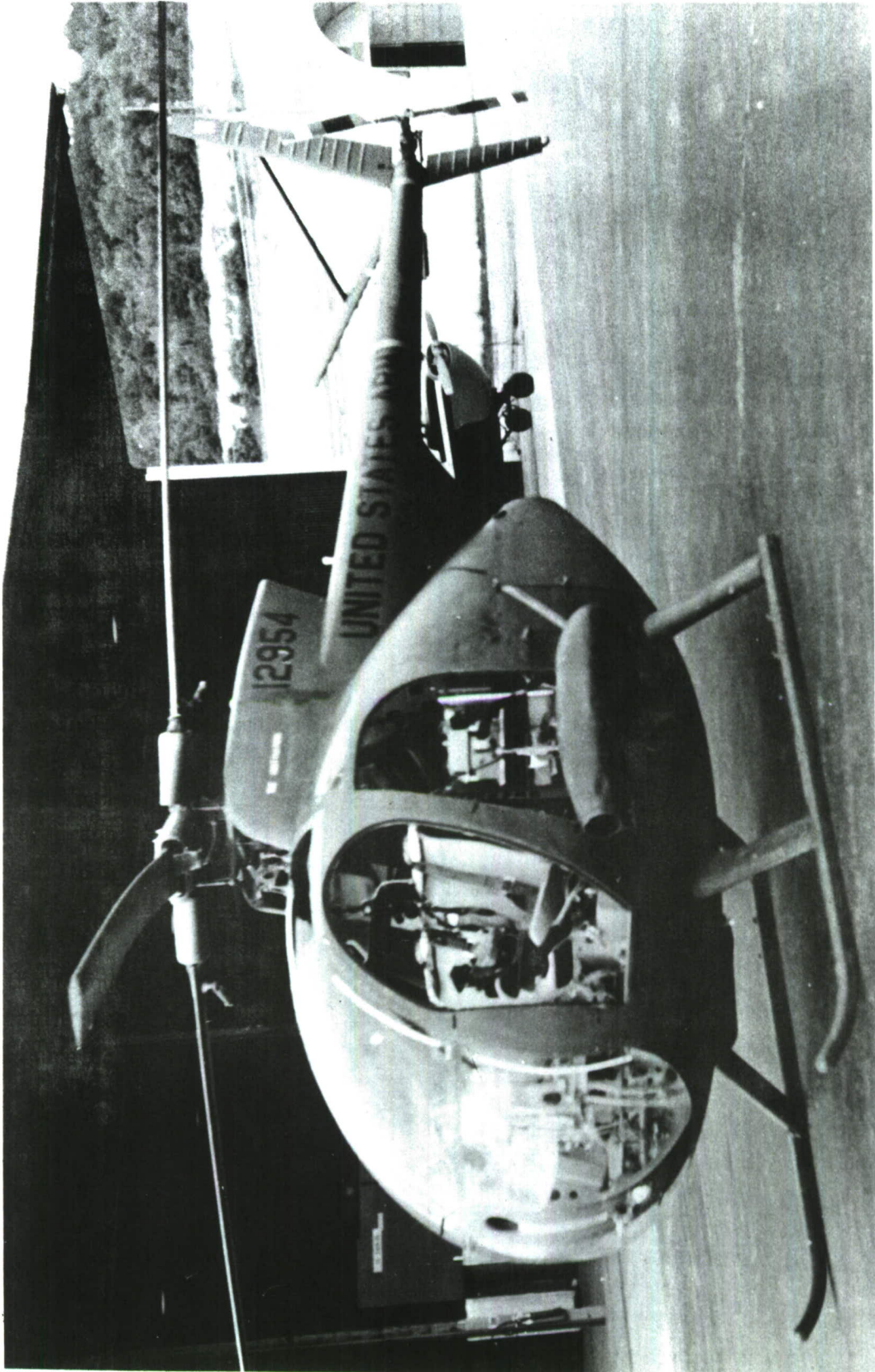

Figure 2. OH-6A Helicopter, S/N 12954, with XM-27 Armament - Doors Off

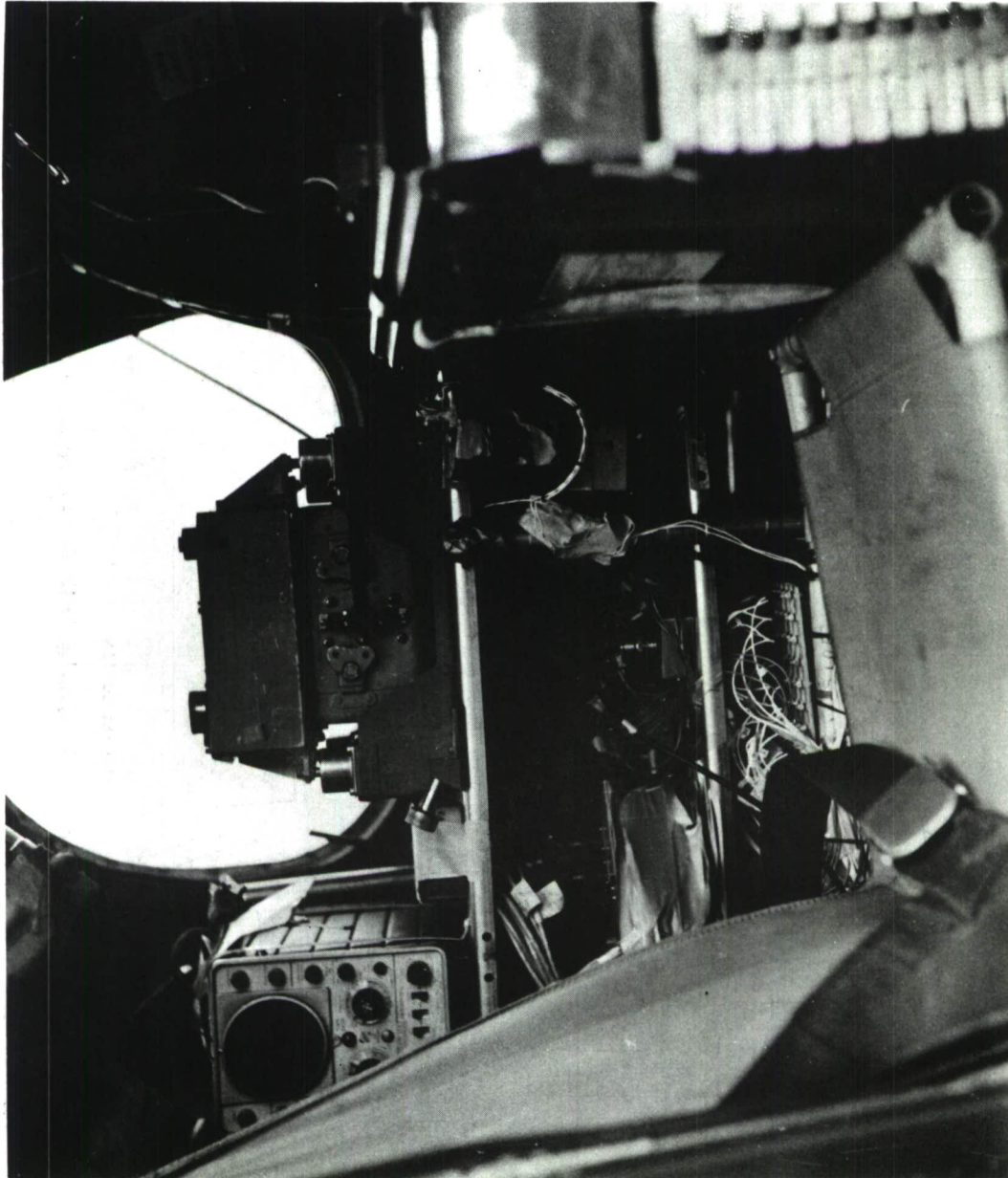

Figure 3. Flight Instrumentation

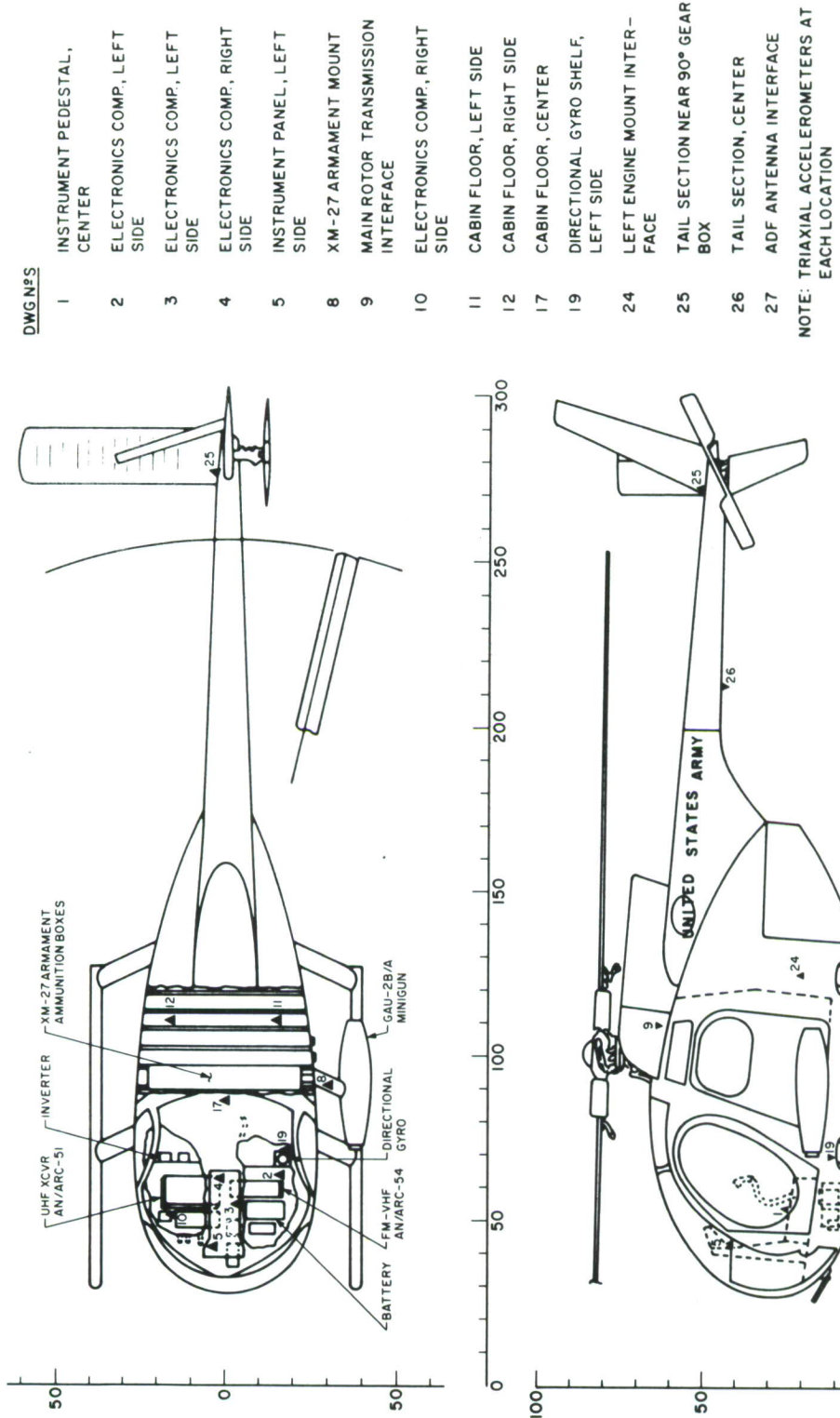

Figure 4. Piezoelectric Accelerometer Locations

| DWG NBS | LOCATION |
|---------|---|
| 1,2,3 | INSTRUMENT PANEL, LEFT SIDE, VERT, LAT, AND F&A |
| 4,5 | INSTRUMENT PANEL BASE, LAT. AND VERT. |
| 6,7 | CABIN FLOOR, RIGHT SIDE, LAT. AND VERT. |
| 8 | CABIN FLOOR, LEFT SIDE, VERT. |
| 9,10 | FUSELAGE-TAIL SECTION INTERFACE, LAT. AND VERT. |
| 11,12 | TAIL SECTION, NEAR 90° GEAR BOX, LAT. AND VERT. |

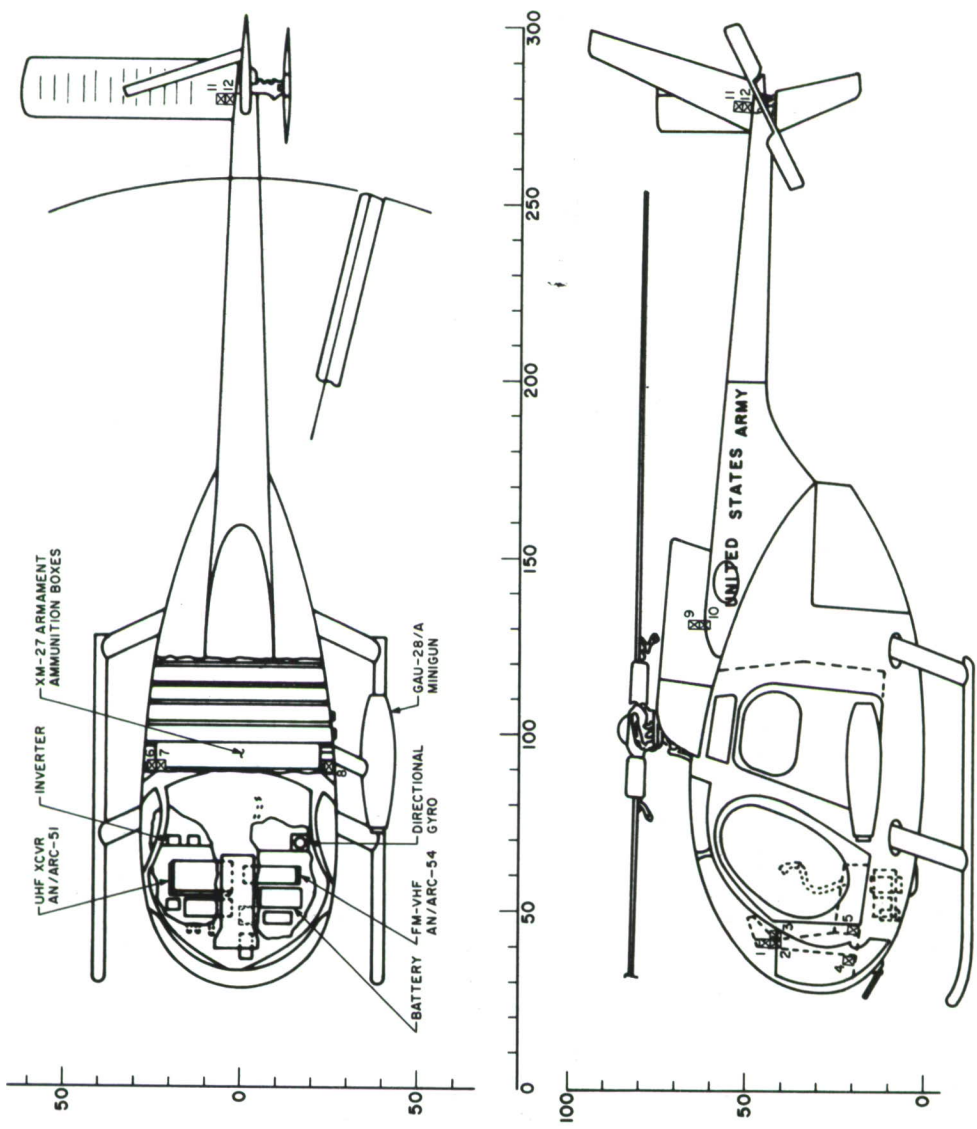
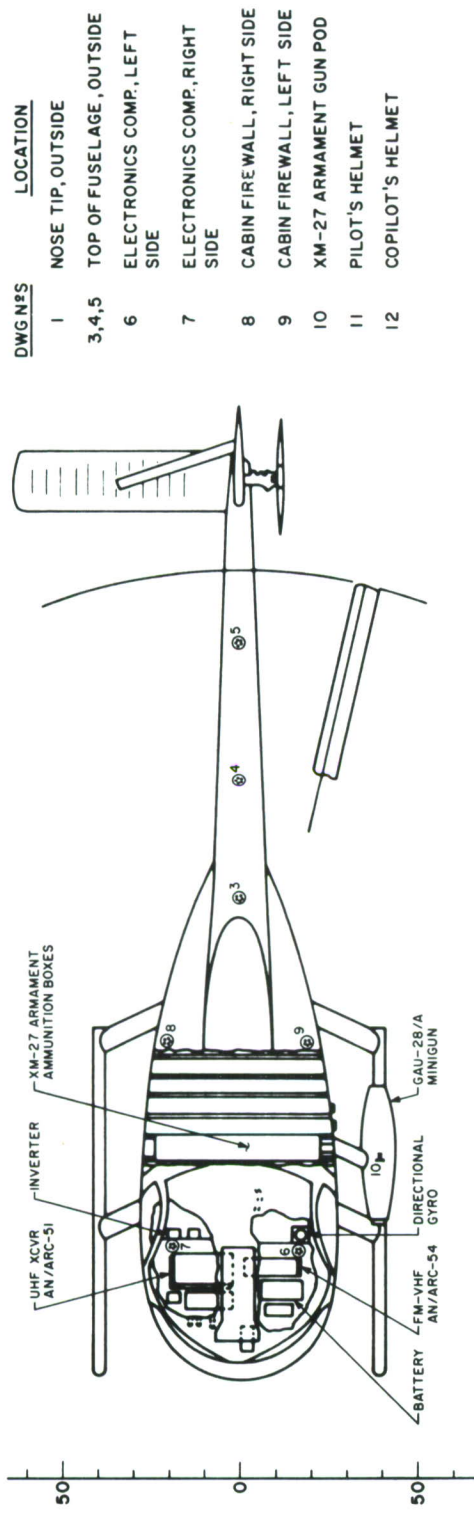
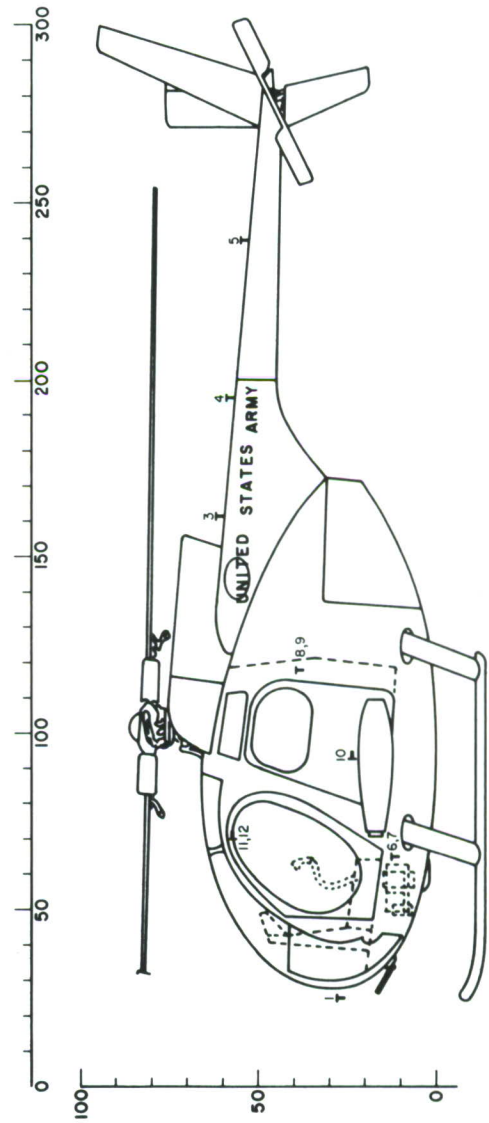

Figure 5. Low Frequency Accelerometer Locations



| DWG. N°S | LOCATION |
|----------|-------------------------------|
| 1 | NOSE TIP, OUTSIDE |
| 3,4,5 | TOP OF FUSELAGE, OUTSIDE |
| 6 | ELECTRONICS COMP., LEFT SIDE |
| 7 | ELECTRONICS COMP., RIGHT SIDE |
| 8 | CABIN FIRE WALL, RIGHT SIDE |
| 9 | CABIN FIRE WALL, LEFT SIDE |
| 10 | XM-27 ARMAMENT GUN POD |
| 11 | PILOT'S HELMET |
| 12 | COPILLOT'S HELMET |



OH-6A HELICOPTER

Figure 6. Microphone Locations

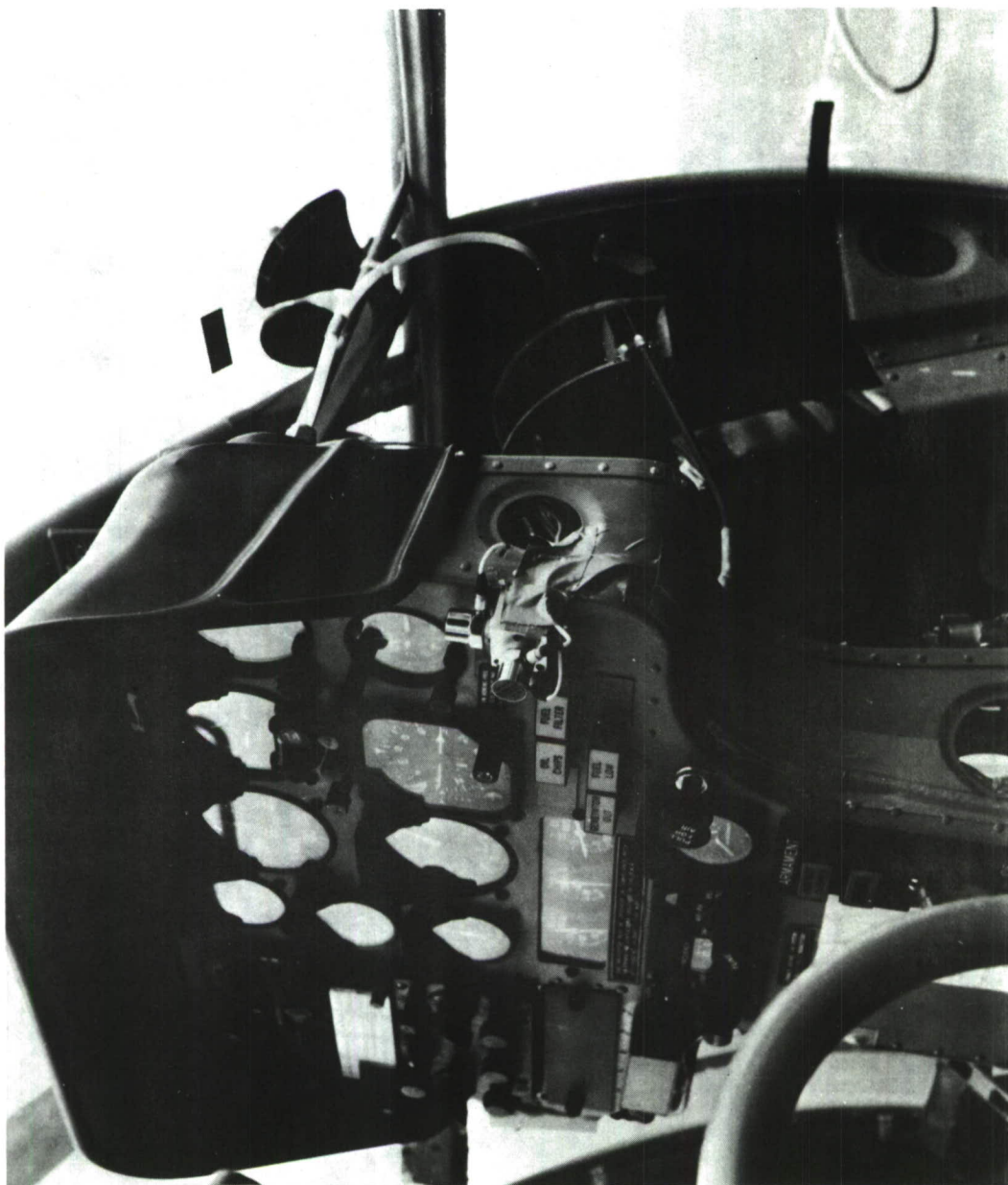

Figure 7. Piezoelectric Accelerometers, Instrument Panel, Right Side, Sta. 44, PUID's 5, 6, 7

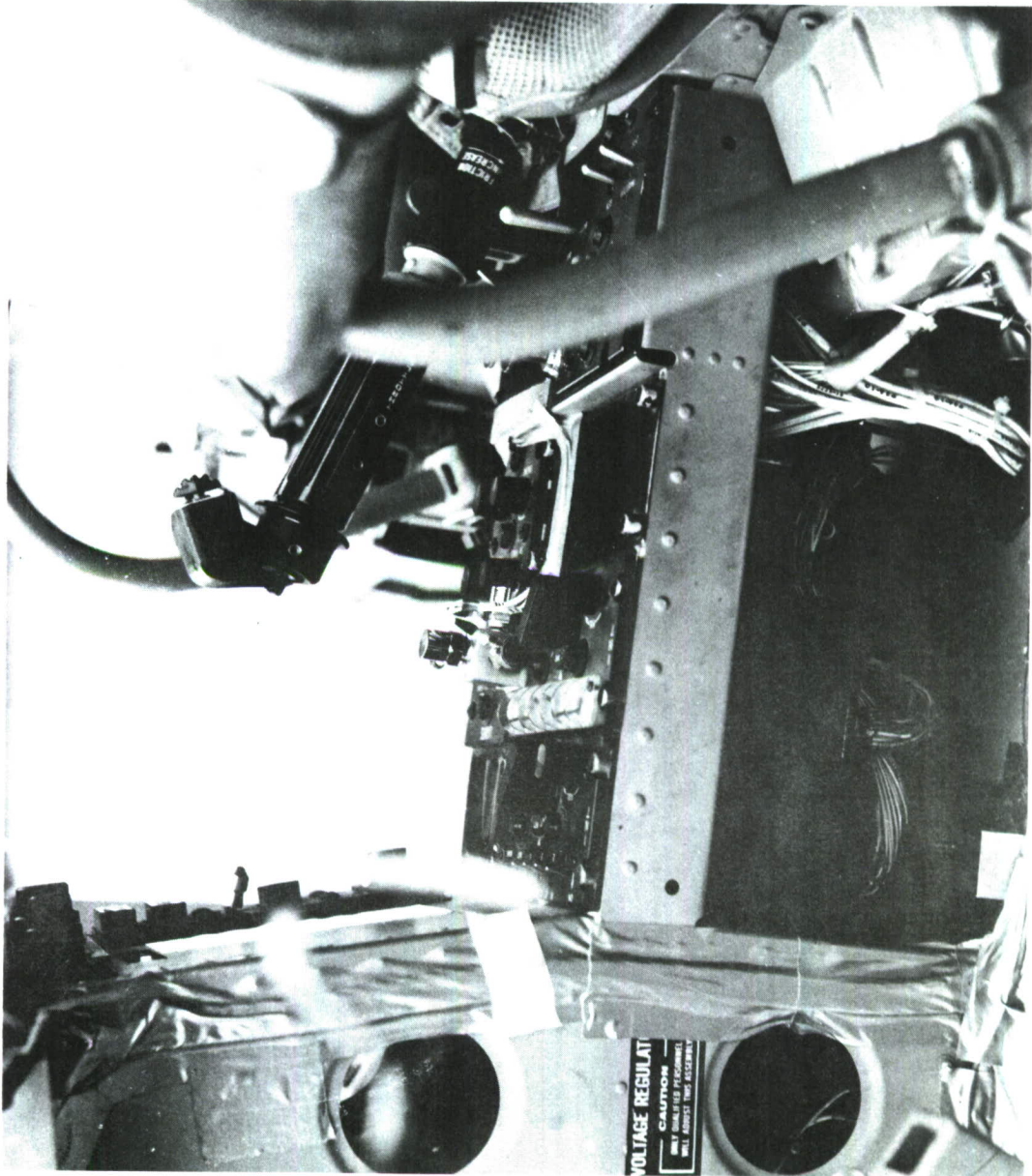

Figure 8. Piezoelectric Accelerometers, Instrument Pedestal, Center Sta. 56, PUID's 8, 9, 10



Figure 9. Piezoelectric Accelerometers, Left Engine Mount Interface, Sta. 121, PUID's 13, 14, 15

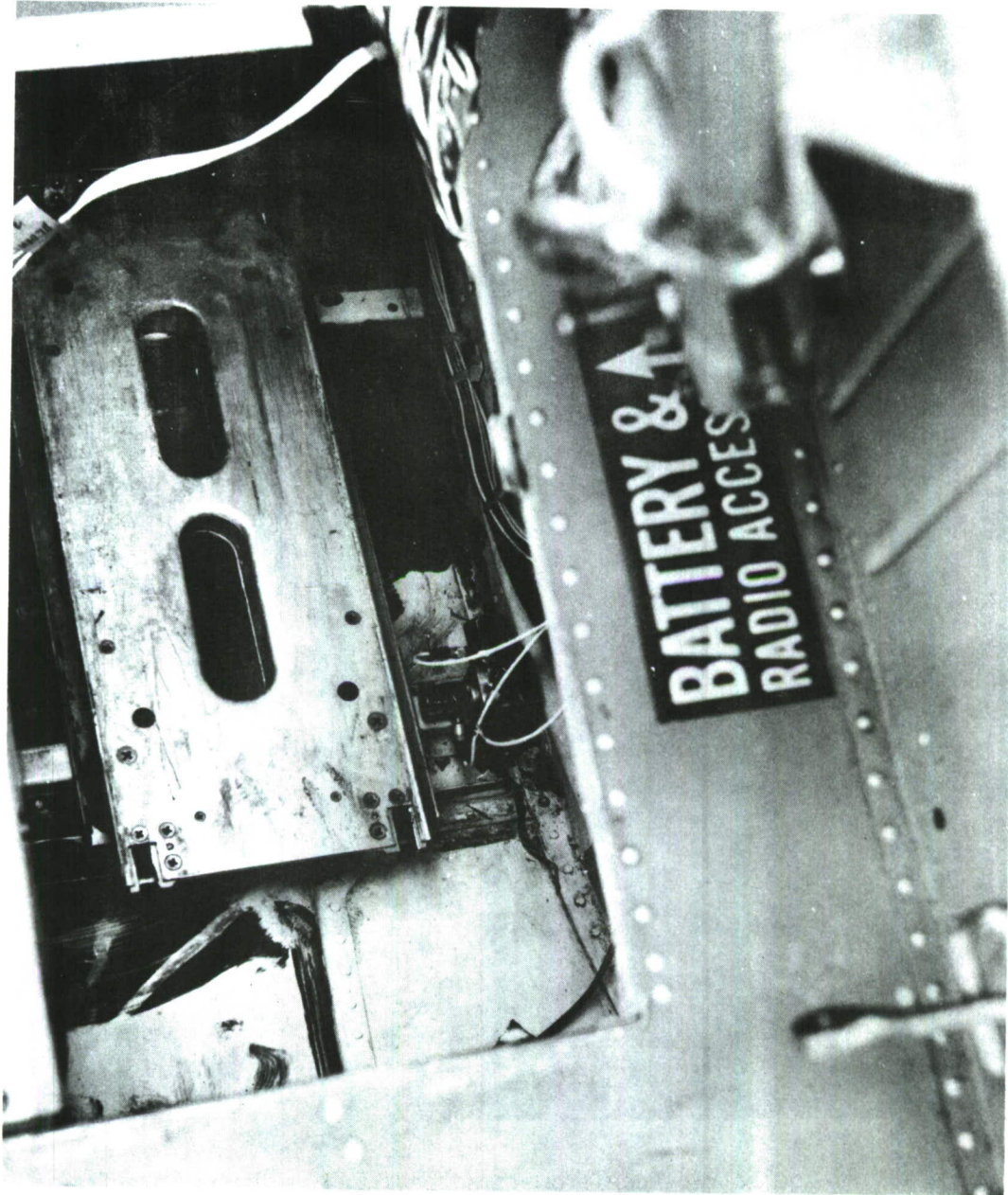

Figure 10. Piezoelectric Accelerometers, Electronic Compartment, Left Side, AN/ARC-54, Sta. 62, PUID's 17, 18, 19

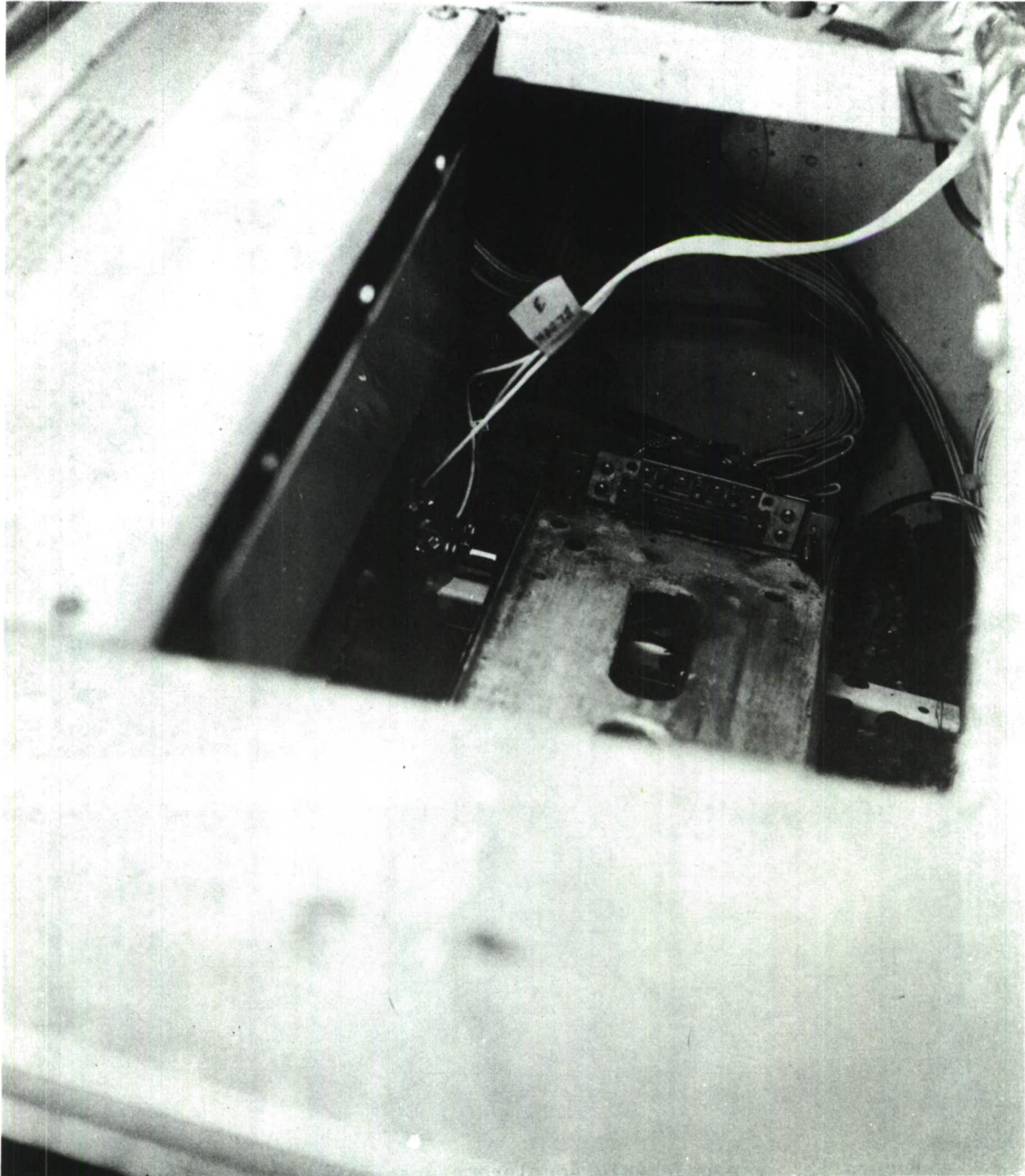

Figure 11. Piezoelectric Accelerometers, Left Side, AN/ARC-54, Sta. 58, PUID's 20, 21, 22

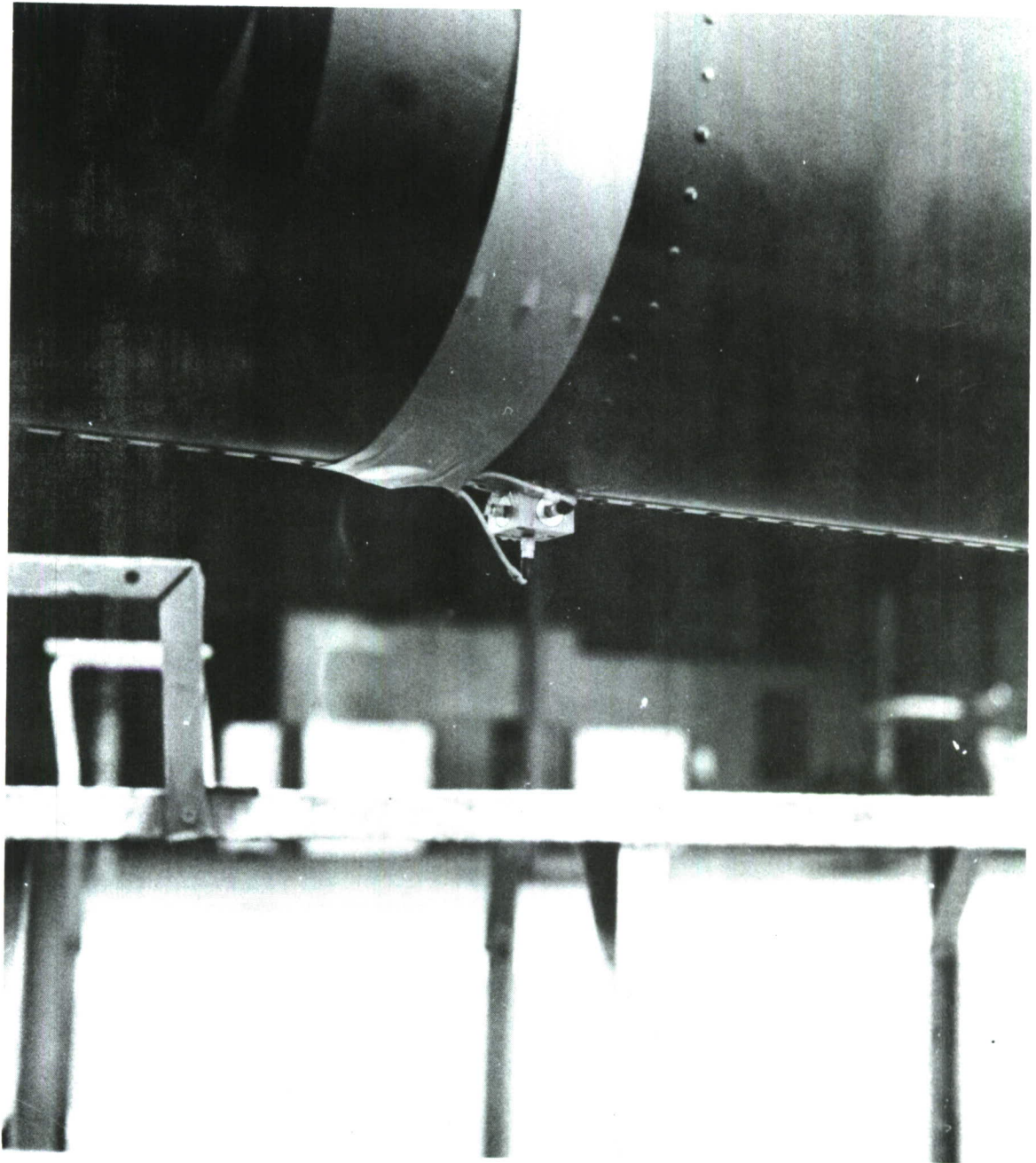

Figure 12. Piezoelectric Accelerometers, Tail Section, Center, Sta. 220, PUID's 25, 26, 27



Figure 13. Piezoelectric Accelerometers, Electronic Compartment, Right Side, AN/ARC-51 Sta. 62, PUID's 29, 30, 31



Figure 14. Piezoelectric Accelerometers, Electronic Compartment, Right Side, AN/ARC-51 Sta. 55, PUID's 32, 33, 34



Figure 15. Piezoelectric Accelerometers, Cabin Floor Left Side, Sta. 110, PUID's 41, 42, 43

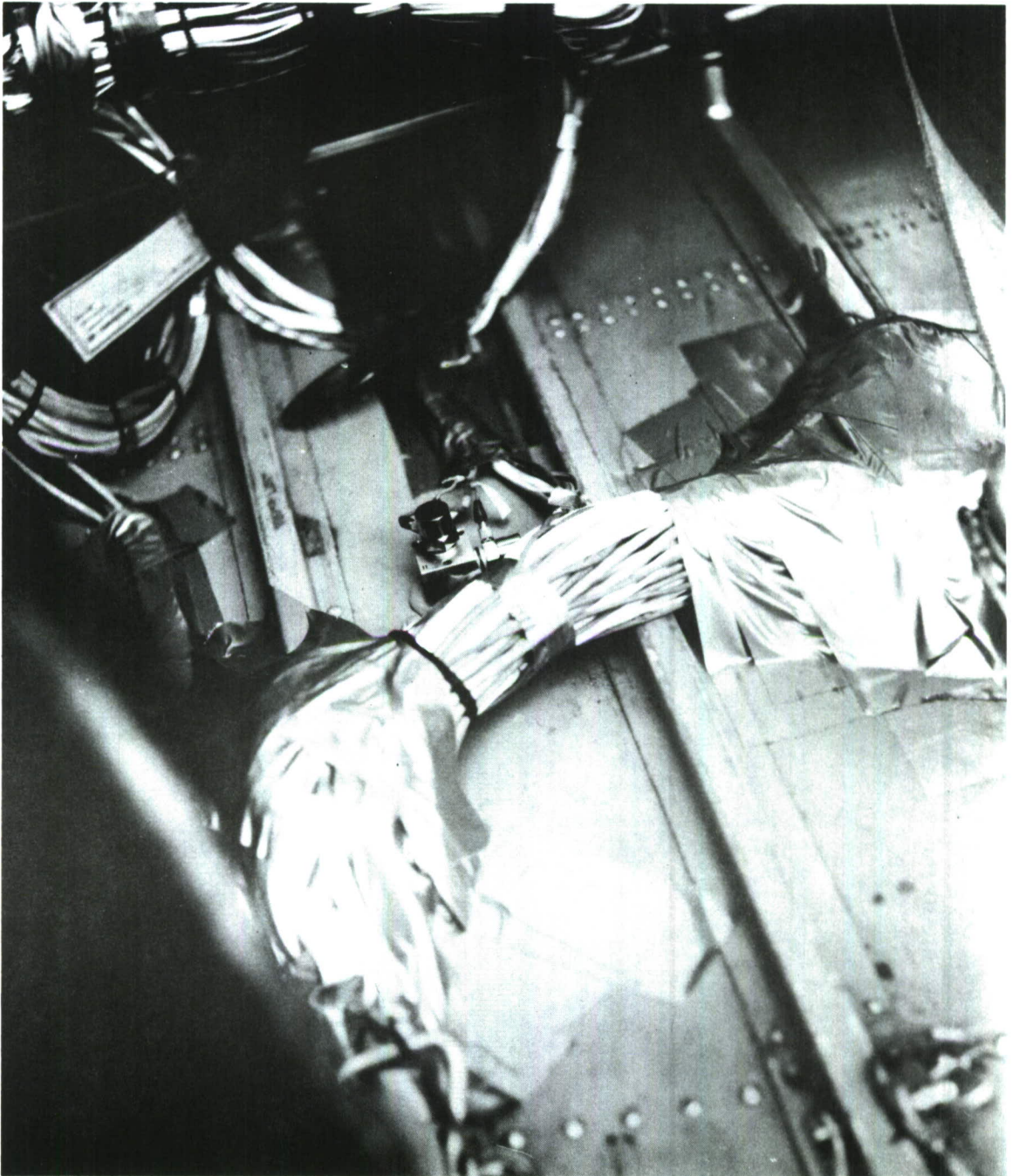

Figure 16. Piezoelectric Accelerometers, Cabin Floor Right Side, Sta. 110, PUID's 44, 45, 46



Figure 17. Piezoelectric Accelerometers, XM-27 Armament Mount,
Sta. 92, PUID's 53, 54, 55



Figure 18. Piezoelectric Accelerometers, ADF Antenna Interface, Sta. 69, PUID's 65, 66, 67

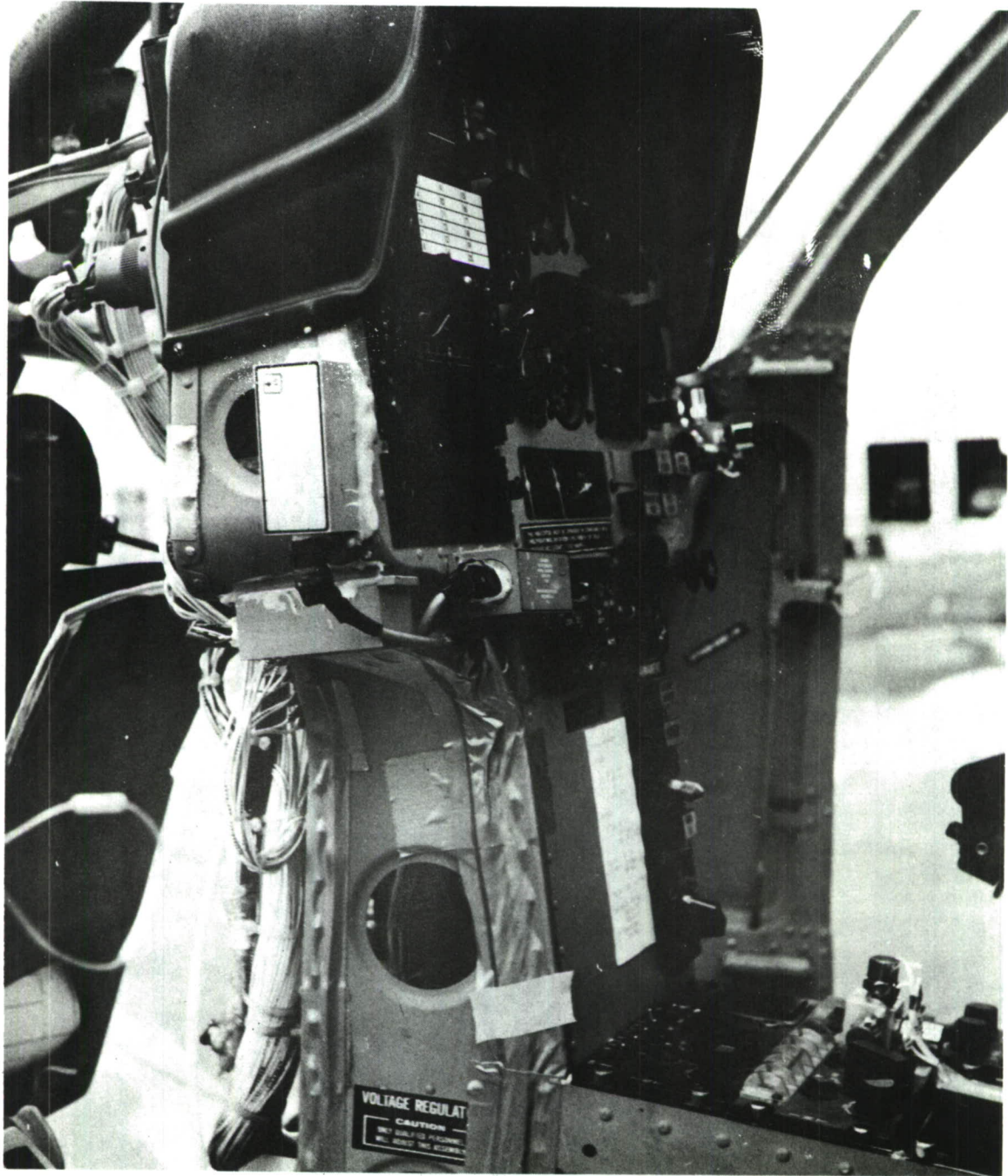

Figure 19. Low Frequency Accelerometers, Instrument Panel, Left Side, Sta. 43; PUID's 4, 16, 28

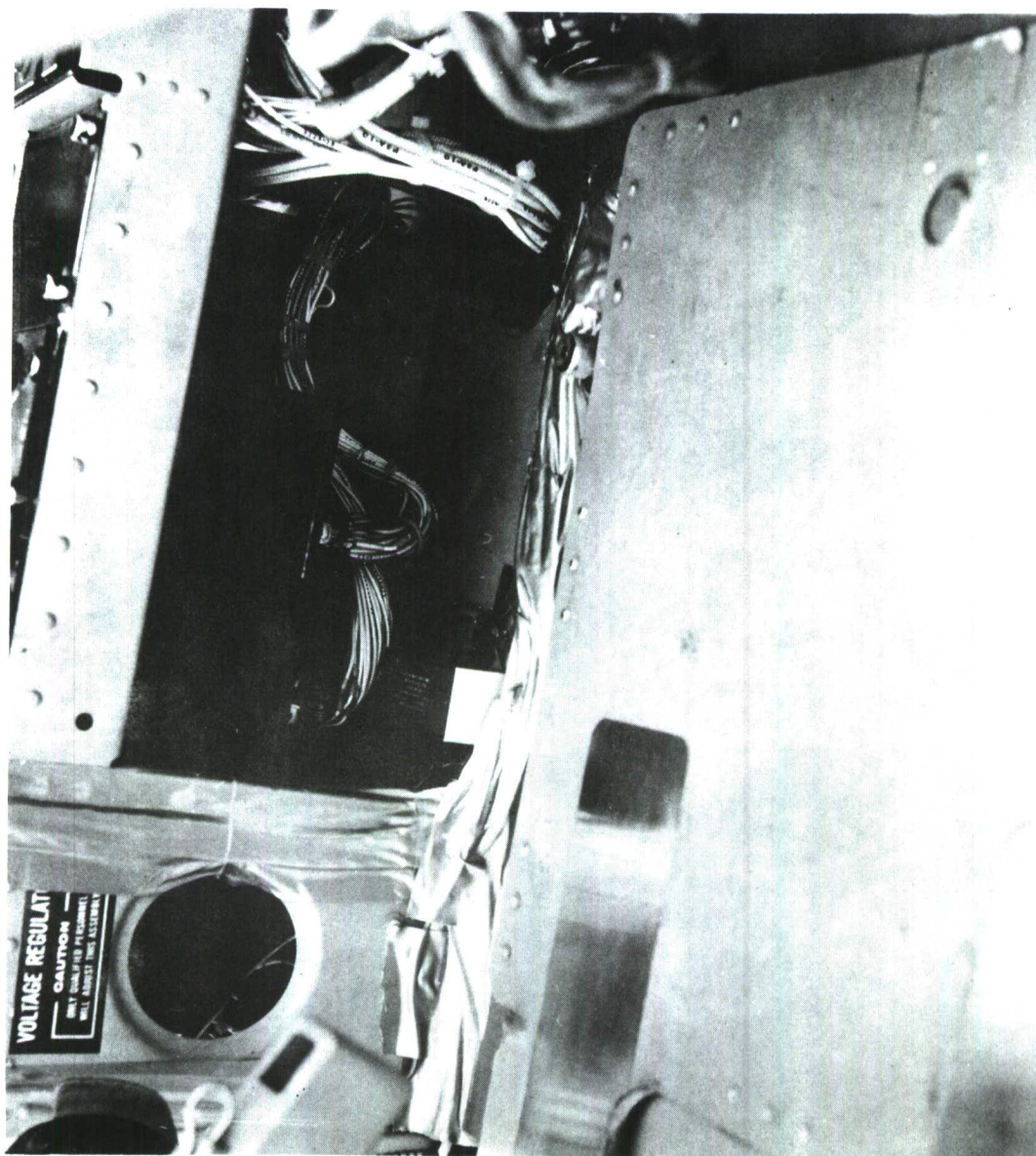

Figure 20. Low Frequency Accelerometer, Lateral, Instrument Panel Base, Left Side, Sta. 39, PUID 40

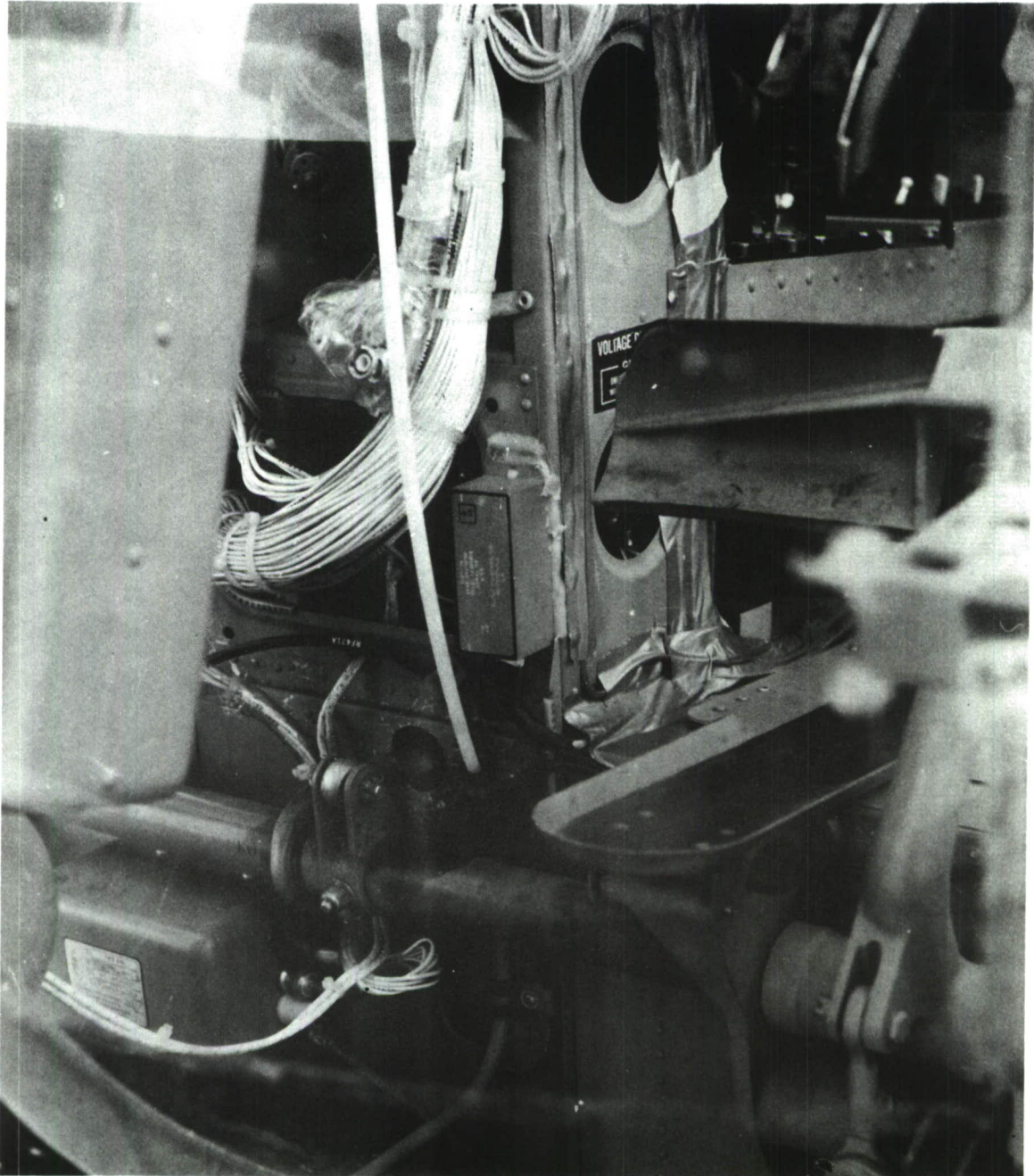

Figure 21. Low Frequency Accelerometer, Vertical, Instrument Panel Base, Left Side, Sta. 39, PUID 49

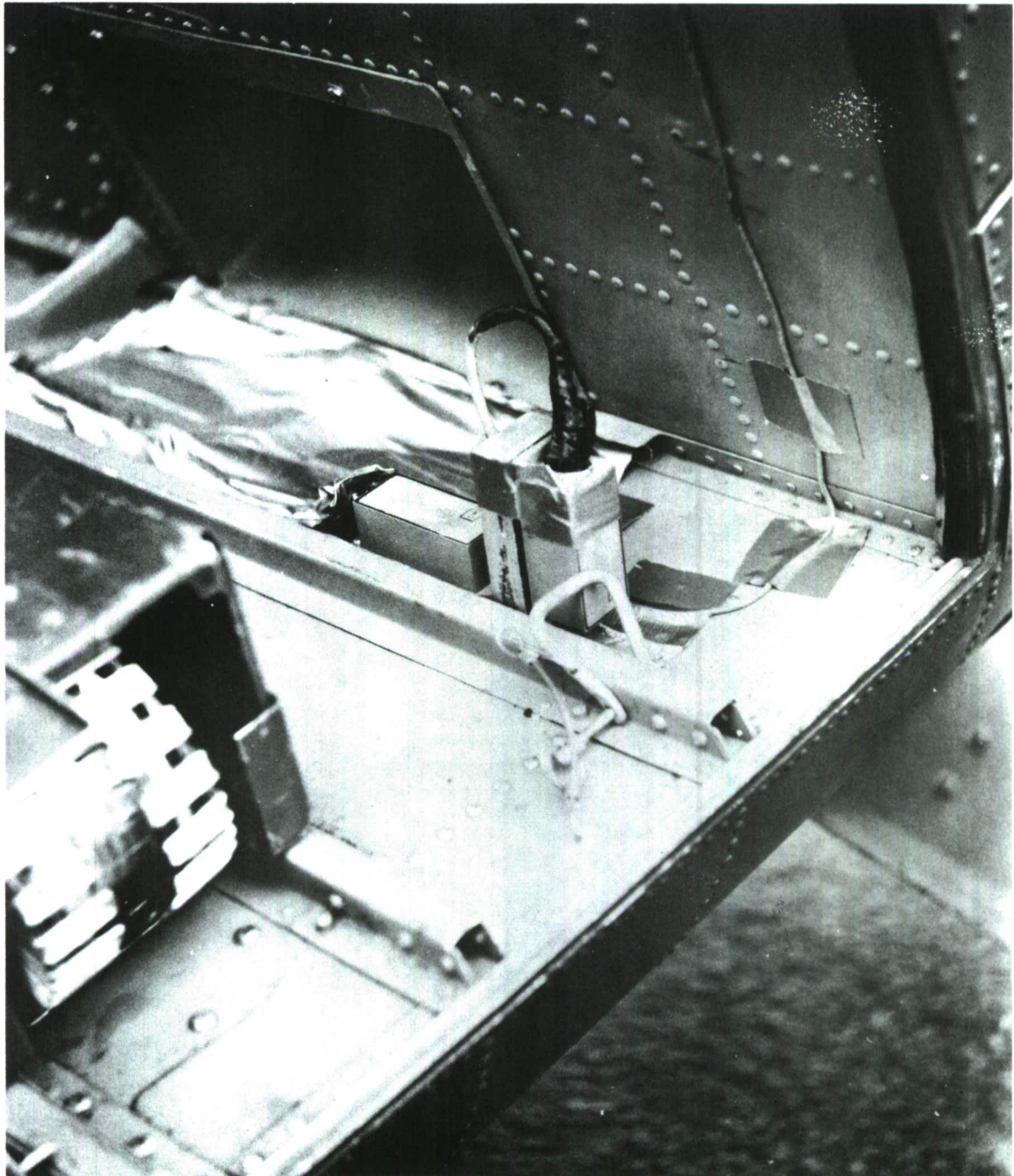

Figure 22. Low Frequency Accelerometers, Cabin Floor, Right Side, Sta. 90, PUID's 50, 61



Figure 23. Low Frequency Accelerometers, Fuselage-Tail Section Interface, Sta. 130, PUID's 51, 63

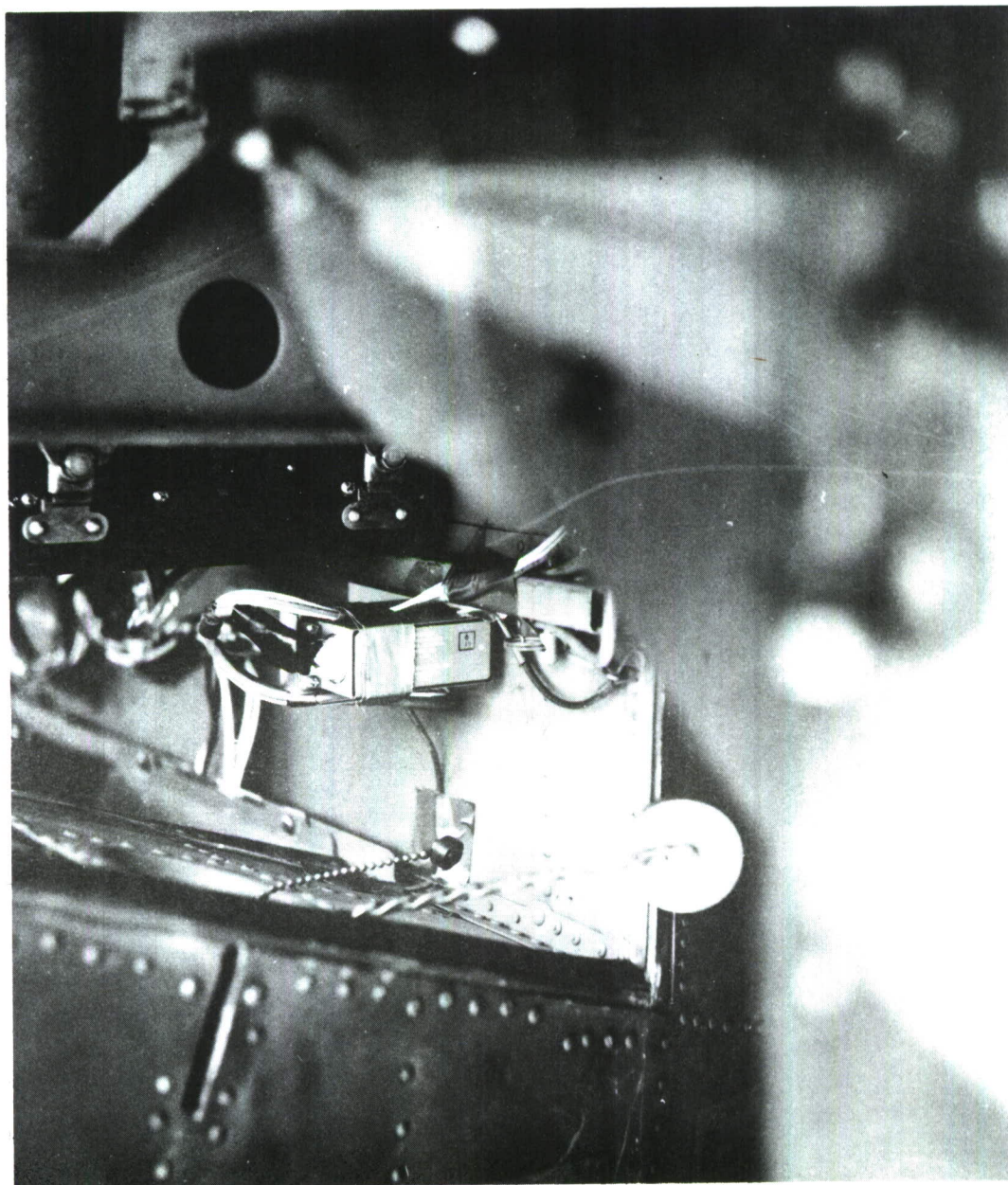

Figure 24. Low Frequency Accelerometer, Cabin Floor, Left Side,
Sta. 90, PUID 59

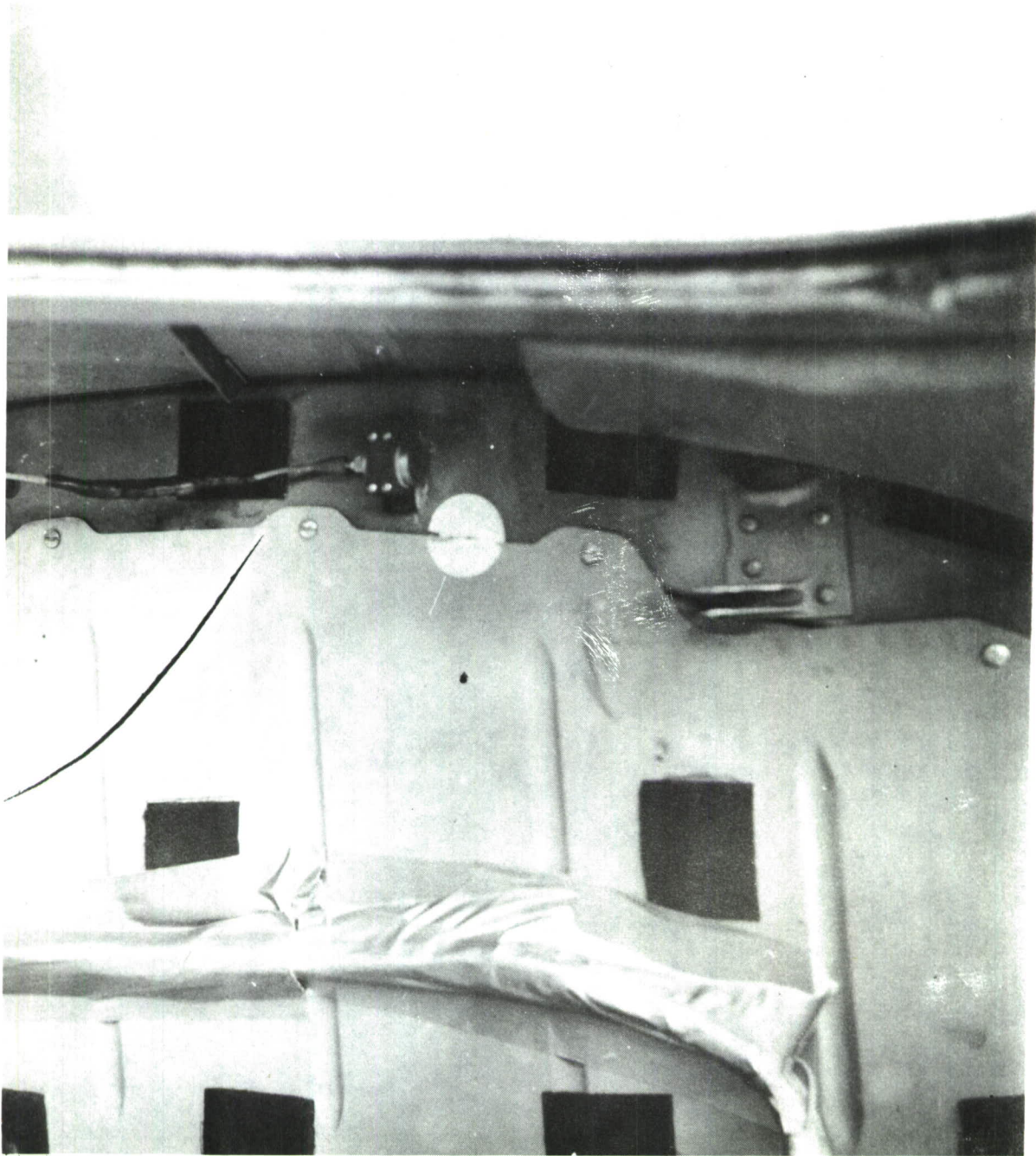

Figure 25. Microphone, Cabin Firewall, Right Side, Sta. 122, PUID 12



Figure 26. Microphone, Cabin Firewall, Left Side, Sta. 122, PUID 24

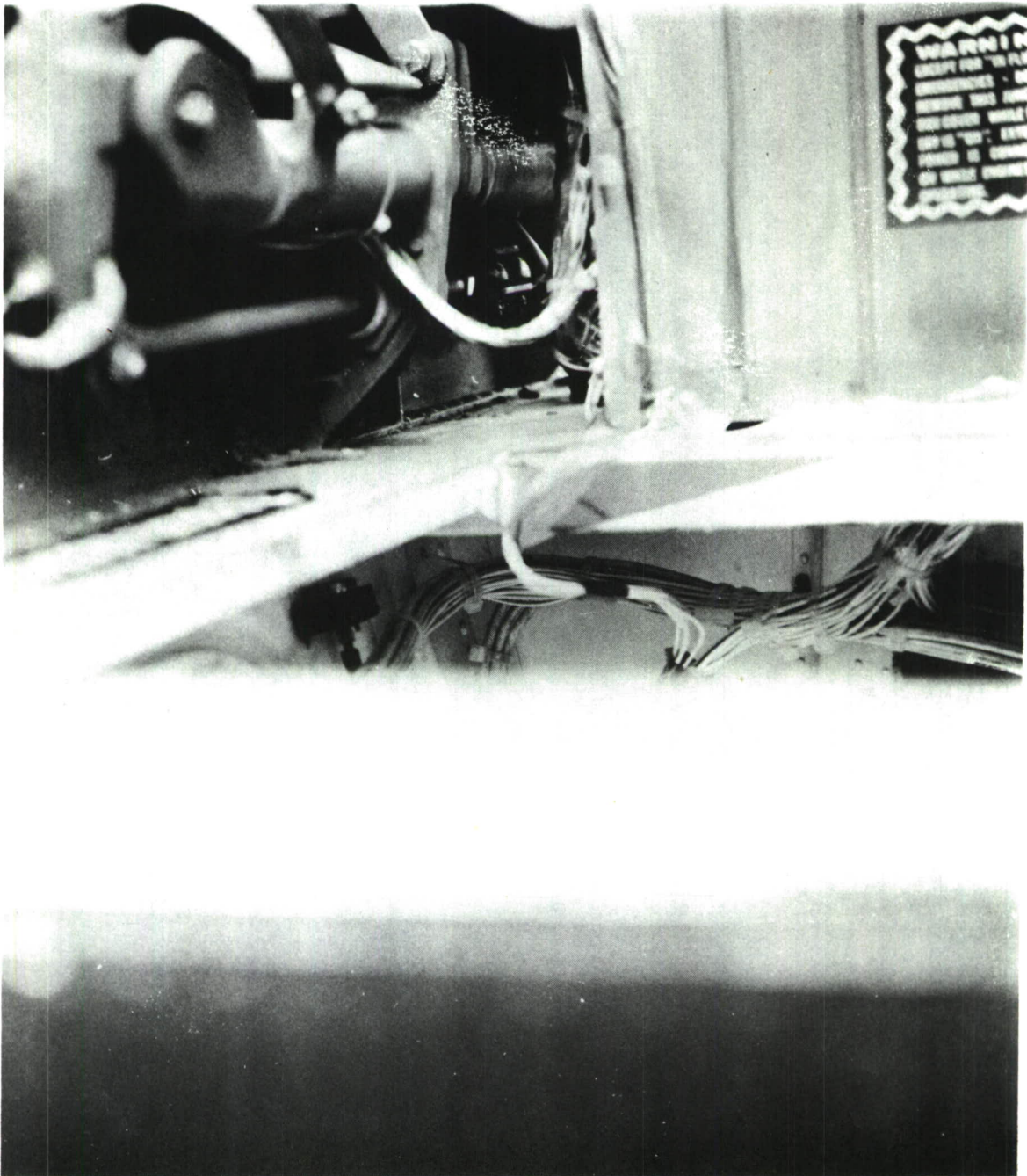

Figure 27. Microphone, Electronics Compartment, Right Side, Sta. 66,
PUID 36



Figure 28. Microphone, Pilot's Helmet, Right Side, Sta. 72, PUID 48



Figure 29. Microphone, Copilot's Helmet, Left Side, Sta. 72, PUID 60

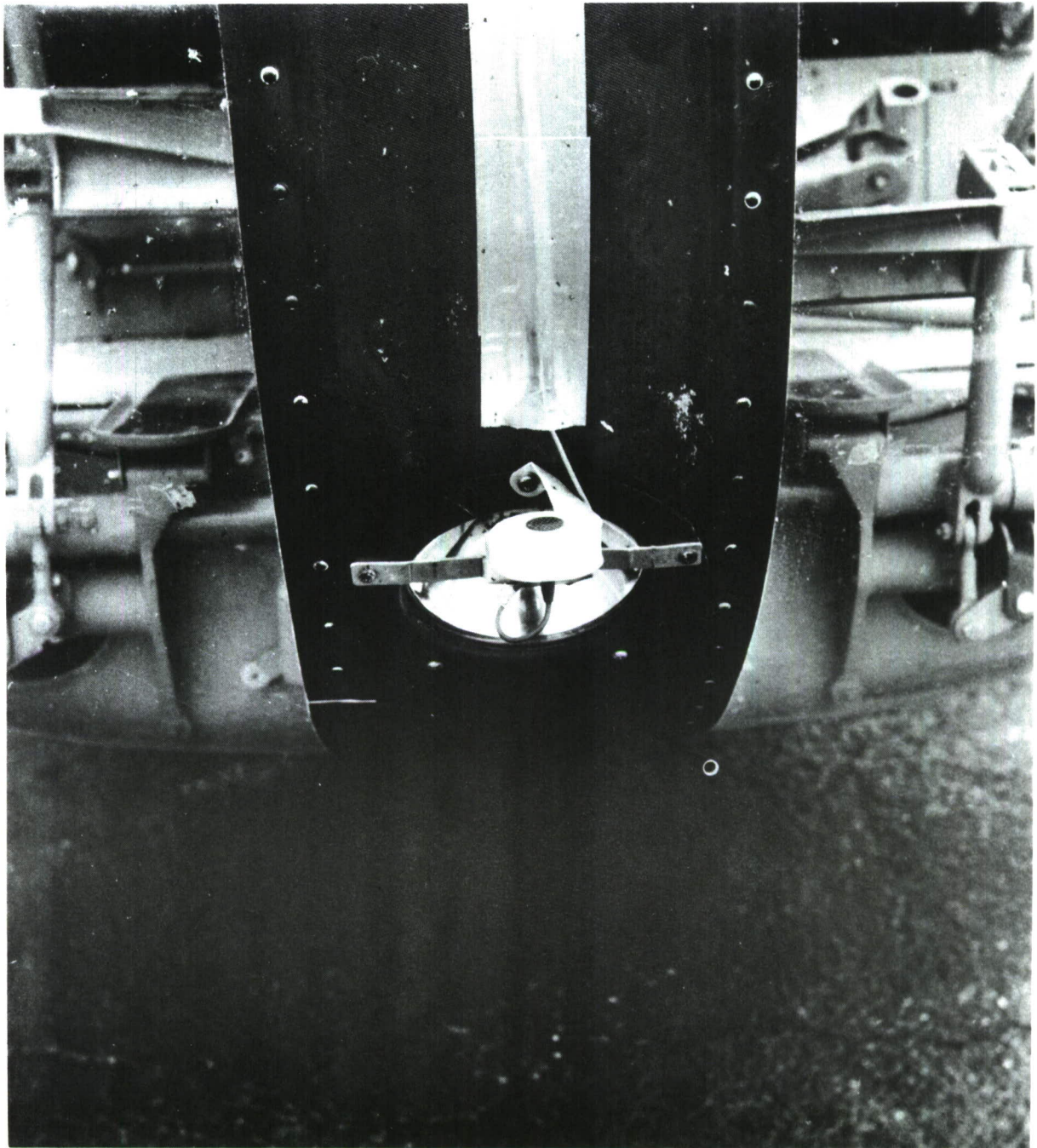

Figure 30. Microphone, Top of Fuselage, Outside, Sta. 27, PUID 68



Figure 31. Microphone, XM-27 Armament Gun Pod, Sta. 90, PUID 69

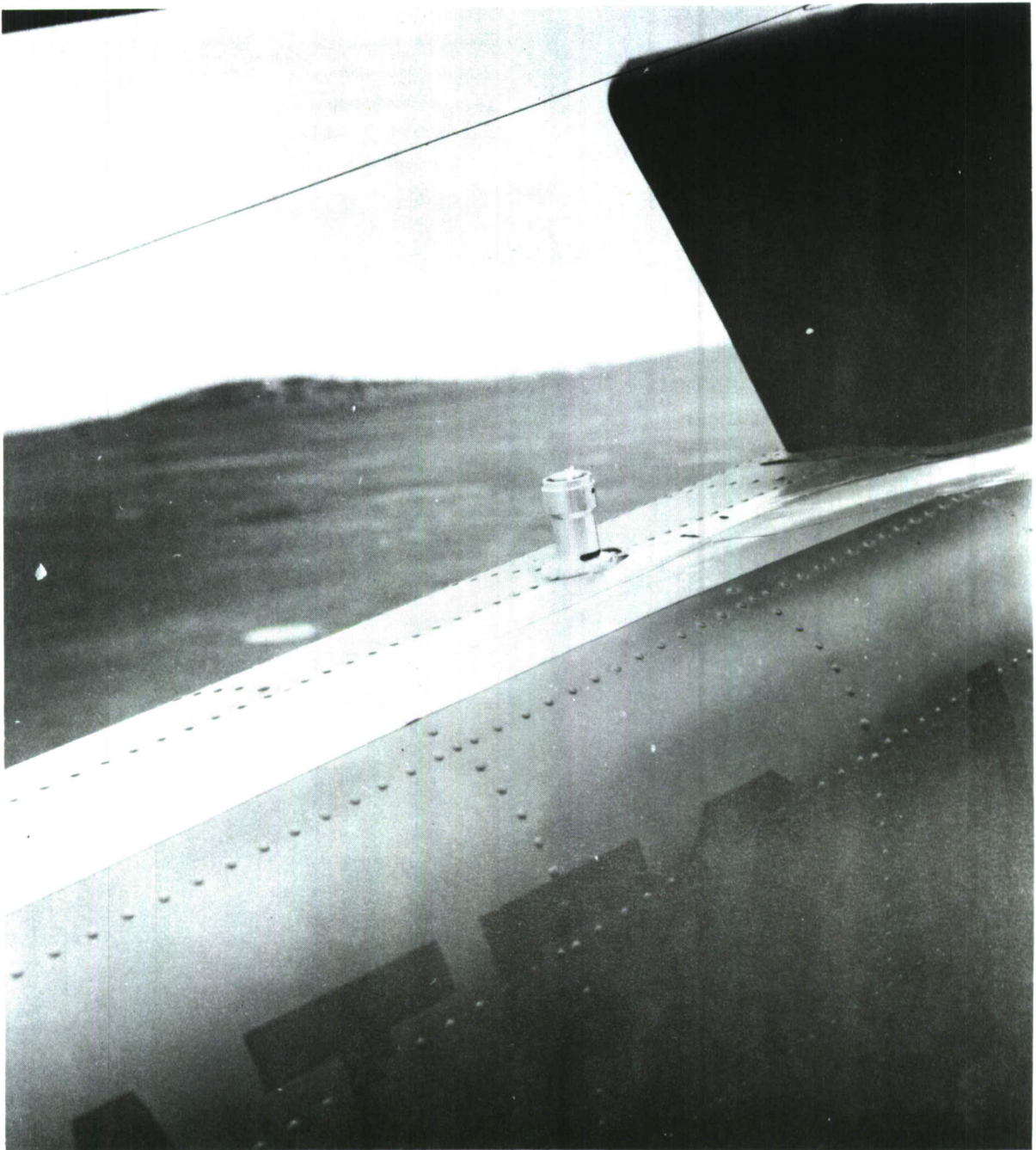

Figure 32. Microphone, Top of Fuselage, Outside, Sta. 165, PUID 70



Figure 33. Microphone, Top of Fuselage, Outside, Sta. 200, PUID 71

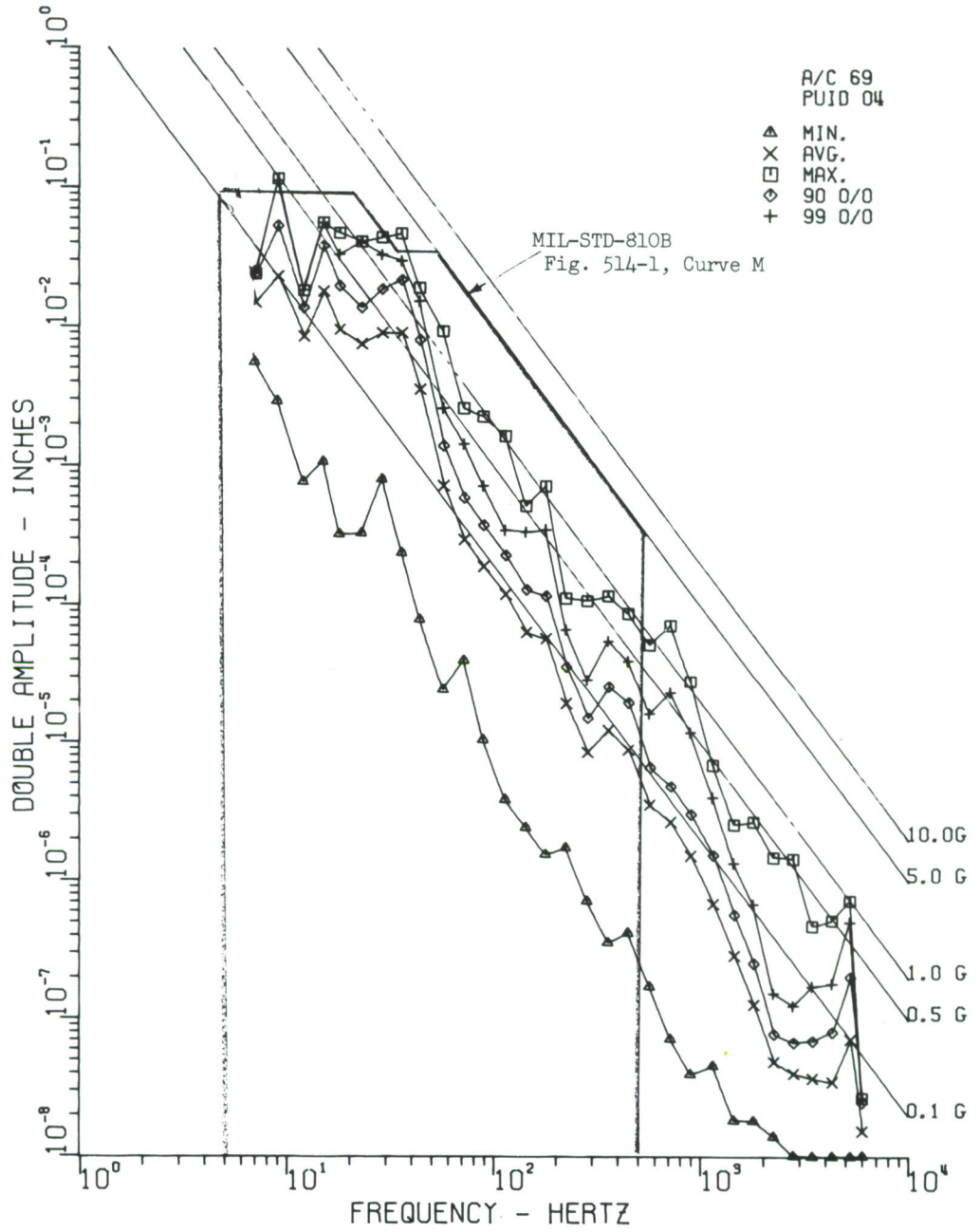

Figure 34. Nose Section and Cockpit, without Gunfire

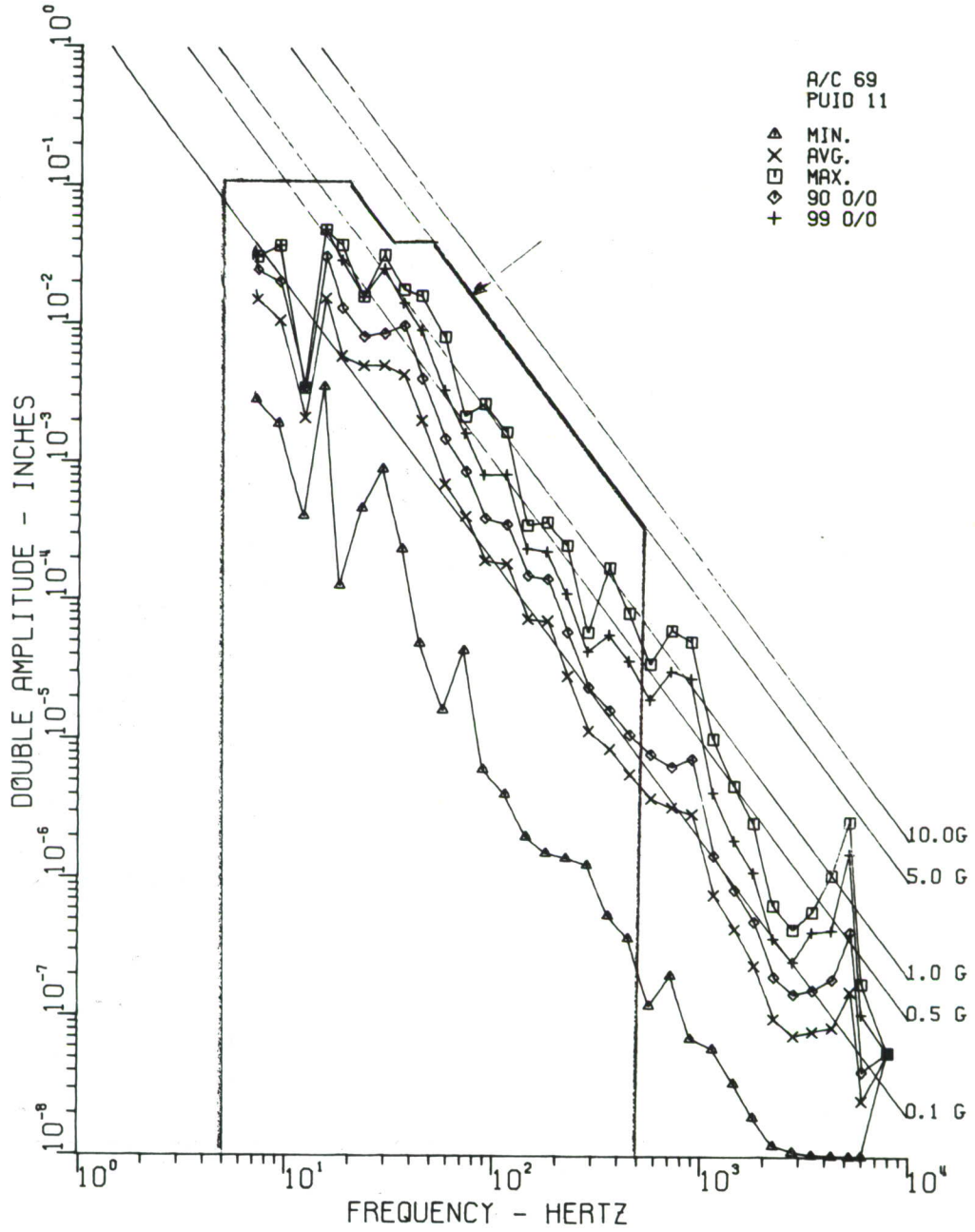

Figure 35. Passenger Compartment, without Gunfire

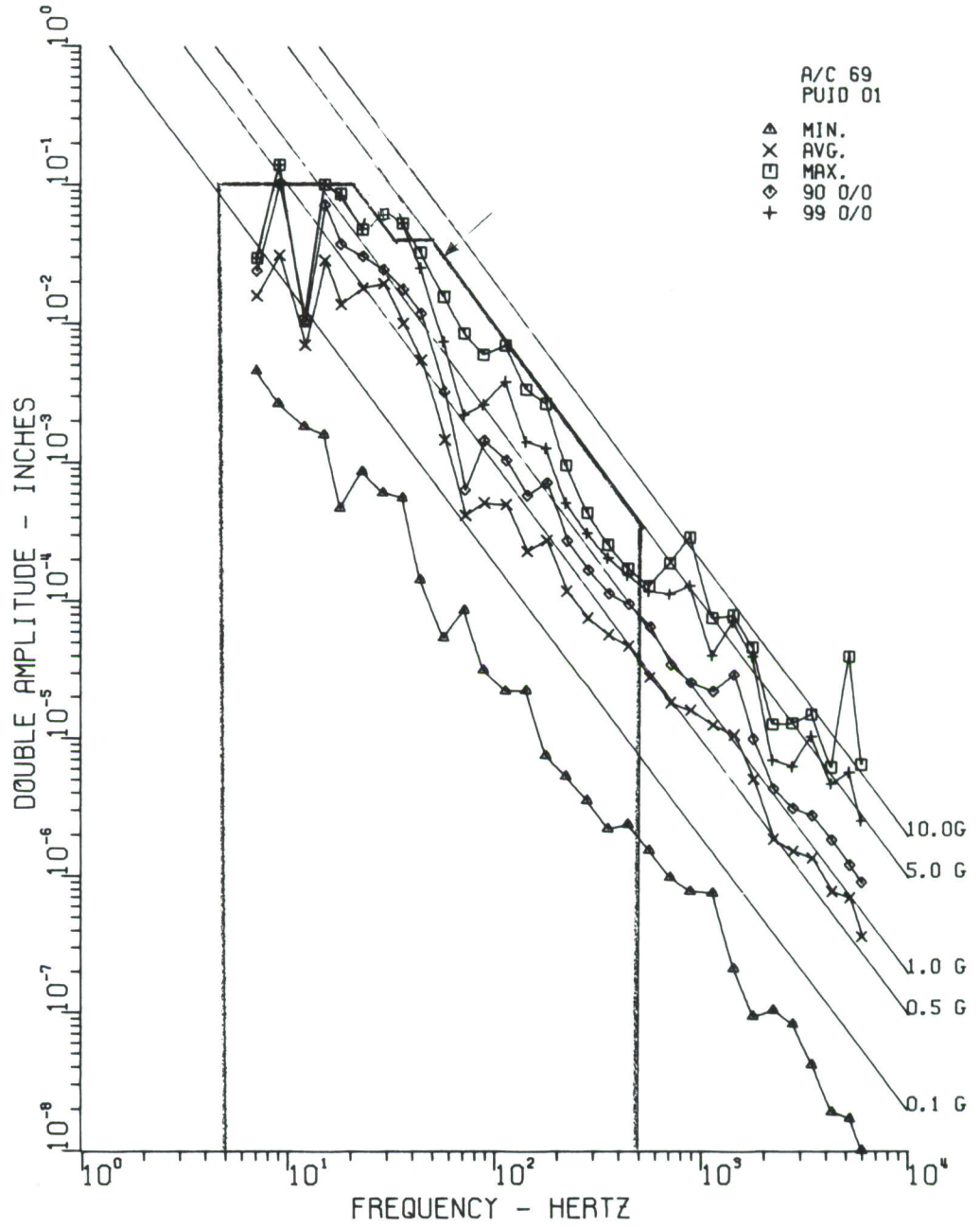

Figure 36. Engine - Transmission Compartment, without Gunfire

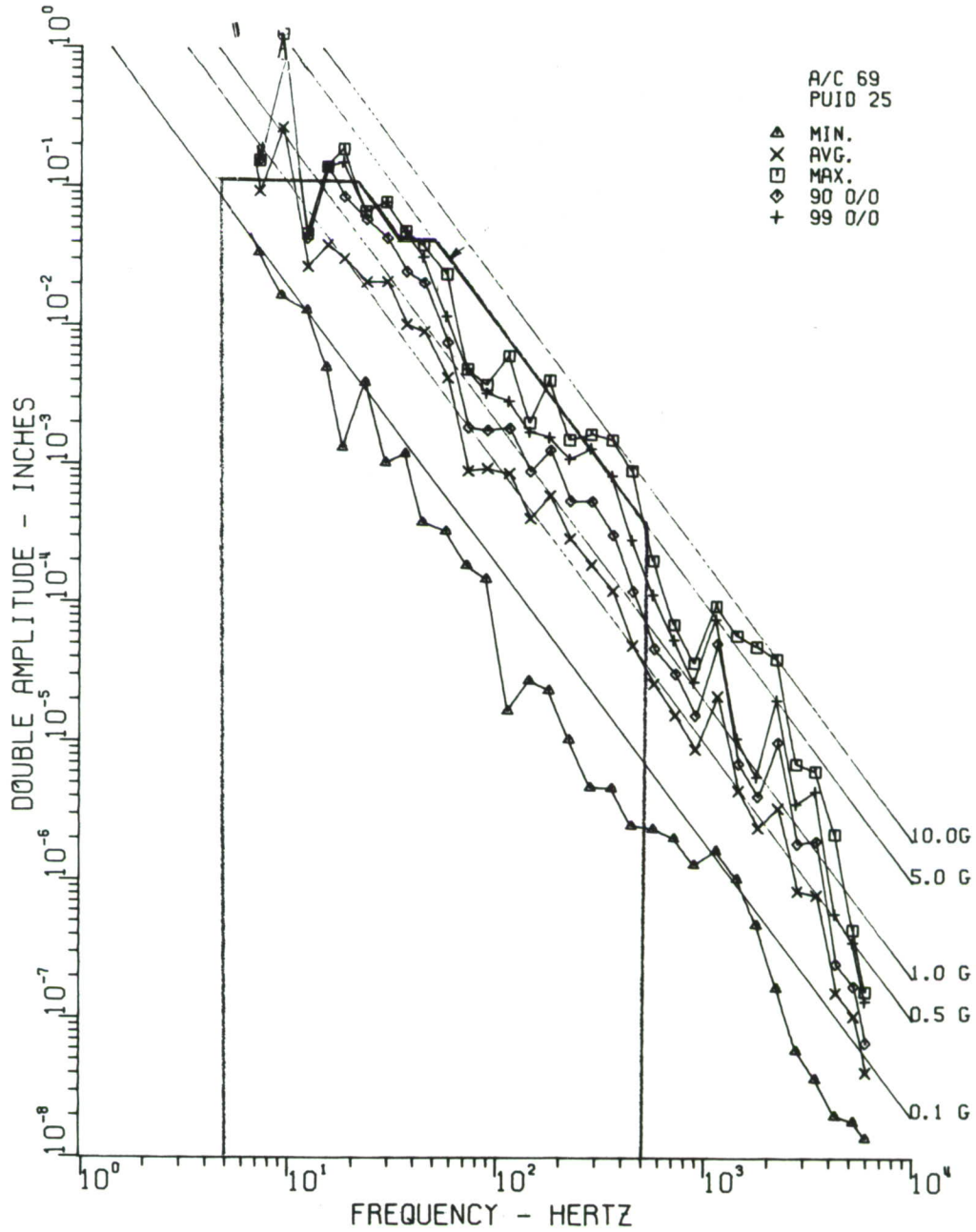

Figure 37. Tail Boom, without Gunfire

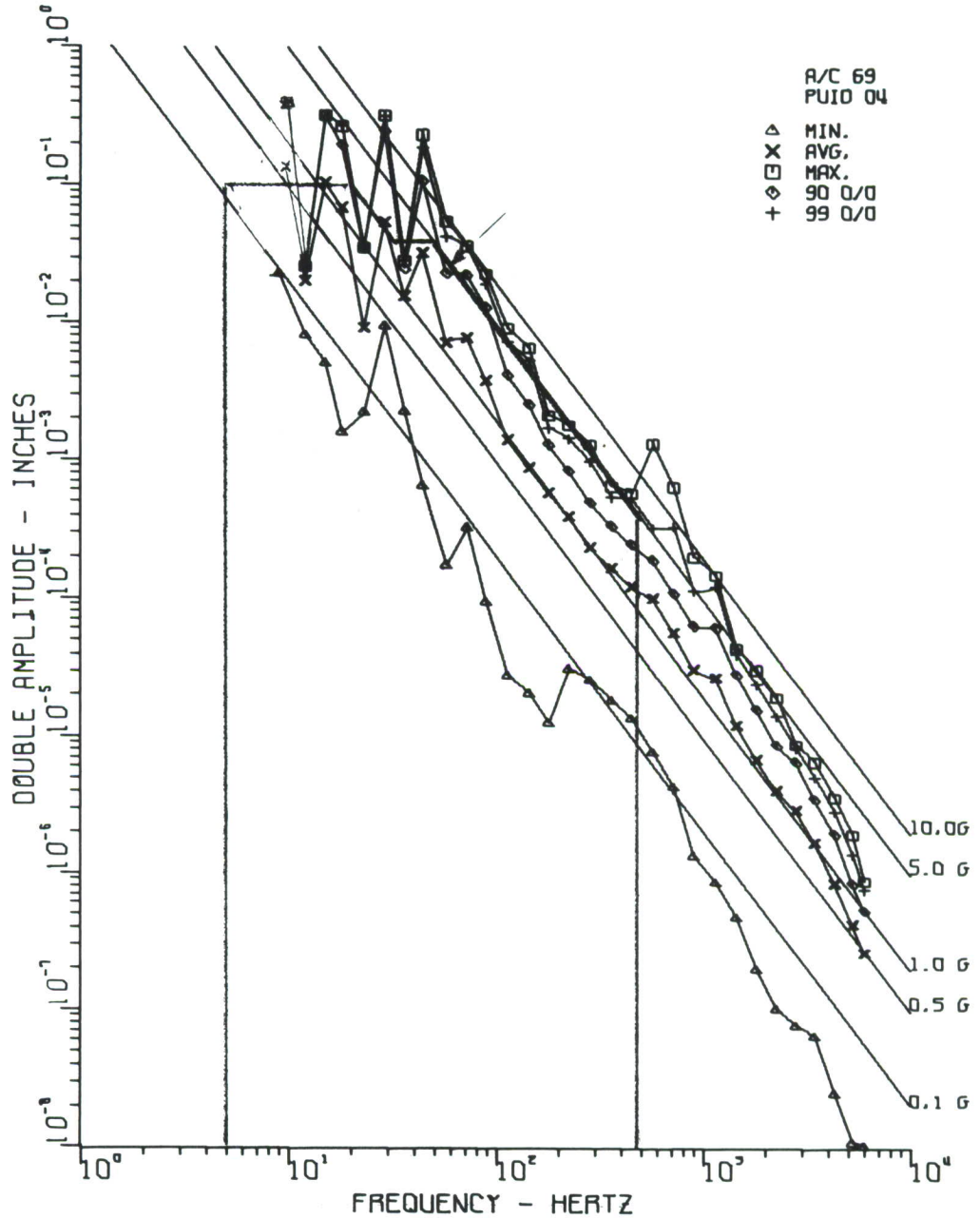

Figure 38. Nose Section and Cockpit, with Gunfire

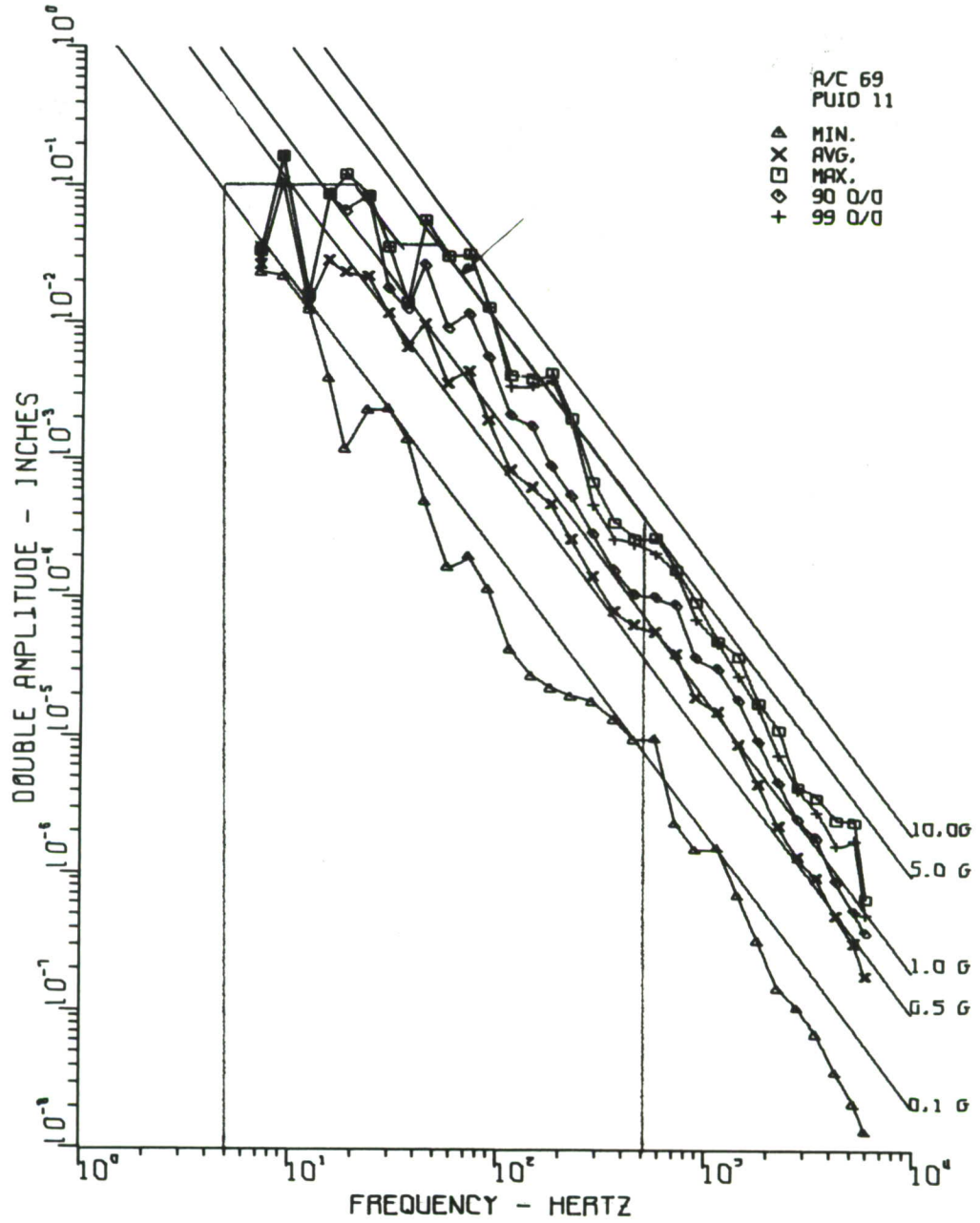

Figure 39. Passenger Compartment, with Gunfire

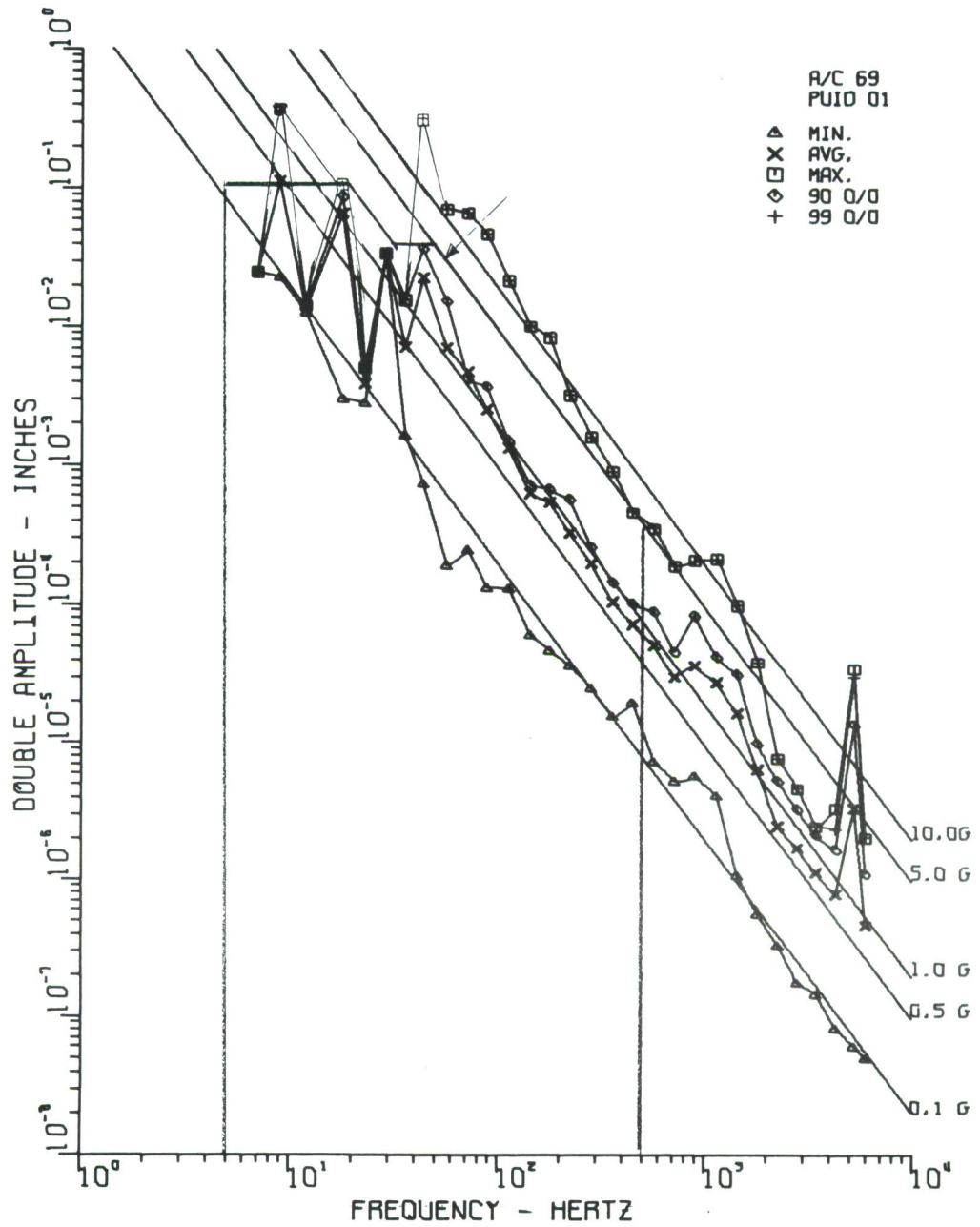

Figure 40. Engine-Transmission Compartment, with Gunfire

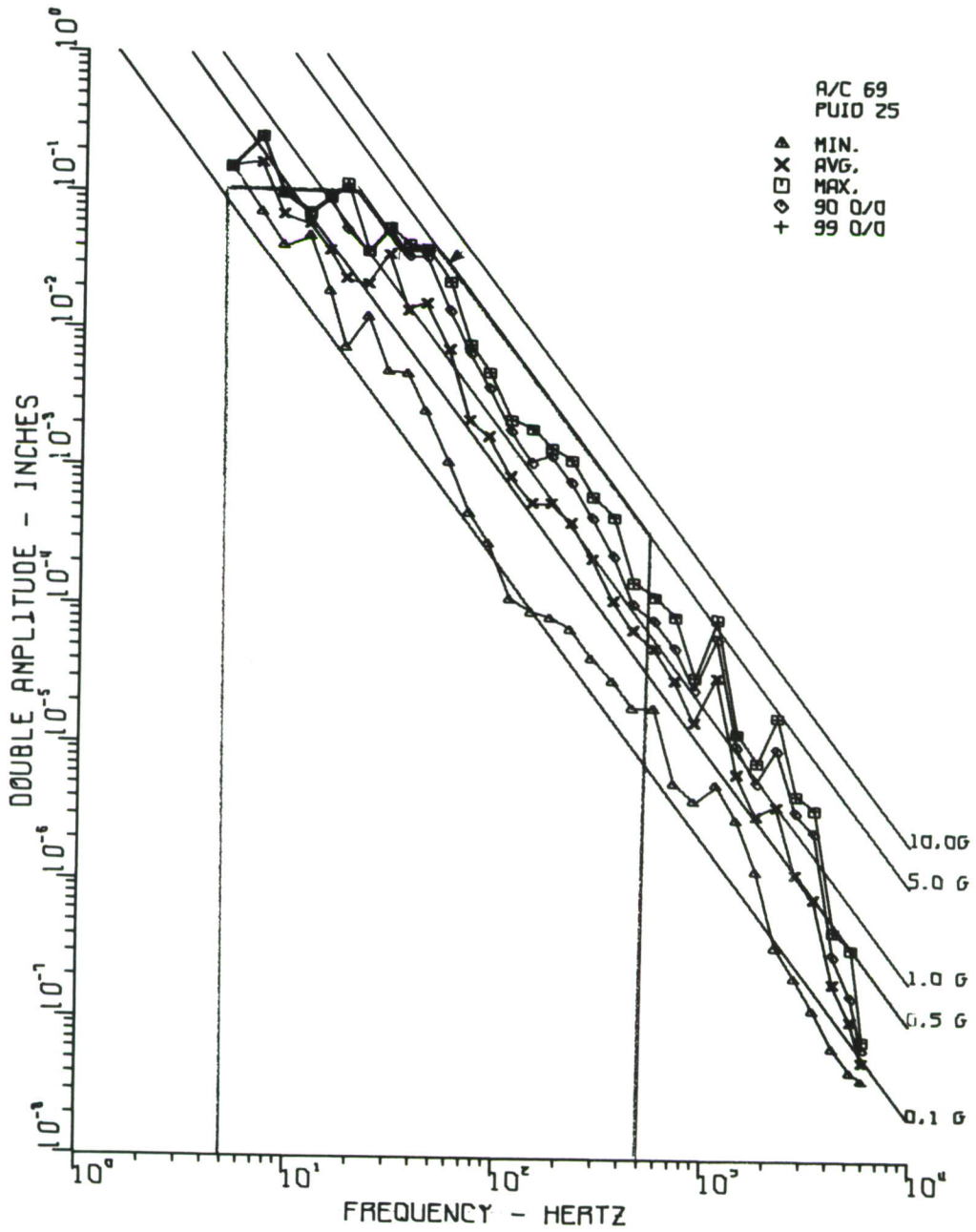

Figure 41. Tail Boom, with Gunfire

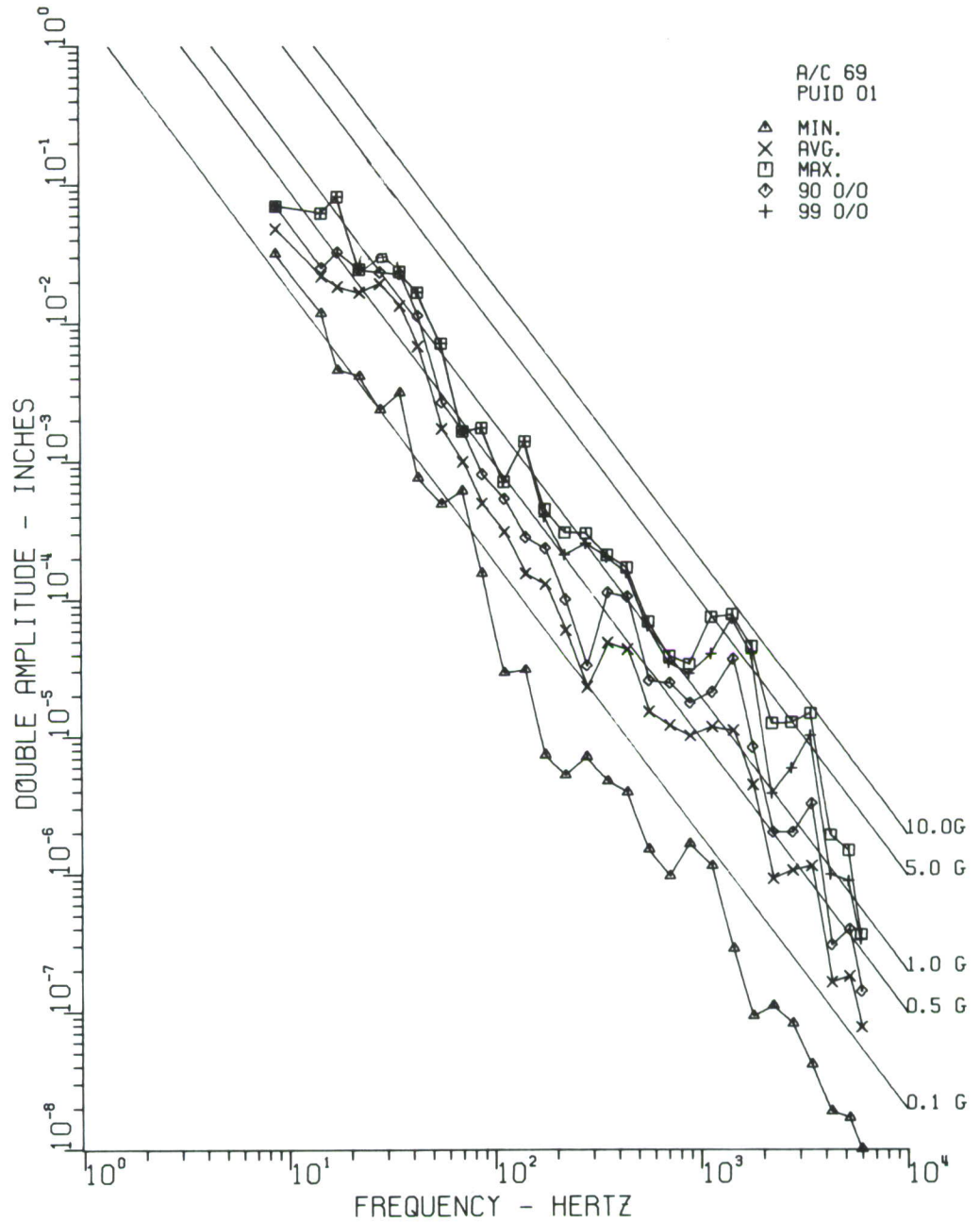

Figure 42. Vertical, Lateral, and Fore and Aft, Main Rotor Transmission Interface, Right Rear Support, Sta. 108, without Gunfire

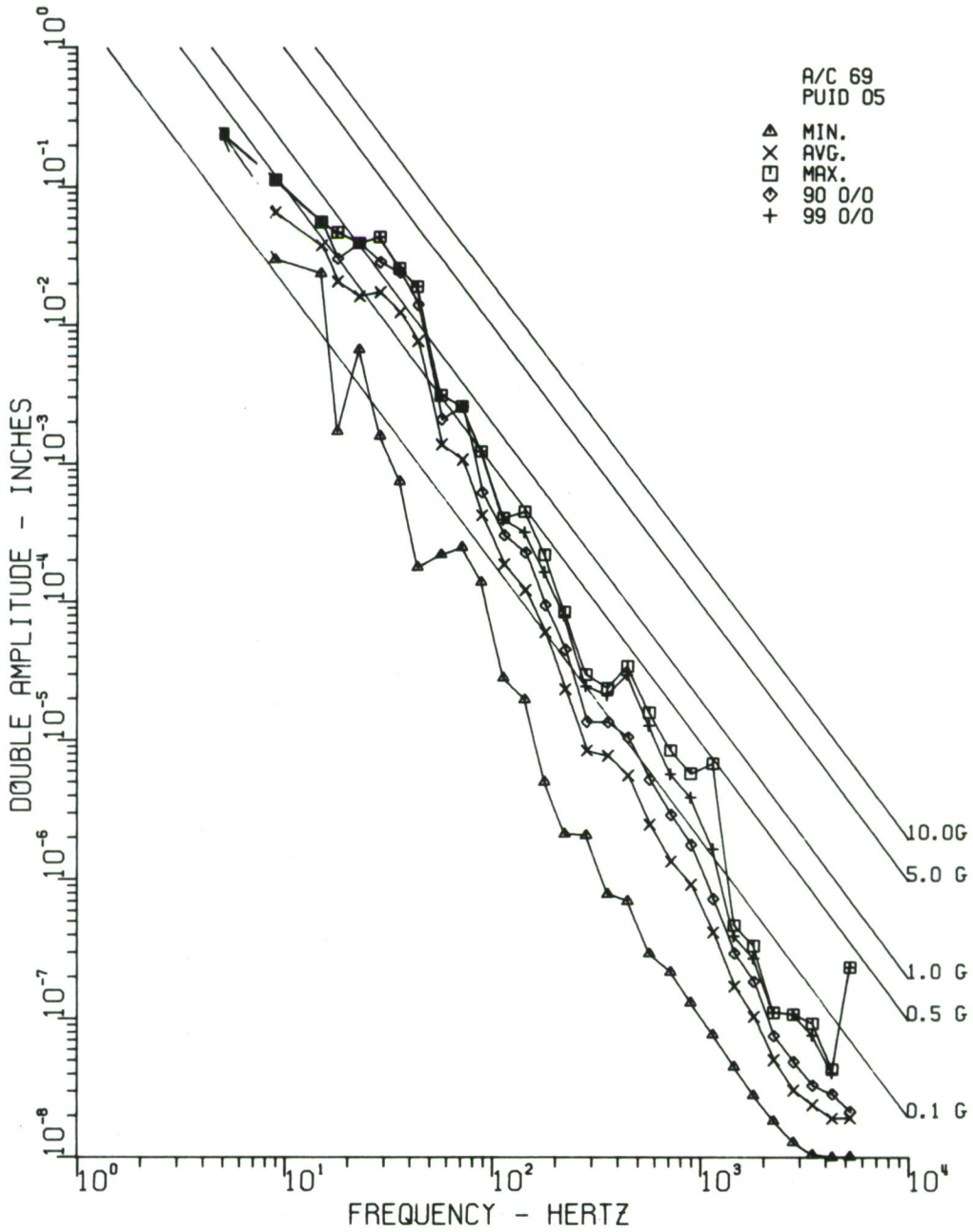

Figure 43. Vertical, Lateral, and Fore and Aft, Instrument Panel, Right Side, Sta. 44, without Gunfire

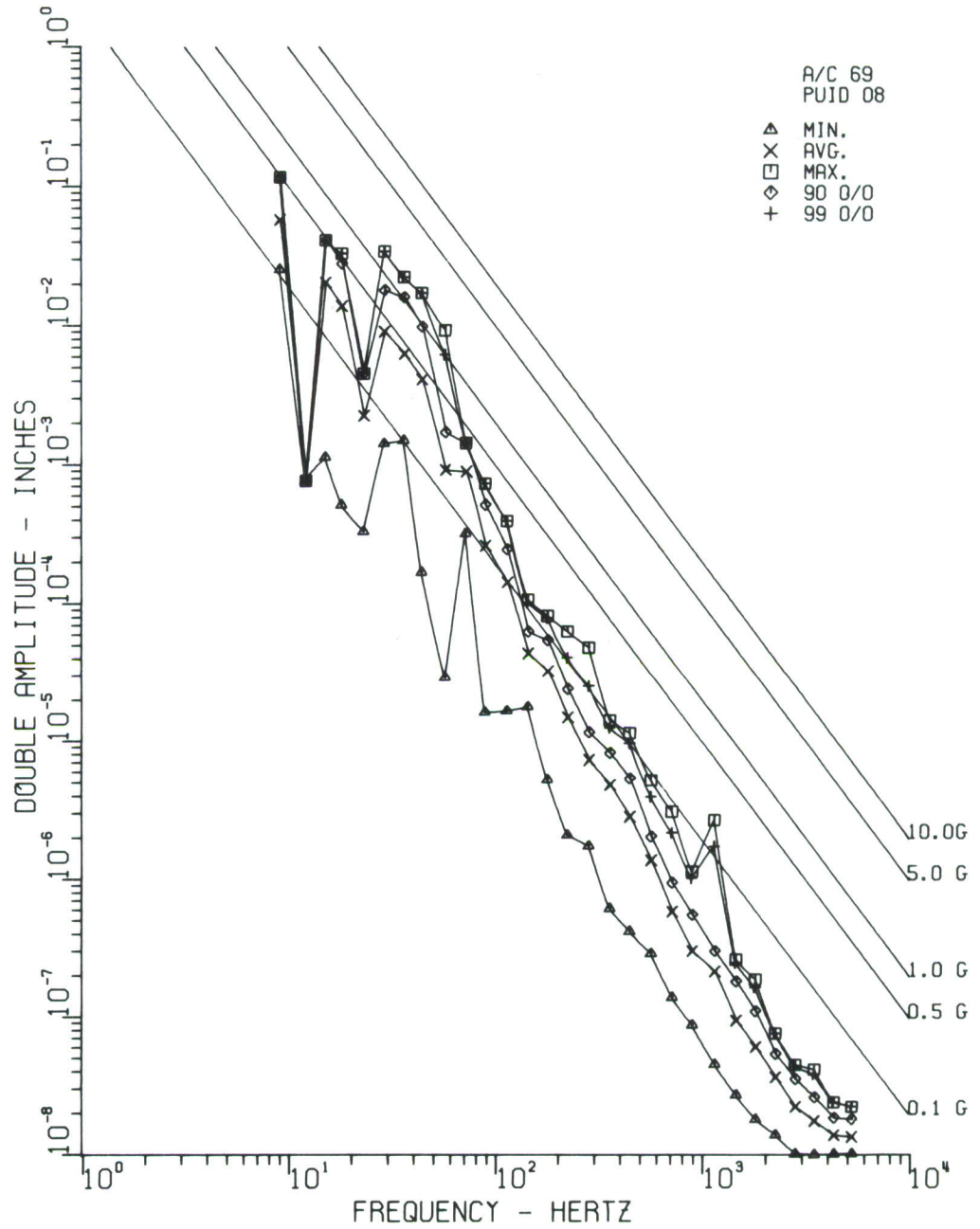

Figure 44. Vertical, Lateral, and Fore and Aft, Instrument Pedestal, Center, Sta. 56, without Gunfire

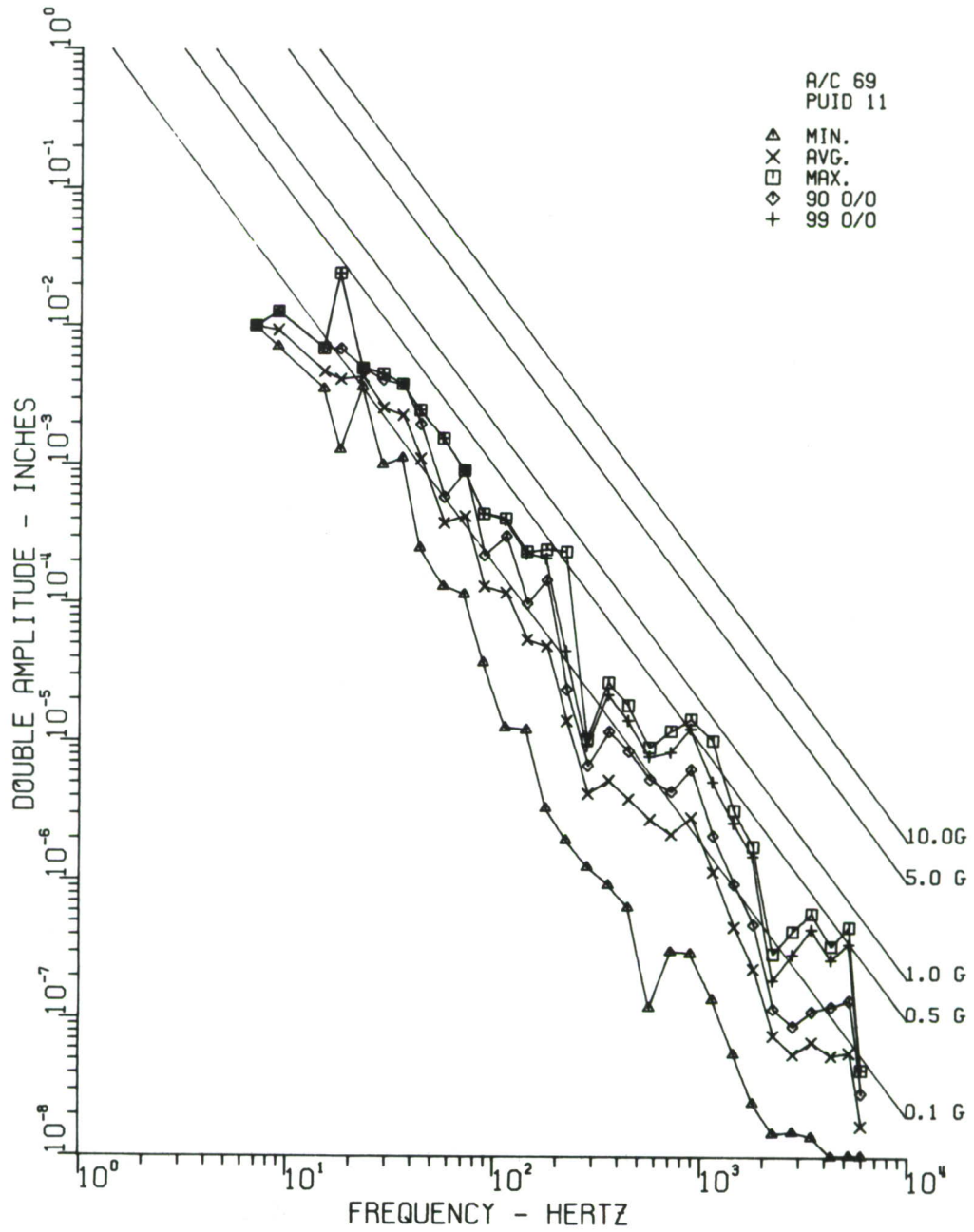

Figure 45. Vertical, Lateral, and Fore and Aft, Cabin Floor, Center, Sta. 88, without Gunfire

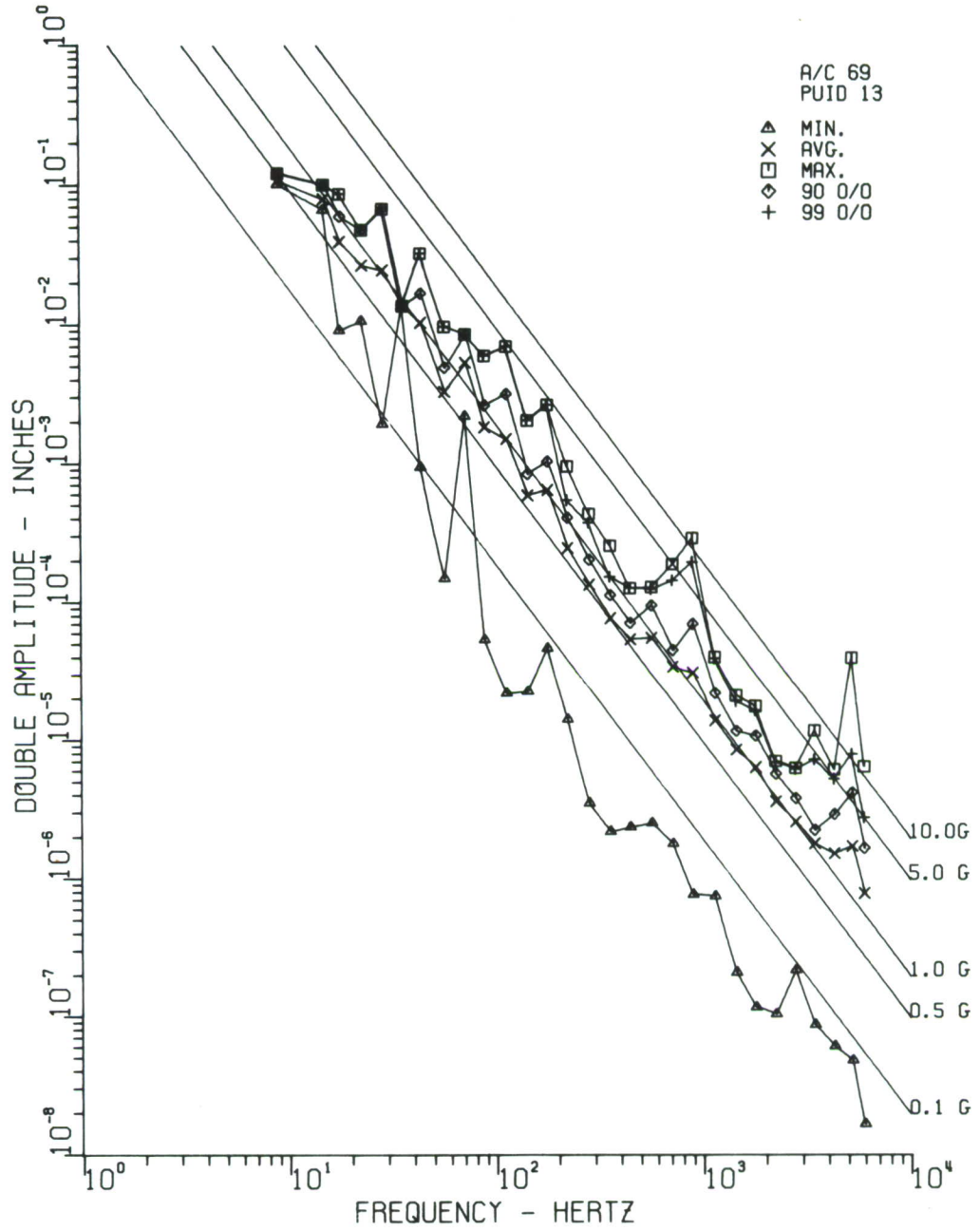

Figure 46. Vertical, Lateral and Fore and Aft, Left Engine Mount, Interface, Sta. 121, without Gunfire

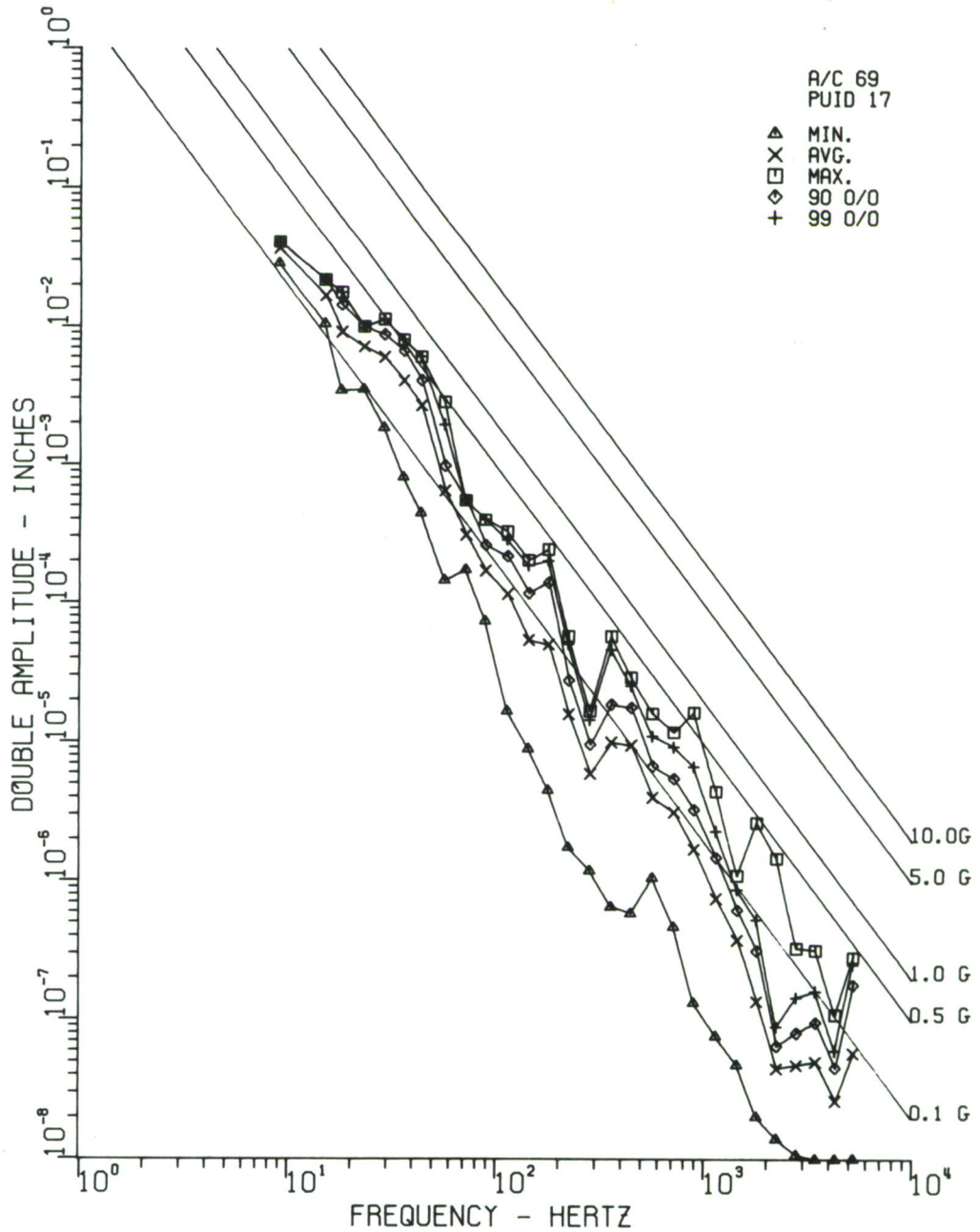

Figure 47. Vertical, Lateral, and Fore and Aft, Electronics Comp., Left Side, AN/ARC-54, Sta. 62, without Gunfire

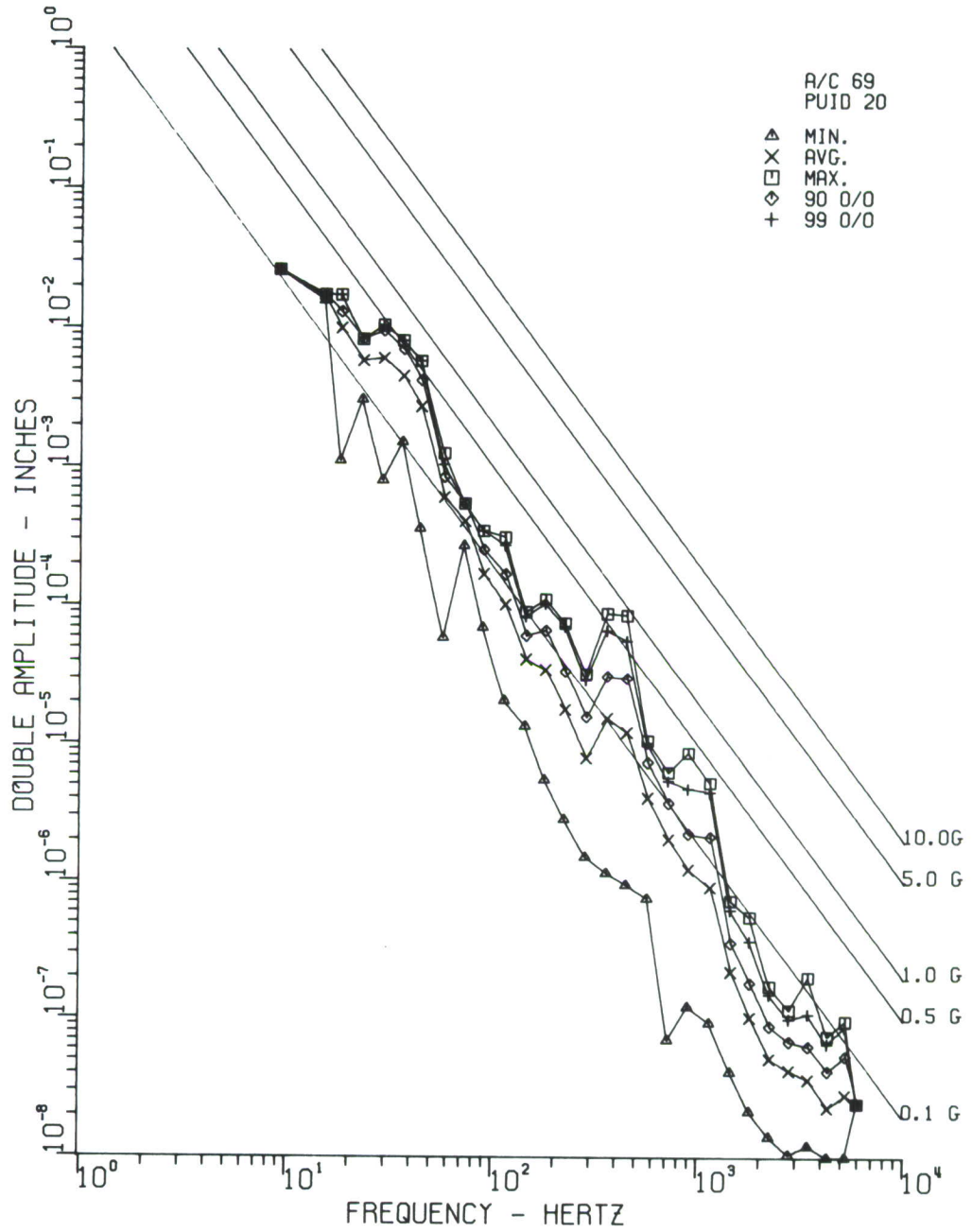

Figure 48. Vertical, Lateral, and Fore and Aft, Electronics Comp., Left Side, AN/ARC-54, Sta. 58, without Gunfire

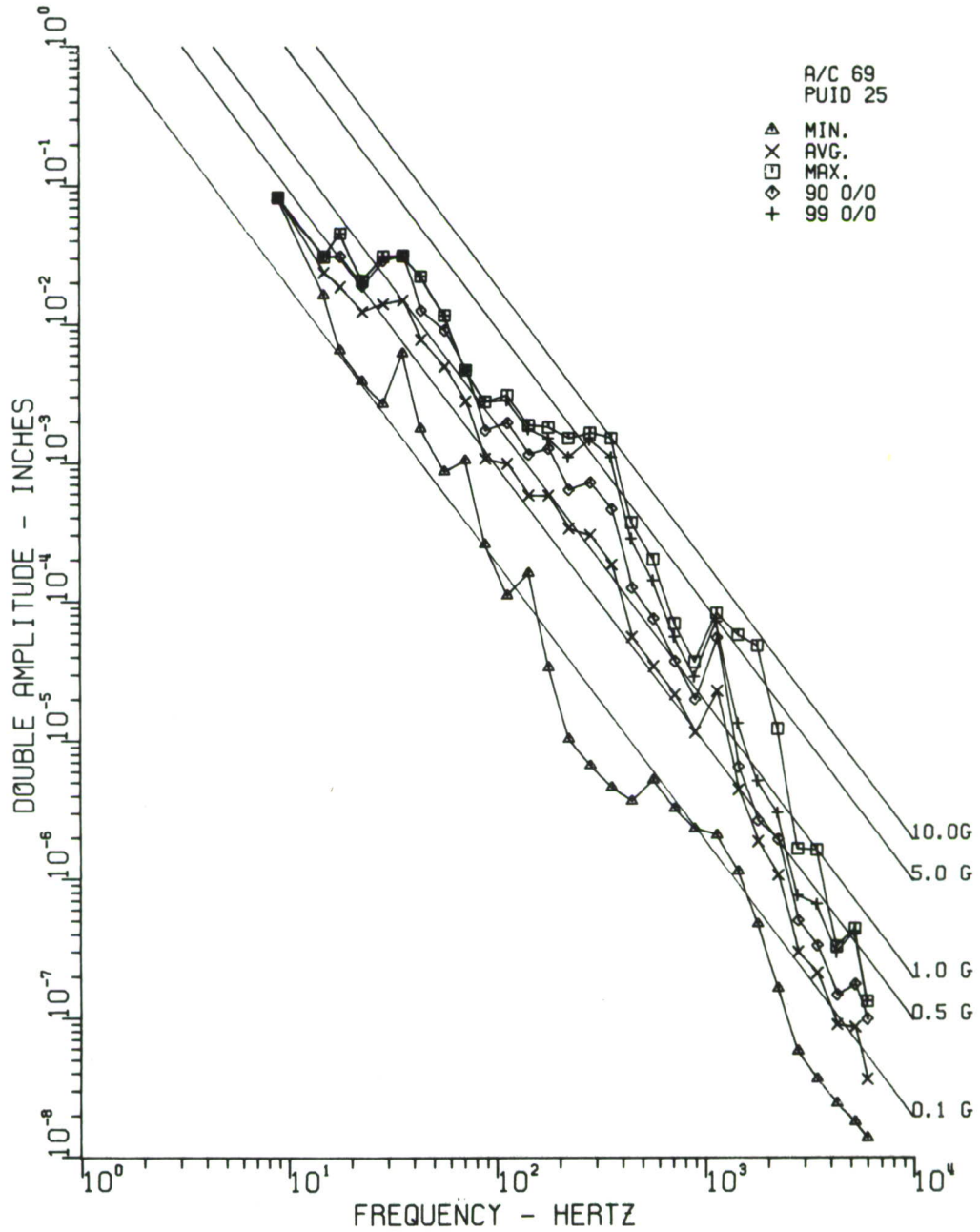

Figure 49. Vertical, Lateral, and Fore and Aft, Tail Section, Center, Sta. 220, without Gunfire

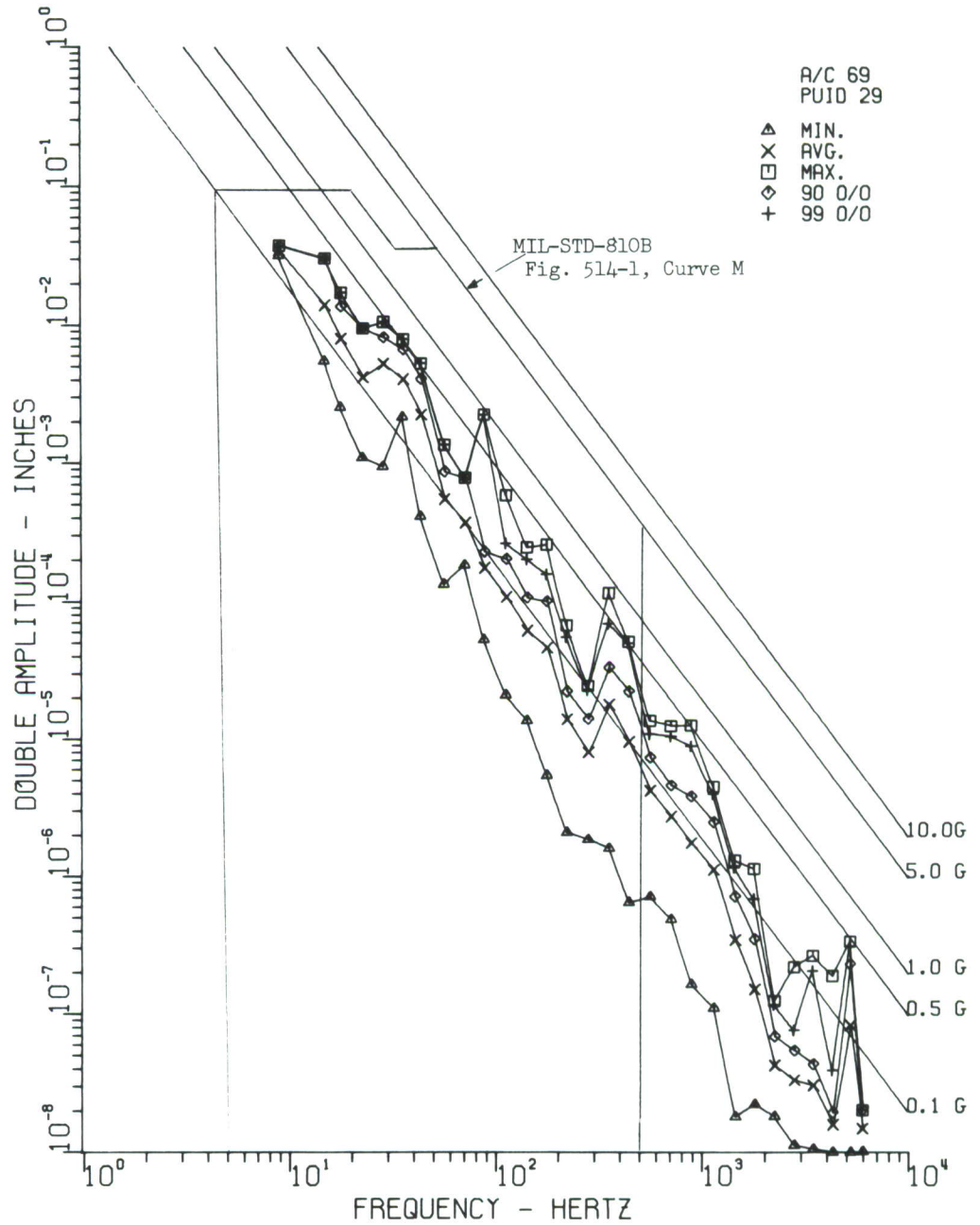

Figure 50. Vertical, Lateral, and Fore and Aft, Electronics Comp., Right Side, AN/ARC-51, Sta. 62, without Gunfire

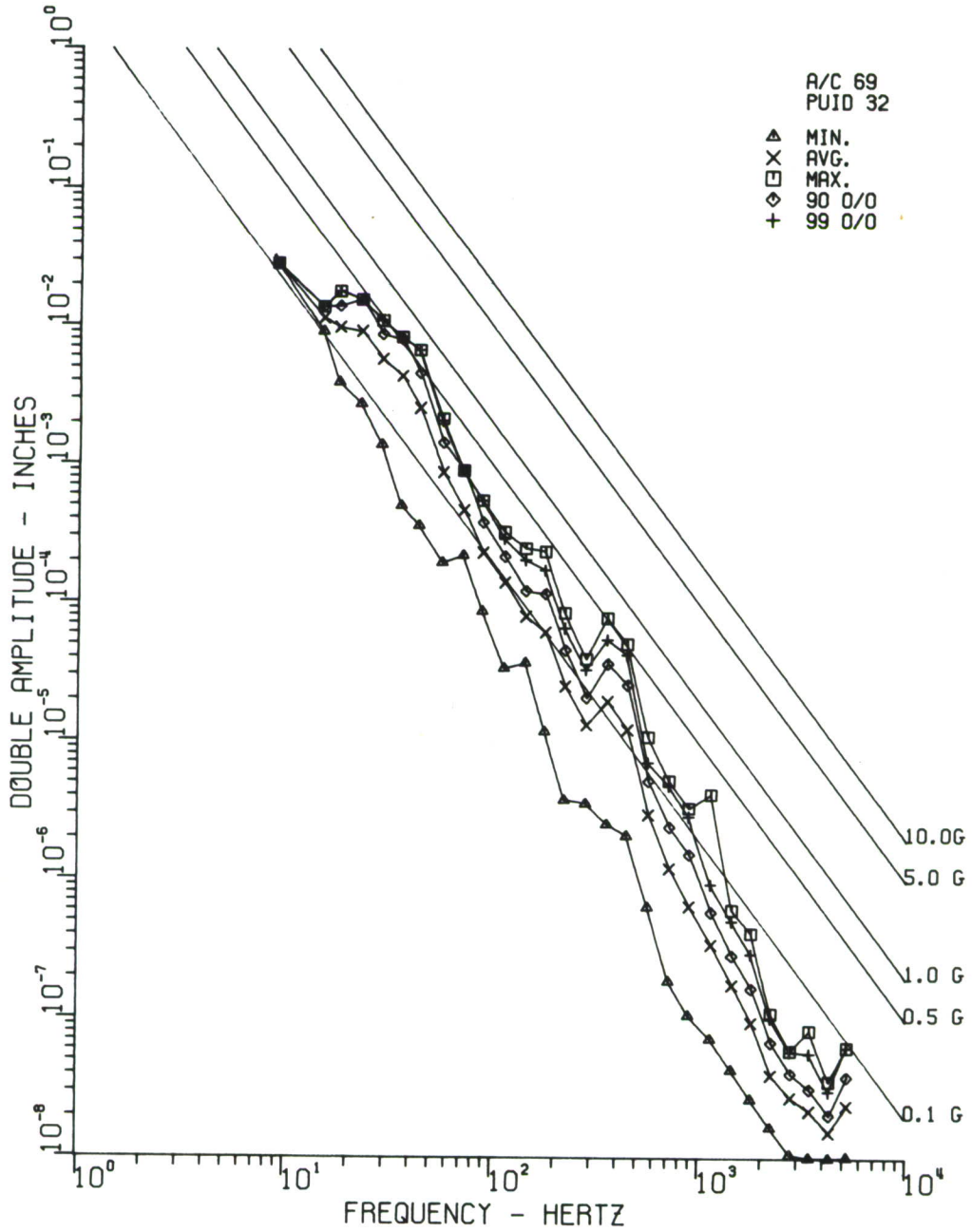

Figure 51. Vertical, Lateral, and Fore and Aft, Electronics Comp., Right Side, AN/ARC-51, Sta. 62, without Gunfire

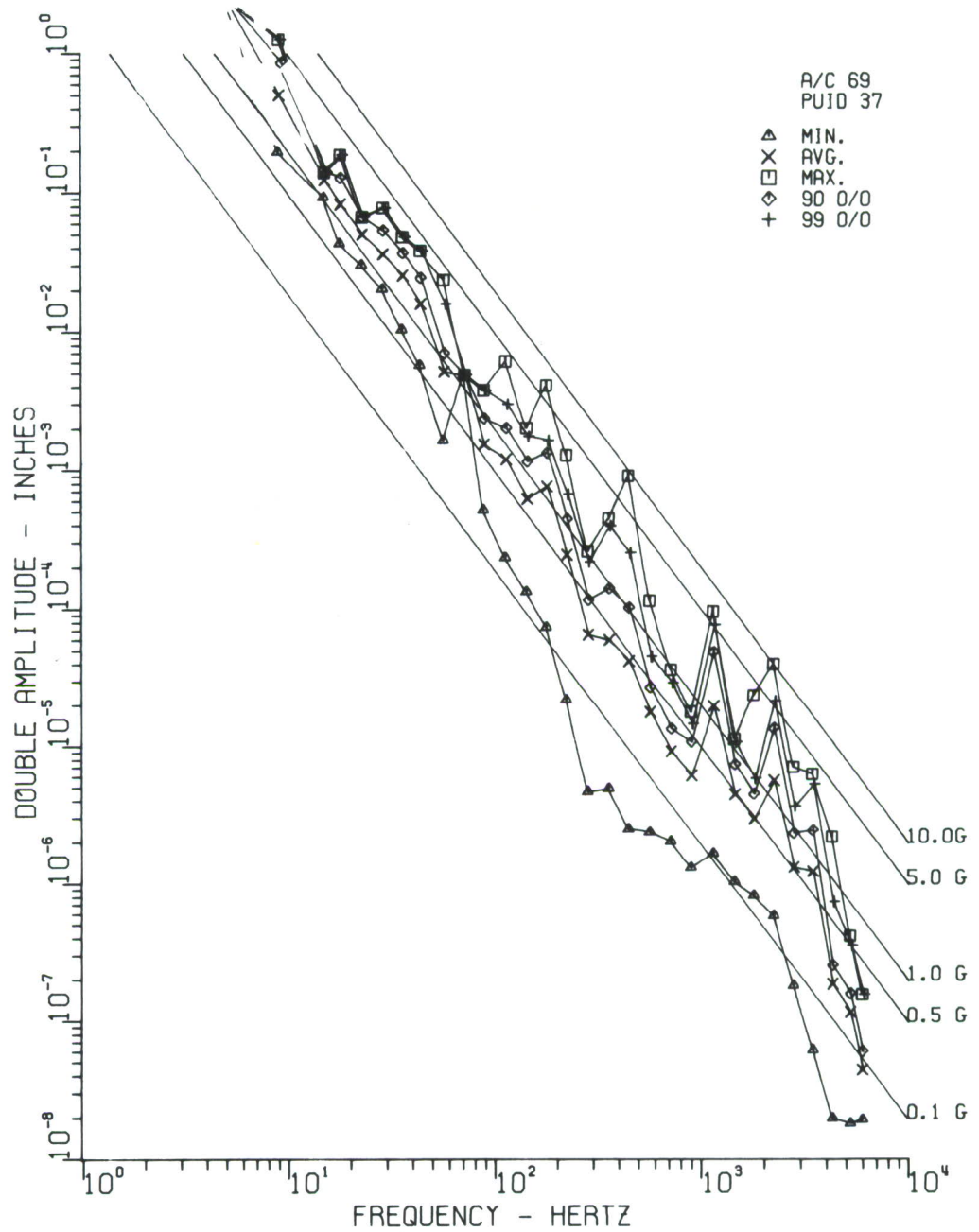

Figure 52. Vertical, Lateral and Fore and Aft, Tail Section Near 90° Gear Box, Sta. 273, without Gunfire

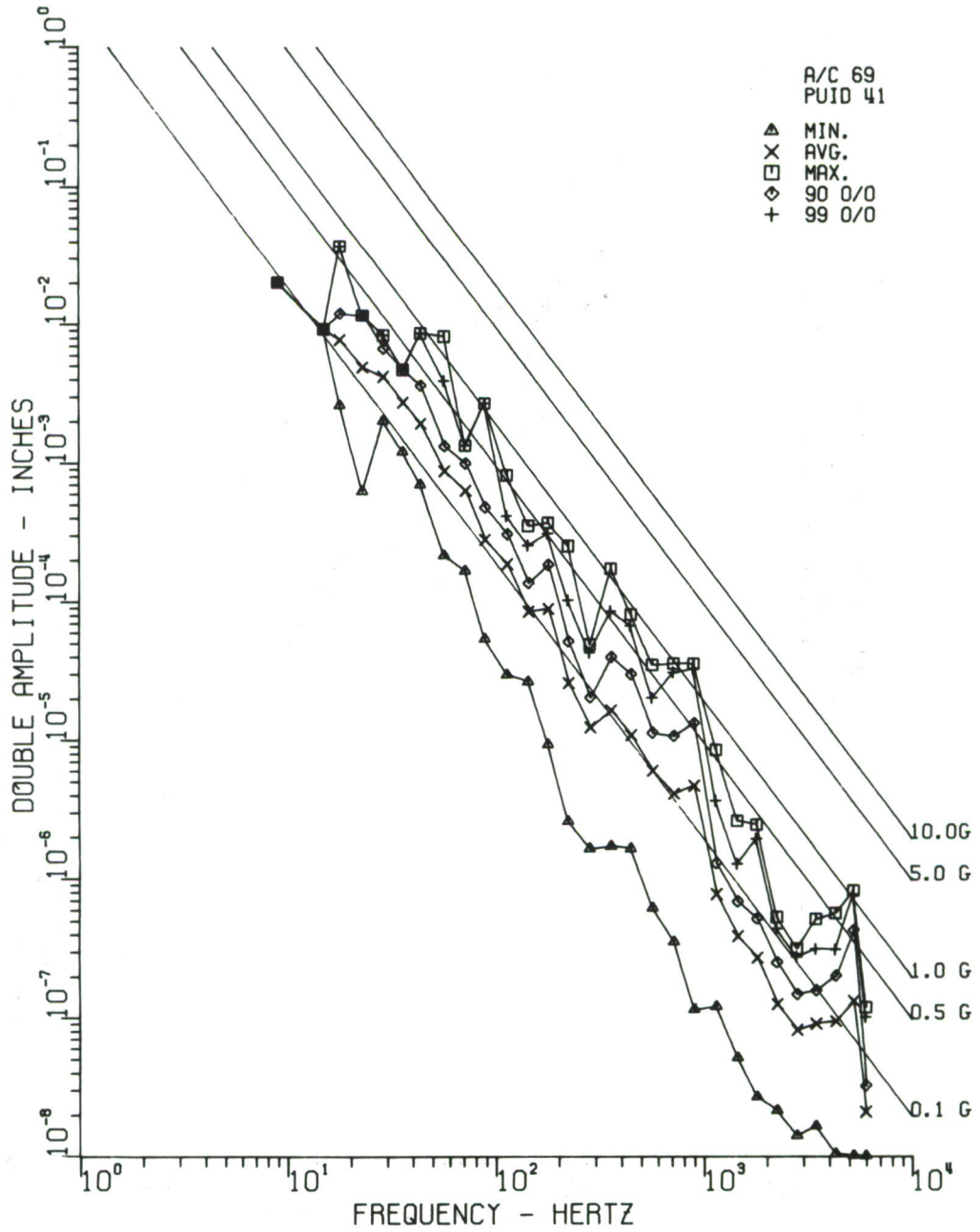

Figure 53. Vertical, Lateral, and Fore and Aft, Cabin Floor, Left Side, Sta. 110, without Gunfire

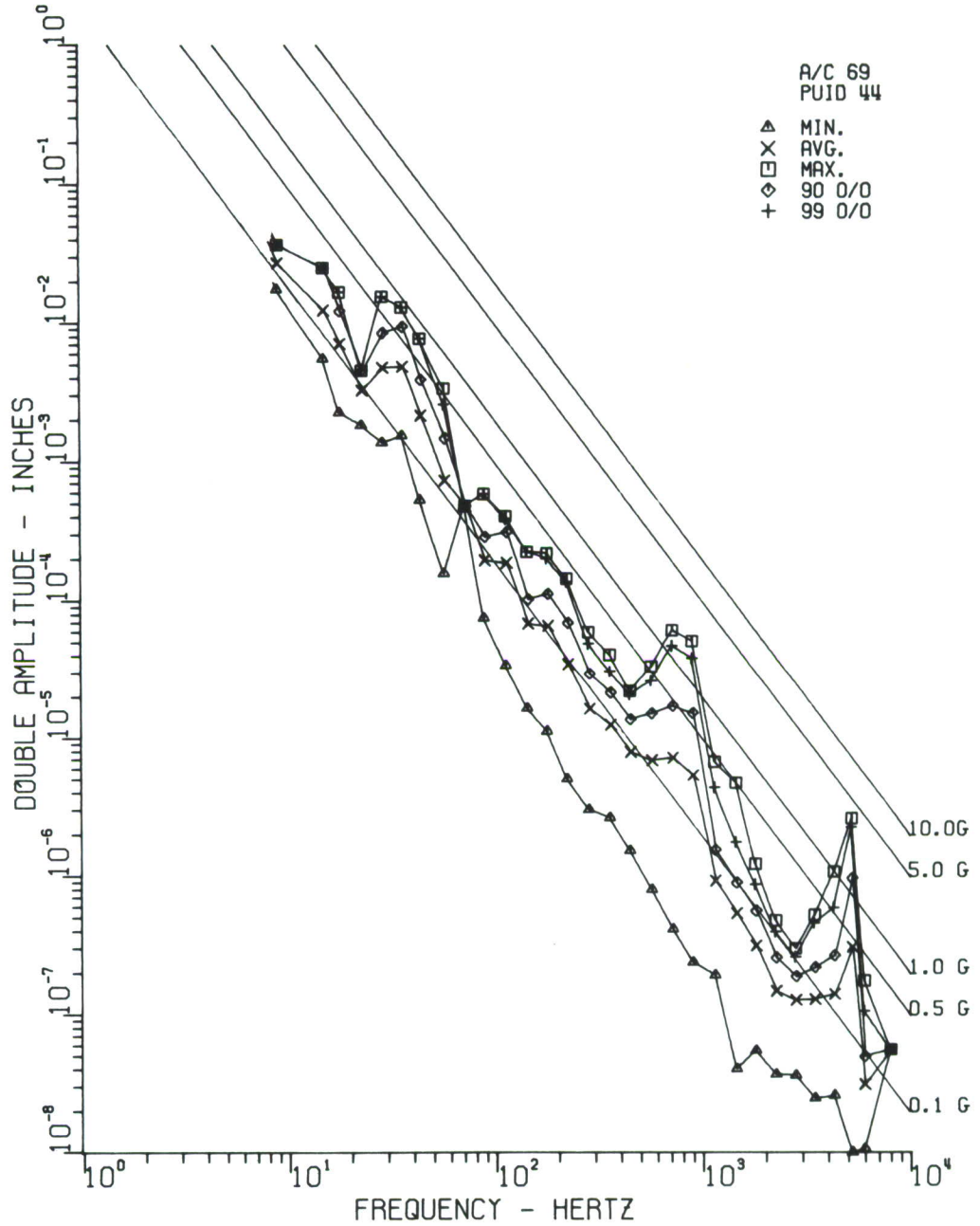

Figure 54. Vertical, Lateral, and Fore and Aft, Cabin Floor, Right Side, Sta. 110, without Gunfire

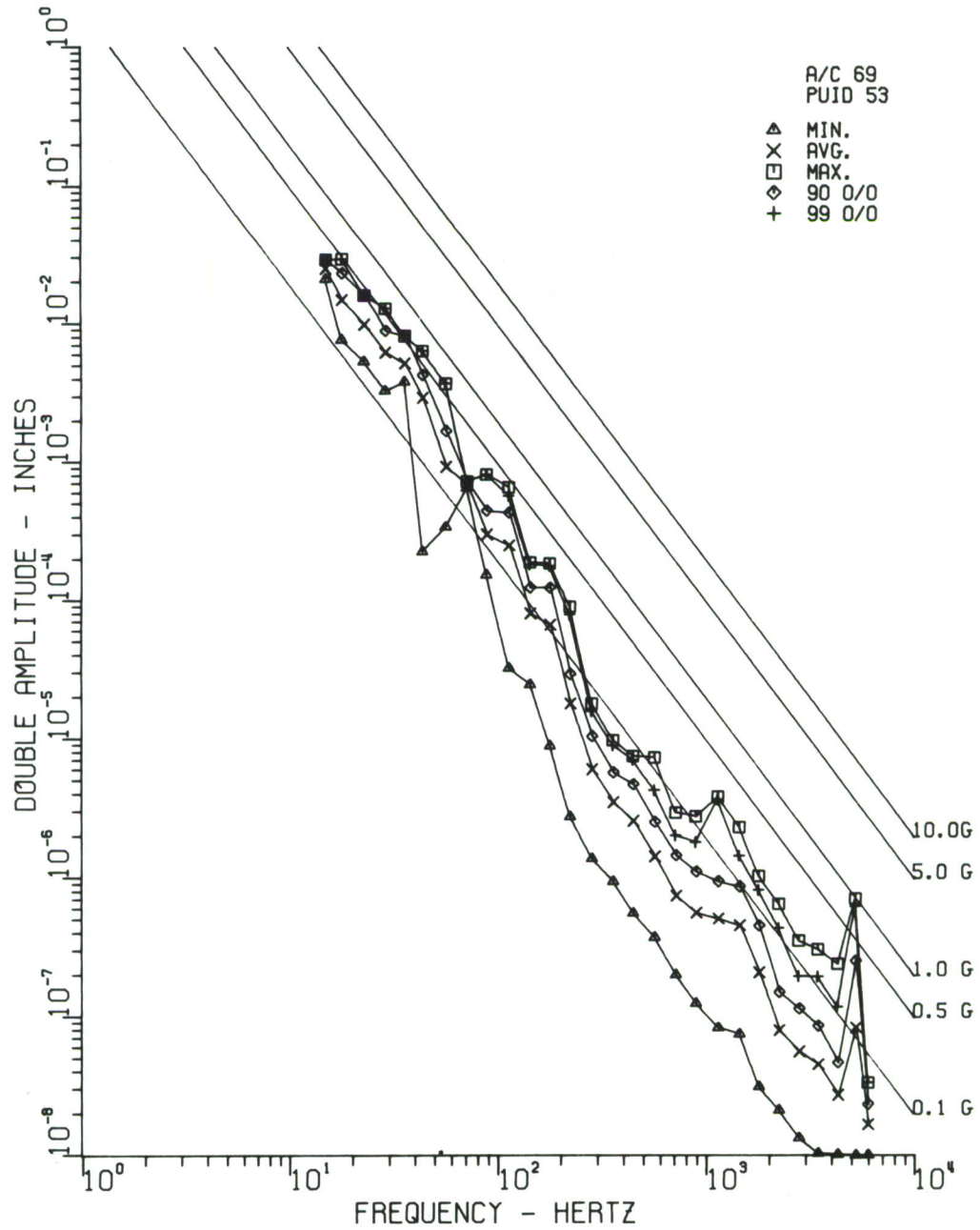

Figure 55. Vertical, Lateral, and Fore and Aft, XM-27 Armament Mount, Sta. 92, without Gunfire

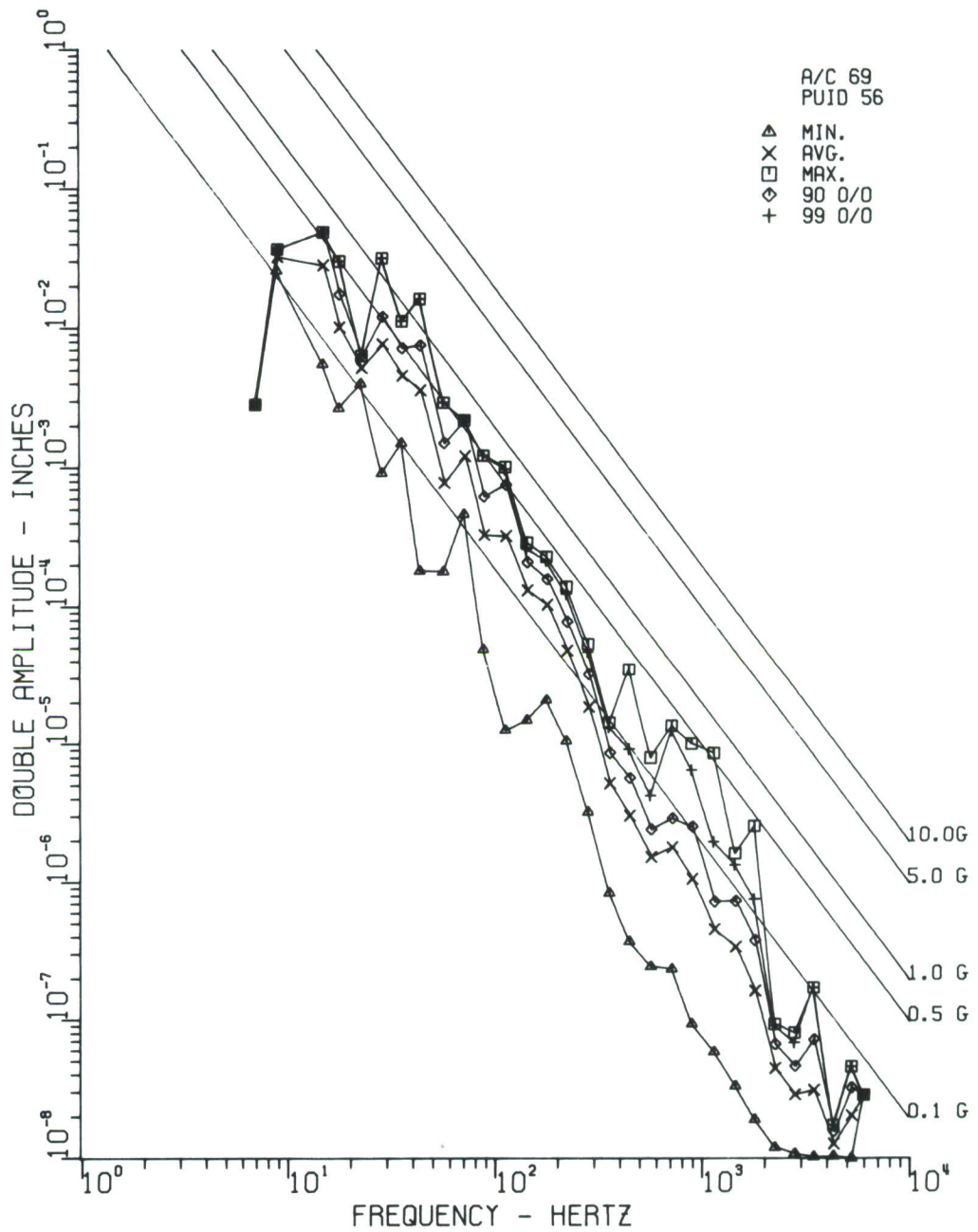

Figure 56. Vertical, Lateral, and Fore and Aft, Directional Gyro Shelf, Left Side, Sta. 70, without Gunfire

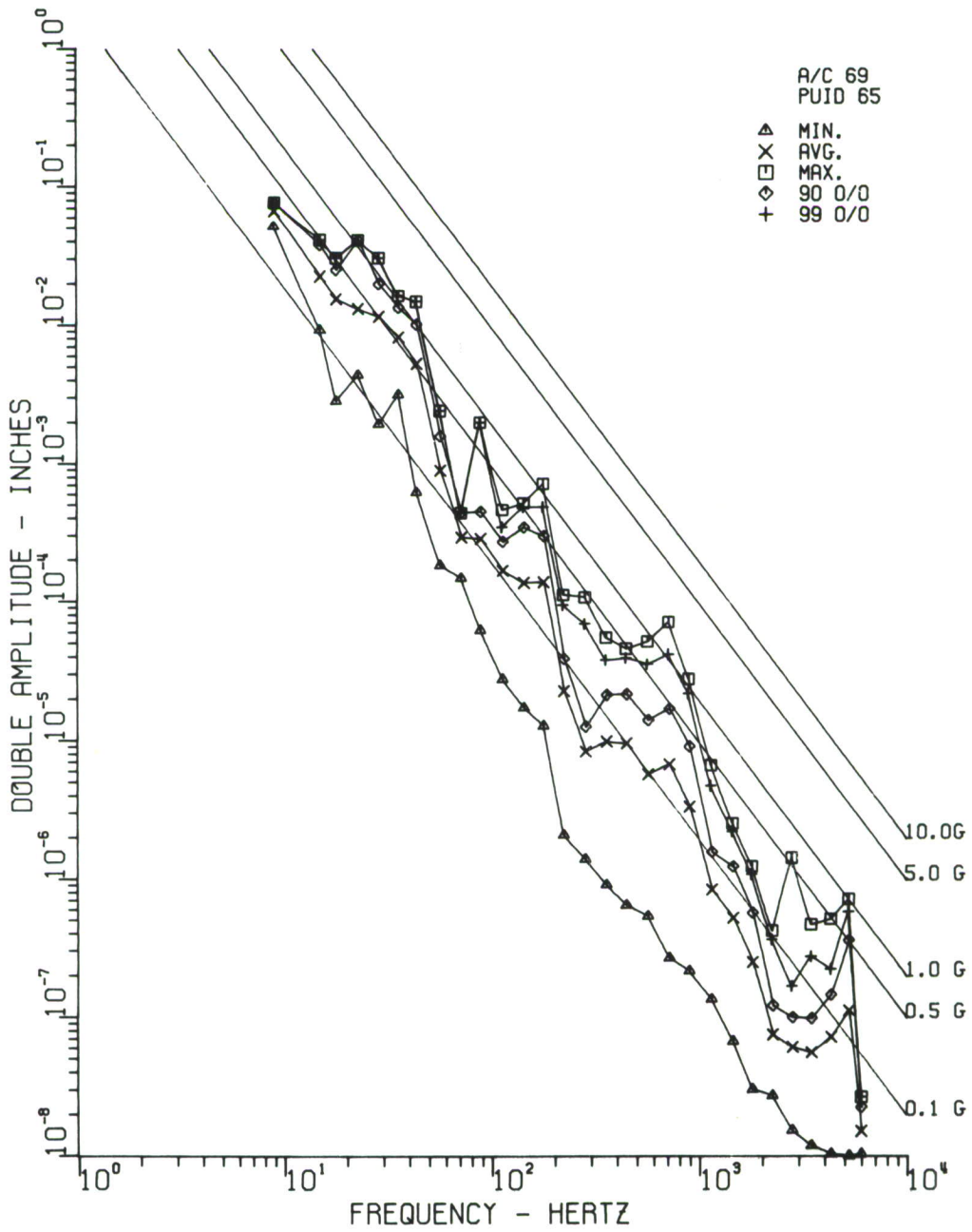

Figure 57. Vertical, Lateral, and Fore and Aft, ADF Antenna Interface Sta. 69 without Gunfire

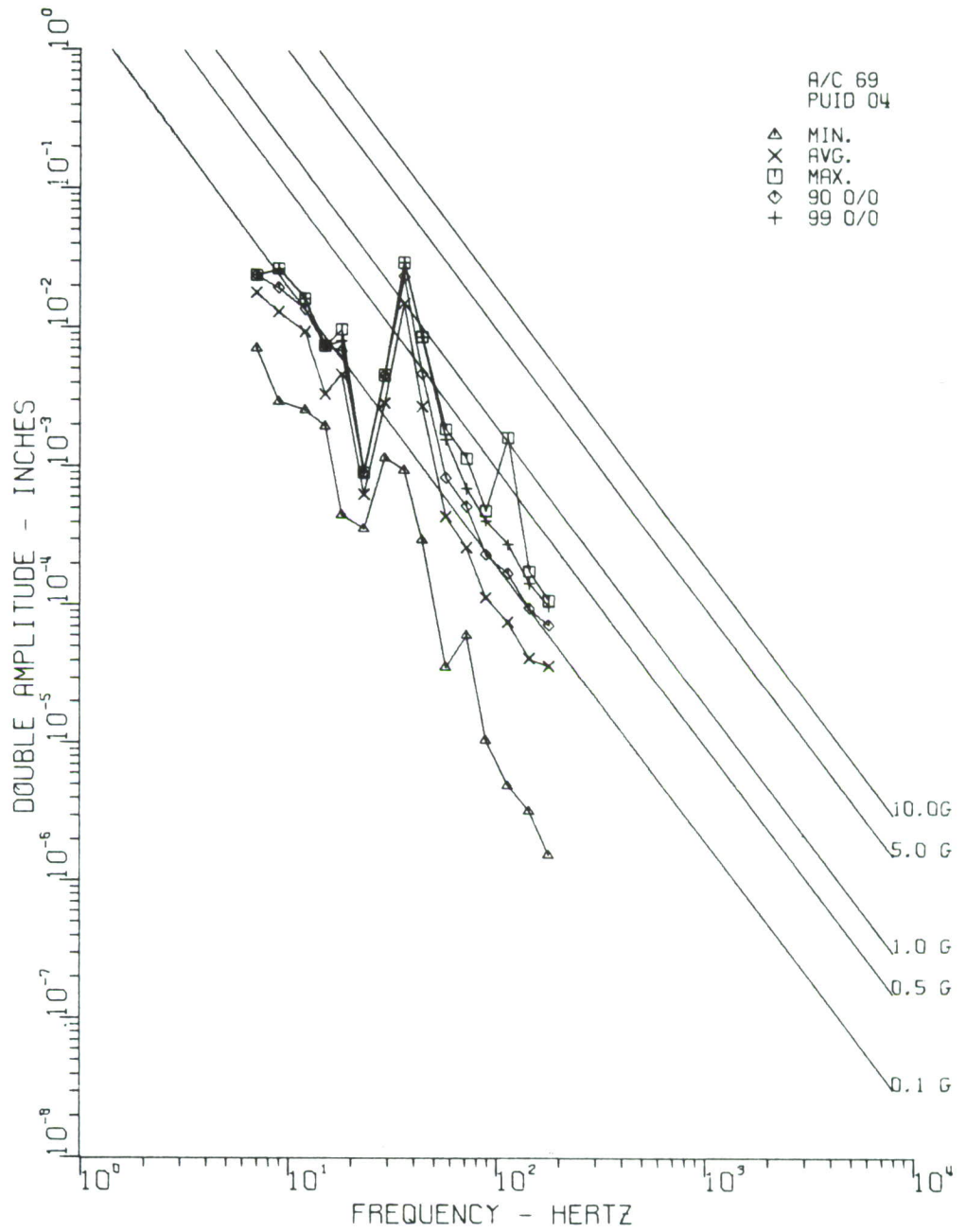

Figure 58. Vertical, Lateral, and Fore and Aft, Instrument Panel, Left Side, Sta. 43, without Gunfire

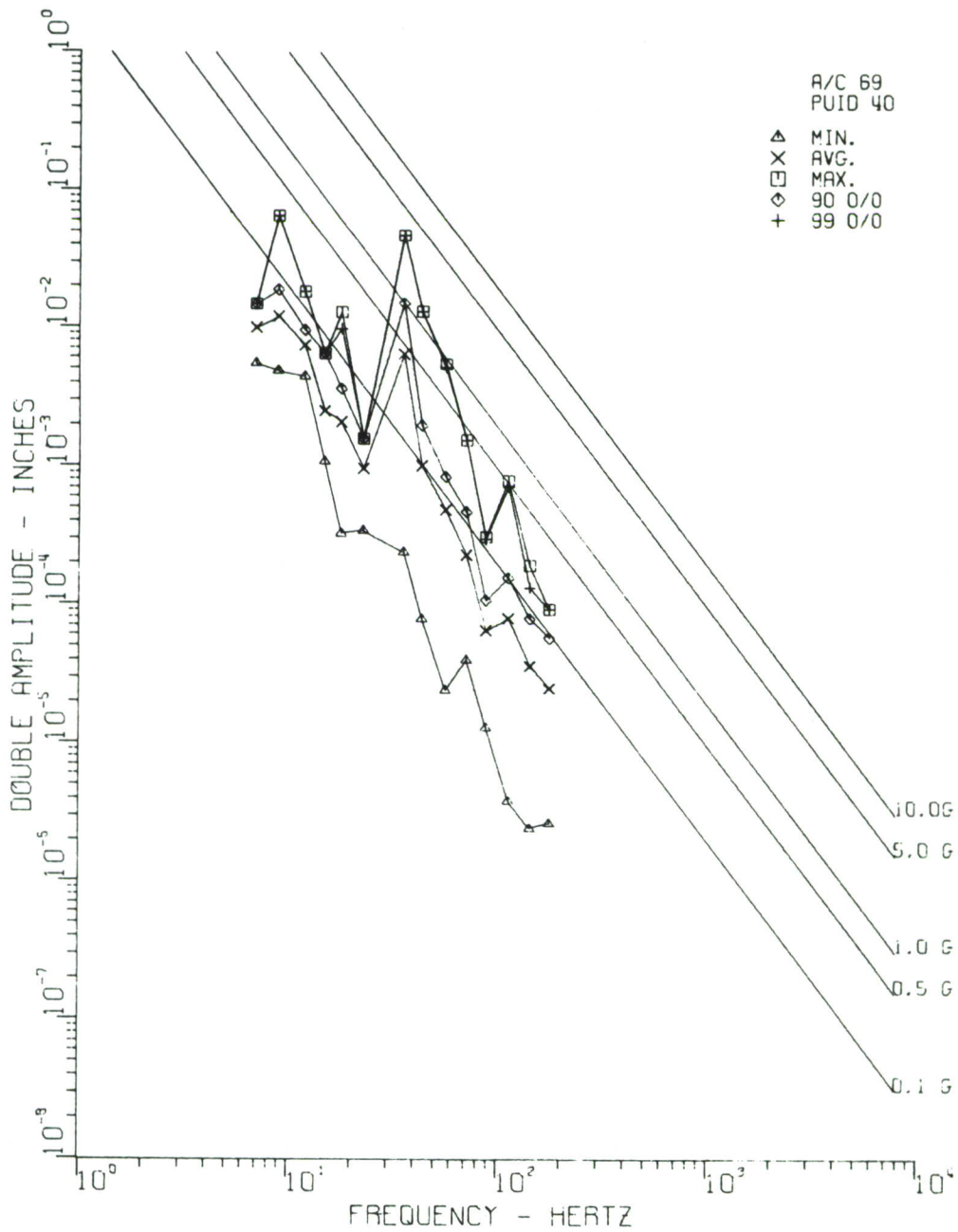

Figure 59. Vertical and Lateral, Instrument Panel Base, Left Side, Sta. 39, without Gunfire

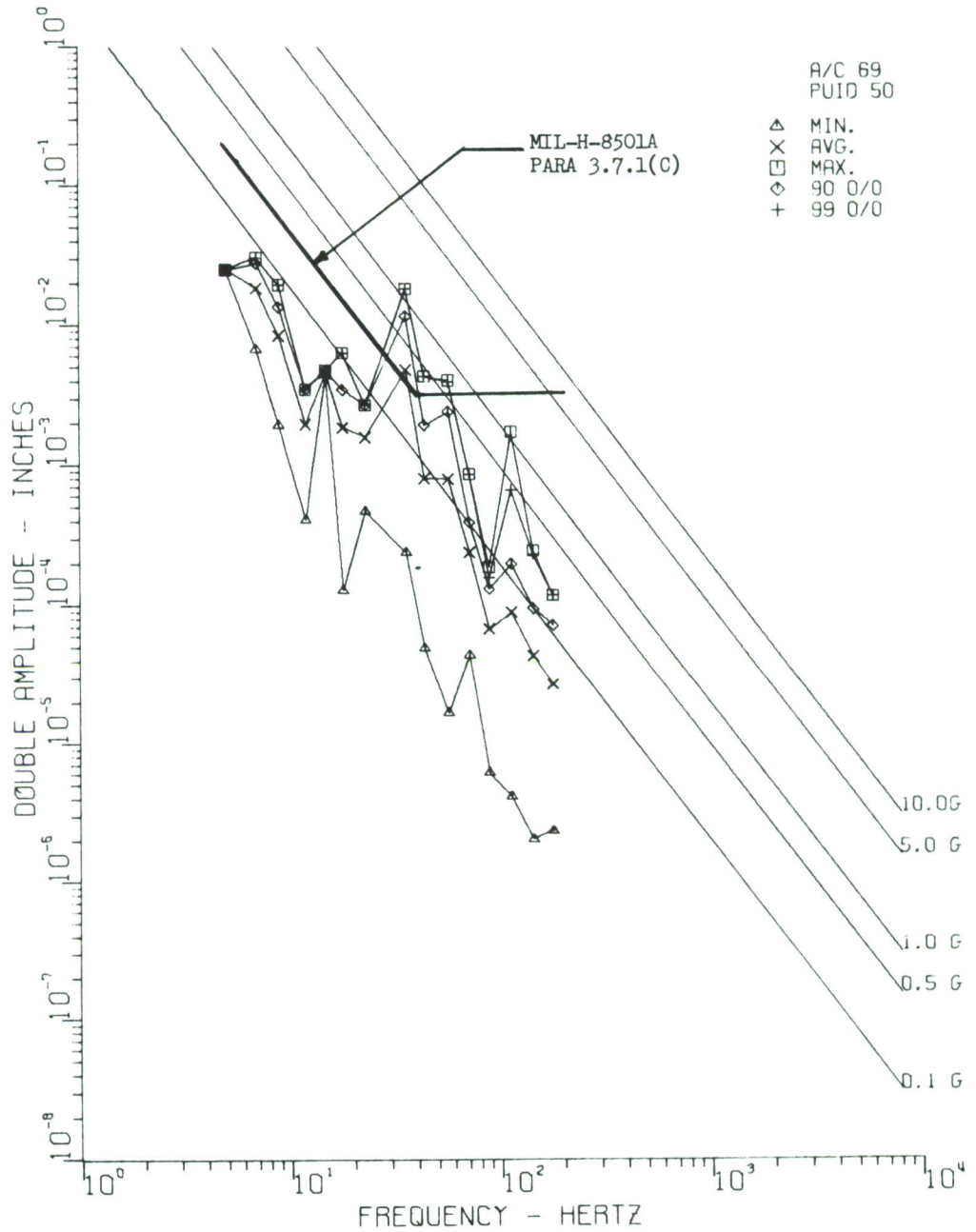

Figure 60. Vertical and Lateral, Cabin Floor, Right Side, Sta. 90, without Gunfire

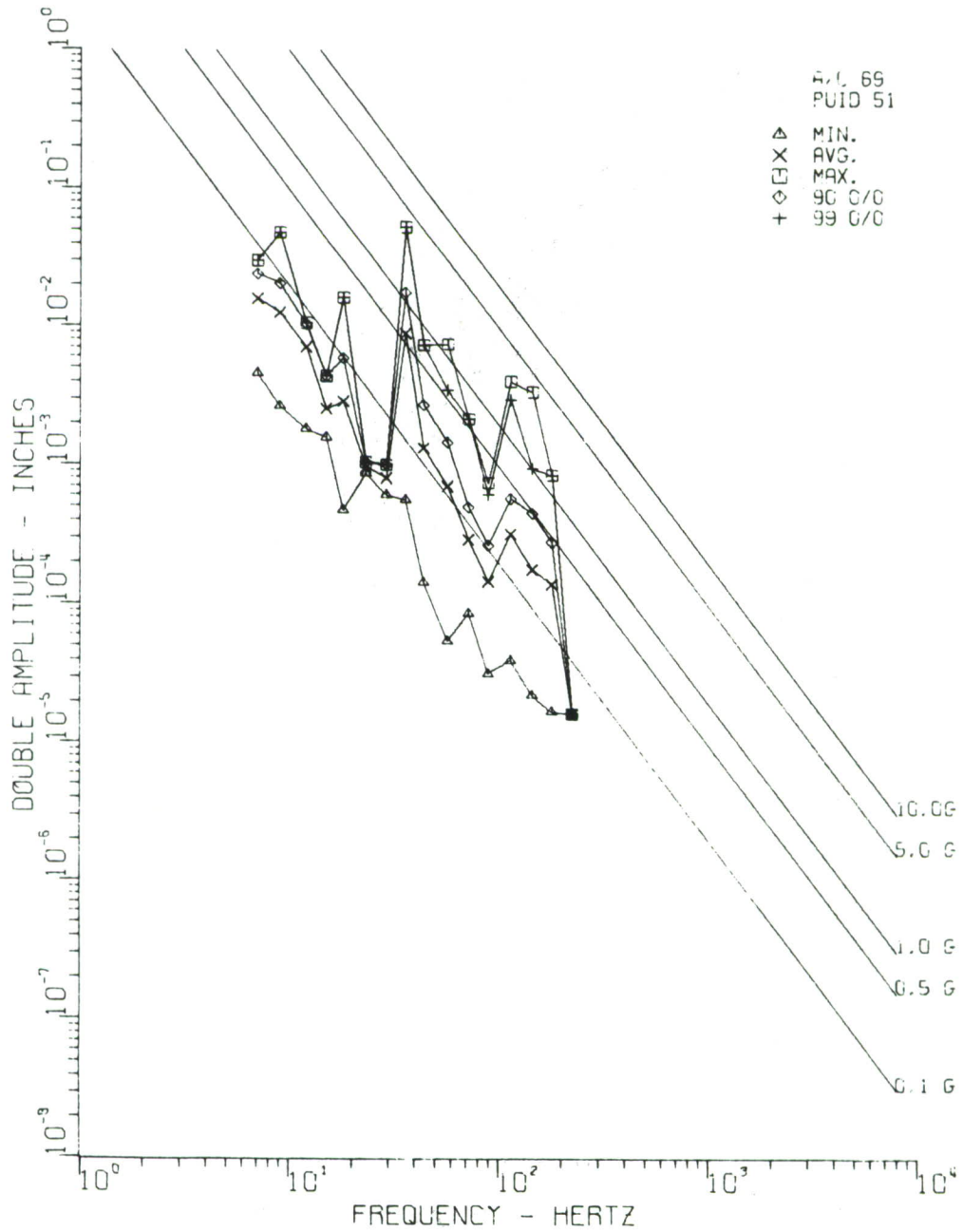

Figure 61. Vertical and Lateral, Fuselage-Tail Section Interface, Sta. 130, without Gunfire

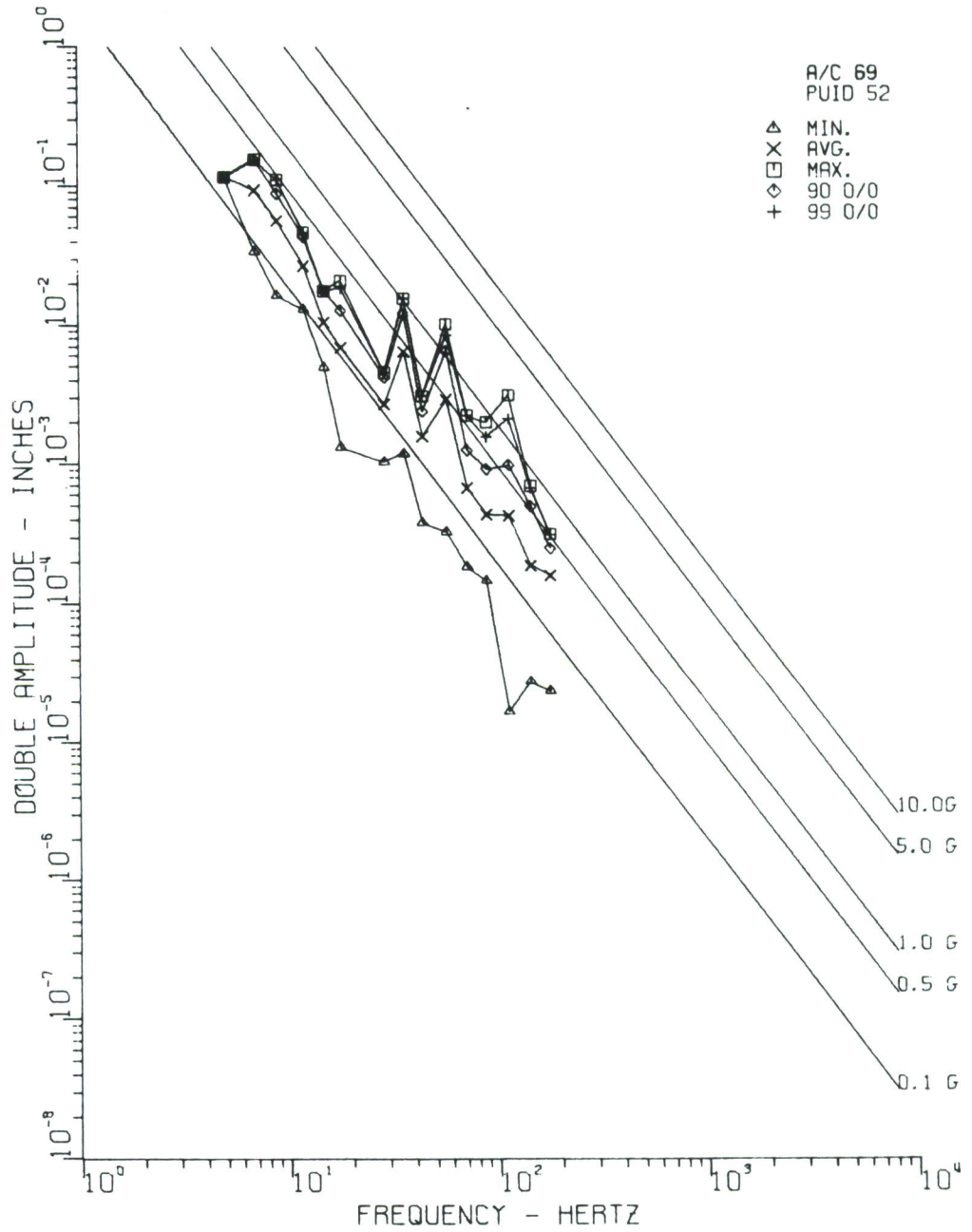

Figure 62. Vertical and Lateral, Tail Section, Near 90° Gear Box, Sta. 273, without Gunfire

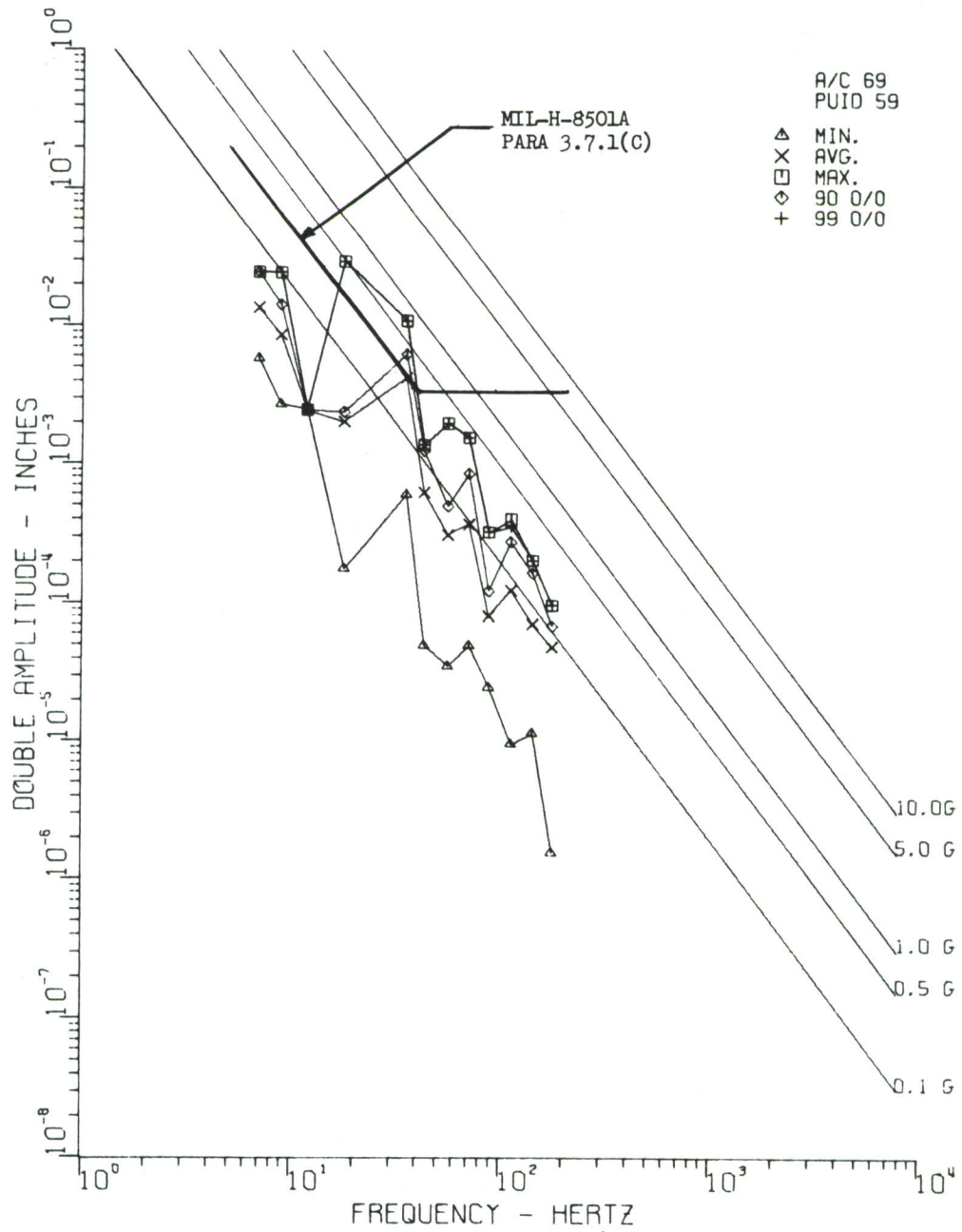

Figure 63. Vertical, Cabin Floor, Left Side, Sta. 90, without Gunfire

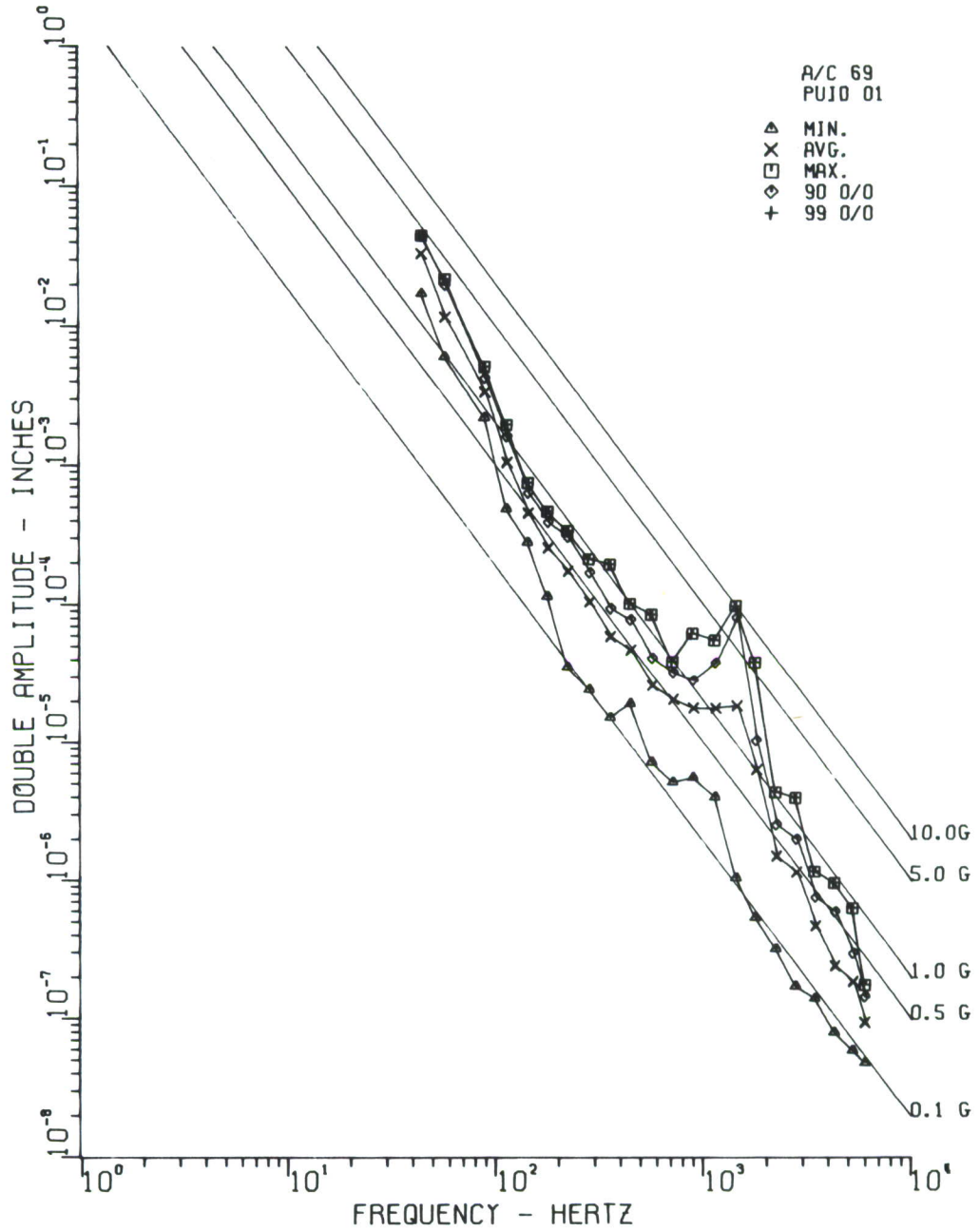

Figure 64. Vertical, Lateral and Fore and Aft, Main Rotor Transmission Interface, Right Rear Support, Sta. 108, with Gunfire

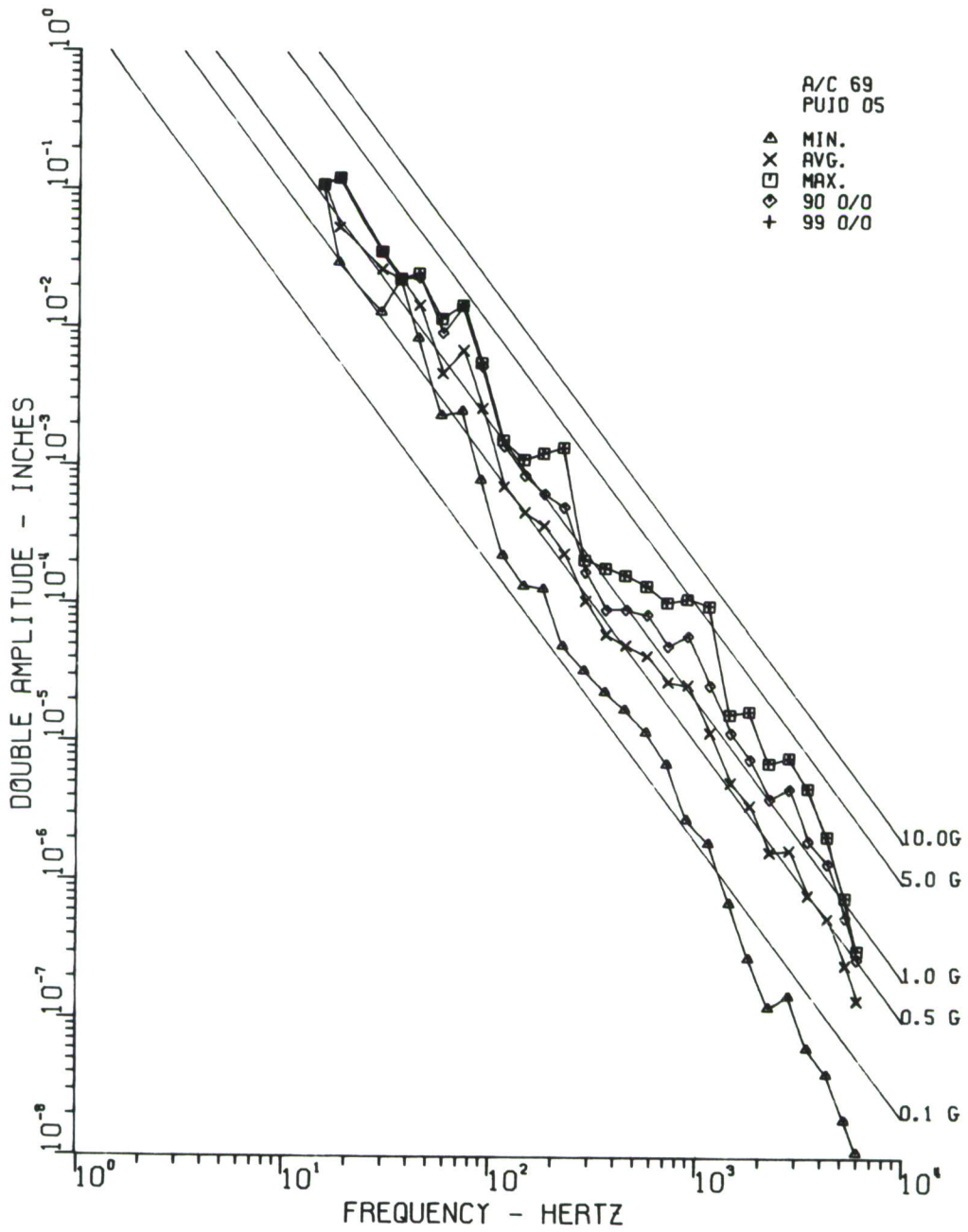

Figure 65. Vertical, Lateral, and Fore and Aft, Instrument Panel, Right Side, Sta. 44, with Gunfire

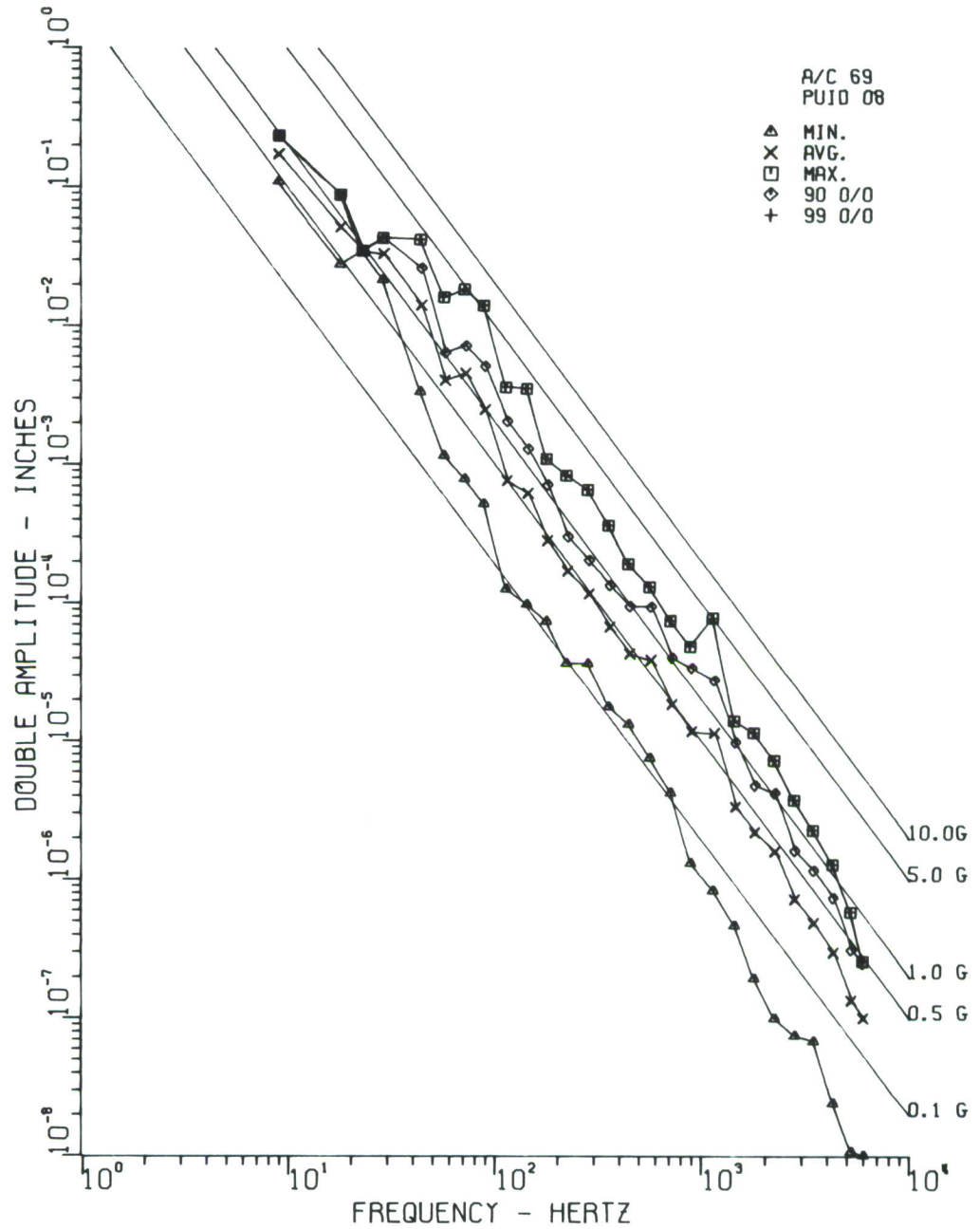

Figure 66. Vertical, Lateral, and Fore and Aft, Instrument Pedestal, Center, Sta. 56, with Gunfire

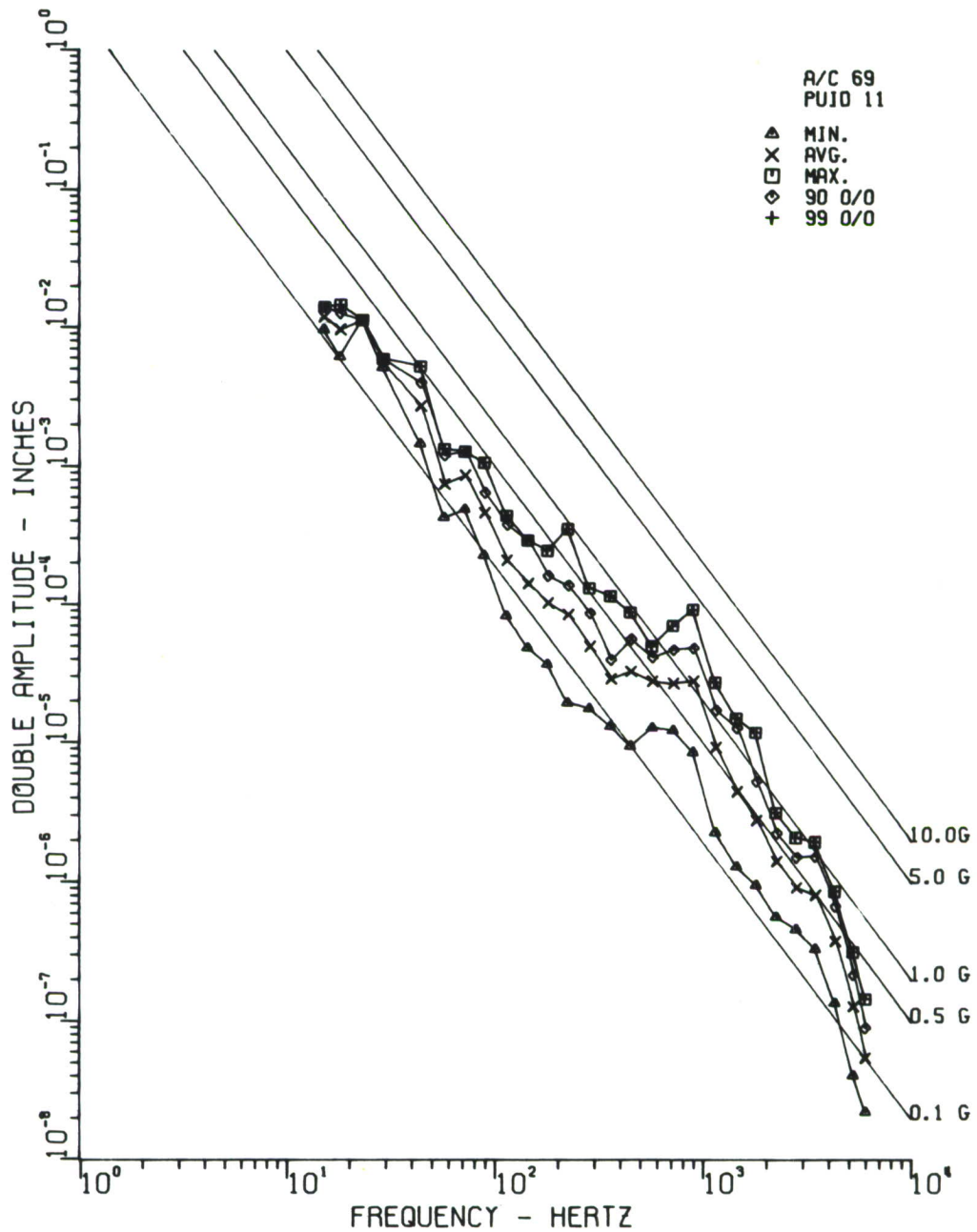

Figure 67. Vertical, Lateral, and Fore and Aft, Cabin Floor, Center Sta. 88, with Gunfire

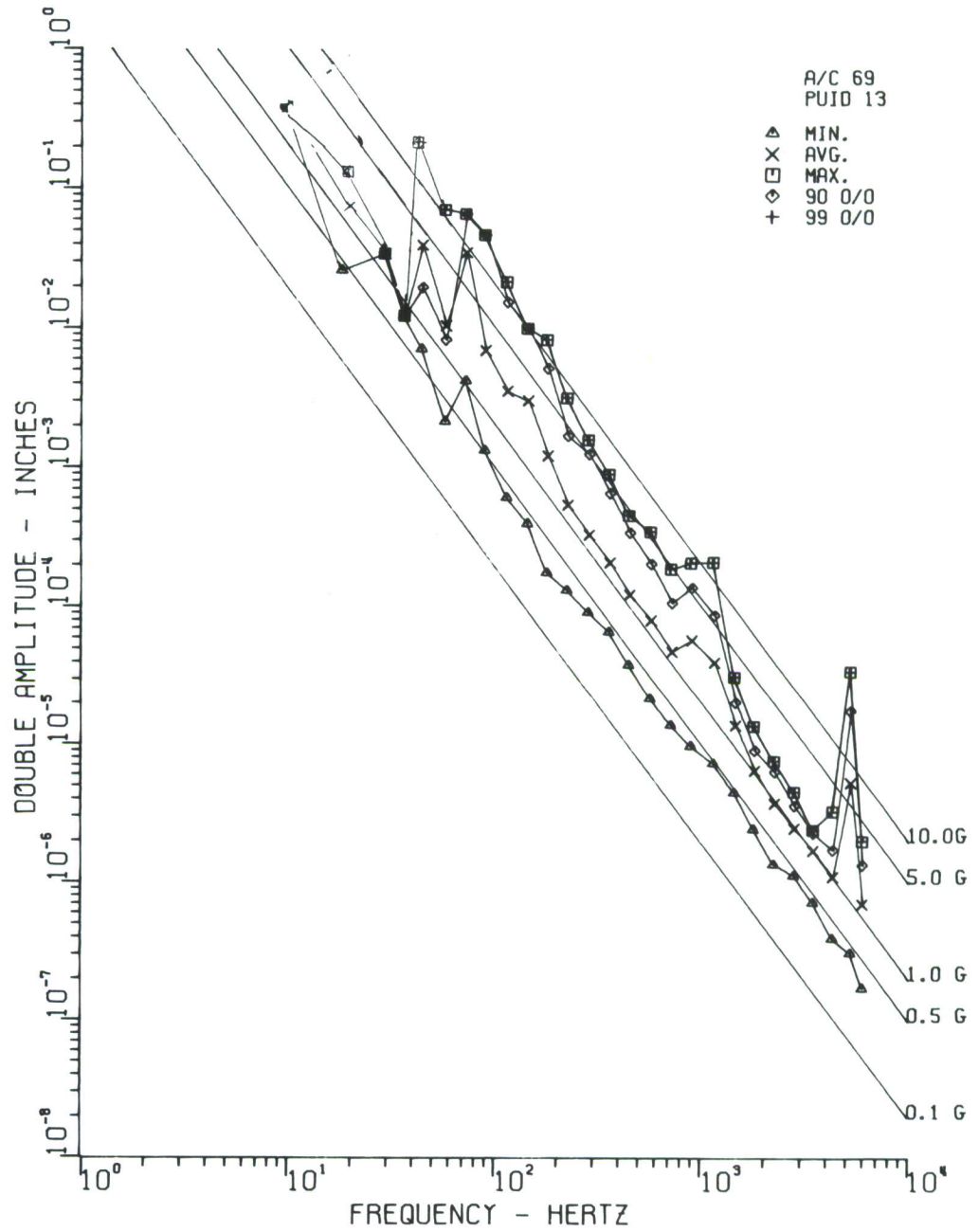

Figure 68. Vertical, Lateral and Fore and Aft, Left Engine Mount Interface, Sta. 121, with Gunfire

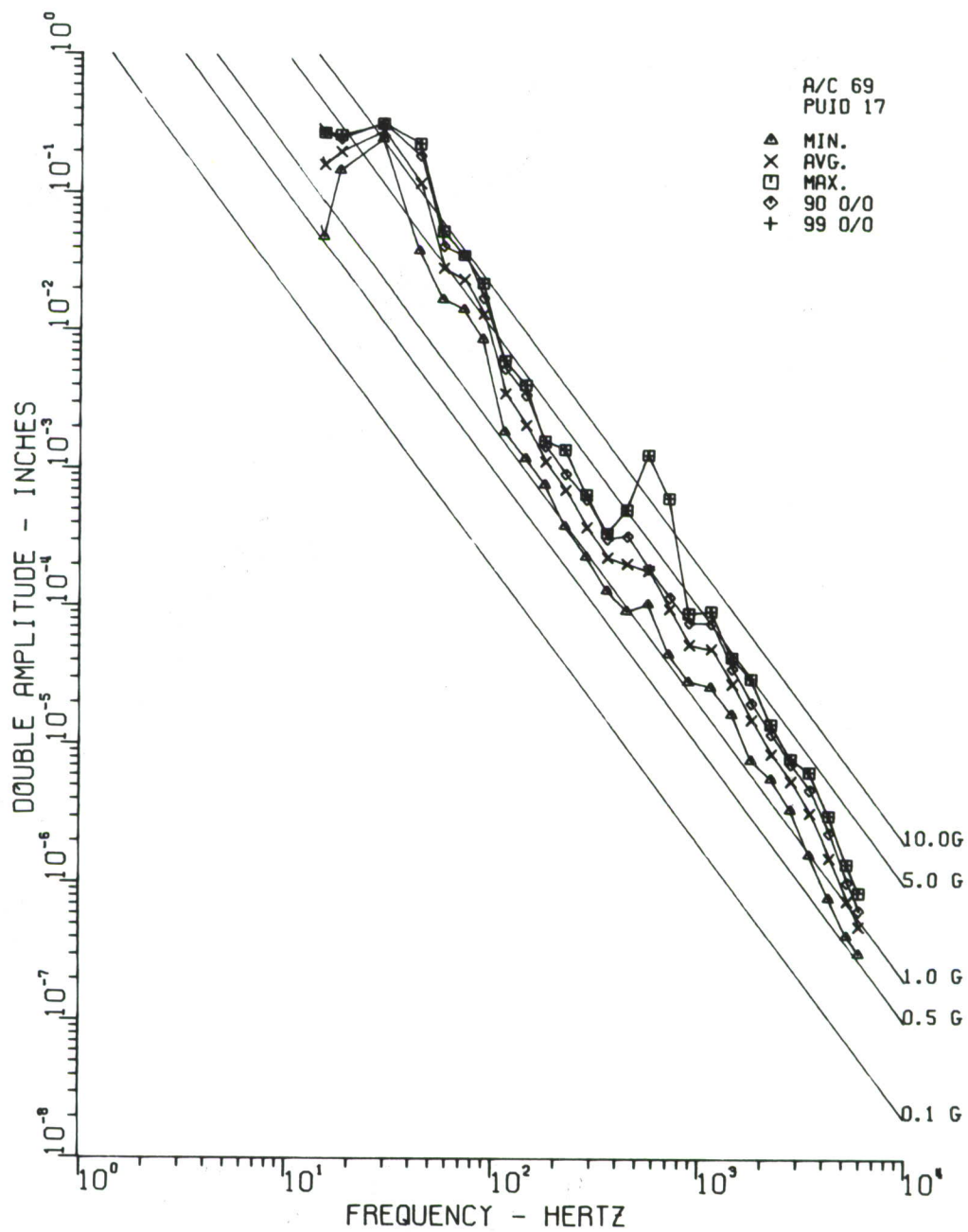

Figure 69. Vertical, Lateral and Fore and Aft, Electronics Comp., Left Side, AN/ARC-54, Sta. 62, with Gunfire

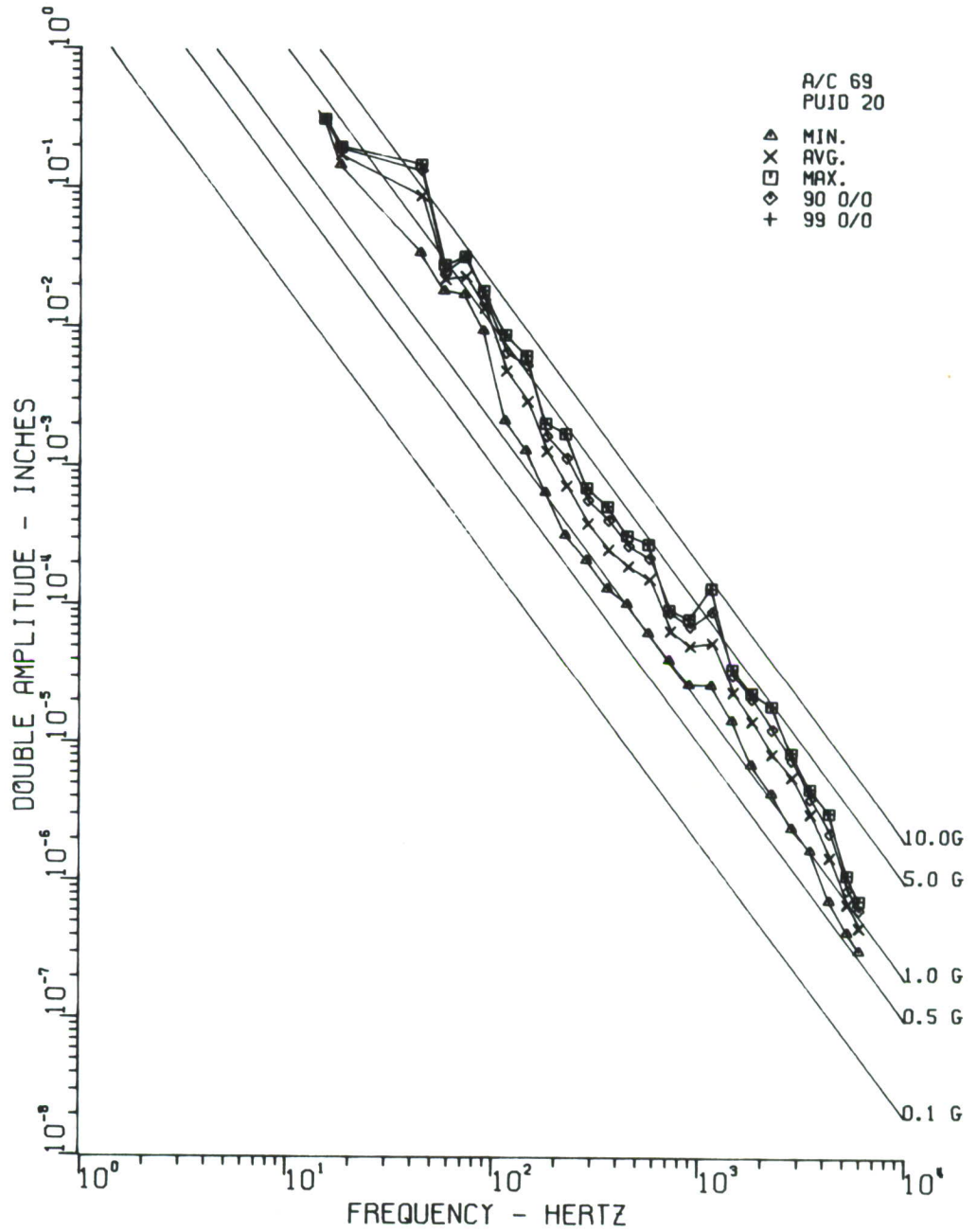

Figure 70. Vertical, Lateral, and Fore and Aft, Electronics Comp., Left Side, AN/ARC-54, Sta. 58, with Gunfire

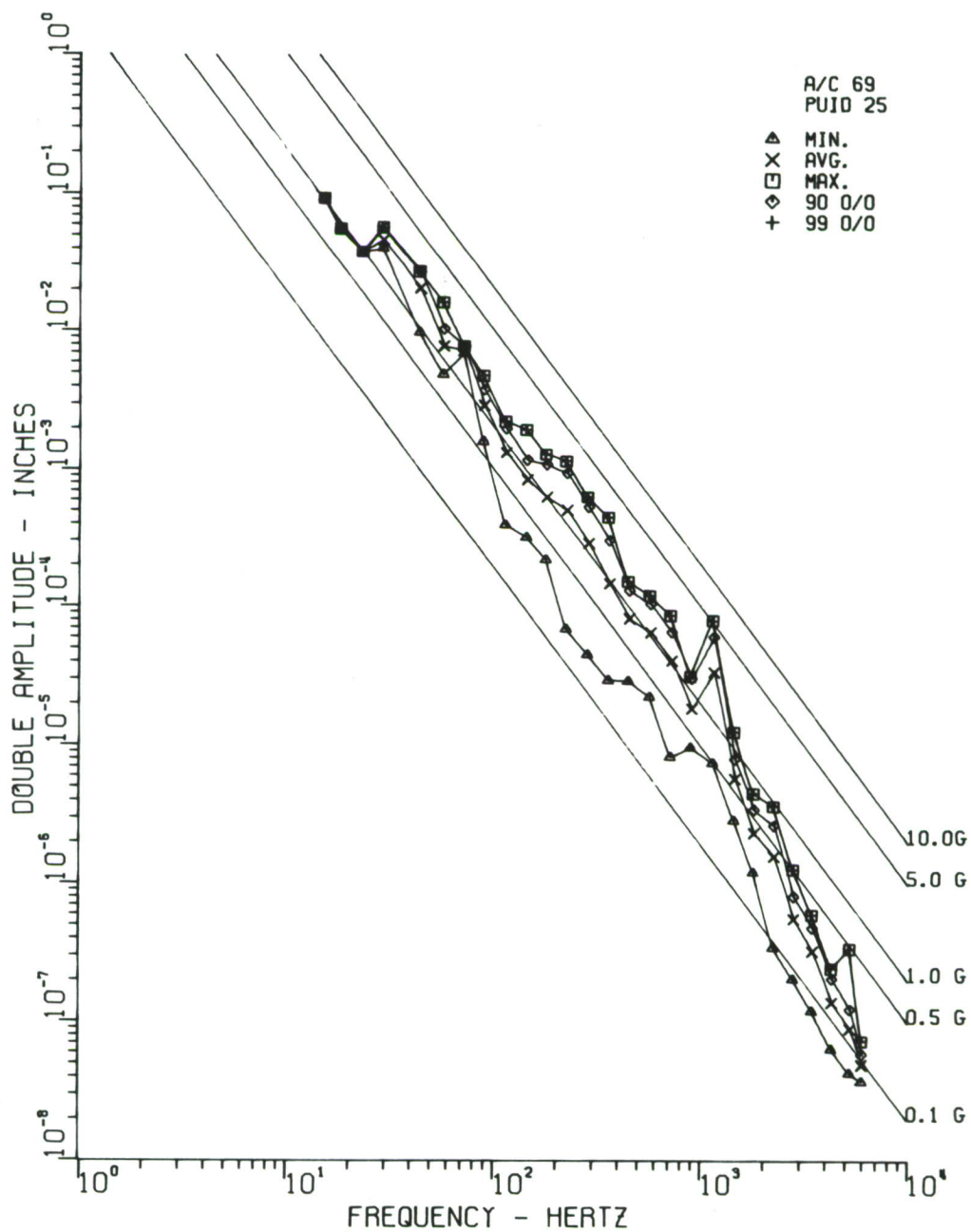

Figure 71. Vertical, Lateral, and Fore and Aft, Tail Section, Center, Sta., 220, with Gunfire

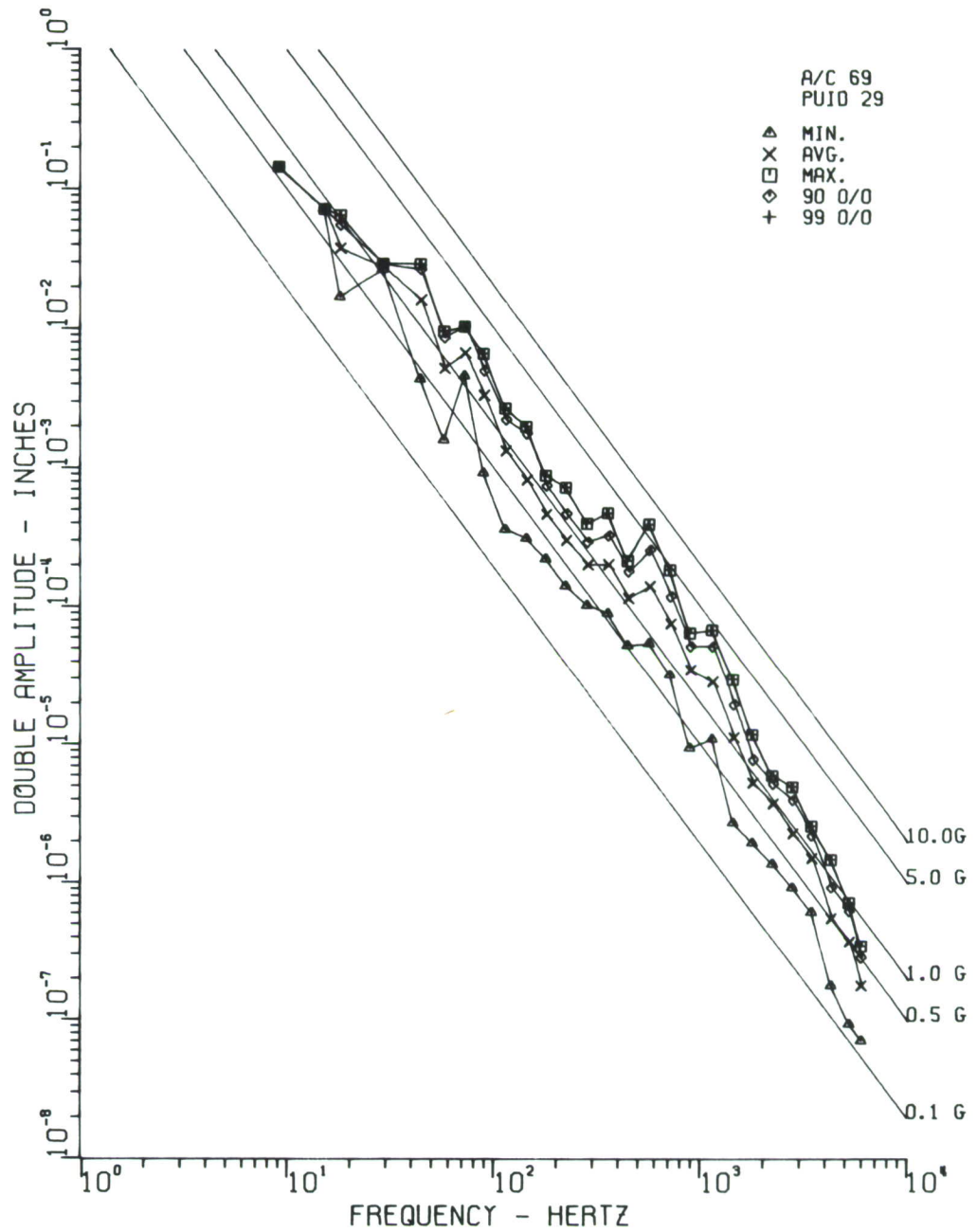

Figure 72. Vertical, Lateral, and Fore and Aft, Electronics Comp., Right Side, AN/ARC-51, Sta. 62, with Gunfire

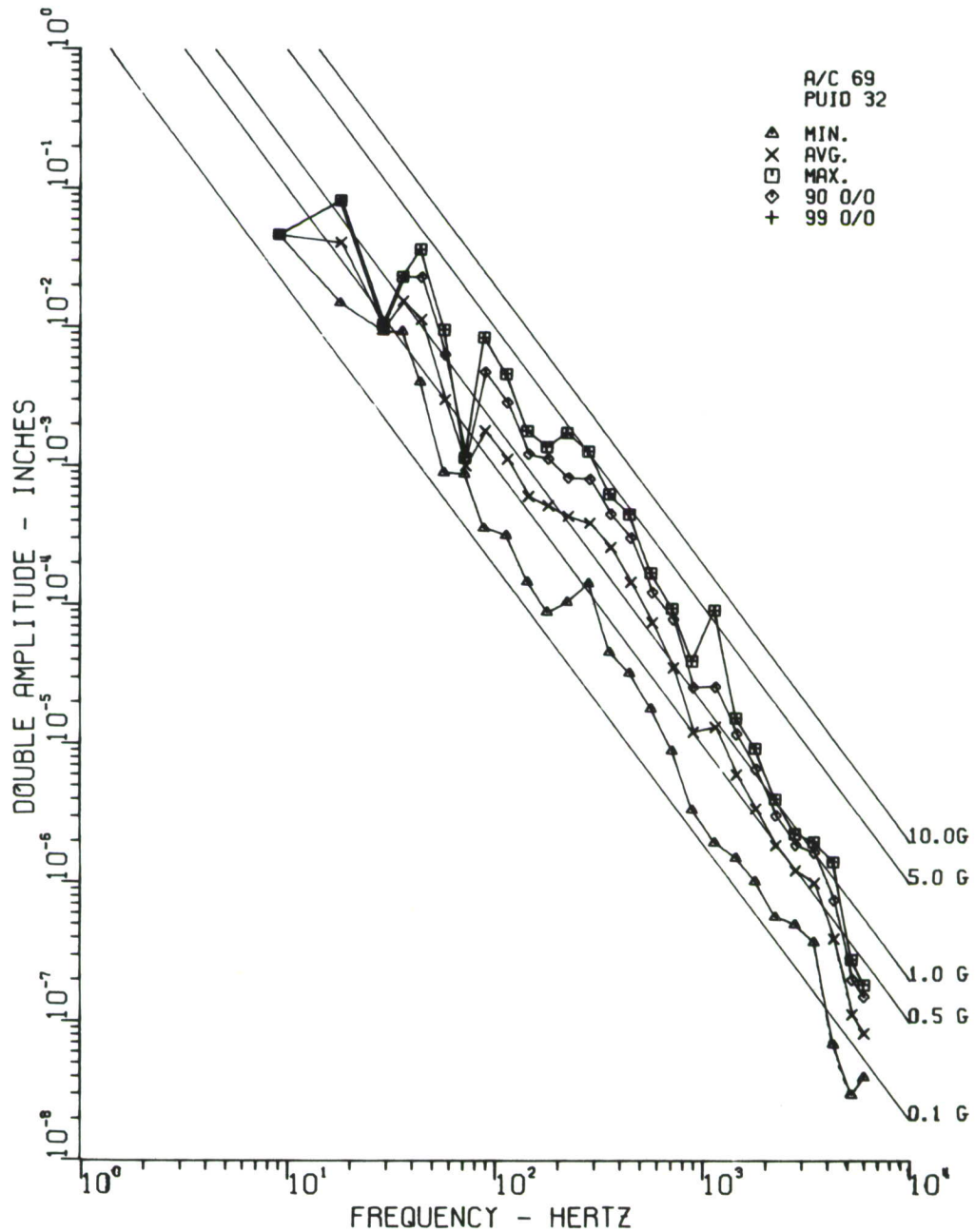

Figure 73. Vertical, Lateral, and Fore and Aft, Electronics Comp., Right Side, AN/ARC-51, Sta. 55, with Gunfire

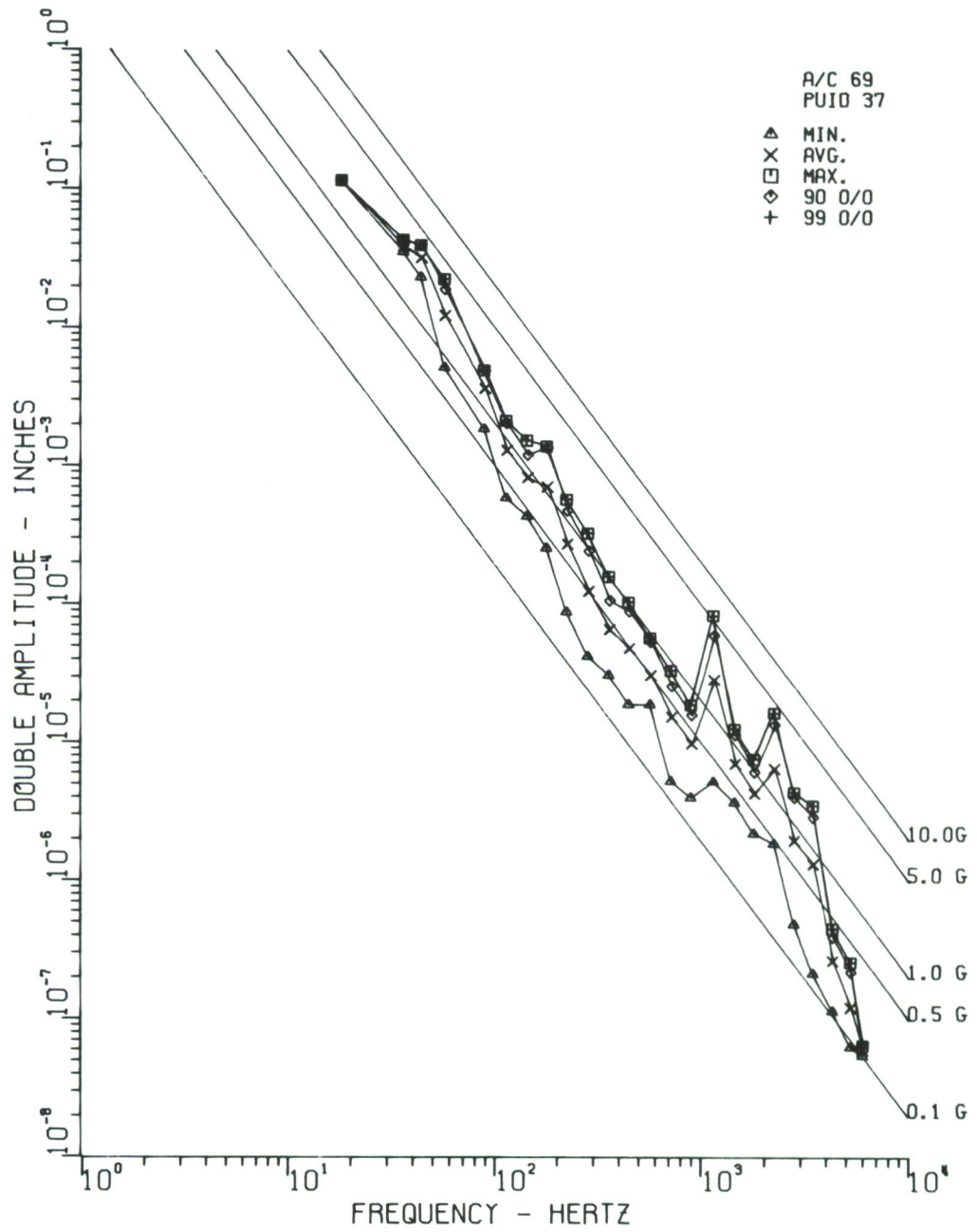

Figure 74. Vertical, Lateral, and Fore and Aft, Tail Section Near 90° Gear Box, Sta. 273, with Gunfire

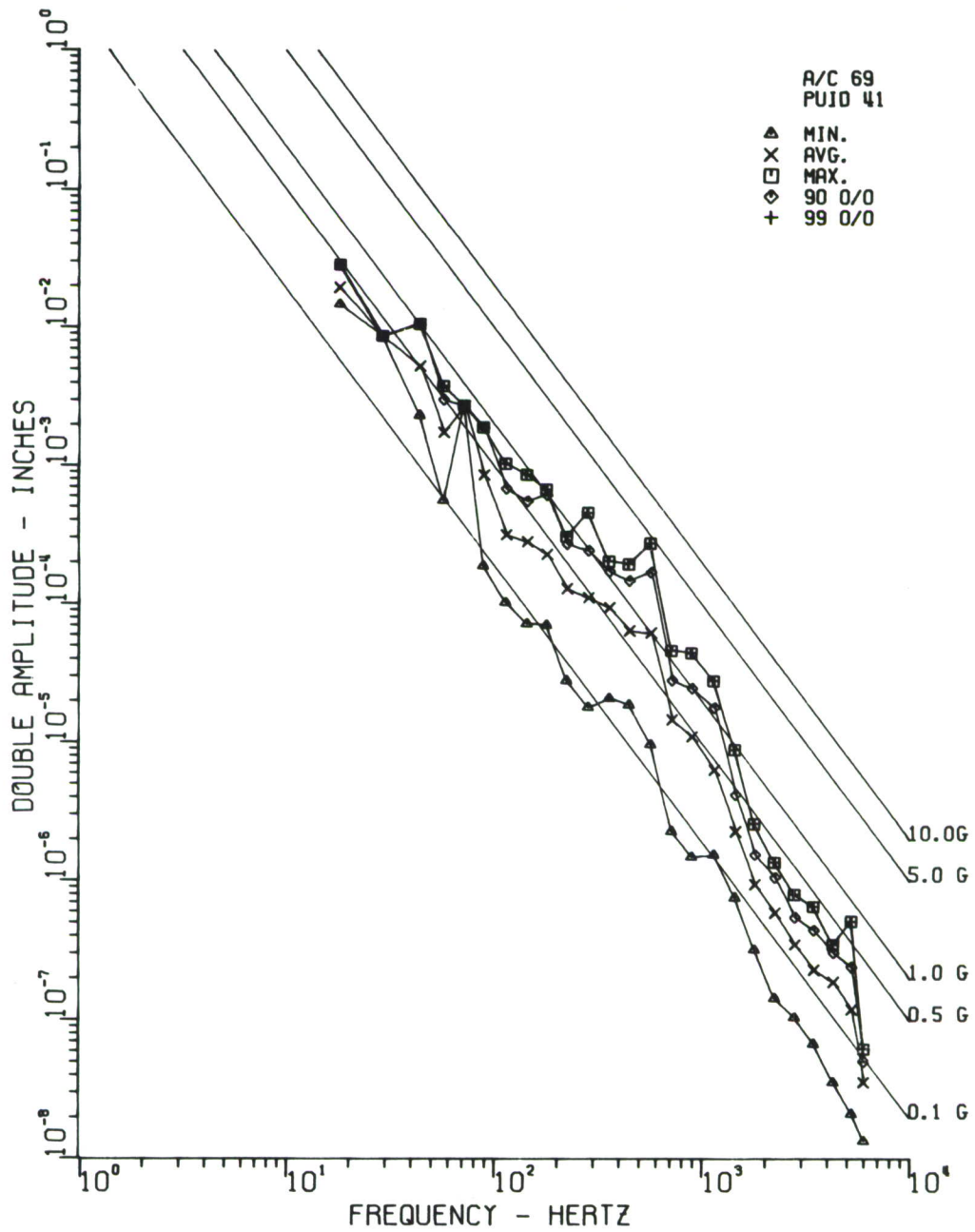

Figure 75. Vertical, Lateral, and Fore and Aft, Cabin Floor, Left Side, Sta. 110, with Gunfire

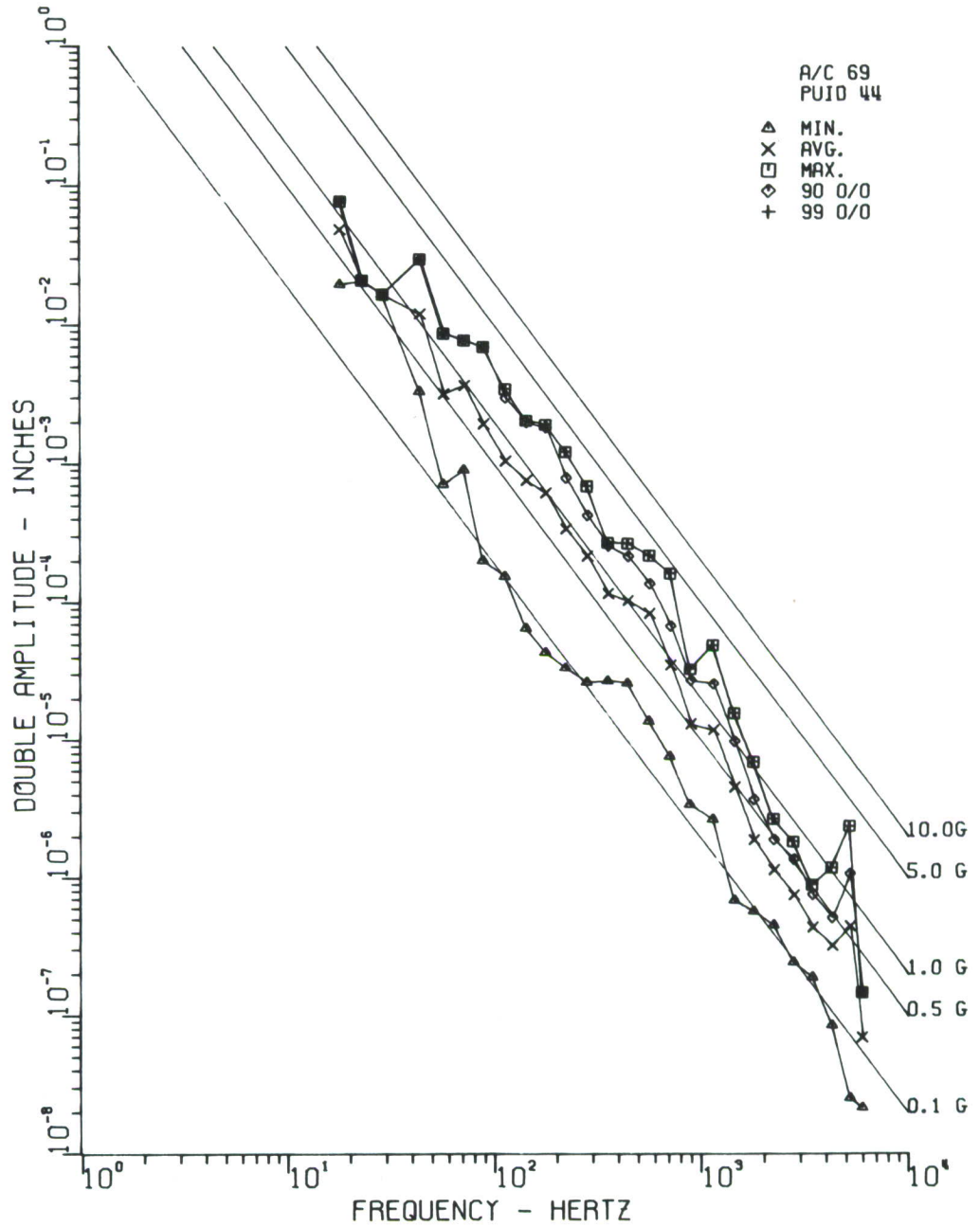

Figure 76. Vertical, Lateral, and Fore and Aft, Cabin Floor, Right Side, Sta. 110, with Gunfire

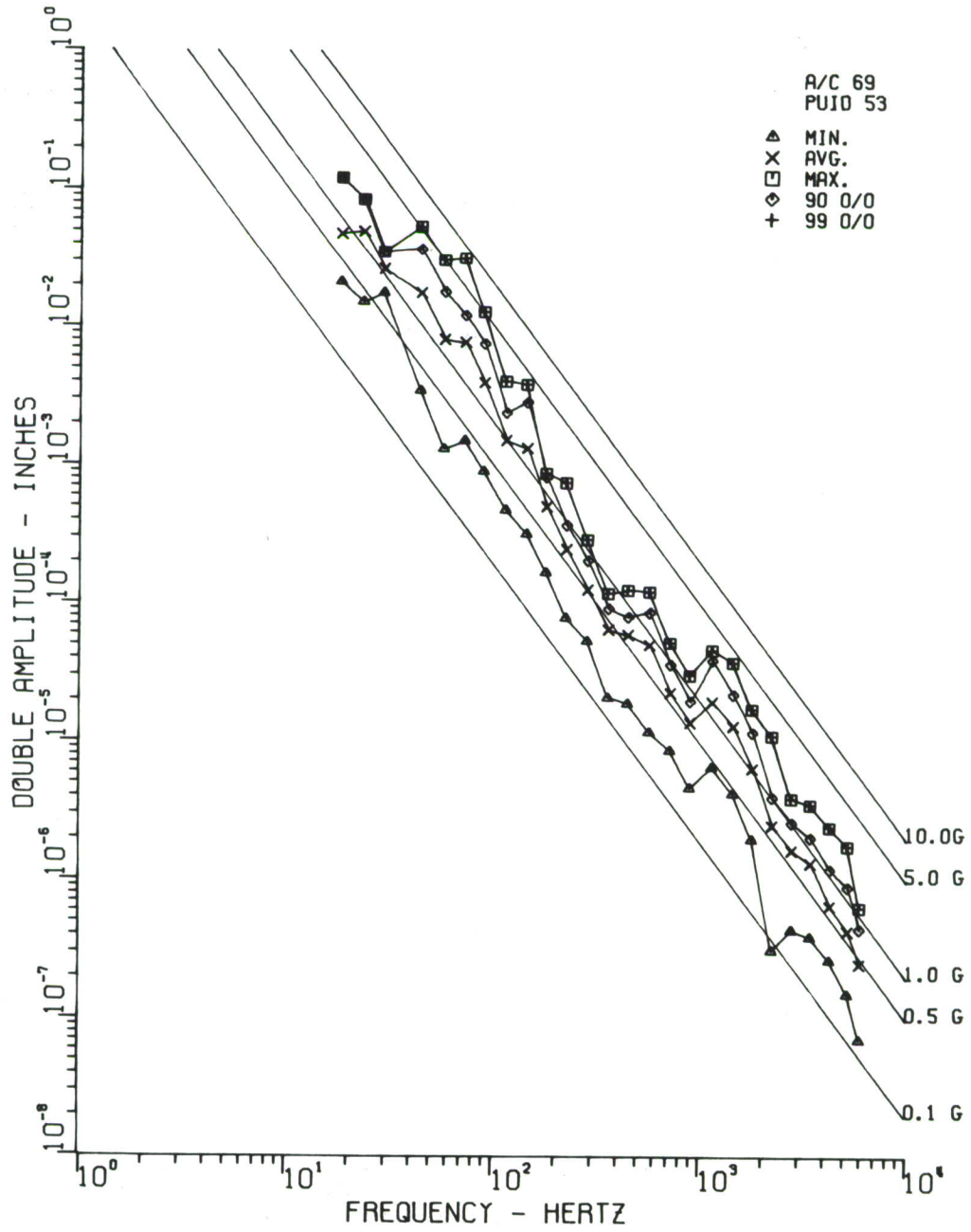

Figure 77. Vertical, Lateral, and Fore and Aft, XM-27 Armament Mount, Sta. 92, with Gunfire

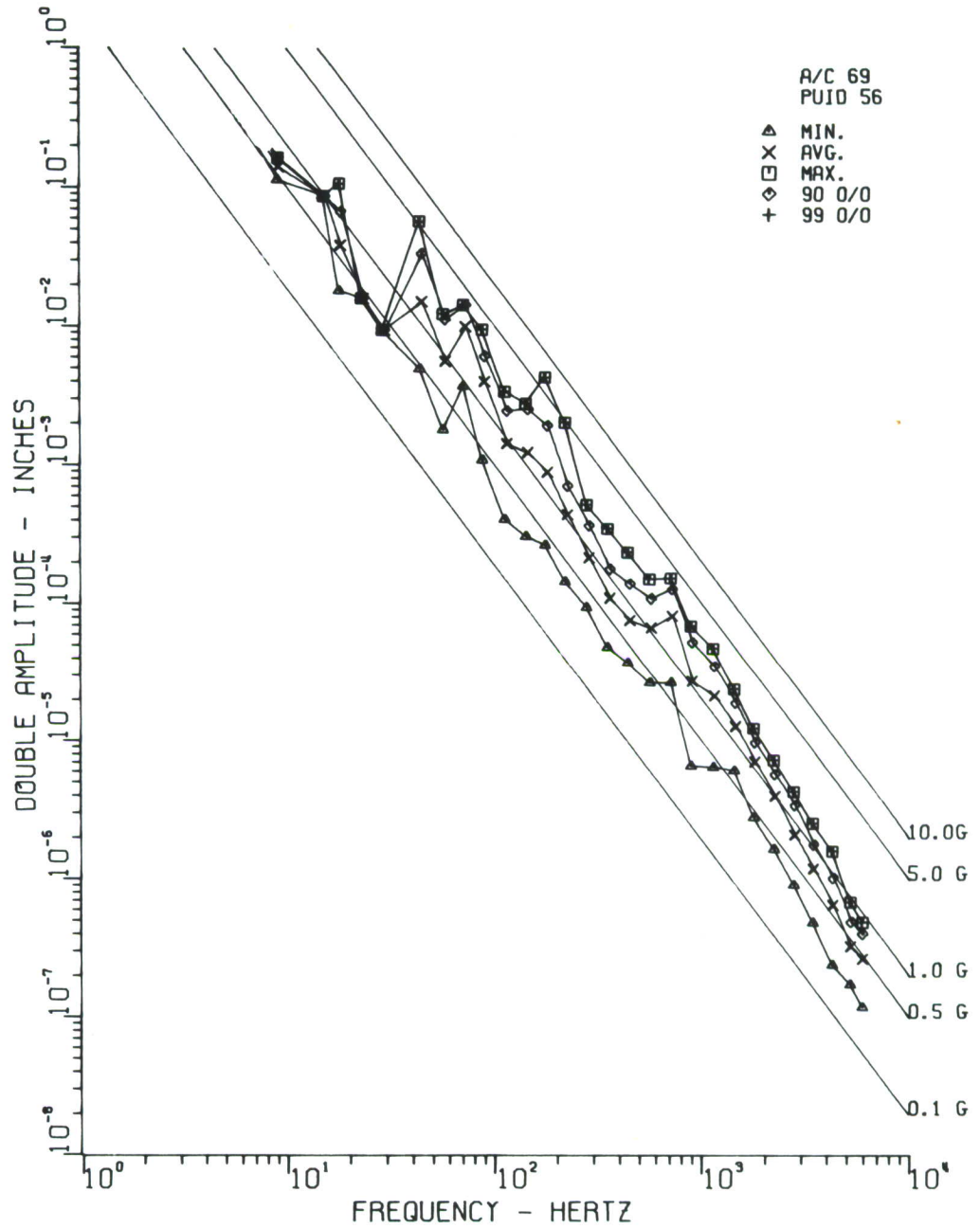

Figure 78. Vertical, Lateral, and Fore and Aft, Directional Gyro Shelf, Left Side, Sta. 70, with Gunfire

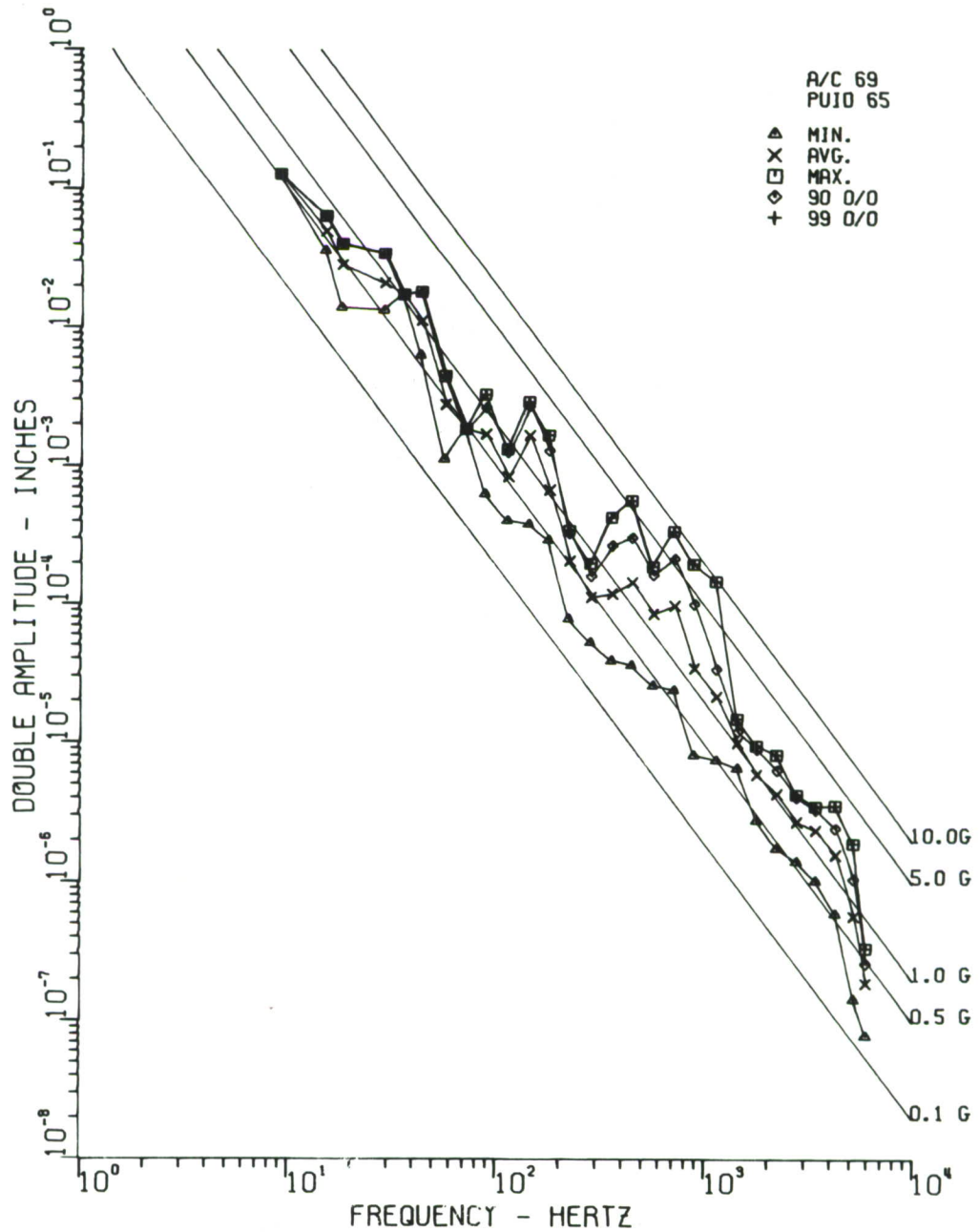

Figure 79. Vertical, Lateral, and Fore and Aft, ADF Antenna Interface, Sta. 69, with Gunfire

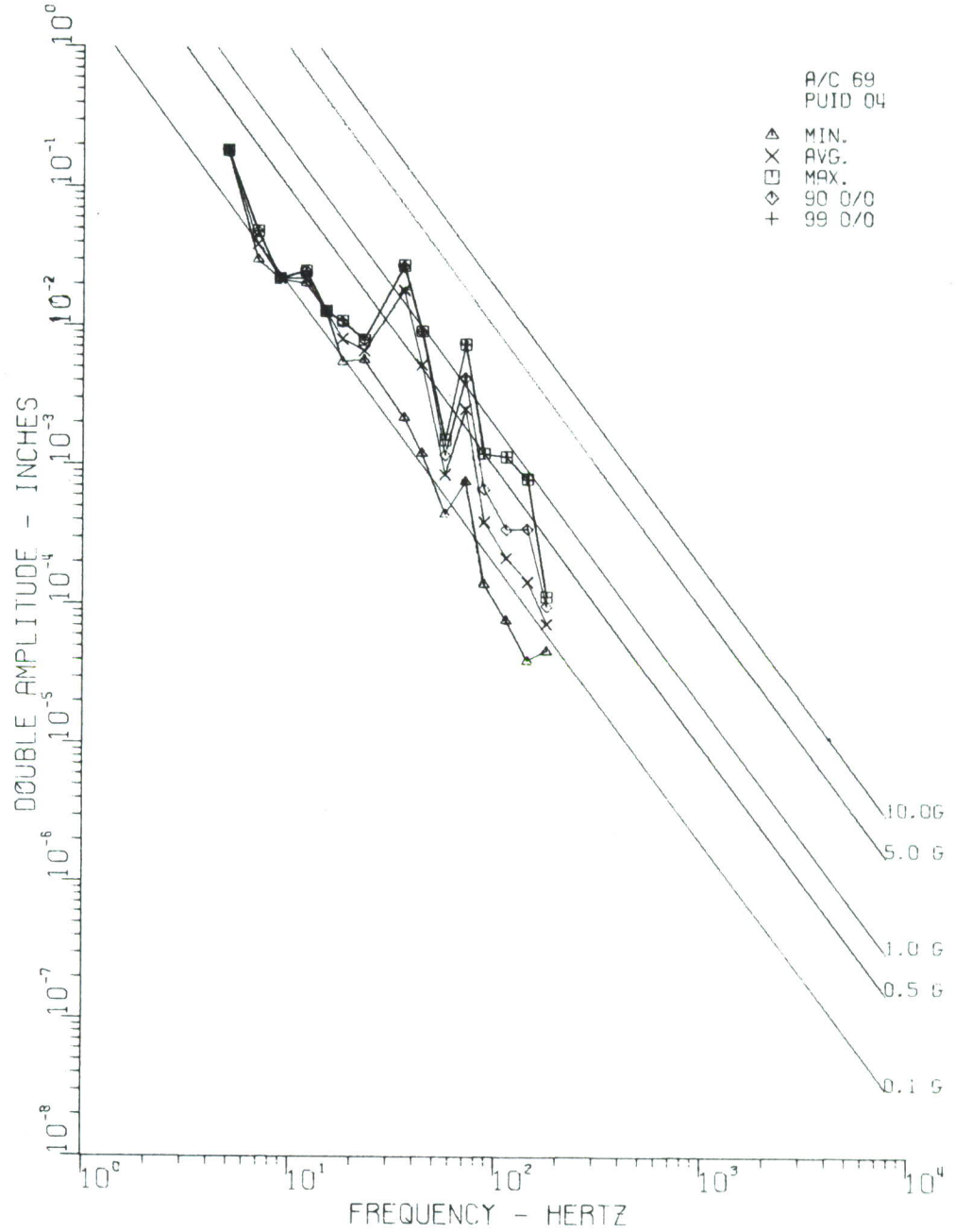

Figure 80. Vertical, Lateral, and Fore and Aft, Instrument Panel, Left Side, Sta. 43, with Gunfire

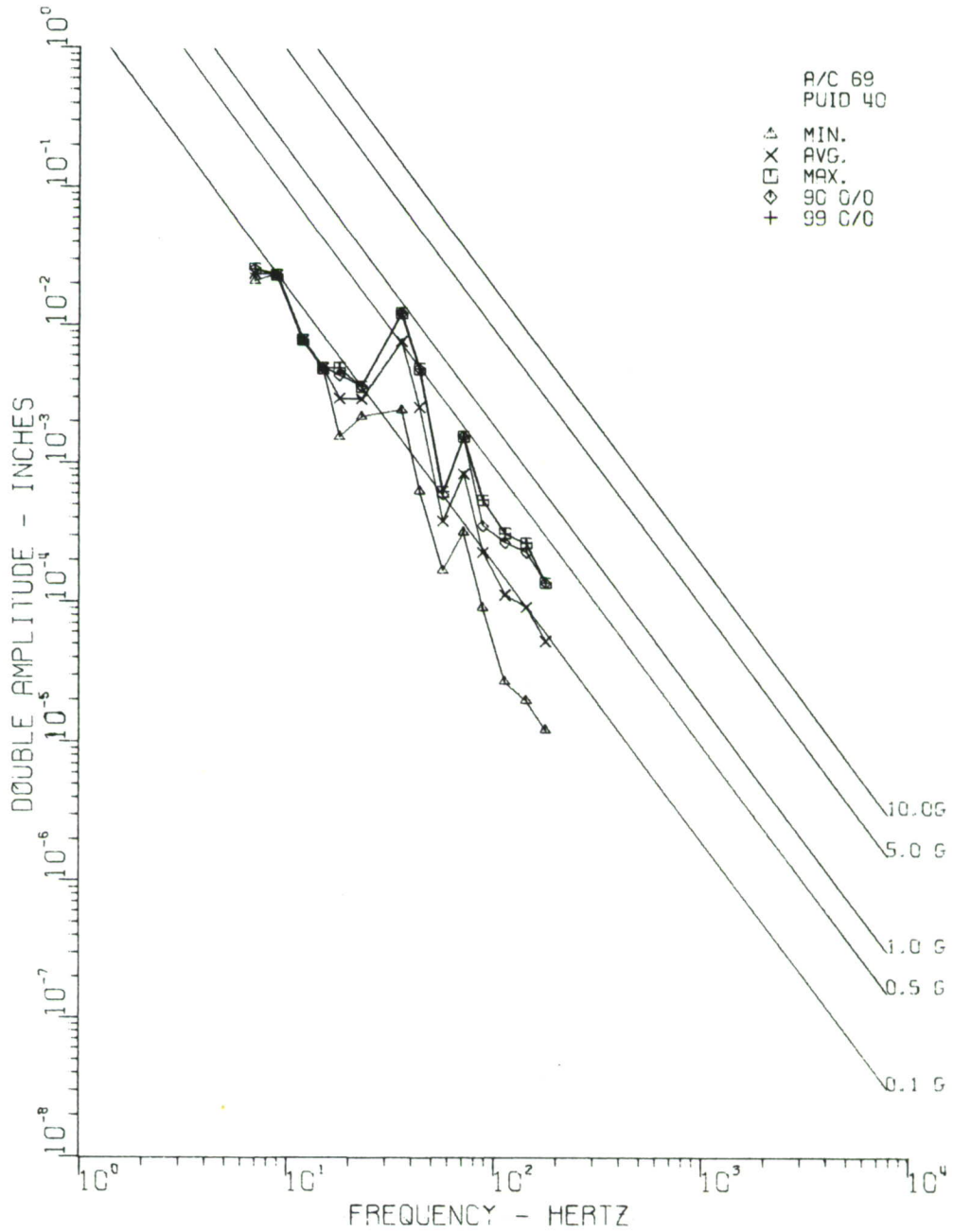

Figure 81. Vertical and Lateral, Instrument Panel Base, Left Side, Sta. 39, with Gunfire

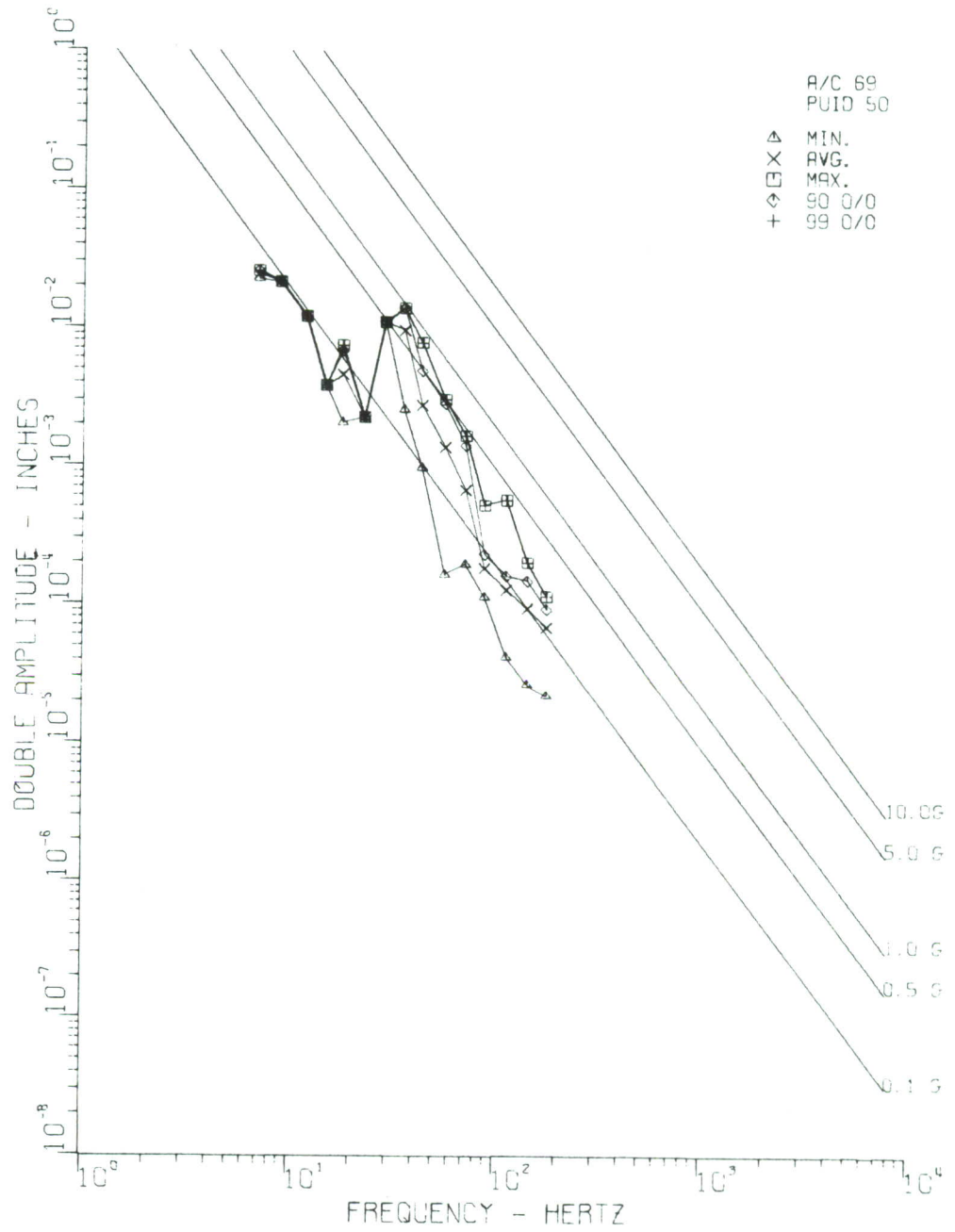

Figure 82. Vertical and Lateral, Cabin Floor, Right Side, Sta. 90, with Gunfire

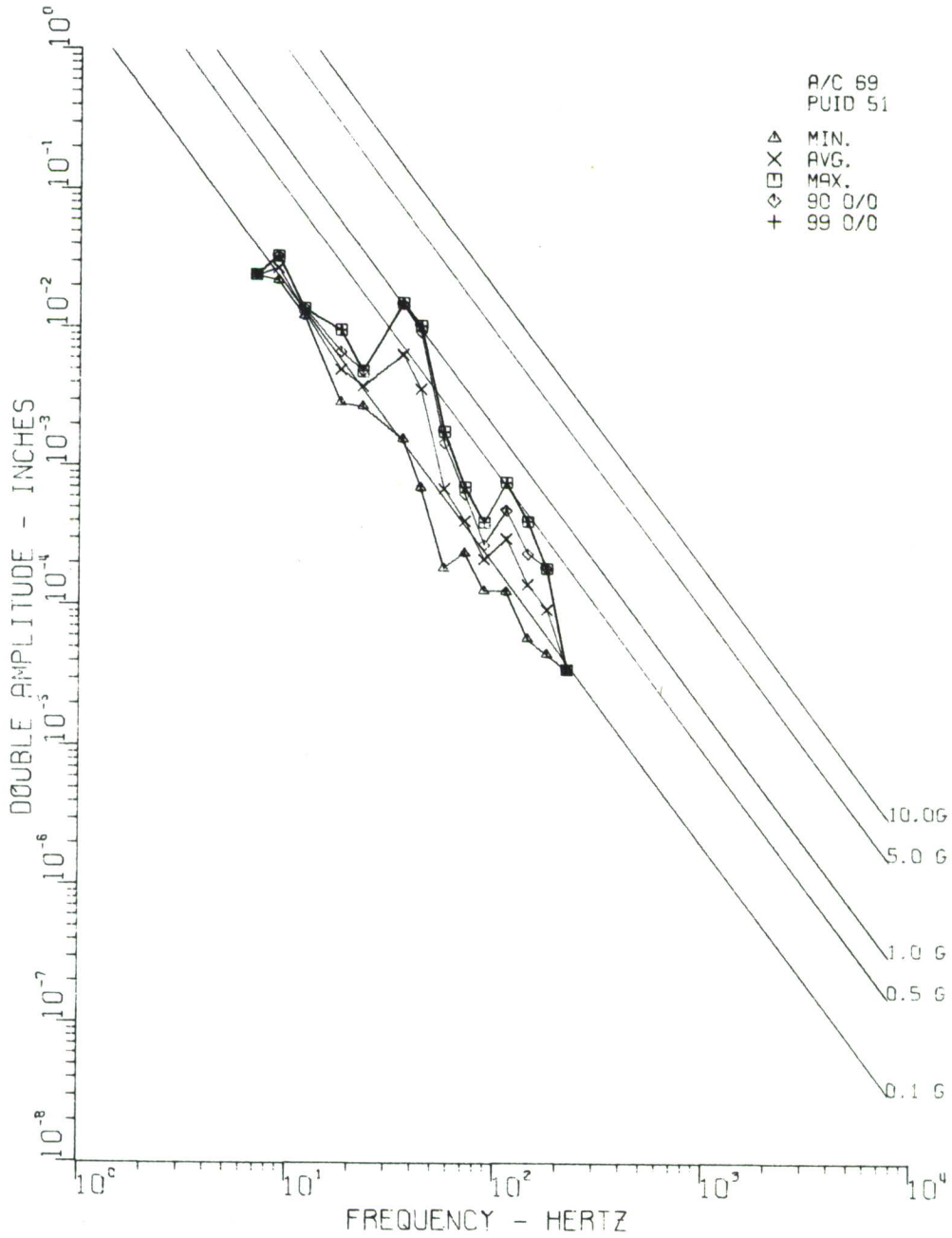

Figure 83. Vertical and Lateral, Fuselage-Tail Section Interface, Sta. 130, with Gunfire

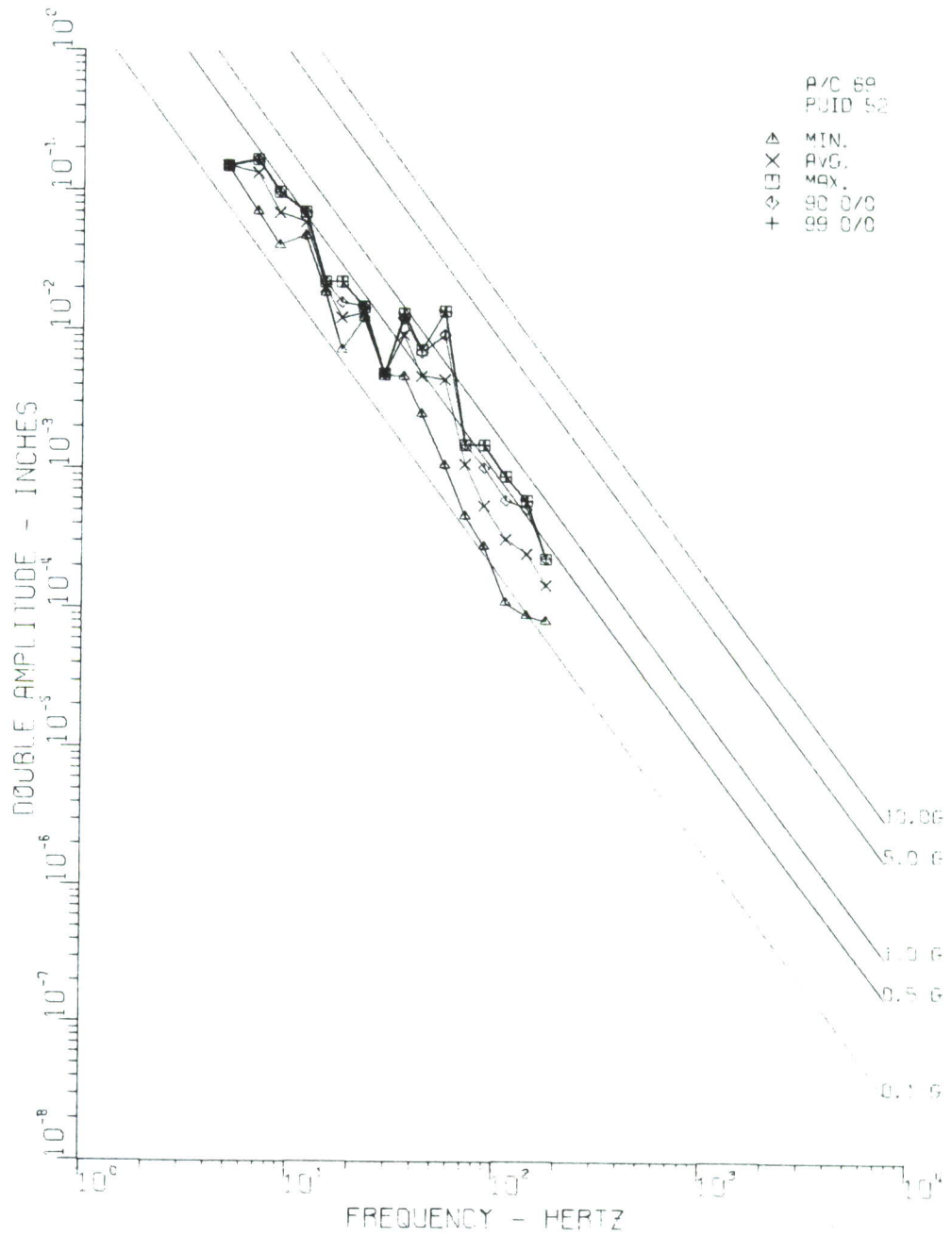

Figure 84. Vertical and Lateral, Tail Section Near 90° Gear Box, Sta. 273, with Gunfire

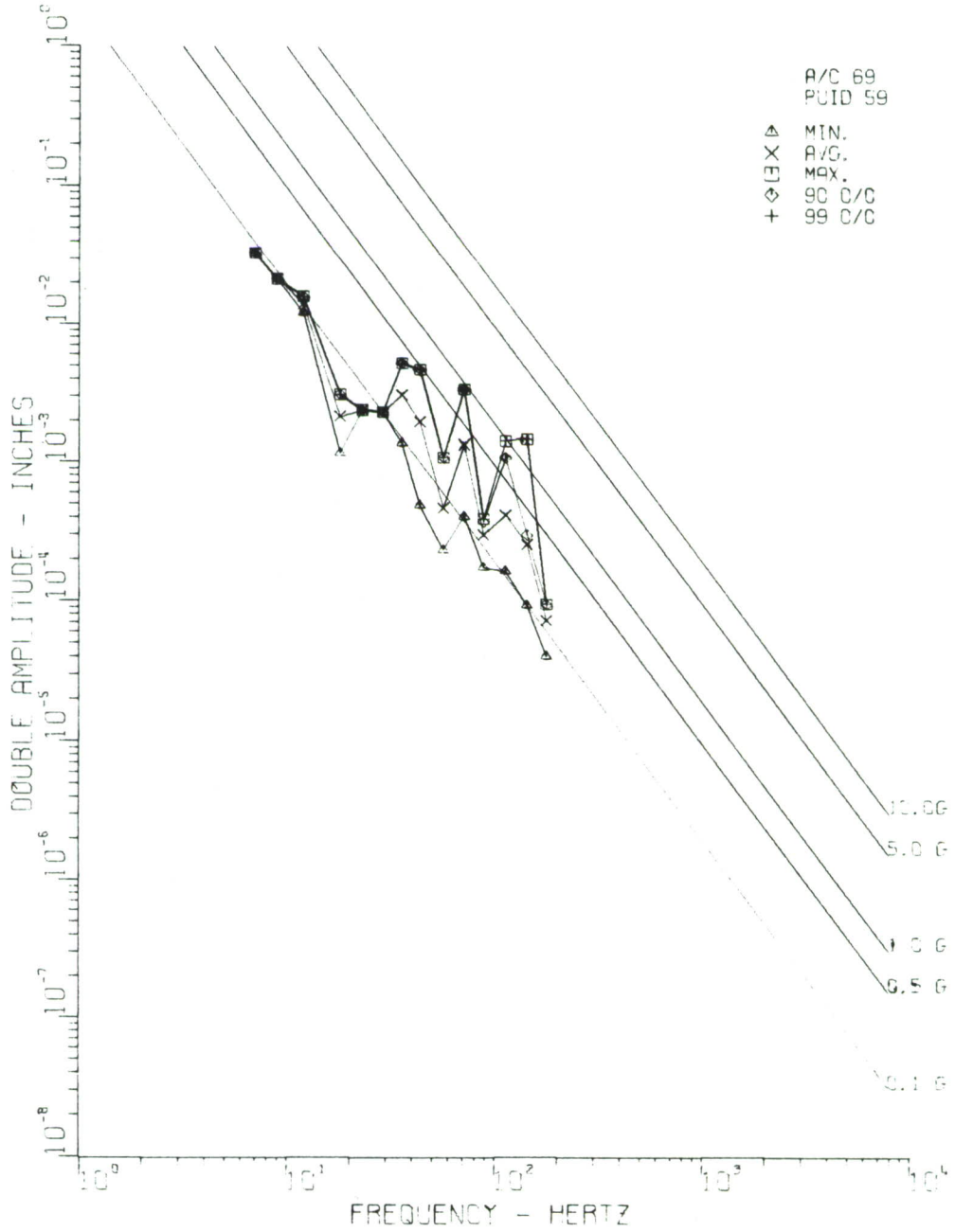

Figure 85. Vertical, Cabin Floor, Left Side, Sta. 90, with Gunfire

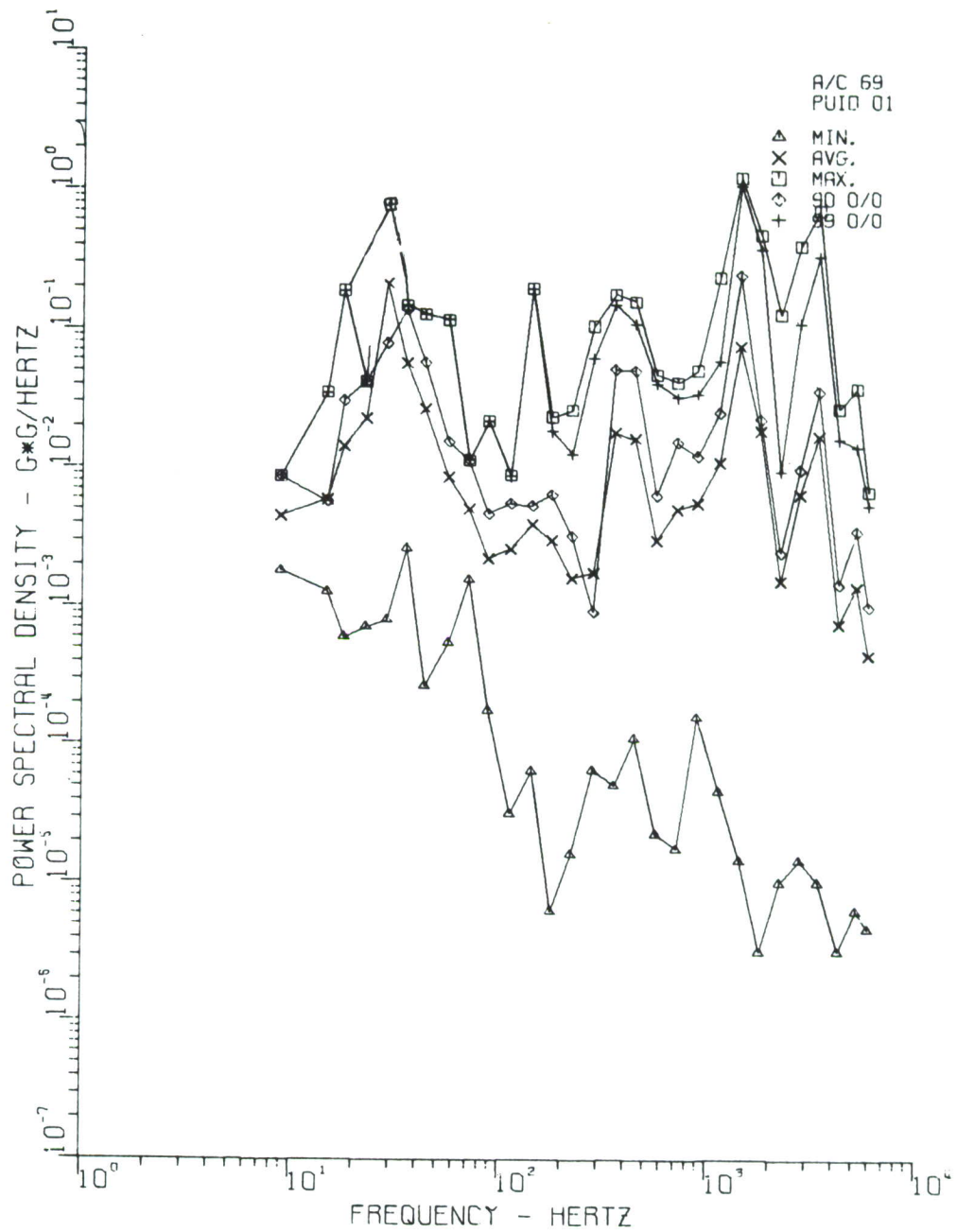

Figure 86. Vertical, Lateral, and Fore and Aft, Main Rotor Transmission Interface, Right Rear Support, Sta. 108, without Gunfire

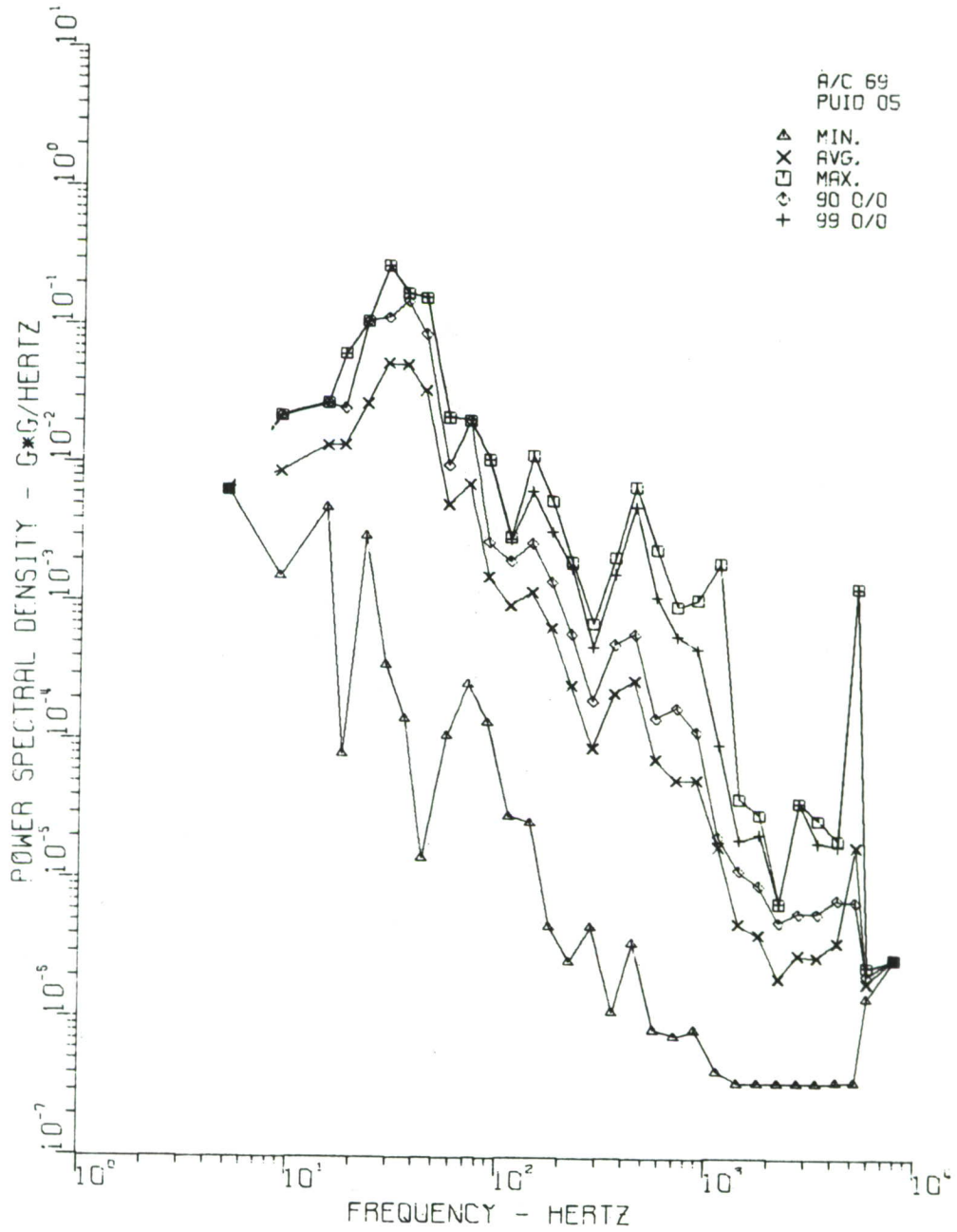

Figure 87. Vertical, Lateral, and Fore and Aft, Instrument Panel, Right Side, Sta. 44, without Gunfire

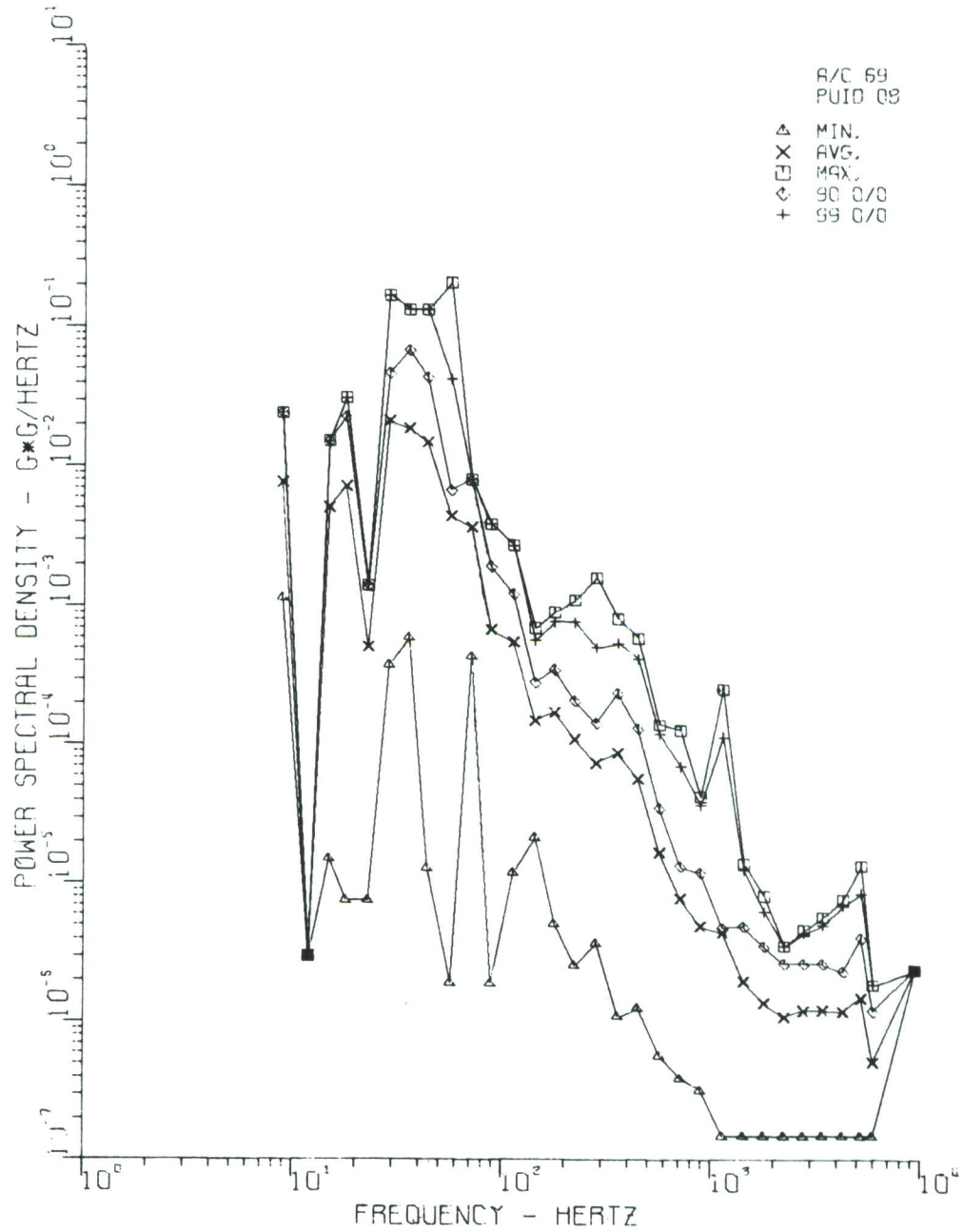

Figure 88. Vertical, Lateral, and Fore and Aft, Instrument Pedestal, Center, Sta. 56, without Gunfire

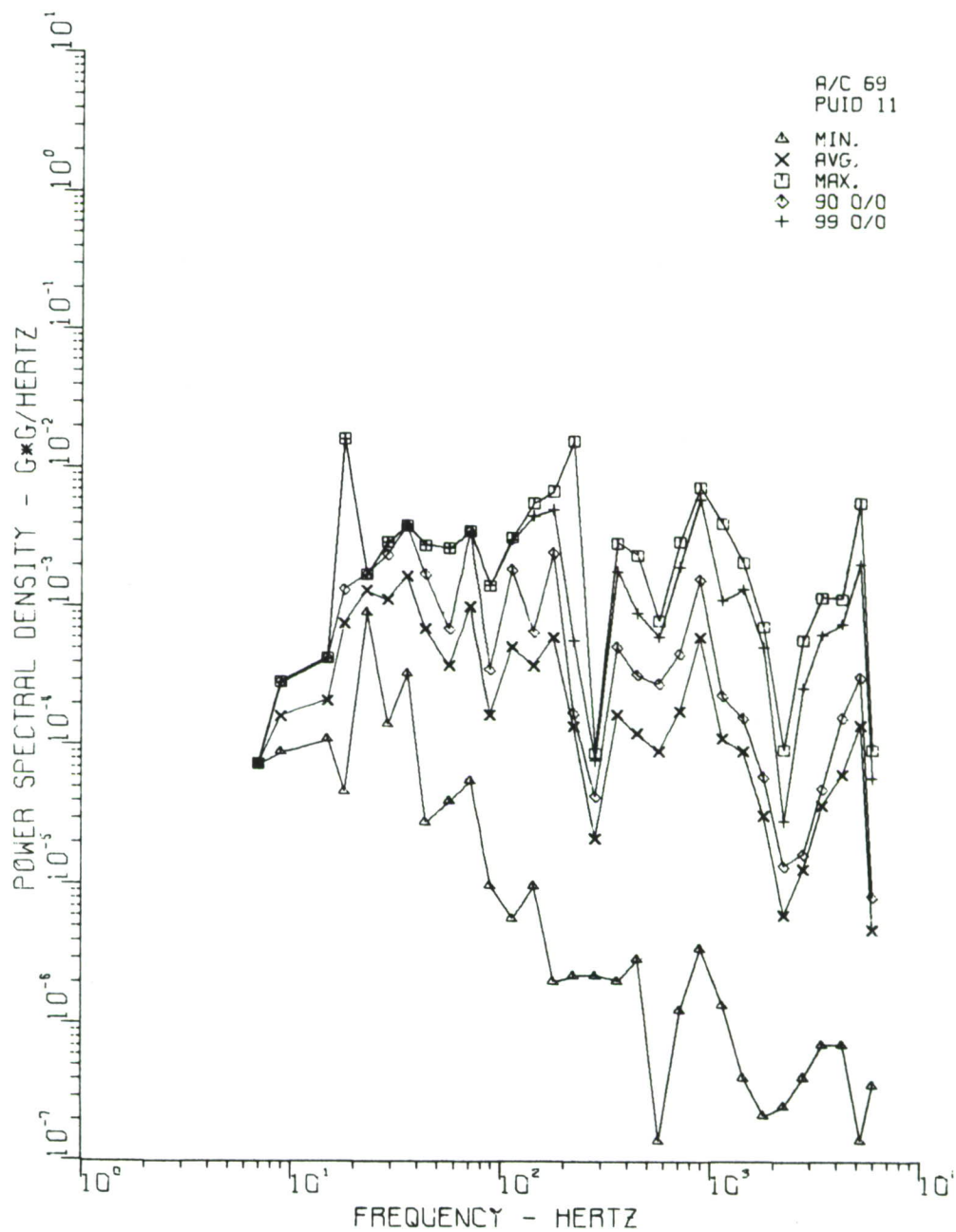

Figure 89. Vertical, Lateral, and Fore and Aft, Cabin Floor, Center, Sta. 88, without Gunfire

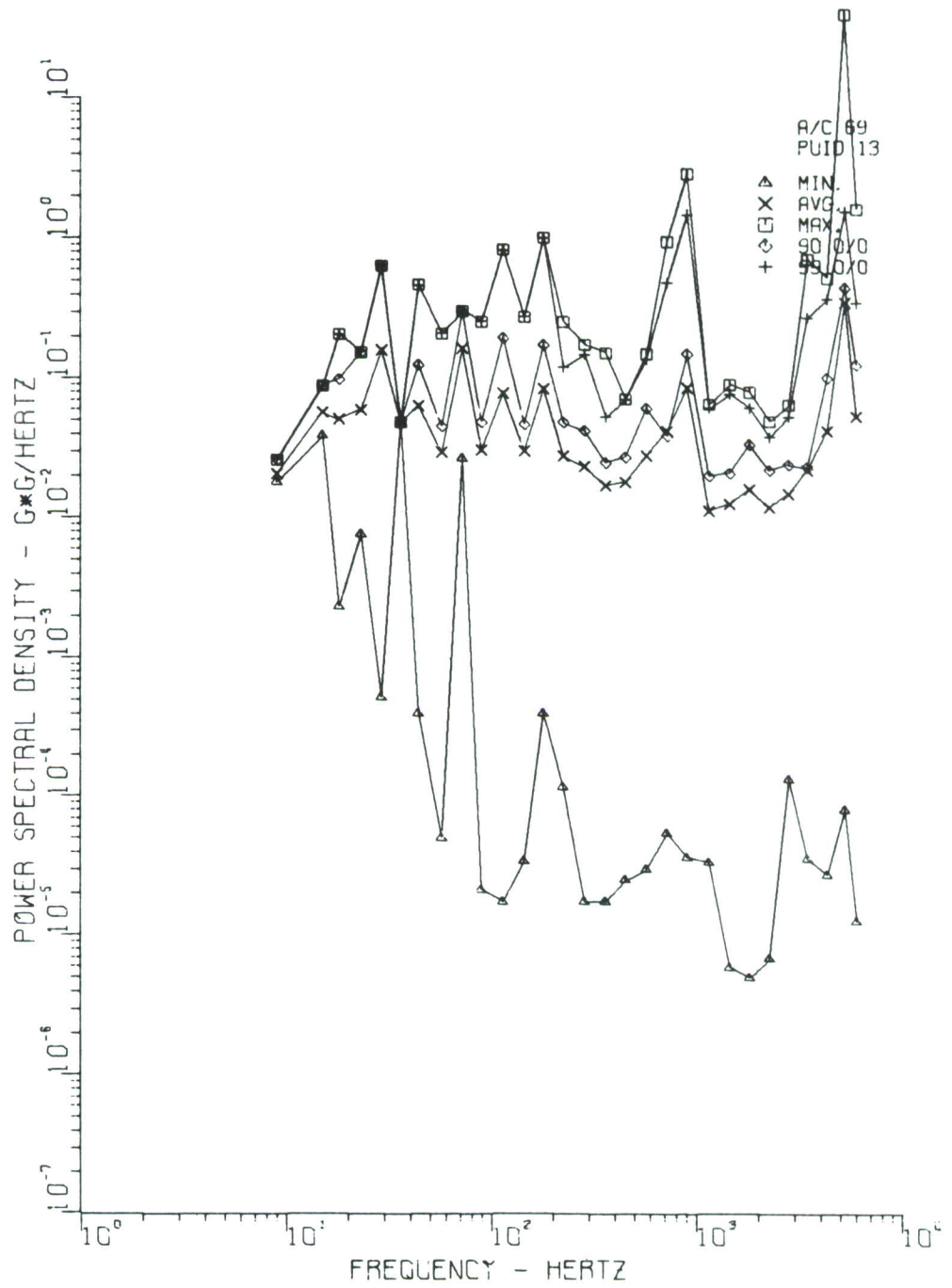

Figure 90. Vertical, Lateral, and Fore and Aft, Left Engine Mount Interface, Sta. 121, without Gunfire

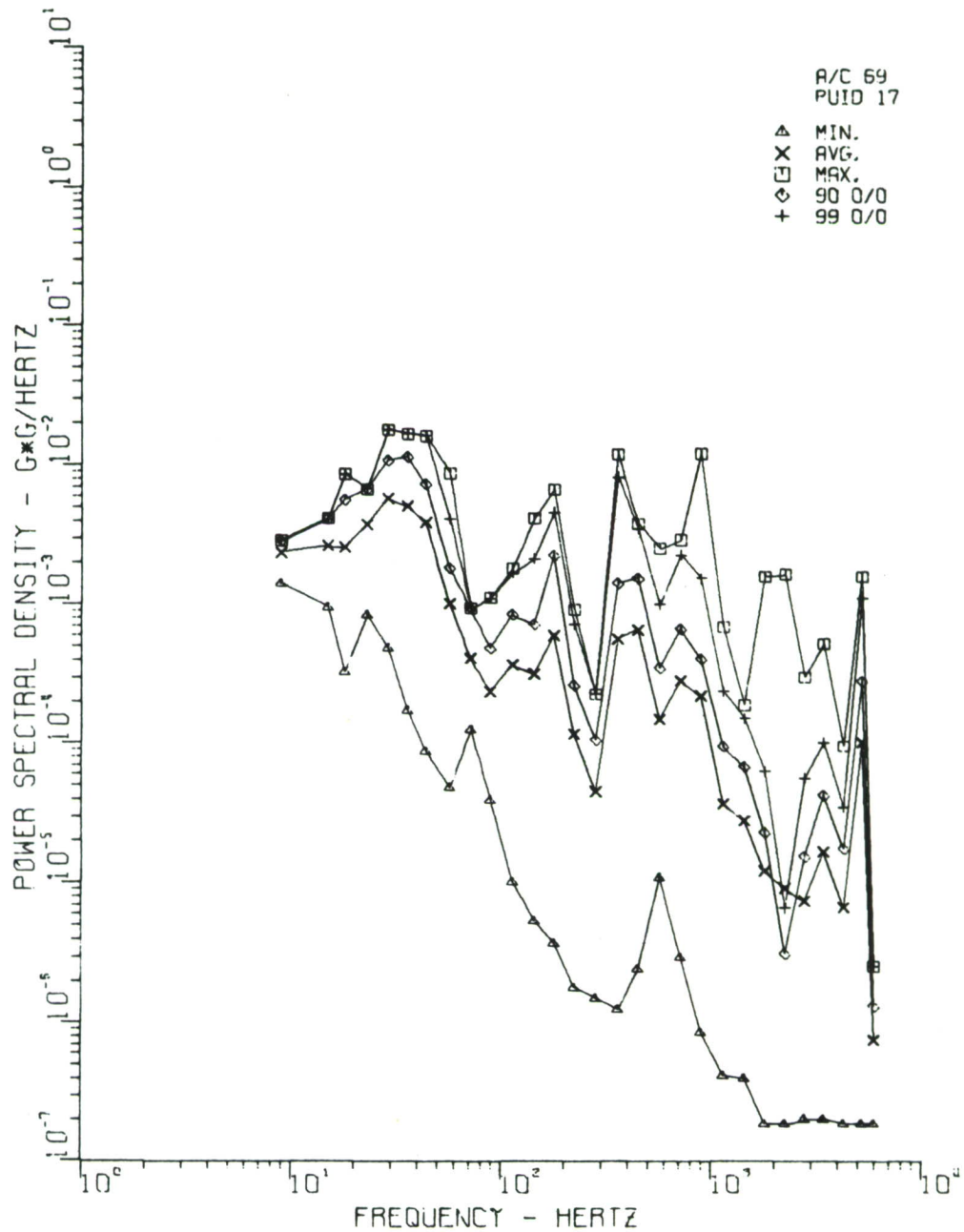

Figure 91. Vertical, Lateral, and Fore and Aft, Electronics Comp., Left Side, AN/ARC-54, Sta. 62, without Gunfire

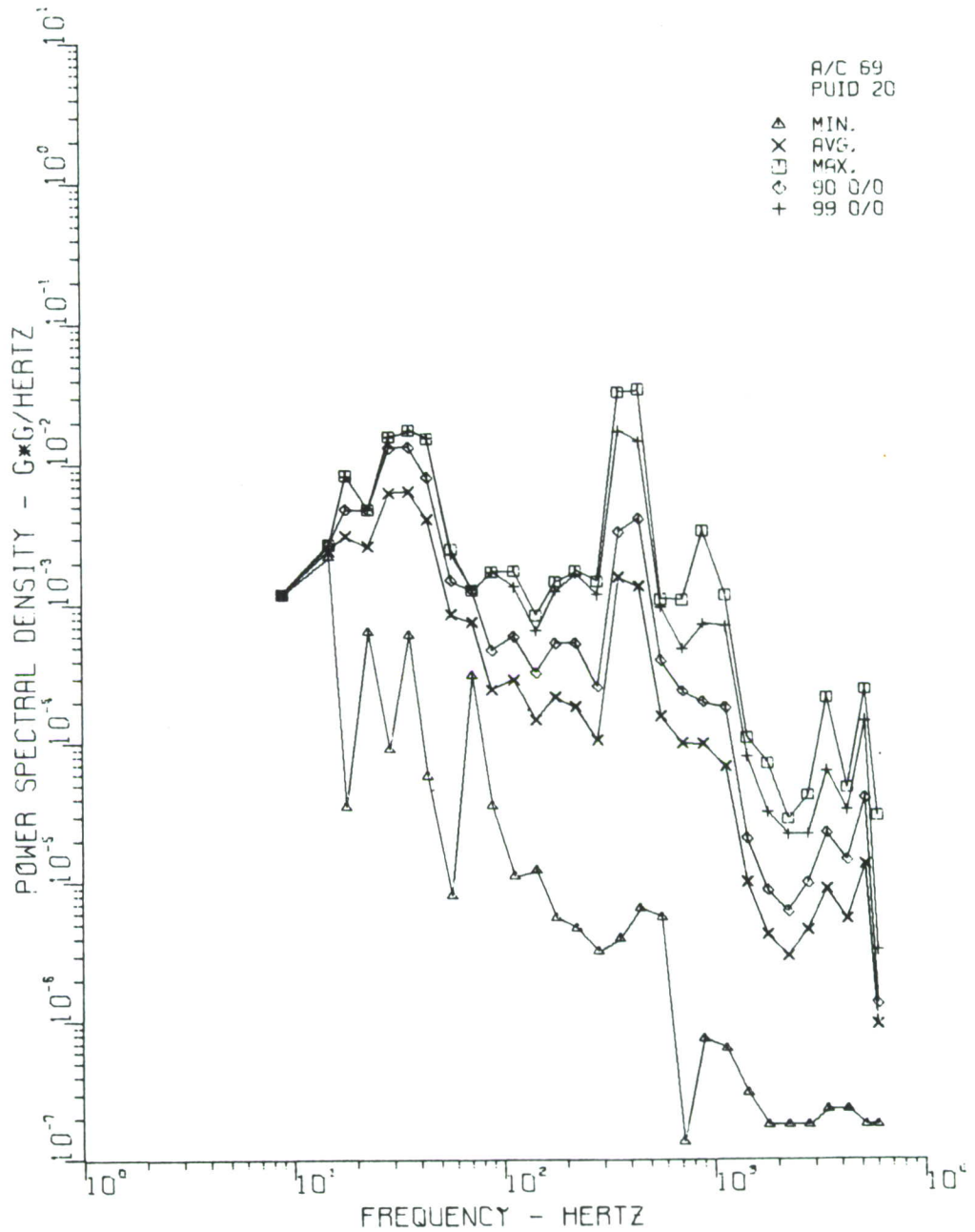

Figure 92. Vertical, Lateral, and Fore and Aft, Electronics Comp., Left Side, AN/ARC-54, Sta. 58, without Gunfire

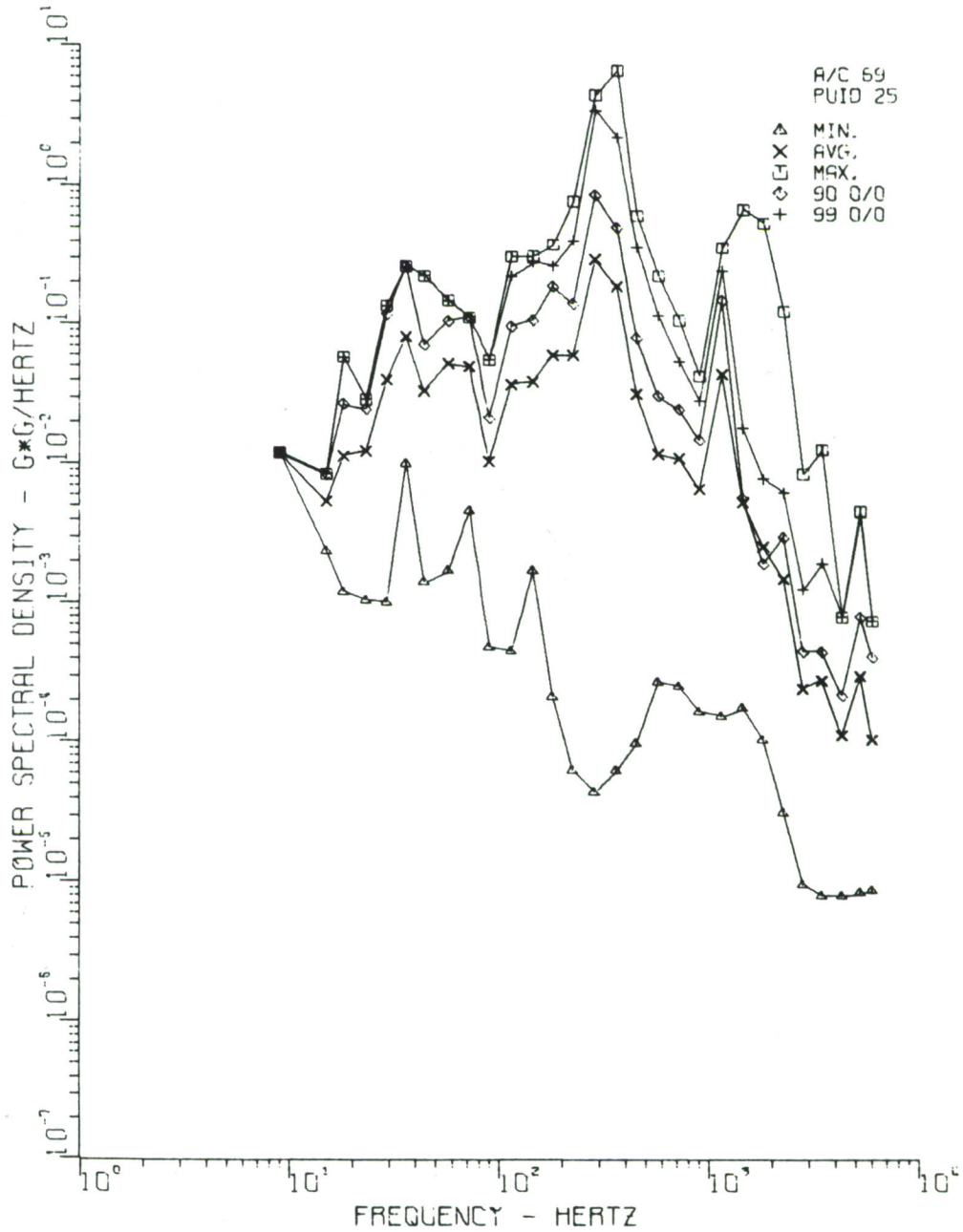

Figure 93. Vertical, Lateral, and Fore and Aft, Tail Section, Center, Sta. 220, without Gunfire

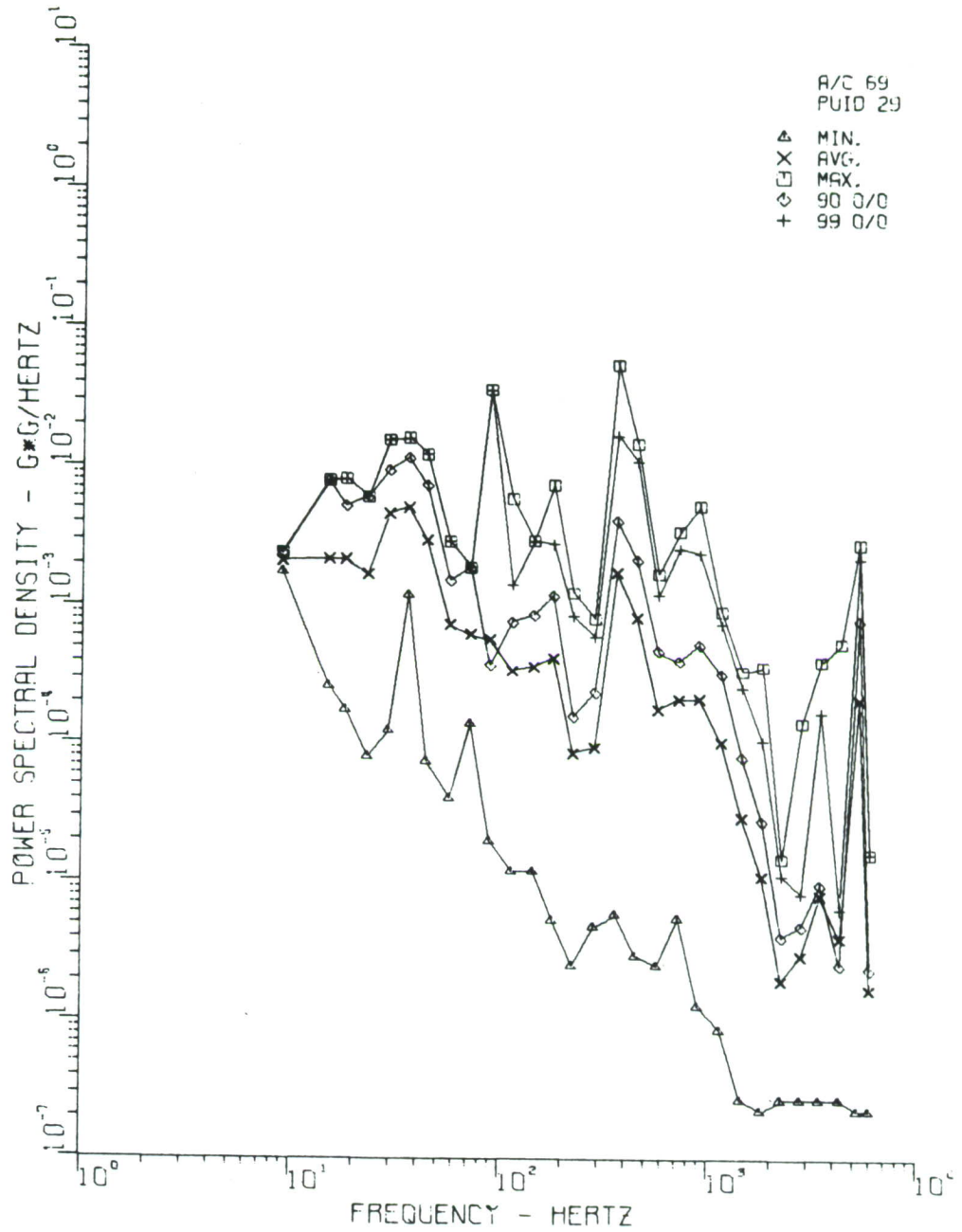

Figure 94. Vertical, Lateral, and Fore and Aft, Electronics Comp., Right Side, AN/ARC-51, Sta. 62, without Gunfire

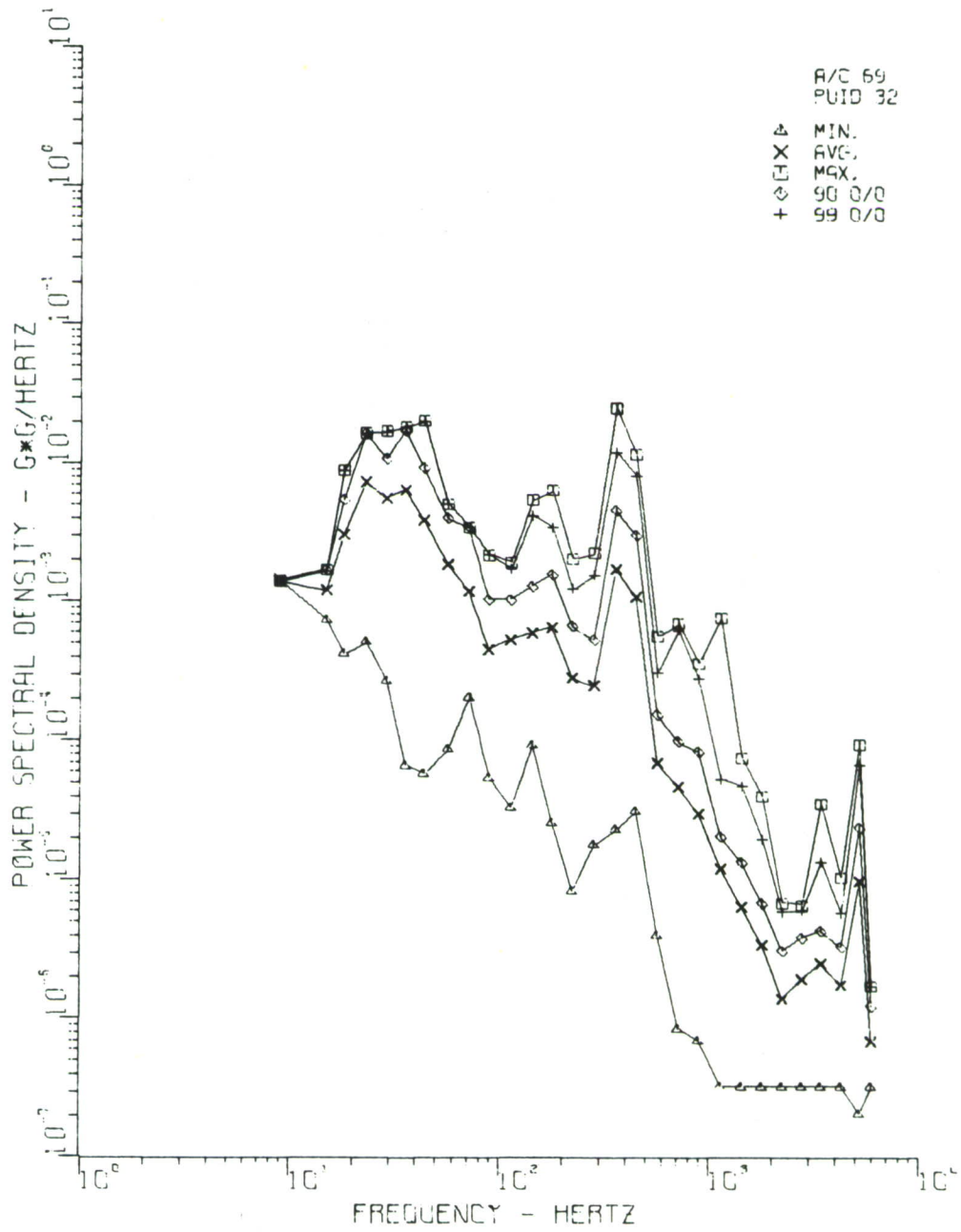

Figure 95. Vertical, Lateral and Fore and Aft, Electronics Comp., Right Side, AN/ARC-51, Sta. 55, without Gunfire

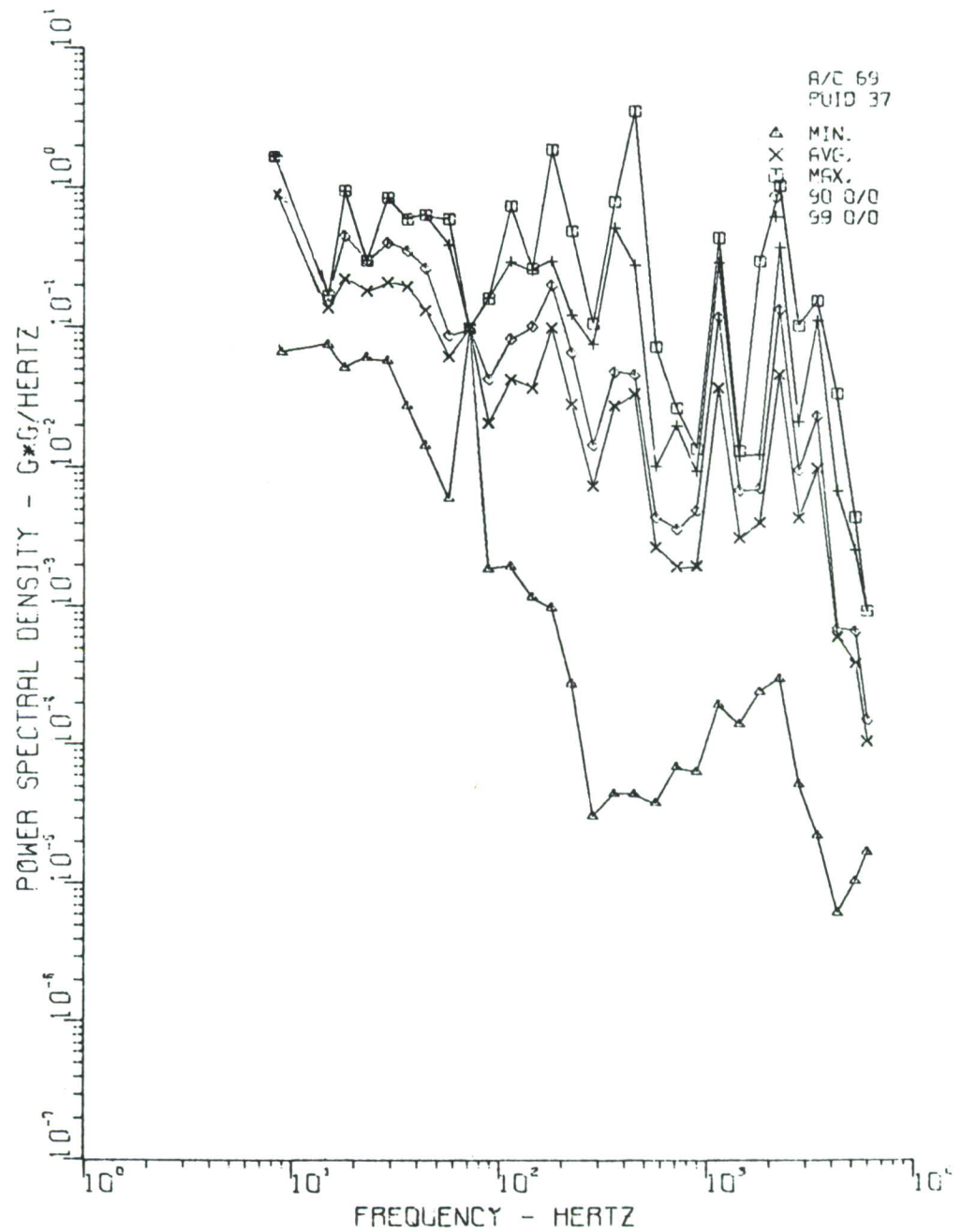

Figure 96. Vertical, Lateral, and Fore and Aft, Tail Section Near 90° Gear Box, Sta. 273, without Gunfire

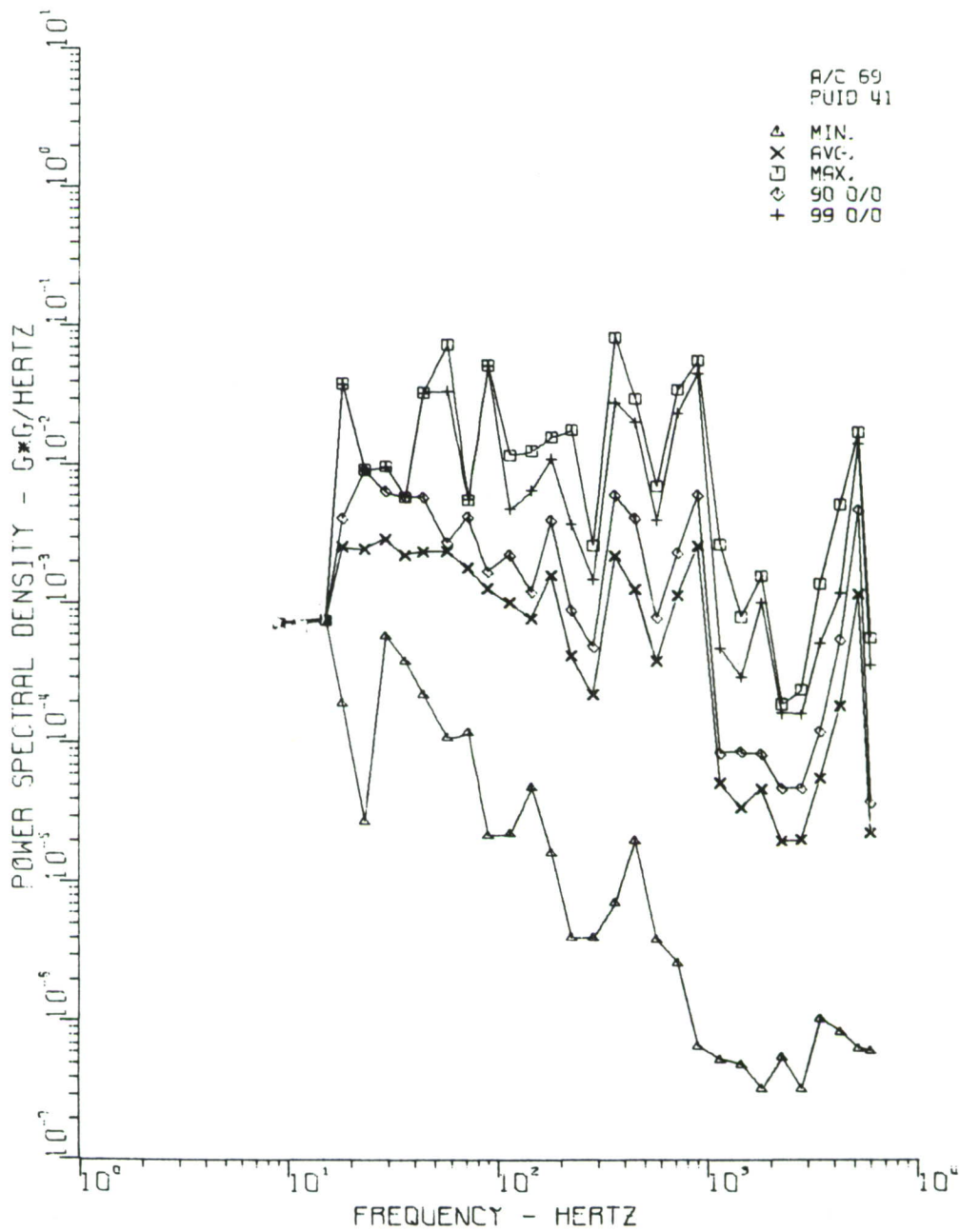

Figure 97. Vertical, Lateral, and Fore and Aft, Cabin Floor, Left Side, Sta. 110, without Gunfire

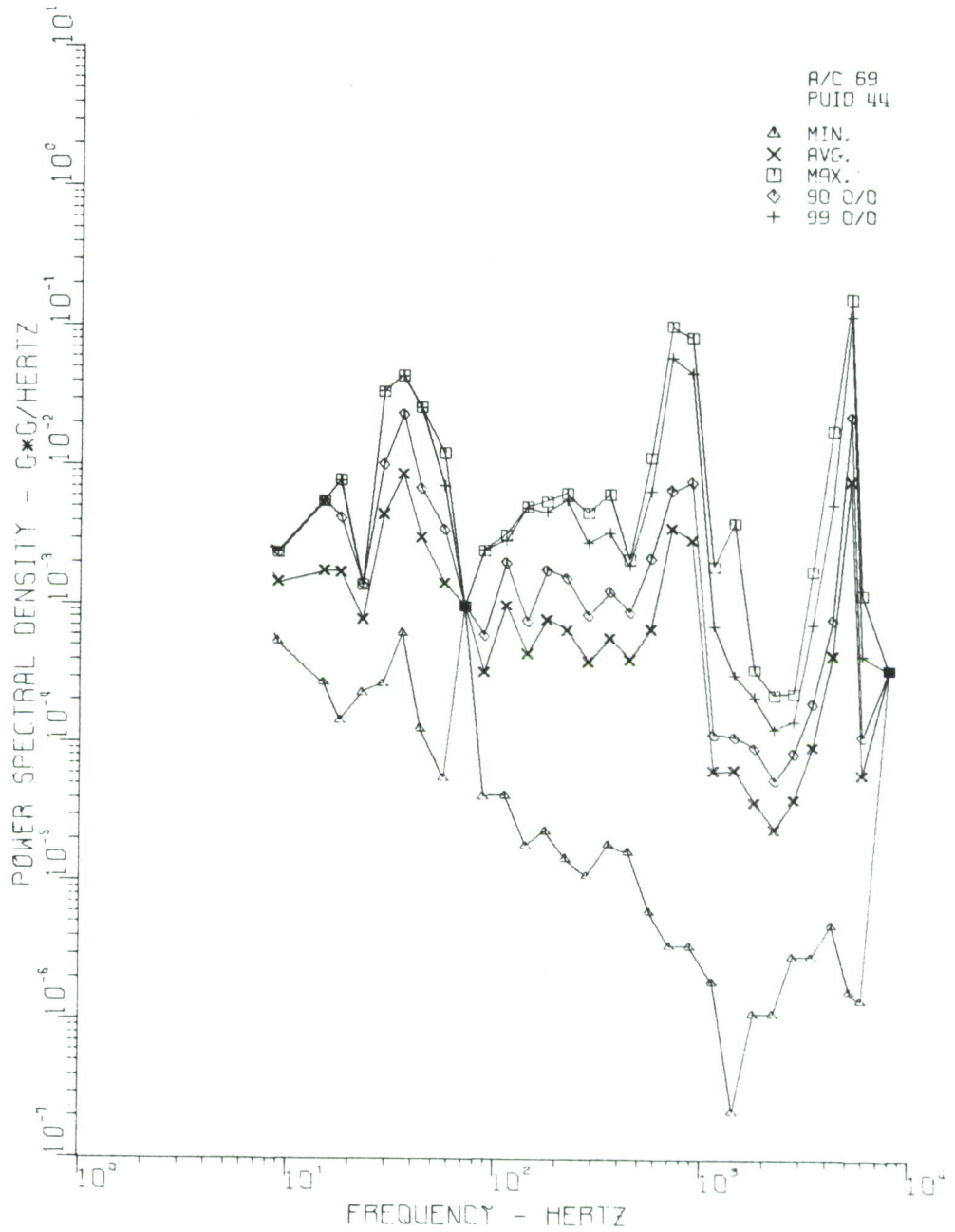

Figure 98. Vertical, Lateral, and Fore and Aft, Cabin Floor, Right Side, Sta. 110, without Gunfire

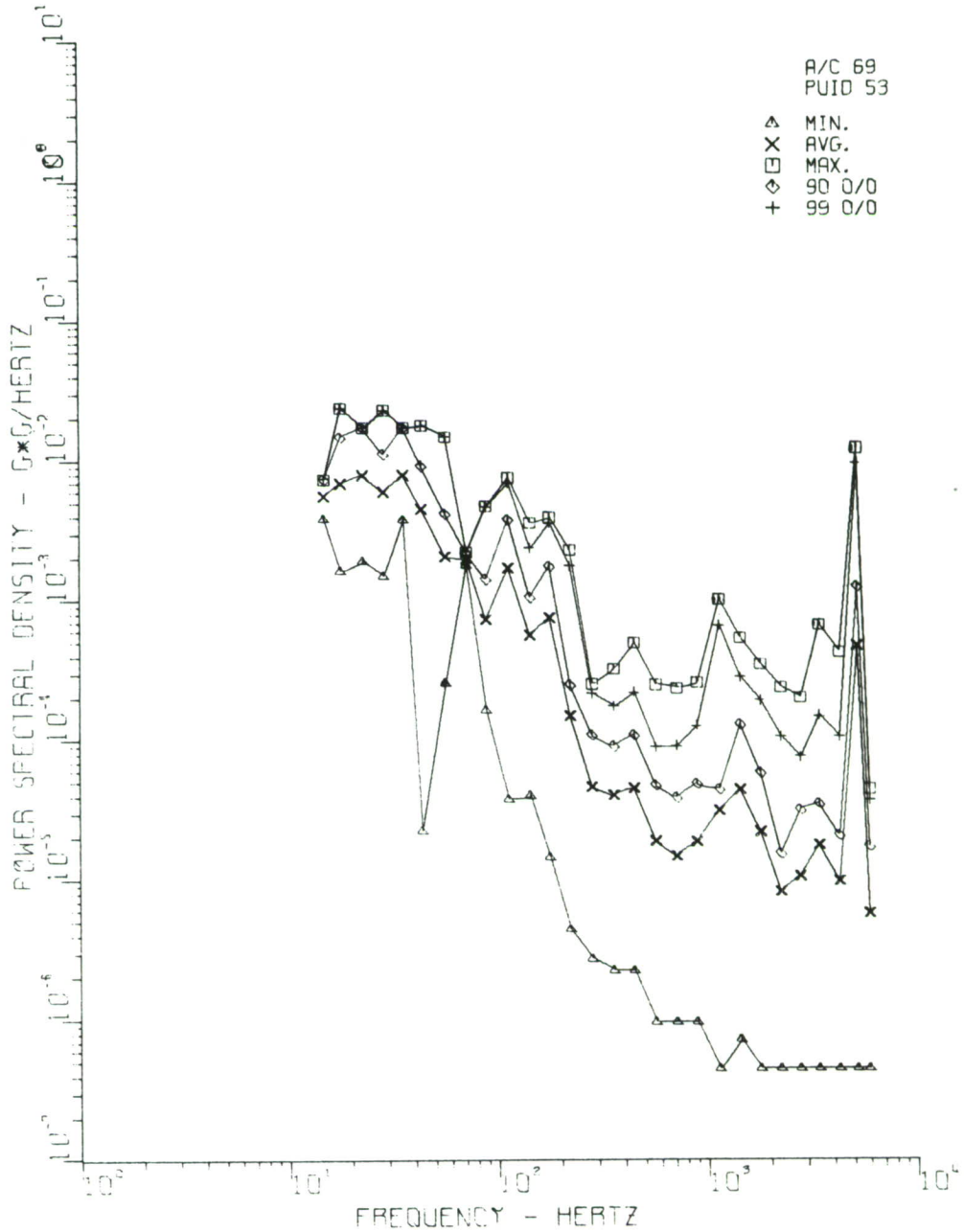

Figure 99. Vertical, Lateral, and Fore and Aft, XM-27 Armament Mount, Sta. 92, without Gunfire

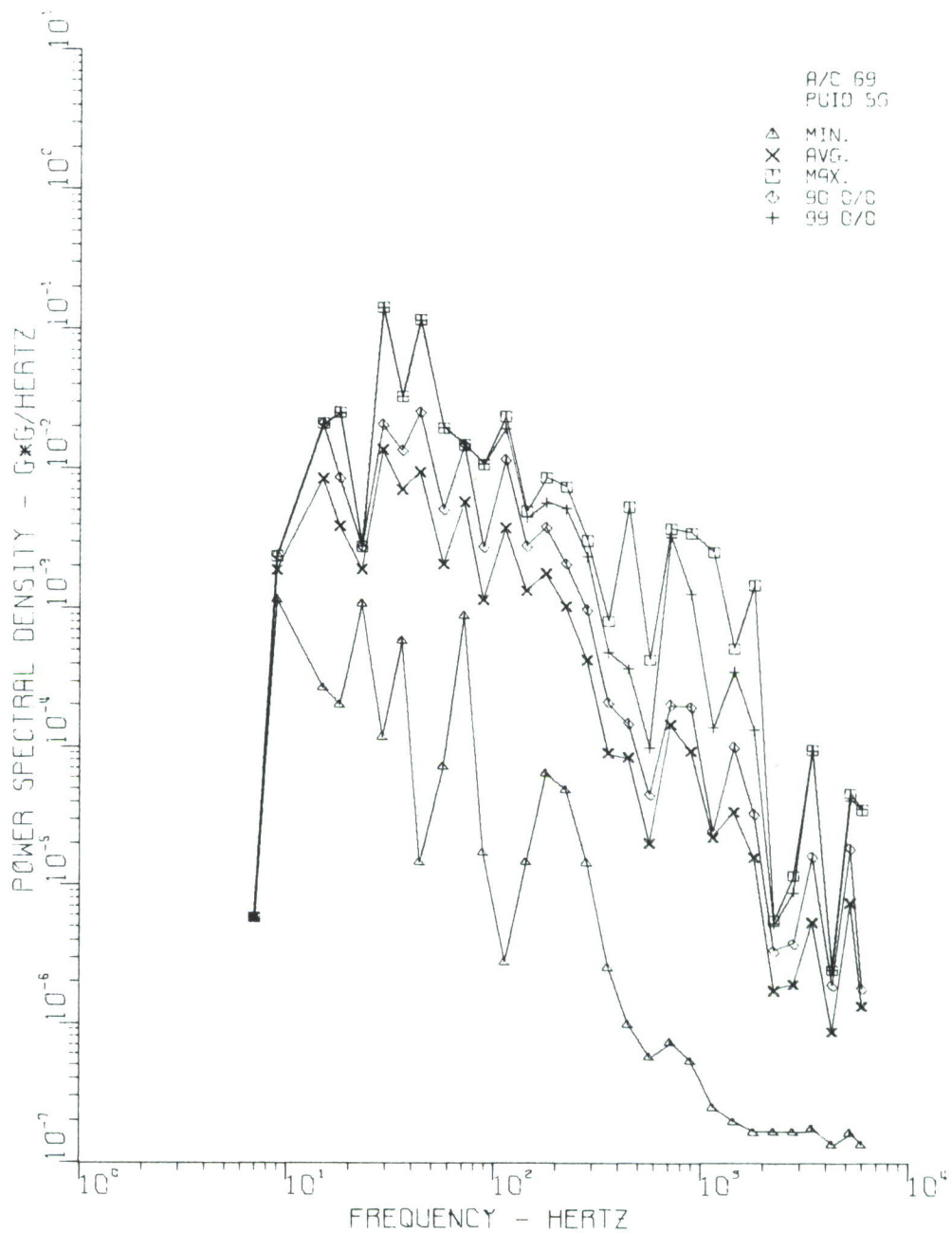

Figure 100. Vertical, Lateral and Fore and Aft, Directional Gyro Shelf, Left Side, Sta. 70, without Gunfire

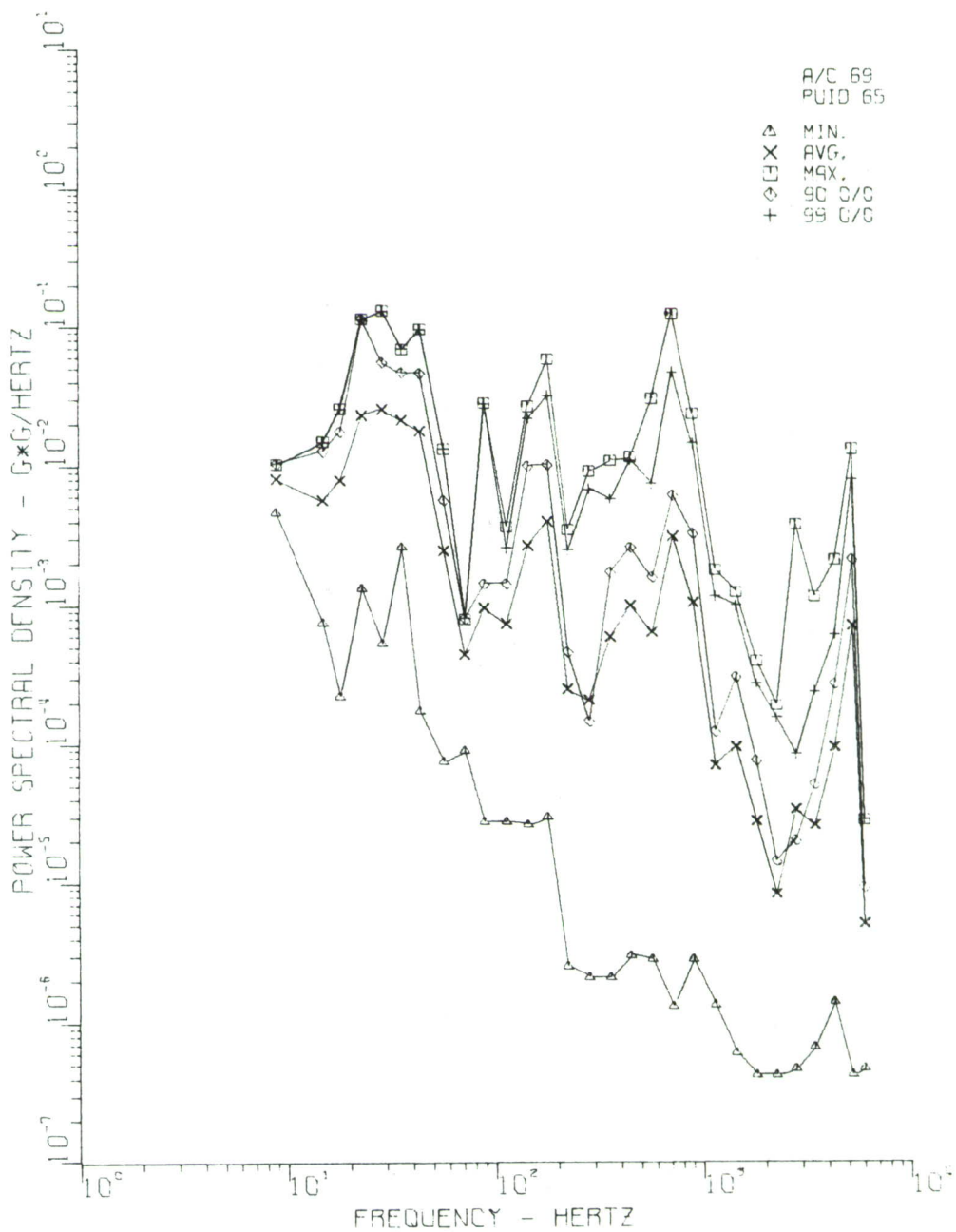

Figure 101. Vertical, Lateral, and Fore and Aft, ADF Antenna Interface, Sta. 69, without Gunfire

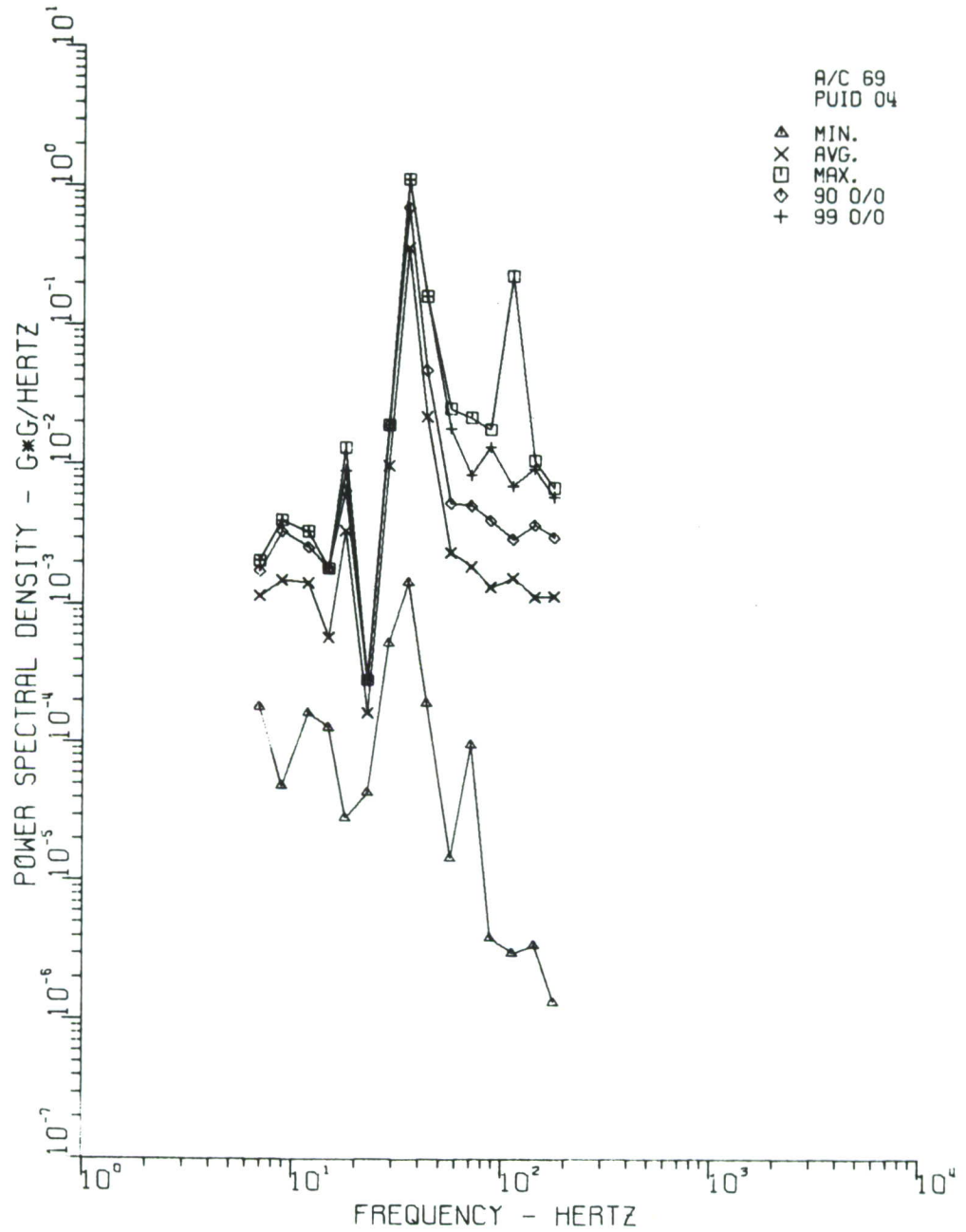

Figure 102. Vertical, Lateral and Fore and Aft, Instrument Panel, Left Side, Sta. 43, without Gunfire

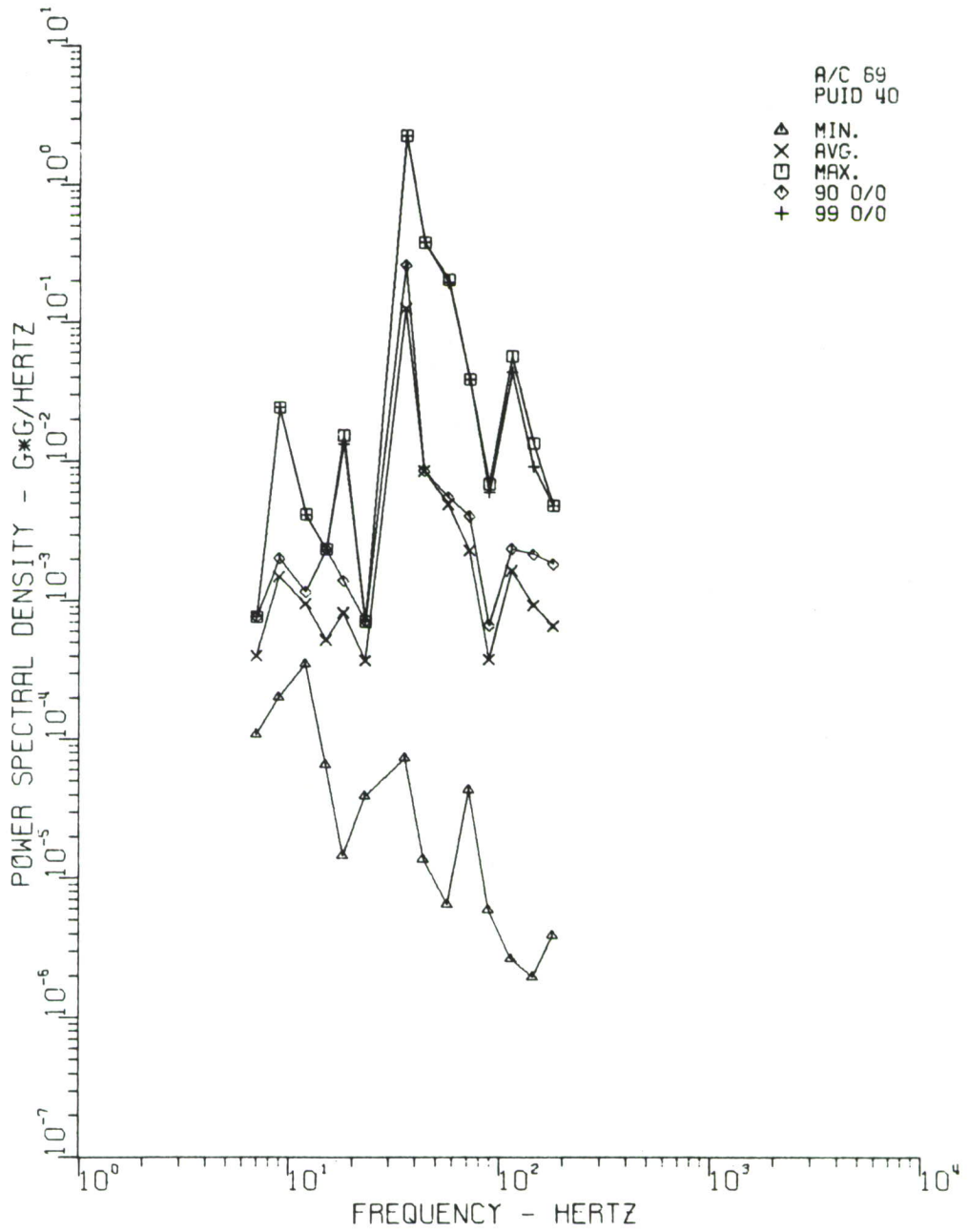

Figure 103. Vertical and Lateral, Instrument Panel Base, Left Side, Sta. 39, without Gunfire

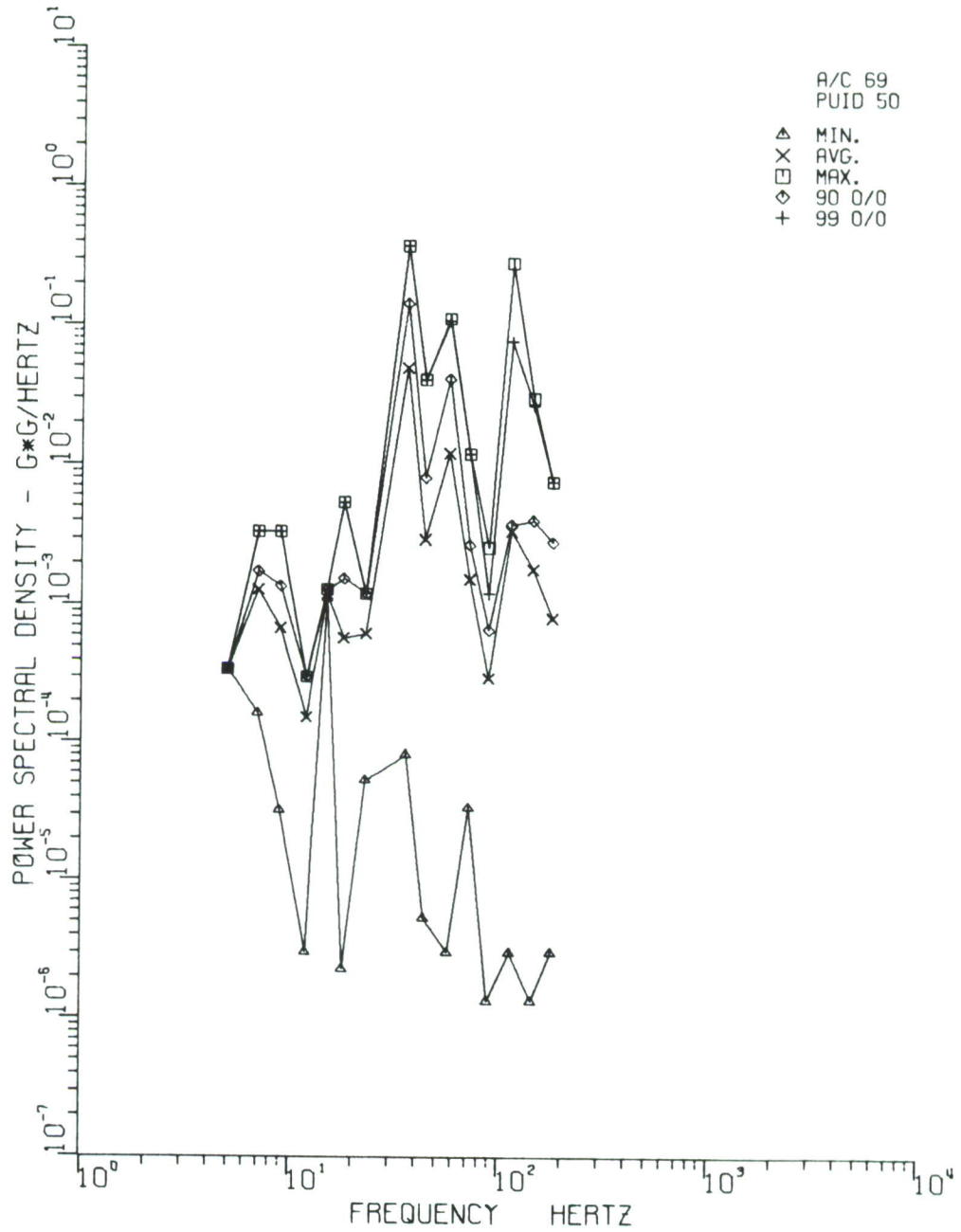

Figure 104. Vertical and Lateral, Cabin Floor, Right Side, Sta. 90, without Gunfire

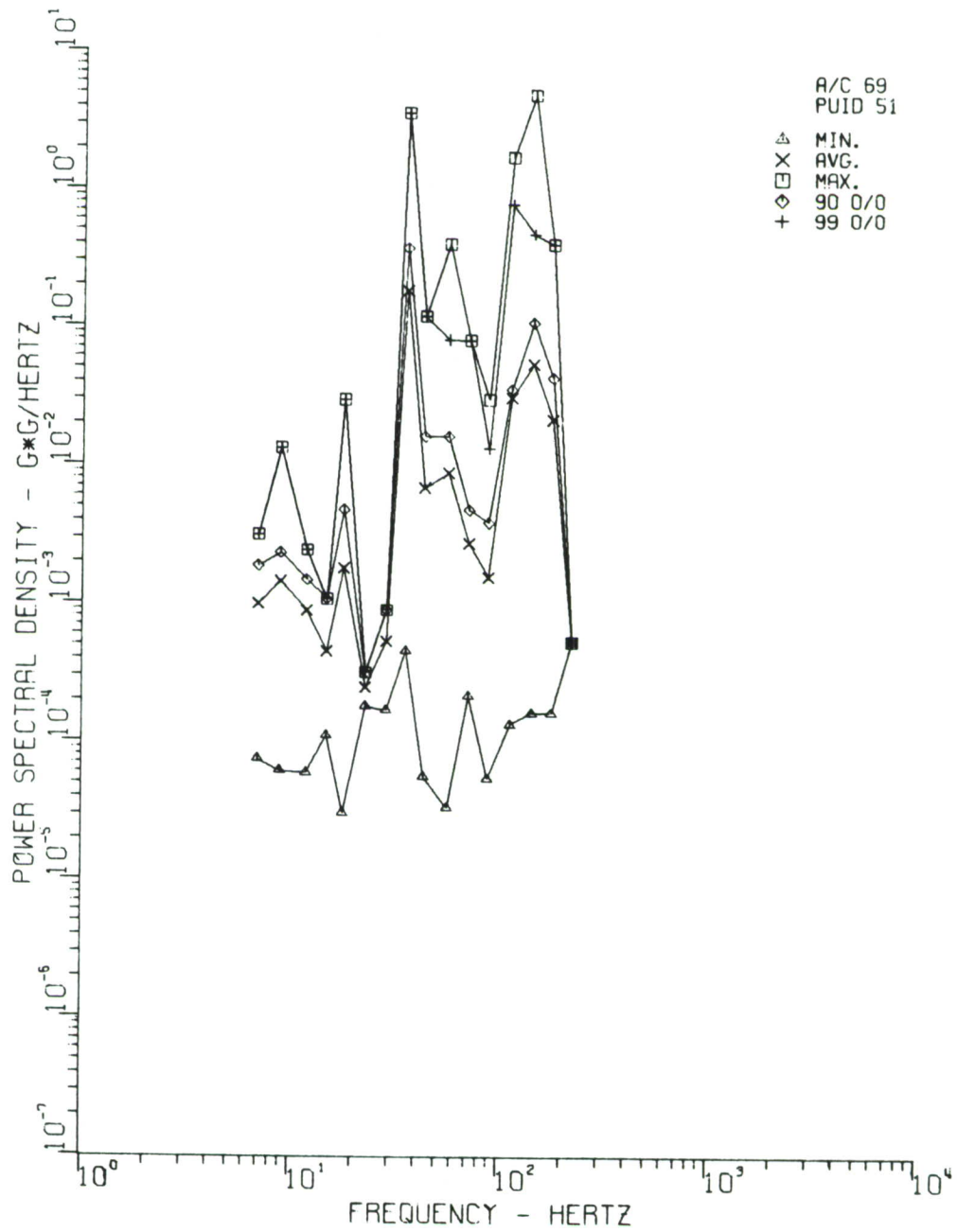

Figure 105. Vertical and Lateral, Fuselage-Tail Section Interface, Sta. 130, without Gunfire

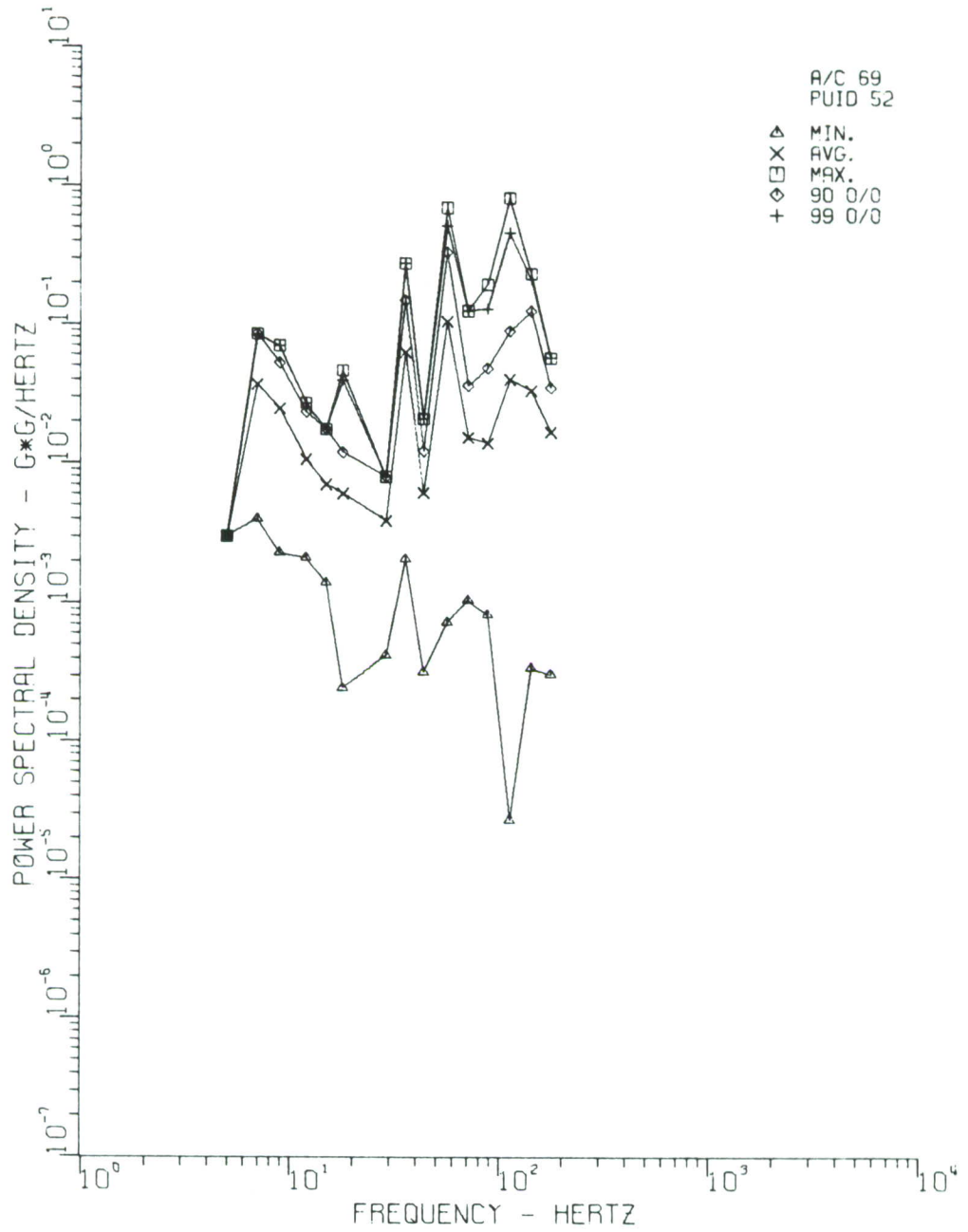

Figure 106. Vertical and Lateral, Tail Section, Near 90° Gear Box, Sta. 273, without Gunfire

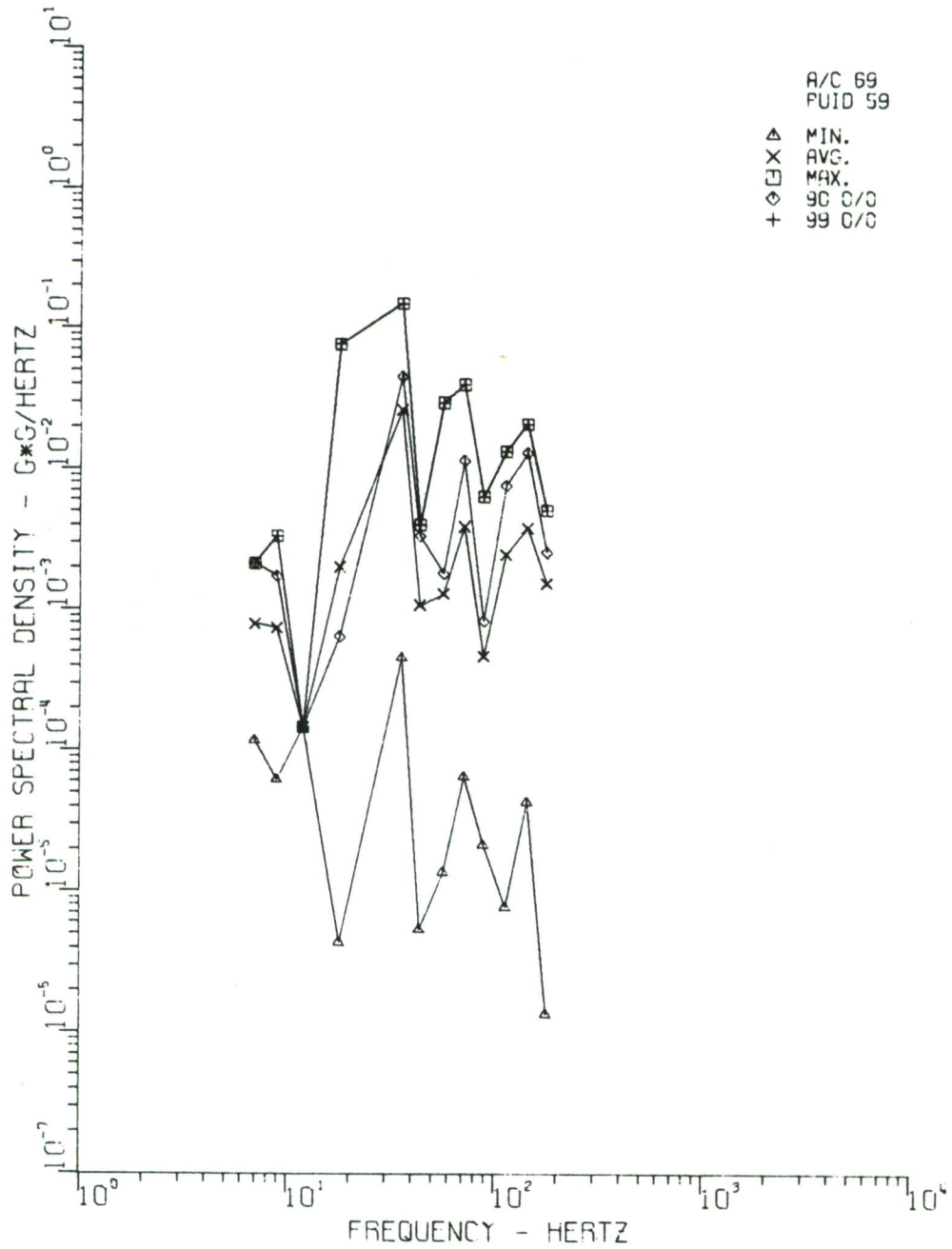

Figure 107. Vertical, Cabin Floor, Left Side, Sta. 90, without Gunfire

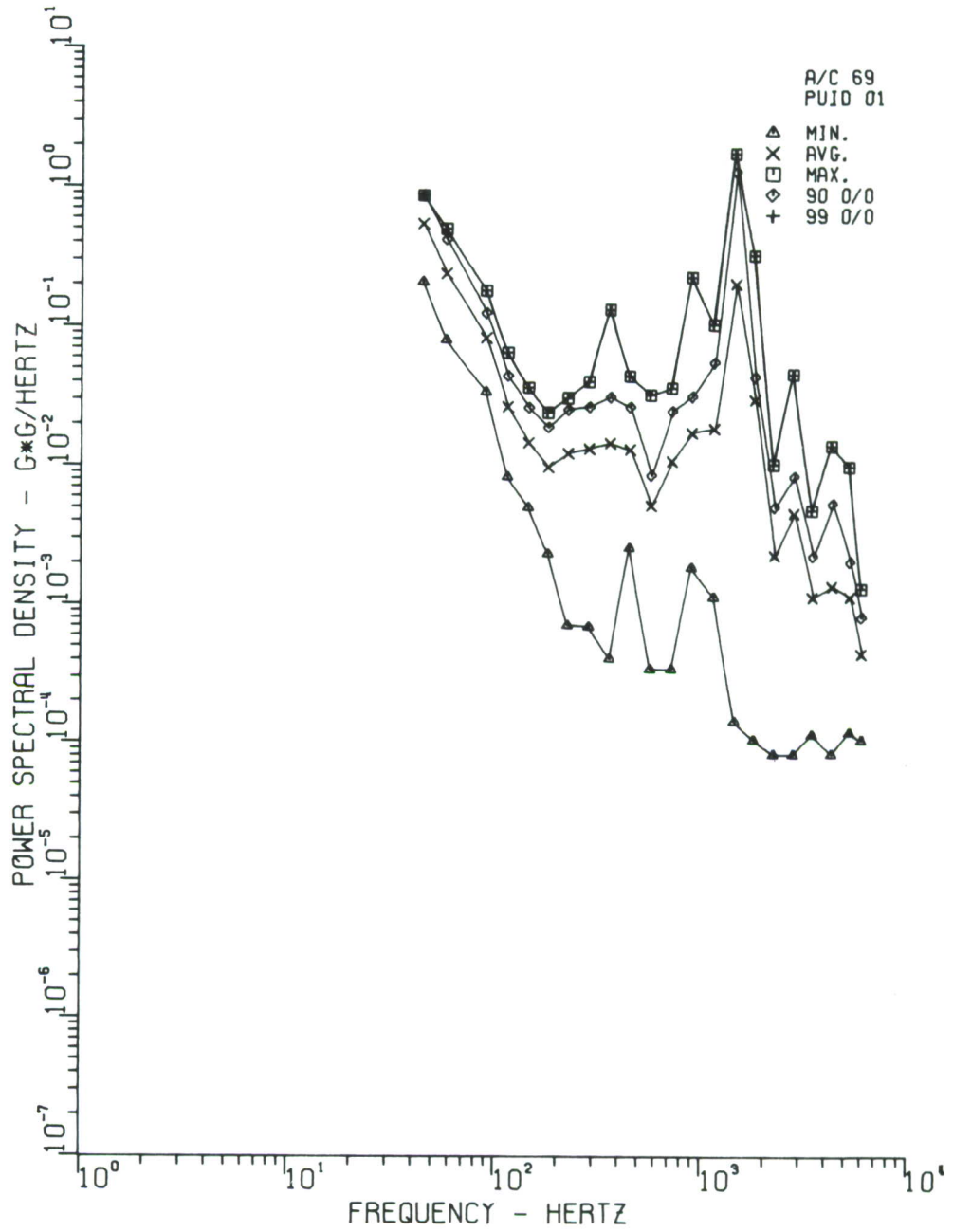

Figure 108. Vertical, Lateral, and Fore and Aft, Main Rotor Transmission Interface, Right Rear Support, Sta. 108, with Gunfire

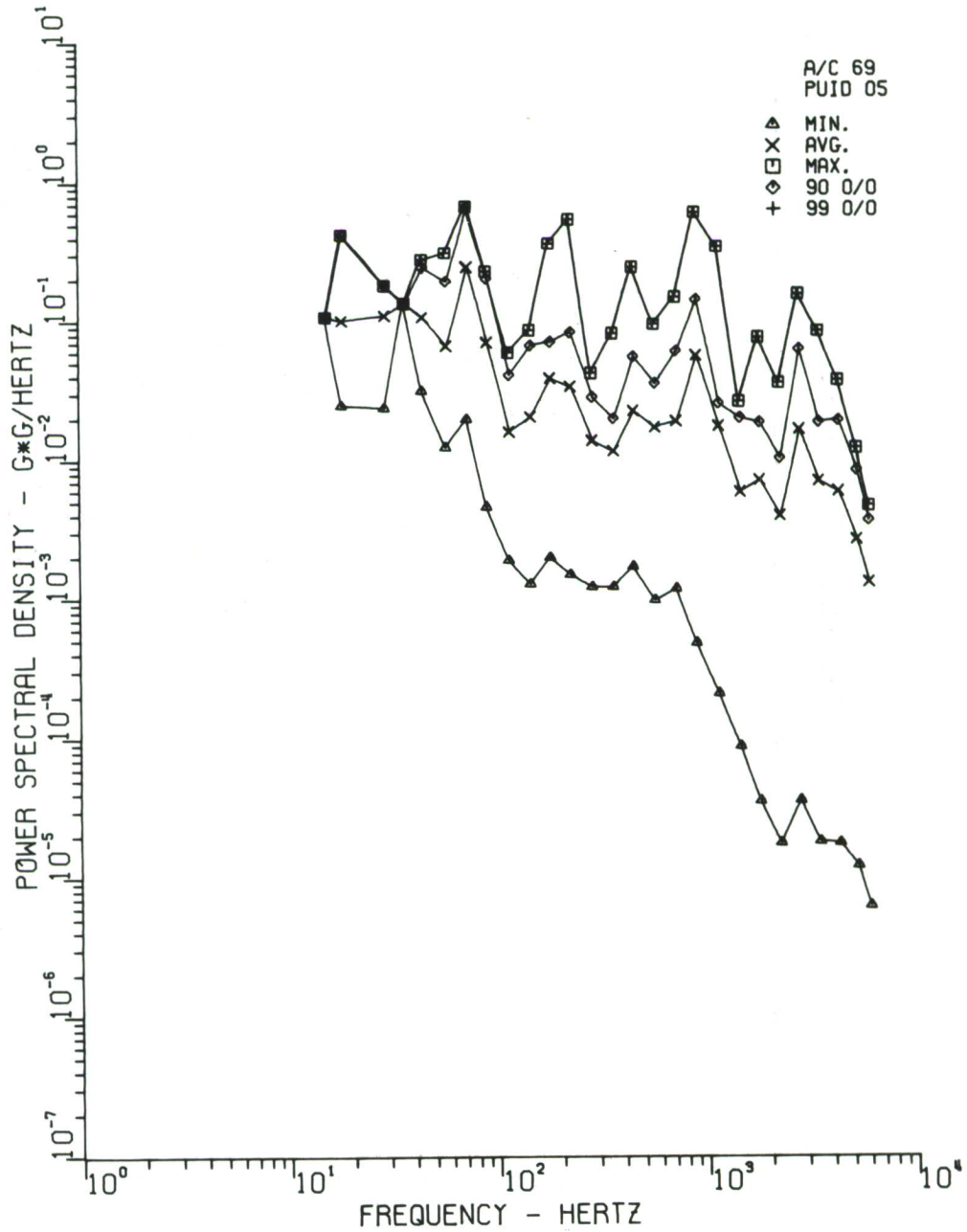

Figure 109. Vertical, Lateral, and Fore and Aft, Instrument Panel, Right Side, Sta. 44, with Gunfire

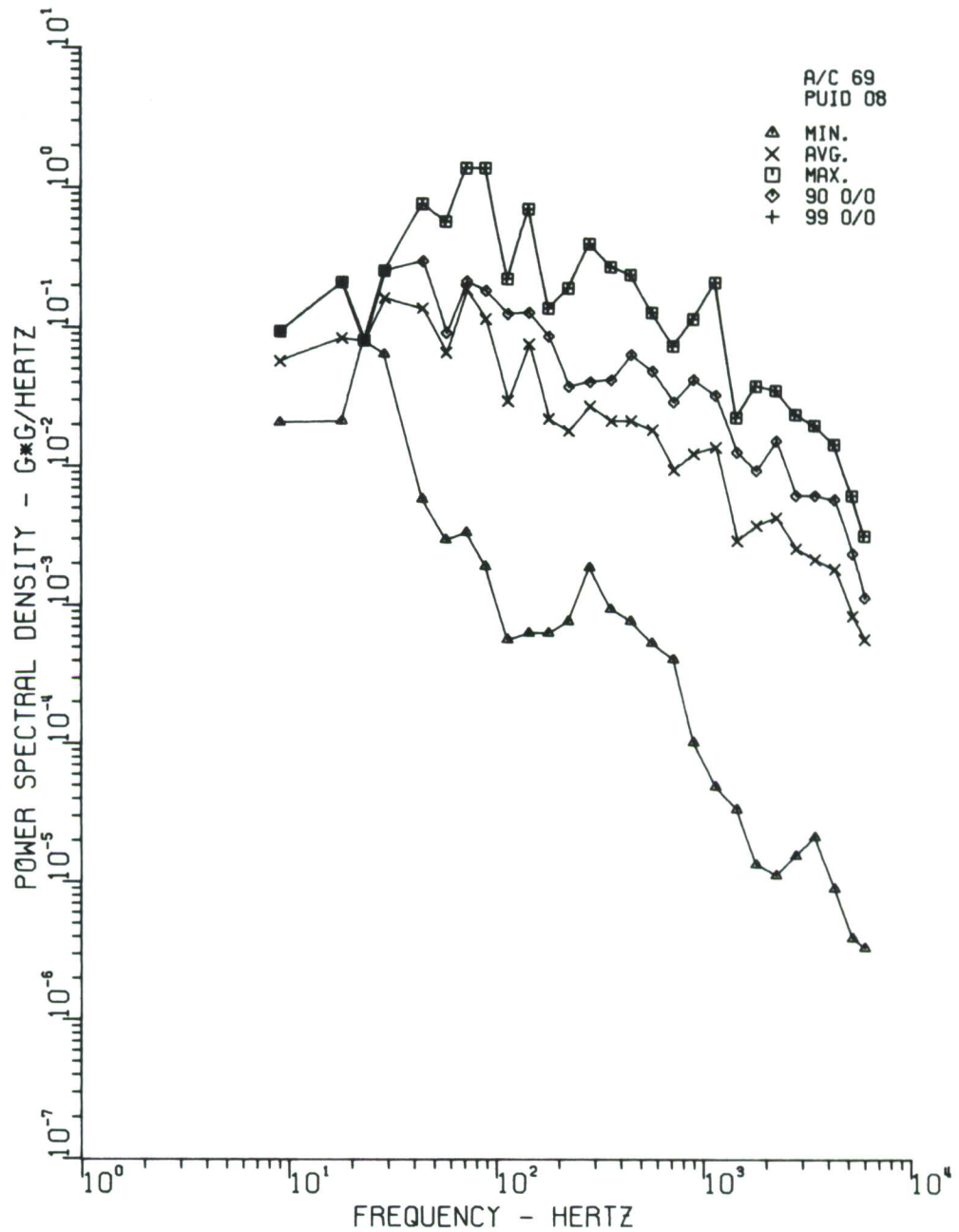

Figure 110. Vertical, Lateral, and Fore and Aft, Instrument Pedestal Center, Sta. 56, with Gunfire

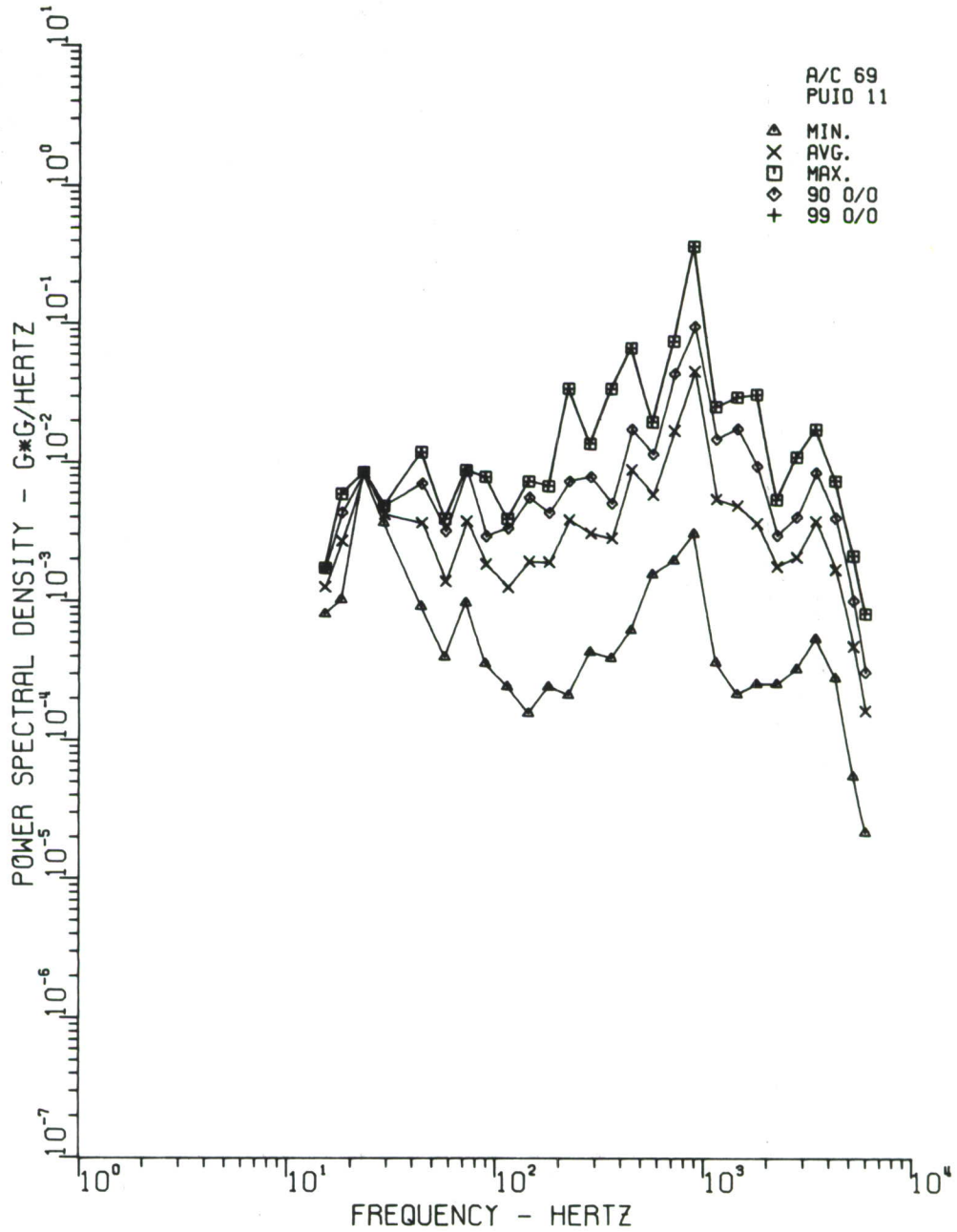

Figure 111. Vertical, Lateral, and Fore and Aft, Cabin Floor, Center, Sta. 88, with Gunfire

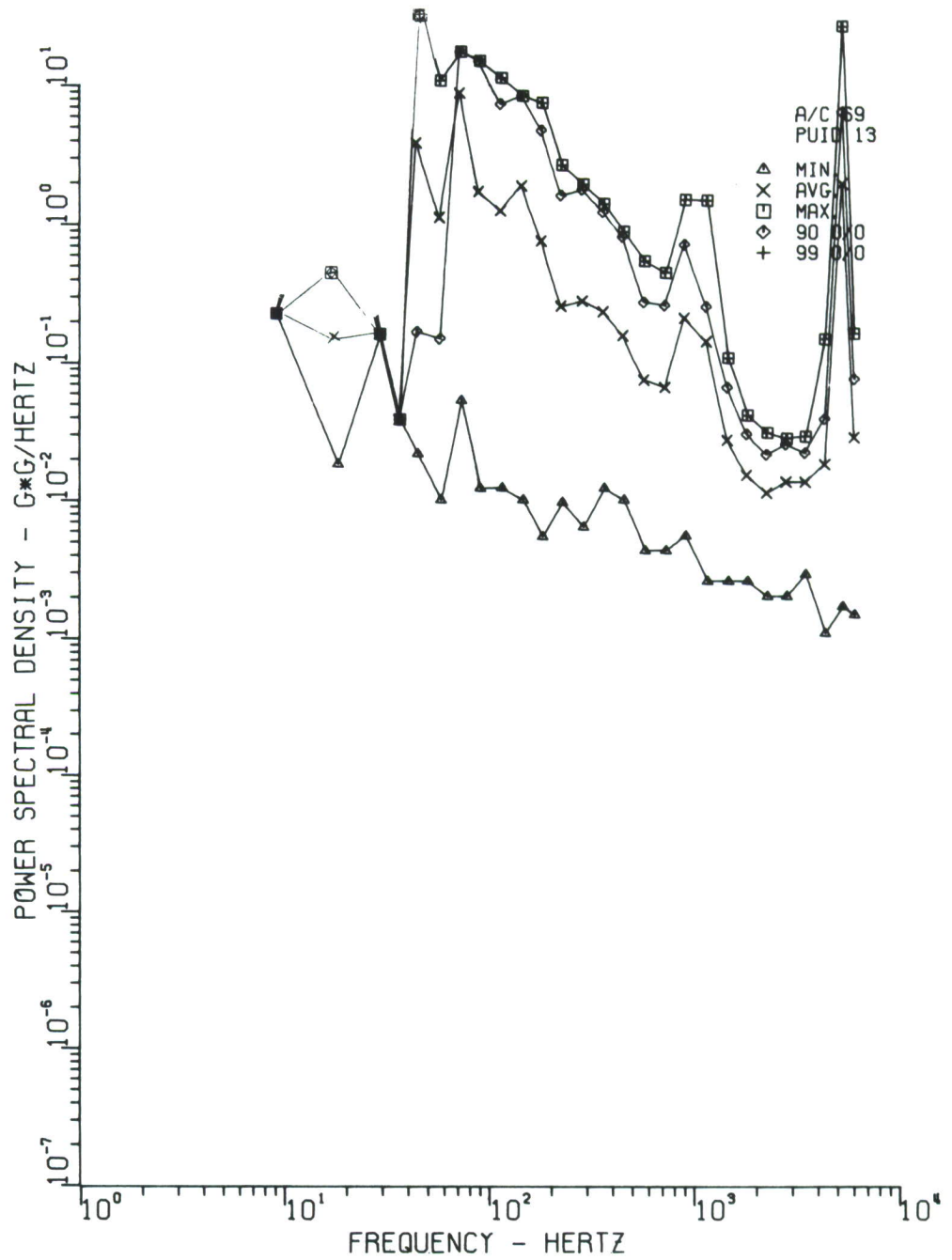

Figure 112. Vertical, Lateral, and Fore and Aft, Left Engine Mount Interface, Sta. 121, with Gunfire

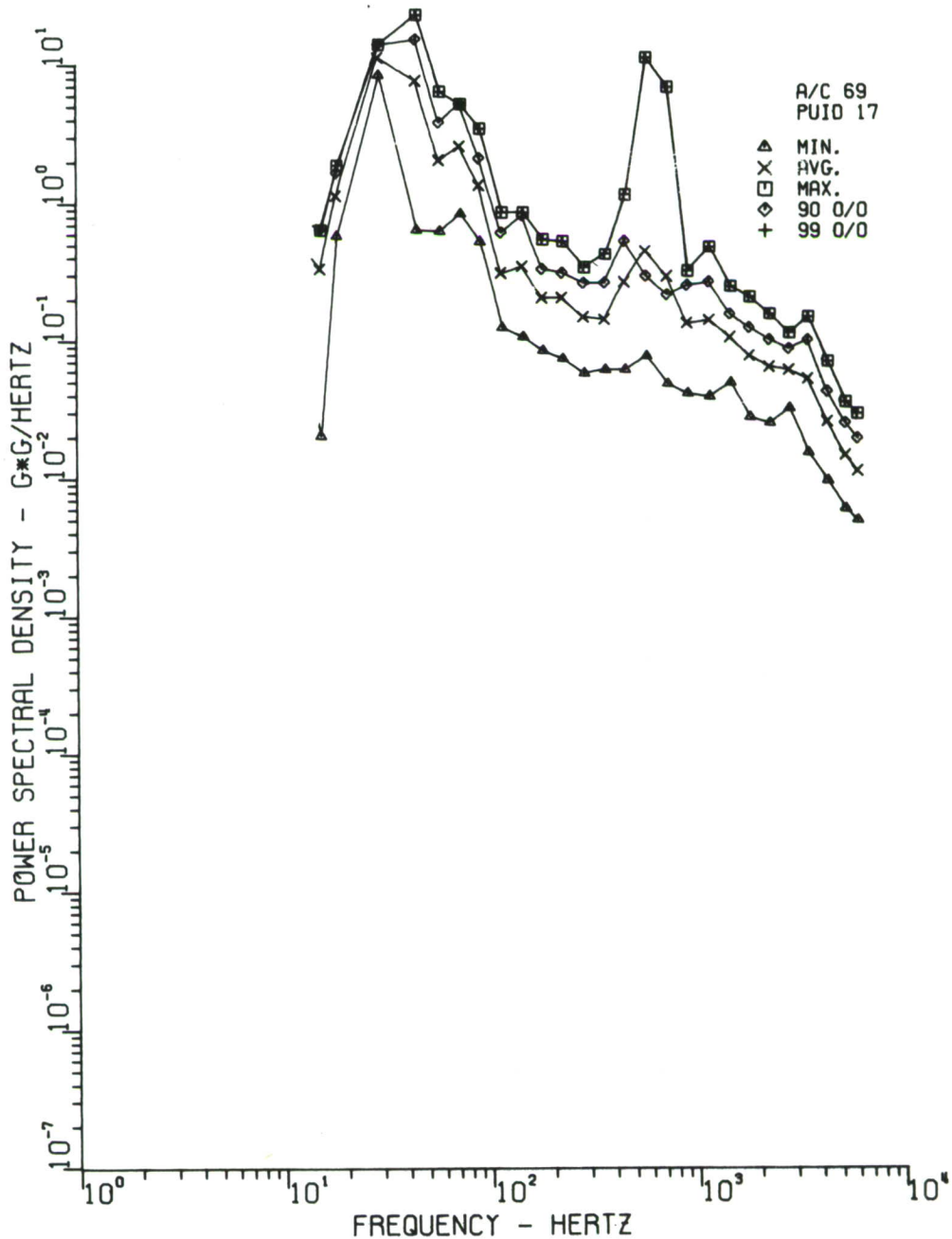

Figure 113. Vertical, Lateral, and Fore and Aft, Electronics Comp., Left Side, AN/ARC-54, Sta. 62, with Gunfire

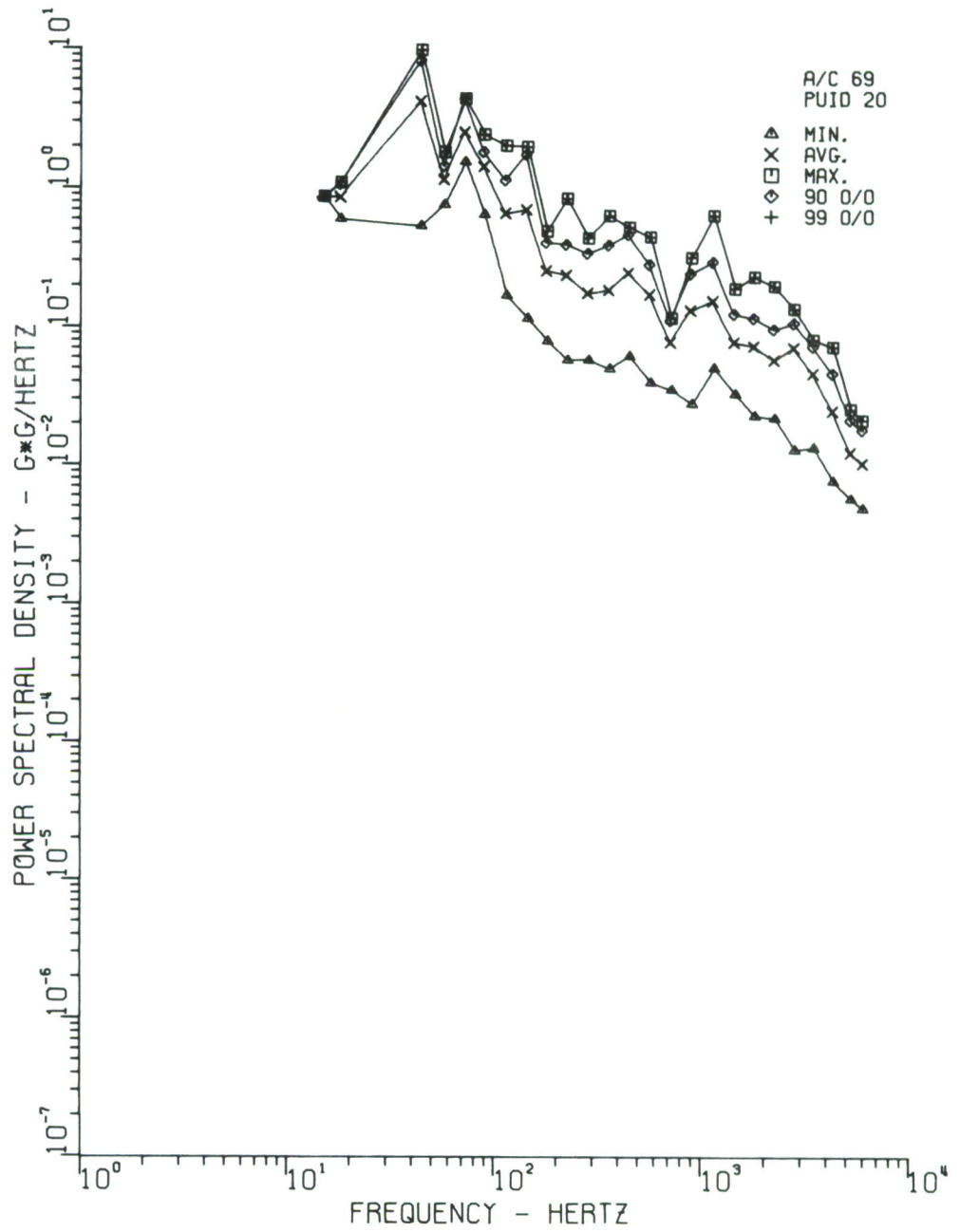

Figure 114. Vertical, Lateral, and Fore and Aft, Electronics Comp., Left Side, AN/ARC-54, Sta. 58, with Gunfire

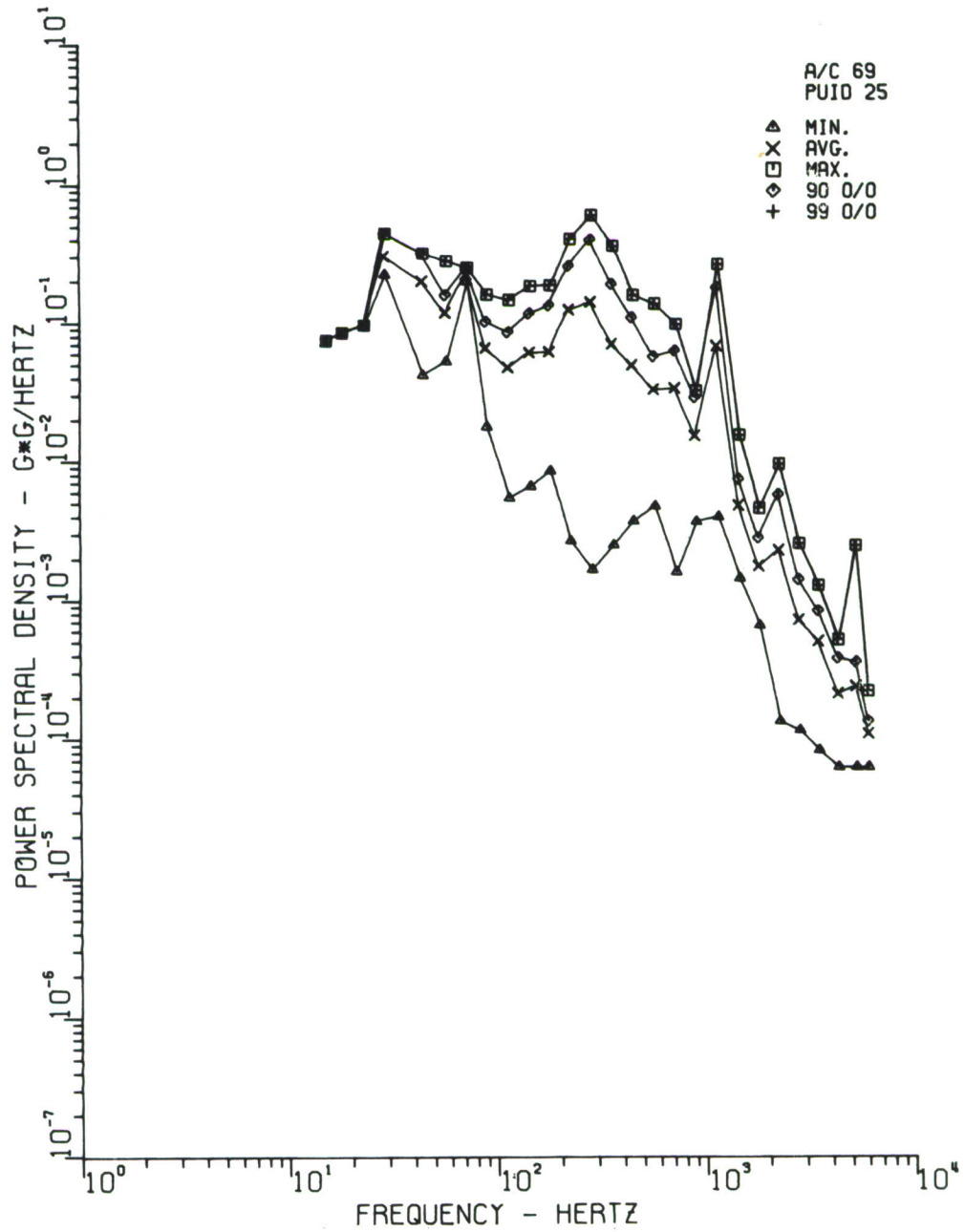

Figure 115. Vertical, Lateral, and Fore and Aft, Tail Section Center, Sta. 220, with Gunfire

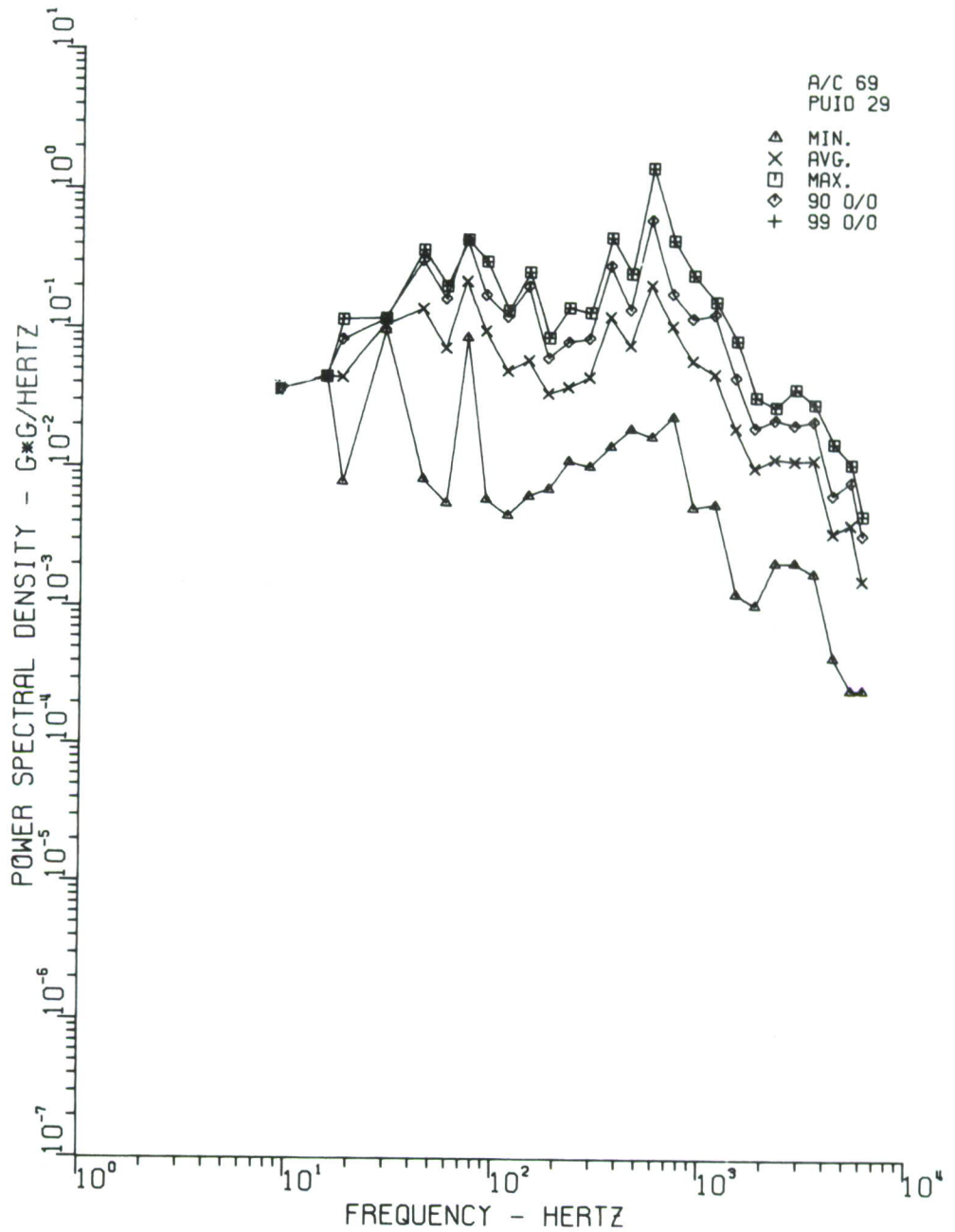

Figure 116. Vertical, Lateral, and Fore and Aft, Electronics Comp., Right Side, AN/ARC-51, Sta. 62, with Gunfire

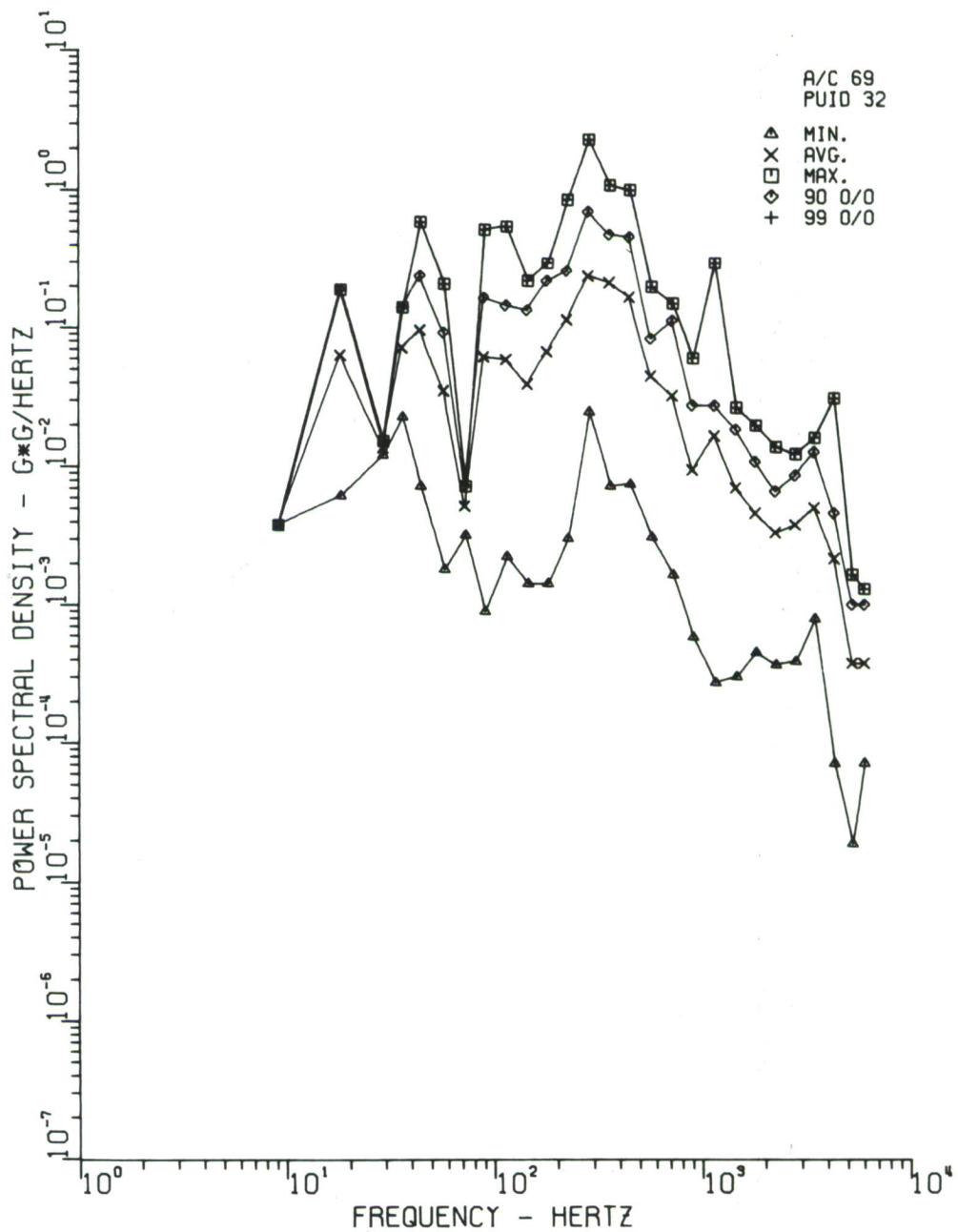

Figure 117. Vertical, Lateral, and Fore and Aft, Electronics Comp., Right Side, AN/ARC-51, Sta. 55, with Gunfire

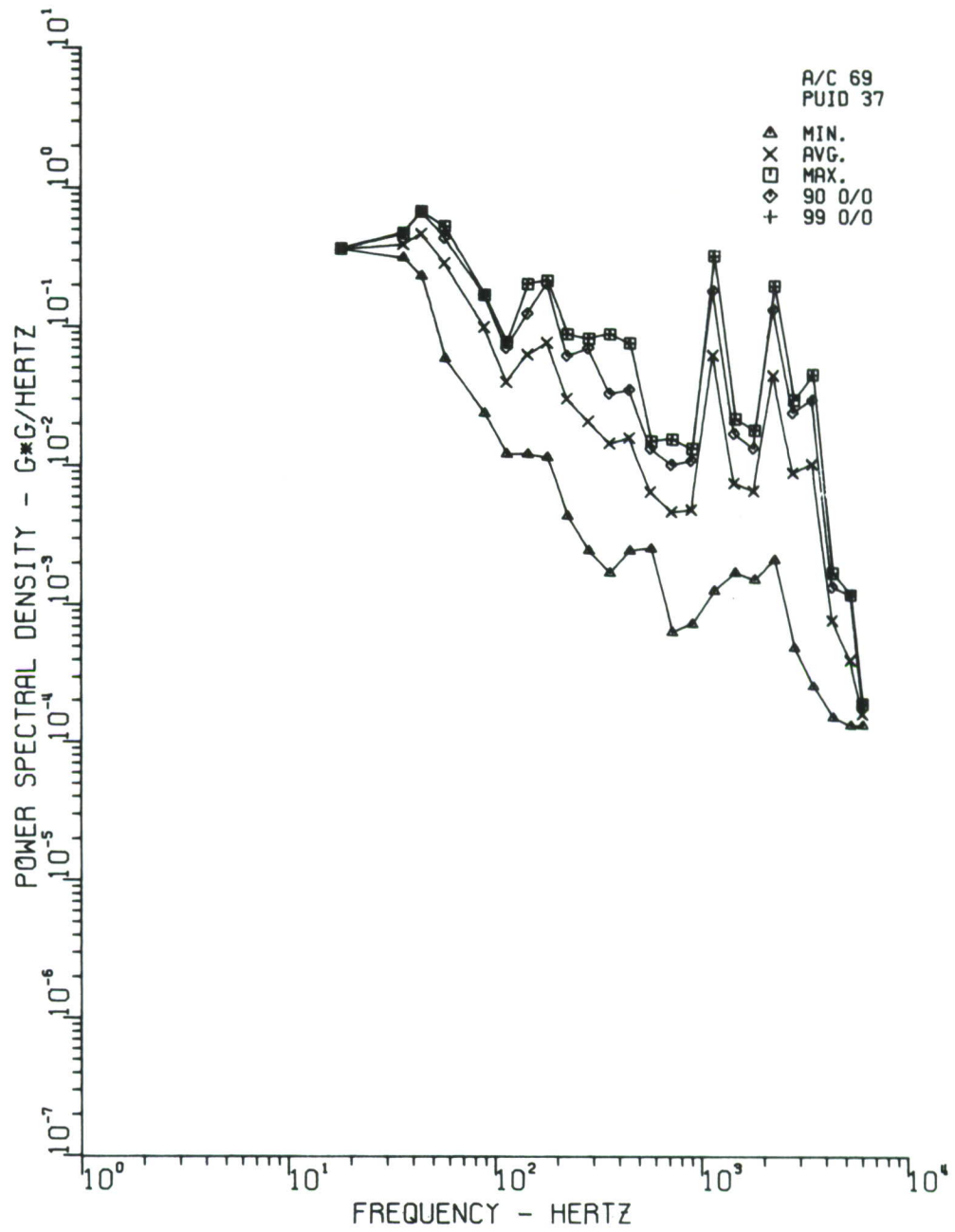

Figure 118. Vertical, Lateral, and Fore and Aft, Tail Section Near 90° Gear Box, Sta. 273, with Gunfire

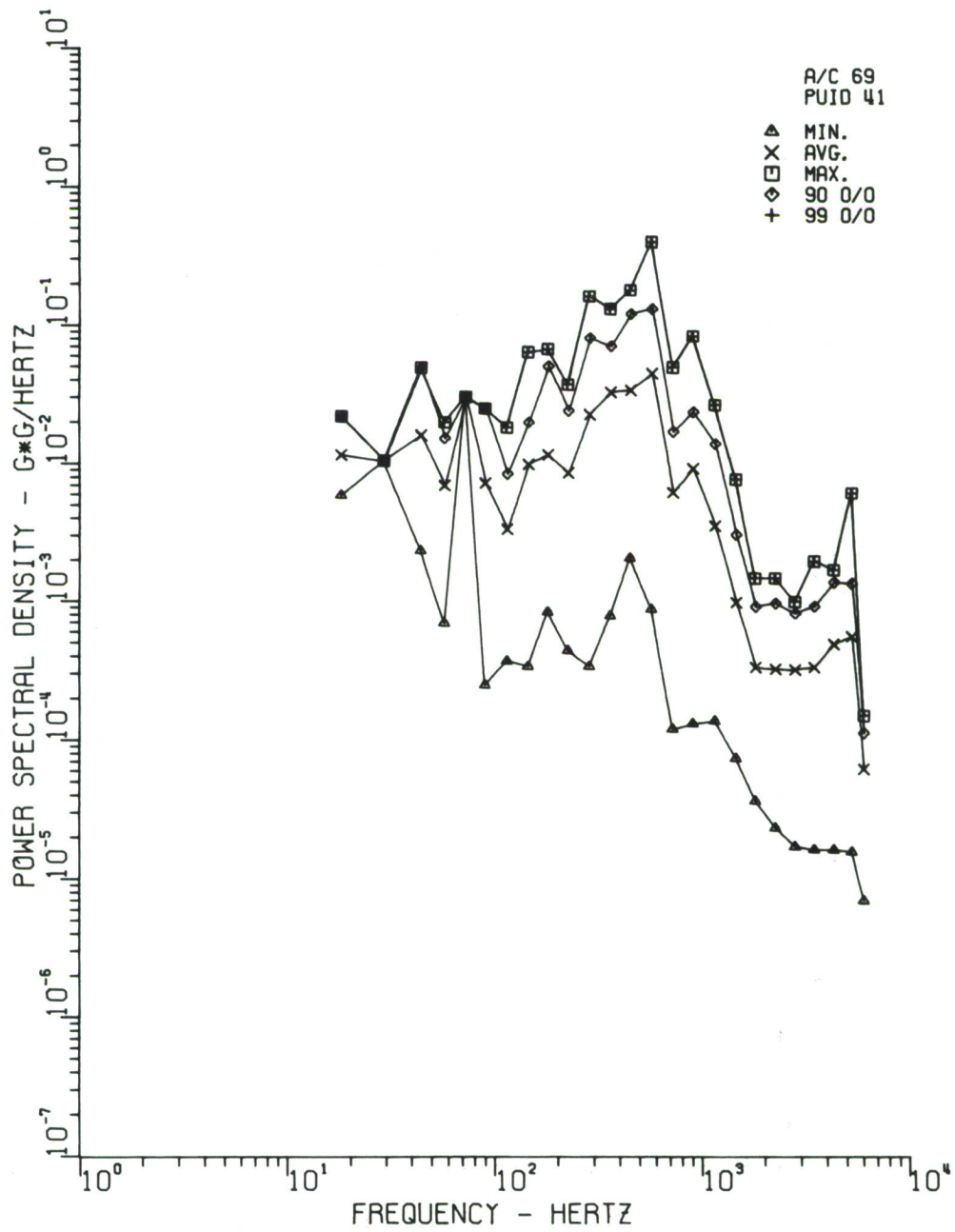

Figure 119. Vertical, Lateral, and Fore and Aft, Cabin Floor, Left Side, Sta. 110, with Gunfire

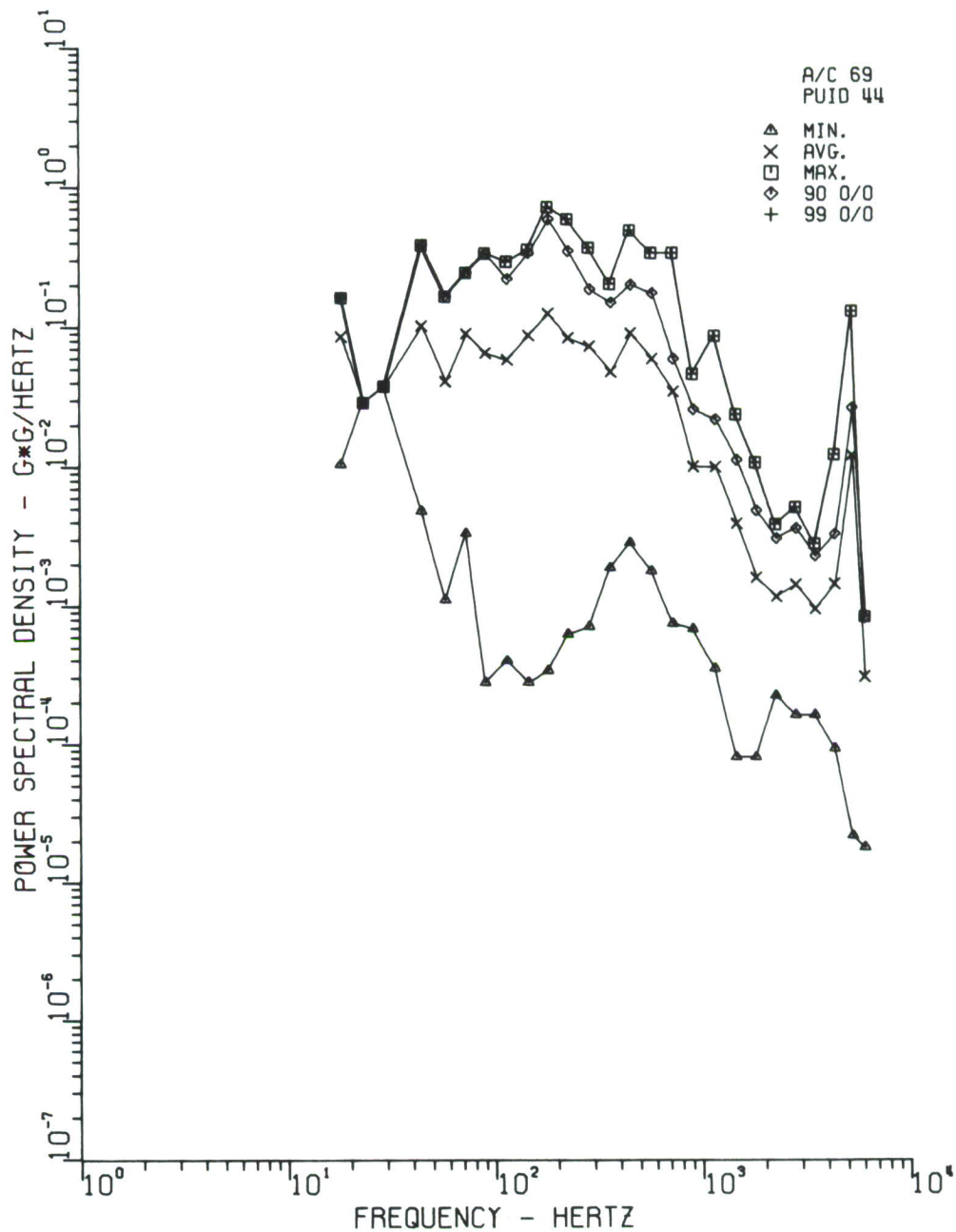

Figure 120. Vertical, Lateral and Fore and Aft, Cabin Floor, Right Side, Sta. 110, with Gunfire

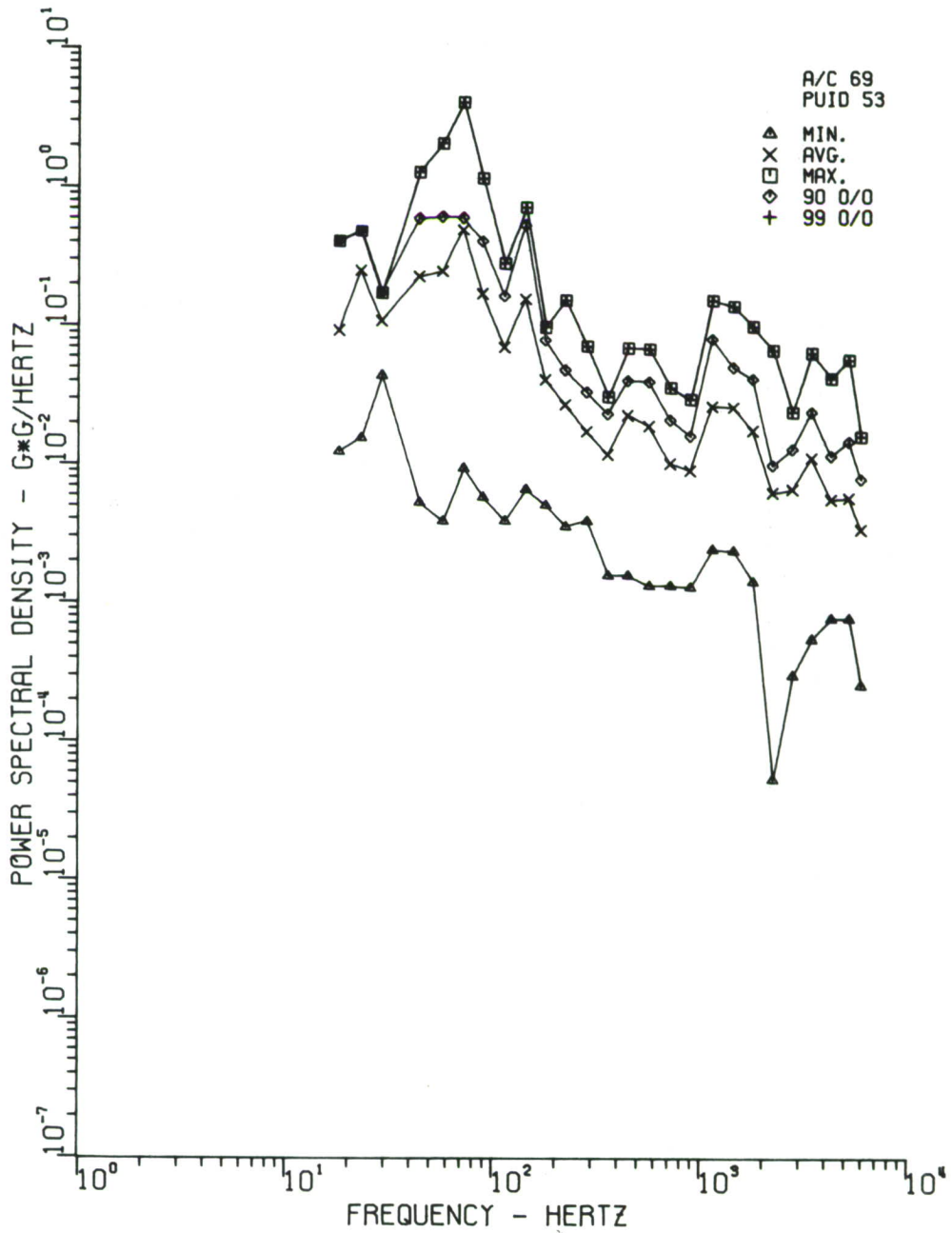

Figure 121. Vertical, Lateral, and Fore and Aft, XM-27 Armament Mount, Sta. 92, with Gunfire

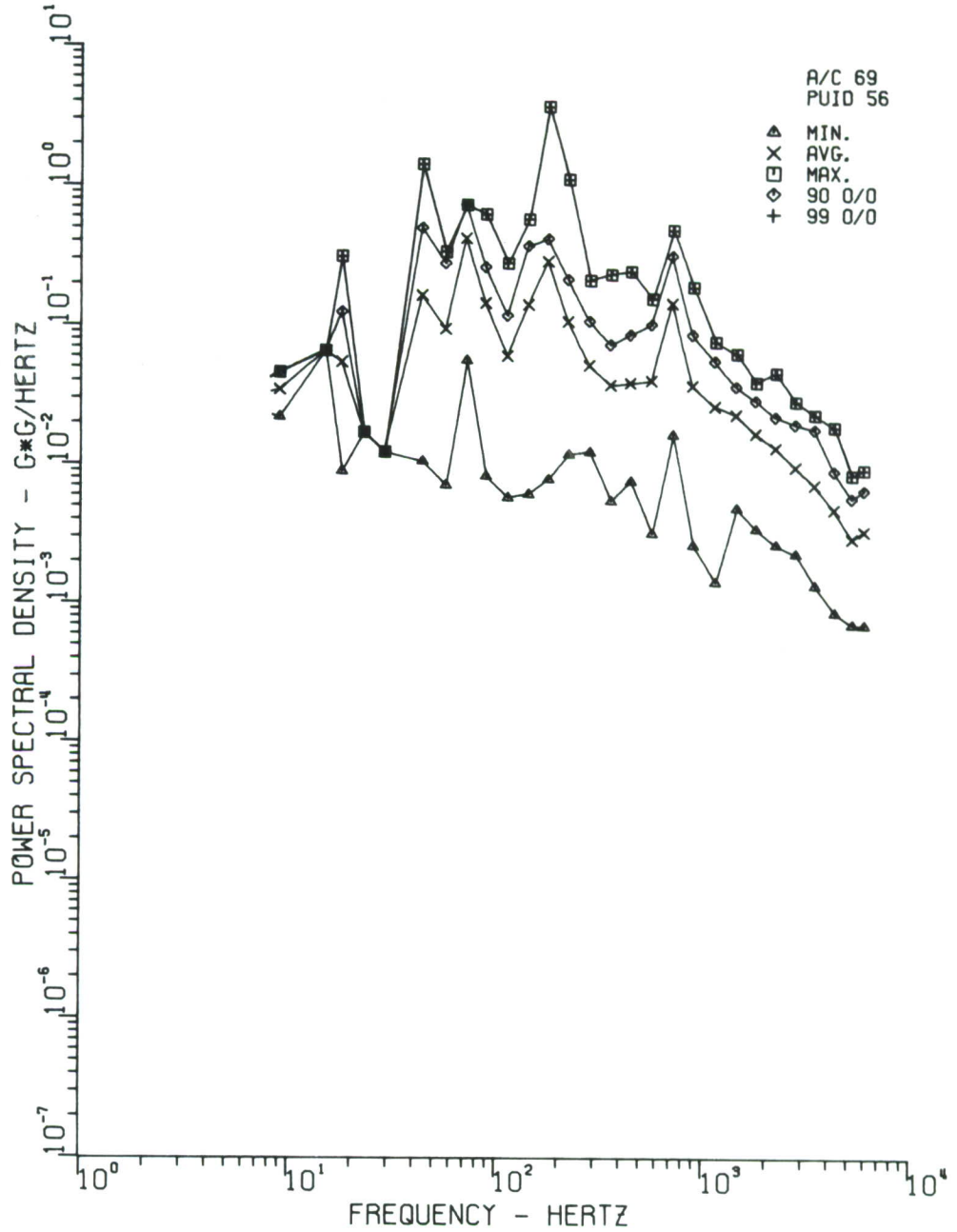

Figure 122. Vertical, Lateral, and Fore and Aft, Directional Gyro Shelf, Left Side, Sta. 70, with Gunfire

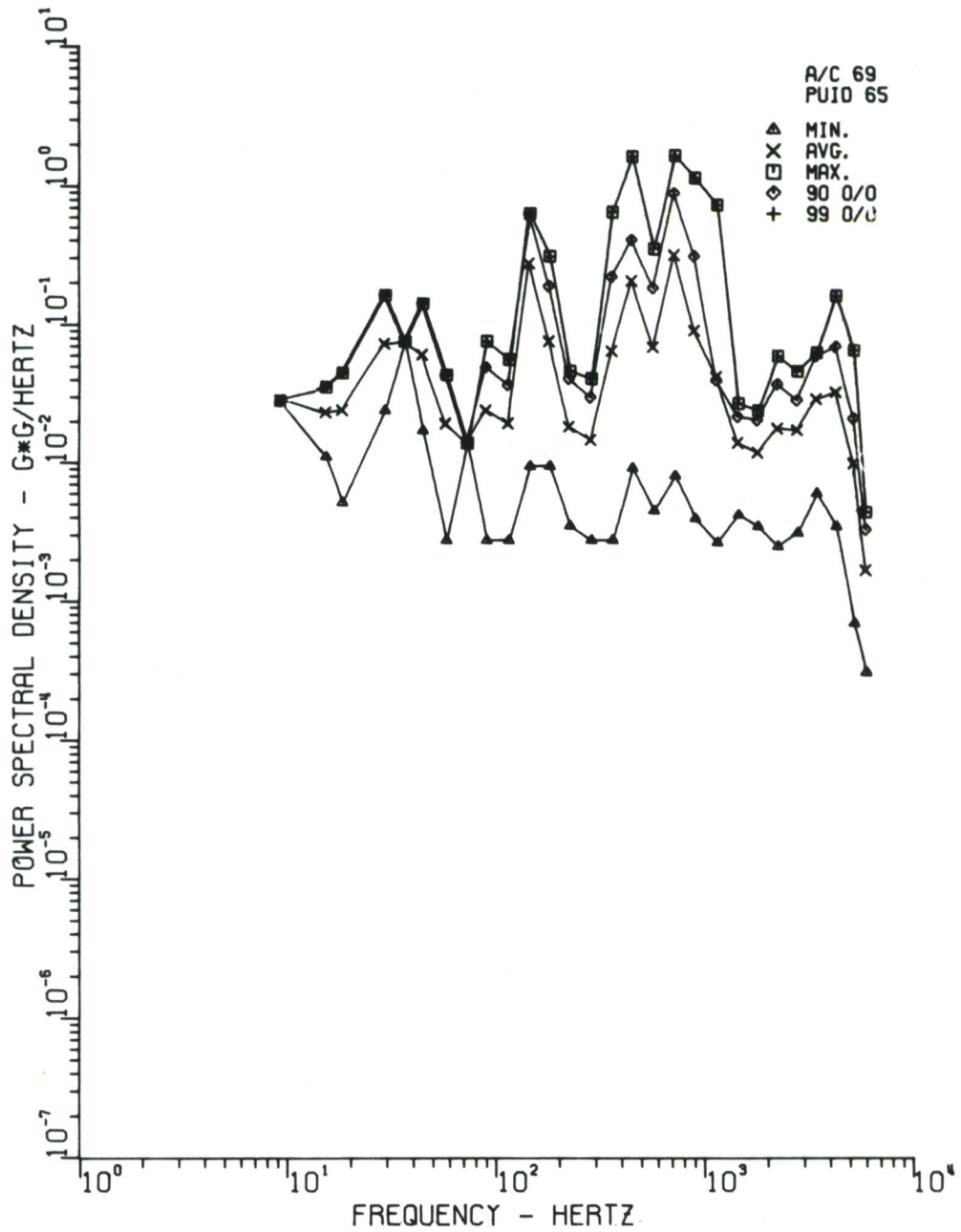

Figure 123. Vertical, Lateral, and Fore and Aft, ADF Antenna Interface, Sta. 69, with Gunfire

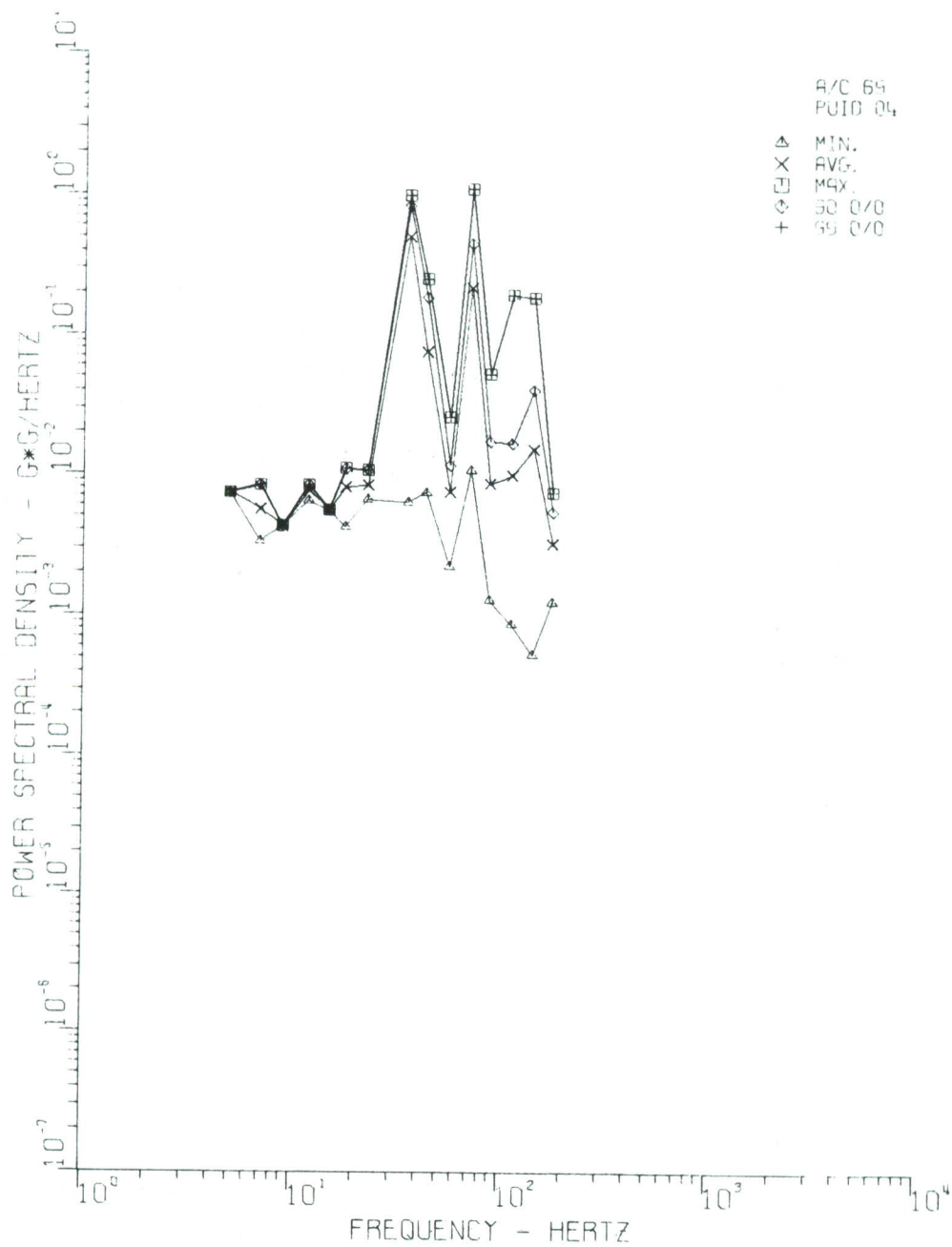

Figure 124. Vertical, Lateral, and Fore and Aft, Instrument Panel, Left Side, Sta. 43, with Gunfire

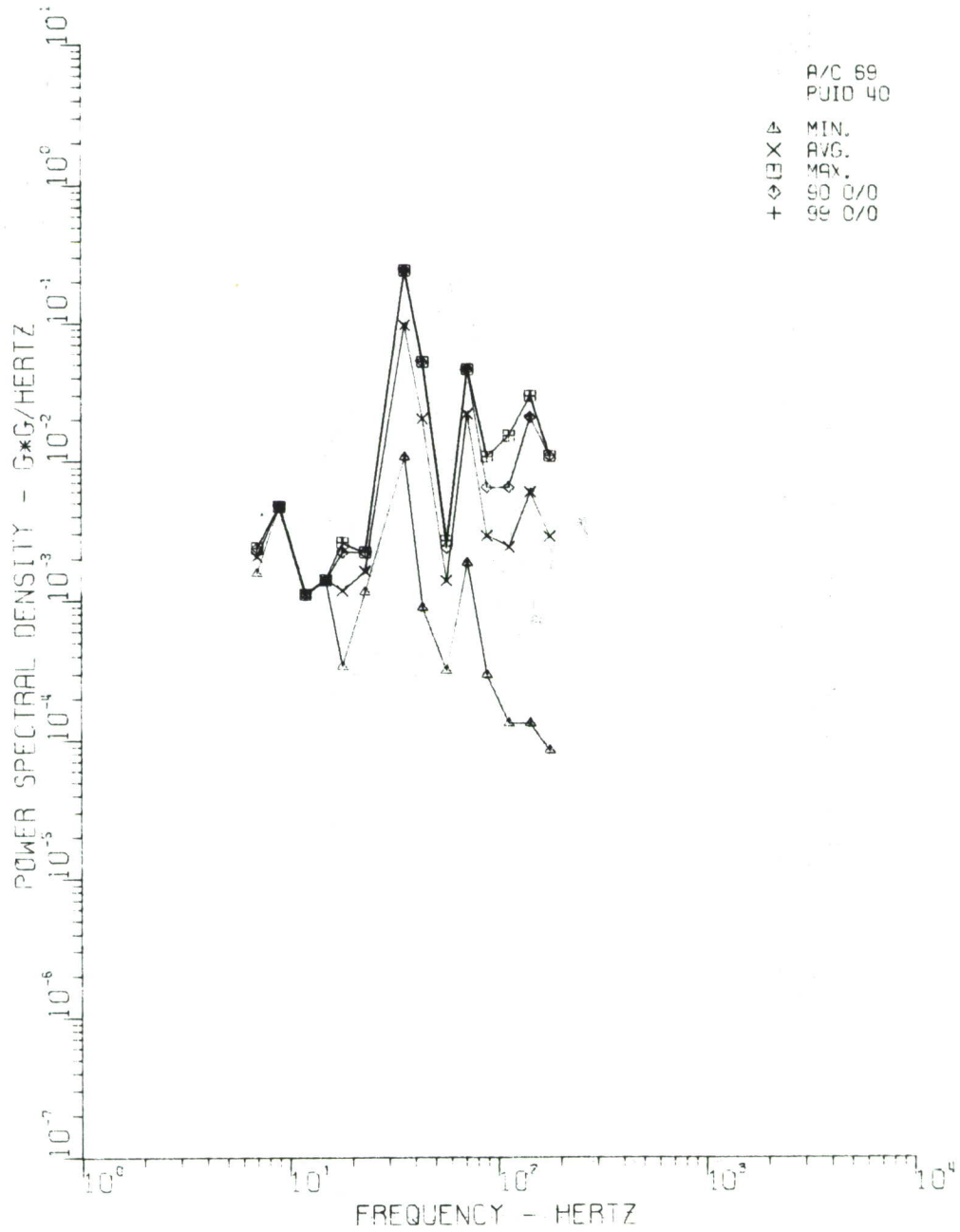

Figure 125. Vertical, Lateral, Instrument Panel Base, Left Side, Sta. 39, with Gunfire

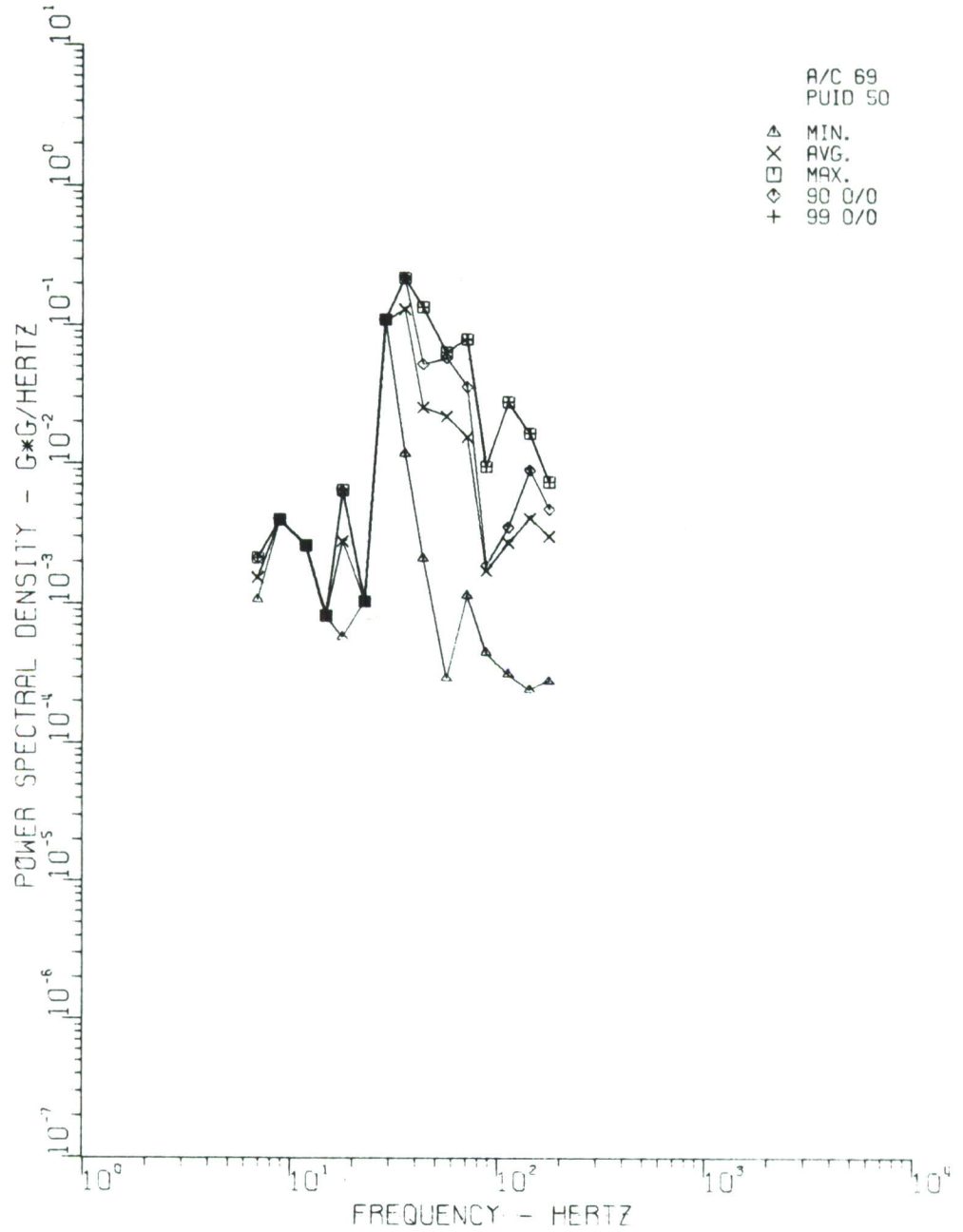

Figure 126. Vertical and Lateral, Cabin Floor, Right Side, Sta. 90, with Gunfire

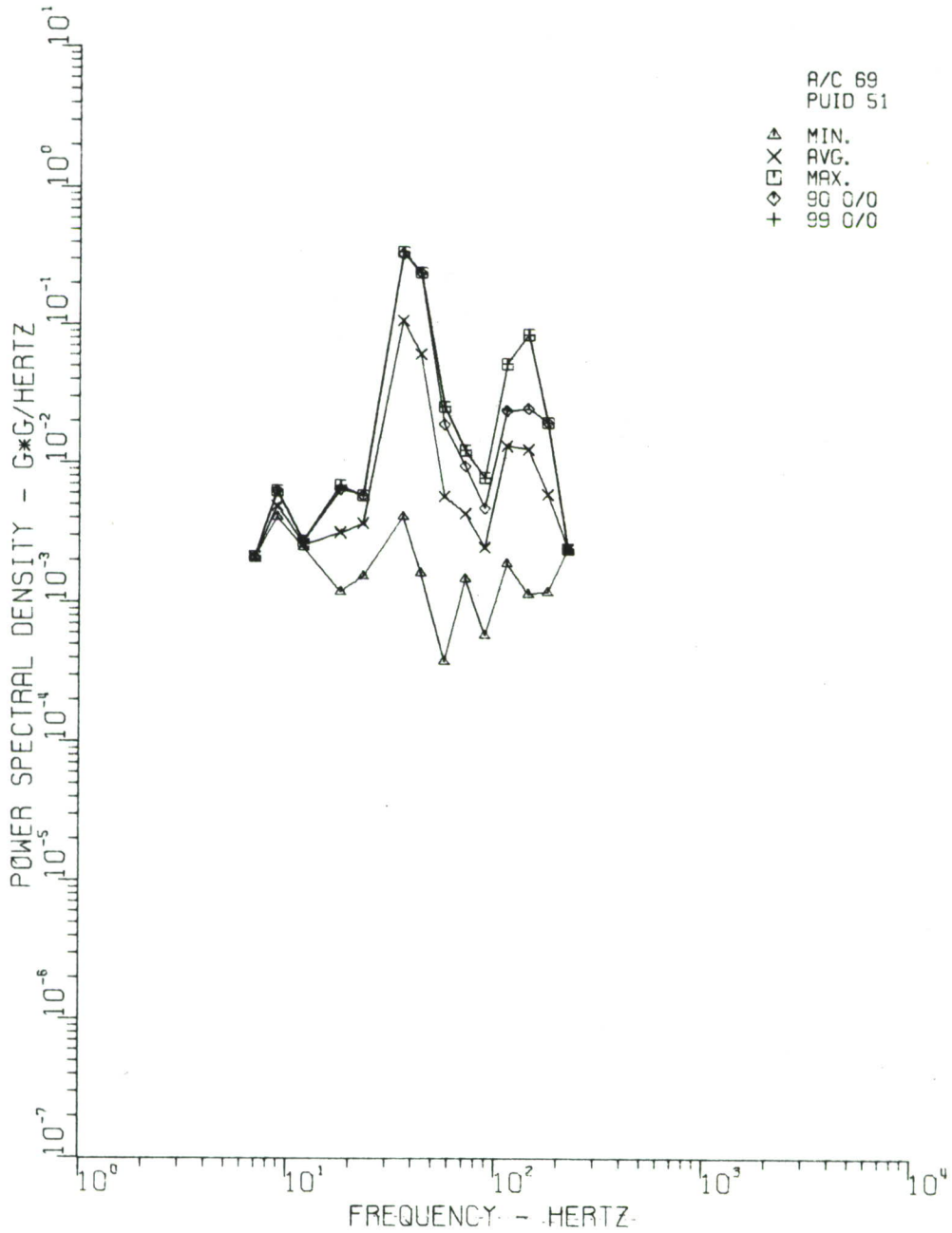

Figure 127. Vertical, and Lateral, Fuselage-tail Section Interface, Sta. 130, with Gunfire

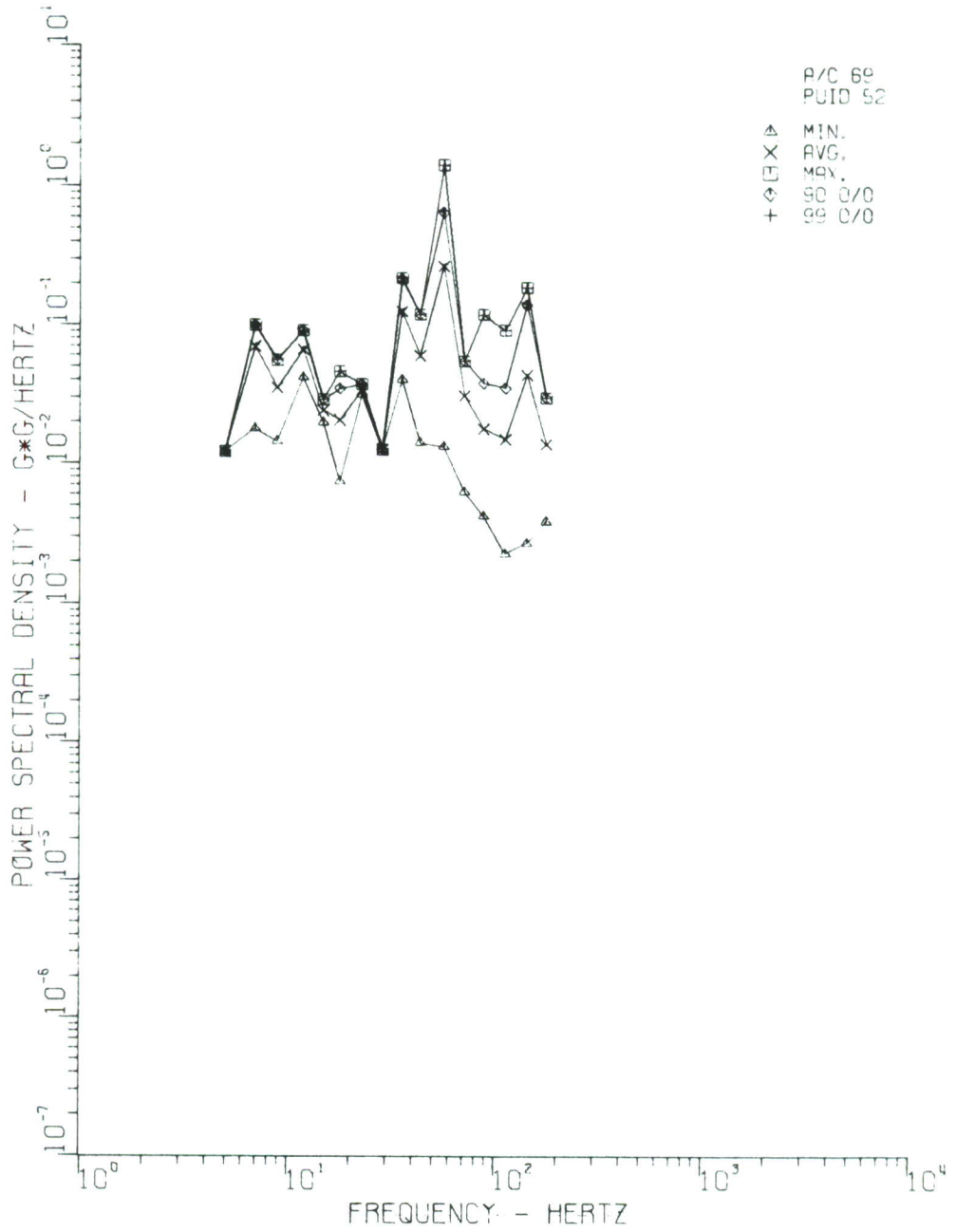

Figure 128. Vertical and Lateral, Tail Section, Near 90° Gear Box, Sta. 273, with Gunfire

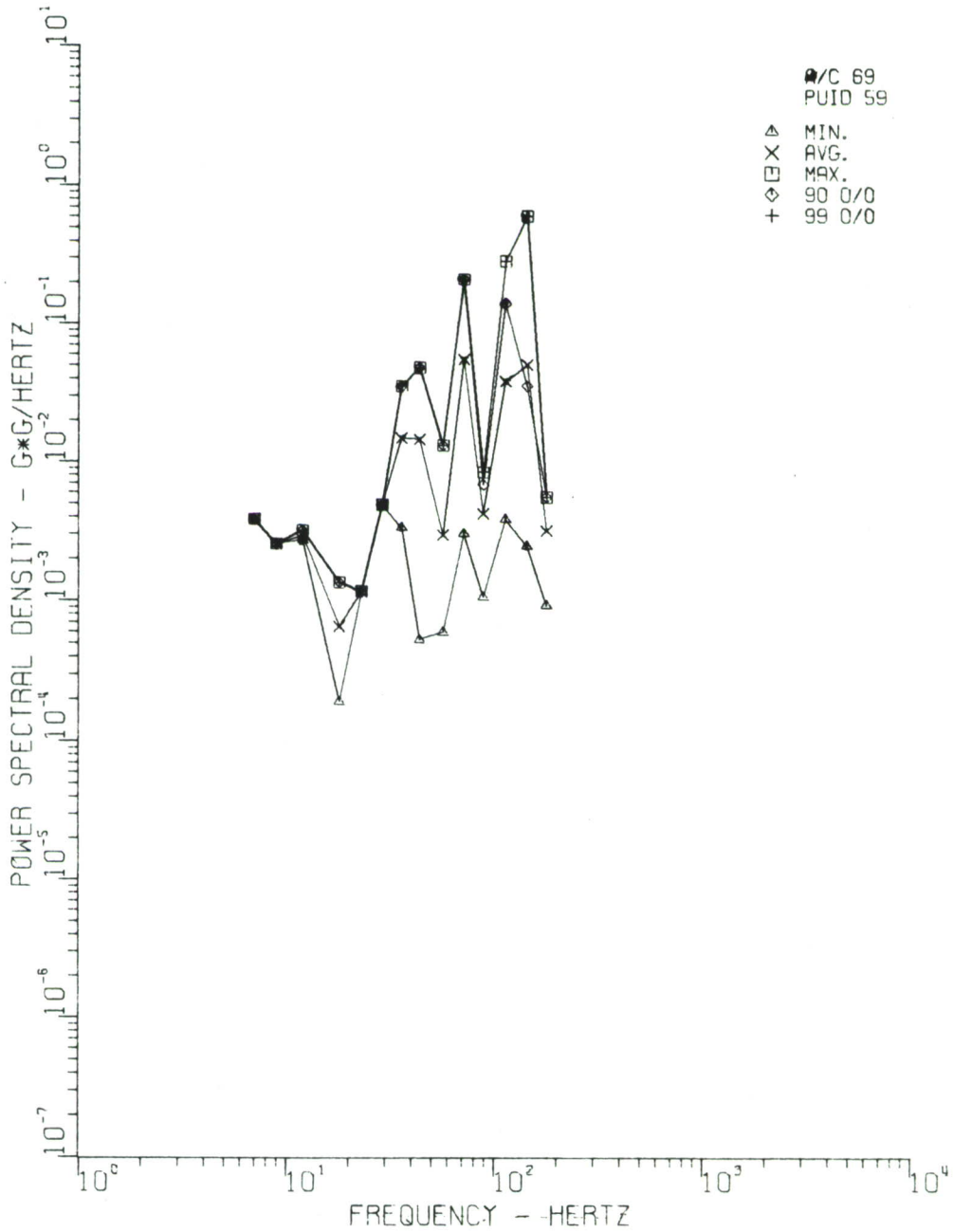

Figure 129. Vertical, Cabin Floor, Left Side, Sta. 90, with Gunfire

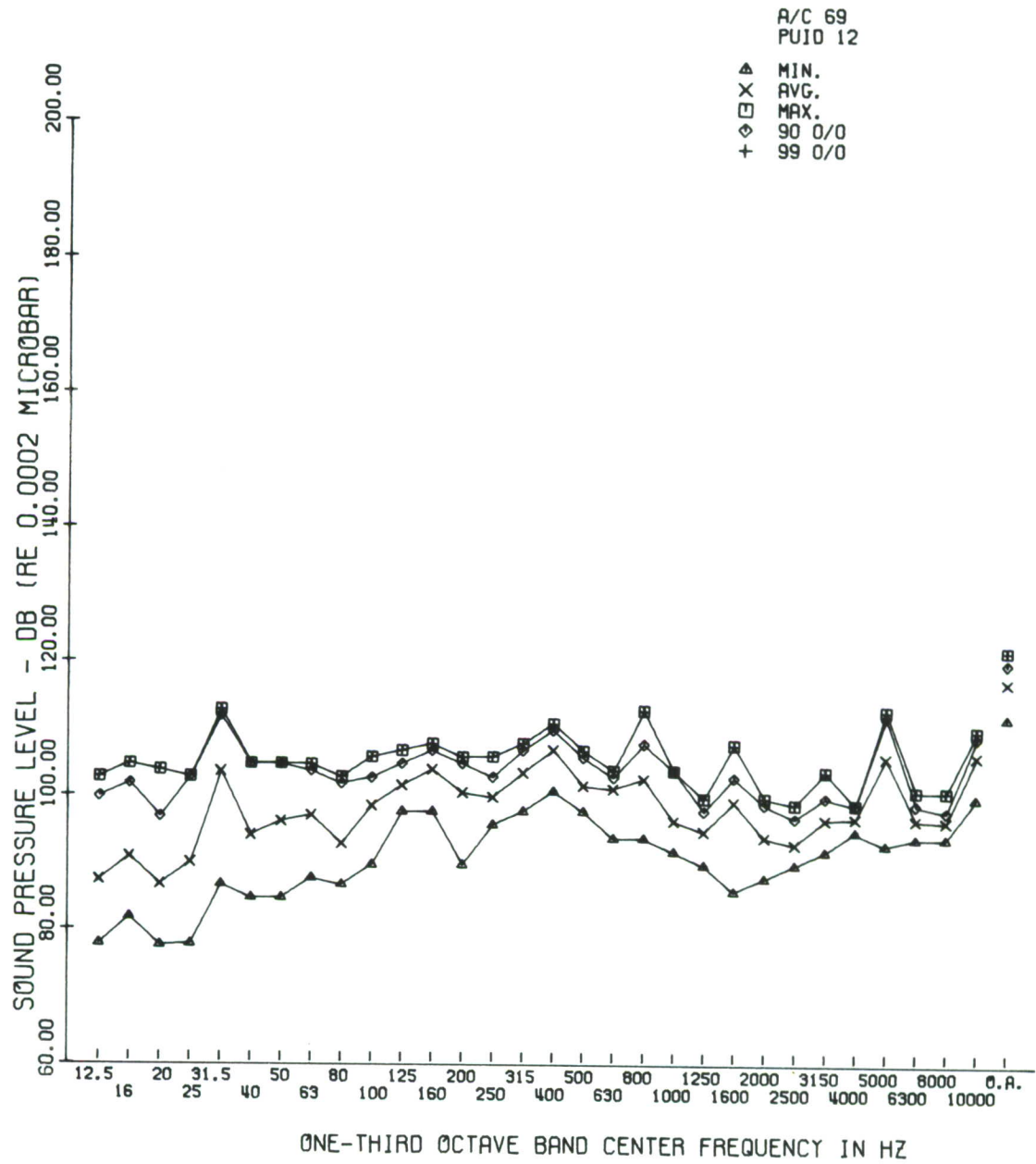

Figure 130. Cabin Firewall, Right Side, Sta. 122, without Gunfire

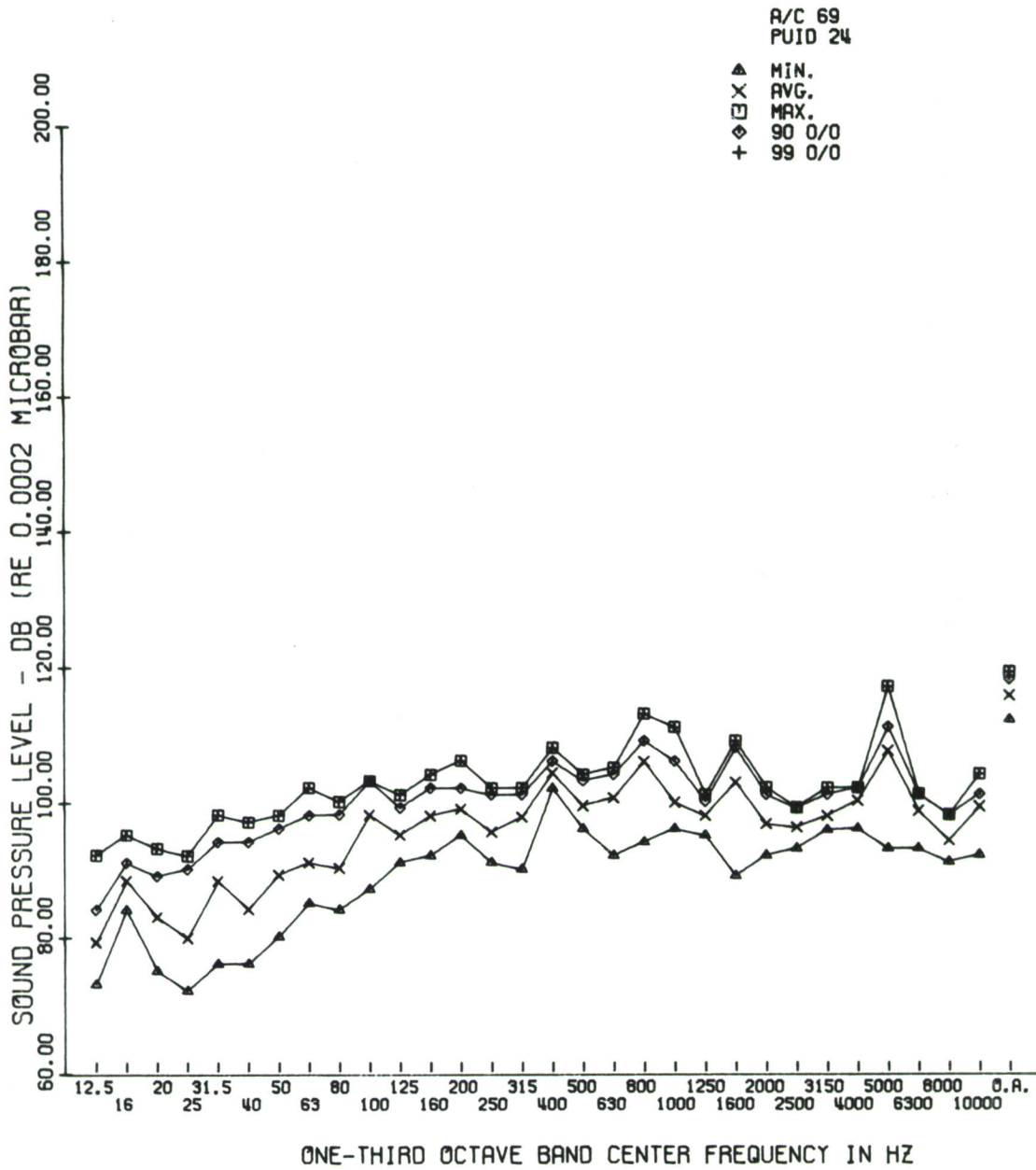

Figure 131. Cabin Firewall, Left Side, Sta. 122, without Gunfire

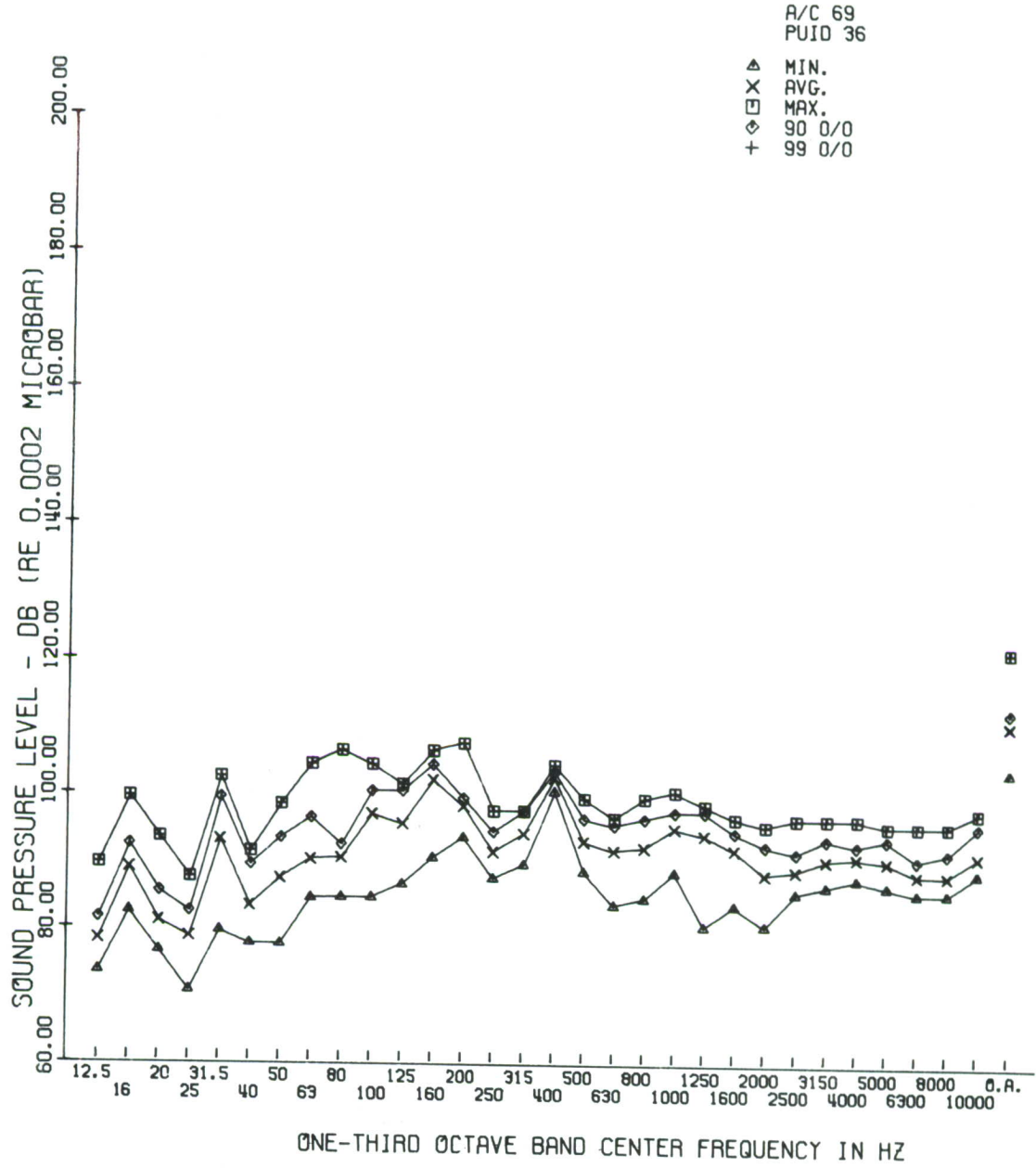

Figure 132. Electronics Comp., Right Side, Sta. 66, without Gunfire

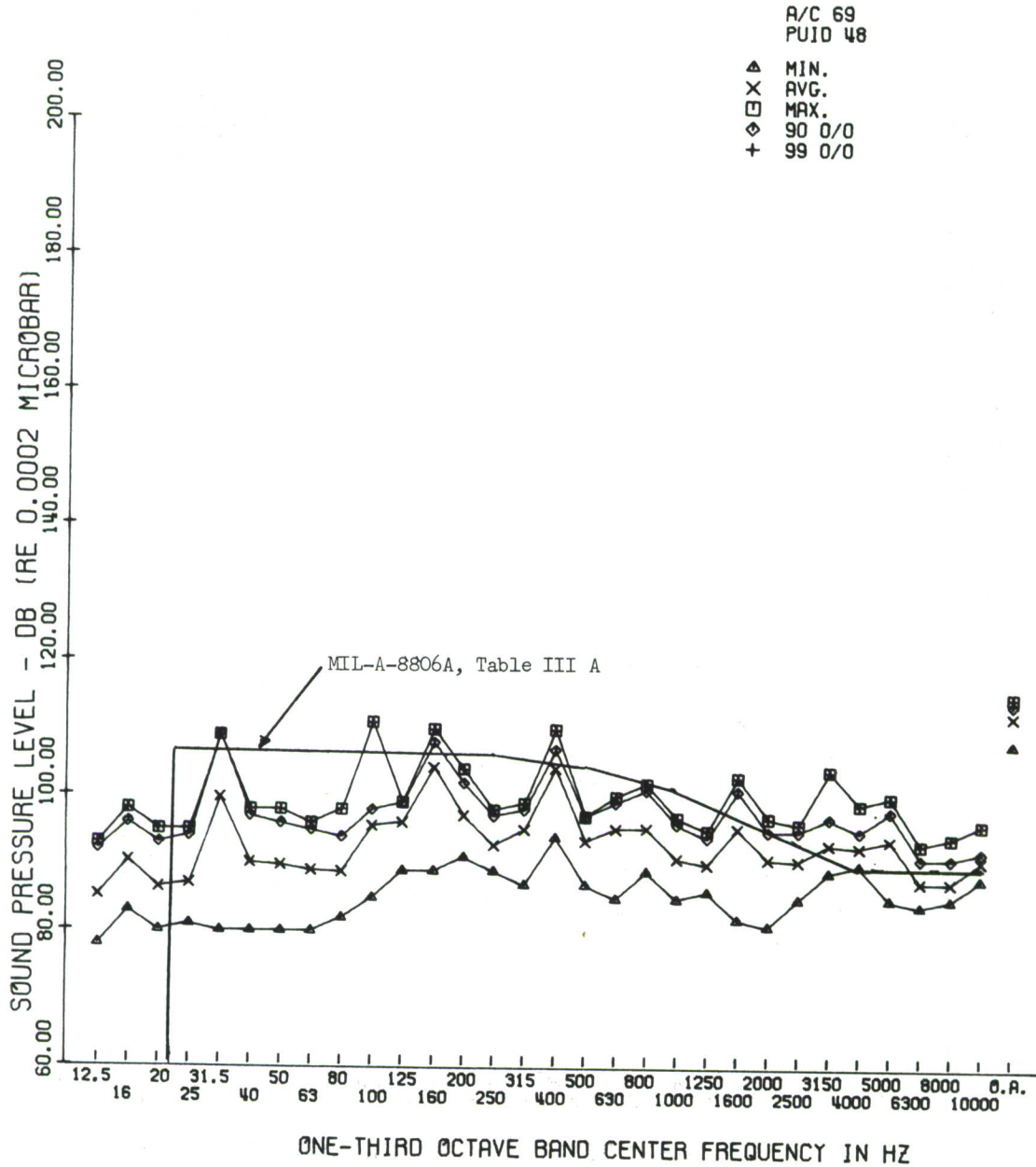

Figure 133. Pilot's Helmet, Right Side, Sta. 72, without Gunfire

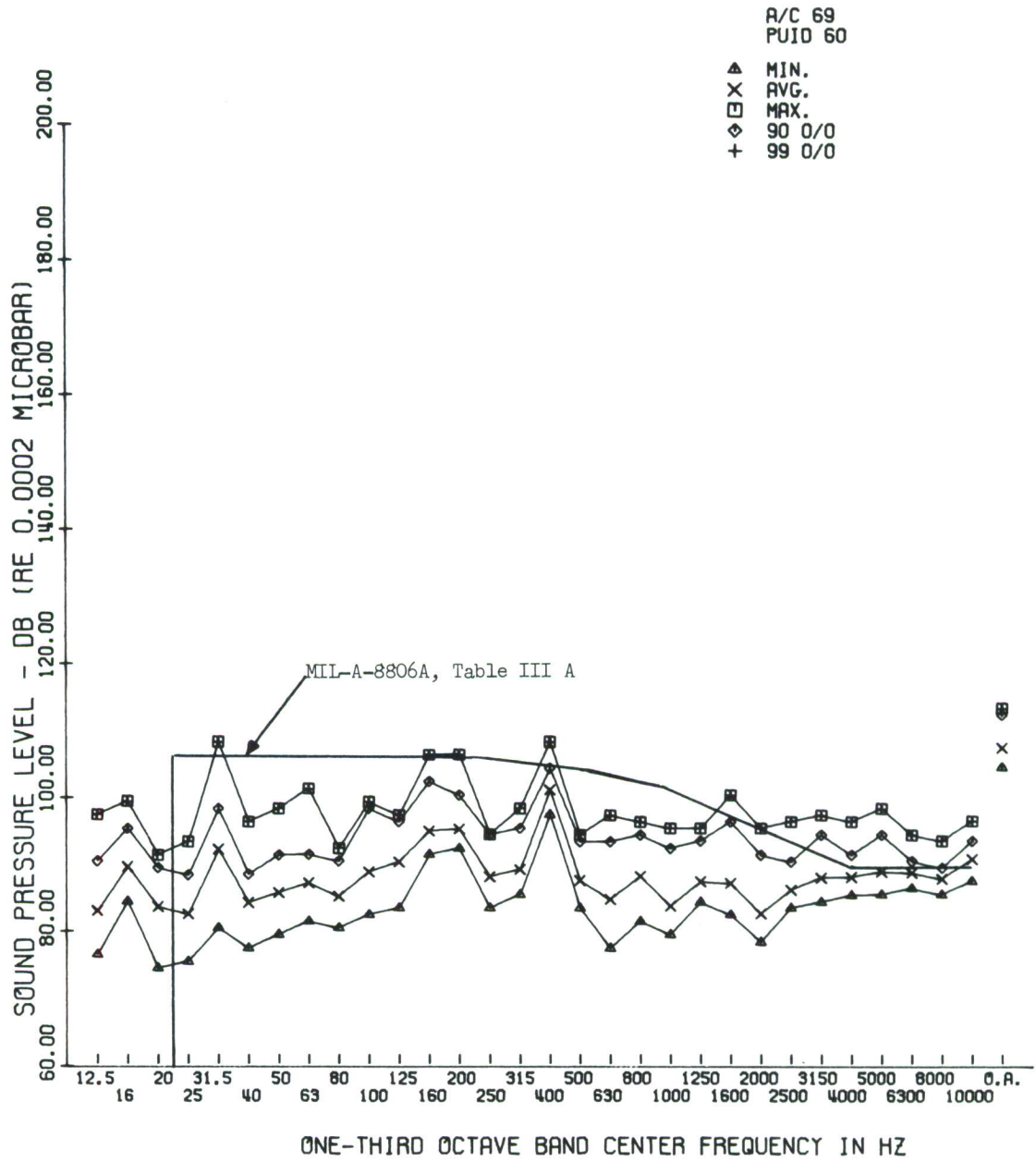

Figure 134. Copilot's Helmet, Left Side, Sta. 72, without Gunfire

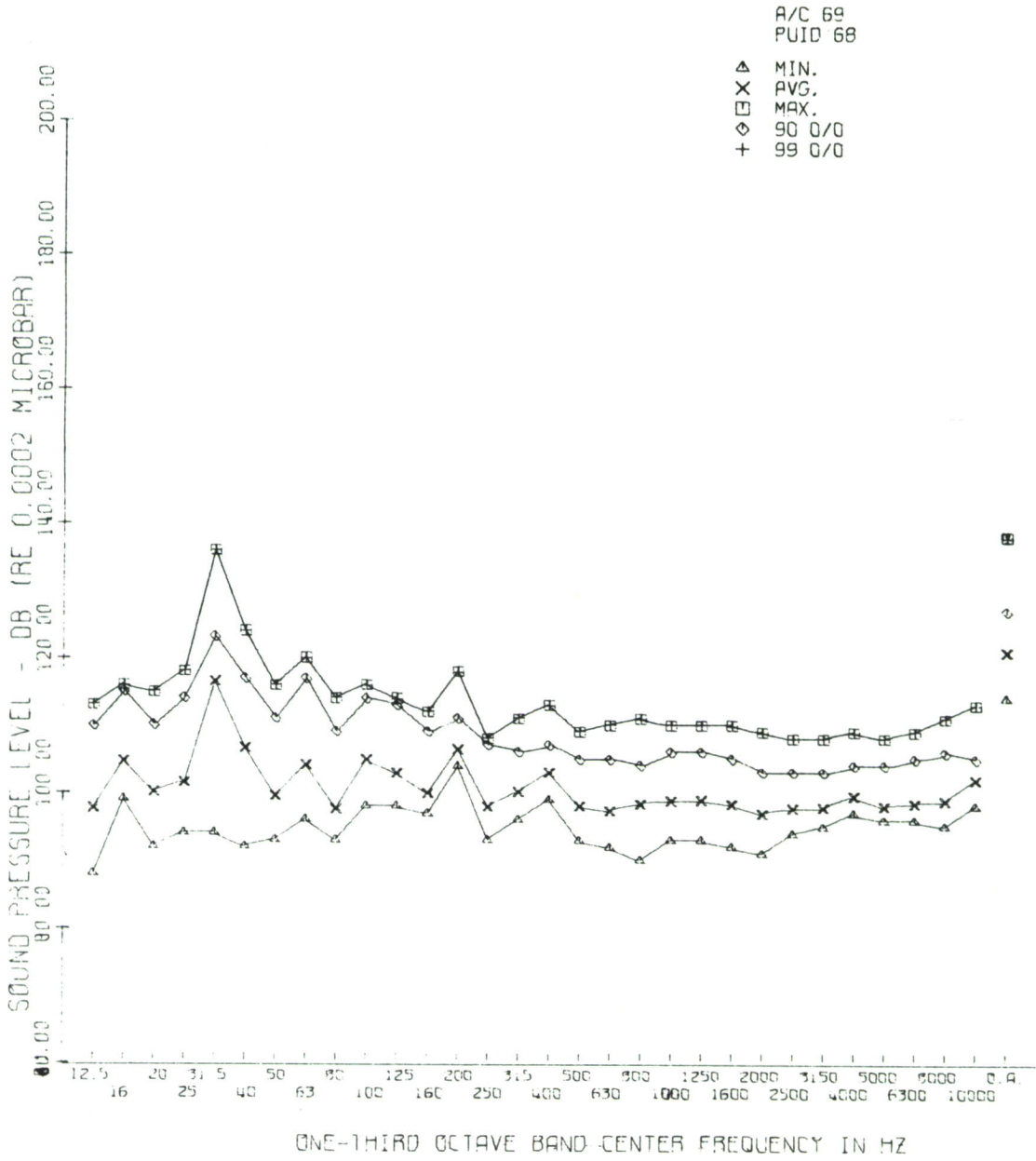

Figure 135. Nose Tip, Outside, Sta. 27, without Gunfire

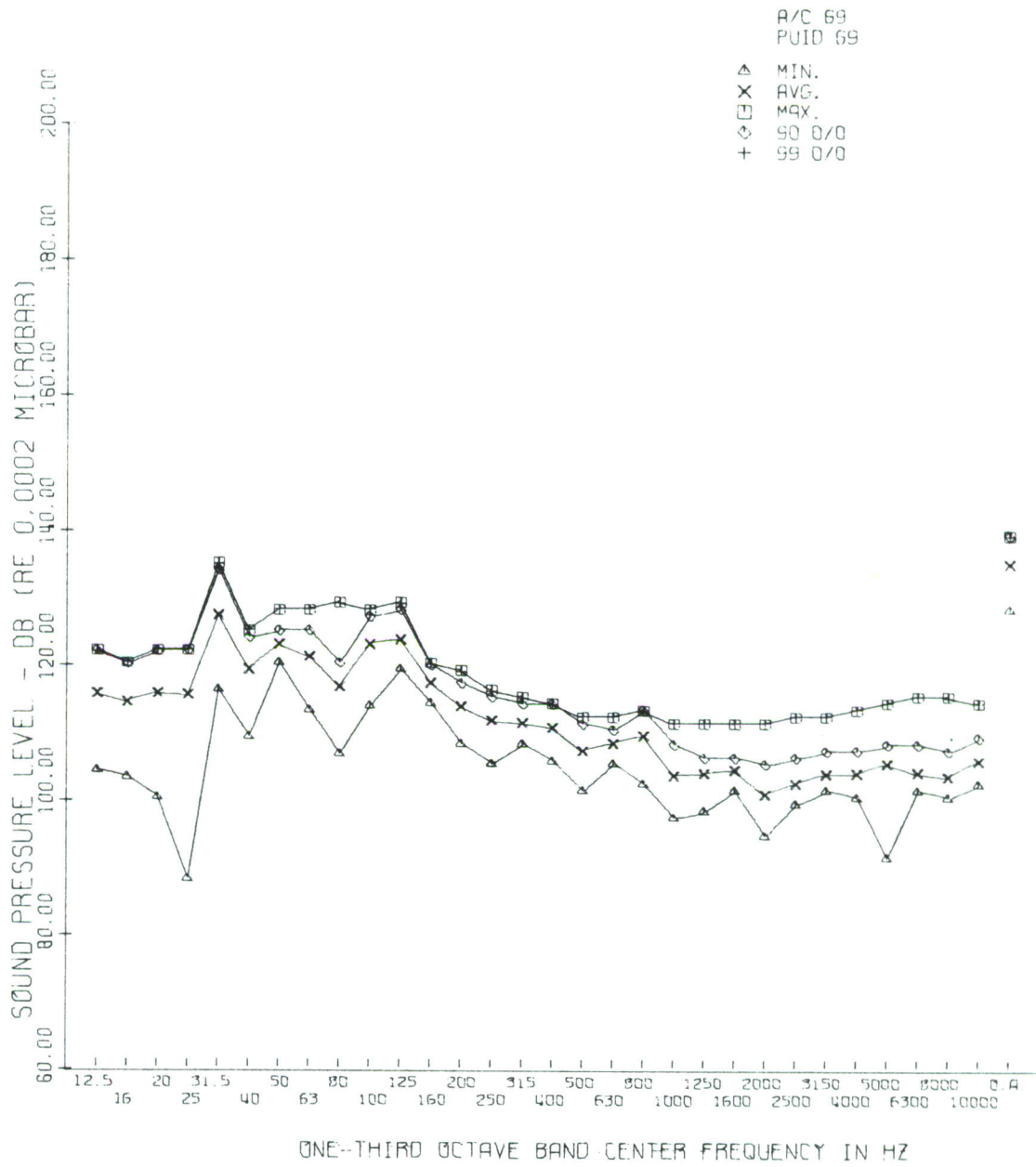

Figure 136. XM-27 Armament Gun Pod, Sta. 90, without Gunfire

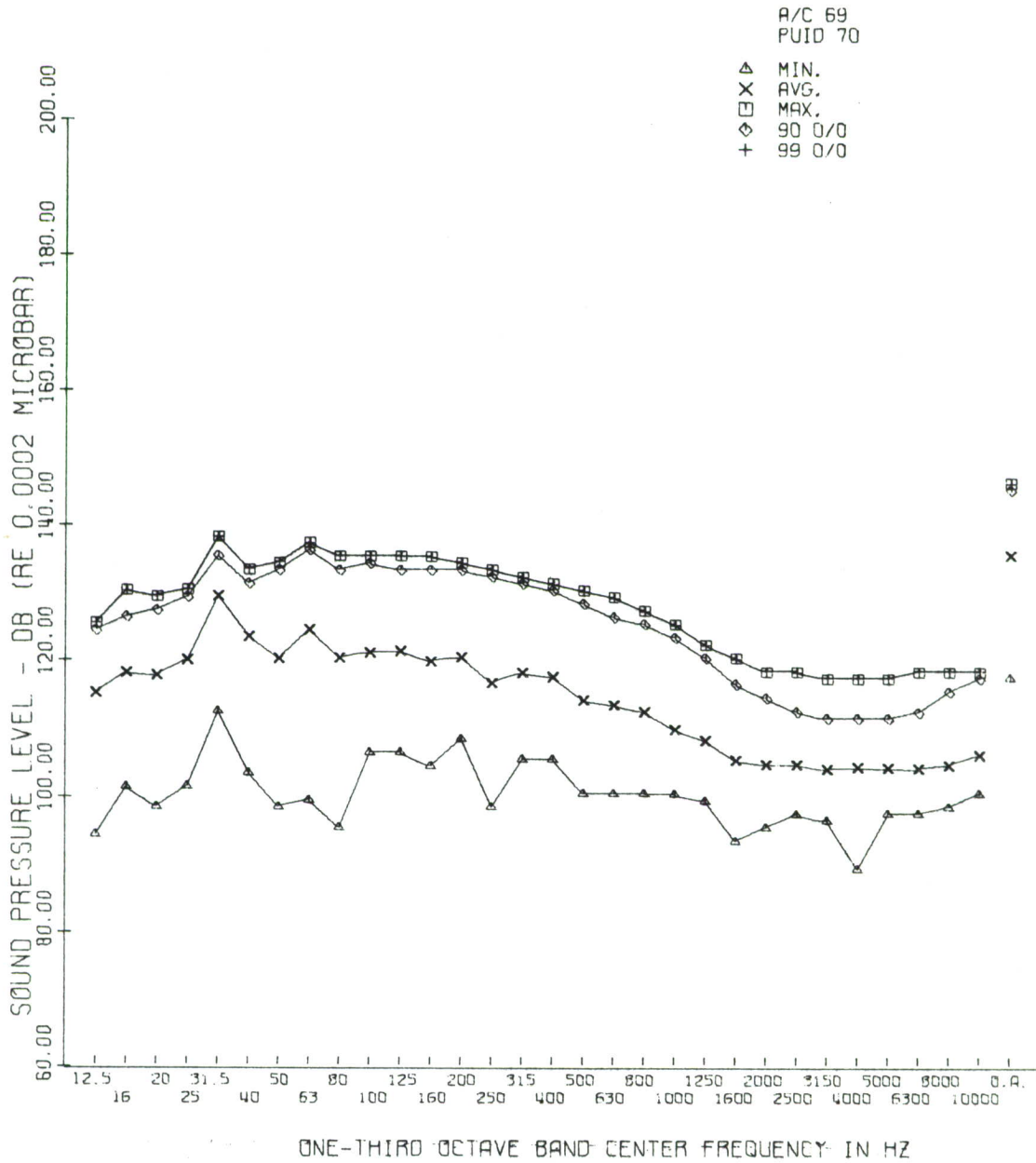

Figure 137. Top of Fuselage, Outside, Sta. 165, without Gunfire

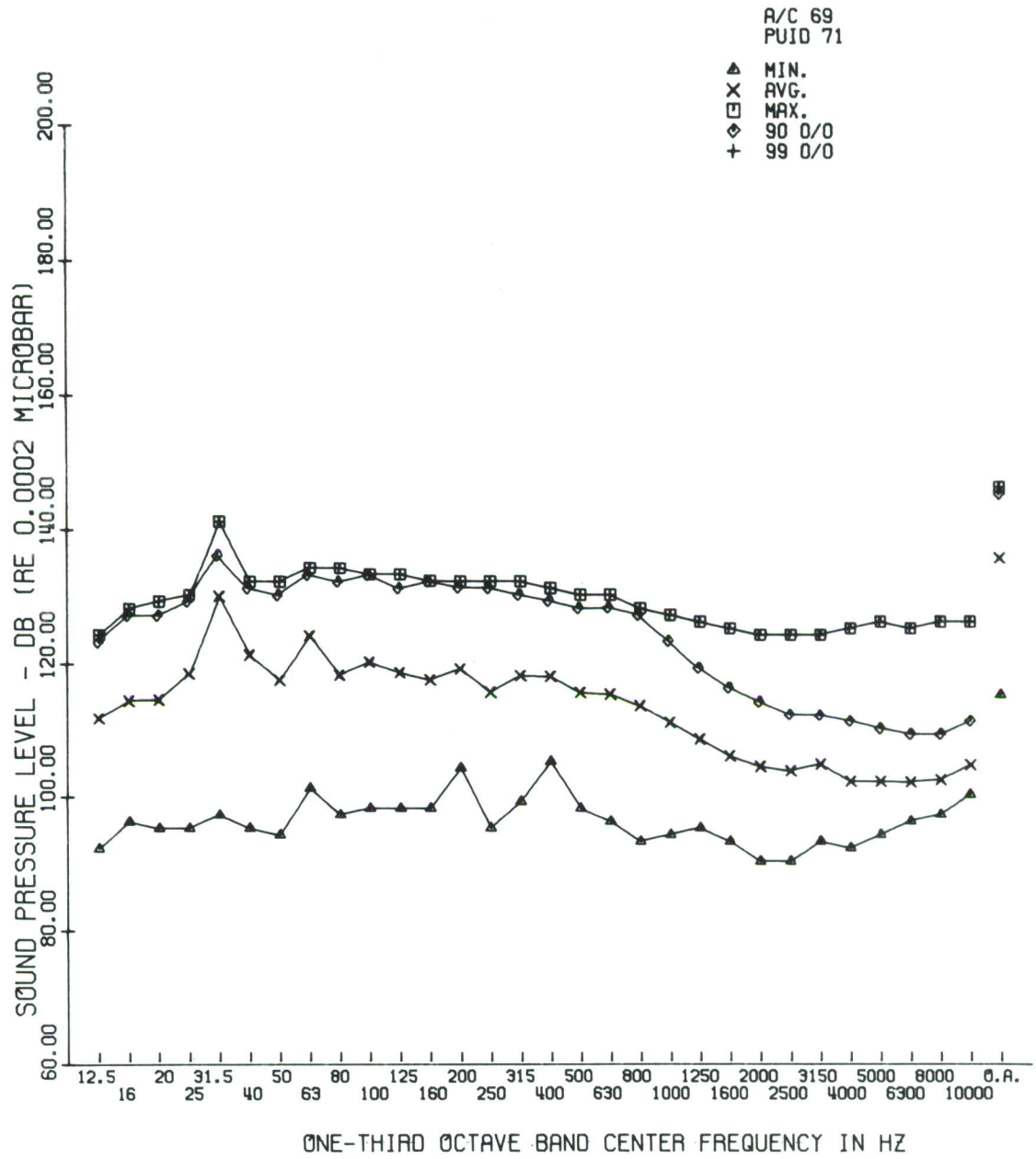

Figure 138. Top of Fuselage, Outside, Sta. 200, without Gunfire

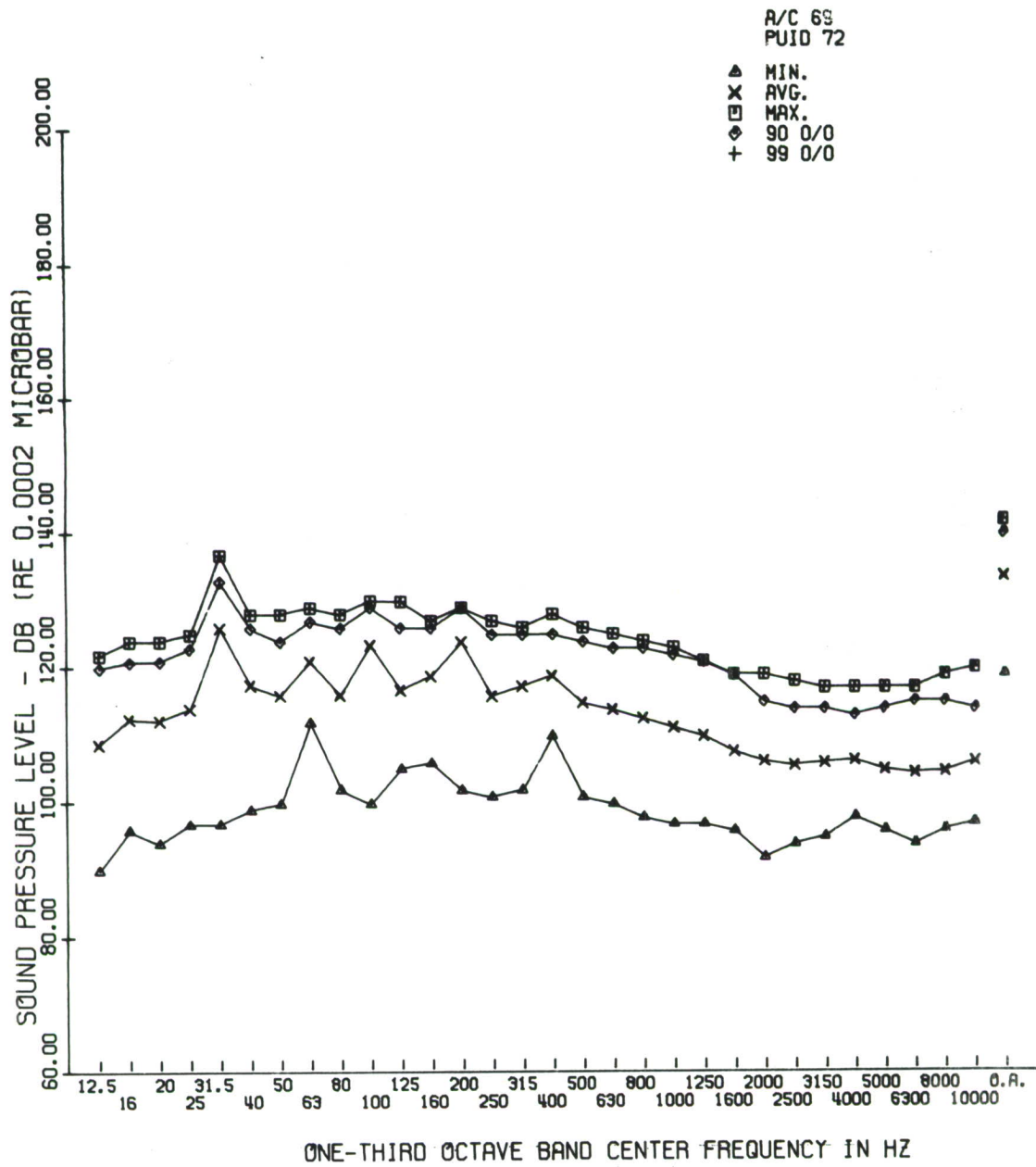

Figure 139. Top of Fuselage, Outside, Sta. 243, without Gunfire

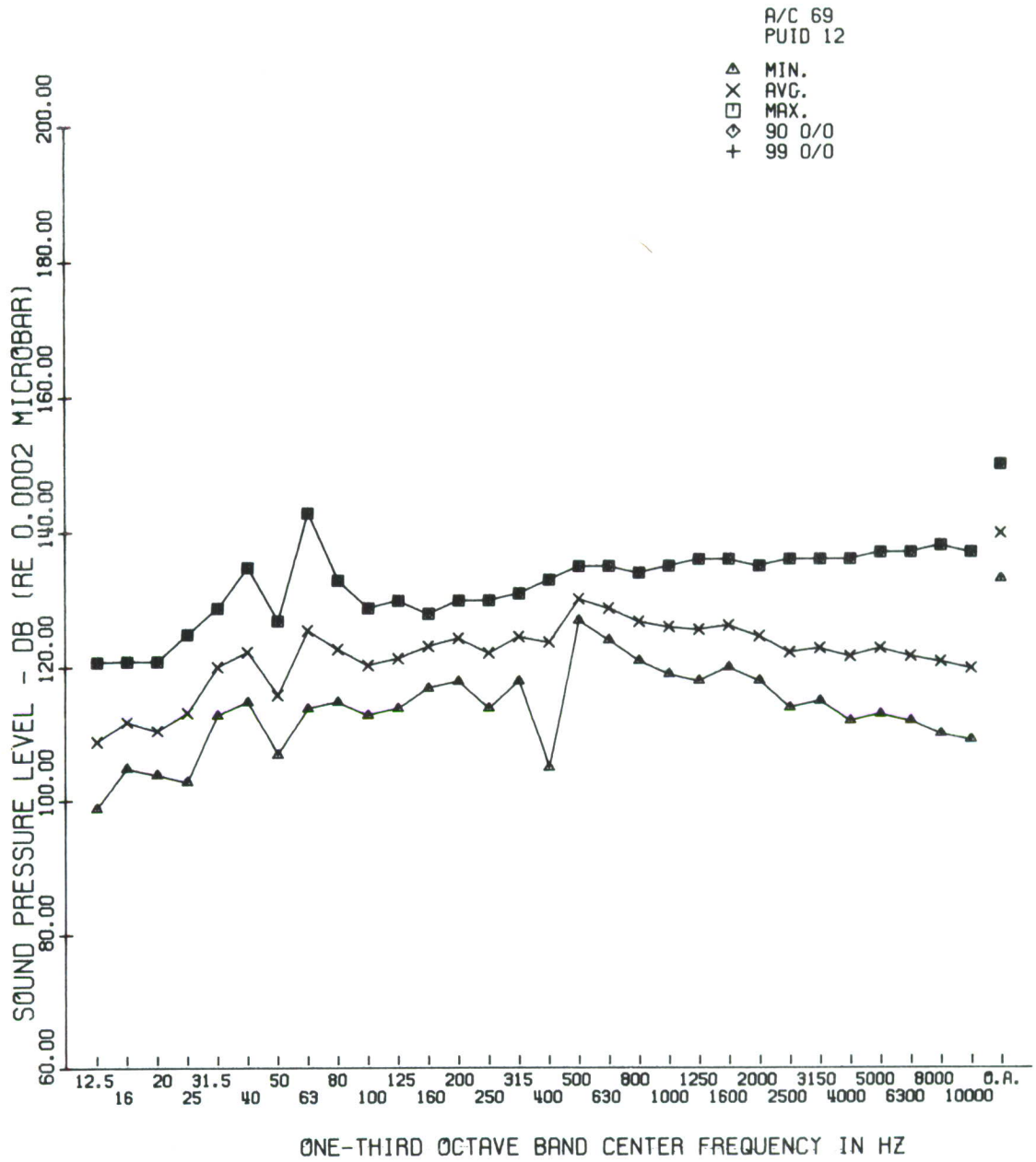

Figure 140. Cabin Firewall, Right Side, Sta.122, with Gunfire

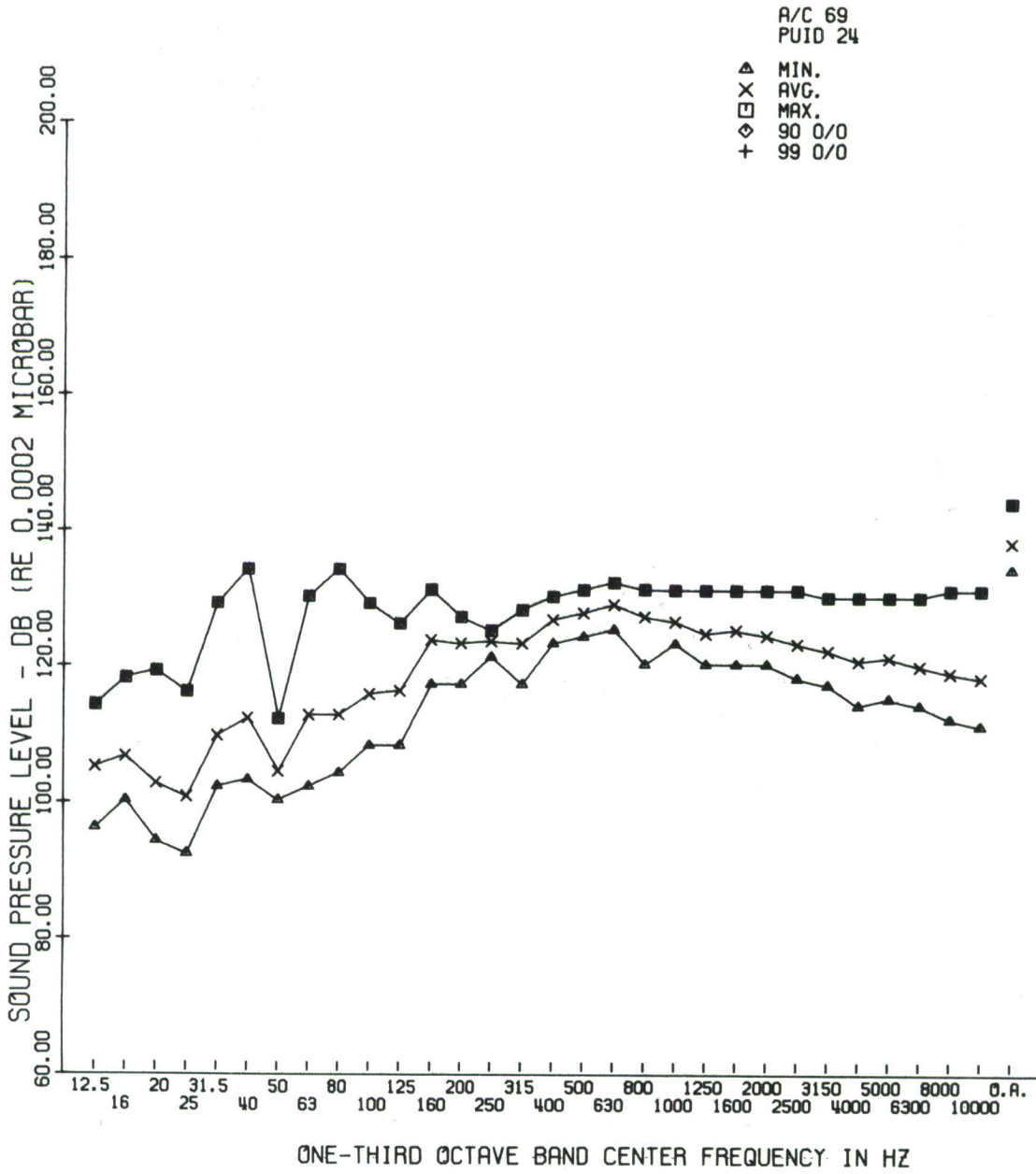

Figure 141. Cabin Firewall, Left Side, Sta. 122, with Gunfire

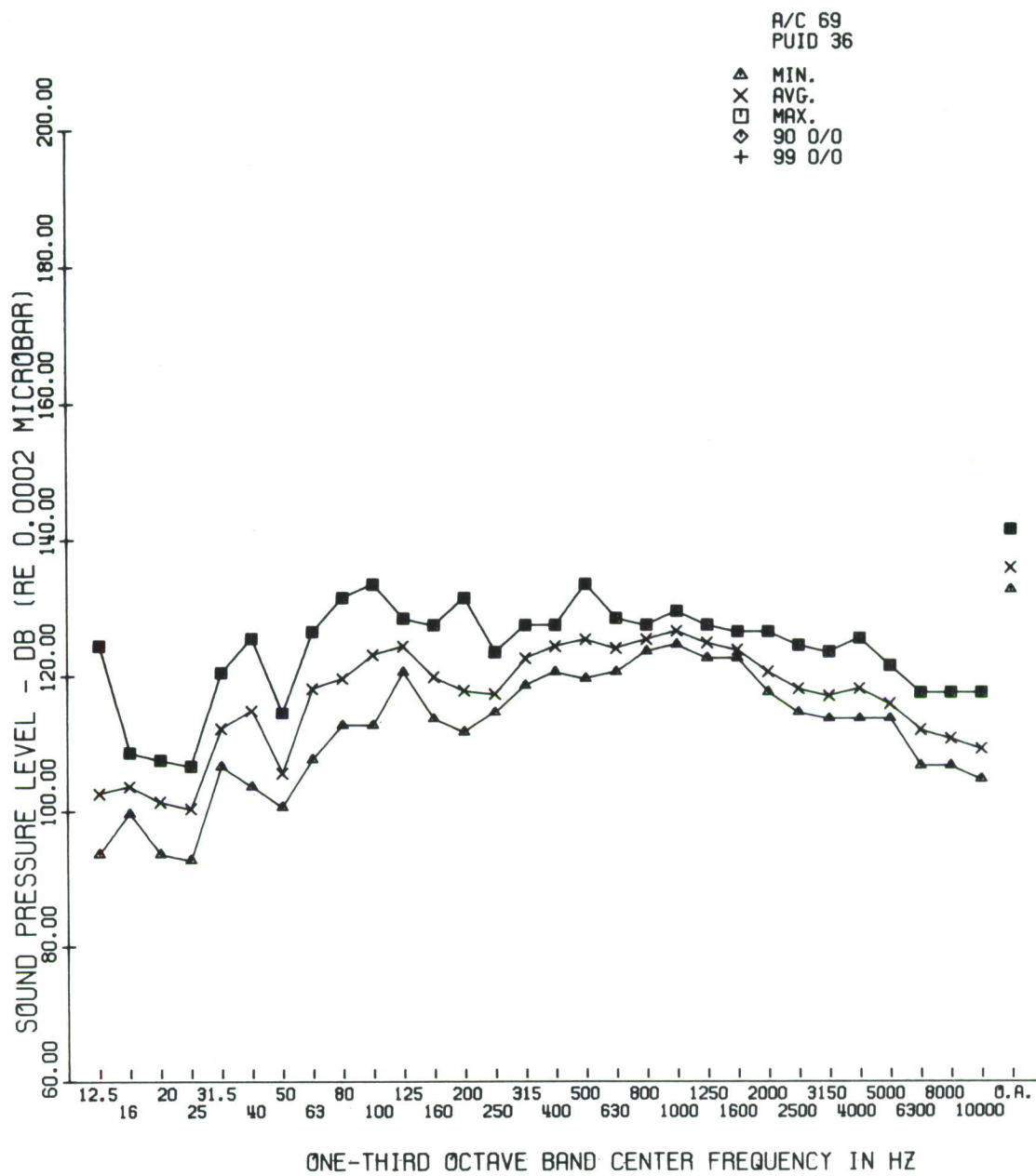

Figure 142. Electronics Comp., Right Side, Sta. 66, with Gunfire

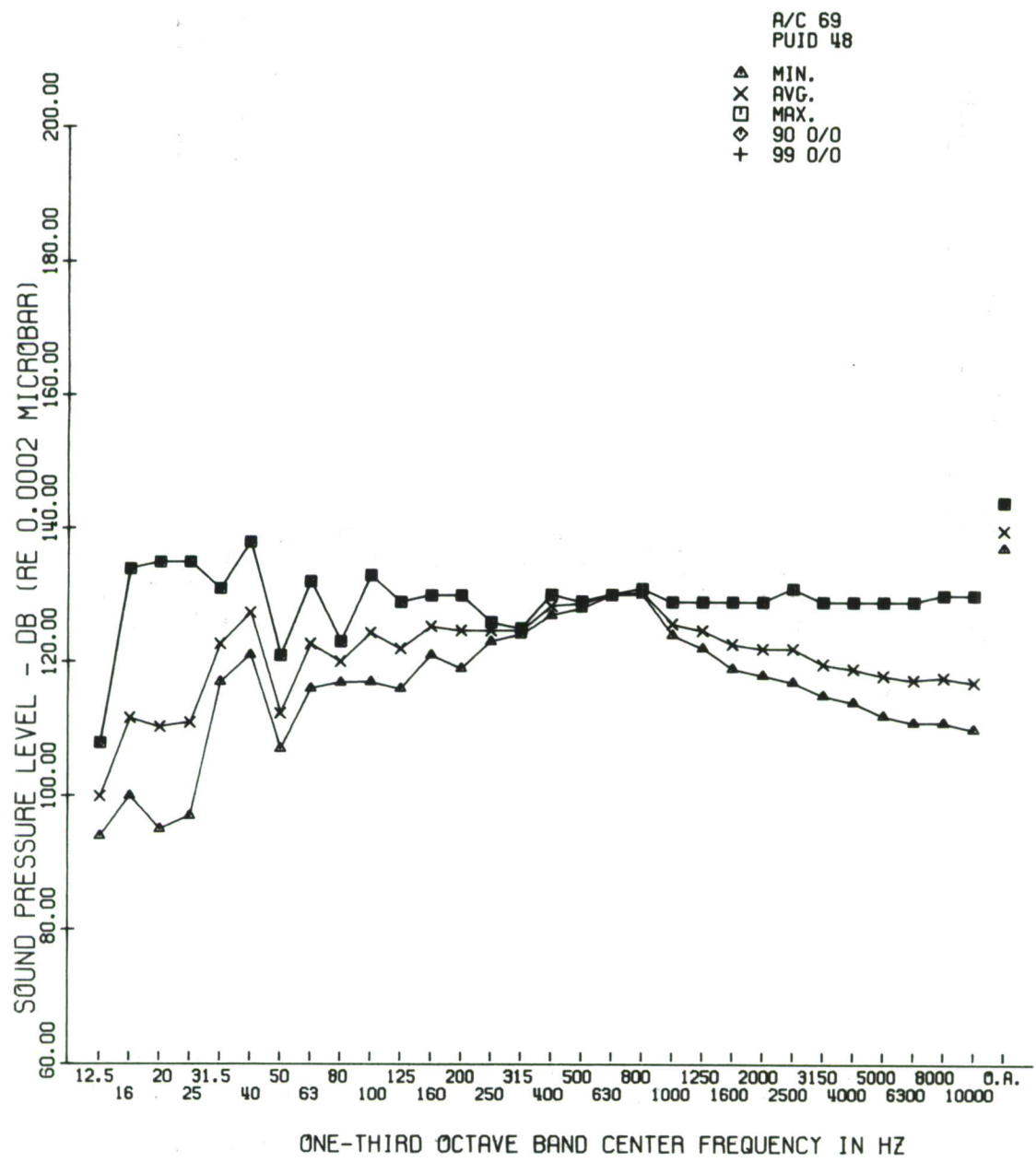

Figure 143. Pilot's Helmet, Right Side, Sta. 72, with Gunfire

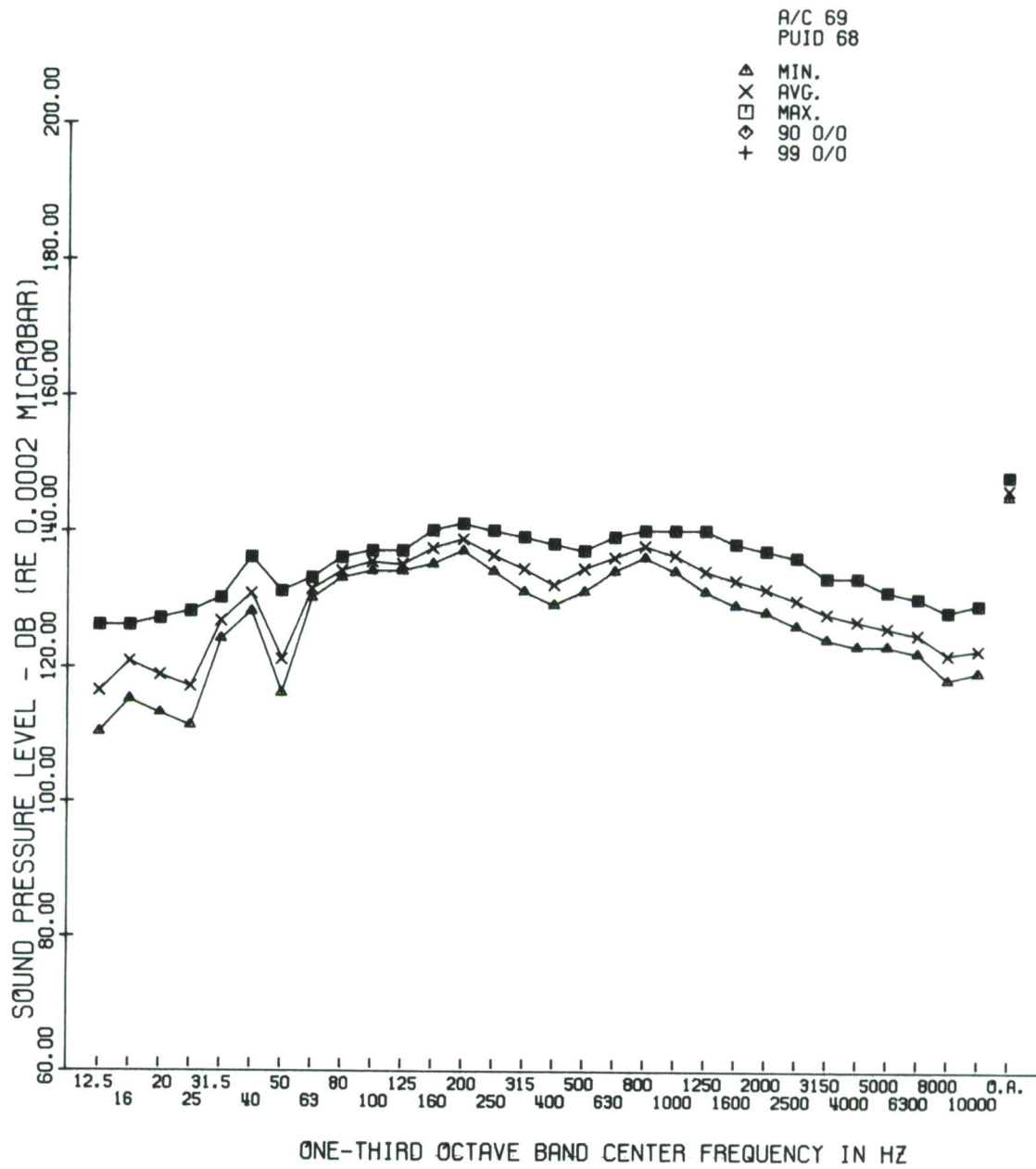

Figure 144. Nose Tip, Outside, Sta. 27, with Gunfire

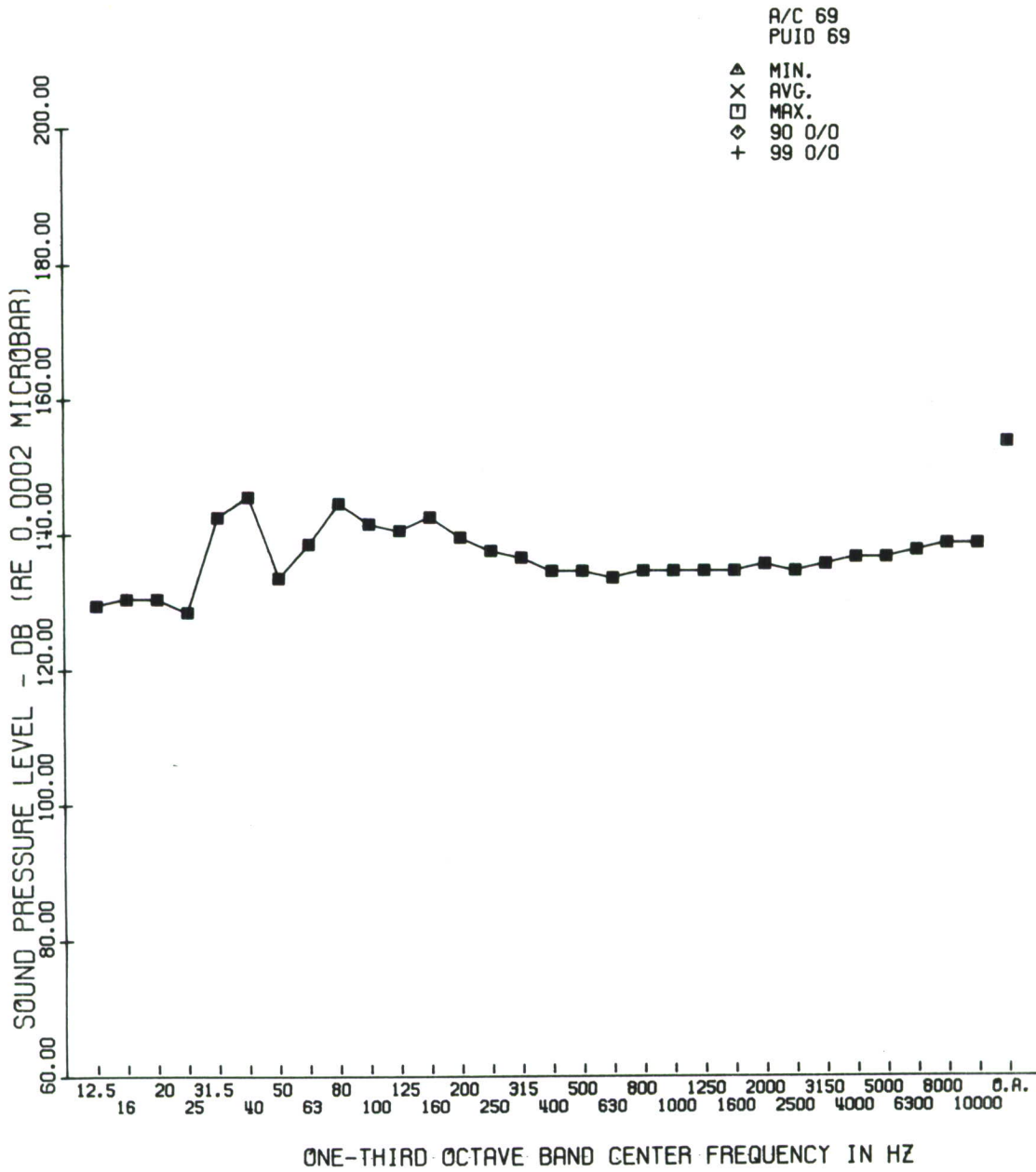

Figure 145. XM-27 Armament Gun Pod, Sta. 90, with Gunfire

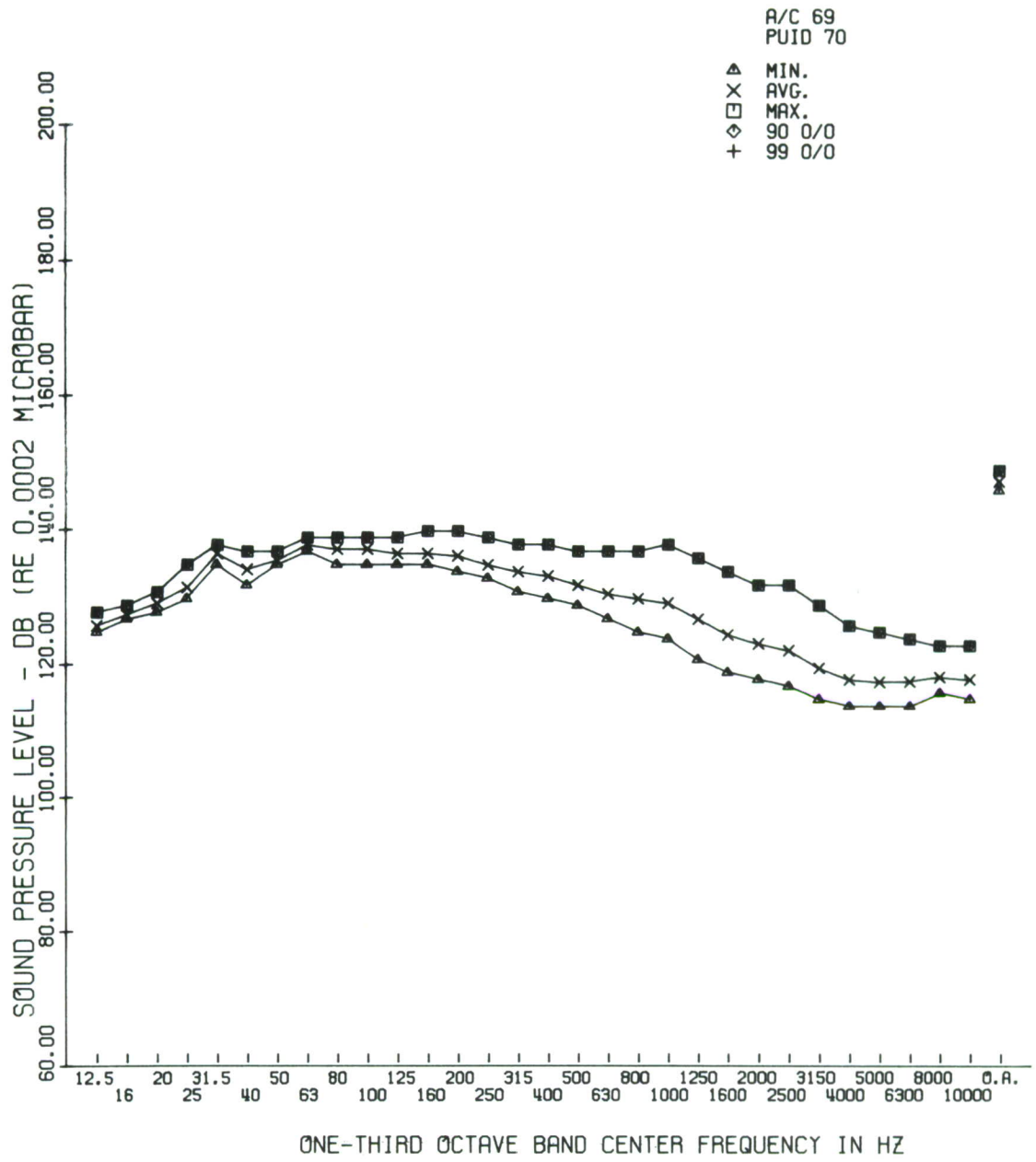

Figure 146. Top of Fuselage, Outside, Sta. 165, with Gunfire

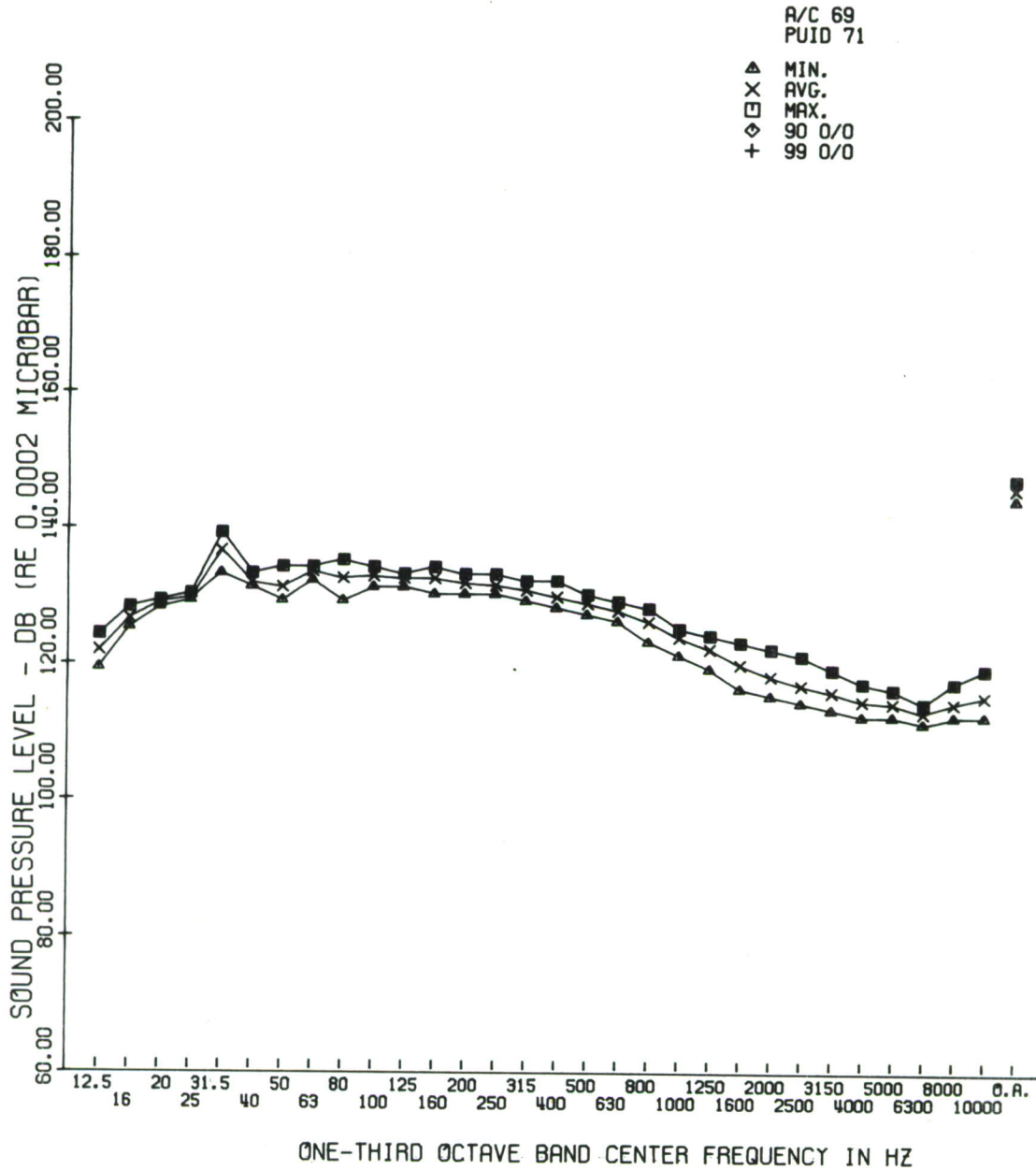

Figure 147. Top of Fuselage, Outside, Sta. 200, with Gunfire

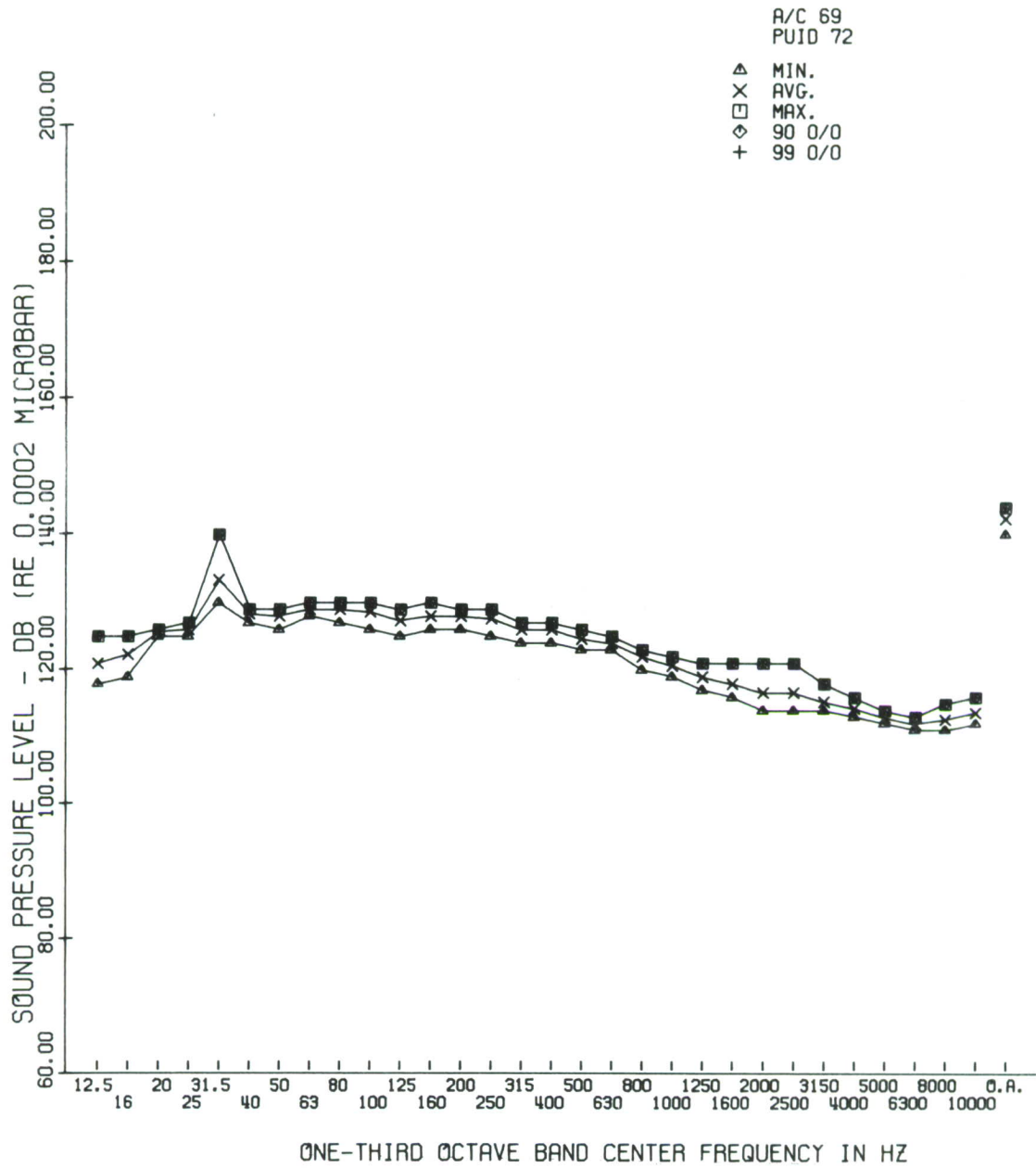

Figure 148. Top of Fuselage, Outside, Sta. 243, with Gunfire

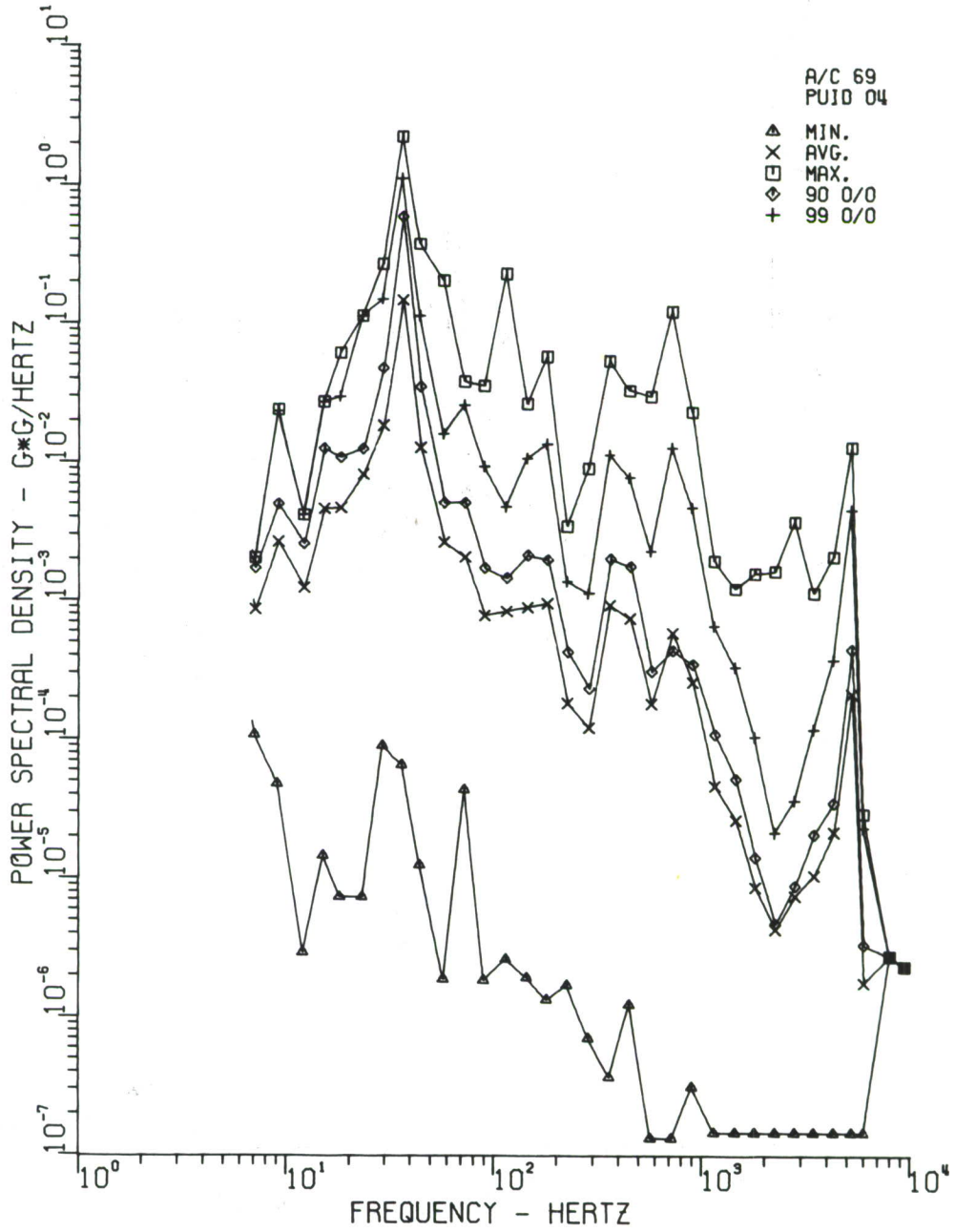

Figure 149. Nose Section and Cockpit, without Gunfire

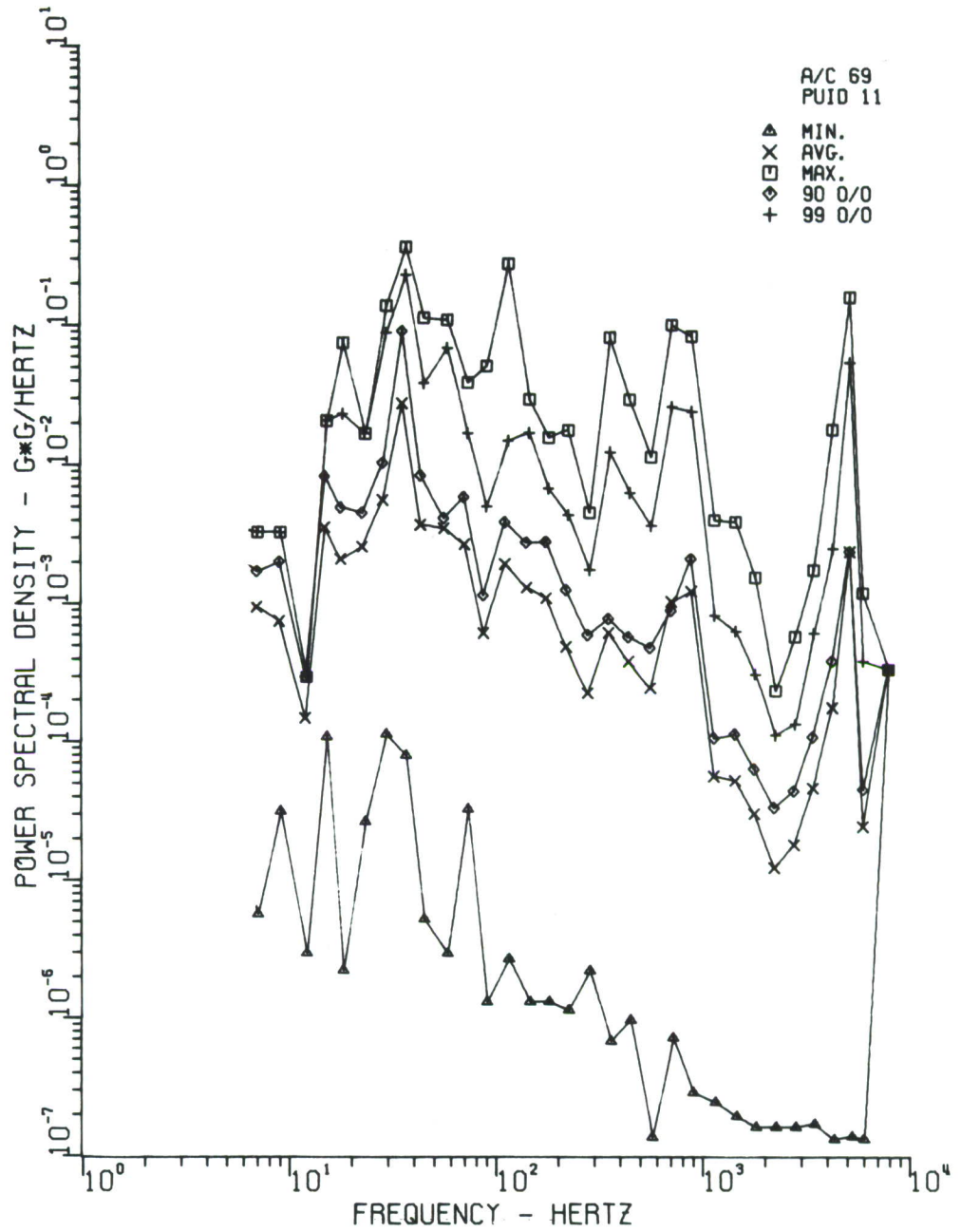

Figure 150. Passenger Compartment, without Gunfire

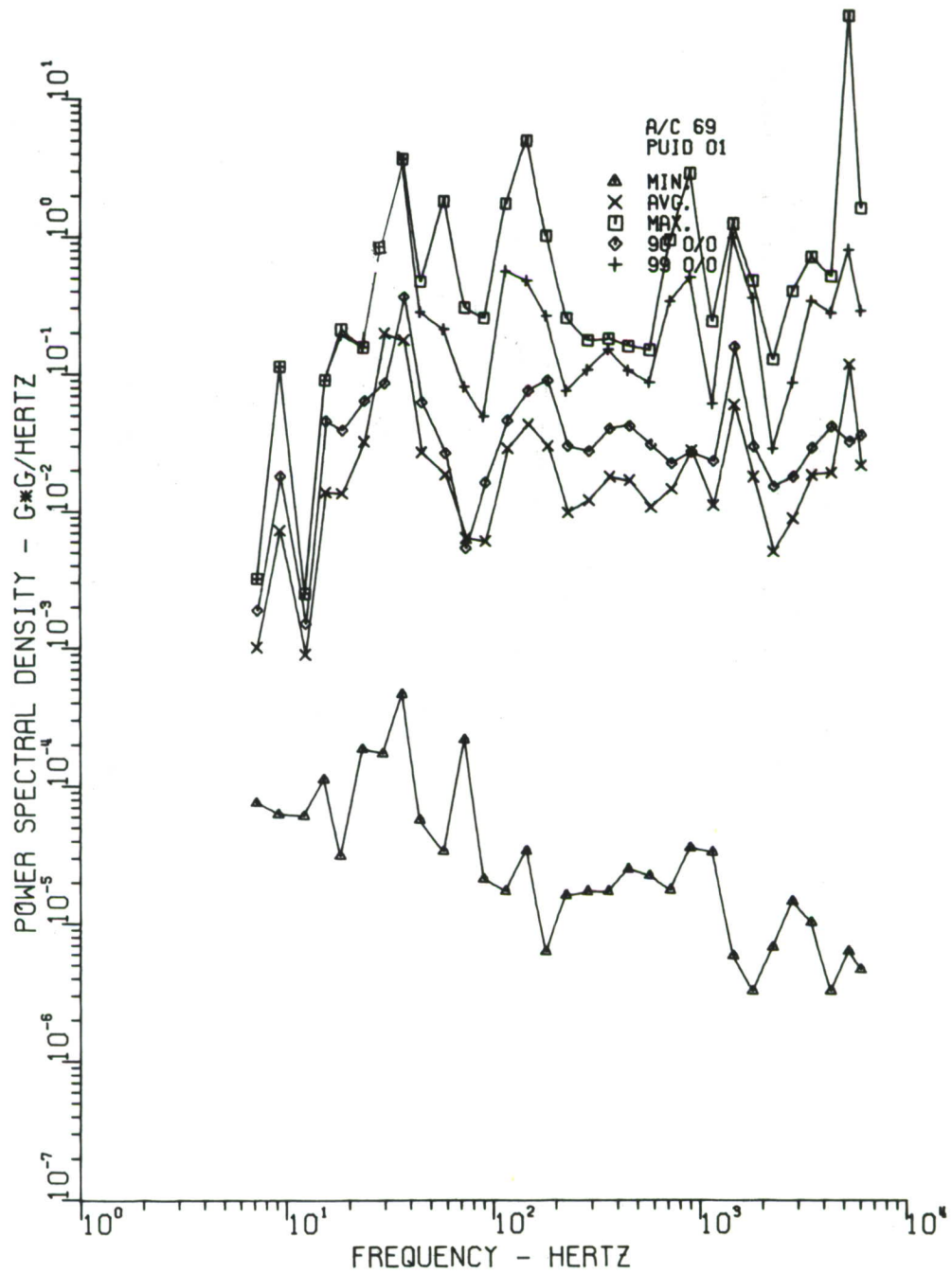

Figure 151. Engine-Transmission Compartment, without Gunfire

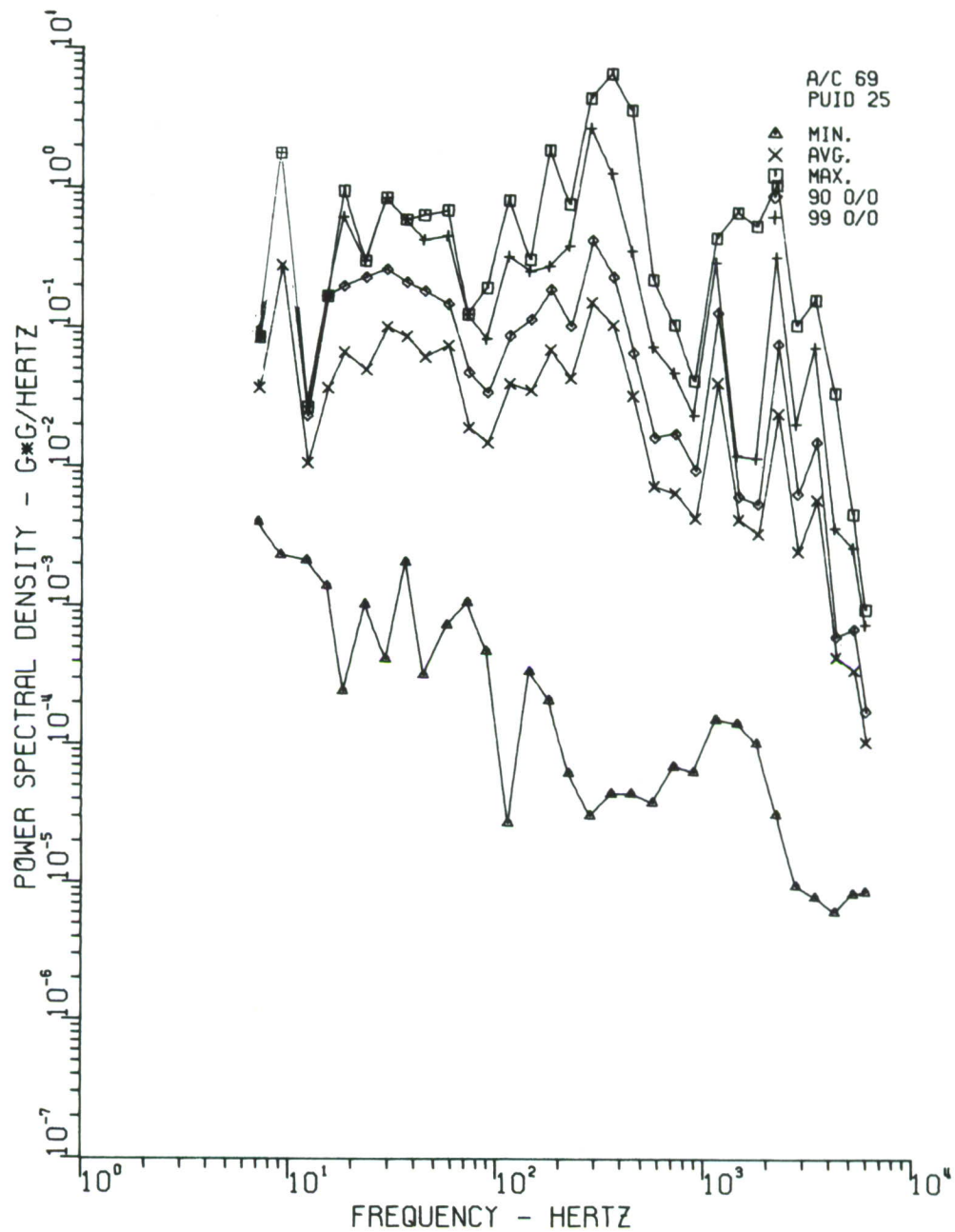

Figure 152. Tail Boom, without Gunfire

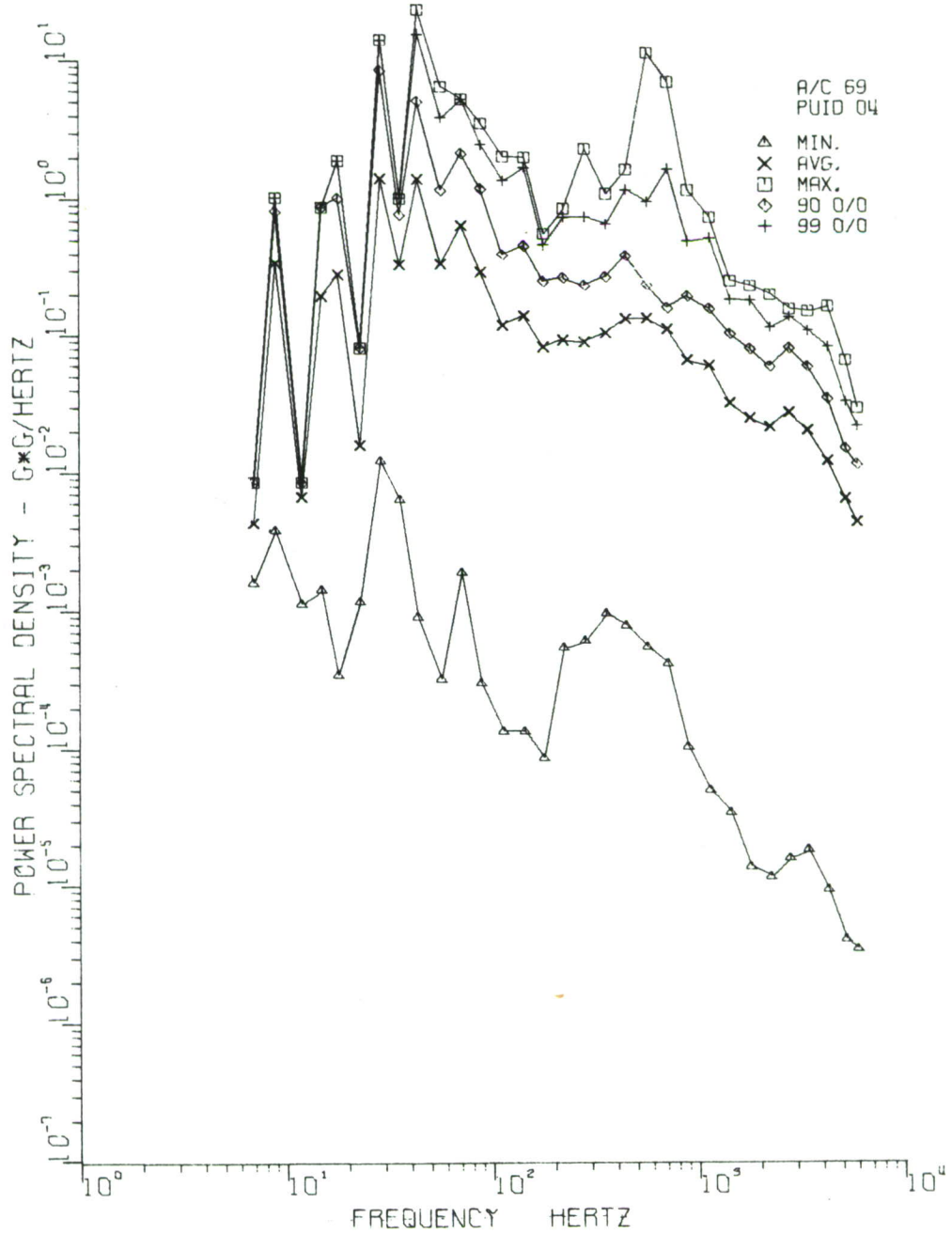

Figure 153. Nose Section and Cockpit, with Gunfire

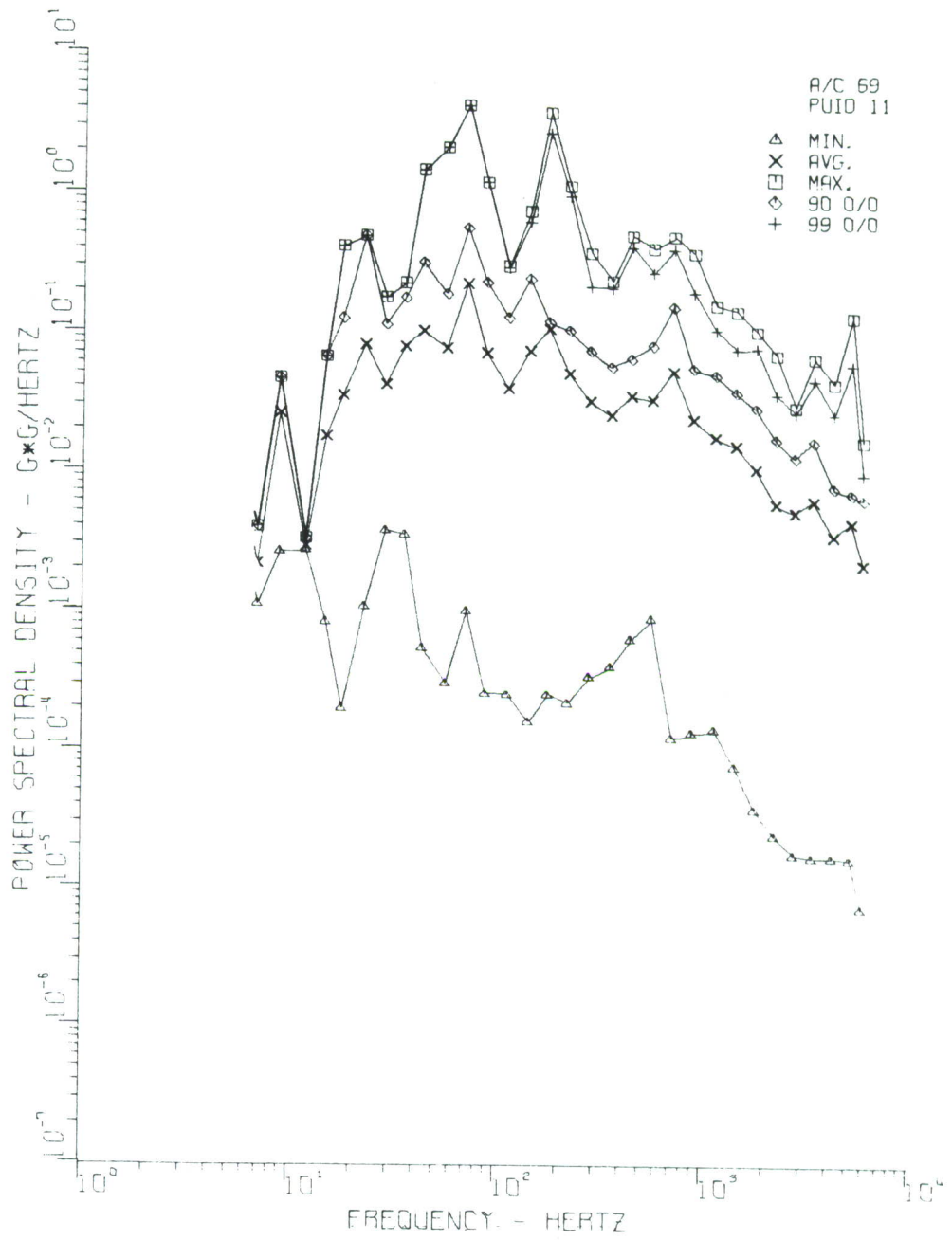

Figure 154. Passenger Compartment, with Gunfire

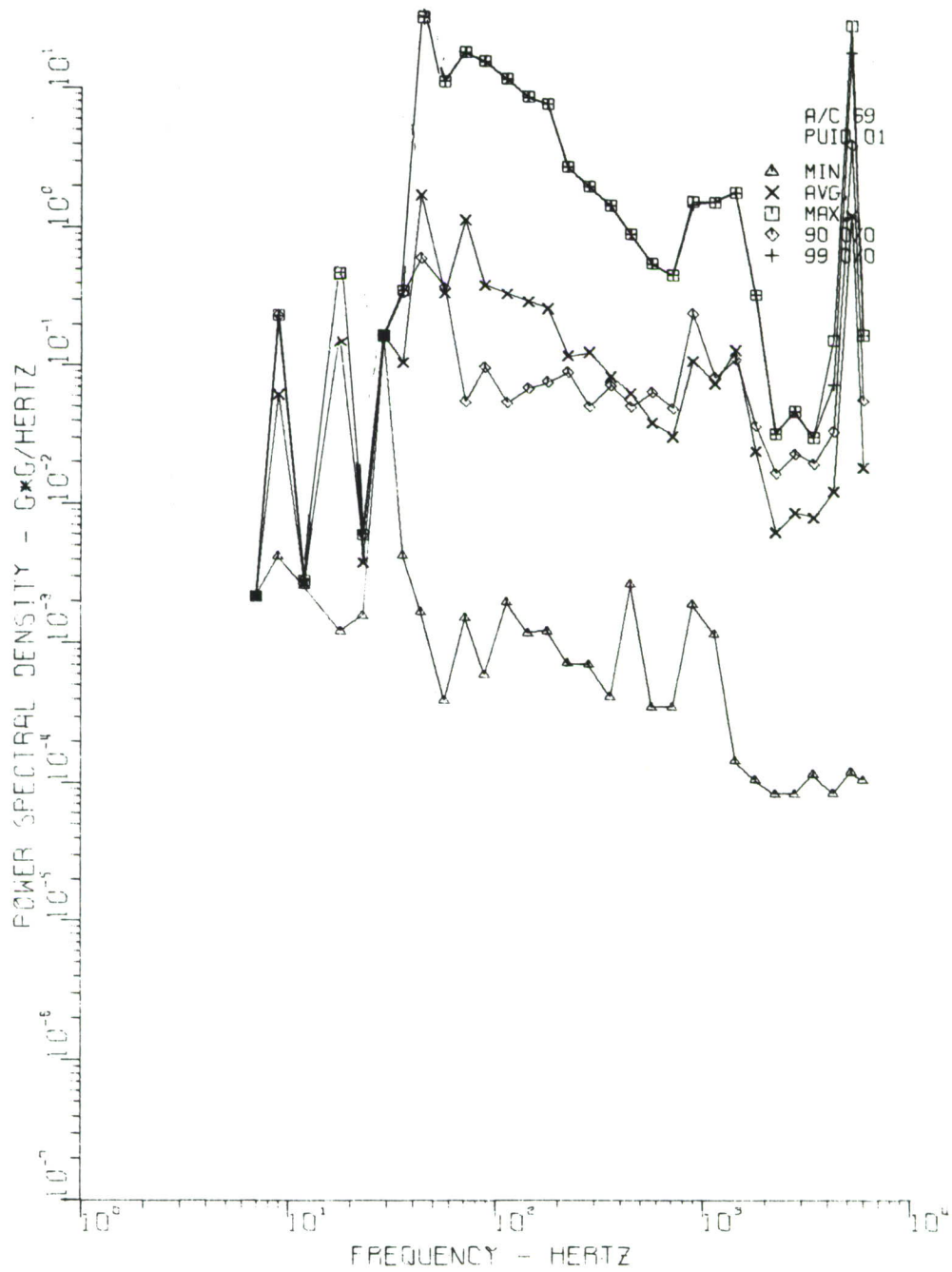

Figure 155. Engine-Transmission Compartment, with Gunfire

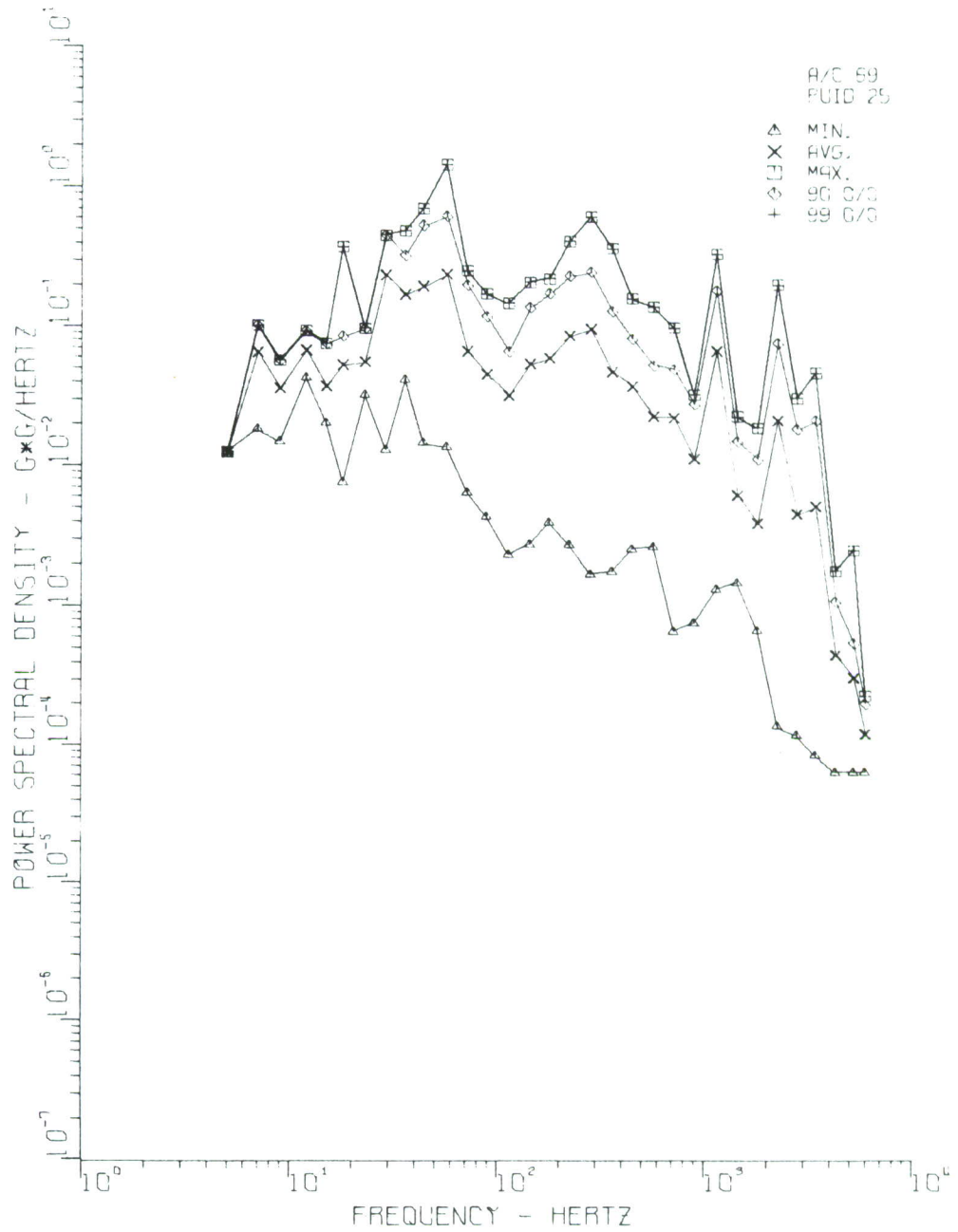

Figure 156. Tail Boom, with Gunfire

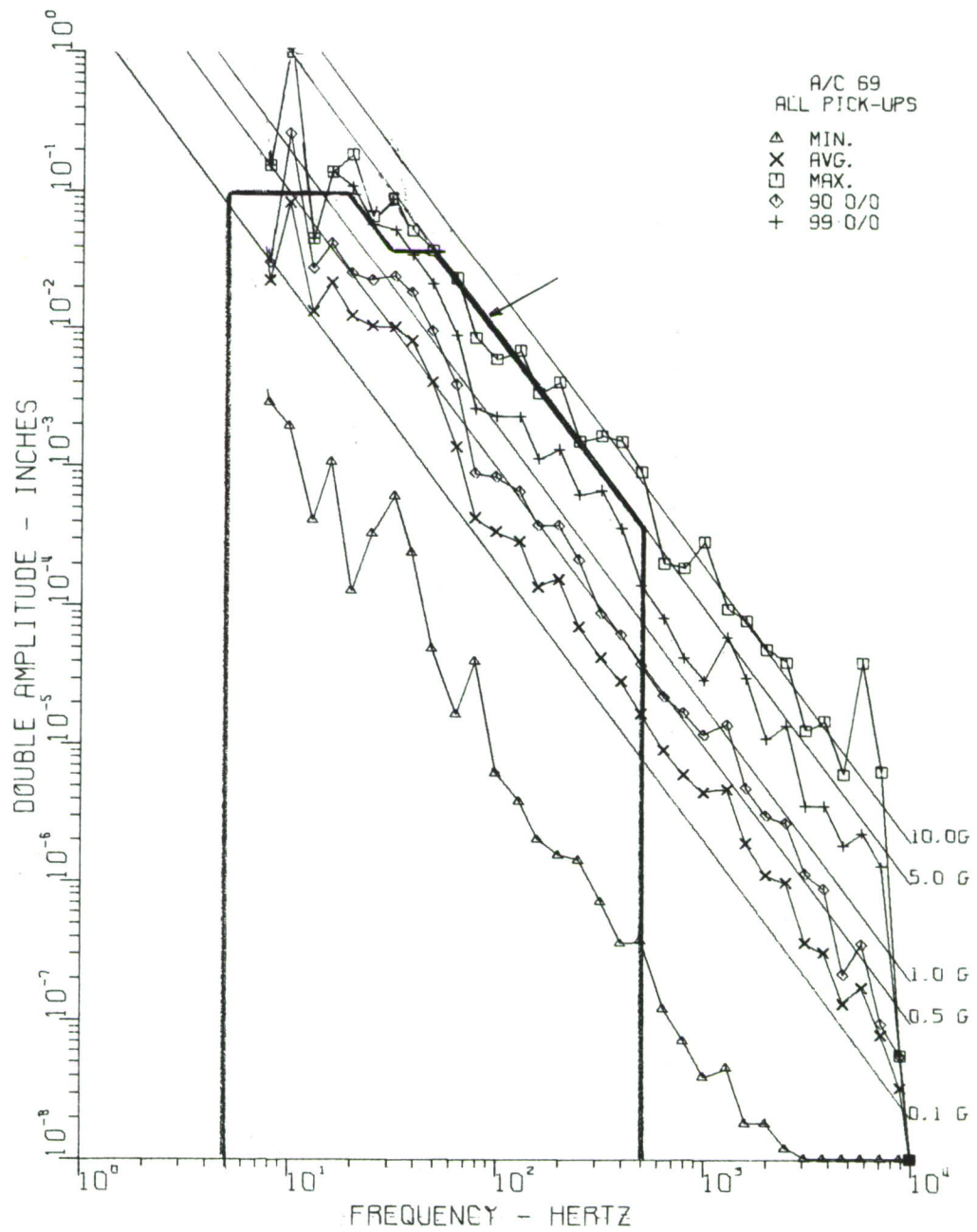

Figure 157. Entire Helicopter, without Gunfire

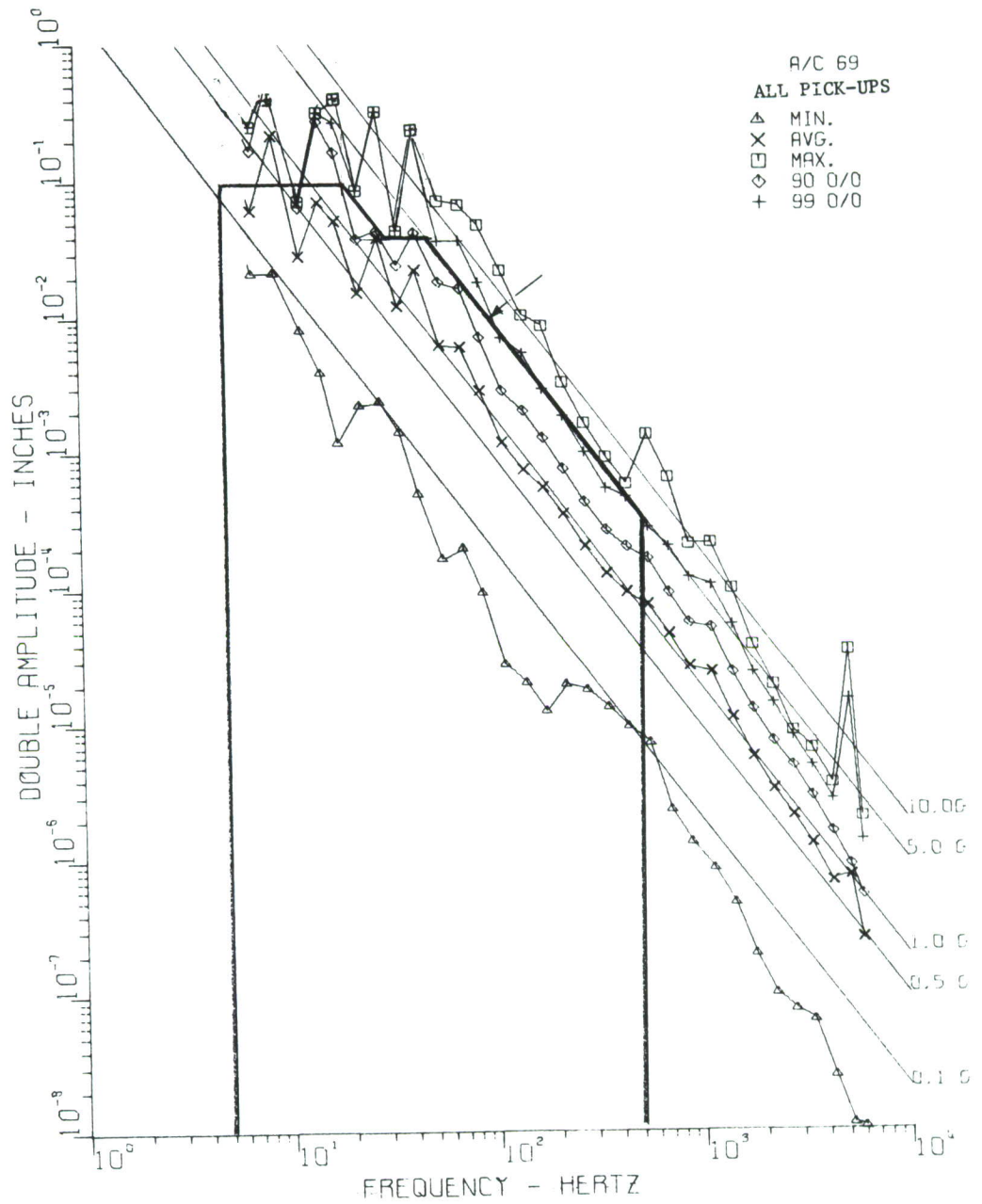

Figure 158. Entire Helicopter, with Gunfire

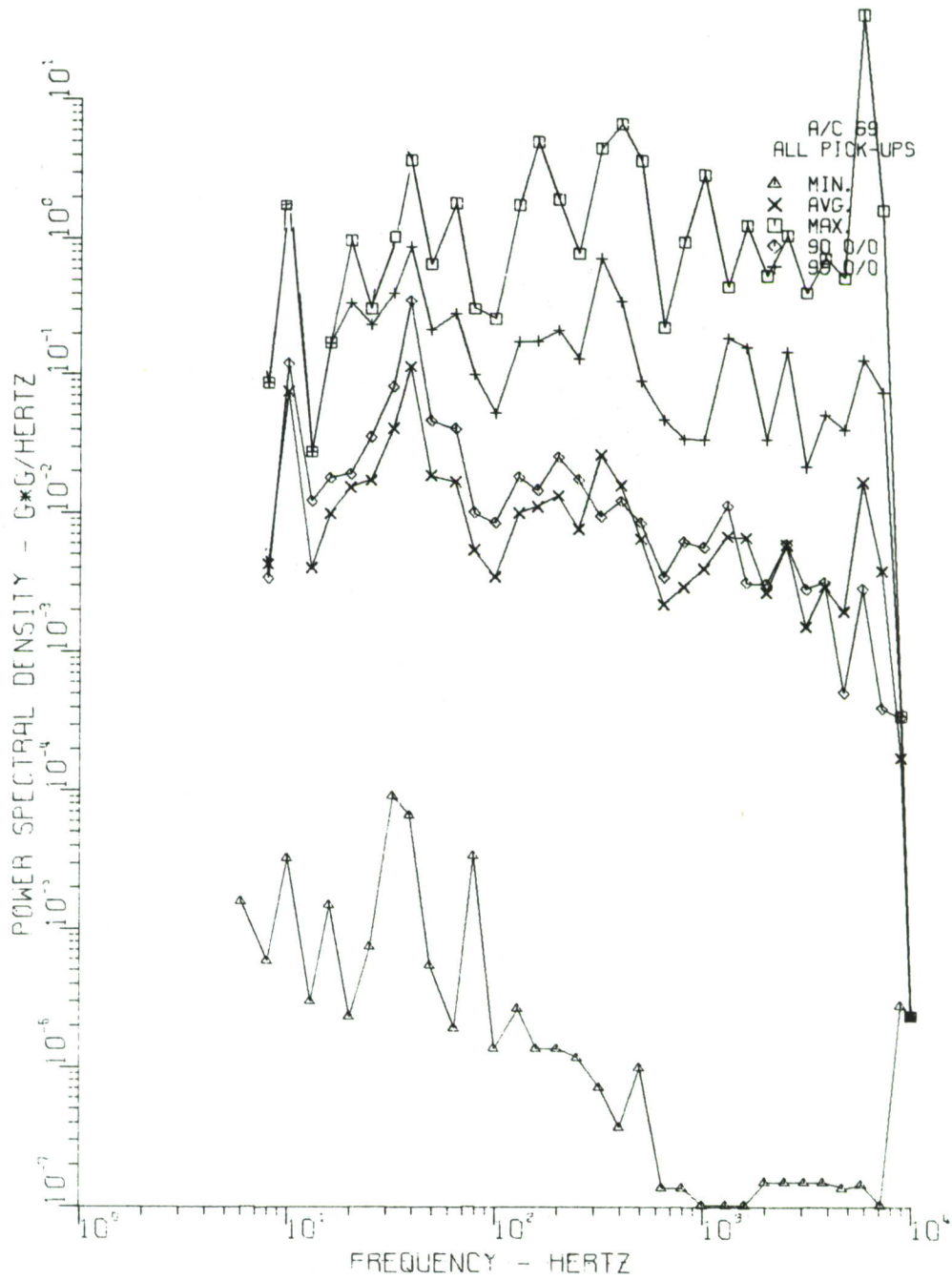

Figure 159. Entire Helicopter, without Gunfire

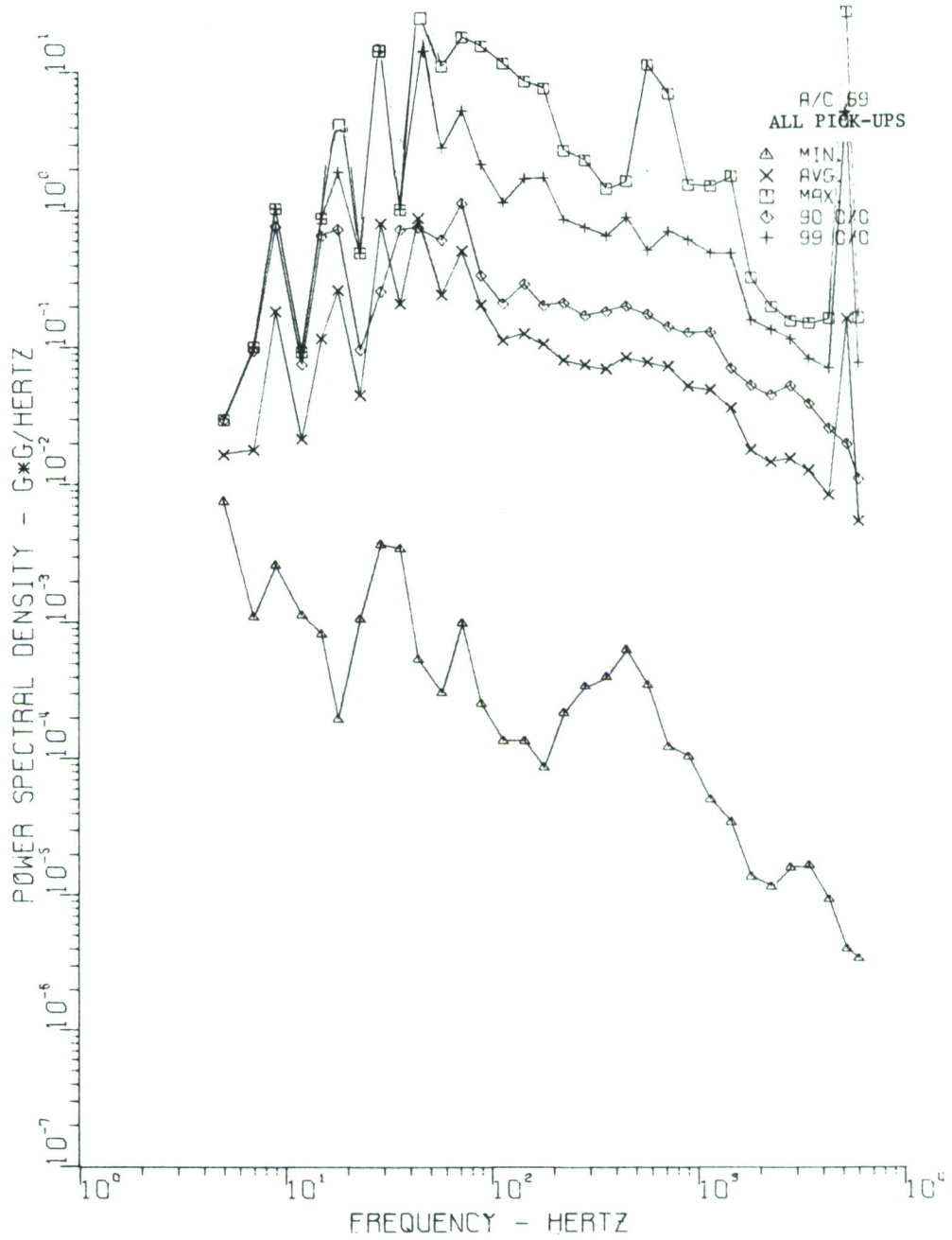

Figure 160. Entire Helicopter, with Gunfire

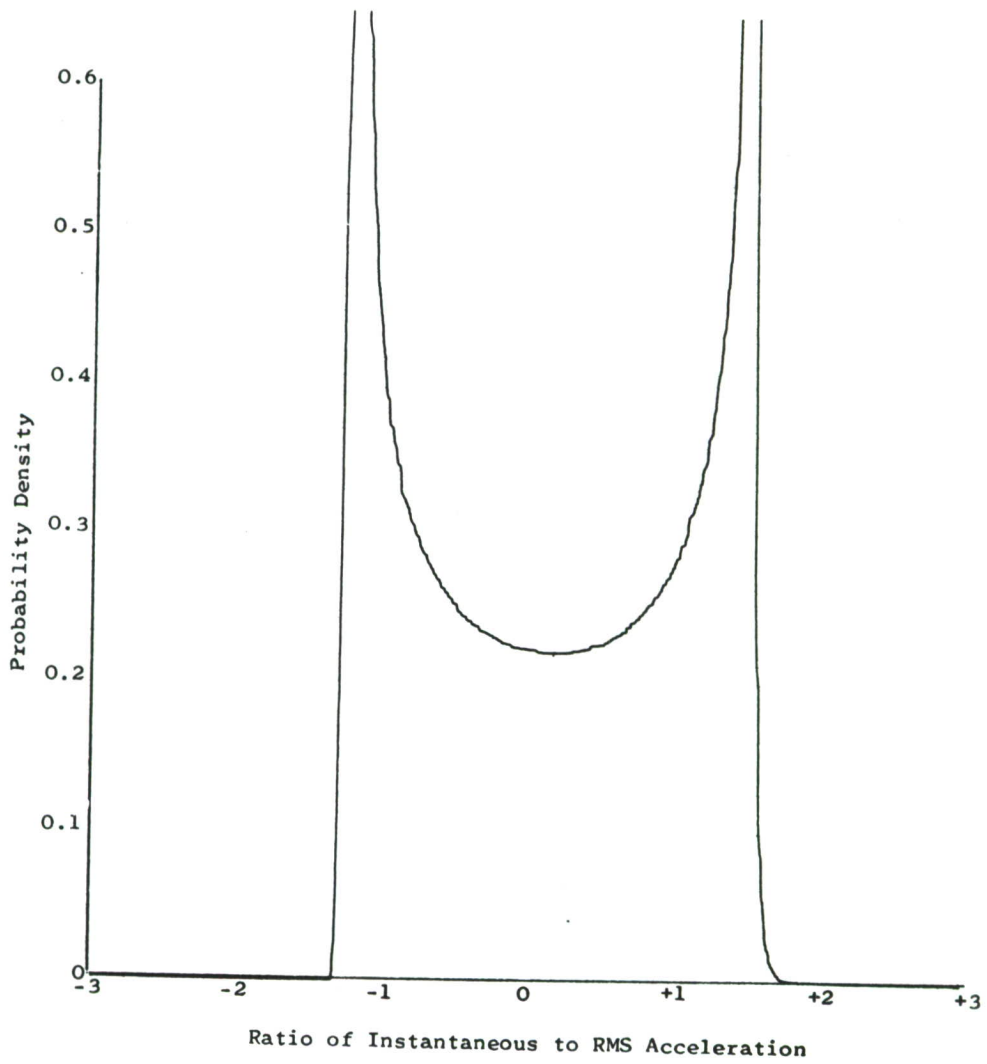

Figure 161. Sinusoidal Input

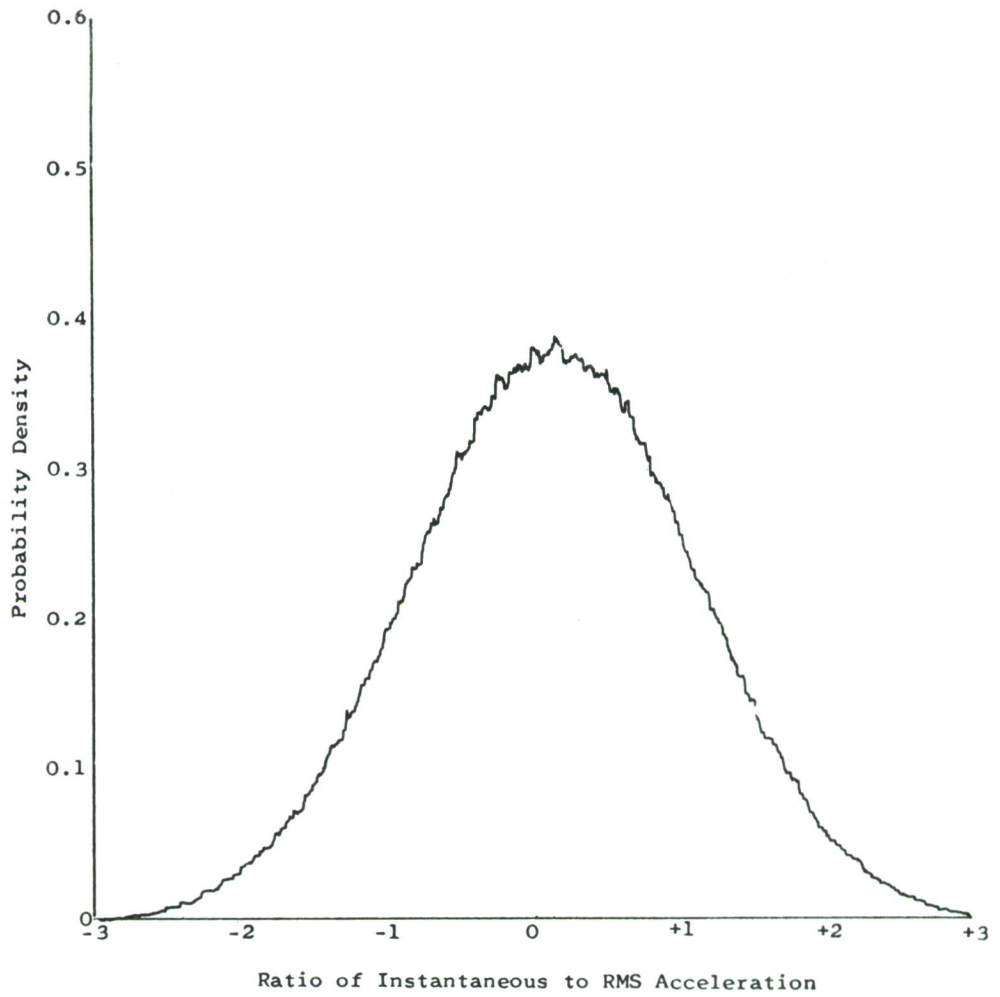

Figure 162. Random Gaussian Input

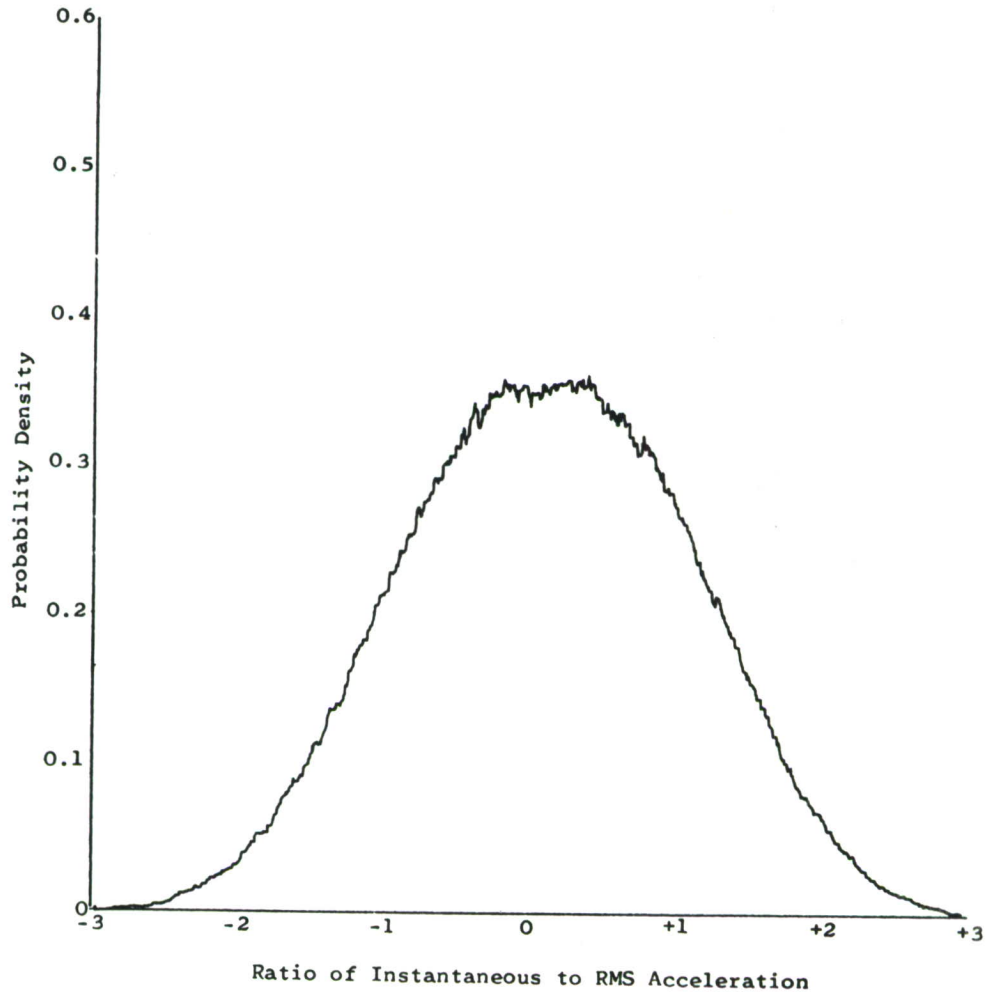

Figure 163. Ratio of Random to Sinusoidal Component of 1:1

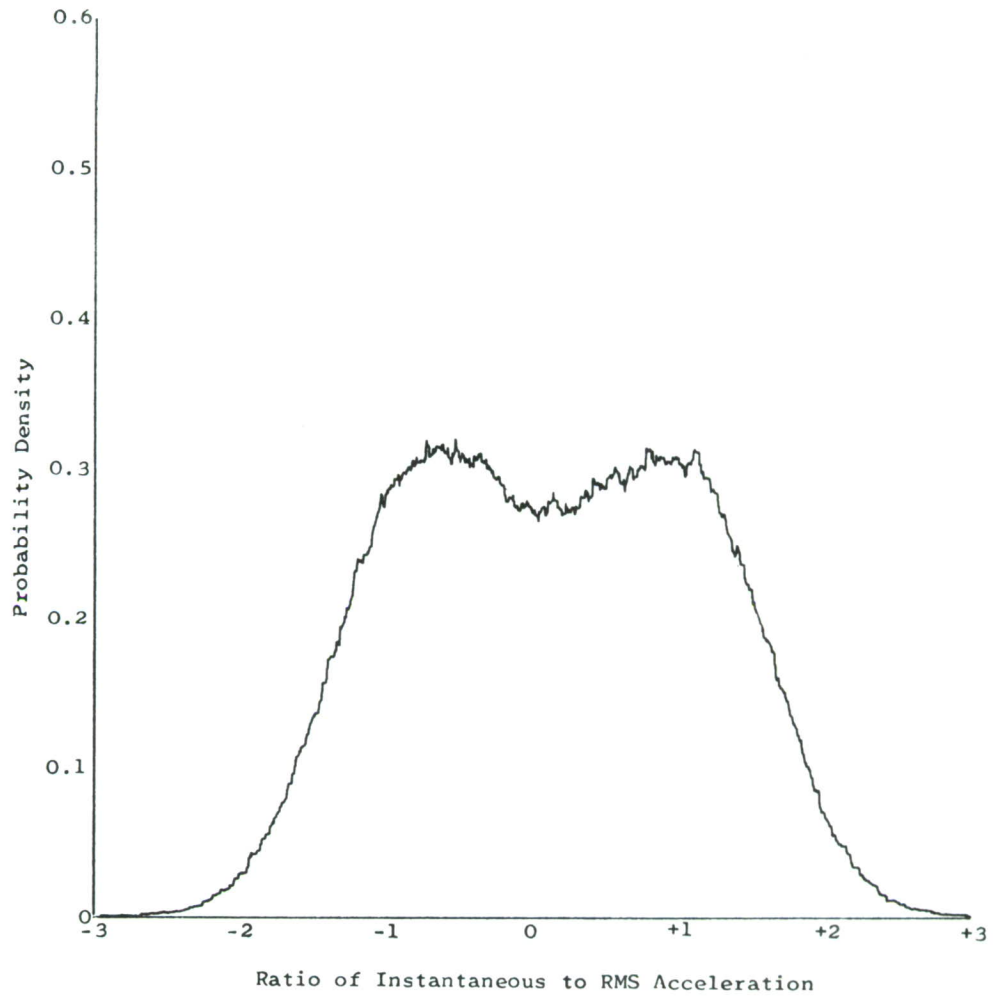

Figure 164. Ratio of Random to Sinusoidal Component of 1:2

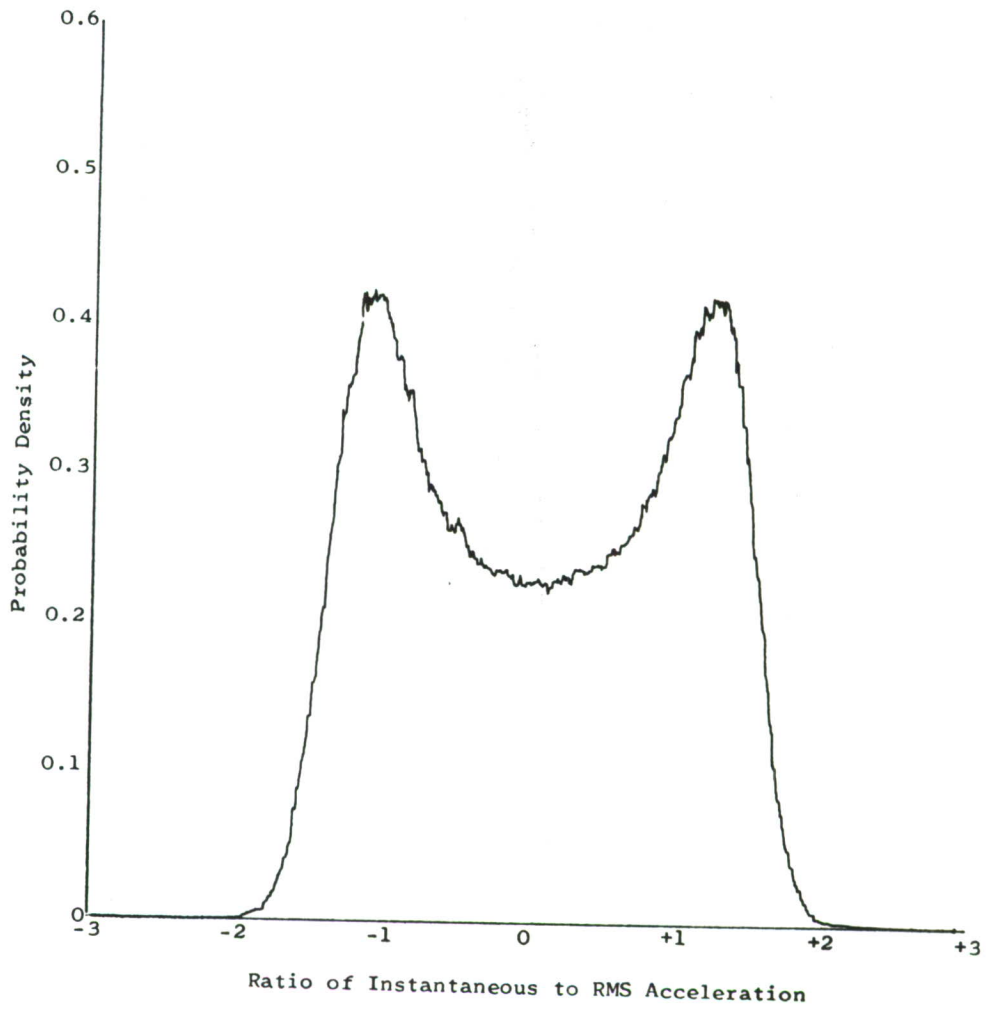

Figure 165. Ratio of Random to Sinusoidal Component of 1:5

Accelerometer Location: Electronics Compartment, Right Side,
Sta. 55, Vertical

Flight Condition: Attack Maneuver, 110 Knots

Center Frequency: 32 Hz

Bandwidth: 5 Hz

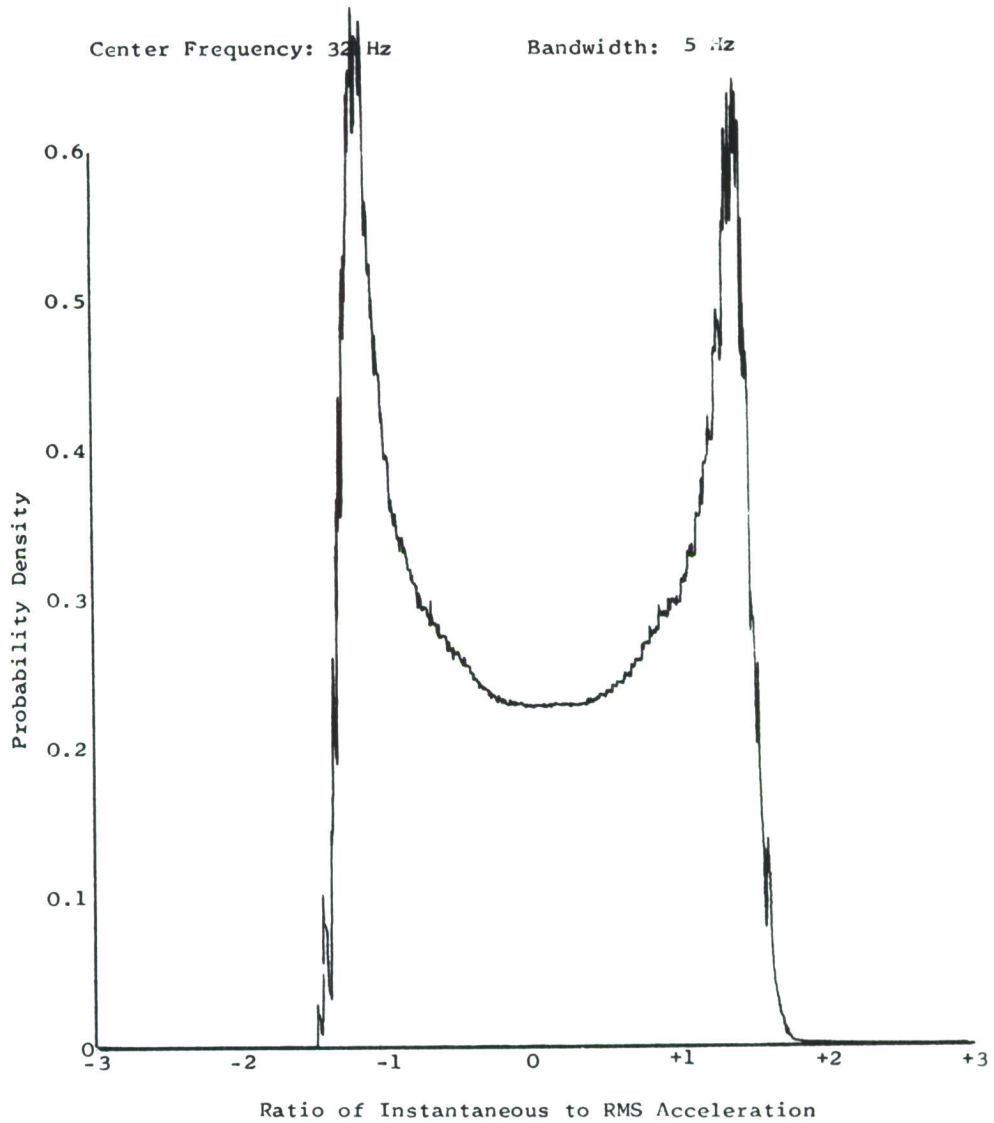

Figure 166. Acceleration APD in Electronics Compartment during Attack Maneuver, Vertical, 32 Hz Band

Accelerometer Location: Electronics Compartment, Right Side,
Sta. 55, Vertical

Flight Condition: Attack Maneuver, 110 Knots

Center Frequency: 64 Hz Bandwidth: 5 Hz

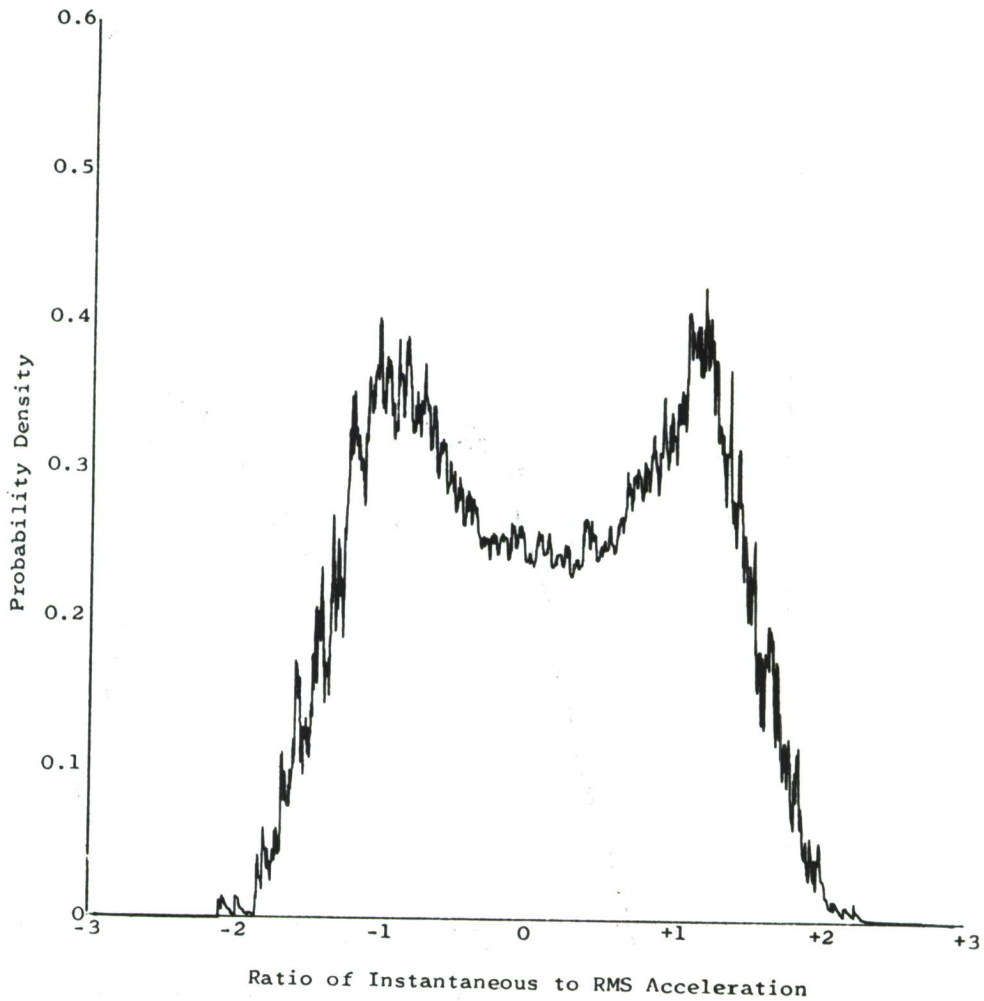

Figure 167. Acceleration APD in Electronics Compartment during Attack Maneuver, Vertical, 64 Hz Band

Accelerometer Location: Electronics Compartment, Right Side,
Sta. 55, Vertical

Flight Condition: Attack Maneuver, 110 Knots

Center Frequency: 200 Hz Bandwidth: 10 Hz

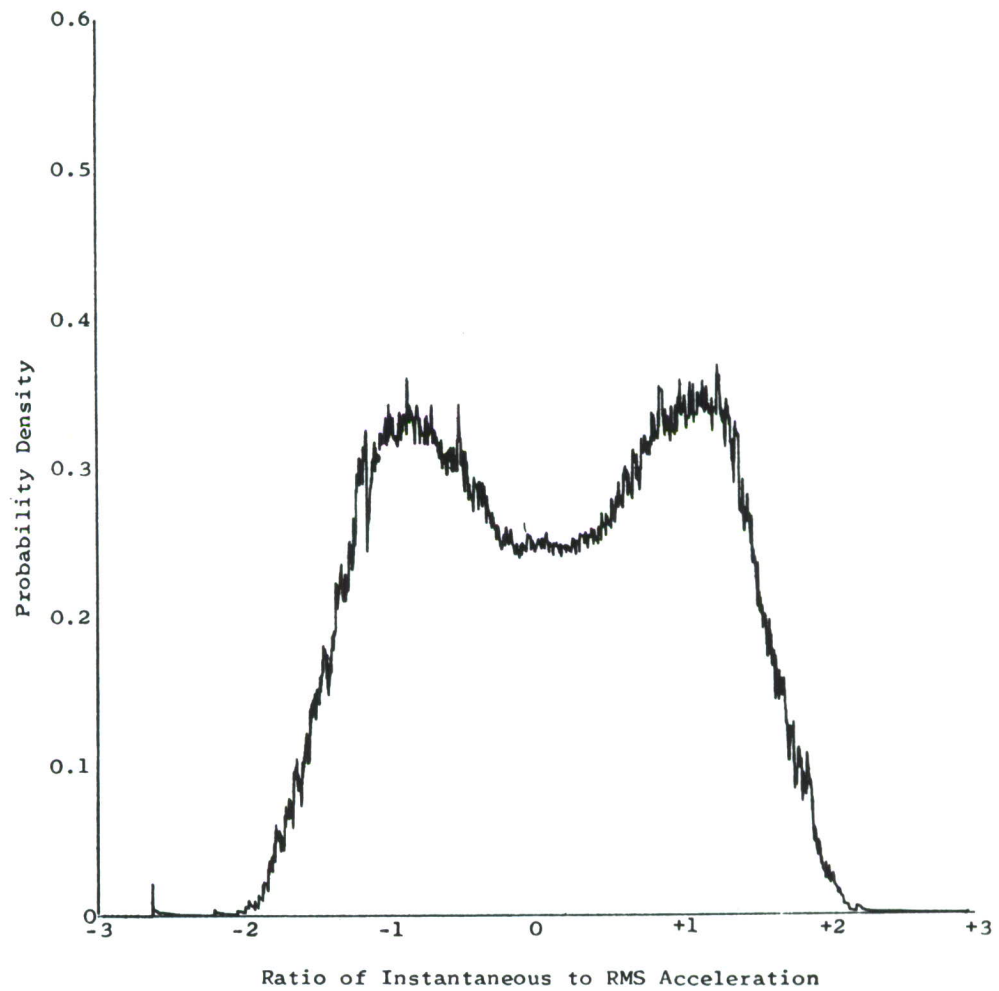

Figure 168. Acceleration APD in Electronics Compartment during Attack Maneuver, Vertical, 200 Hz Band

Accelerometer Location: Electronics Compartment, Right Side,
Sta. 55, Vertical

Flight Condition: Attack Maneuver, 110 Knots

Center Frequency: 382 Hz Bandwidth: 20 Hz

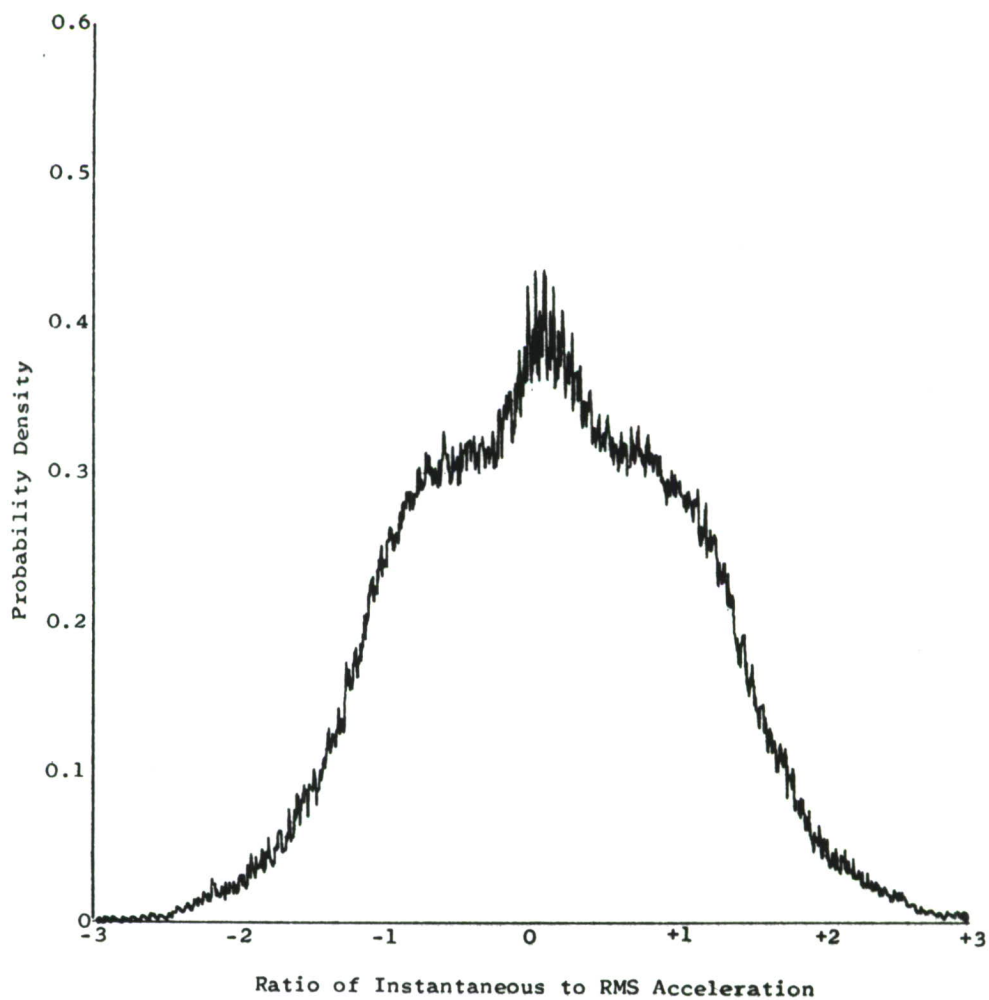

Figure 169. Acceleration APD in Electronics Compartment during Attack Maneuver, Vertical, 382 Hz Band

Accelerometer Location: Electronics Compartment, Right Side,
Sta. 55, Vertical

Flight Condition: Attack Maneuver, 110 Knots

Center Frequency: 590 Hz Bandwidth: 20 Hz

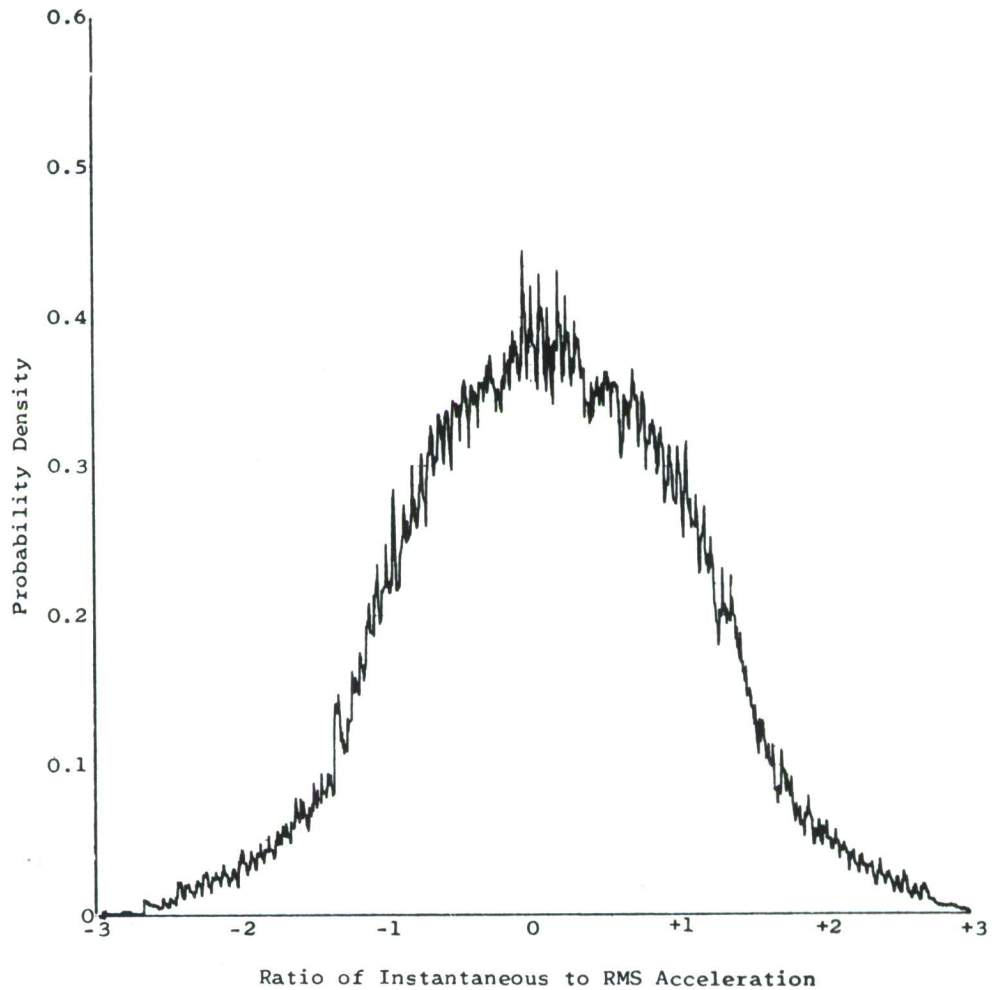

Figure 170. Acceleration APD in Electronics Compartment during Attack Maneuver, Vertical, 590 Hz Band

Accelerometer Location: Electronics Compartment, Right Side,
Sta. 55, Vertical

Flight Condition: Gunfire, 4000 Rounds/min., 110 Knots

Center Frequency: 31 Hz Bandwidth: 5 Hz

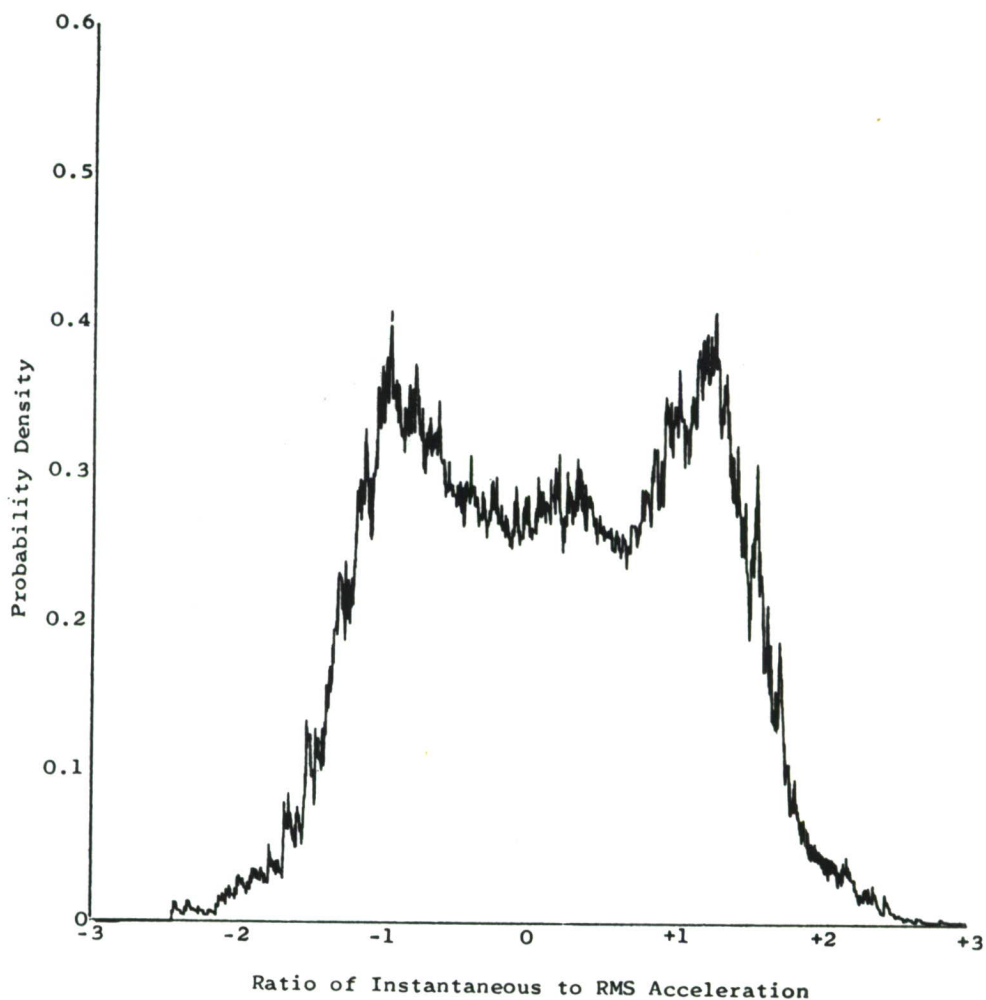

Figure 171. Acceleration APD in Electronics Compartment during Gunfire,
Vertical, 31 Hz Band

Accelerometer Location: Electronics Compartment, Right Side,
Sta. 55, Vertical

Flight Condition: Gunfire, 4000 Rounds/min., 110 Knots

Center Frequency: 67 Hz Bandwidth: 5 Hz

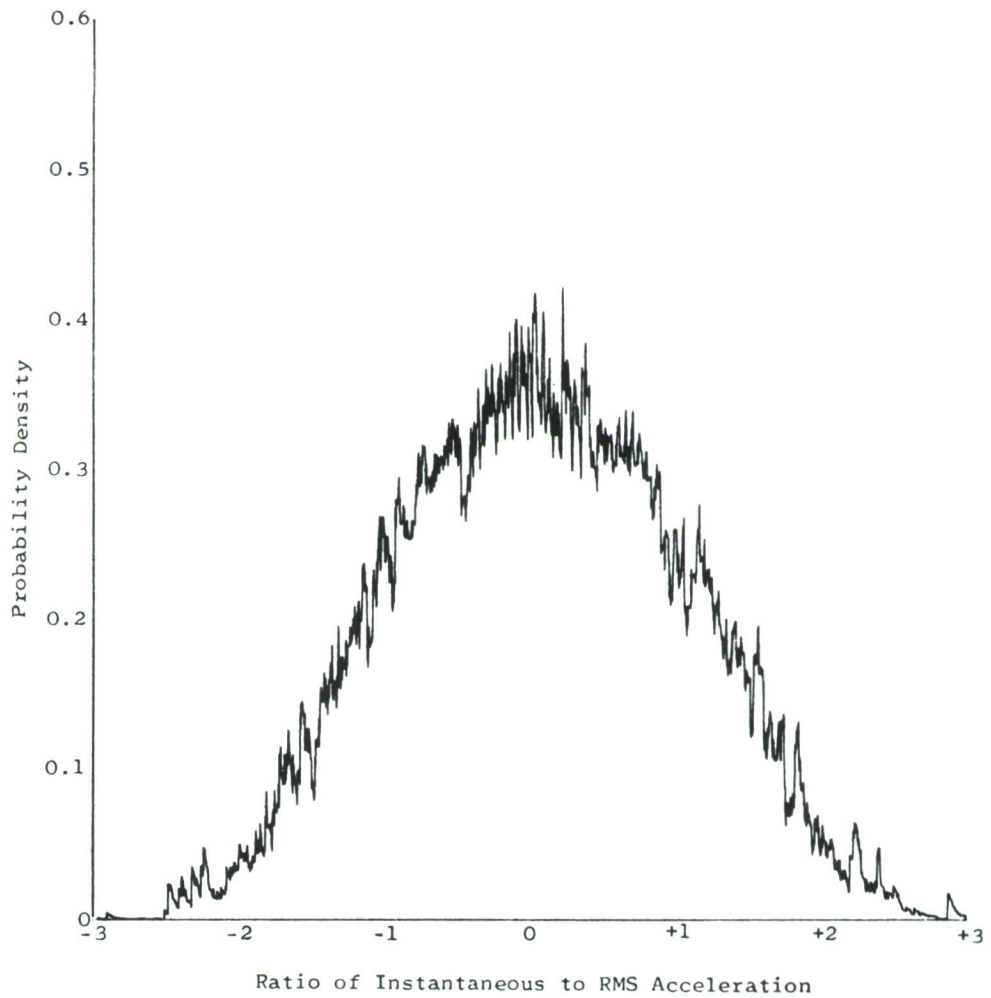

Figure 172. Acceleration APD in Electronics Compartment during Gunfire,
Vertical, 67 Hz Band

Accelerometer Location: Electronics Compartment, Right Side,
Sta. 55, Vertical

Flight Condition: Gunfire, 4000 Rounds/min., 110 Knots

Center Frequency: 200 Hz Bandwidth: 10 Hz

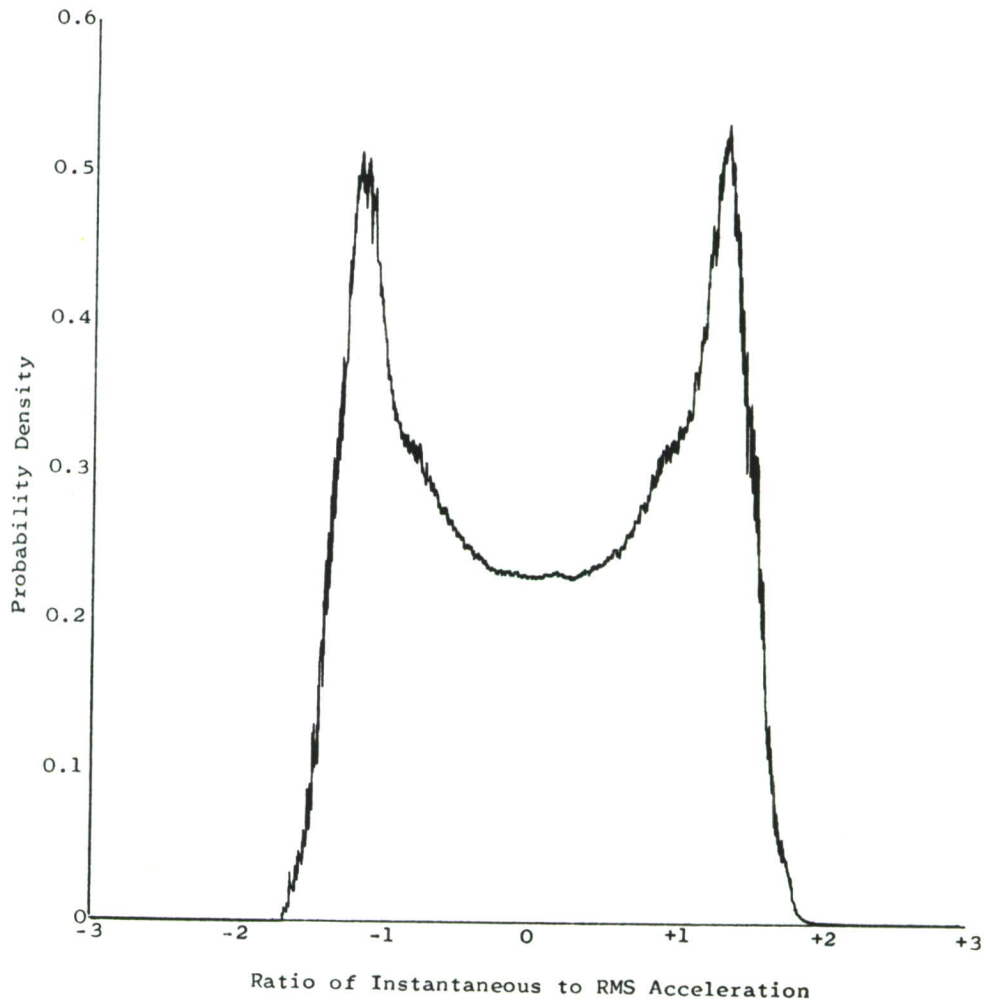

Figure 173. Acceleration APD in Electronics Compartment during Gunfire, Vertical, 200 Hz Band

Accelerometer Location: Electronics Compartment, Right Side,
Station 55, Vertical

Flight Condition: Gunfire, 4000 Rounds/min., 110 Knots

Center Frequency: 386 Hz Bandwidth: 20 Hz

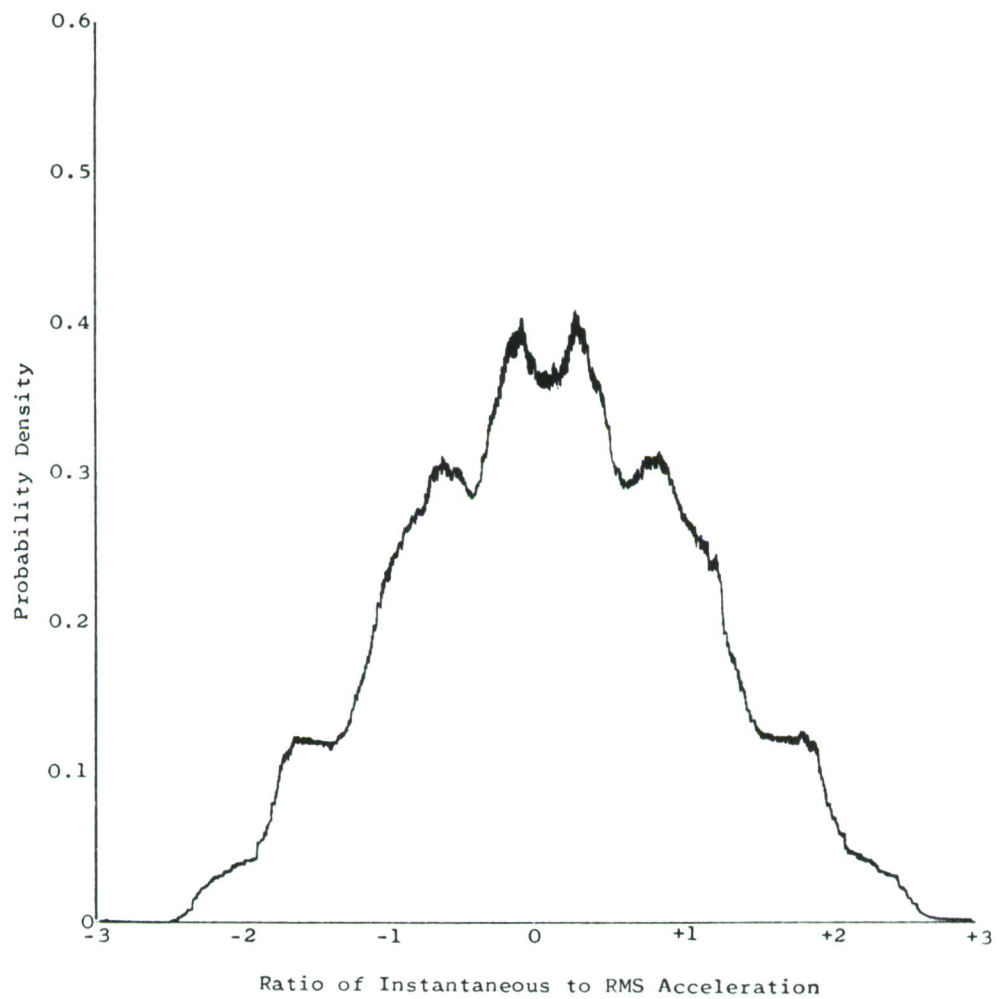

Figure 174. Acceleration APD in Electronics Compartment during Gunfire, Vertical, 386 Hz Band

Accelerometer Location: Electronics Compartment, Right Side,
Sta. 55, Vertical

Flight Condition: Gunfire, 4000 Rounds/min., 110 Knots

Center Frequency: 700 Hz Bandwidth: 20 Hz

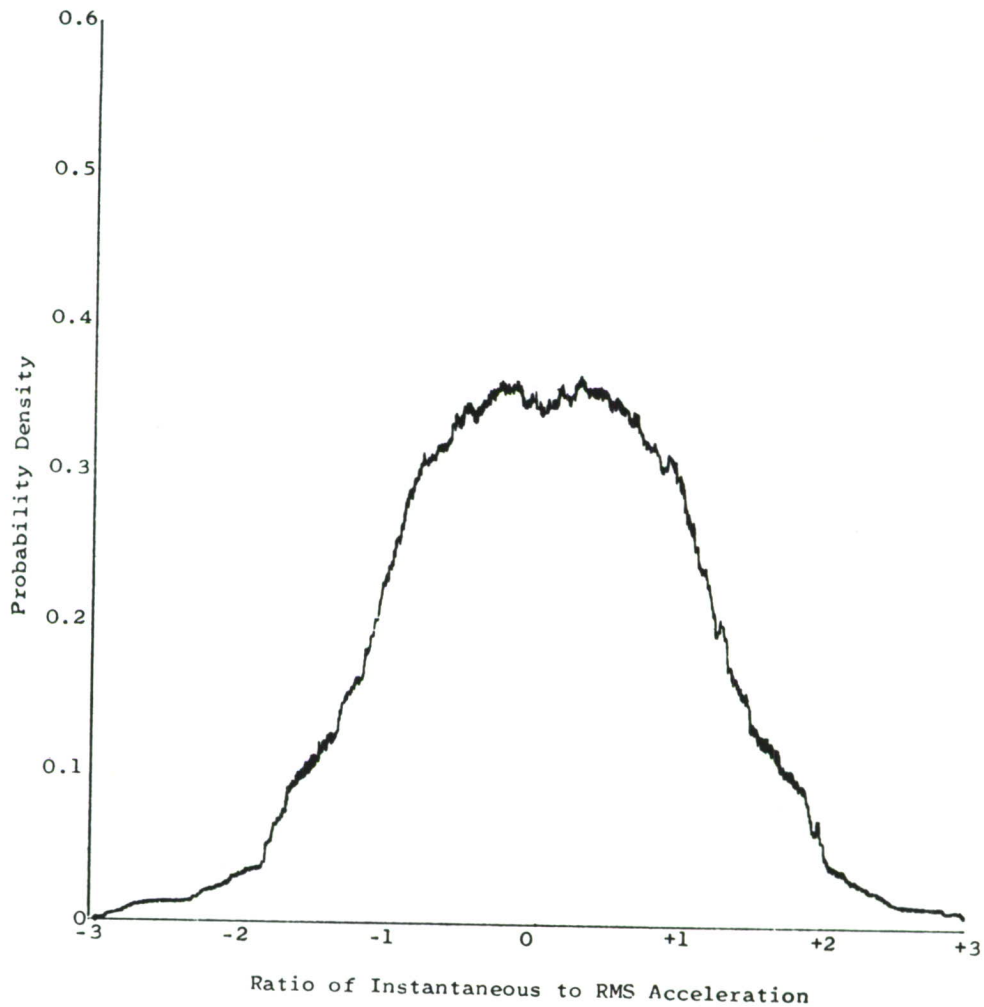

Figure 175. Acceleration APD in Electronics Compartment during Gunfire, Vertical, 700 Hz Band