

UNCLASSIFIED

AD NUMBER

ADB012292

LIMITATION CHANGES

TO:

Approved for public release; distribution is unlimited.

FROM:

Distribution authorized to U.S. Gov't. agencies only; Proprietary Information; 30 JUN 1976. Other requests shall be referred to Air Force Geophysics Lab., Hanscom AFB, MA.

AUTHORITY

AFGL ltr 7 Jan 1981

THIS PAGE IS UNCLASSIFIED

**THIS REPORT HAS BEEN DELIMITED
AND CLEANED FOR PUBLIC RELEASE
UNDER DOD DIRECTIVE 5200.20 AND
NO RESTRICTIONS ARE IMPOSED UPON
ITS USE AND DISCLOSURE.**

DISTRIBUTION STATEMENT A

**APPROVED FOR PUBLIC RELEASE;
DISTRIBUTION UNLIMITED.**

AFGL-TR-76-0130

~~SECRET~~
B.S.

AD B012292

EVALUATION STUDIES OF TELEMETRY SYSTEM COMPONENTS

by
Richard H. Marks



Northeastern University
Electronics Research Laboratory
Boston, Massachusetts 02115

Contract No. F19628-73-C-0148

SCIENTIFIC REPORT NO. 4

13 February 1976

Contract Monitor: Eben M. Hiscock
Aerospace Instrumentation Division

Prepared for

Air Force Cambridge Geophysics Laboratory
Air Force Systems Command
United States Air Force
Hanscom AFB, Massachusetts 01730

AD No. ~~SECRET~~
DDC FILE COPY

DDC
RECEIVED
JUL 19 1976
RECEIVED

[Handwritten signature]

Unclassified

SECURITY CLASSIFICATION OF THIS PAGE (When Data Entered)

(19) REPORT DOCUMENTATION PAGE		READ INSTRUCTIONS BEFORE COMPLETING FORM	
(18) REPORT NUMBER AFGL-TR-76-0130		2. GOVT ACCESSION NO. (9) Rept. for 8 Jan 73-13 Feb 76	3. RECIPIENT'S CATALOG NUMBER
(6) TITLE (and Subtitle) EVALUATION STUDIES OF TELEMETRY SYSTEM COMPONENTS		5. TYPE OF REPORT & PERIOD COVERED (14) Scientific -4	
(10) AUTHOR Richard H. Marks		6. PERFORMING ORG. REPORT NUMBER (15) F19628-73-C-0148	
9. PERFORMING ORGANIZATION NAME AND ADDRESS Northeastern University Electronics Research Laboratory Boston, Massachusetts 02115		10. PROGRAM ELEMENT, PROJECT, TASK AREA & WORK UNIT NUMBERS 62101F 76590101	
11. CONTROLLING OFFICE NAME AND ADDRESS Air Force Geophysics Laboratory Hanscom AFB, Massachusetts 01731 Monitor/Eben M. Hiscock/LCS		12. REPORT DATE (11) 13 Feb 76	
13. MONITORING AGENCY NAME & ADDRESS (if different from Controlling Office) (16) AF-7659 / (17) 765901		13. NUMBER OF PAGES 188 (12) 190p.	
		15. SECURITY CLASS. Unclassified	
		15a. DECLASSIFICATION/DOWNGRADING SCHEDULE	
16. DISTRIBUTION STATEMENT (of this Report) Distribution limited to U. S. Government agencies only; Proprietary Information; 30 June 1976. Other requests for this document must be referred to AFGL/LCS, Hanscom AFB, Massachusetts 01731.			
17. DISTRIBUTION STATEMENT (of the abstract entered in Block 20, if different from Report)			
18. SUPPLEMENTARY NOTES			
19. KEY WORDS (Continue on reverse side if necessary and identify by block number) Transmitters Voltage-controlled oscillators			
20. ABSTRACT (Continue on reverse side if necessary and identify by block number) This report contains the results of a program for the evaluation of commercial airborne telemetry system equipment. A number of RF telemetry transmitters and voltage-controlled subcarrier oscillators were tested. The test procedures and results are given for all the equipment evaluated.			

7/B

Form with checkboxes and a handwritten 'B' in the bottom left corner.

EVALUATION STUDIES OF TELEMETRY SYSTEM COMPONENTS

by

Richard H. Marks

**Northeastern University
Electronic Research Laboratory
Boston, Massachusetts 02115**

Contract No. F19628-73-C-0148

SCIENTIFIC REPORT NO. 4

13 February 1976

**Contract Monitor: Eben M. Hiscock
Aerospace Instrumentation Division**

Prepared for

**Air Force Cambridge Geophysics Laboratory
Air Force Systems Command
United States Air Force
Hanscom AFB, Massachusetts 01730**

**DDC
RECEIVED
JUL 19 1976
RECEIVED
D**

Limited Distribution

This report contains proprietary information and can only be distributed to authorized agencies.

Abstract

This report contains the results of a program for the evaluation of commercial airborne telemetry system equipment. A number of RF telemetry transmitters and voltage-controlled subcarrier oscillators were tested. The test procedures and results are given for all the equipment evaluated.

TABLE OF CONTENTS

TITLE PAGE - - - - -	Page 1
DISTRIBUTION - - - - -	11
ABSTRACT - - - - -	111
TABLE OF CONTENTS - - - - -	iv
INTRODUCTION - - - - -	1

RF Telemetry Transmitters

CHAPTER I.	A. Evaluation Test Procedures for RF Telemetry Transmitters - - - - -	2
	B. Test Results for RF Telemetry Transmitters - - - - -	12

<u>Manufacturer</u>	<u>Type</u>	<u>Serial No.</u>	<u>Freq. (MHz)</u>	
CONIC	CTP-402	402P191	234.0	13
CONIC	CTP-402	402P192	234.0	17
CONIC	CTP-402	402P193	240.2	20
CONIC	CTP-402	402P194	240.2	23
CONIC	CTP-402	402P195	244.3	26
CONIC	CTP-402	402P196	244.3	29
CONIC	CTS-402	4020319	2259.5	32
CONIC	CTS-402	4020558	2251.5	36
CONIC	CTS-402	4020599	2251.5	39
CONIC	CTS-402	4021093	2251.5	42
CONIC	CTS-402	4021094	2251.5	45
CONIC	CTS-402	4021095	2251.5	48
CONIC	CTS-402	4021096	2279.5	51
CONIC	CTS-402	4021097	2279.5	54
CONIC	CTS-402	4021098	2279.5	57
CONIC	CTS-402	4021099	2259.5	60
CONIC	CTS-402	4021100	2259.5	63
CONIC	CTS-402	4021101	2259.5	66
CONIC	CTS-402	4021102	2259.5	69
CONIC	CTS-402	4021103	2259.5	72
CONIC	CTS-402	4021104	2269.5	75
CONIC	CTS-402	4021106	2269.6	78
CONIC	CTS-402	4021107	2269.5	81

TABLE OF CONTENTS (continued)

<u>Manufacturer</u>	<u>Type</u>	<u>Serial No.</u>	<u>Freq.(MHz)</u>	<u>Page</u>
RAYTHEON	T-201	020	2228.5	84
RAYTHEON	T-201	022	2219.5	88
VECTOR	T105S	550	2259.5	91
VECTOR	T202S	201	2220.5	95
VECTOR	T202S	202	2220.5	99

CHAPTER II. Voltage - Controlled Subcarrier Oscillators

A. Evaluation Test Procedure for Voltage - Controlled Subcarrier Oscillators - - - - -	102
B. Test Results for Voltage - Controlled Subcarrier Oscillators - - - - -	112

<u>Manufacturer</u>	<u>Type</u>	<u>Serial No.</u>	<u>Band</u>	
OMNITEK	40A1	3168	6	113
OMNITEK	40A1	3169	6	116
OMNITEK	40A1	3170	13	118
OMNITEK	40A1	3171	13	120
OMNITEK	40A1	3172	18	122
OMNITEK	40A1	3173	18	124
VECTOR	MMO-11	24774	18	126
VECTOR	MMO-11	32493	16	129
VECTOR	MMO-11	51409	12	131
VECTOR	MMO-11	51432	12	133
VECTOR	MMO-11	51491	14	135
VECTOR	MMO-11	51518	14	137
VECTOR	MMO-11	51661	16	139
VECTOR	MMO-11	51940	15	141
VECTOR	MMO-11	51954	15	143
VECTOR	MMO-11	52377	13	145
VECTOR	MMO-11	52378	13	147
VECTOR	MMO-11	52406	17	149
VECTOR	MMO-11	52422	17	151
VECTOR	MMO-11	54168	18	153
VECTOR	MTS-42	7499	12	155
VECTOR	MTS-42	7744	7	158
VECTOR	MTS-42	7762	7	160

TABLE OF CONTENTS (continued)

<u>Manufacturer</u>	<u>Type</u>	<u>Serial No.</u>	<u>Band</u>	<u>Page</u>
VECTOR	MTS-42	7854	12	162
VECTOR	MTS-42	7880	13	164
VECTOR	MTS-42	7922	15	166
VECTOR	MTS-42	7956	17	168
VECTOR	MTS-42	8826	10	170
VECTOR	MTS-42	8831	10	172
VECTOR	MTS-42	8894	13	174
VECTOR	MTS-42	8918	15	176
VECTOR	MTS-42	8935	15	178
VECTOR	MTS-42	8964	17	180
PERSONNEL	-----	-----	-----	182



INTRODUCTION

A comparative evaluation of commercial telemetry equipment is being conducted under contract, from Air Force Cambridge Research Laboratories, Bedford, Massachusetts (contract F19628-73-C-0148) from 8 January 1973 through 13 February 1976. During the span of this contract, major manufacturers of certain categories of airborne system components are asked to submit their products on consignment. In each instance the electrical characteristics are measured and compared against the manufacturer's published specifications. The results of these tests are classified as proprietary information and made available to AFCRL and the individual manufacturer concerned. Complete results of all components tested during the period 9 January 1975 through 13 February 1976 are included in this report. Scientific Report No. 1 of Contract F19628-73-C-0148, dated 8 January 1974 contains the results obtained during the period of 9 January 1973 through 8 January 1974. Scientific Report No. 2 of Contract F19628-73-C-0148, dated 8 January 1975 contains the results obtained during the period of 9 January 1974 through 8 January 1975.

This evaluation program was initiated in April 1958 (under contract AF19(604)-3506) as a means of insuring the receipt of working units. Since that time, the program has expanded to the point where all manufacturers are invited to participate. RF Transmitters and Subcarrier Oscillators are the two main categories of components tested to date. The first section of each chapter details the test performed, equipment used and the procedures followed. The second section of each chapter contains a tabulation of the equipment tested and the resulting data.

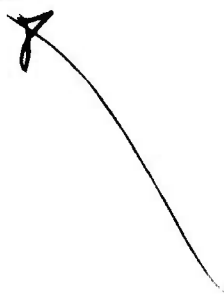

RF Telemetry Transmitters

A. Evaluation Test Procedure for RF Telemetry Transmitter

Test I. Time Drift

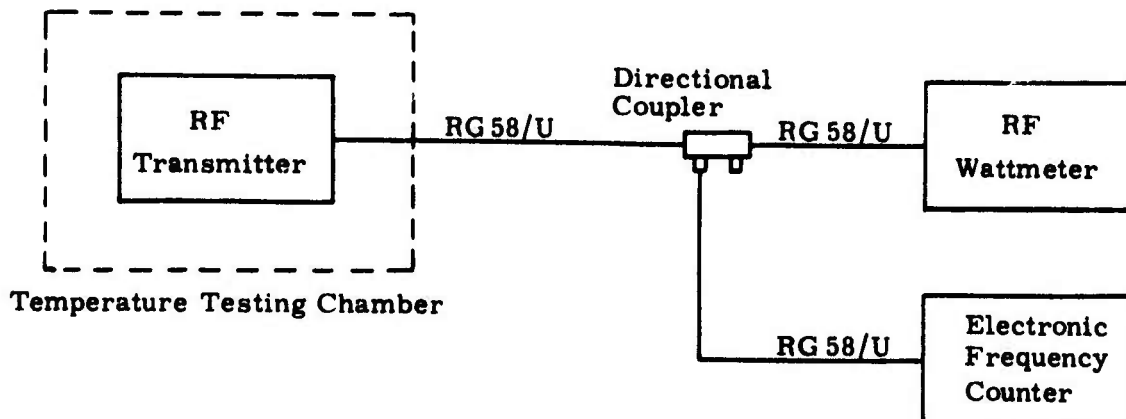

FIGURE 1.

Step 1. Place the RF Transmitter inside the temperature testing chamber. Set the temperature at $+30^{\circ}\text{C}$. Wire test equipment as shown in Figure 1. Ground the modulation input terminal. Use recommended B+ Supply voltage. Without allowing a warm-up period, turn on the supply voltage. Measure the output frequency and output power at the time intervals shown on Transmitter Data Sheet 1. Record the following observations on Data Sheet 1:

- (a) Time of observation;
- (b) Output frequency in MHz;
- (c) Output power in watts.

Step 2. Results

- (a) Plot the Frequency Drift in % of Carrier Frequency, f_c , versus Time on Graph Sheet 1;
- (b) Plot the Output Power versus Time on Graph Sheet 1.

Evaluation Tests - Data Sheet 1
RF Telemetry Transmitter

Make: _____ ; Type: _____ ; Serial Number: _____
 Carrier Frequency fc: _____ MHz ; Date: _____ ; By: _____

I. Time Drift

Time Minutes	Output Frequency Mhz	Drift in % of Carrier Frequency	Output Power Watts
0			
1			
2			
3			
4			
5			
10			
15			
20			
25			
30			
40			
50			
60			
70			
80			
90			
100			
110			
120			

II. Temperature Stability

Temperature °C	Output Frequency Mhz	Shift in % of Carrier Frequency	Output Power Watts	Input Current	Incidental FM

III. B+ Voltage Regulation

B+ Voltage Variation %	Output Frequency Mhz	Shift in % of Carrier Frequency	Output Power Watts
+10			
+5			
0			
-5			
-10			

NORTHEASTERN UNIVERSITY

Evaluation Tests - RF Telemetry Transmitter - Sheet 1

Make: _____; Type: _____; Serial Number: _____

Carrier Frequency f_c : _____ MHz; Date: _____; By: _____

I. Time Drift

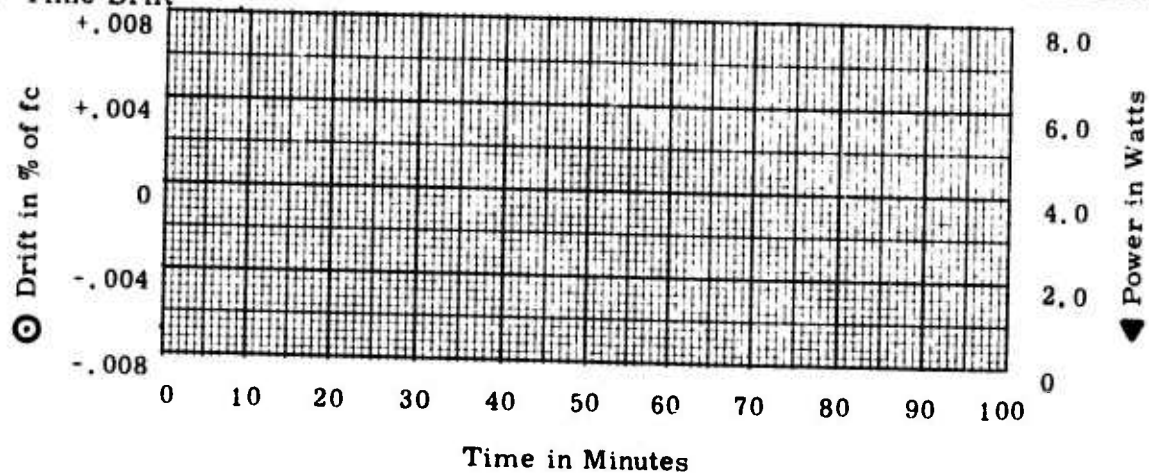

II. Temperature Stability

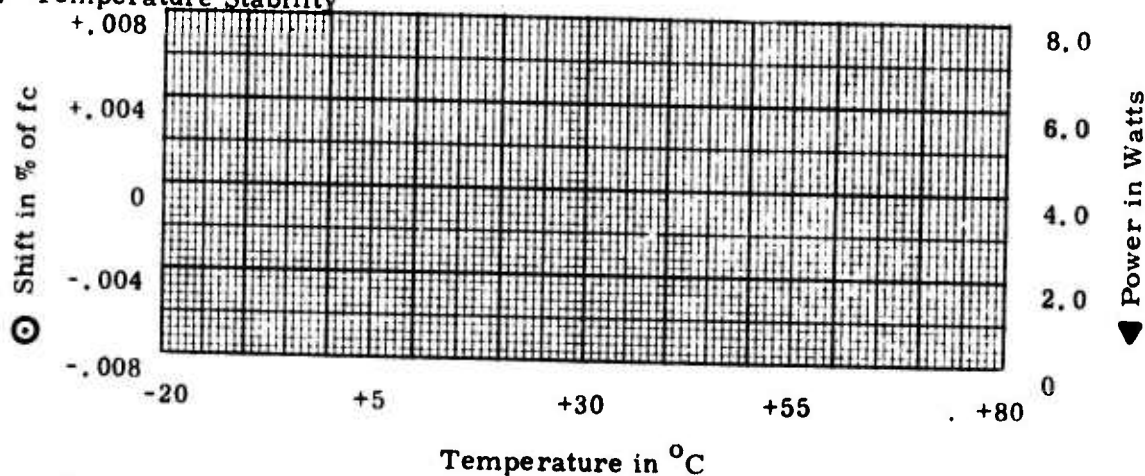

III. B⁺ Voltage Regulation

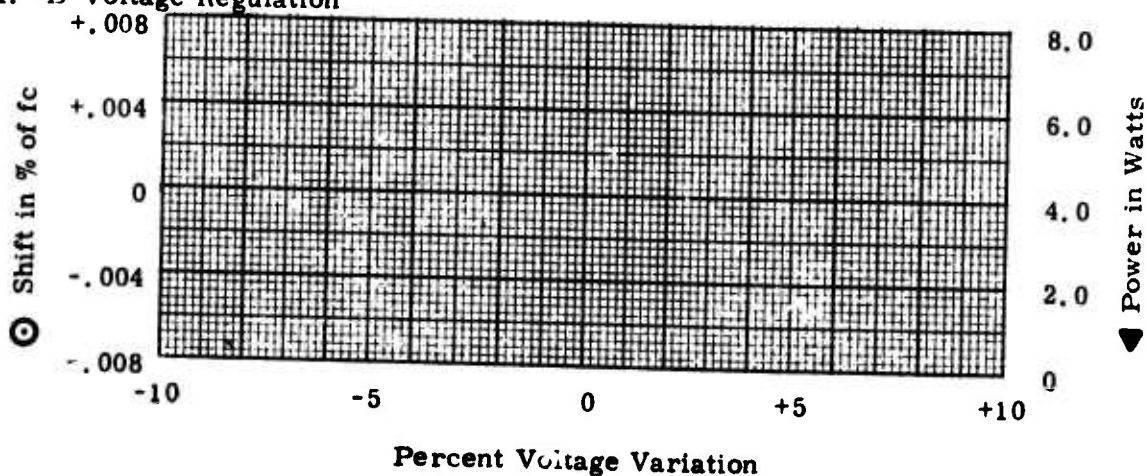

Test II. Temperature Stability Tests

- Step 1. With the temperature testing chamber set at $+30^{\circ}\text{C}$, wire test equipment as shown in Figure 1. Using recommended B+ supply voltage, allow a sufficient warm-up period before proceeding to Step 2.
- Step 2. Ground the modulation input terminal of the transmitter. Measure the output power and the carrier frequency. Record the following observations on Data Sheet 1:
- (a) Temperature in $^{\circ}\text{C}$;
 - (b) Output power in watts;
 - (c) Output frequency in MHz;
 - (d) Input current in amps;
 - (e) Incidental FM in Hz.
- Step 3. Repeat Steps 1 and 2 for the following temperatures: -20°C , $+5^{\circ}\text{C}$, 55°C and 80°C .
- Step 4. Calculate the frequency shift in % of f_c . Plot the % frequency shift versus temperature on Graph Sheet 1. Also plot the output power versus temperature on Graph Sheet 1.

Test III. Voltage Regulation

- Step 1. Use equipment set up shown in Figure 1. With the temperature of the chamber set at 30°C , vary the B+ supply voltage from -10% to $+10\%$. Record and compute the following on Data Sheet 1.
- (a) B+ supply in % of recommended value;
 - (b) Frequency shift in % of f_c ;
 - (c) Output power in watts.
- Step 2. Results
- Plot the % frequency shift and output power versus B+ supply variations on Graph Sheet 1.

Tests IV and V. Modulation Response and Linearity Tests

- Step 1. With the temperature testing chamber set at $+30^{\circ}\text{C}$, wire the test equipment as shown in Figure 2. Using recommended B+ supply voltage, allow a sufficient warm-up period before proceeding to Step 2.
- Step 2. Set the audio oscillator at each of the modulating frequencies indicated in Data Sheet 2A. Adjust the output level of the oscillator for the nominal deviation (E_4). Repeat for 25%, 50%, 75% and 125% of nominal deviation. Record the following observations on Data Sheet 2A.
- (a) Oven temperature in $^{\circ}\text{C}$;
 - (b) Modulating voltages E_1 , E_2 , E_3 , E_4 , E_5 ;
 - (c) Frequency deviation in KHz;
 - (d) Distortion.
- Step 3. Repeat Steps 1 and 2 using modulating voltage E_4 , for the following temperatures; -20°C , $+5^{\circ}\text{C}$, 55°C and 80°C and record on Data Sheet 2.

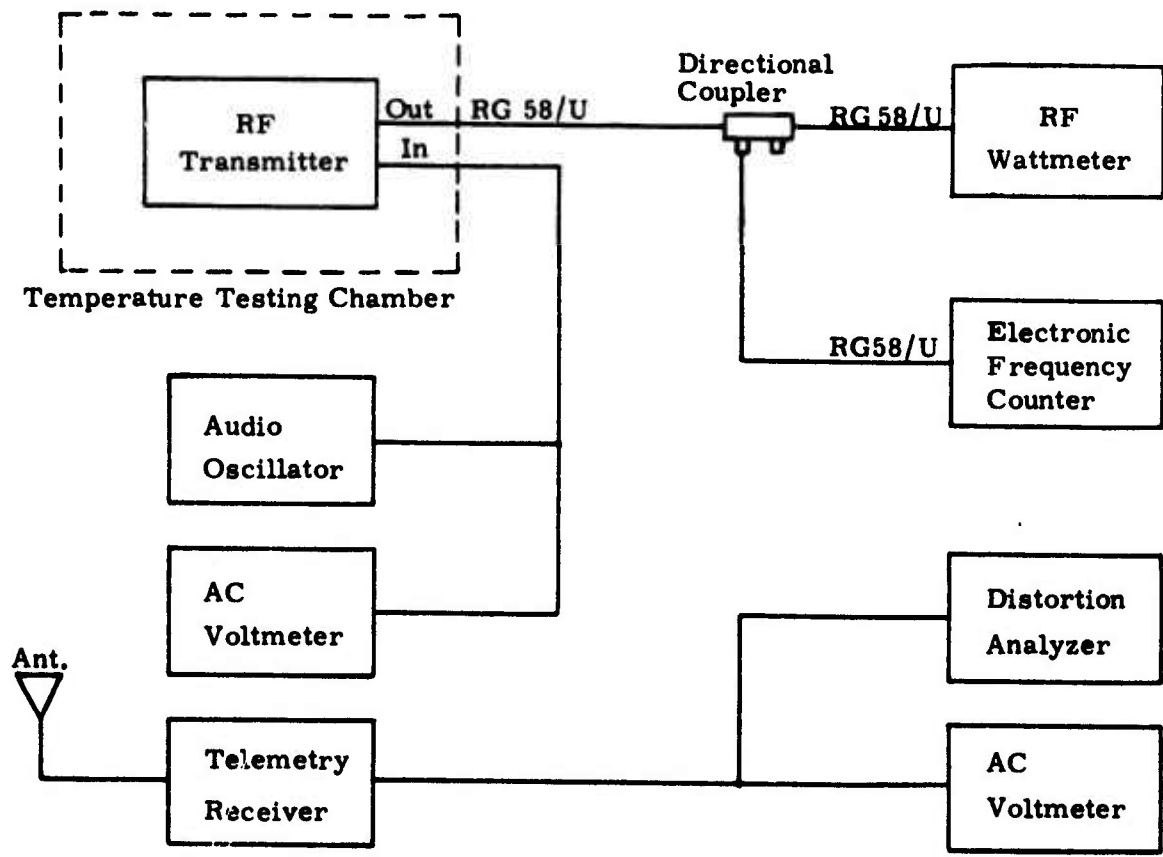

FIGURE 2.

Evaluation Tests - Data Sheet 2
RF Telemetry Transmitter

Make: _____; Type: _____; Serial No: _____;
Carrier Frequency fc: _____; Mhz Date: _____; By: _____;

II MODULATION RESPONSE VS TEMPERATURE

T = _____ °c; Modulation Voltage = _____ Volts

Modulating Frequency fm KHz	Deviation Δfc in KHz	DB = 20 Log $\frac{\Delta fc}{\Delta fco}$		Distortion
		$\Delta fc / \Delta fco$	DB	
.4				
.6				
.8				
1				
2				
4				
6				
8				
10				
20				
40				
60				
80				
100				
200				
300				
400				
500				

$$\Delta fco = \sqrt{\Delta fc \text{ Min} \times \Delta fc \text{ Max}}$$

Evaluation Tests - Data Sheet 2A
RF Telemetry Transmitter

Make: _____; Type: _____; Serial No: _____;
Carrier Frequency f_c : _____; Mhz Date: _____; By: _____;

LINEARITY VS FREQUENCY
T = AMBIENT

Modulating Frequency fm Khz	Deviation Δf_c in Khz					Distortion
	E1	E2	E3	E4	E5	
.4						
.6						
.8						
1						
2						
4						
6						
8						
10						
20						
40						
60						
80						
100						
200						
300						
400						
500						

Step 4. Calculations and Results

- (a) Linearity at Ambient - Plot deviation versus modulating frequency for the five modulating voltages on Graph Sheet 2.
- (b) Modulation Response - Calculate the modulation response in db using information from Data Sheet 2. Plot modulation response versus modulating frequency for the five different temperatures on Graph Sheet 2.

Test VI. Spurious Emission (Antenna Conducted)

- Step 1. Tune the band elimination filter for maximum attenuation at the carrier frequency of the transmitter under test. The amount of attenuation should be such that the transmitter rf output is attenuated to -40dbm. Make a frequency response of the filter and spectrum analyzer and plot the response curve.

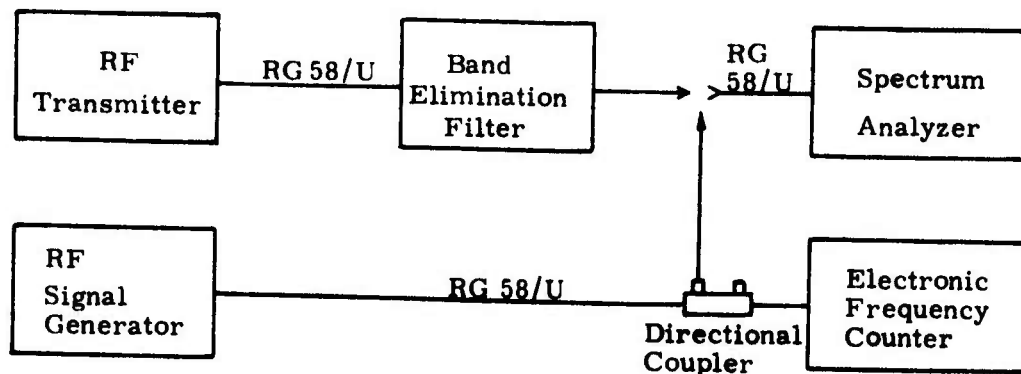

FIGURE 3.

- Step 2. Use equipment set-up shown in Figure 3. Identify and measure the spurious frequencies present using the spectrum analyzer. The frequency may be measured accurately by comparison with a known frequency from the signal generator.
- Step 3. Use the frequency response obtained in Step 1 to make appropriate amplitude corrections. Record the frequencies and amplitudes of the spurious emissions on Result Sheet 3.

NORTHEASTERN UNIVERSITY

Evaluation Tests - RF Telemetry Transmitter - Sheet 2

Make: _____; Type: _____; Serial Number: _____;
Carrier Frequency fc: _____ MHz; Date: _____; By: _____

IV. Modulation Response vs. Temperature

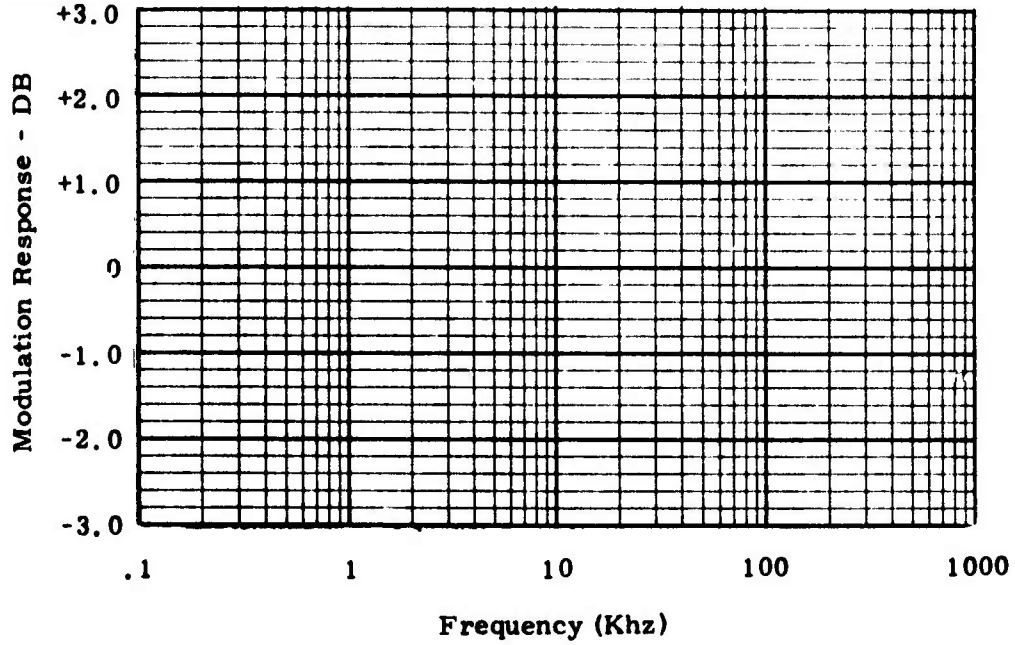

V. Linearity at Ambient

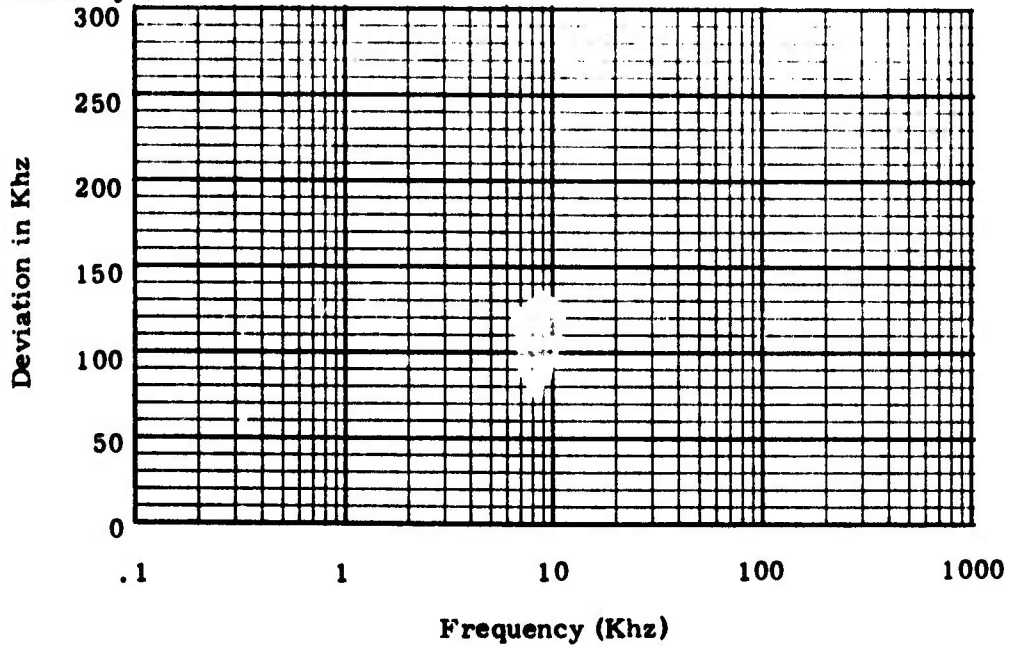

NORTHEASTERN UNIVERSITY

Evaluation Tests - RF Telemetry Transmitter - Sheet 3

Make: _____; Type: _____; Serial Number: _____
 Carrier Frequency f_c : _____ MHz; Date: _____; By: _____

VI. Spurious Emission (Antenna Conducted)

Frequency Mhz	DB Down from f_c	Identification

NOTE: W.S.M.R. Regulation No. 105-2-60 requirement is $55+10 \log P_t$ DB Down from carrier.

VII. Miscellaneous

1. Maximum Distortion _____
2. Incidental FM _____
3. Power Requirement _____
4. Efficiency _____
5. O.C. & S.C. Protection _____
6. Other Checks _____

Test VII. Miscellaneous

- Step 1. Record maximum distortion from Data Sheet 2.
- Step 2. Record maximum incidental FM from Data Sheet 1.
- Step 3. Computer power requirements and efficiency from information on Data Sheet 1.
- Step 4. Perform open circuit and short circuit tests and record if the transmitter is within the manufacturer's specifications.

B. Test Results for RF Transmitters

Table 1 contains information regarding the manufacture, type and number of transmitters tested during the period of 9 January 1975 to 13 February 1976. The remainder of this chapter contains the test results for each transmitter in the order listed in the table.

Table 1

<u>Manufacturer</u>	<u>Type</u>	<u>Number Tested</u>
CONIC	CTP-402	6
CONIC	CTS-402	17
RAYTHEON	T-201	2
VECTOR	T/05S	1
VECTOR	T202S	2

Evaluation Tests - Proprietary Information Sheet

RF Telemetry Transmitters

Make: Conic;

Type: CTP - 402;

Manufacturer's Specifications

<u>Frequency Range</u>	Crystal Controlled (single frequency) VHF Telemetry Band 225 - 260 MHz (other frequencies available on special order)
<u>Center Frequency Stability</u>	0.01% under environmental operating conditions.
<u>Power Output</u>	2 watts minimum - terminated into 50 ohms with 28 ± 4 Vdc supply over specified temperature range.
<u>Carrier Deviation</u>	± 250 kHz
<u>Modulation Characteristics</u>	
<u>Type</u>	FM
<u>Deviation Sensitivity</u>	up to ± 150 kHz/volt p-p (factory set)
<u>Input Impedance</u>	10 K ohms resistive minimum, shunted by 30 pf
<u>Frequency Response</u>	± 1.5 dB from 10 Hz to 500 kHz
<u>Power Requirements</u>	28 ± 4 Vdc at 450 milliamperes maximum
<u>Radio Frequency Interference</u>	Satisfies the requirements of IRIG 106-69 for antenna conducted and radiated and MIL - I - 28600 for box and power line conducted and radiated.
<u>Temperature</u>	- 30 ^o C to +80 ^o C, MIL-STD-810 as follows: Low Temperature, Method 502 High Temperature, Method 501 Temperature Shock, Method 503
<u>Humidity</u>	MIL-STD-810, Method 507
<u>Acceleration</u>	100 g's in each direction of any three mutual perpendicular axes.
<u>Shock</u>	100 g's 11 millisecond duration (half sine pulse) in each direction of any three mutually perpendicular axes.
<u>Vibration</u>	20 G peak sine (20-2000 Hz) or .3 G ² /cps random in any axis.
<u>Weight</u>	Less than 12 ounces.

NORTHEASTERN UNIVERSITY

Evaluation Tests - RF Telemetry Transmitter - Sheet 1

Make: CONIC ; Type: CTP-402 ; Serial Number: 402 P 191 ;

Carrier Frequency f_c : 234.0 MHz; Date: 3/17/75 ; By: J.F.E. ;

I. Time Drift

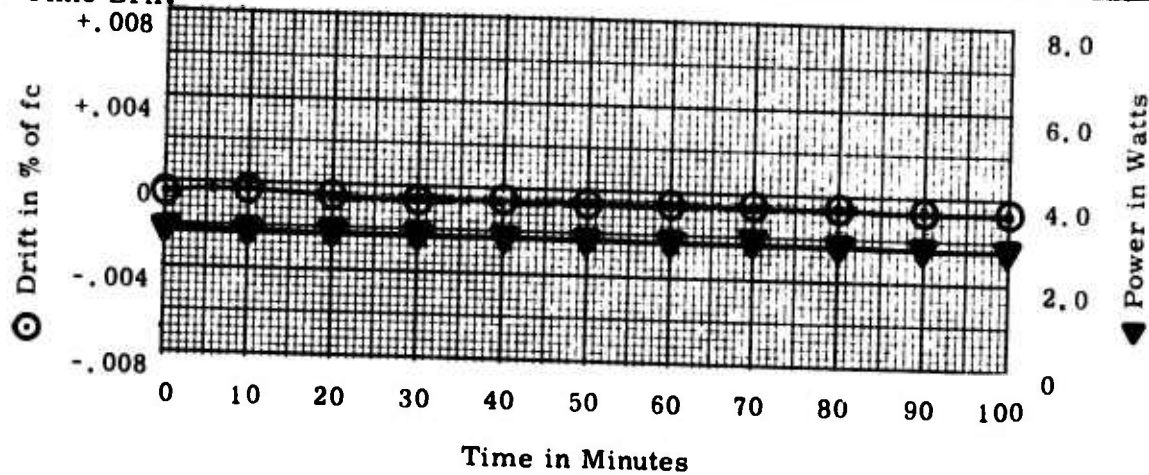

II. Temperature Stability

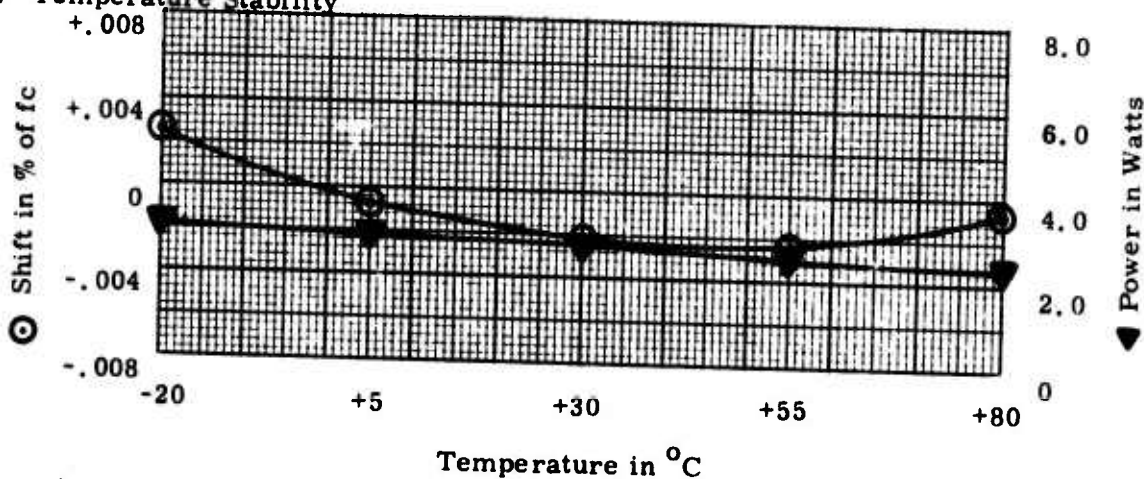

III. B⁺ Voltage Regulation

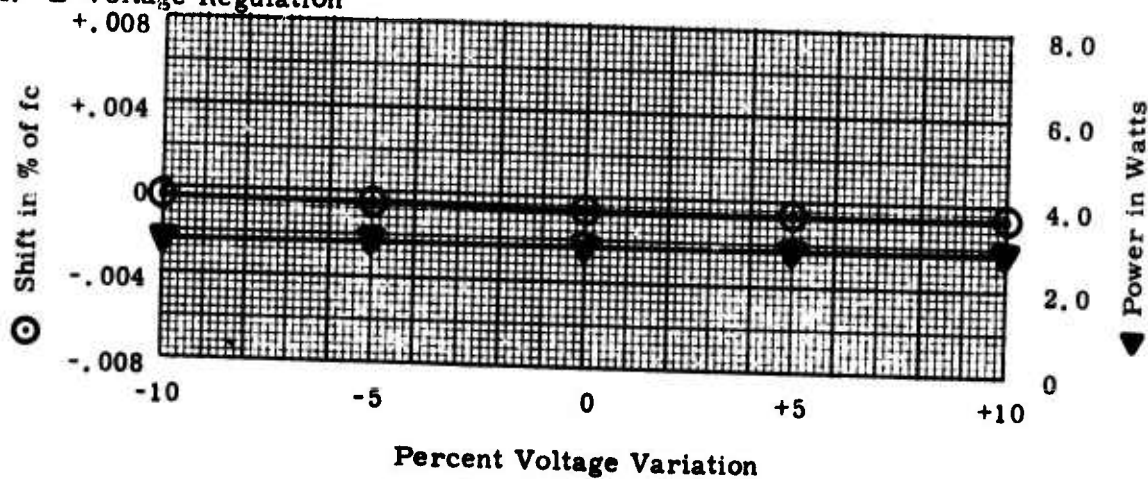

NORTHEASTERN UNIVERSITY

Evaluation Tests - RF Telemetry Transmitter - Sheet 2

Make: CONIC ; Type: CTP-402 ; Serial Number: 402 P 191 ;
 Carrier Frequency f_c : 234.0 MHz; Date: 3/17/75 ; By: J.F.E.

IV. Modulation Response vs. Temperature

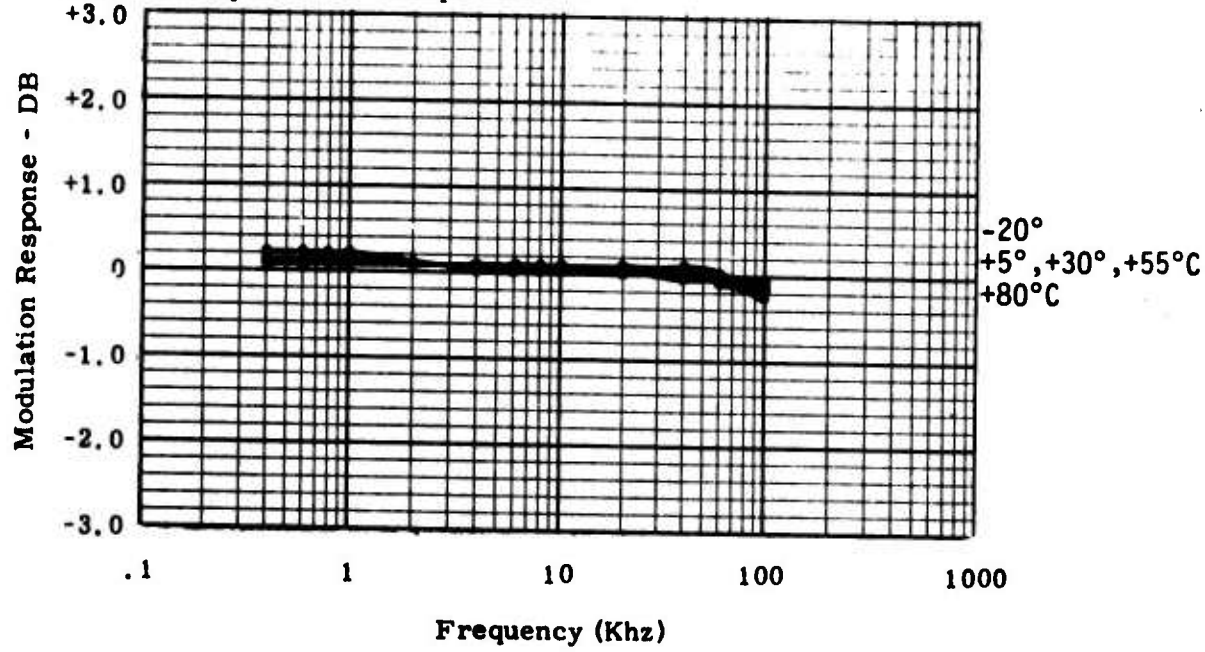

V. Linearity at Ambient

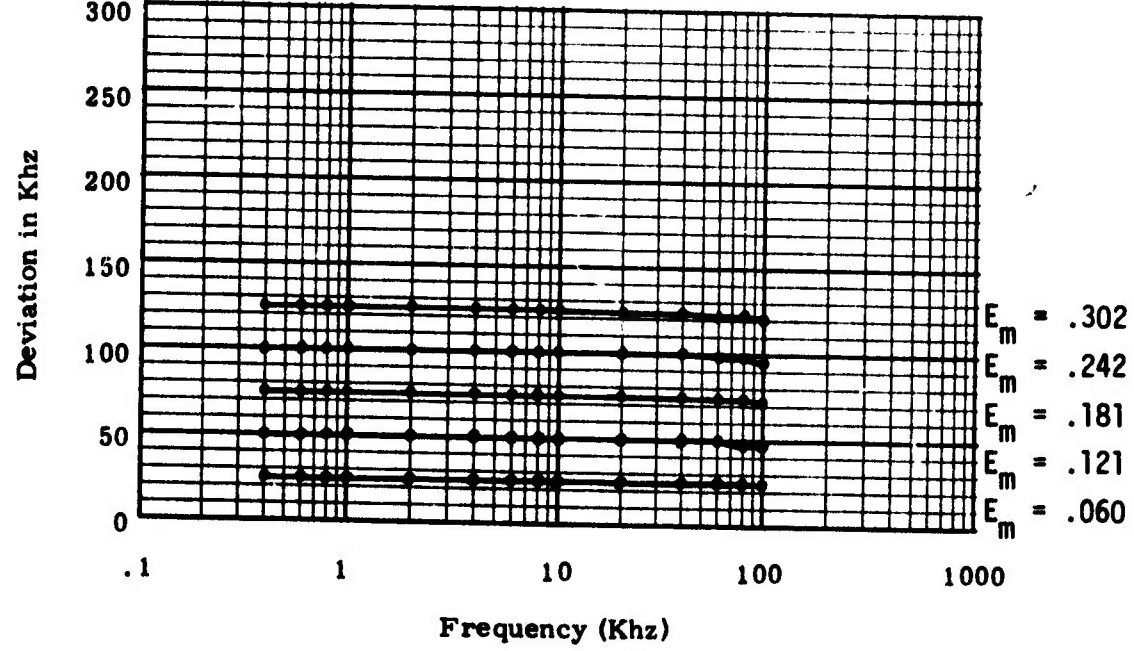

NORTHEASTERN UNIVERSITY

Evaluation Tests - RF Telemetry Transmitter - Sheet 3

Make: CONIC ; Type: CTP-402 ; Serial Number: 402 P 191
 Carrier Frequency fc: 234.0 MHz; Date: 3/17/75 ; By: J.F.E.

VI. Spurious Emission (Antenna Conducted)

Frequency Mhz	DB Down from fc	Identification
85.6	88+3	fc - 14fx
95.4	79+3	fc - 13fx
138.6	85+3	fc - 9fx
149.2	89+3	fc - 8fx
170.4	86+3	fc - 6fx
191.6	77+3	fc - 4fx
212.8	79+3	fc - 2fx
223.4	80+3	fc - fx
234.0	0	carrier frequency
244.6	78+3	fc + fx
255.2	77+3	fc + 2fx
276.4	82+3	fc + 4fx
287.0	103+3	fc + 5fx
297.6	105+3	fc + 6fx
468.0	72+3	2fc

NOTE: W.S.M.R. Regulation No. 105-2-60 requirement is $55+10 \log P_t$ DB Down from carrier.

VII. Miscellaneous

1. Maximum Distortion 0.95%
2. Incidental FM <500 Hz PEAK
3. Power Requirement 12.3 watts
4. Efficiency 23.2%
5. O.C. & S.C. Protection OK
6. Other Checks freq. at 5:1 VSWR = 234.0060
carrier shift = -0.0026% of fc for 5:1 VSWR

NORTHEASTERN UNIVERSITY

Evaluation Tests - RF Telemetry Transmitter - Sheet 1

Make: CONIC ; Type: CTP-402 ; Serial Number: 402 P 192

Carrier Frequency f_c : 234.0 MHz; Date: 3/21/75 ; By: JFE

I. Time Drift

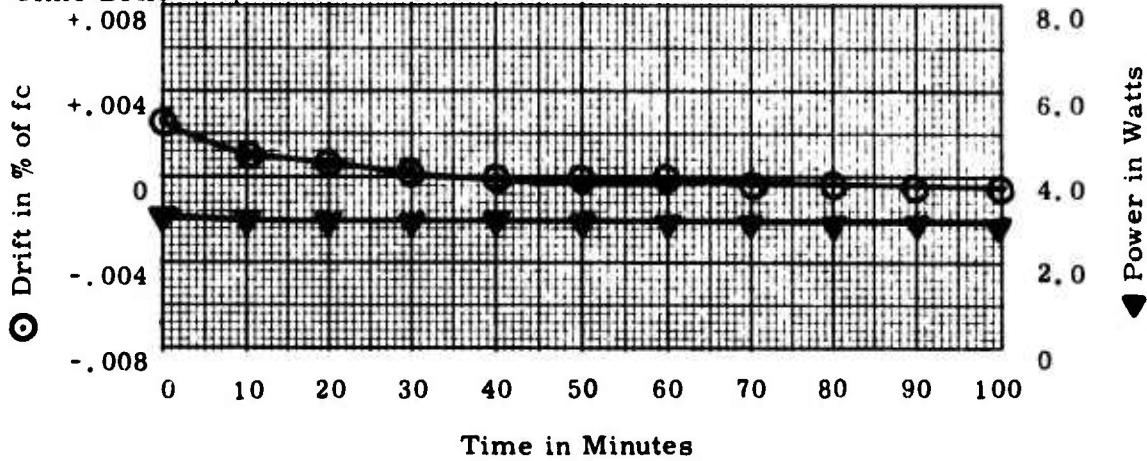

II. Temperature Stability

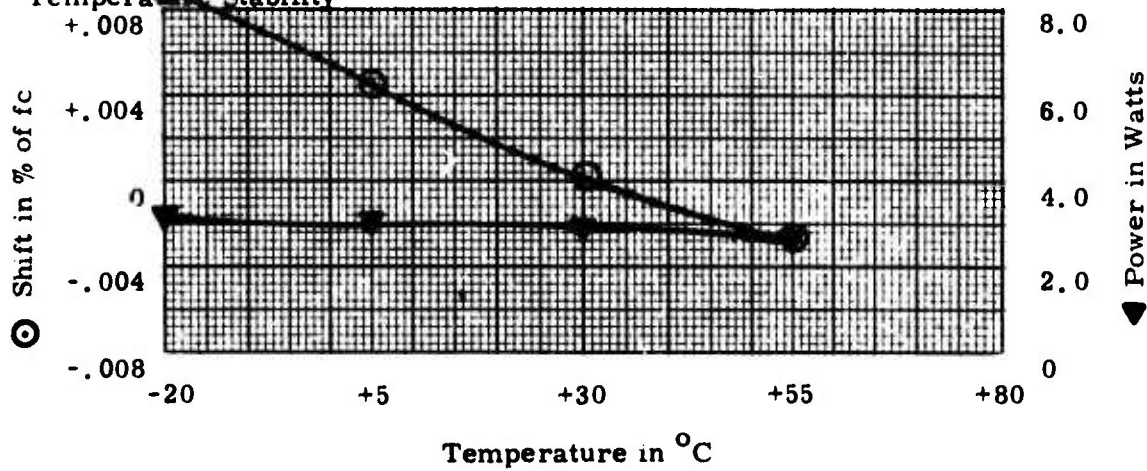

III. B⁺ Voltage Regulation

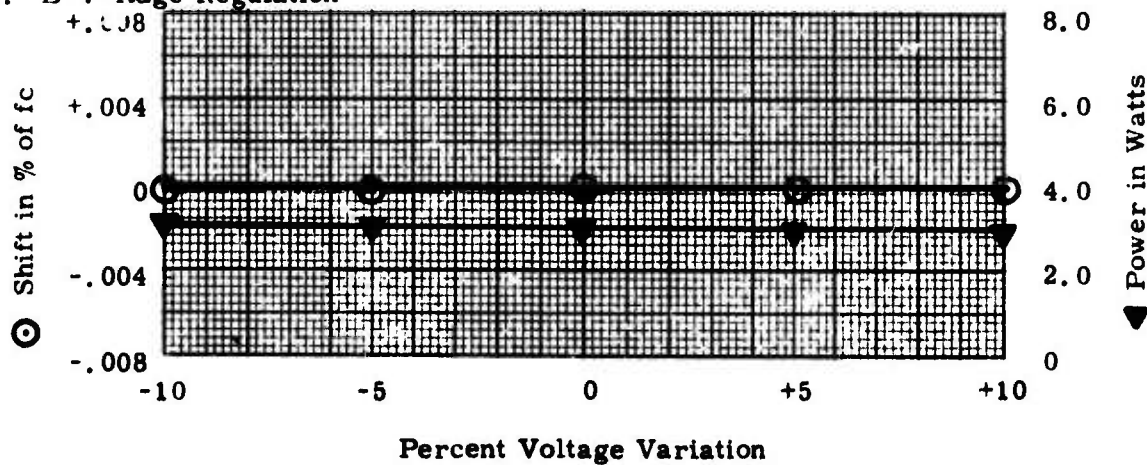

NORTHEASTERN UNIVERSITY

Evaluation Tests - RF Telemetry Transmitter - Sheet 2

Make: CONIC ; Type: CTP-402 ; Serial Number: 402 P 192 ;
 Carrier Frequency f_c : 234.0 MHz; Date: 3/21/75 ; By: JFE ;

IV. Modulation Response vs. Temperature

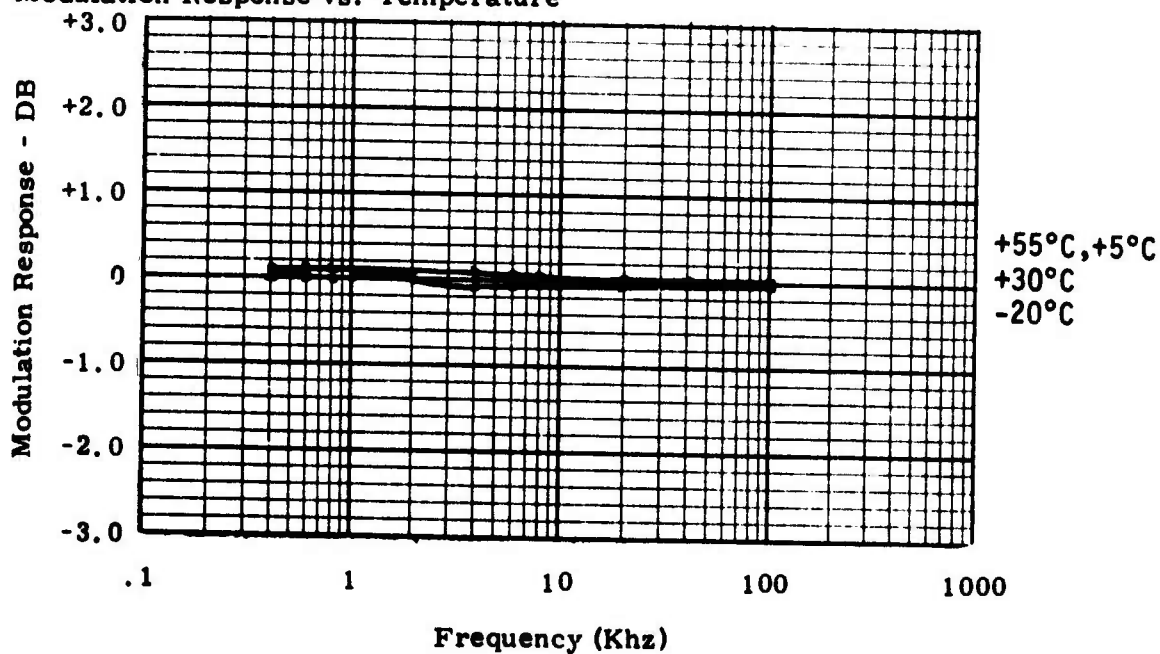

V. Linearity at Ambient

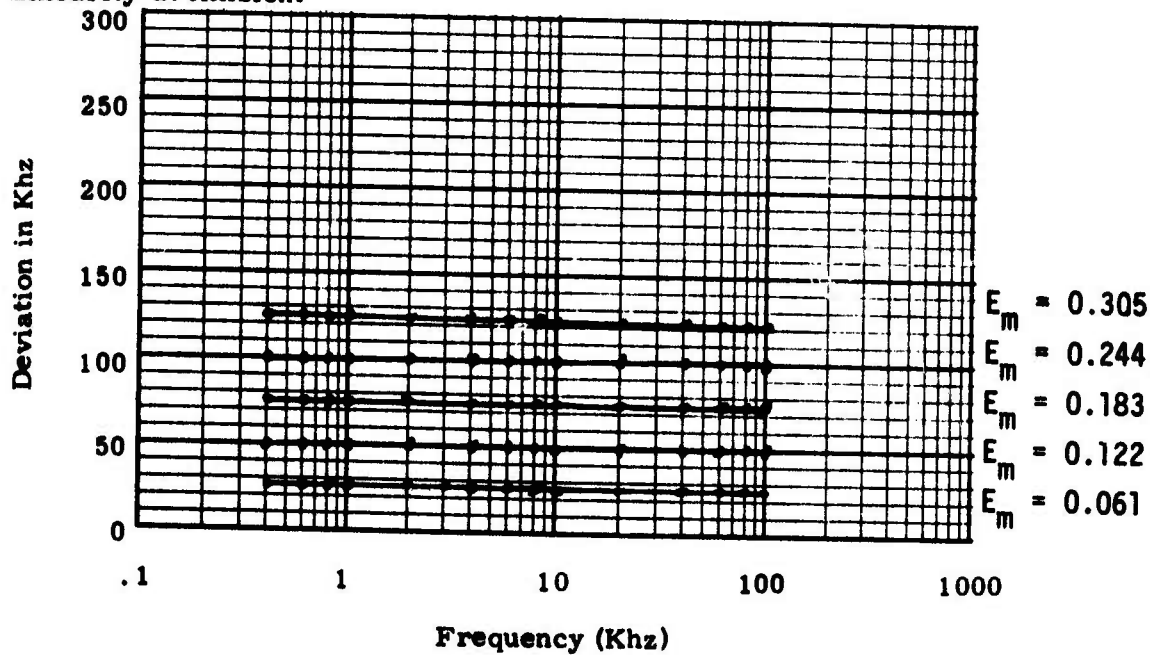

NORTHEASTERN UNIVERSITY

Evaluation Tests - RF Telemetry Transmitter - Sheet 3

Make: CONIC ; Type: CTP-402 ; Serial Number: 402 P 192
 Carrier Frequency f_c : 234.0 MHz; Date: 3/21/75 ; By: JFE

VI. Spurious Emission (Antenna Conducted)

Frequency Mhz	DB Down from f_c	Identification
All Spurious Emissions meet IRIG Standards.		

NOTE: W. S. M. R. Regulation No. 105-2-60 requirement is $55+10 \log P_t$ DB Down from carrier.

VII. Miscellaneous

1. Maximum Distortion <2.0%
2. Incidental FM <500 Hz PEAK
3. Power Requirement 11.2 watts
4. Efficiency 27.0%
5. O.C. & S.C. Protection O.K.
6. Other Checks 5:1 VSWR = 234.0001
carrier shift = +0.00004% of f_c at 5:1 VSWR

* At 62°C becomes unstable, power output, input current fluctuate; input current drops to = .2Amps.

NORTHEASTERN UNIVERSITY

Evaluation Tests - RF Telemetry Transmitter - Sheet 1

Make: CONIC ; Type: CTP-402 ; Serial Number: 402 P 193 ;

Carrier Frequency f_c : 240.2 MHz; Date: 3/18/75 ; By: J.F.E.

I. Time Drift

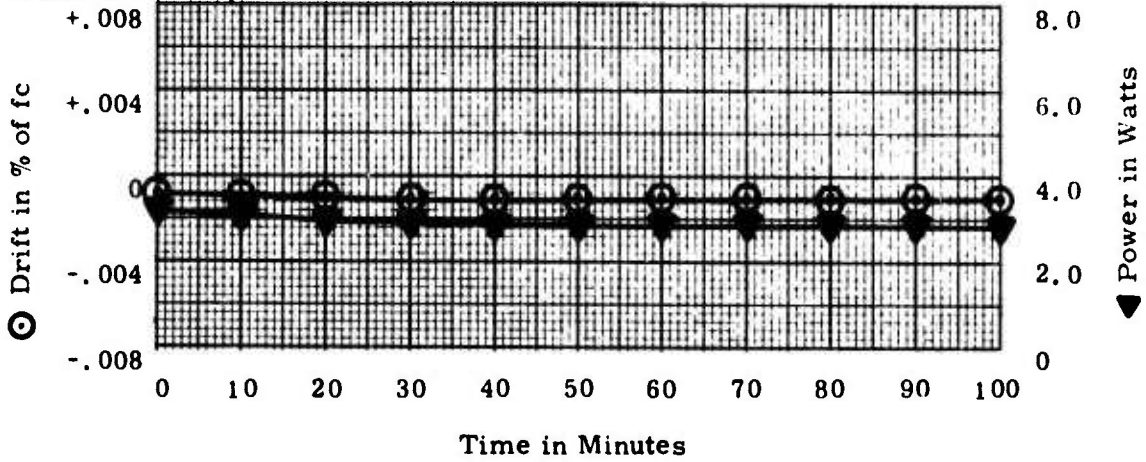

II. Temperature Stability

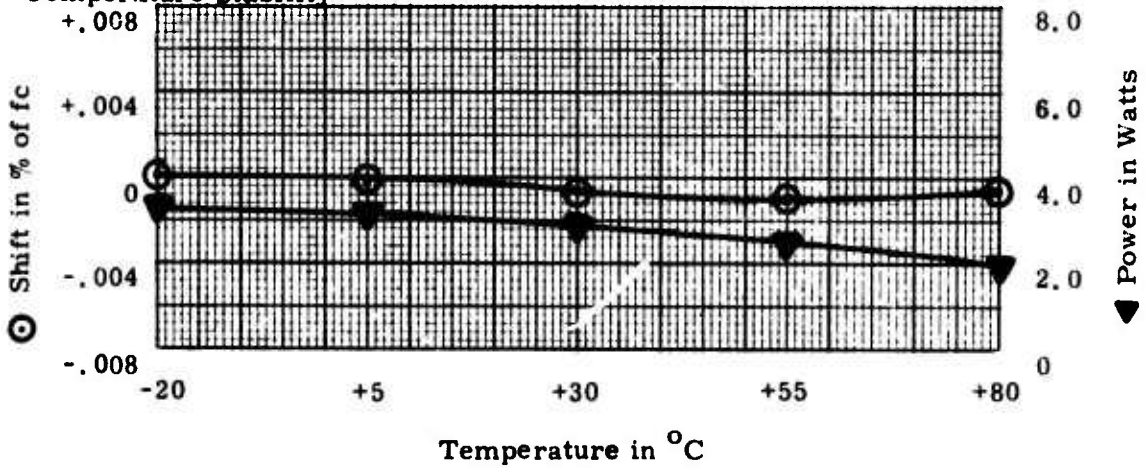

III. B^+ Voltage Regulation

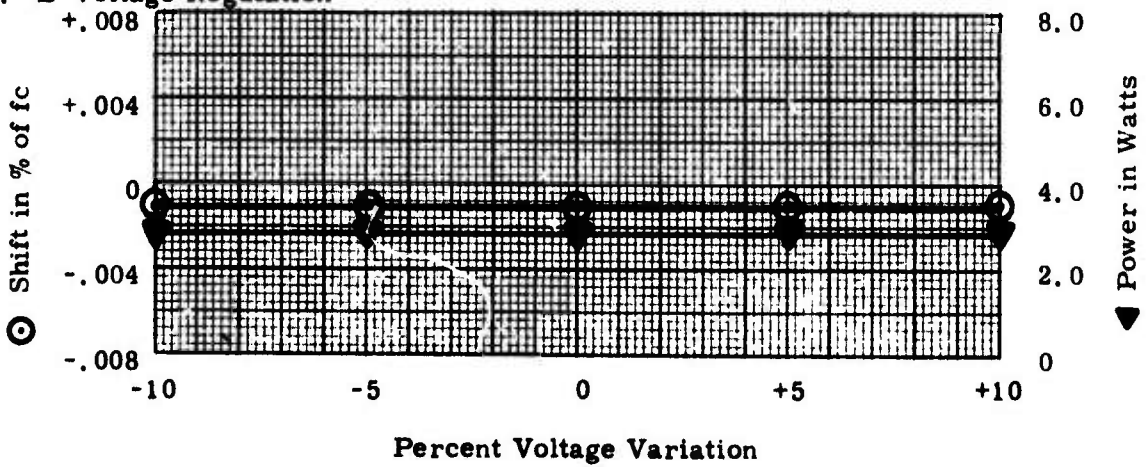

NORTHEASTERN UNIVERSITY

Evaluation Tests - RF Telemetry Transmitter - Sheet 2

Make: CONIC ; Type: CTP-402 ; Serial Number: 402 P 193
 Carrier Frequency f_c : 240.2 MHz; Date: 3/18/75 ; By: J.F.E.

IV. Modulation Response vs. Temperature

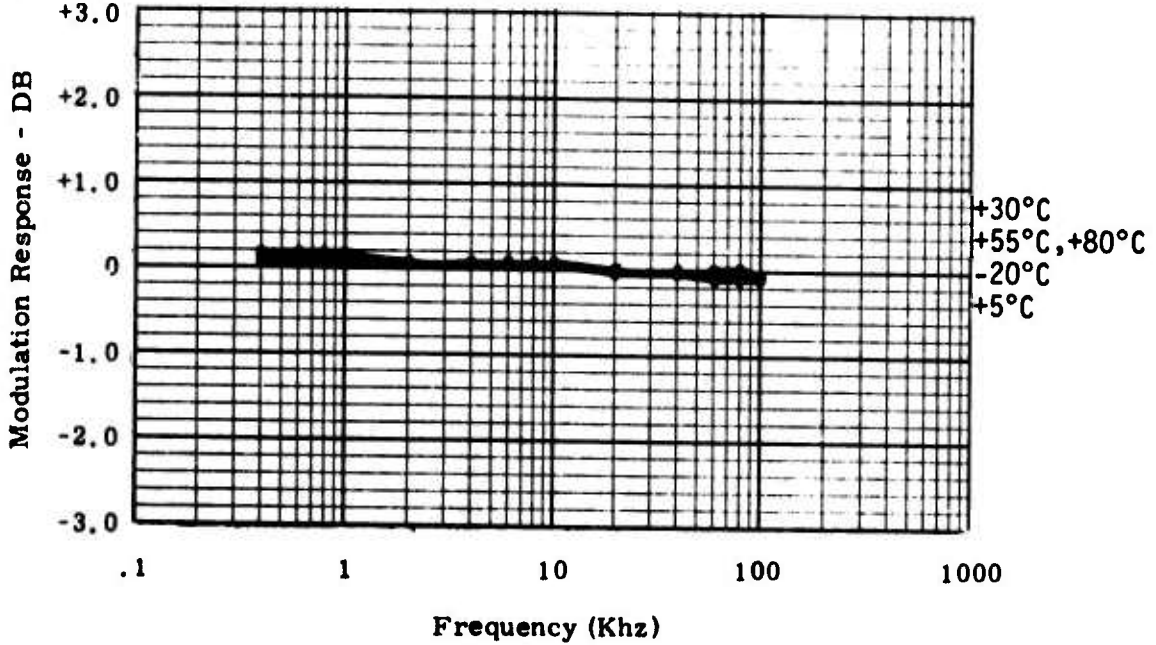

V. Linearity at Ambient

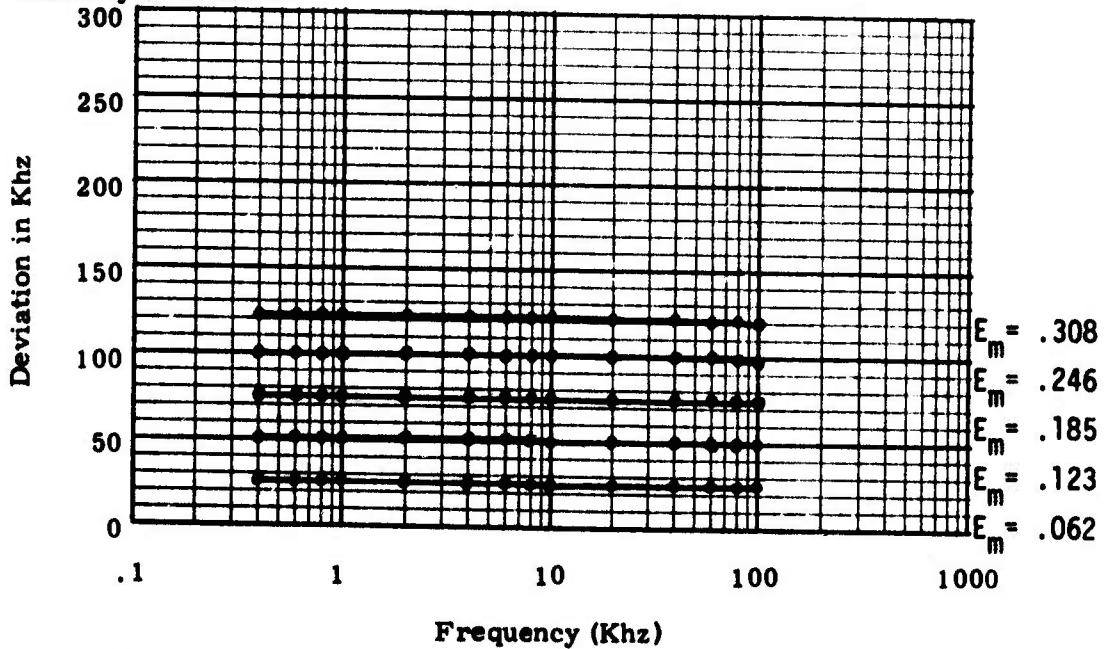

NORTHEASTERN UNIVERSITY

Evaluation Tests - RF Telemetry Transmitter - Sheet 3

Make: CONIC ; Type: CTP-402 ; Serial Number: 402 P 193
 Carrier Frequency fc: 240.2 MHz; Date: 3/18/75 ; By: J.F.E.

VI. Spurious Emission (Antenna Conducted)

Frequency Mhz	DB Down from fc	Identification
97.8	91+3	fc - 16fx
142.3	87+3	fc - 11fx
151.2	80+3	fc - 10fx
177.9	90+3	fc - 7fx
186.8	94+3	fc - 6fx
195.7	90+3	fc - 5fx
204.6	93+3	fc - 4fx
222.4	91+3	fc - 2fx
231.3	77+3	fc - fx
240.2	0	carrier frequency
249.7	79+3	fc + fx
258.0	95+3	fc + 2fx
275.8	85+3	fc + 4fx
284.7	89+3	fc + 5fx
293.6	110+3	fc + 6fx
302.5	114+3	fc + 7fx
329.2	116+3	fc + 10fx
480.4	68+3	2fc

NOTE: W. S. M. R. Regulation No. 105-2-60 requirement is $55+10 \log P_t$ DB Down from carrier.

VII. Miscellaneous

1. Maximum Distortion 0.63%
2. Incidental FM <500Hz PEAK
3. Power Requirement 12.3 Watts
4. Efficiency 23.4%
5. O.C. & S.C. Protection OK
6. Other Checks freq. at 5:1VSWR = 240.2182
carrier shift = -0.0076% of fc for 5:1 VSWR

NORTHEASTERN UNIVERSITY

Evaluation Tests - RF Telenetry Transmitter - Sheet 1

Make: CONIC ; Type: CTP-402 ; Serial Number: 402 P 194

Carrier Frequency f_c : 240.2 MHz; Date: 3/18/75 ; By: J.F.E.

I. Time Drift

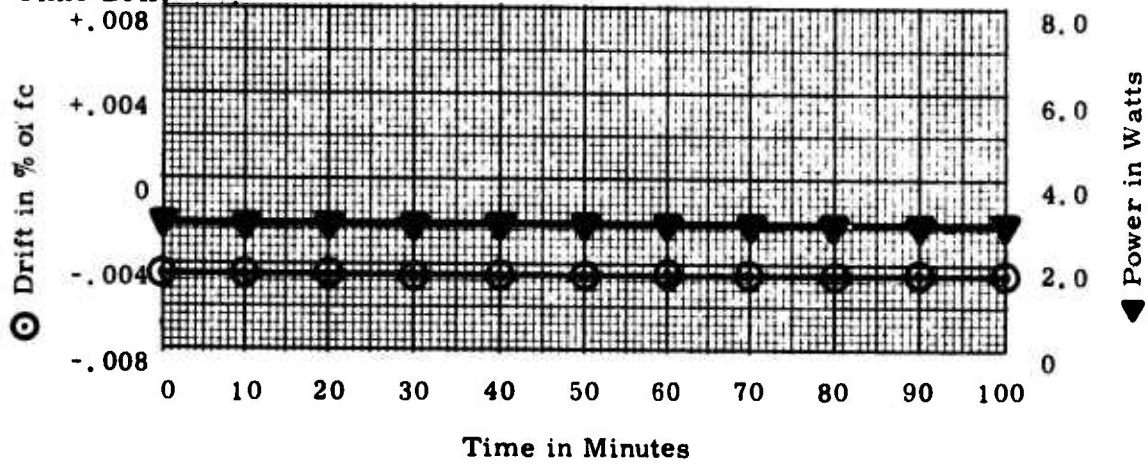

II. Temperature Stability

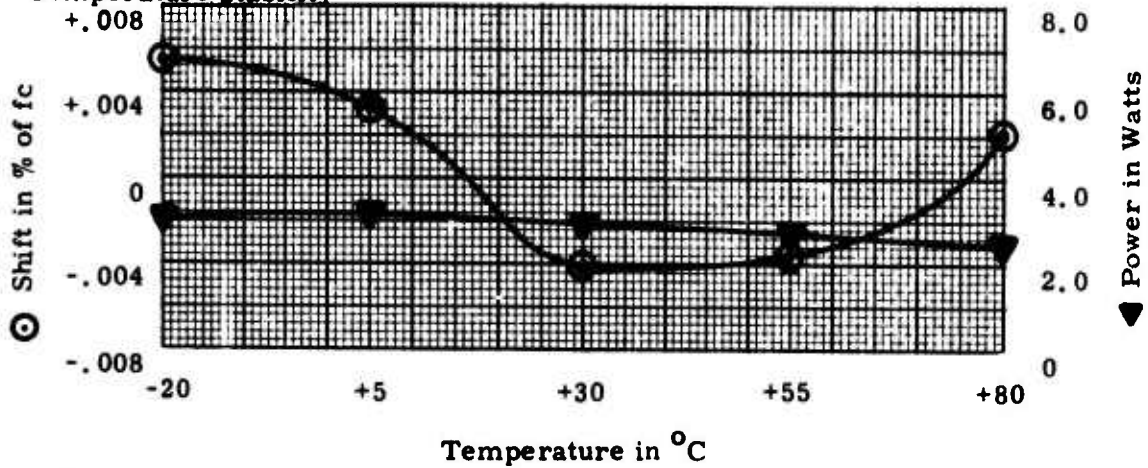

III. B^+ Voltage Regulation

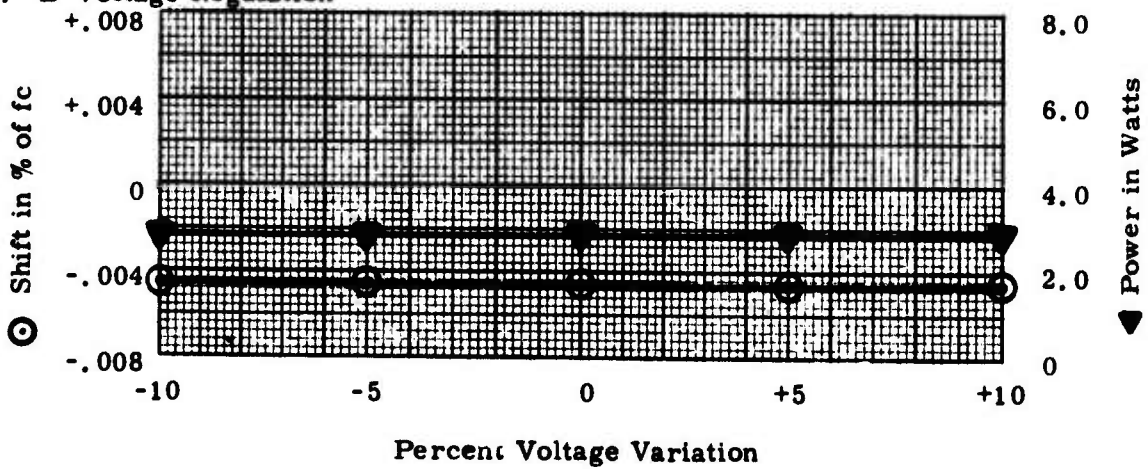

NORTHEASTERN UNIVERSITY

Evaluation Tests - RF Telemetry Transmitter - Sheet 2

Make: CONIC ; Type: CTP-402 ; Serial Number: 402 P 194 ;
Carrier Frequency f_c : 240.2 MHz; Date: 3/18/75 ; By: J.F.E. ;

IV. Modulation Response vs. Temperature

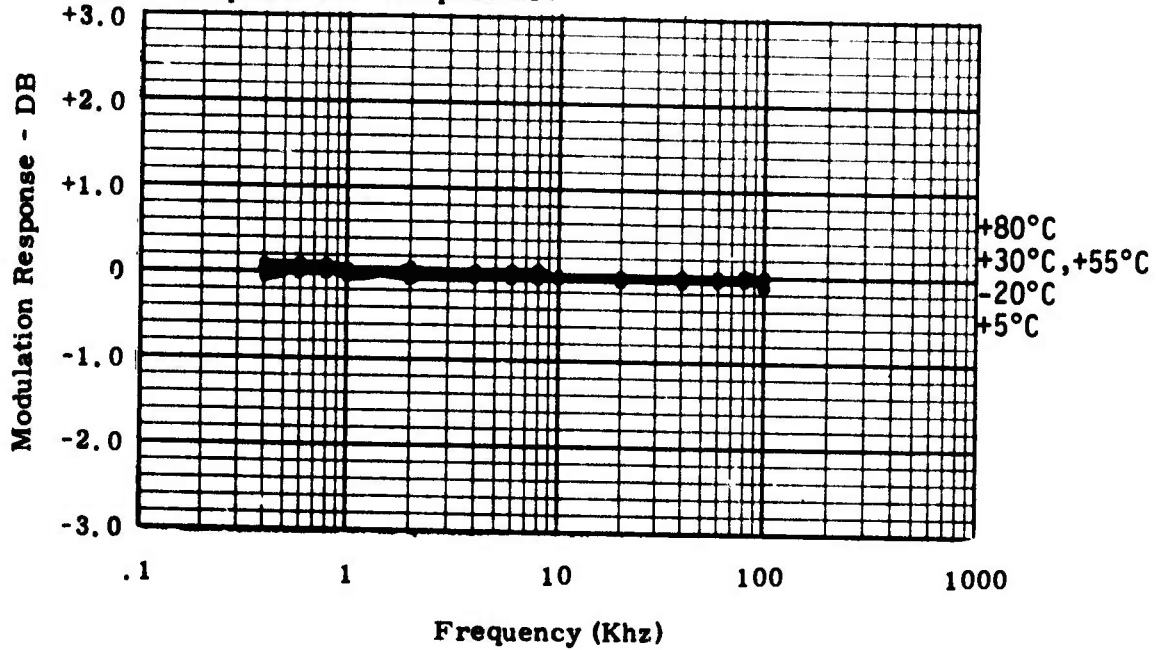

V. Linearity at Ambient

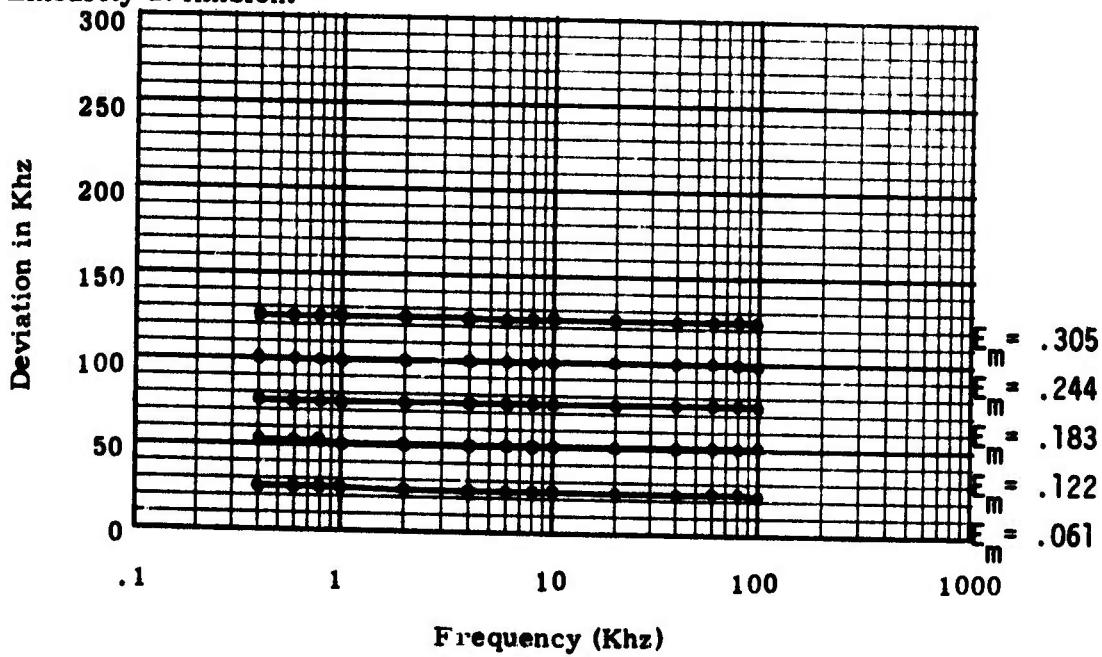

NORTHEASTERN UNIVERSITY

Evaluation Tests - RF Telemetry Transmitter - Sheet 3

Make: CONIC ; Type: CTP-402 ; Serial Number: 402 P 194
 Carrier Frequency fc: 240.2 MHz; Date: 3/18/75 ; By: J.F.E.

VI. Spurious Emission (Antenna Conducted)

Frequency Mhz	DB Down from fc	Identification
88.9	82+3	fc - 17fx
97.8	86+3	fc - 16fx
151.2	84+3	fc - 10fx
177.9	91+3	fc - 7fx
186.8	87+3	fc - 6fx
195.7	69+3	fc - 5fx
213.3	90+3	fc - 3fx
222.4	94+3	fc - 2fx
231.3	87+3	fc - 1fx
240.2	0	carrier frequency
249.1	82+3	fc + 1fx
258.0	85+3	fc + 2fx
266.9	95+3	fc + 3fx
284.7	77+3	fc + 5fx
293.6	99+3	fc + 6fx
302.5	111+3	fc + 7fx
480.4	77+3	2fc
720.0	76+3	3fc

NOTE: W. S. M. R. Regulation No. 105-2-60 requirement is $55+10 \log P_t$ DB Down from carrier.

VII. Miscellaneous

1. Maximum Distortion 0.68%
2. Incidental FM <500 Hz PEAK
3. Power Requirement 10.6 watts
4. Efficiency 27.4%
5. O.C. & S.C. Protection OK
6. Other Checks freq. at 5:1 VSWR = 240.2019
carrier shift = -0.0033% of fc for 5:1 VSWR

NORTHEASTERN UNIVERSITY

Evaluation Tests - RF Telemetry Transmitter - Sheet 1

Make: CONIC ; Type: CTP-402 ; Serial Number: 402 P 195
 Carrier Frequency f_c : 244.3 MHz; Date: 3/19/75 ; By: J.F.E.

I. Time Drift

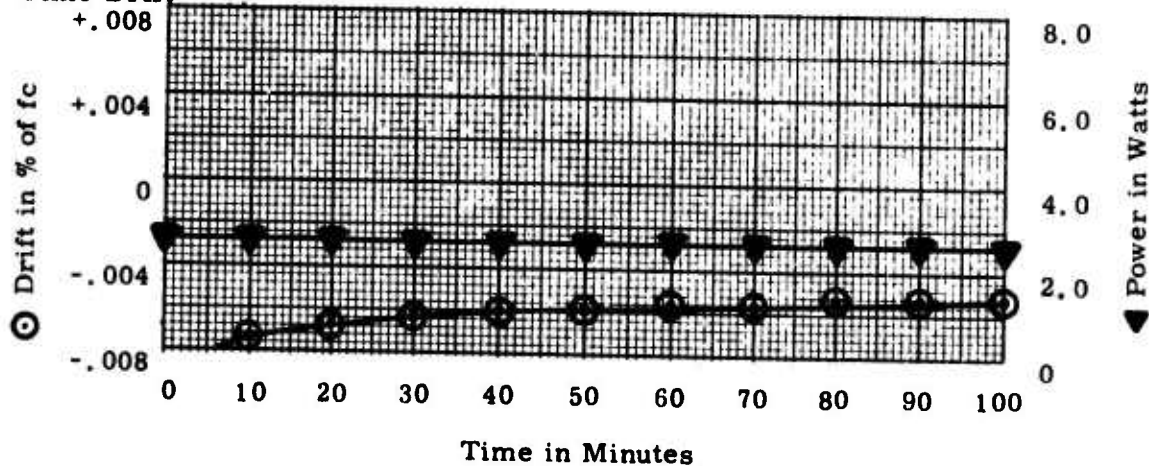

II. Temperature Stability

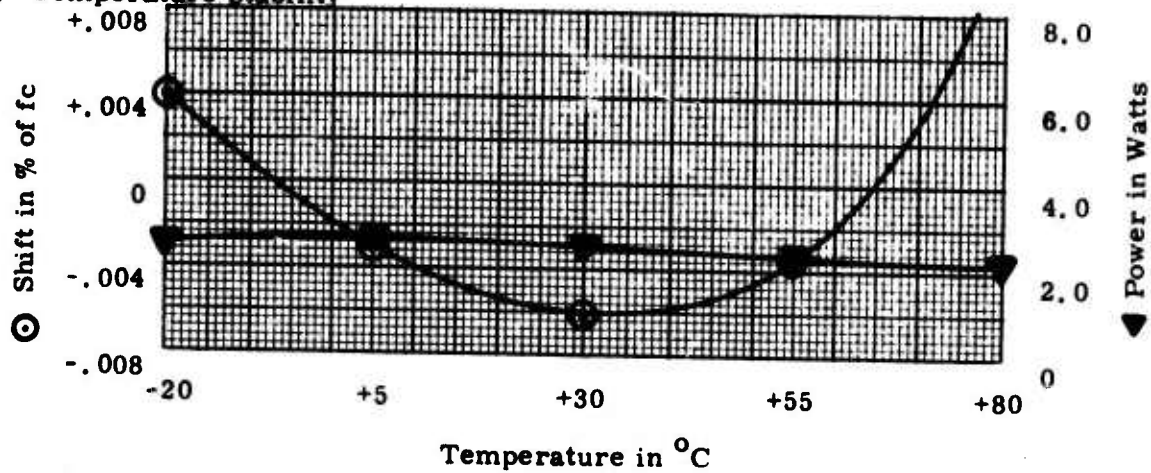

III. B⁺ Voltage Regulation

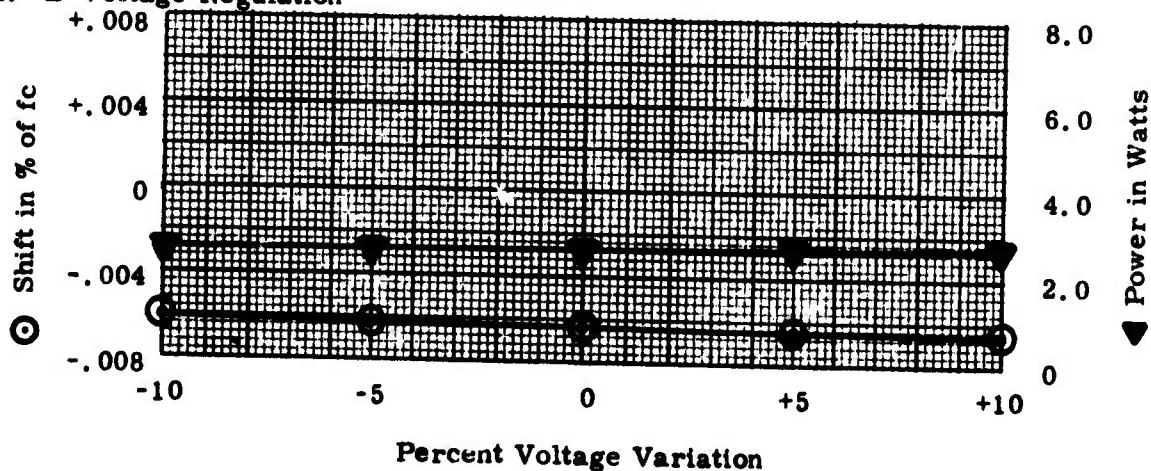

NORTHEASTERN UNIVERSITY

Evaluation Tests - RF Telemetry Transmitter - Sheet 2

Make: CONIC ; Type: CTP-402 ; Serial Number: 402 P 195 ;
 Carrier Frequency f_c : 244.3 MHz; Date: 3/19/75 ; By: J.F.E. ;

IV. Modulation Response vs. Temperature

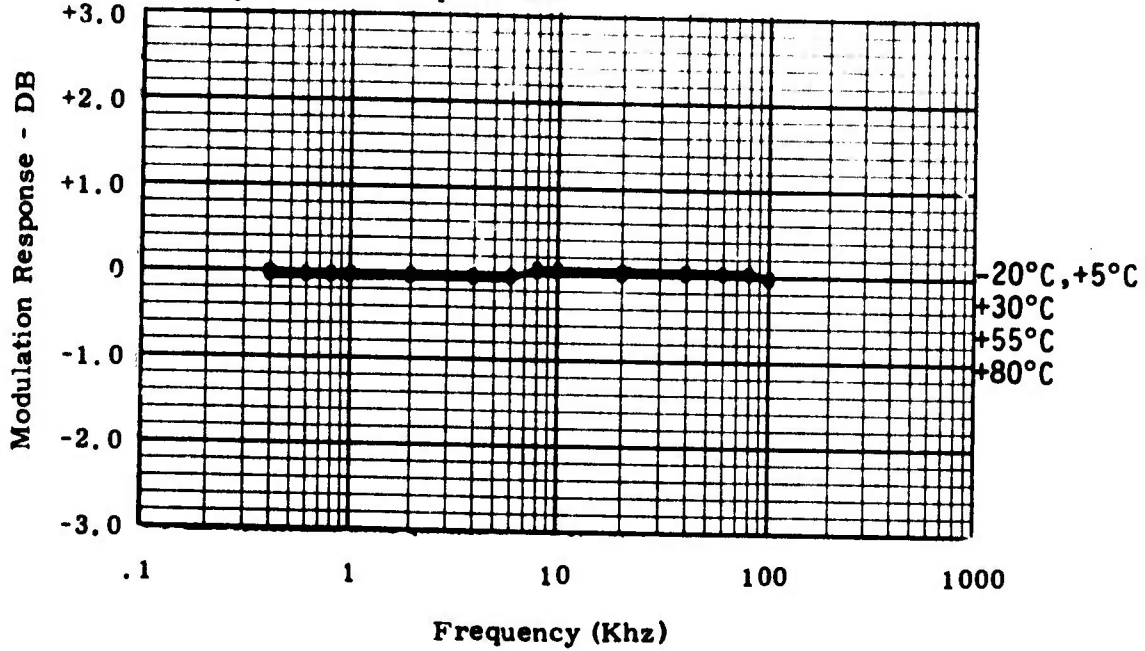

V. Linearity at Ambient

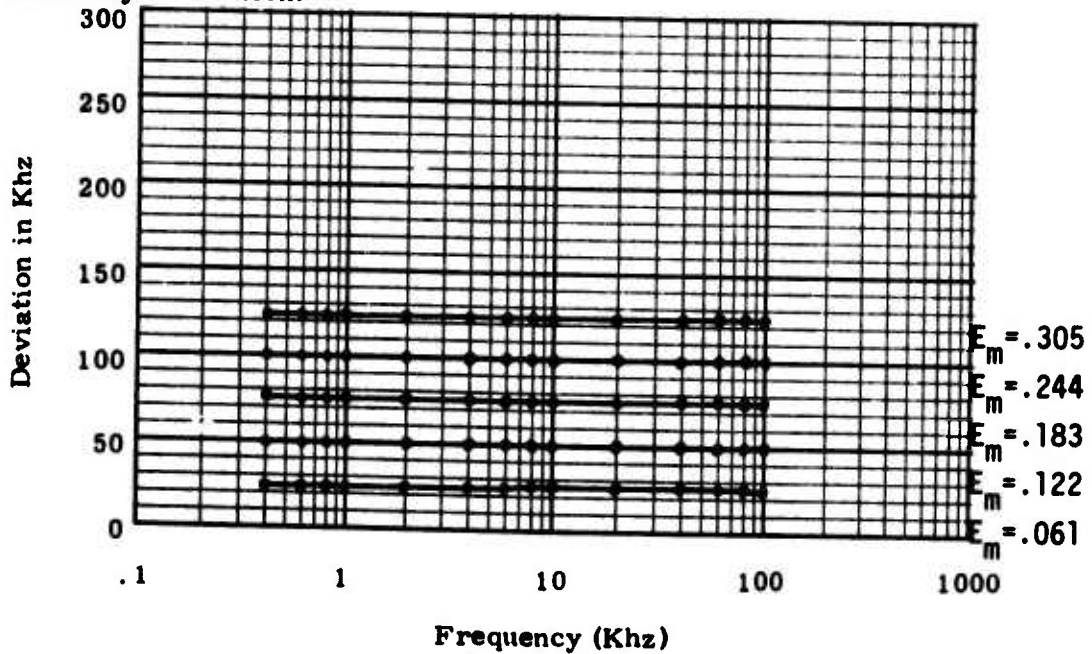

NORTHEASTERN UNIVERSITY

Evaluation Tests - RF Telemetry Transmitter - Sheet 3

Make: CONIC; Type: CTP-402; Serial Number: 402 P 195;
 Carrier Frequency fc: 244.3 MHz; Date: 3/19/75; By: J.F.E.

VI. Spurious Emission (Antenna Conducted)

Frequency Mhz	DB Down from fc	Identification
100.4	70+3	fc - 33fx
144.0	69+3	fc - 23fx
157.0	74+3	fc - 20fx
174.4	91+3	fc - 16fx
187.6	94+3	fc - 13fx
200.7	73+3	fc - 10fx
231.2	93+3	fc - 3fx
235.6	85+3	fc - 2fx
239.9	78+3	fc - fx
244.3	0	carrier frequency
248.7	79+3	fc + fx
253.0	81+3	fc + 2fx
257.4	81+3	fc + 3fx
261.7	84+3	fc + 4fx
270.5	110+3	fc + 6fx
287.9	89+3	fc + 10fx
331.5	104+3	fc + 20fx
488.6	78+3	2fc
732.9	77+3	3fc

NOTE: W.S.M.R. Regulation No. 105-2-60 requirement is $55+10\log P_t$ DB Down from carrier.

VII. Miscellaneous

1. Maximum Distortion 0.78%
2. Incidental FM <500 Hz PEAK
3. Power Requirement 10.7 watts
4. Efficiency 24.5%
5. O.C. & S.C. Protection OK
6. Other Checks freq. at 5:1 VSWR = 244.3180
carrier shift = -0.0074% of fc at 5:1 VSWR

NORTHEASTERN UNIVERSITY

Evaluation Tests - RF Telemetry Transmitter - Sheet 1

Make: CONIC ; Type: CTP-402 ; Serial Number: 402 P 196 ;
 Carrier Frequency f_c : 244.3 MHz; Date: 3/19/75 ; By: J.F.E. ;

I. Time Drift

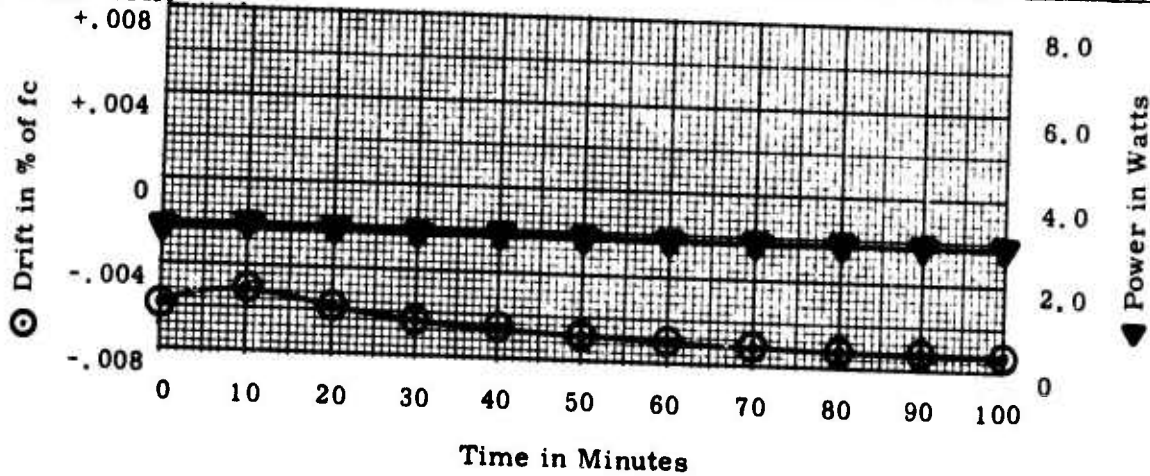

II. Temperature Stability

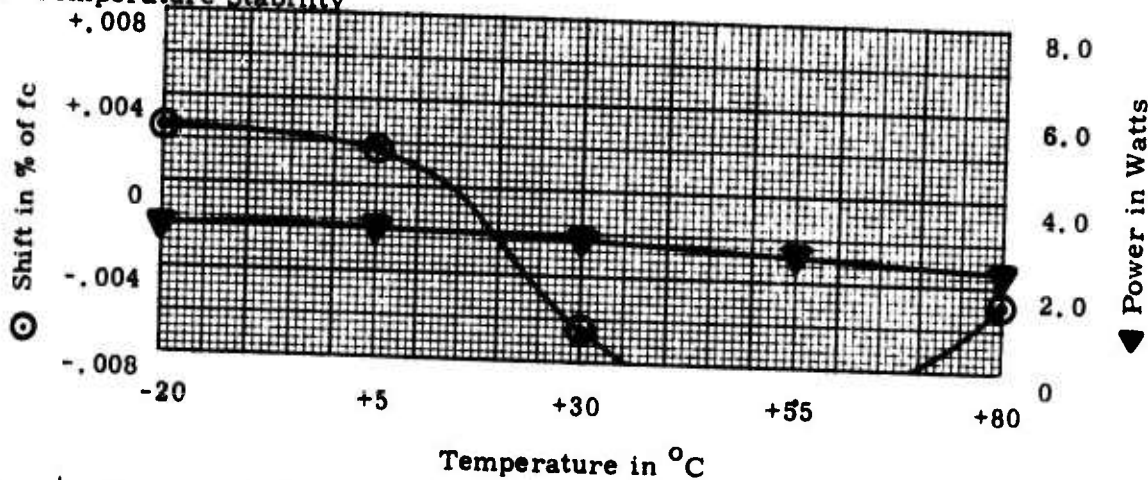

III. B⁺ Voltage Regulation

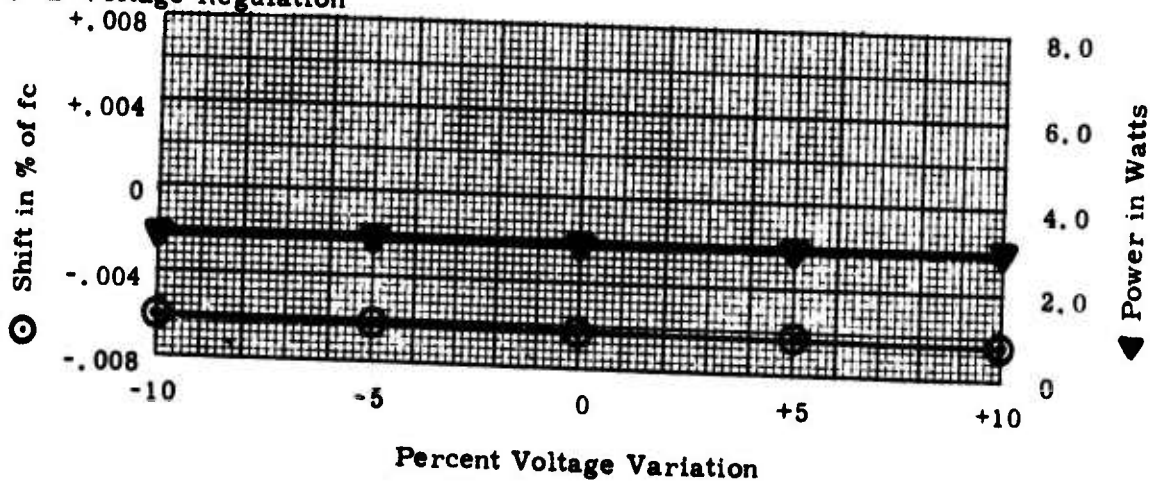

NORTHEASTERN UNIVERSITY

Evaluation Tests - RF Telemetry Transmitter - Sheet 3

Make: CONIC ; Type: CTP-402 ; Serial Number: 402 P 196 ;
 Carrier Frequency f_c : 244.3 MHz; Date: 3/19/75 ; By: J.F.E.

VI. Spurious Emission (Antenna Conducted)

Frequency Mhz	DB Down from f_c	Identification
86.3	89+3	$f_c - 36f_x$
156.5	81+3	$f_c - 20f_x$
174.1	100+3	$f_c - 16f_x$
182.8	96+3	$f_c - 14f_x$
187.2	88+3	$f_c - 13f_x$
200.4	90+3	$f_c - 10f_x$
226.7	93+3	$f_c - 4f_x$
231.1	95+3	$f_c - 3f_x$
235.5	87+3	$f_c - 2f_x$
244.3	0	carrier frequency
248.7	89+3	$f_c + f_x$
253.1	91+3	$f_c + 2f_x$
257.5	92+3	$f_c + 3f_x$
261.9	95+3	$f_c + 4f_x$
288.2	92+3	$f_c + 10f_x$
301.4	100+3	$f_c + 13 f_x$
488.6	73+3	2 f_c
732.9	68+3	3 f_c

NOTE: W. S. M. R. Regulation No. 105-2-60 requirement is $55+10 \log P_t$ DB Down from carrier.

VII. Miscellaneous

1. Maximum Distortion 0.86%
2. Incidental FM <500Hz PEAK
3. Power Requirement 12.0 watts
4. Efficiency 24.1%
5. O.C. & S.C. Protection OK
6. Other Checks freq. at 5:1 VSWR = 244.3139
carrier shift = -0.0057% of f_c for 5:1 VSWR

Evaluation Tests - Proprietary Information Sheet

RF Telemetry Transmitters

Make: Conic;

Type: CTS-402;

Manufacturer's Specifications

<u>Output Frequency</u>	S-Band (2200-2300MHz) crystal controlled, factory preset.
<u>Output Power</u>	2 watts minimum over temperature and supply voltage ranges specified below delivered to 50 ohm load impedance with a VSWR of 1.5:1.
<u>Output Impedance</u>	50 ohms nominal, employs internal isolator, will operate into open or short circuit without damage.
<u>Frequency Stability</u>	$\pm .003\%$ of carrier, cumulative total of setability and drift over environments.
<u>Deviation Sensitivity</u>	S-Band; $\pm 200\text{KHz/V}$ peak to peak, factory preset.
<u>Total Harmonic Distortion</u>	2% maximum over modulation bandwidth at $\pm 600\text{KHz}$ deviation.
<u>Incidental Frequency Modulation</u>	S-Band; $\pm 4\text{KHz}$ bench; $\pm 7\text{KHz}$ over environments.
<u>Power Requirements</u>	28 ± 4 VDC, 0.70 amp maximum with reverse polarity protection provided.
<u>Electro-Magnetic Interference</u>	IRIG 106-69 for antenna conducted and radiated. MIL-STD-461 for power line conducted and radiated interference and conducted susceptibility at 28 VDC.
<u>Modulation Type</u>	True FM.
<u>Input Impedance</u>	10K ohms resistive minimum, shunted by 30 pf maximum.
<u>Frequency Response</u>	10HZ - 1MHz $\pm 1.5\text{db}$.
<u>Carrier Deviation</u>	S-Band; $\pm 600\text{KHz}$.
<u>Temperature</u>	-20°C to $+70^{\circ}\text{C}$ baseplate operating range.
<u>Vibration</u>	Sine: 20 G peak, 20-2000 cps, 3 axes.
<u>Shock</u>	100 G peak, 11 milliseconds, 1/2 sine pulse, 3 axes.
<u>Acceleration</u>	100 G, 3 axes.
<u>Volume</u>	10 cubic inches (excluding connectors).
<u>Weight</u>	14 ounces maximum.

NORTHEASTERN UNIVERSITY

Evaluation Tests - RF Telemetry Transmitter - Sheet 1

Make: Conic ; Type: CTS-402 ; Serial Number: 4020319

Carrier Frequency f_c : 2259.5 MHz; Date: 6/23/75 ; By: PJR

I. Time Drift

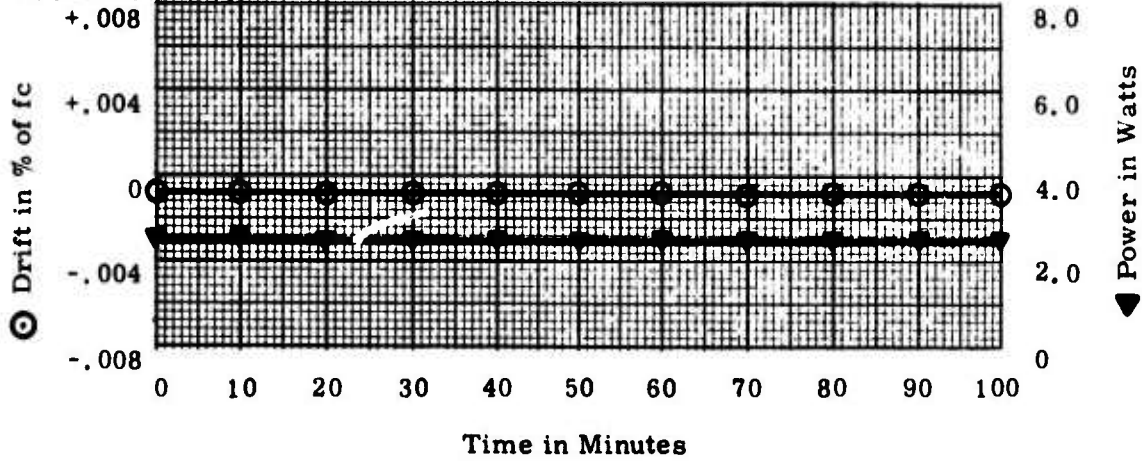

II. Temperature Stability

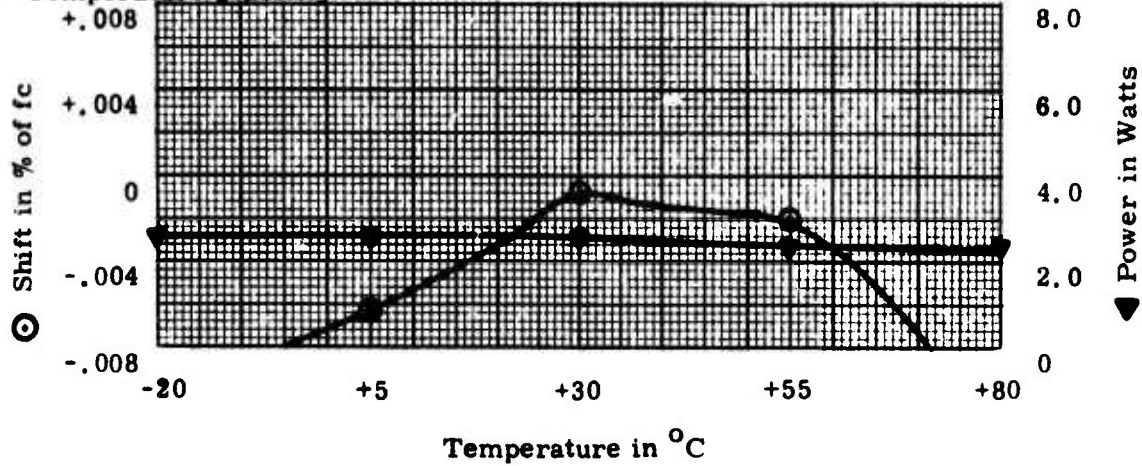

III. B⁺ Voltage Regulation

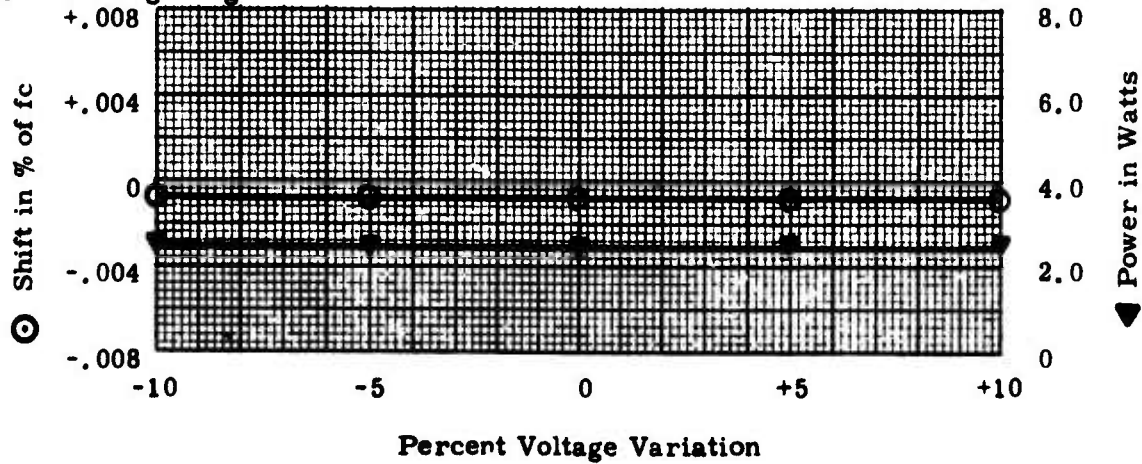

NORTHEASTERN UNIVERSITY

Evaluation Tests - RF Telemetry Transmitter - Sheet 2

Make: Conic ; Type: CTS-402 ; Serial Number: 4020319 ;
 Carrier Frequency f_c : 2259.5 MHz; Date: 6/23/75 ; By: PJR ;

IV. Modulation Response vs. Temperature

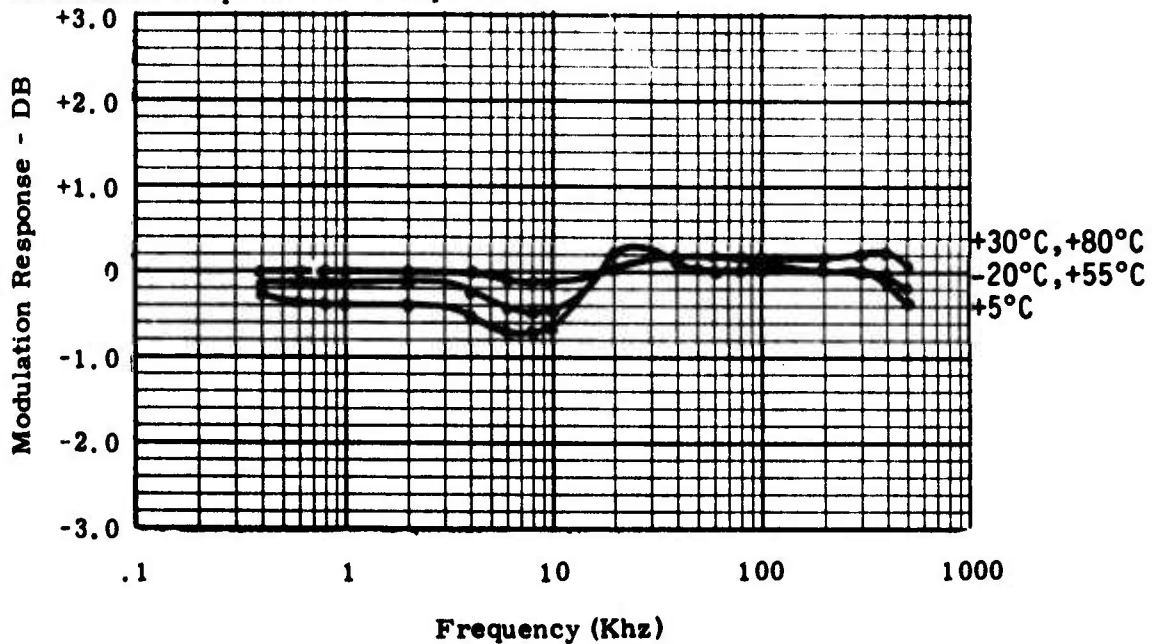

V. Linearity at Ambient

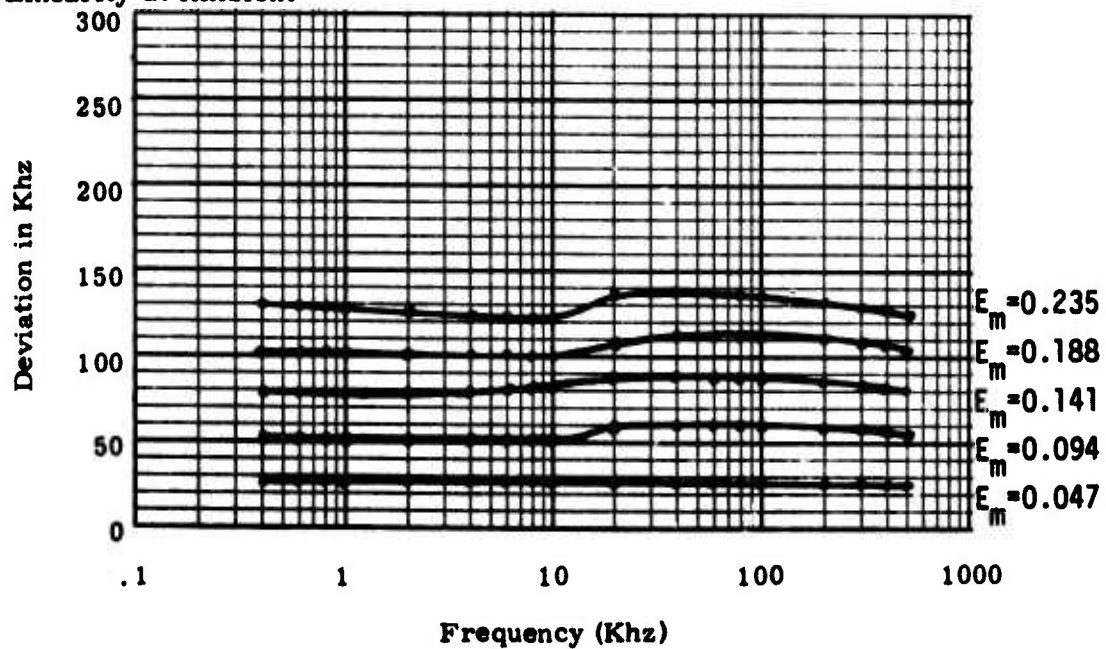

NORTHEASTERN UNIVERSITY

Evaluation Tests - RF Telemetry Transmitter - Sheet 3

Make: CONIC ; Type: CTS-402 ; Serial Number: 4020319
 Carrier Frequency fc: 2259.5 MHz; Date: 6/23/75 ; By: PJR

VI. Spurious Emission (Antenna Conducted)

Frequency Mhz	DB Down from fc	Identification
2138	103 ± 3	fc - 9fx
2245	87 ± 3	fc - fx
2259.5	0	carrier frequency
2273	90 ± 3	fc + fx
2381	109 ± 3	fc + 9fx
3389	110 ± 3	3fc/2
4519	65 ± 3	2fc

NOTE: W.S.M.R. Regulation No. 105-2-60 requirement is $55+10 \log P_t$ DB Down from carrier.

VII. Miscellaneous

1. Maximum Distortion <2.0%
2. Incidental FM <500 Hz PEAK
3. Power Requirement 17.9 watts
4. Efficiency 13.7%
5. O.C. & S.C. Protection OK
6. Other Checks freq at 5:1 VSWR = 2259.4893
carrier shift = +0.000349% of fc for 5:1 VSWR

NORTHEASTERN UNIVERSITY

Evaluation Tests - RF Telemetry Transmitter - Sheet 1

Make: CONIC ; Type: CTS-402 ; Serial Number: 4020558
 Carrier Frequency f_c : 2251.5 MHz; Date: 3/26/76 ; By: KYL

I. Time Drift

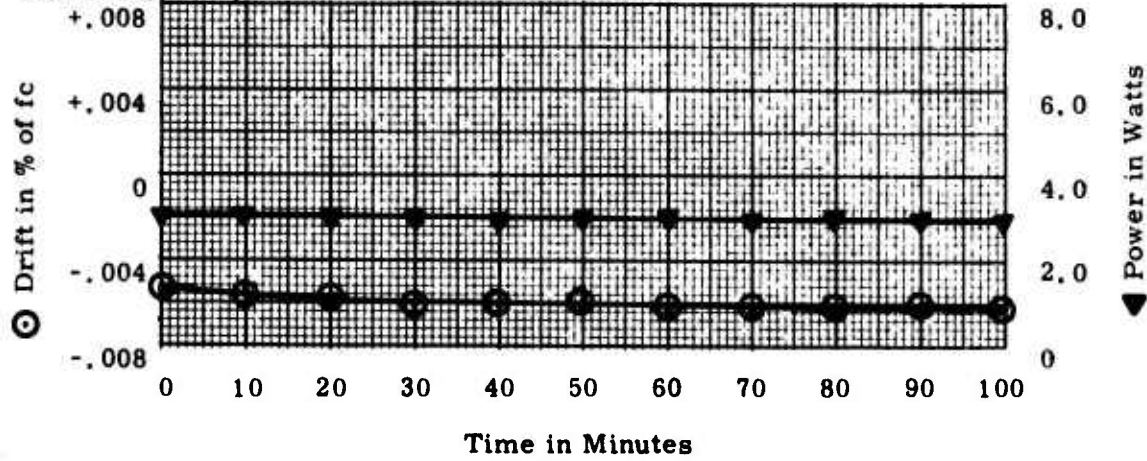

II. Temperature Stability

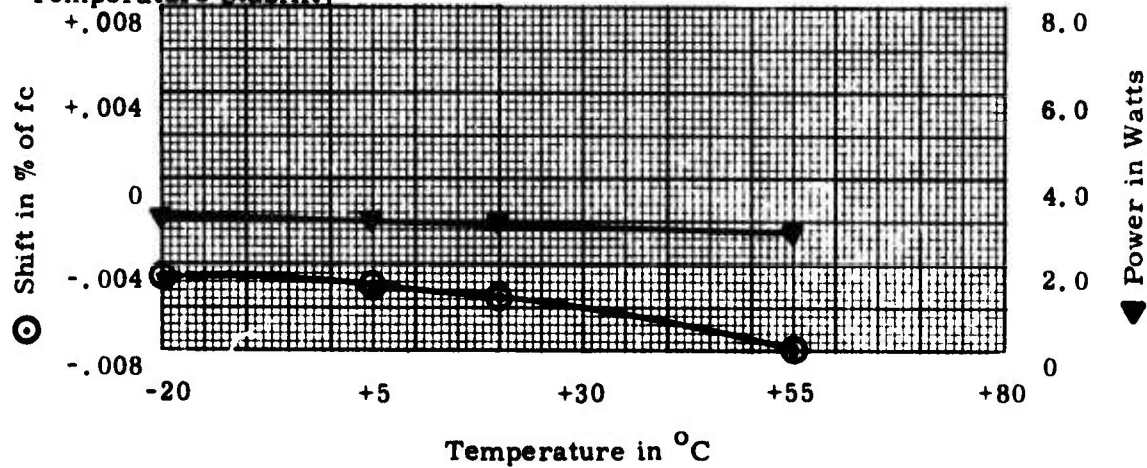

III. B⁺ Voltage Regulation

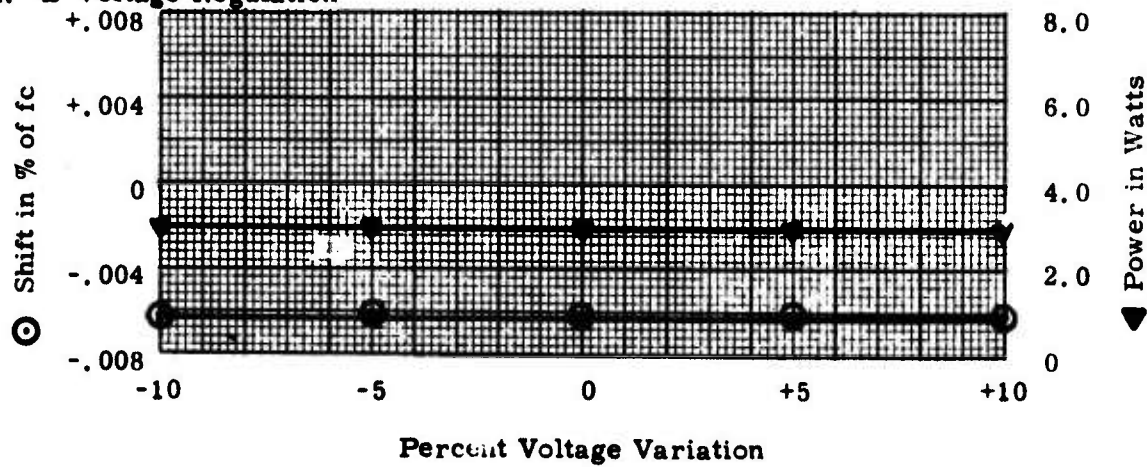

NORTHEASTERN UNIVERSITY

Evaluation Tests - RF Telemetry Transmitter - Sheet 2

Make: CONIC ; Type: CTS-402 ; Serial Number: 4020558 ;
 Carrier Frequency f_c : 2251.5 MHz; Date: 3/6/76 ; By: KYL

IV. Modulation Response vs. Temperature

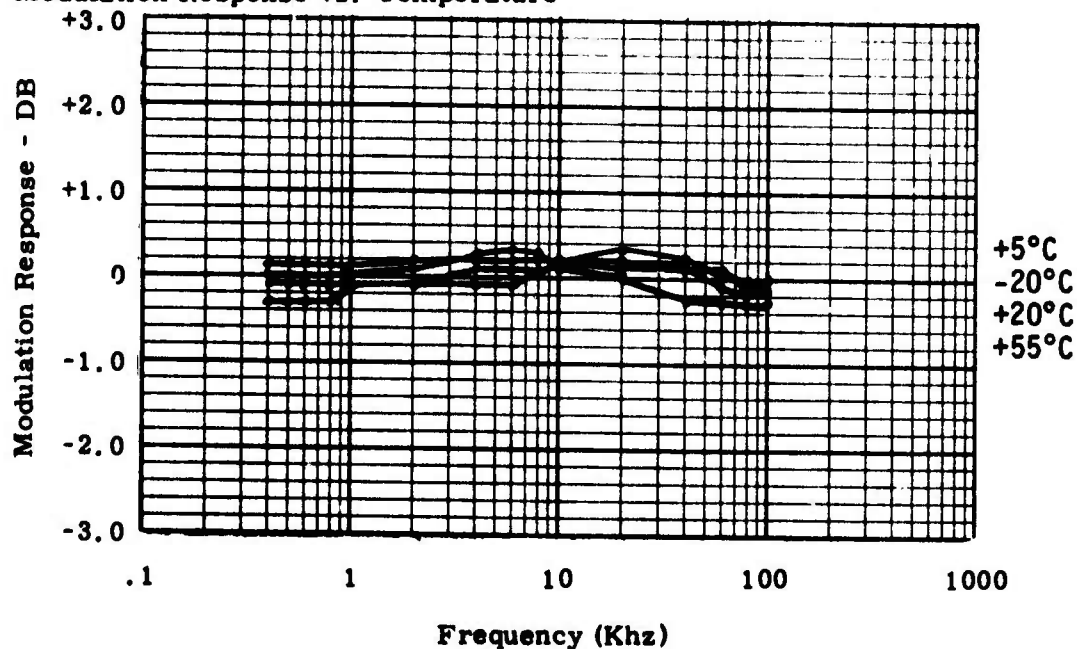

V. Linearity at Ambient

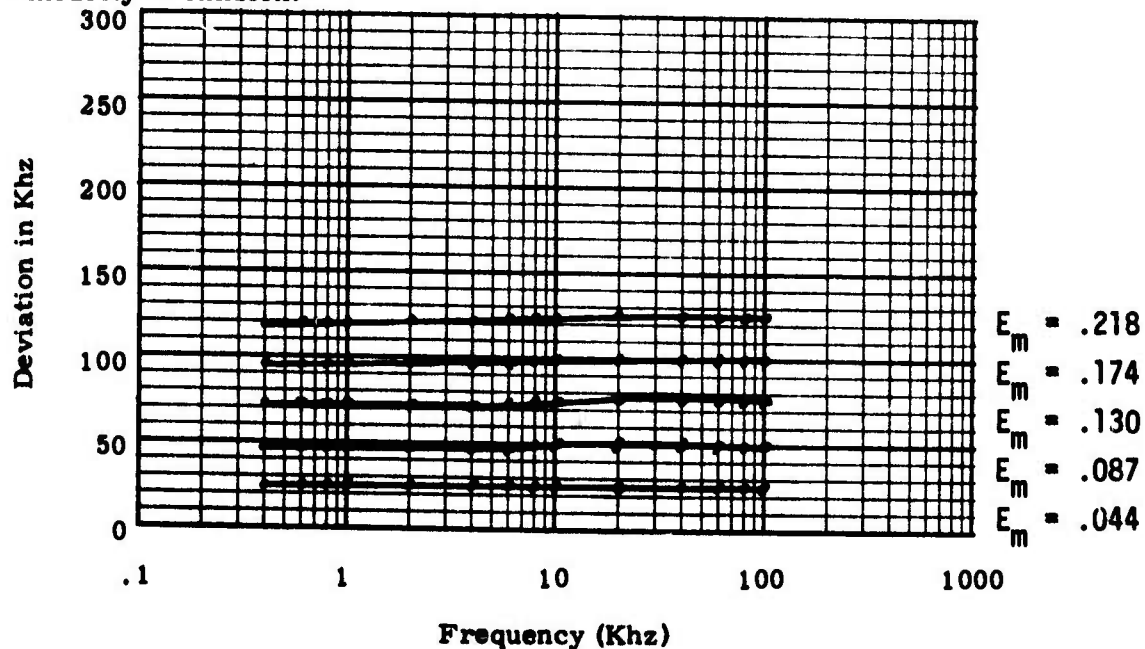

NORTHEASTERN UNIVERSITY

Evaluation Tests - RF Telemetry Transmitter - Sheet 3

Make: CONIC; Type: CTS-402; Serial Number: 4020558;
 Carrier Frequency f_c : 2251.5 MHz; Date: 3/26/76; By: KYL;

VI. Spurious Emission (Antenna Conducted)

Frequency Mhz	DB Down from f_c	Identification
4503	59 ± 3	2 f_c
3376	84 ± 3	$f_c + 75f_x$
2371	81 ± 3	$f_c + 8f_x$
2265	71 ± 3	$f_c + f_x$
2251.5	0	carrier frequency
2236	71 ± 3	$f_c - f_x$
2131	76 ± 3	$f_c - 8f_x$

NOTE: W. S. M. R. Regulation No. 105-2-60 requirement is $55 + 10 \log P_t$ DB Down from carrier.

VII. Miscellaneous

1. Maximum Distortion 1.00%
2. Incidental FM <500 Hz PEAK
3. Power Requirement 20.16 watts
4. Efficiency 15.1%
5. O.C. & S.C. Protection OK
6. Other Checks no carrier shift for 5:1 VSWR.

NORTHEASTERN UNIVERSITY

Evaluation Tests - RF Telemetry Transmitter - Sheet 1

Make: CONIC ; Type: CTS-402 ; Serial Number: 4020599
 Carrier Frequency f_c : 2251.5 MHz; Date: 3/5/76 ; By: KYL

I. Time Drift

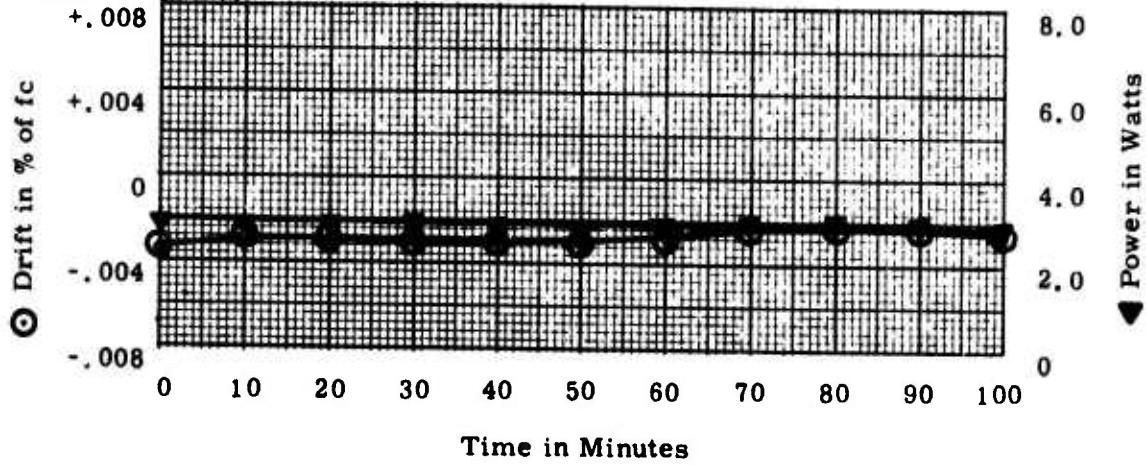

II. Temperature Stability

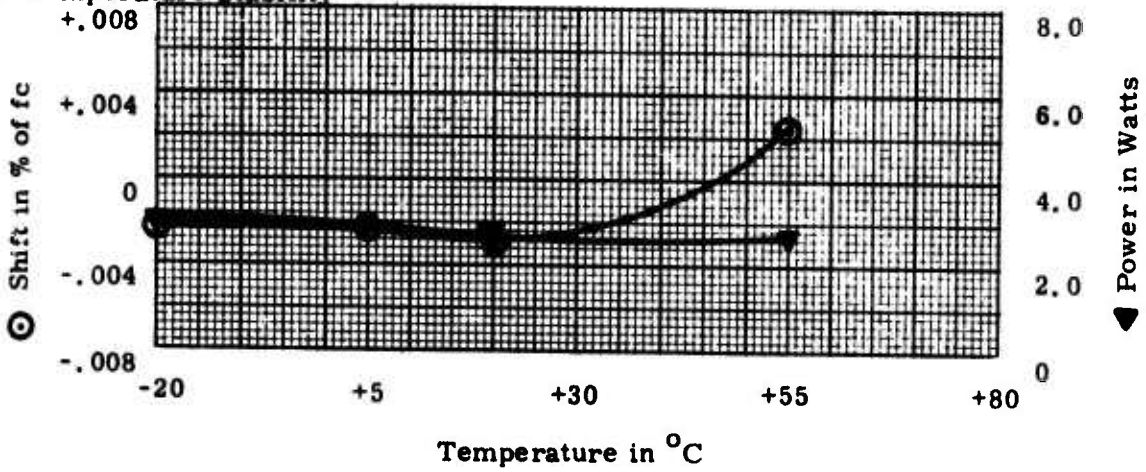

III. B⁺ Voltage Regulation

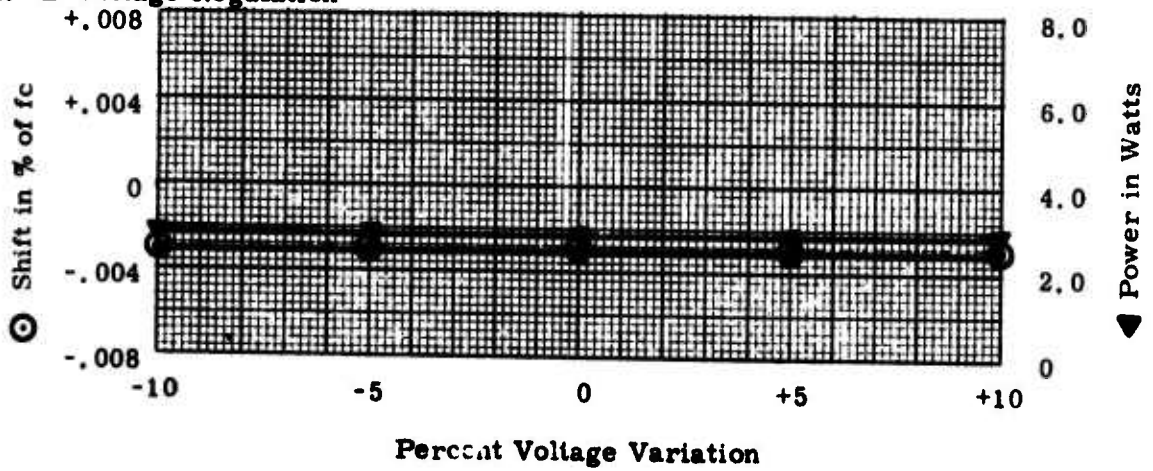

NORTHEASTERN UNIVERSITY

Evaluation Tests - RF Telemetry Transmitter - Sheet 2

Make: CONIC ; Type: CTS-402 ; Serial Number: 4020599 ;
Carrier Frequency f_c : 2251.5 MHz ; Date: 3/5/76 ; By: KYL ;

IV. Modulation Response vs. Temperature

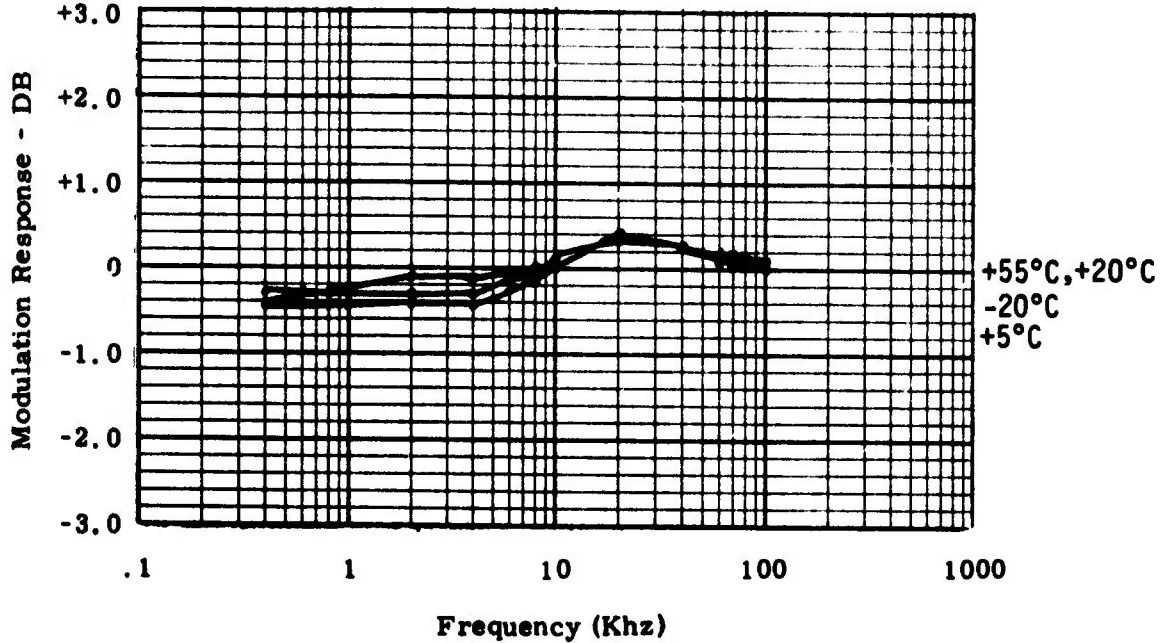

V. Linearity at Ambient

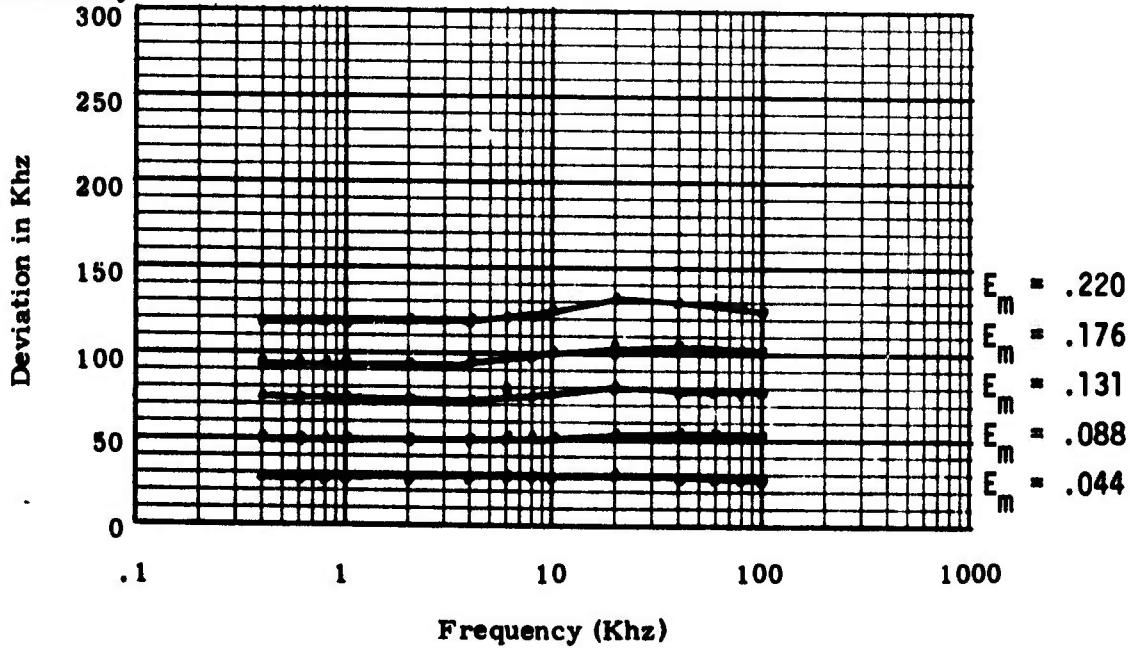

NORTHEASTERN UNIVERSITY

Evaluation Tests - RF Telemetry Transmitter - Sheet 3

Make: CONIC ; Type: CTS-402 ; Serial Number: 4020599 ;
 Carrier Frequency f_c : 2251.5 MHz; Date: 3/5/76 ; By: KYL ;

VI. Spurious Emission (Antenna Conducted)

Frequency Mhz	DB Down from f_c	Identification
2370	88 ± 3	$f_c + 8f_x$
2265	90 ± 3	$f_c + f_x$
2251.5	0	carrier frequency
2235	89 ± 3	$f_c - f_x$
2130	84 ± 3	$f_c - 8f_x$

NOTE: W. S. M. R. Regulation No. 105-2-60 requirement is $55 + 10 \log P_t$ DB Down from carrier.

VII. Miscellaneous

1. Maximum Distortion 1.50%
2. Incidental FM <500 Hz PEAK
3. Power Requirement 19.04 watts
4. Efficiency 15.1%
5. O.C. & S.C. Protection OK
6. Other Checks no carrier shift for 5:1 VSWR.

NORTHEASTERN UNIVERSITY

Evaluation Tests - RF Telemetry Transmitter - Sheet 1

Make: Conic ; Type: CTS-402 ; Serial Number: 4021093 ;
 Carrier Frequency f_c : 2251.5 MHz; Date: 6/23/75 ; By: PJR

I. Time Drift

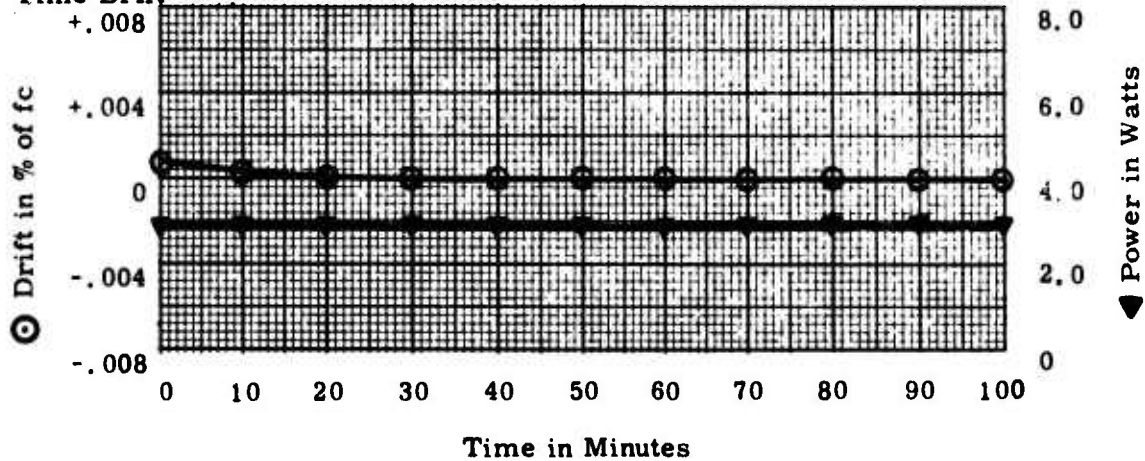

II. Temperature Stability

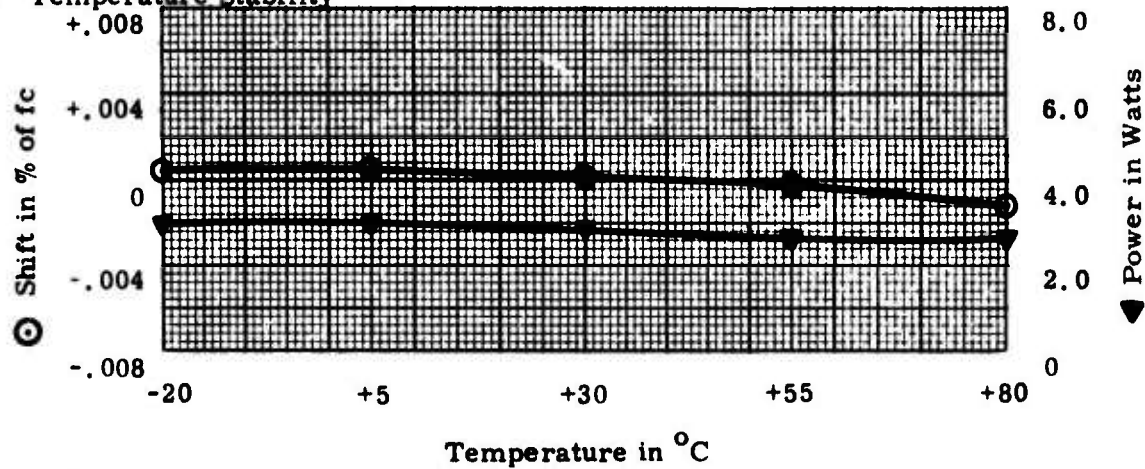

III. B⁺ Voltage Regulation

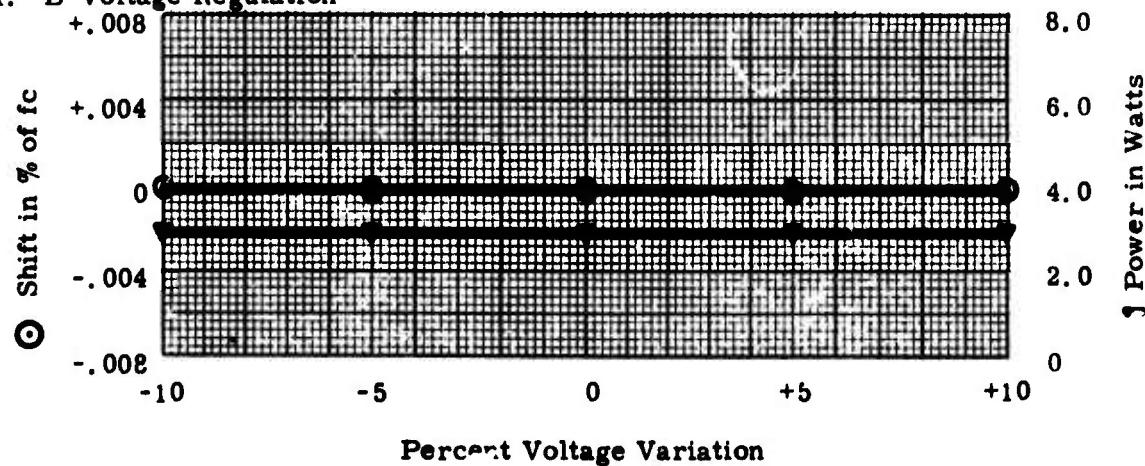

NORTHEASTERN UNIVERSITY

Evaluation Tests - RF Telemetry Transmitter - Sheet 2

Make: Conic ; Type: CTS-402 ; Serial Number: 4021093 ;
Carrier Frequency f_c : 2251.5 MHz; Date: 6/23/75 ; By: PJR ;

IV. Modulation Response vs. Temperature

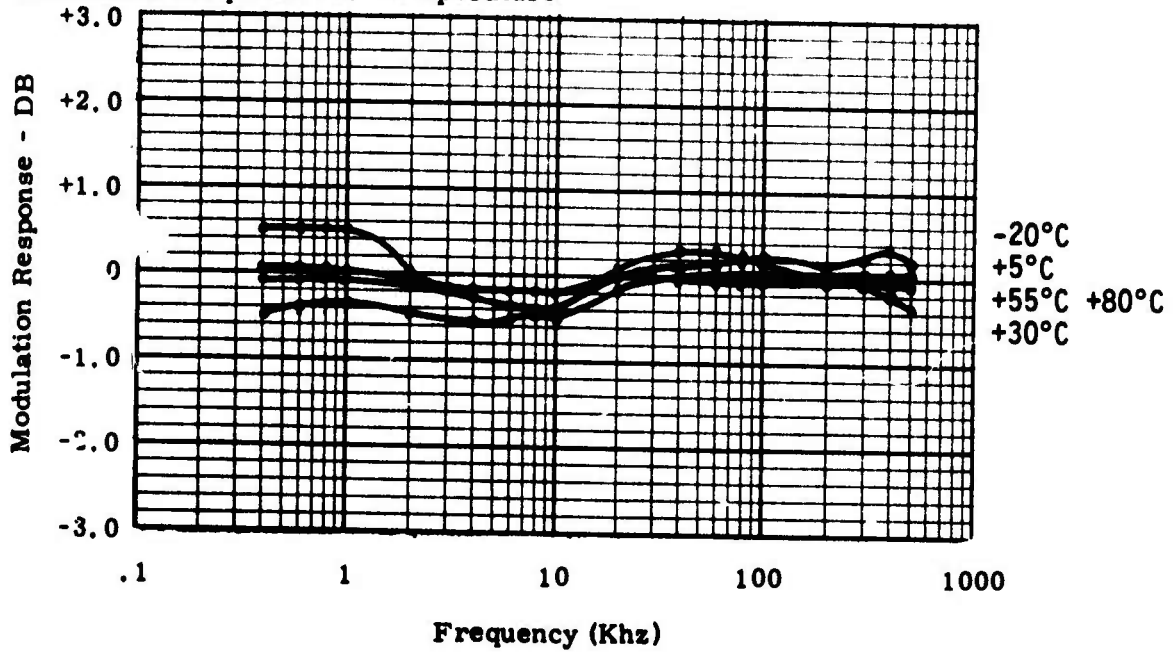

V. Linearity at Ambient

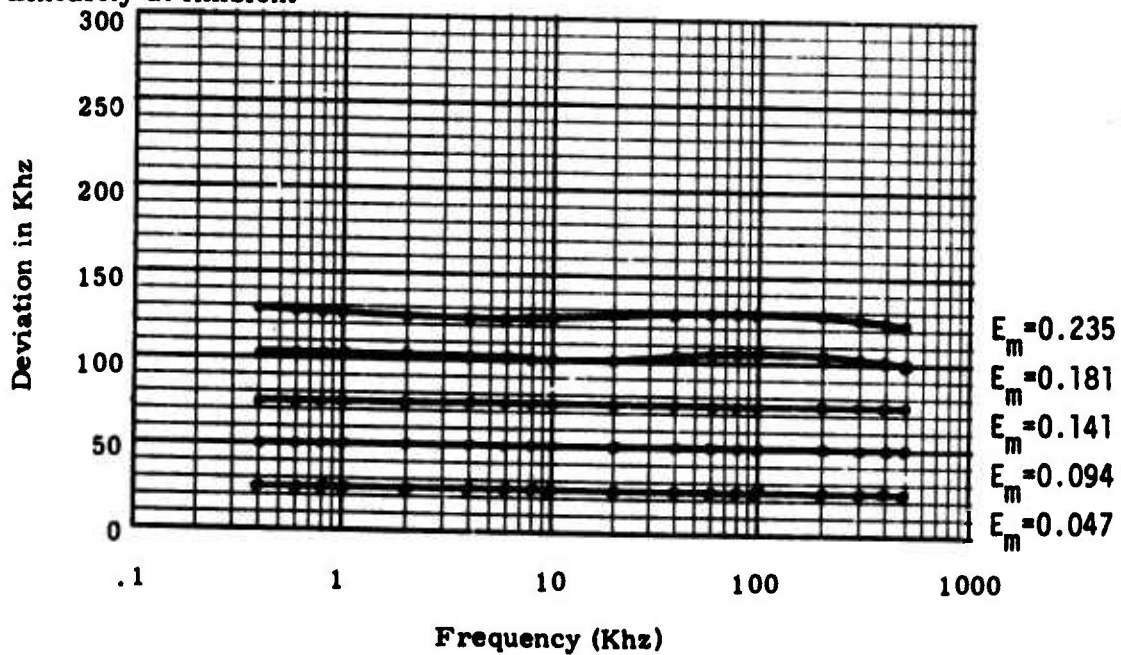

NORTHEASTERN UNIVERSITY

Evaluation Tests - RF Telemetry Transmitter - Sheet 3

Make: CONIC ; Type: CTS-402 ; Serial Number: 4021093
 Carrier Frequency f_c : 2251.5 MHz; Date: 6/23/75 ; By: PJR

VI. Spurious Emission (Antenna Conducted)

Frequency Mhz	DB Down from f_c	Identification
2126.5	102 ± 3	$f_c - 10f_x$
2251.5	0	carrier frequency
2264	97 ± 3	$f_c + f_x$
2289	104 ± 3	$f_c + 3f_x$
4503	66 ± 3	$2f_c$

NOTE: W. S. M. R. Regulation No. 105-2-60 requirement is $55 + 10 \log P_t$ DB Down from carrier.

VII. Miscellaneous

1. Maximum Distortion <2.0%
2. Incidental FM <500 Hz PEAK
3. Power Requirement 20.5 watts
4. Efficiency 10.27%
5. O.C. & S.C. Protection OK
6. Other Checks freq at 5:1 VSWR = 2251.4961
carrier shift = -0.000222% of f_c for 5:1 VSWR

NORTHEASTERN UNIVERSITY

Evaluation Tests - RF Telemetry Transmitter - Sheet 1

Make: Conic ; Type: CTS-402 ; Serial Number: 4021094

Carrier Frequency f_c : 2251.5 MHz; Date: 6/23/75 ; By: PJR

I. Time Drift

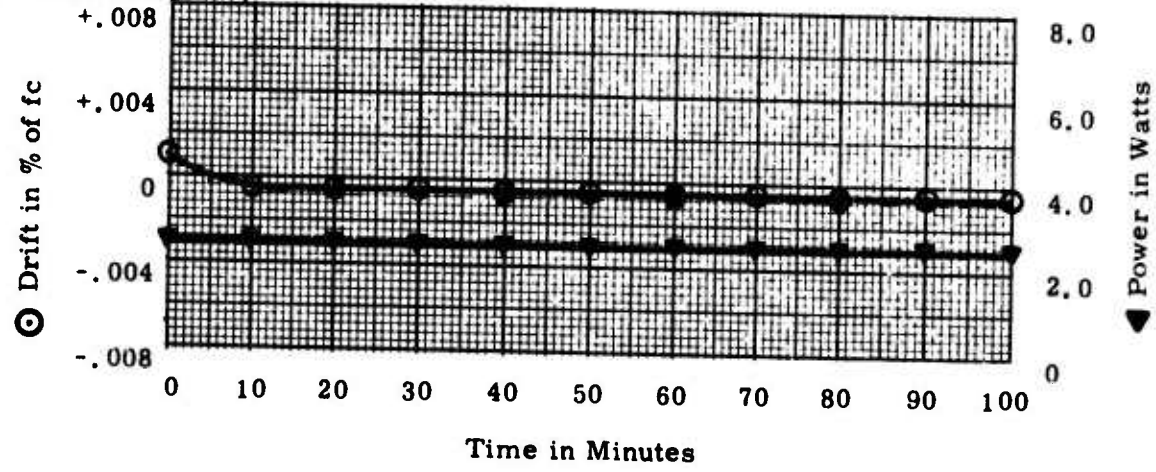

II. Temperature Stability

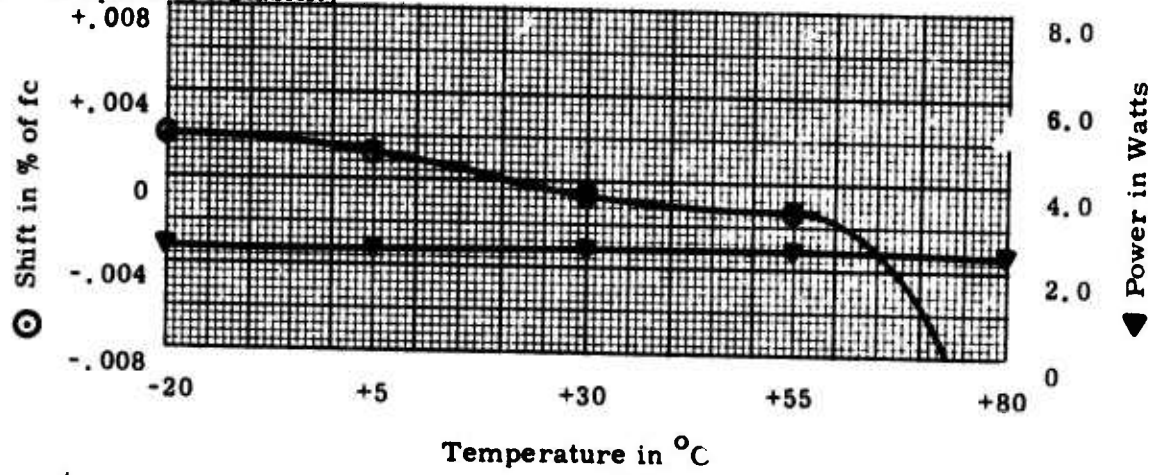

III. B⁺ Voltage Regulation

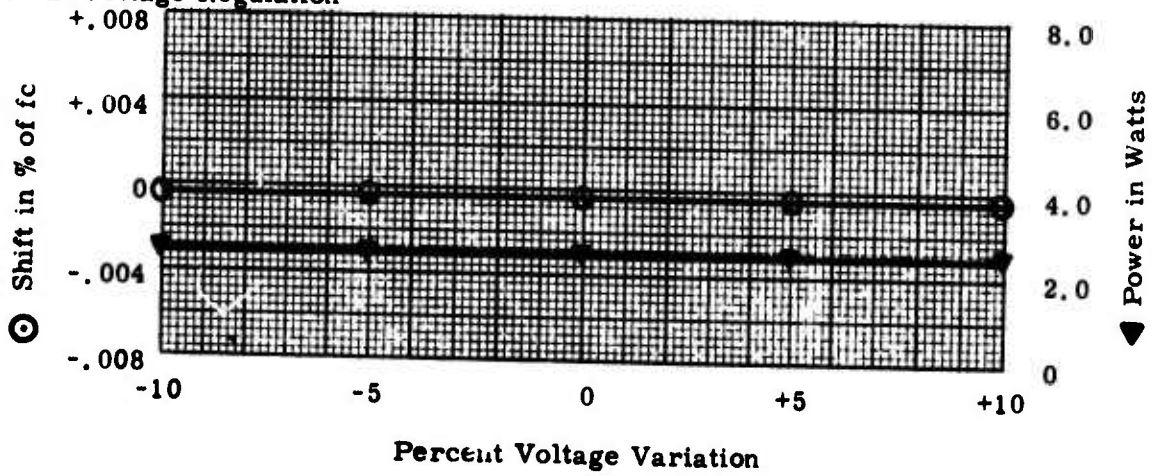

NORTHEASTERN UNIVERSITY

Evaluation Tests - RF Telemetry Transmitter - Sheet 2

Make: Conic ; Type: CTS-402 ; Serial Number: 4021094 ;
Carrier Frequency f_c : 2251.5 MHz; Date: 6/23/75 ; By: PJR ;

IV. Modulation Response vs. Temperature

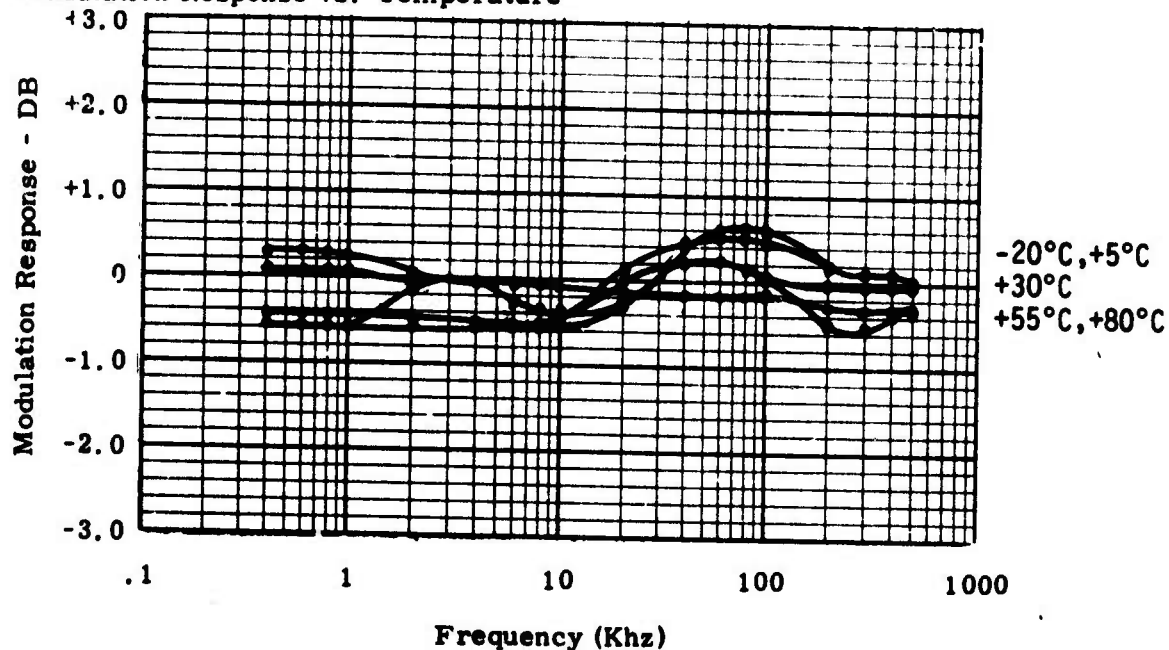

V. Linearity at Ambient

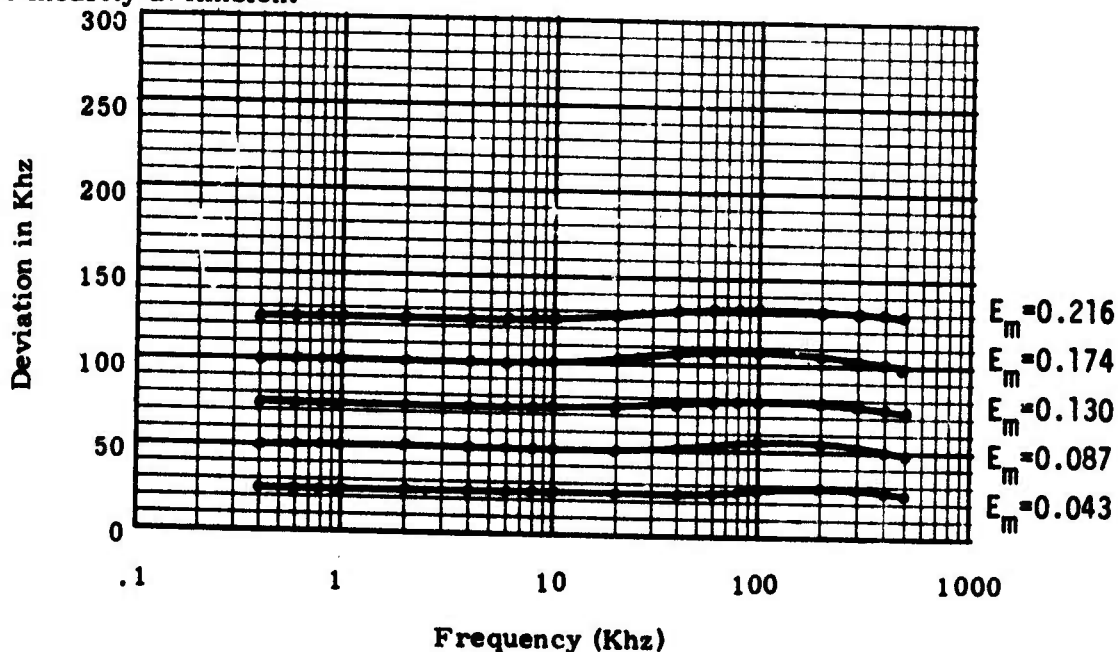

NORTHEASTERN UNIVERSITY

Evaluation Tests - RF Telemetry Transmitter - Sheet 3

Make: CONIC ; Type: CTS-402 ; Serial Number: 4021094 ;
 Carrier Frequency f_c : 2251.5 MHz; Date: 6/23/75 ; By: PJR ;

VI. Spurious Emission (Antenna Conducted)

Frequency Mhz	DB Down from f_c	Identification
2136	101 ± 3	$f_c - 10f_x$
2240	92 ± 3	$f_c - f_x$
2251.5	0	carrier frequency
2263	93 ± 3	$f_c + f_x$
2366	107 ± 3	$f_c + 10f_x$
3377	100 ± 3	$3f_c/2$
4503	67 ± 3	$2f_c$
6754	76 ± 3	$3f_c$

NOTE: W. S. M. R. Regulation No. 105-2-60 requirement is $55+10 \log P_t$ DB Down from carrier.

VII. Miscellaneous

1. Maximum Distortion <2.0%
2. Incidental FM <500 Hz PEAK
3. Power Requirement 16.8 watts
4. Efficiency 15.1%
5. O.C. & S.C. Protection OK
6. Other Checks freq at 5:1 VSWR = 2251.4910
carrier shift = -0.0399% of f_c for 5:1 VSWR

NORTHEASTERN UNIVERSITY

Evaluation Tests - RF Telemetry Transmitter - Sheet 1

Make: Conic ; Type: CTS-402 ; Serial Number: 4021095
 Carrier Frequency f_c : 2251.5 MHz; Date: 6/23/75 ; By: PJR

I. Time Drift

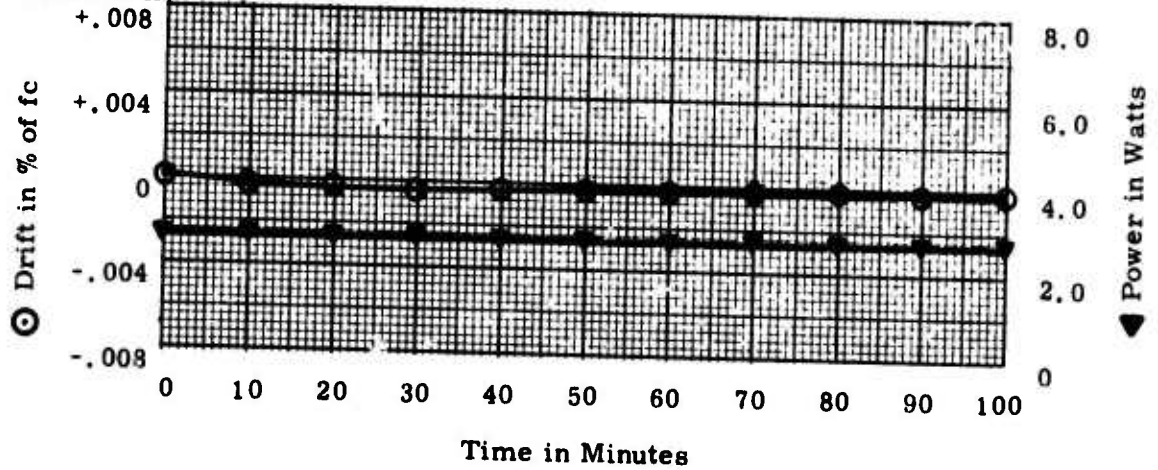

II. Temperature Stability

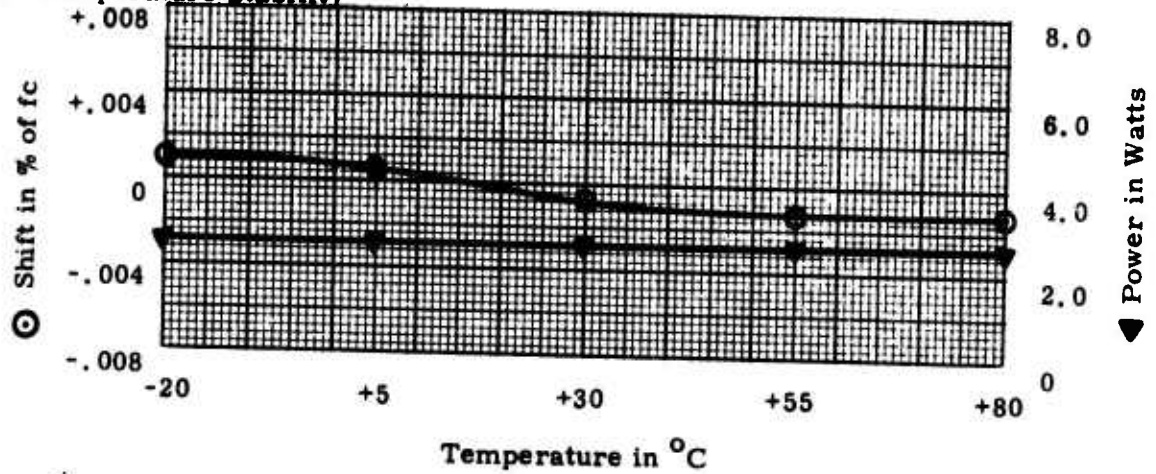

III. B⁺ Voltage Regulation

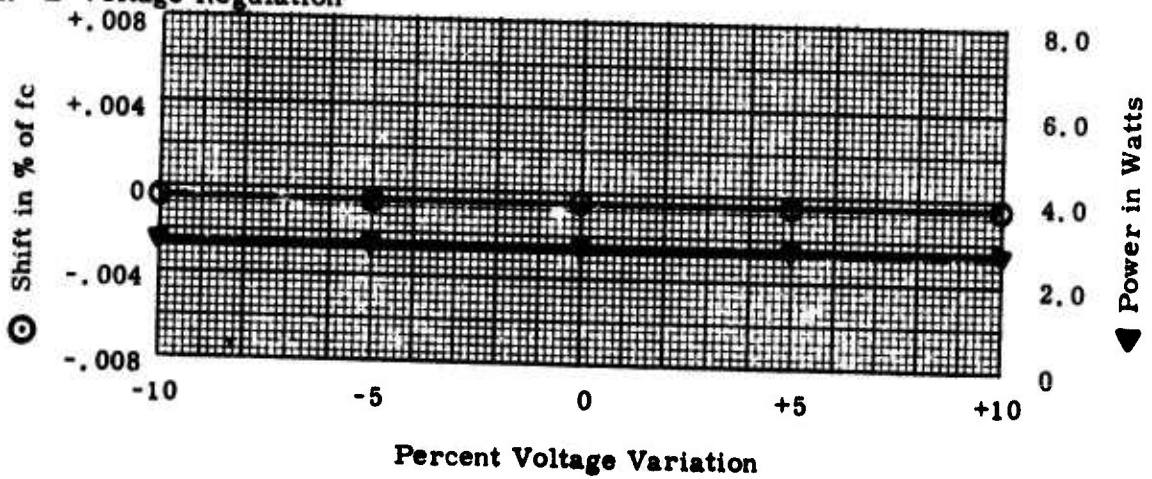

NORTHEASTERN UNIVERSITY

Evaluation Tests - RF Telemetry Transmitter - Sheet 2

Make: Conic ; Type: CTS-402 ; Serial Number: 4021095 ;
Carrier Frequency f_c : 2251.5 MHz; Date: 6/23/75 ; By: PJR ;

IV. Modulation Response vs. Temperature

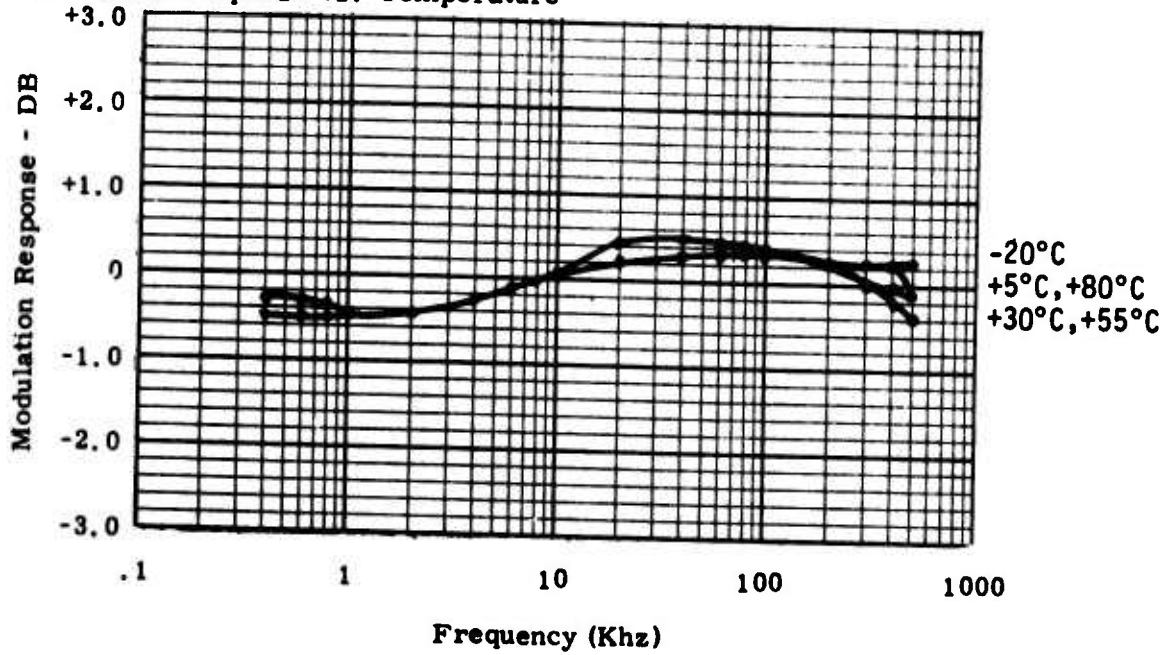

V. Linearity at Ambient

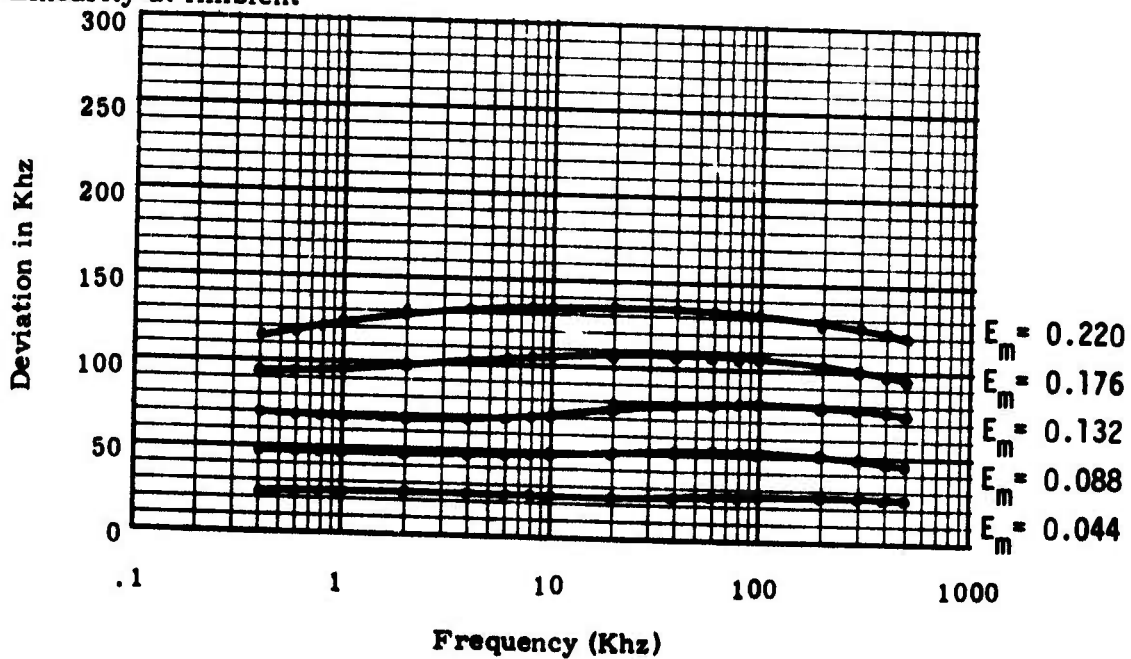

NORTHEASTERN UNIVERSITY

Evaluation Tests - RF Telemetry Transmitter - Sheet 3

Make: CONIC; Type: CTS-402; Serial Number: 4021095
 Carrier Frequency f_c : 2251.5 MHz; Date: 6/23/75; By: PJR

VI. Spurious Emission (Antenna Conducted)

Frequency Mhz	DB Down from f_c	Identification
2126	114 ± 3	$f_c - 10f_x$
2239	90 ± 3	$f_c - f_x$
2251.5	0	carrier frequency
2264	93 ± 3	$f_c + f_x$
2289	106 ± 3	$f_c + 3f_x$
4503	82 ± 3	$2f_c$

NOTE: W. S. M. R. Regulation No. 105-2-60 requirement is $55 + 10 \log P_t$ DB Down from carrier.

VII. Miscellaneous

1. Maximum Distortion <2.0%
2. Incidental FM <500 Hz PEAK
3. Power Requirement 16.8 watts
4. Efficiency 16.6%
5. O.C. & S.C. Protection OK
6. Other Checks freq at 5:1 VSWR = 2251.4826
carrier shift = -0.00088% of f_c at 5:1 VSWR

NORTHEASTERN UNIVERSITY

Evaluation Tests - RF Telemetry Transmitter - Sheet 1

Make: Conic ; Type: CTS-402 ; Serial Number: 4021096

Carrier Frequency f_c : 2279.5 MHz; Date: 6/23/75 ; By: PJR

I. Time Drift

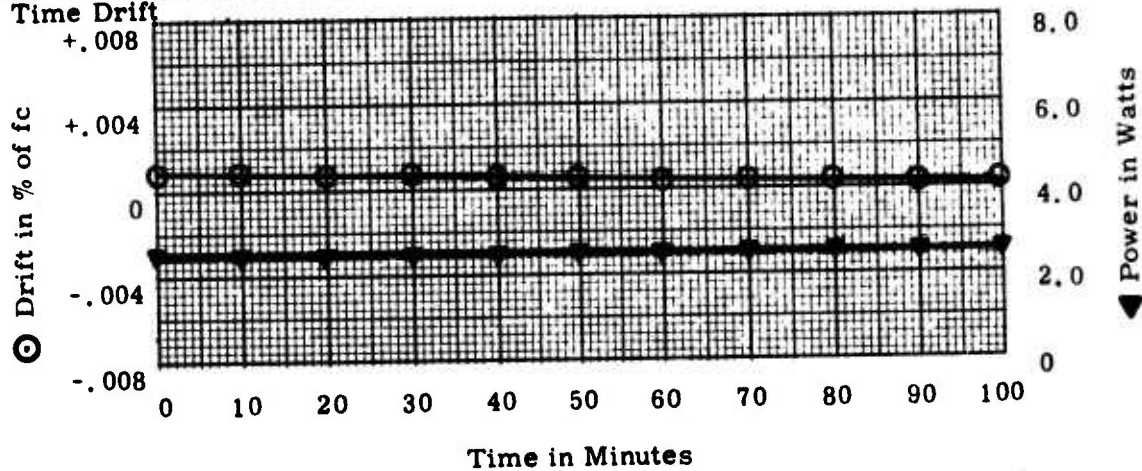

II. Temperature Stability

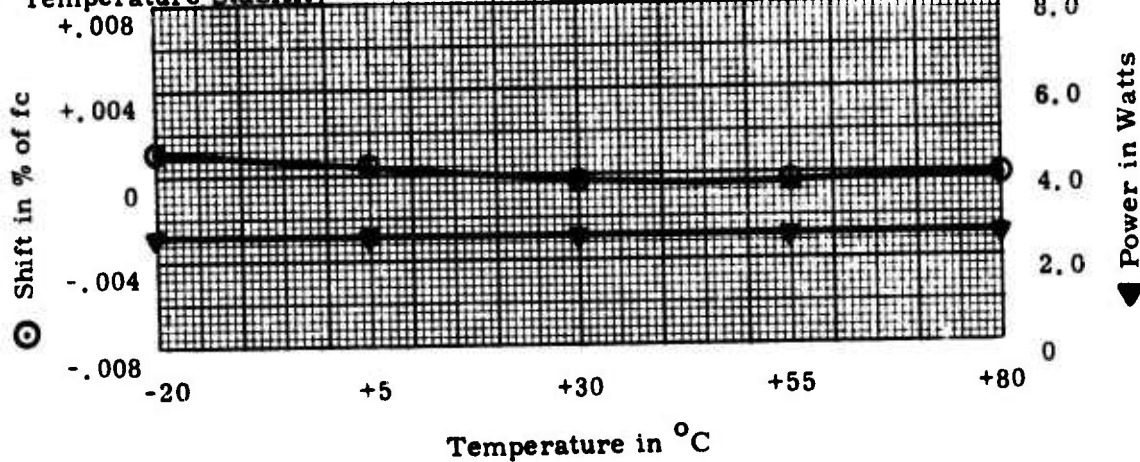

III. B⁺ Voltage Regulation

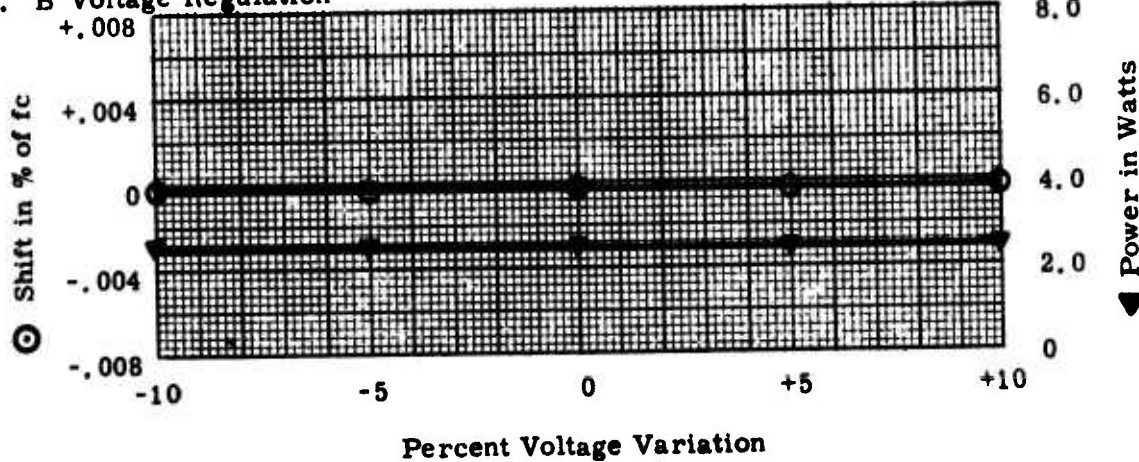

NORTHEASTERN UNIVERSITY

Evaluation Tests - RF Telemetry Transmitter - Sheet 2

Make: Conic ; Type: CTS-402 ; Serial Number: 4021096 ;
Carrier Frequency f_c : 2279.5 MHz; Date: 6/23/75 ; By: PJR ;

IV. Modulation Response vs. Temperature

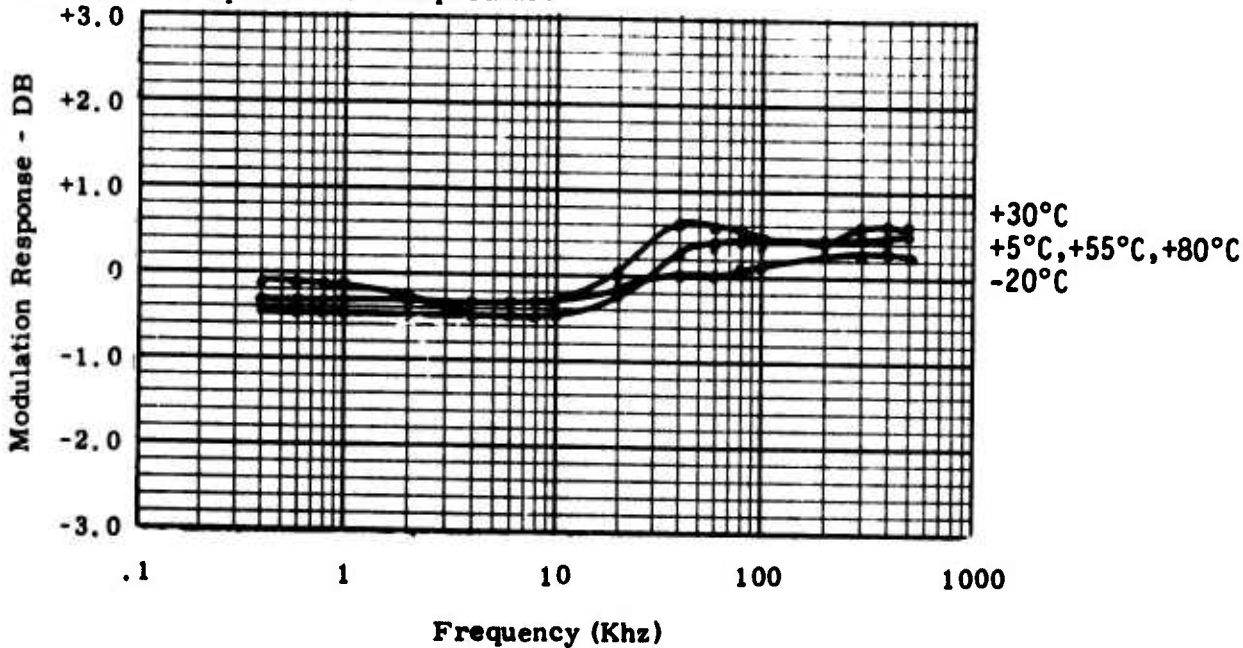

V. Linearity at Ambient

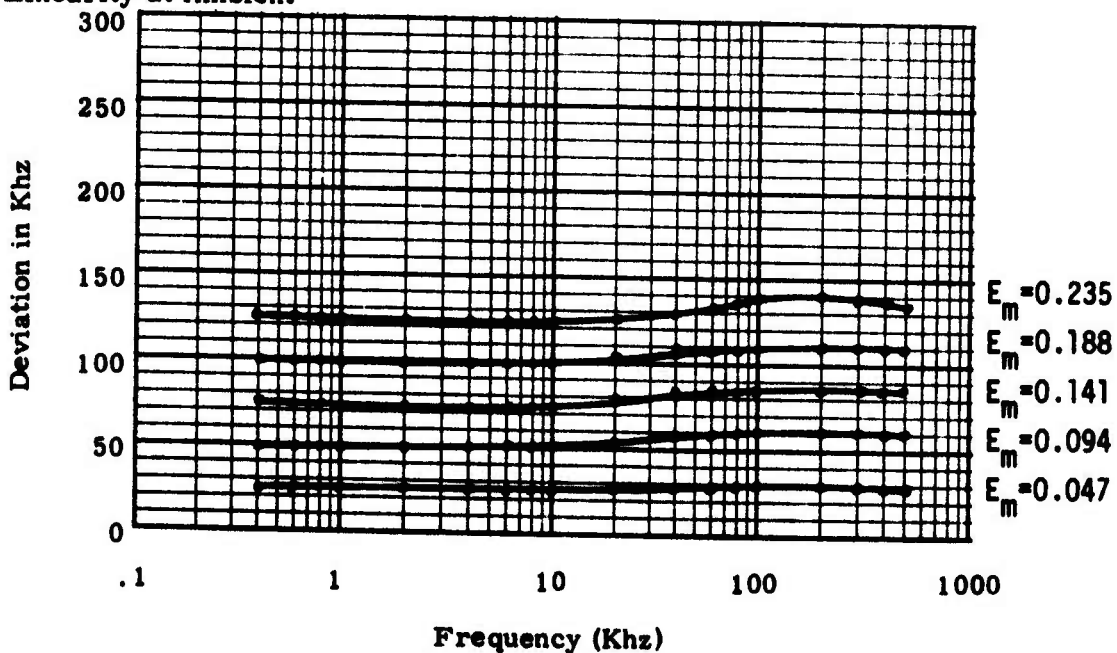

NORTHEASTERN UNIVERSITY

Evaluation Tests - RF Telemetry Transmitter - Sheet 3

Make: CONIC; Type: CTS-402; Serial Number: 4021096
 Carrier Frequency f_c : 2279.5 MHz; Date: 6/23/75; By: PJR

VI. Spurious Emission (Antenna Conducted)

Frequency Mhz	DB Down from f_c	Identification
2038	104 ± 3	$f_c - 2f_x$
2159	95 ± 3	$f_c - f_x$
2259	85 ± 3	$f_c - f_x/6$
2279.5	0	carrier frequency
2400	108 ± 3	$f_c + f_x$
3419	91 ± 3	$3f_c/2$
4559	63 ± 3	$2f_c$

NOTE: W.S.M.R. Regulation No. 105-2-60 requirement is $55+10 \log P_t$ DB Down from carrier.

VII. Miscellaneous

1. Maximum Distortion <2.0%
2. Incidental FM <500 Hz PEAK
3. Power Requirement 17.3 watts
4. Efficiency 14.6%
5. O.C. & S.C. Protection OK
6. Other Checks freq at 5:1 VSWR = 2279.4925
carrier shift = -0.0000175% of f_c for 5:1 VSWR

NORTHEASTERN UNIVERSITY

Evaluation Tests - RF Telemetry Transmitter - Sheet 1

Make: CONIC ; Type: CTS-402 ; Serial Number: 4021097 ;

Carrier Frequency f_c : 2279.5 MHz ; Date: 6/30/75 ; By: JFE ;

I. Time Drift

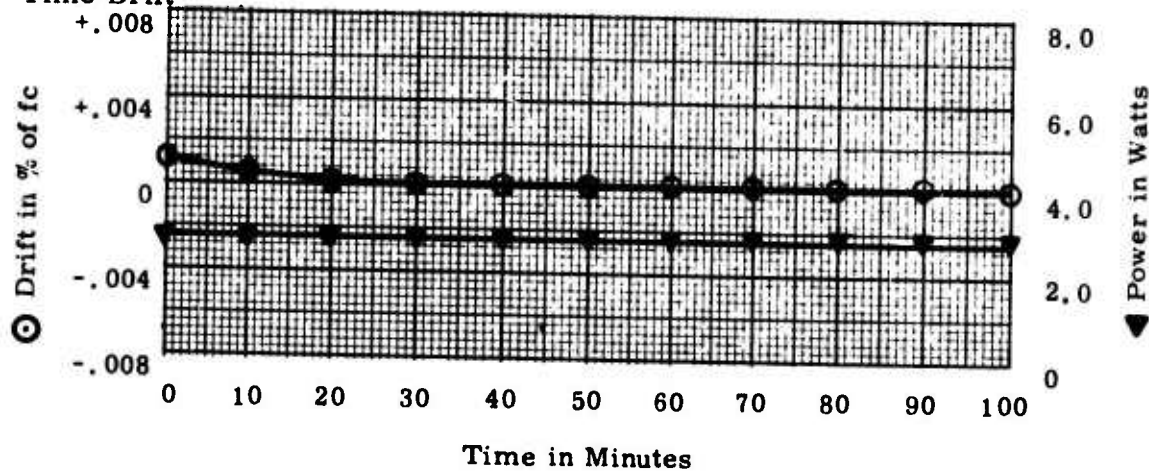

II. Temperature Stability

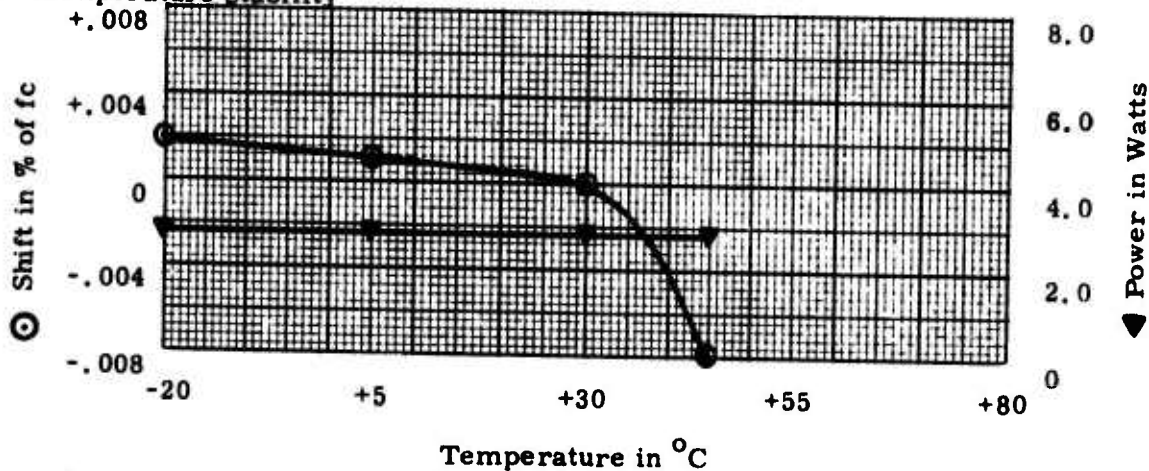

III. B⁺ Voltage Regulation

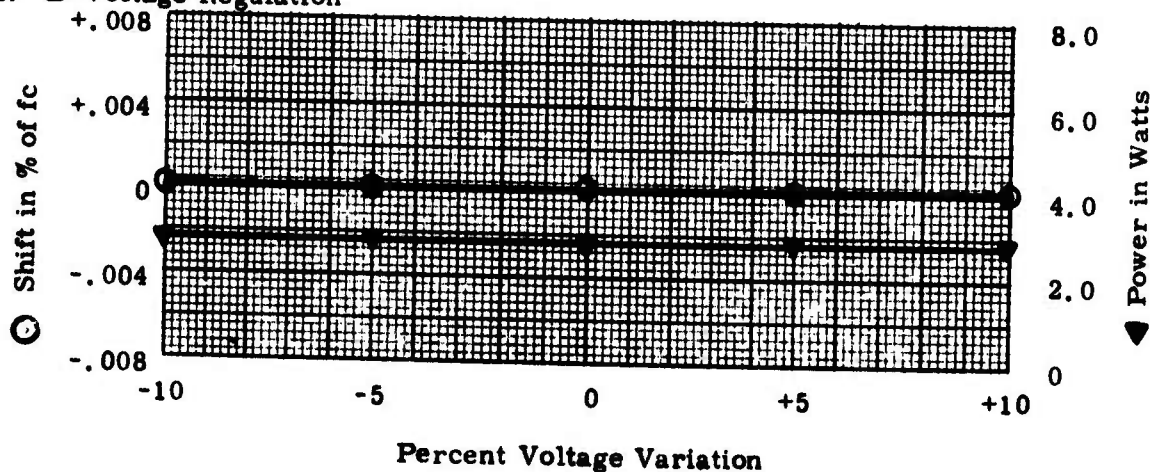

NORTHEASTERN UNIVERSITY

Evaluation Tests - RF Telemetry Transmitter - Sheet 2

Make: CONIC ; Type: CTS-402 ; Serial Number: 4021097 ;
 Carrier Frequency fc: 2279.5 MHz ; Date: 6/30/75 ; By: JFE ;

IV. Modulation Response vs. Temperature

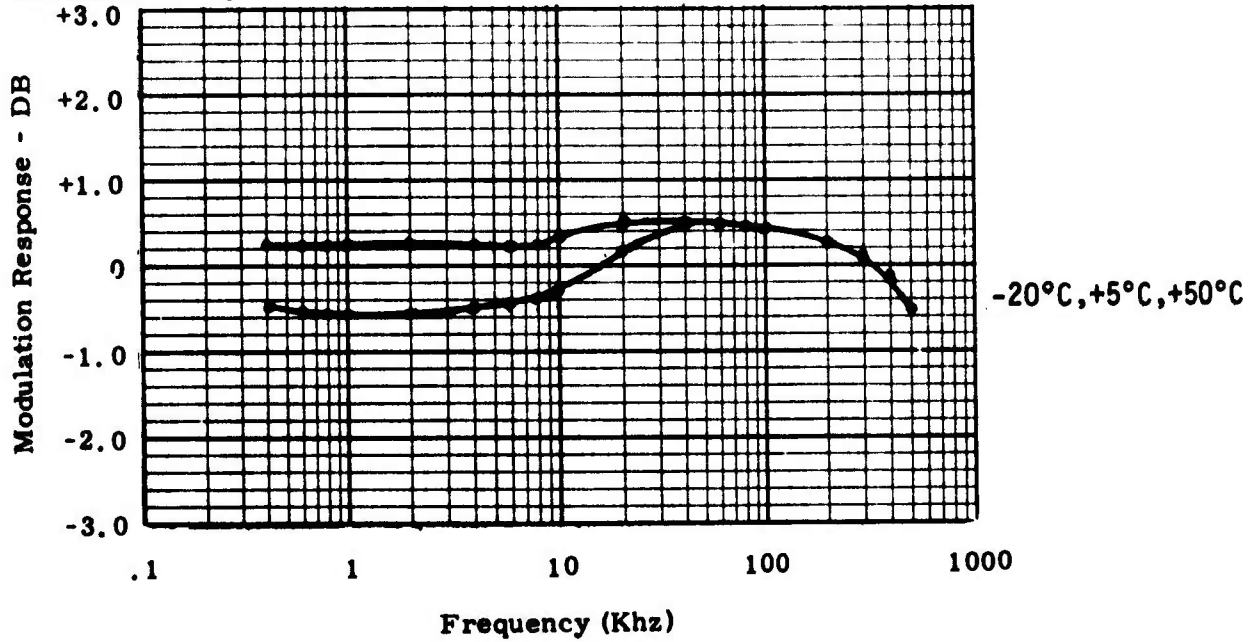

V. Linearity at Ambient

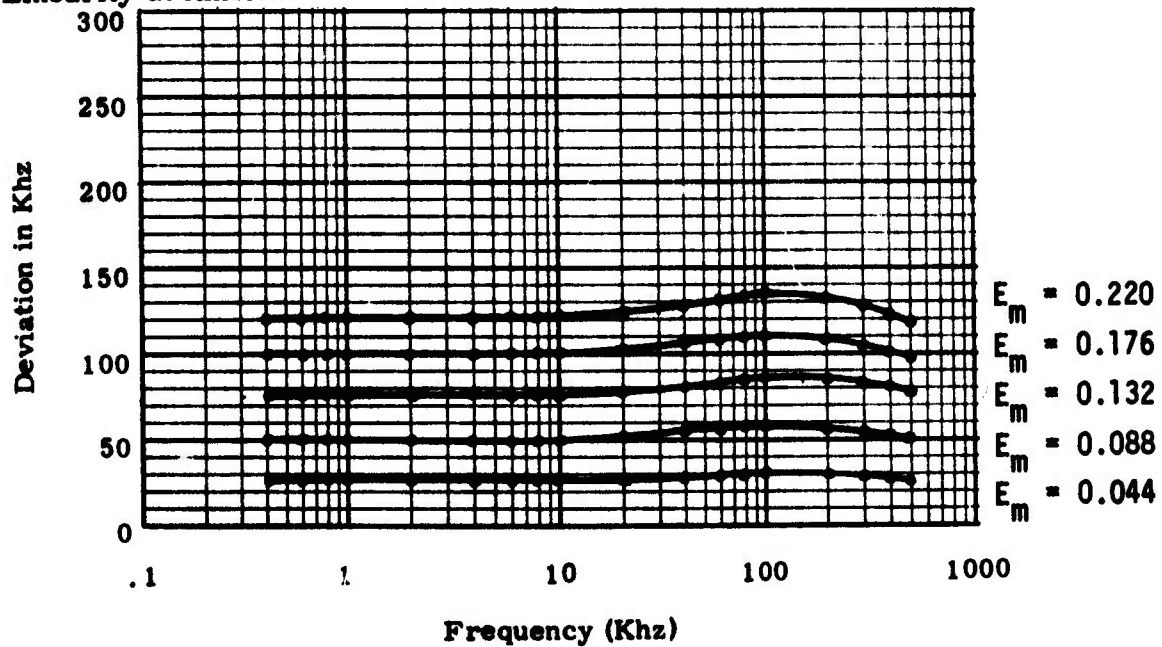

NORTHEASTERN UNIVERSITY

Evaluation Tests - RF Telemetry Transmitter - Sheet 3

Make: CONIC ; Type: CTS-402 ; Serial Number: 4021097
 Carrier Frequency fc: 2279.5 MHz; Date: 6/30/75 ; By: JFE

VI. Spurious Emission (Antenna Conducted)

Frequency Mhz	DB Down from fc	Identification
2026	109 ± 3	fc - 22fx
2262	88 ± 3	fc - 3fx/2
2279.5	0	carrier frequency
2291	88 ± 3	fc + fx
2532	112 ± 3	fc + 22fx
3419	111 ± 3	3fc/2
4559	71 ± 3	2fc

NOTE: W.S.M.R. Regulation No. 105-2-60 requirement is $55 + 10 \log P_t$ DB Down from carrier.

VII. Miscellaneous

1. Maximum Distortion <2.0%
2. Incidental FM <500 Hz PEAK
3. Power Requirement 19.6 watts
4. Efficiency 16.8%
5. O.C. & S.C. Protection OK
6. Other Checks freq at 5:1 VSWR = 2279.5029
carrier shift = +0.000132% fc for 5:1 VSWR

NORTHEASTERN UNIVERSITY

Evaluation Tests - RF Telemetry Transmitter - Sheet 1

Make: CONIC ; Type: CTS-402 ; Serial Number: 4021098 ;

Carrier Frequency f_c : 2279.5 MHz ; Date: 6/30/75 ; By: JFE ;

I. Time Drift

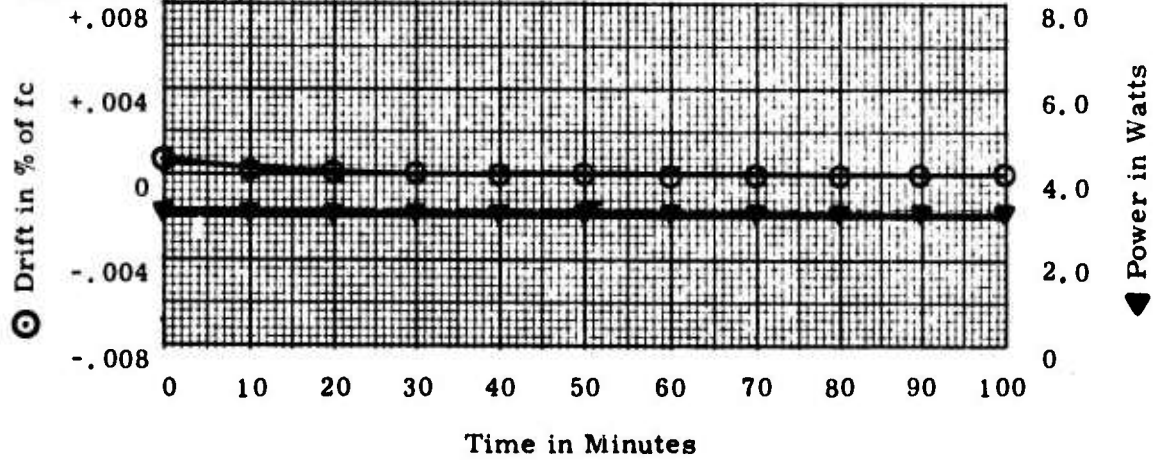

II. Temperature Stability

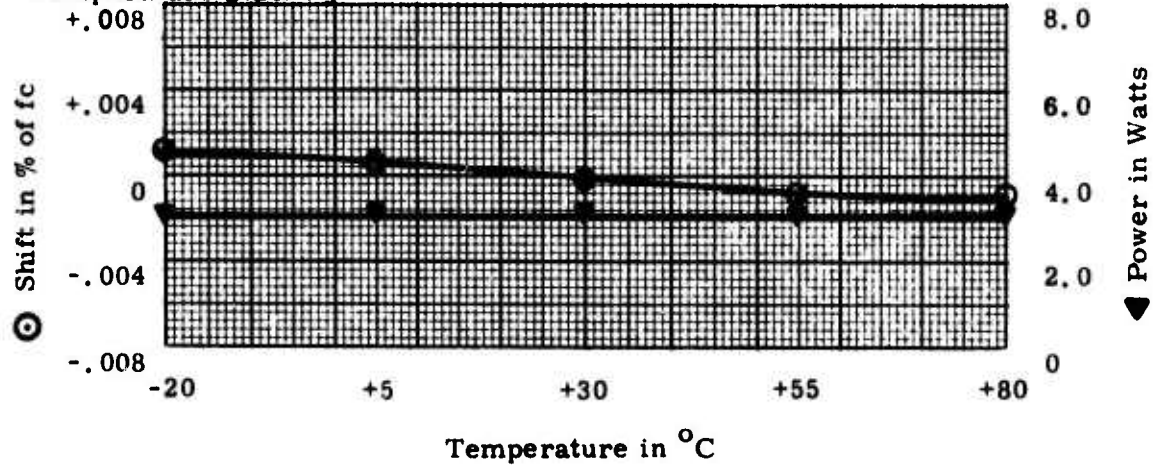

III. B⁺ Voltage Regulation

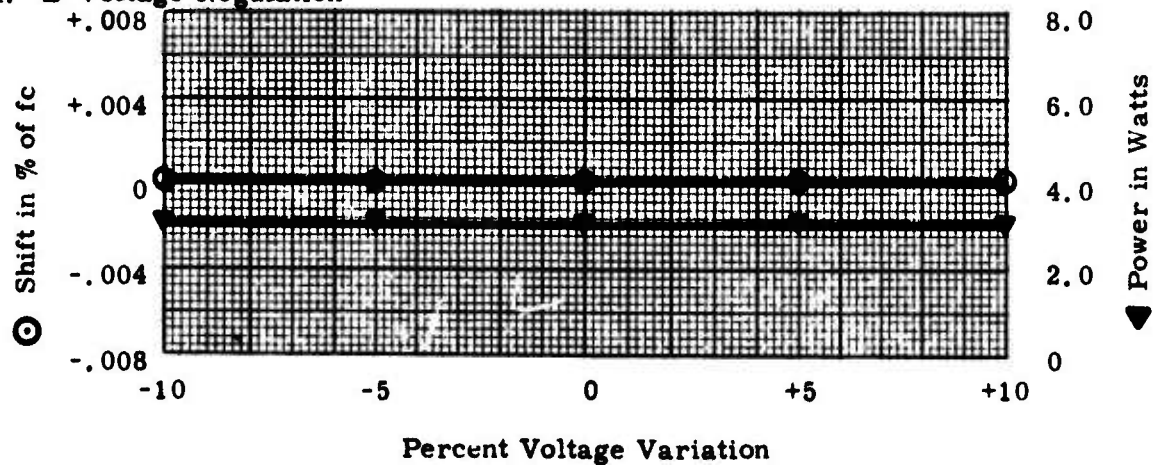

NORTHEASTERN UNIVERSITY

Evaluation Tests - RF Telemetry Transmitter - Sheet 2

Make: CONIC ; Type: CTS-402 ; Serial Number: 4021098 ;

Carrier Frequency f_c : 2279.5 MHz; Date: 6/30/75 ; By: JFE ;

IV. Modulation Response vs. Temperature

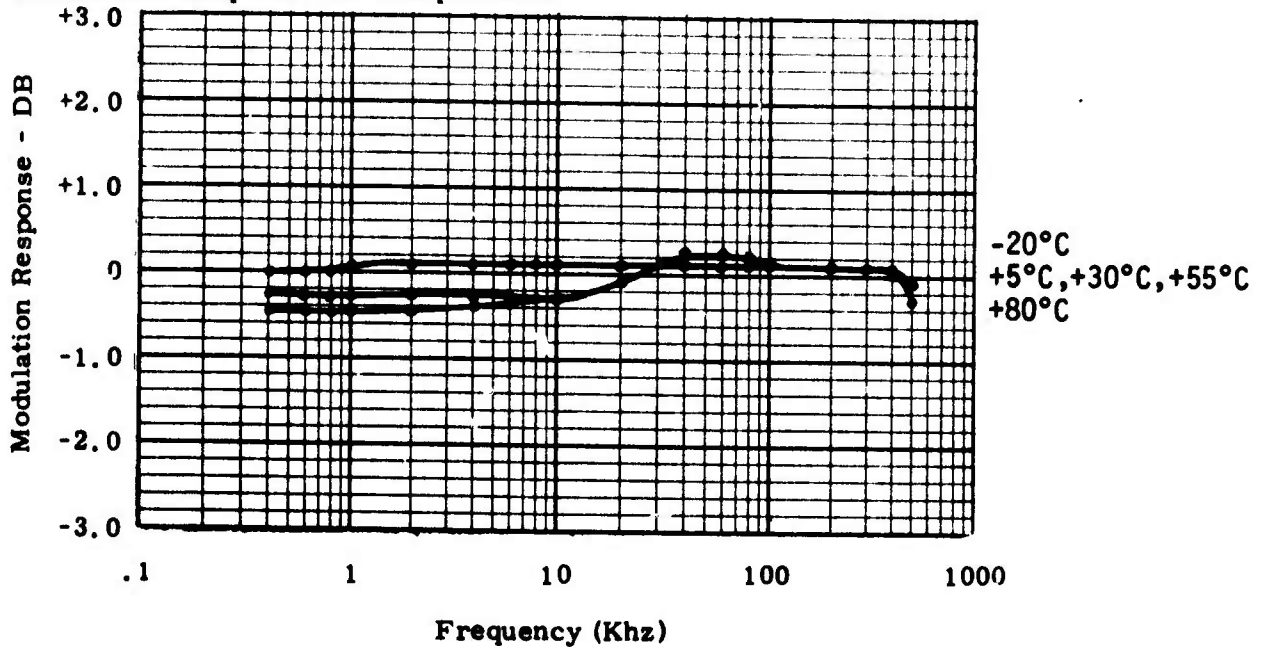

V. Linearity at Ambient

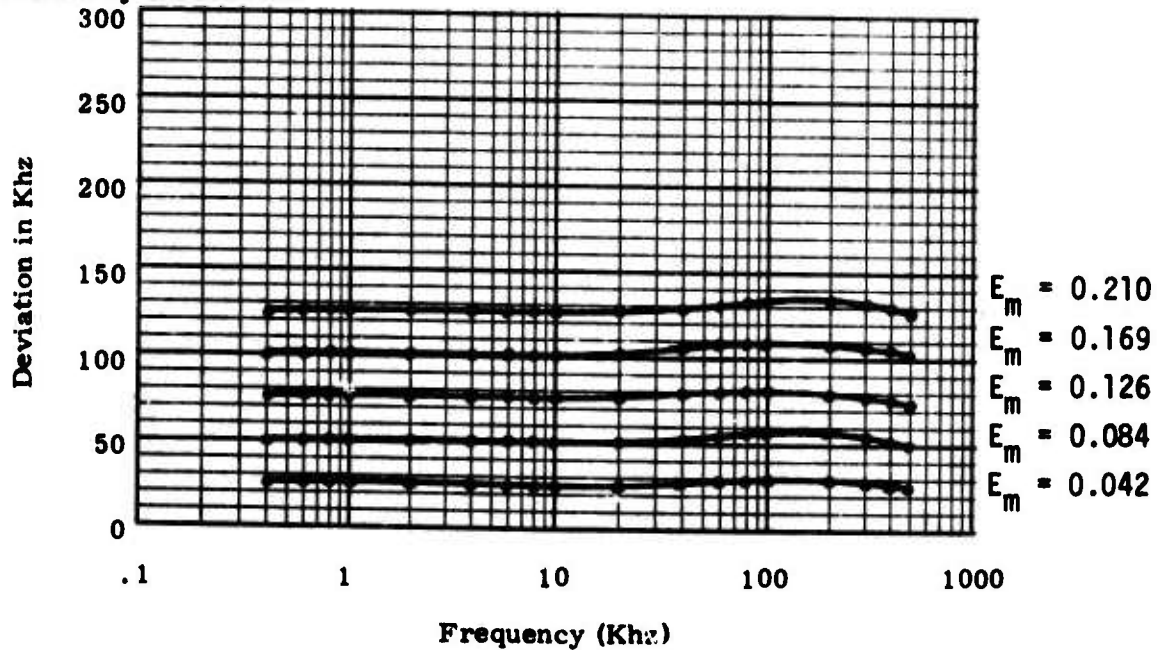

NORTHEASTERN UNIVERSITY

Evaluation Tests - RF Telemetry Transmitter - Sheet 3

Make: CONIC ; Type: CTS-402 ; Serial Number: 4021098
 Carrier Frequency f_c : 2279.5 MHz; Date: 6/30/75 ; By: JFE

VI. Spurious Emission (Antenna Conducted)

Frequency Mhz	DB Down from f_c	Identification
1140	64 ± 3	$1/2 f_c$
2026.5	106 ± 3	$f_c - 22f_x$
2155	100 ± 3	$f_c - 11f_x$
2262.3	89 ± 3	$f_c - 3f_x/2$
2279.5	0	carrier frequency
2291	87 ± 3	$f_x + f_x$
2314	86 ± 3	$f_c + 3f_x$
2406	111 ± 3	$f_c + 11f_x$
2532.5	112 ± 3	$f_c + 22f_x$
3419	90 ± 3	$3f_c/2$
4692	70 ± 3	$2f_c$
5699	68 ± 3	$5f_c/2$
6838.5	83 ± 3	$3f_c$

NOTE: W. S. M. R. Regulation No. 105-2-60 requirement is $55 + 10 \log P_t$ DB Down from carrier.

VII. Miscellaneous

1. Maximum Distortion <2.0%
2. Incidental FM <500 Hz PEAK
3. Power Requirement 19.6 watts
4. Efficiency 16.8%
5. O.C. & S.C. Protection OK
6. Other Checks freq at 5:1 VSWR = 2279.5030
carrier shift = +0.000131% of f_c for 5:1 VSWR

NORTHEASTERN UNIVERSITY

Evaluation Tests - RF Telemetry Transmitter - Sheet 1

Make: Conic ; Type: CTS-402 ; Serial Number: 4021099
 Carrier Frequency f_c : 2259.5 MHz; Date: 6/23/75 ; By: PJR

I. Time Drift

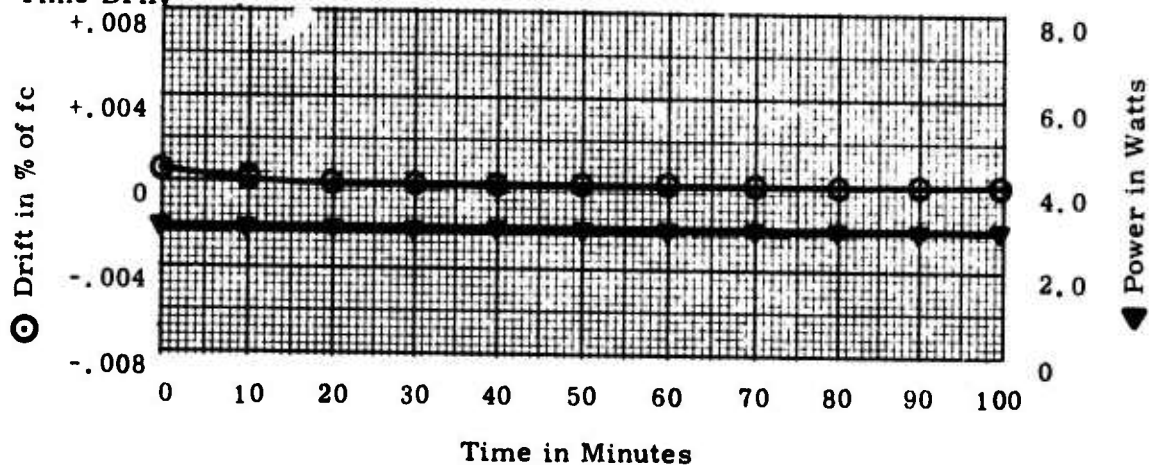

II. Temperature Stability

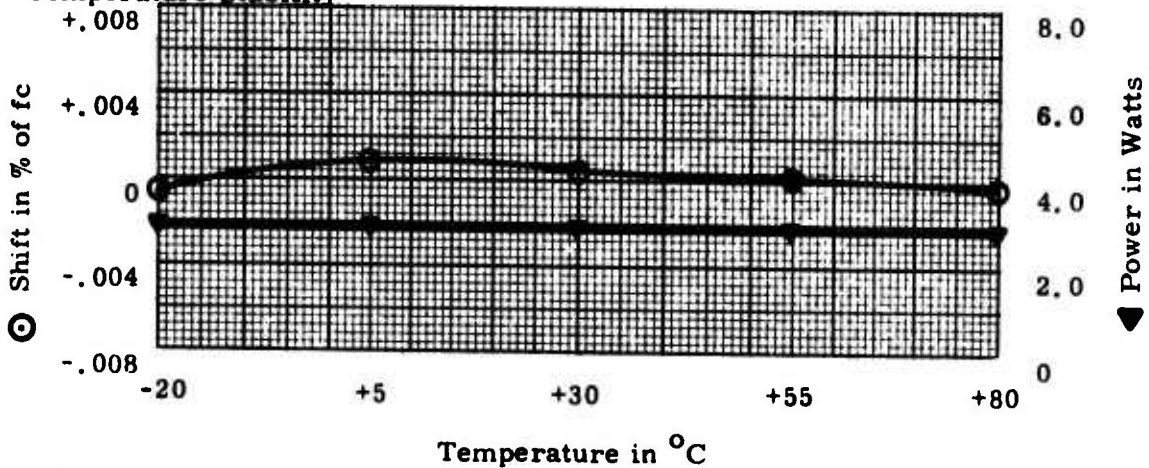

III. B⁺ Voltage Regulation

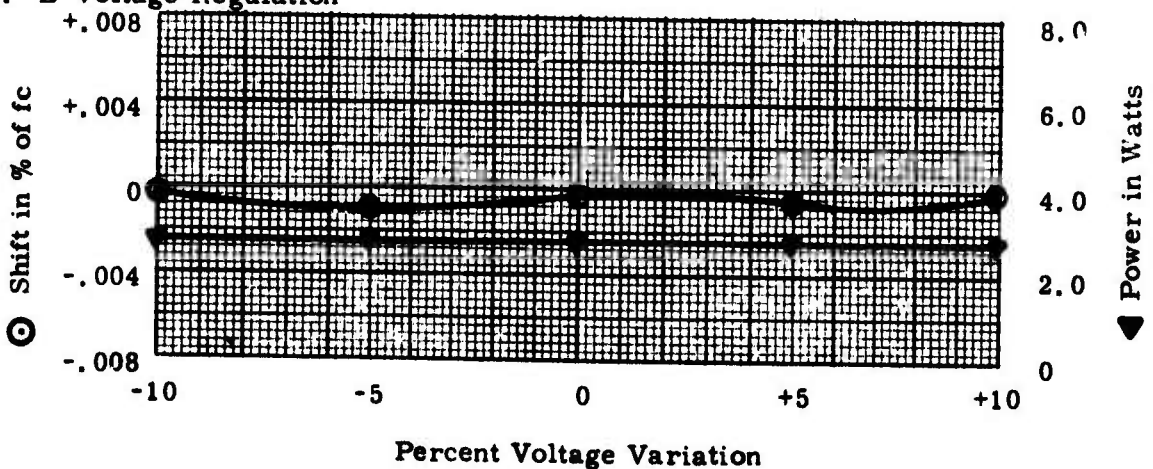

NORTHEASTERN UNIVERSITY

Evaluation Tests - RF Telemetry Transmitter - Sheet 2

Make: Conic ; Type: CTS-402 ; Serial Number: 4021099 ;
Carrier Frequency f_c : 2259.5 MHz; Date: 6/23/75 ; By: PJR ;

IV. Modulation Response vs. Temperature

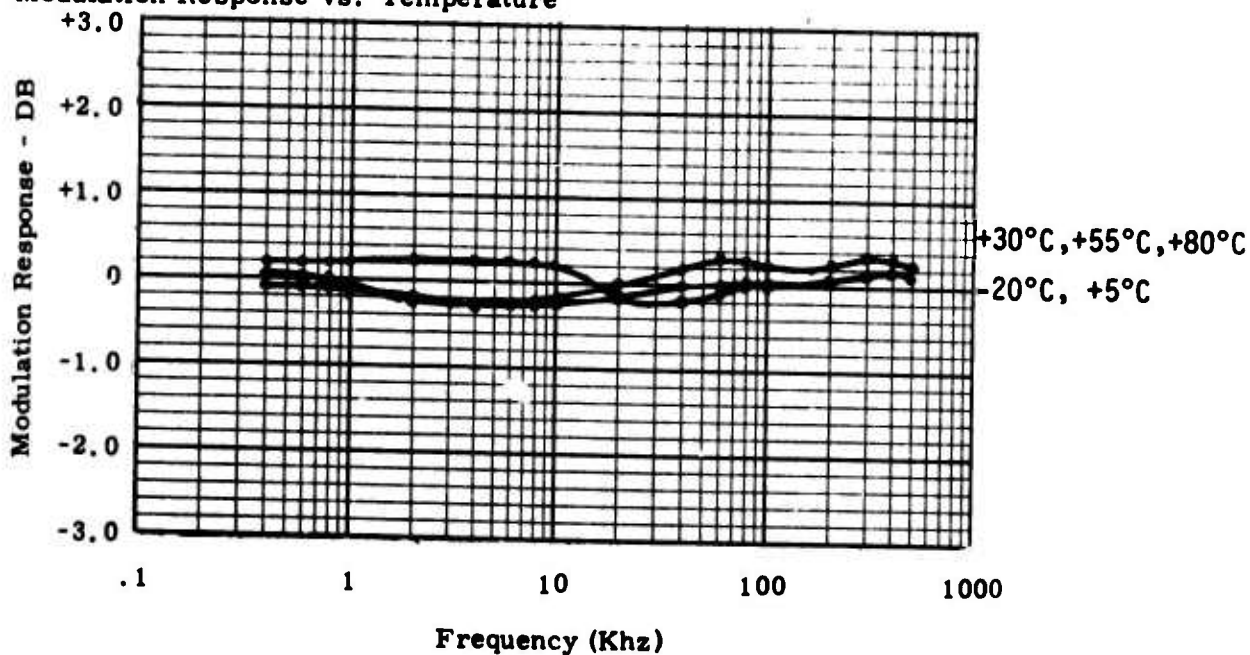

V. Linearity at Ambient

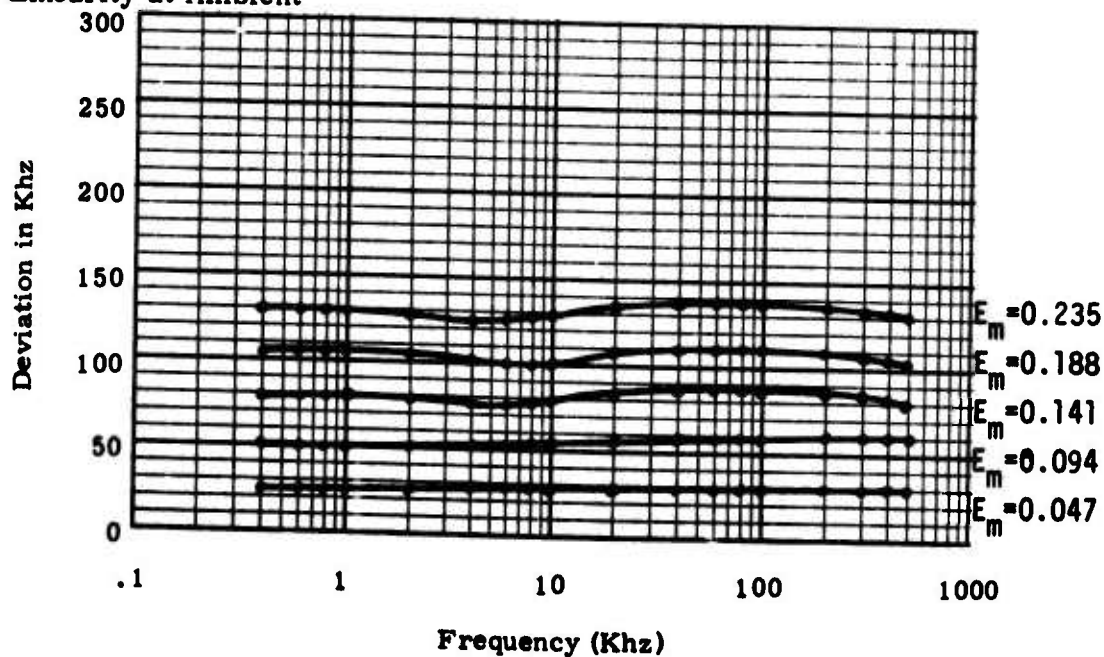

NORTHEASTERN UNIVERSITY

Evaluation Tests - RF Telemetry Transmitter - Sheet 3

Make: CONIC ; Type: CTS-402 ; Serial Number: 4021099 ;
 Carrier Frequency fc: 2259.5 MHz; Date: 6/23/75 ; By: PJR ;

VI. Spurious Emission (Antenna Conducted)

Frequency Mhz	DB Down from fc	Identification
2138	94 ± 3	fc - 9fx
2246	79 ± 3	fc - fx
2259.5	0	carrier frequency
2273	80 ± 3	fc + fx
2381	110 ± 3	fc + 9fx
3389	108 ± 3	3fc/2
4519	70 ± 3	2fc

NOTE: W.S.M.R. Regulation No. 105-2-60 requirement is $55+10 \log P_t$ DB Down from carrier.

VII. Miscellaneous

1. Maximum Distortion <2.0%
2. Incidental FM <500 Hz PEAK
3. Power Requirement 18.2 watts
4. Efficiency 16.1%
5. O.C. & S.C. Protection OK
6. Other Checks freq at 5:1 VSWR = 2259.4989
carrier shift = +0.00292% of fc at 5:1 VSWR

NORTHEASTERN UNIVERSITY

Evaluation Tests - RF Telemetry Transmitter - Sheet 1

Make: Conic ; Type: CTS-402 ; Serial Number: 4021100

Carrier Frequency f_c : 2259.5 MHz; Date: 6/23/75 ; By: PJR

I. Time Drift

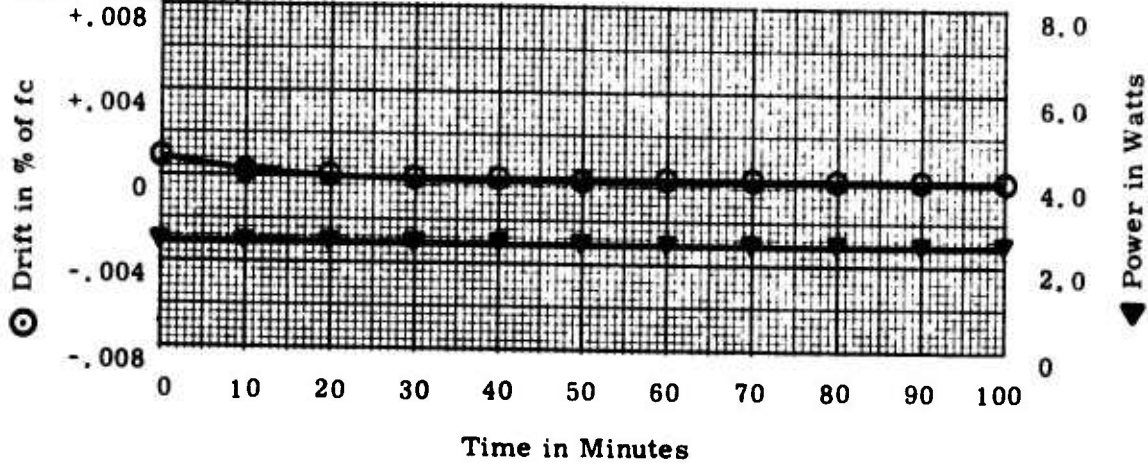

II. Temperature Stability

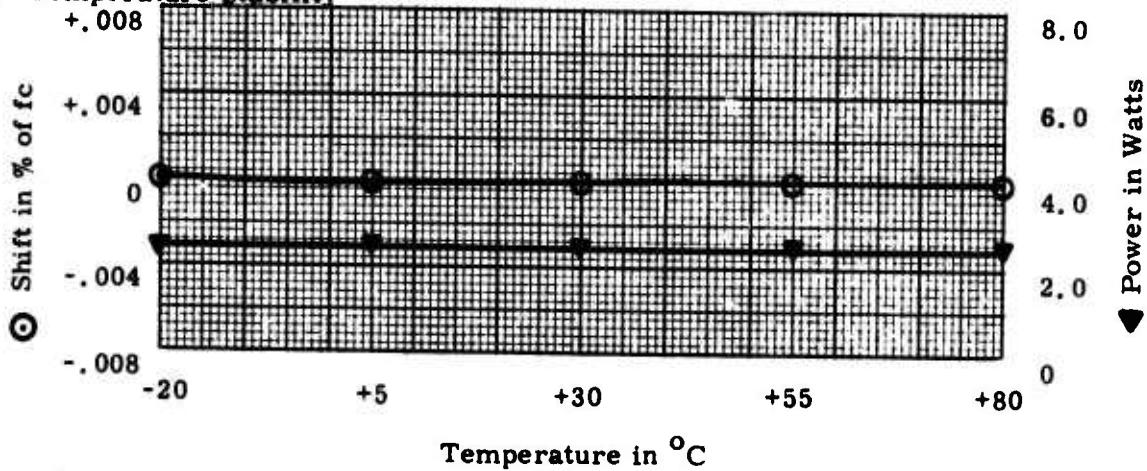

III. B⁺ Voltage Regulation

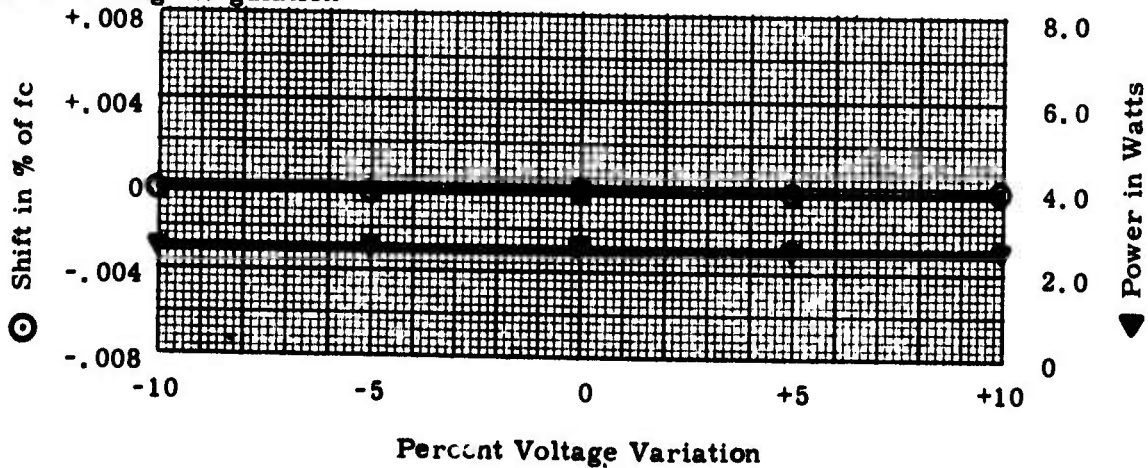

NORTHEASTERN UNIVERSITY

Evaluation Tests - RF Telemetry Transmitter - Sheet 2

Make: Conic ; Type: CTS-402 ; Serial Number: 4021100 ;
Carrier Frequency f_c : 2259.5 MHz; Date: 6/23/75 ; By: PJR ;

IV. Modulation Response vs. Temperature

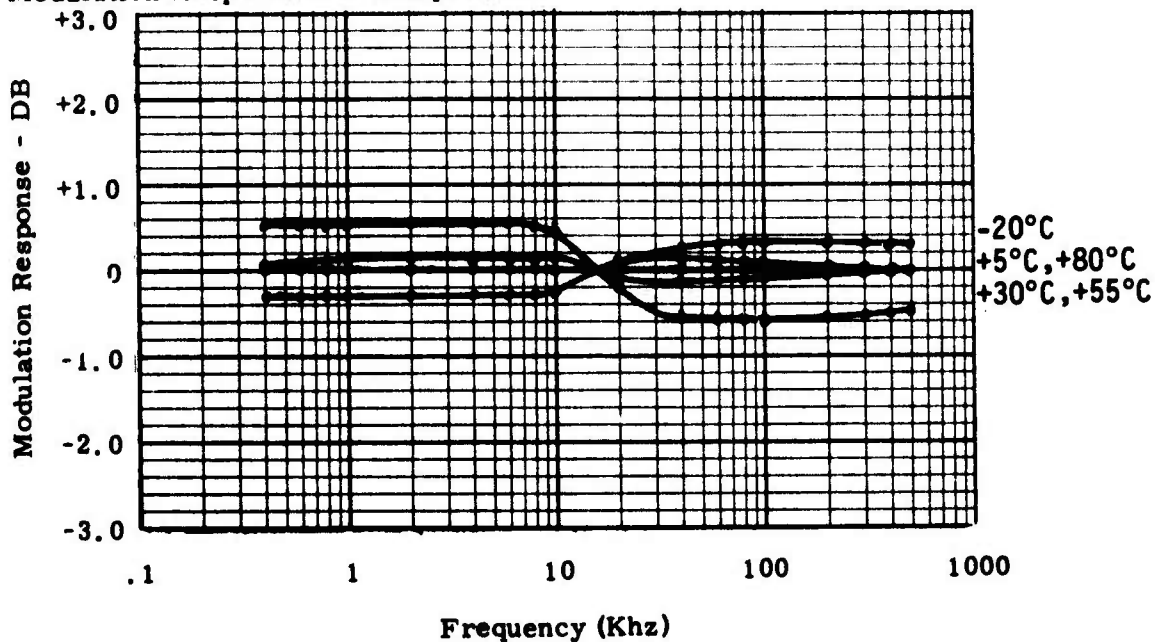

V. Linearity at Ambient

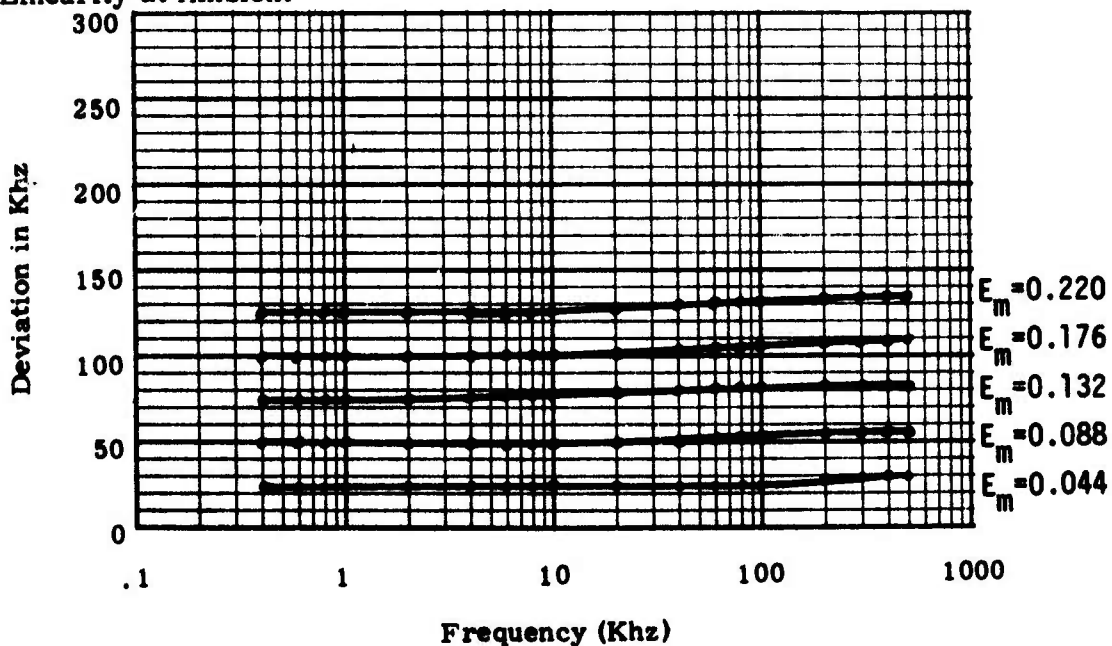

NORTHEASTERN UNIVERSITY

Evaluation Tests - RF Telemetry Transmitter - Sheet 3

Make: CONIC; Type: CTS-402; Serial Number: 4021100

Carrier Frequency f_c : 2259.5 MHz; Date: 6/23/75; By: PJR

VI. Spurious Emission (Antenna Conducted)

Frequency Mhz	DB Down from f_c	Identification
2016	110 ± 3	$f_c - 18f_x$
2138	90 ± 3	$f_c - 9f_x$
2246	85 ± 3	$f_c - f_x$
2259.5	0	carrier frequency
2273	85 ± 3	$f_c + f_x$
2381	100 ± 3	$f_c + 9f_x$
2502	110 ± 3	$f_c + 18f_x$
3389	97 ± 3	$3f_c/2$
4519	90 ± 3	$2f_c$

NOTE: W.S.M.R. Regulation No. 105-2-60 requirement is $55+10 \log P_t$ DB Down from carrier.

VII. Miscellaneous

1. Maximum Distortion <2.0%
2. Incidental FM <500 Hz PEAK
3. Power Requirement 21.0 watts
4. Efficiency 12.2%
5. O.C. & S.C. Protection OK
6. Other Checks freq at 5:1 VSWR = 2259.4899
carrier shift = -0.0017% of f_c for 5:1 VSWR

NORTHEASTERN UNIVERSITY

Evaluation Tests - RF Telemetry Transmitter - Sheet 1

Make: Conic ; Type: CTS-402 ; Serial Number: 4021101

Carrier Frequency f_c : 2259.5 MHz; Date: 6/23/75 ; By: PJR

I. Time Drift

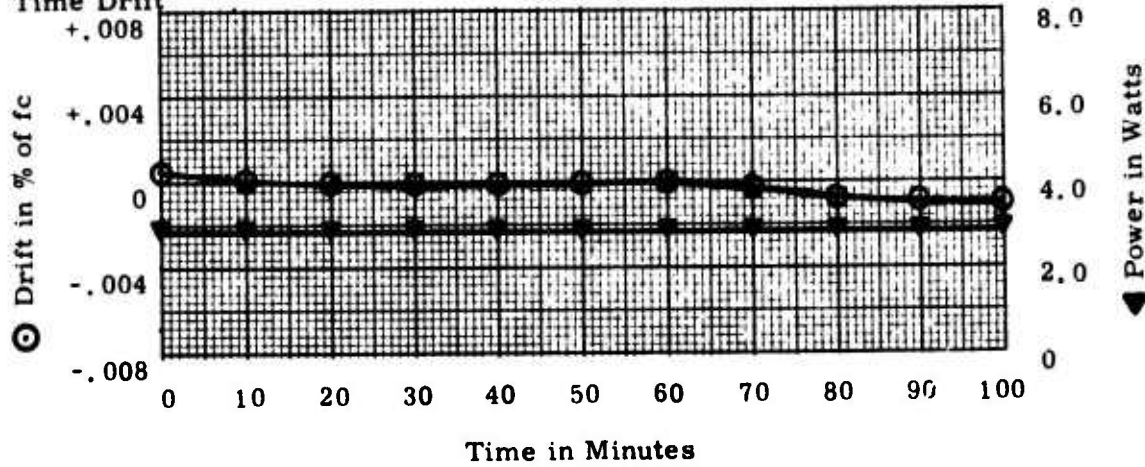

II. Temperature Stability

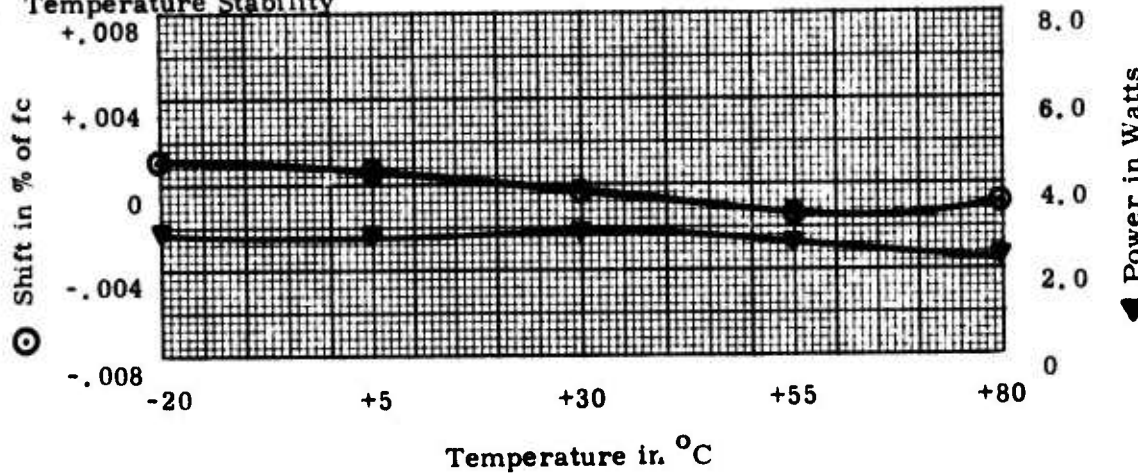

III. B⁺ Voltage Regulation

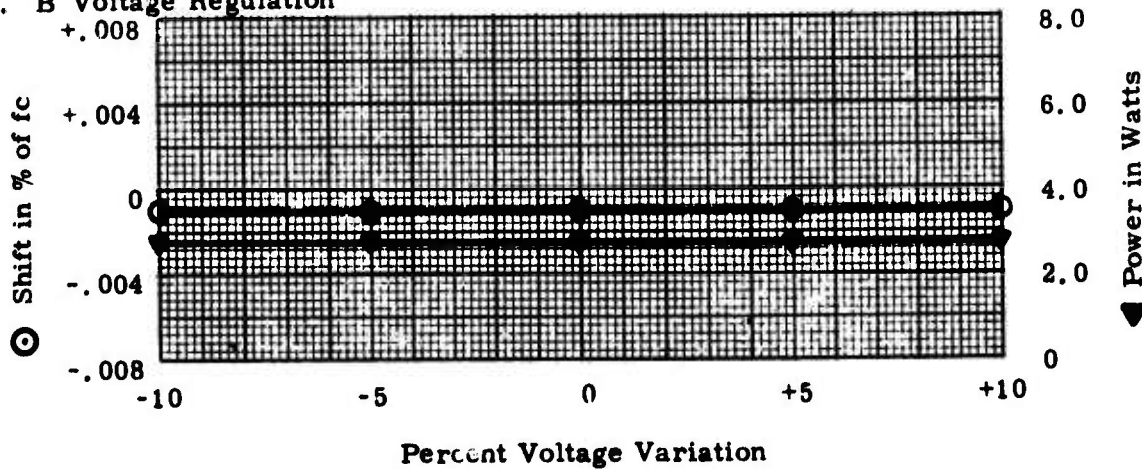

NORTHEASTERN UNIVERSITY

Evaluation Tests - RF Telemetry Transmitter - Sheet 2

Make: Conic ; Type: CTS-402 ; Serial Number: 4021101 ;
Carrier Frequency f_c : 2259.5 MHz; Date: 6/23/75 ; By: PJR ;

IV. Modulation Response vs. Temperature

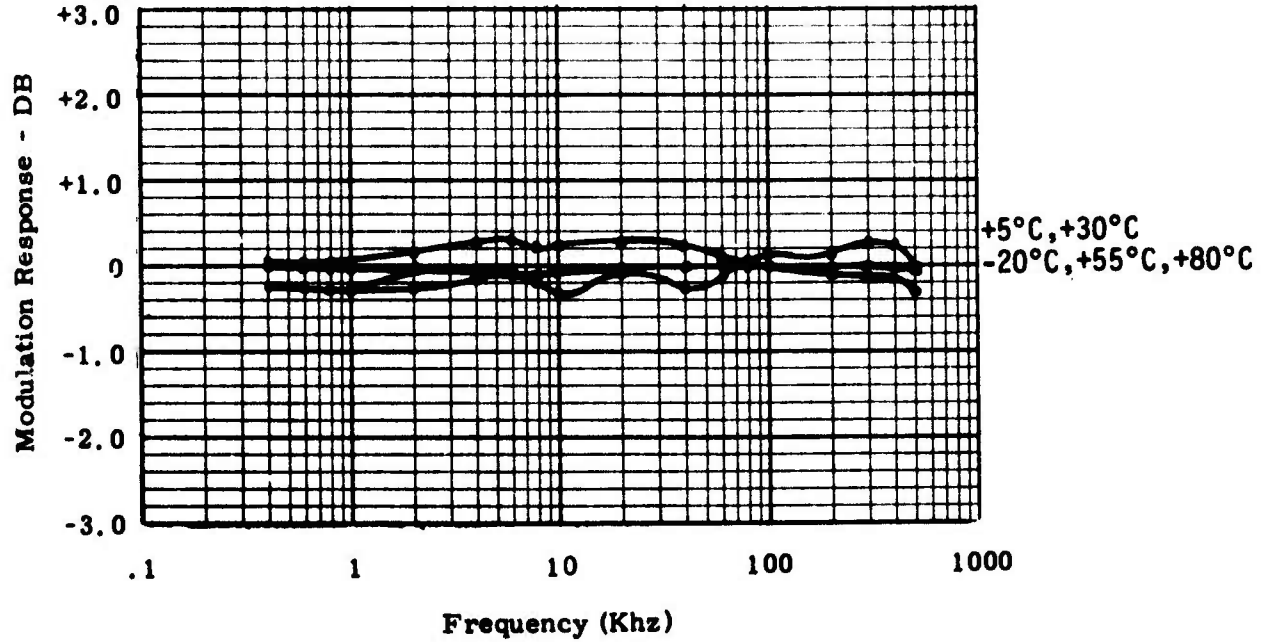

V. Linearity at Ambient

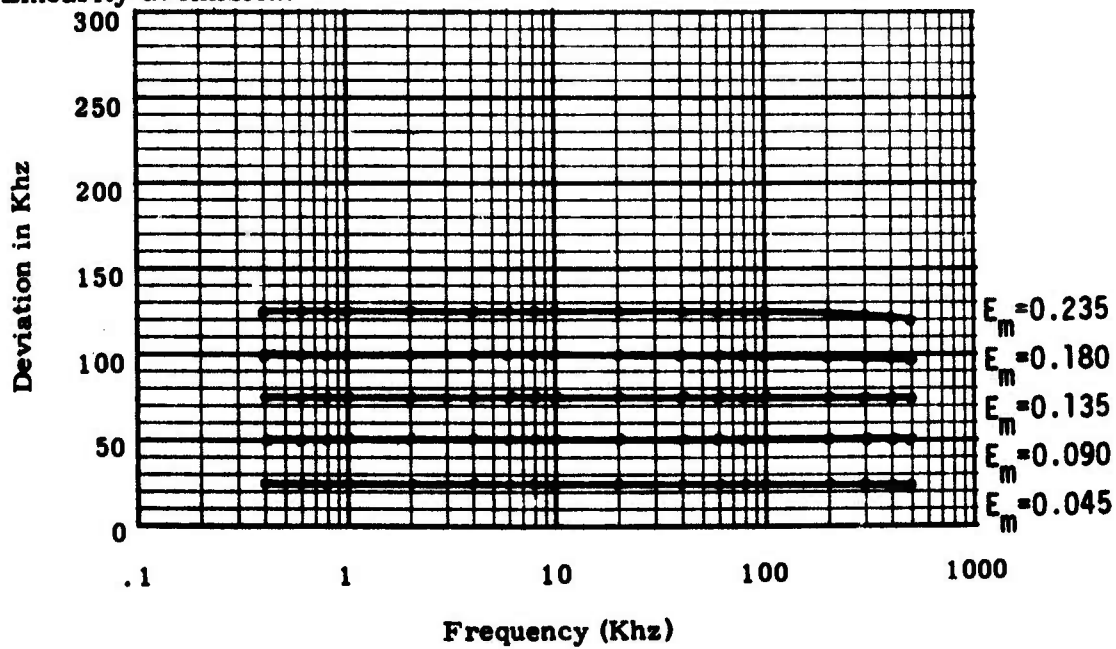

NORTHEASTERN UNIVERSITY

Evaluation Tests - RF Telemetry Transmitter - Sheet 3

Make: CONIC; Type: CTS-402; Serial Number: 4021101;
 Carrier Frequency f_c : 2259.5 MHz; Date: 6/23/75; By: PJR;

VI. Spurious Emission (Antenna Conducted)

Frequency Mhz	DB Down from f_c	Identification
2138	92 ± 3	$f_c - 9f_x$
2246	86 ± 3	$f_c - f_x$
2259.5	0	carrier frequency
2273	86 ± 3	$f_c + f_x$
2381	105 ± 3	$f_c + 9f_x$
3389	101 ± 3	$3f_c/2$
4519	65 ± 3	$2f_c$

NOTE: W. S. M. R. Regulation No. 105-2-60 requirement is $55 + 10 \log P_t$ DB Down from carrier.

VII. Miscellaneous

1. Maximum Distortion <2.0%
2. Incidental FM <500 Hz PEAK
3. Power Requirement 19.7 watts
4. Efficiency 14.7%
5. O.C. & S.C. Protection OK
6. Other Checks freq at 5:1 VSWR = 2259.4770
carrier shift = -0.007521% of f_c for 5:1 VSWR

NORTHEASTERN UNIVERSITY

Evaluation Tests - RF Telemetry Transmitter - Sheet 1

Make: Conic ; Type: CTS-402 ; Serial Number: 4021102 ;

Carrier Frequency f_c : 2259.5 MHz ; Date: 6/23/75 ; By: PJR ;

I. Time Drift

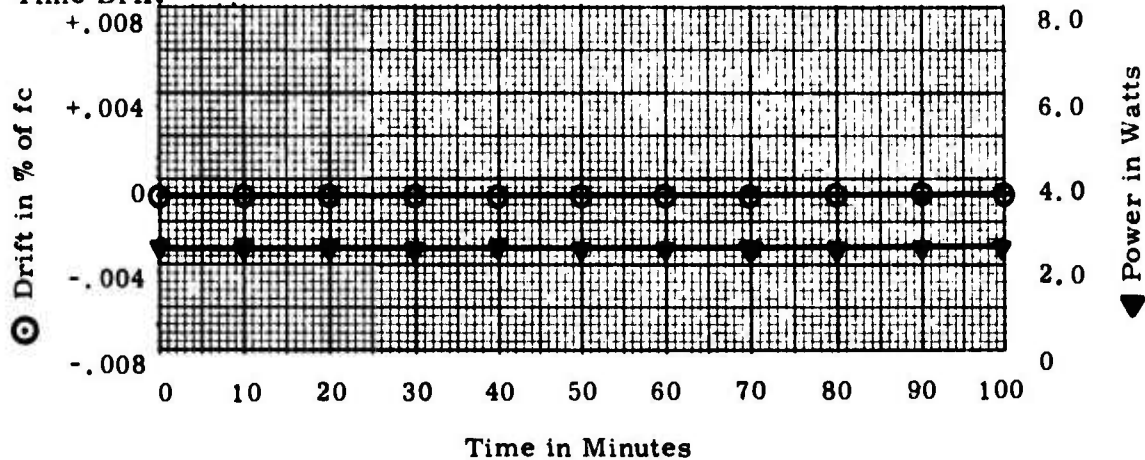

II. Temperature Stability

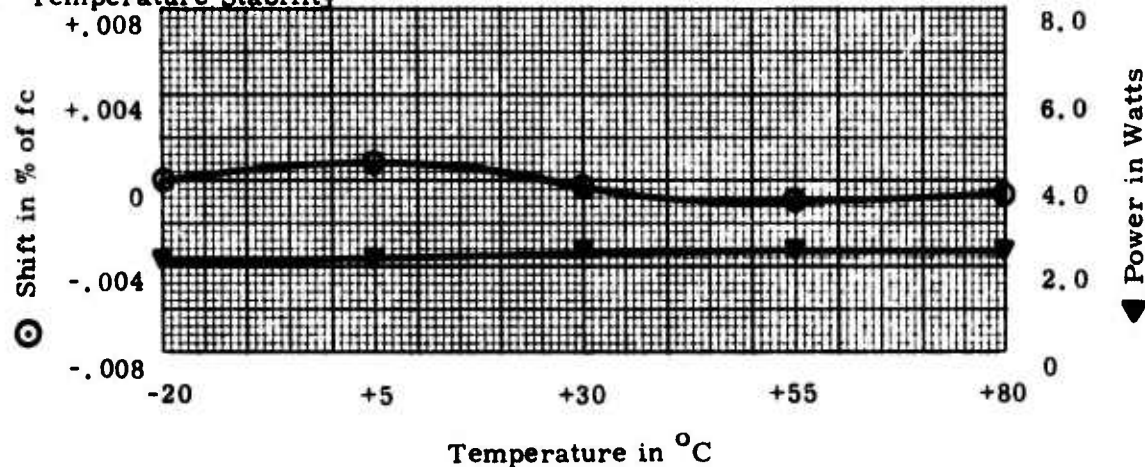

III. B⁺ Voltage Regulation

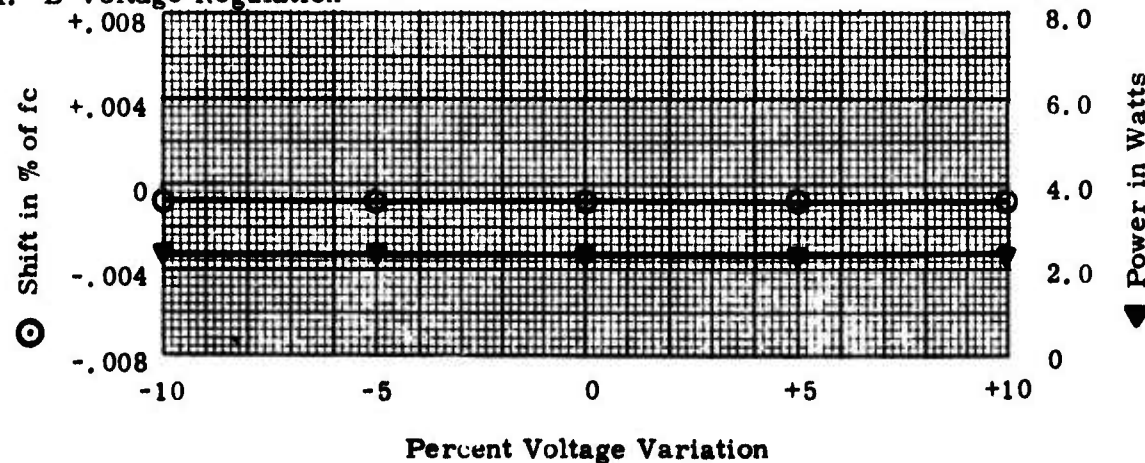

NORTHEASTERN UNIVERSITY

Evaluation Tests - RF Telemetry Transmitter - Sheet 2

Make: Conic; Type: CTS-402; Serial Number: 4021102;
Carrier Frequency f_c : 2259.5 MHz; Date: 6/23/75; By: PJR

IV. Modulation Response vs. Temperature

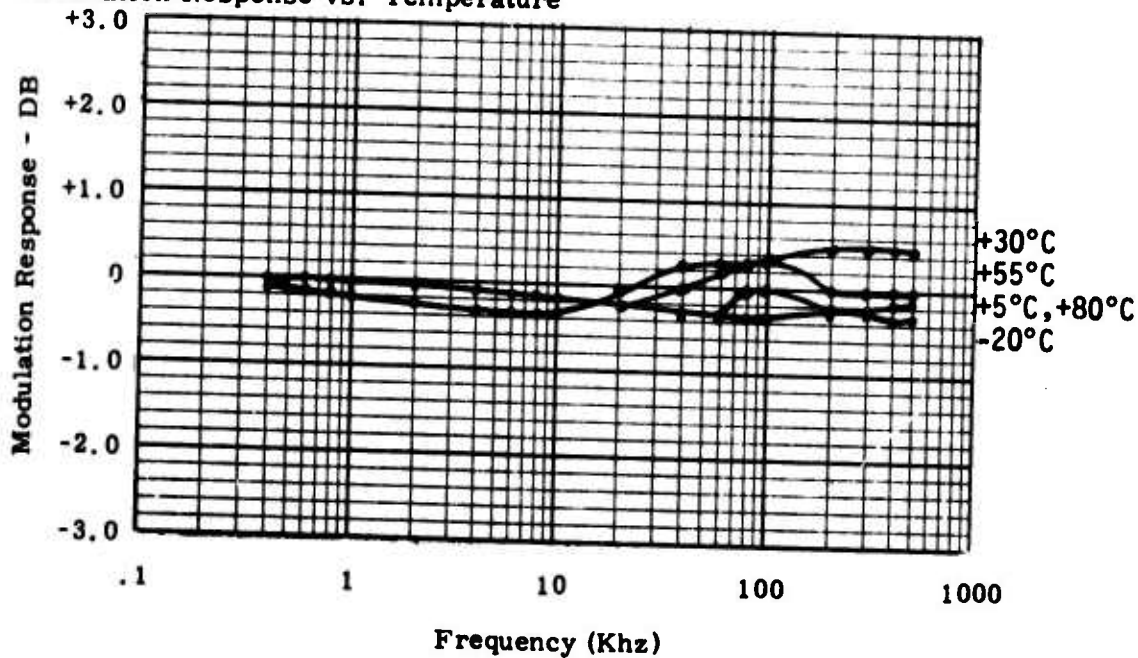

V. Linearity at Ambient

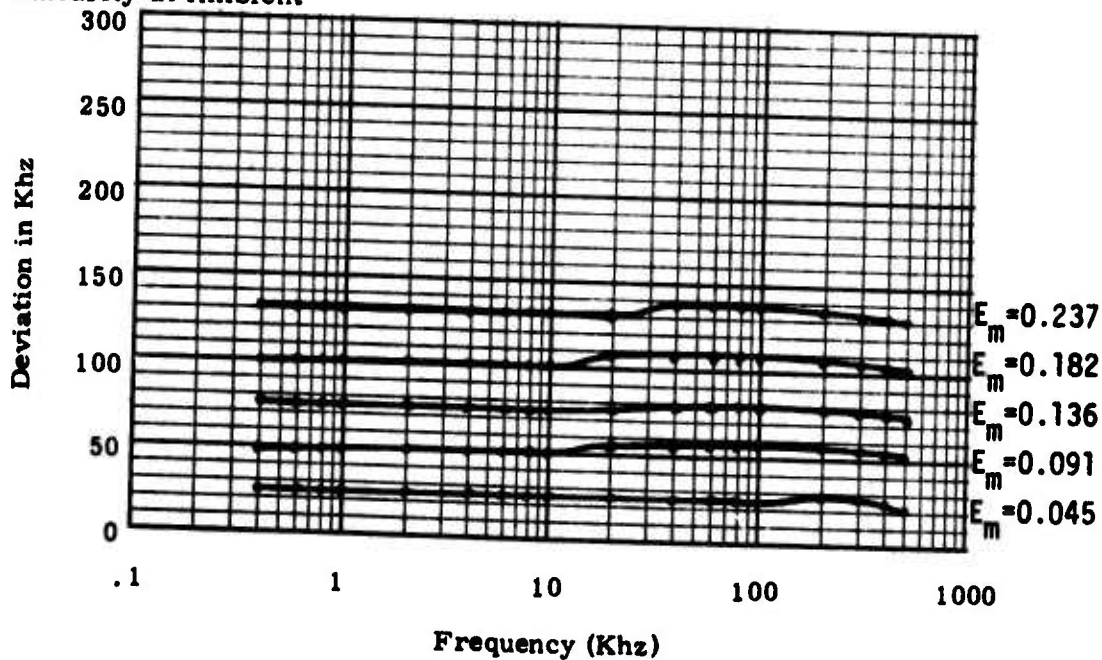

NORTHEASTERN UNIVERSITY

Evaluation Tests - RF Telemetry Transmitter - Sheet 3

Make: CONIC ; Type: CTS-402 ; Serial Number: 4021102
 Carrier Frequency f_c : 2259.5 MHz; Date: 6/23/75 ; By: PJR

VI. Spurious Emission (Antenna Conducted)

Frequency Mhz	DB Down from f_c	Identification
2016	100 ± 3	$f_c - 2f_x$
2138	90 ± 3	$f_c - f_x$
2259.5	0	carrier frequency
3389	80 ± 3	$3f_c/2$
4519	67 ± 3	$2f_c$

NOTE: W.S.M.R. Regulation No. 105-2-60 requirement is $55 + 10 \log P_t$ DB Down from carrier.

VII. Miscellaneous

1. Maximum Distortion <2.0%
2. Incidental FM <500 Hz PEAK
3. Power Requirement 17.91 watts
4. Efficiency 13.1%
5. O.C. & S.C. Protection OK
6. Other Checks freq at 5:1 VSWR = 2259.4893
carrier shift = -0.0004421% of f_c for 5:1 VSWR

NORTHEASTERN UNIVERSITY

Evaluation Tests - RF Telemetry Transmitter - Sheet 1

Make: Conic ; Type: CTS-402 ; Serial Number: 4021103 ;

Carrier Frequency f_c : 2259.5 MHz; Date: 6/23/75 ; By: PJR ;

I. Time Drift

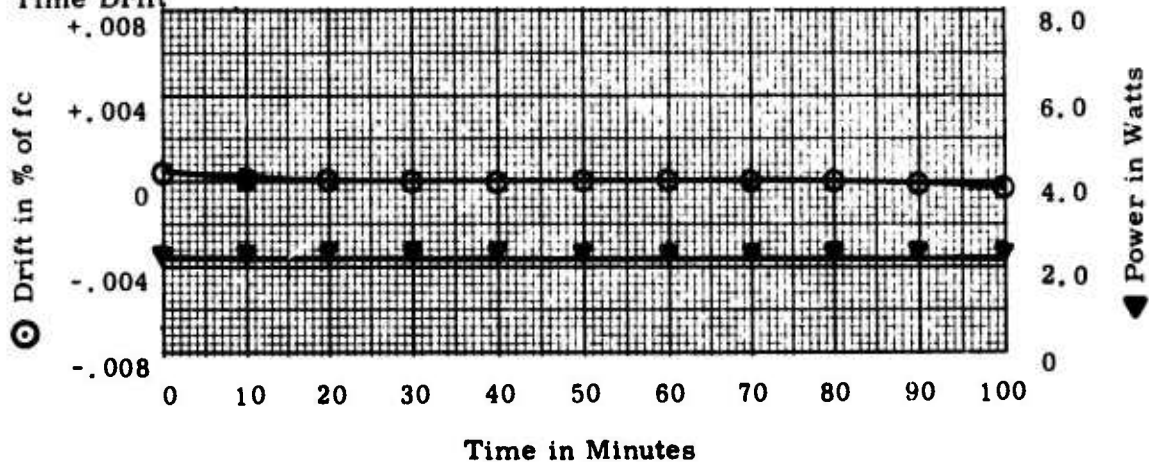

II. Temperature Stability

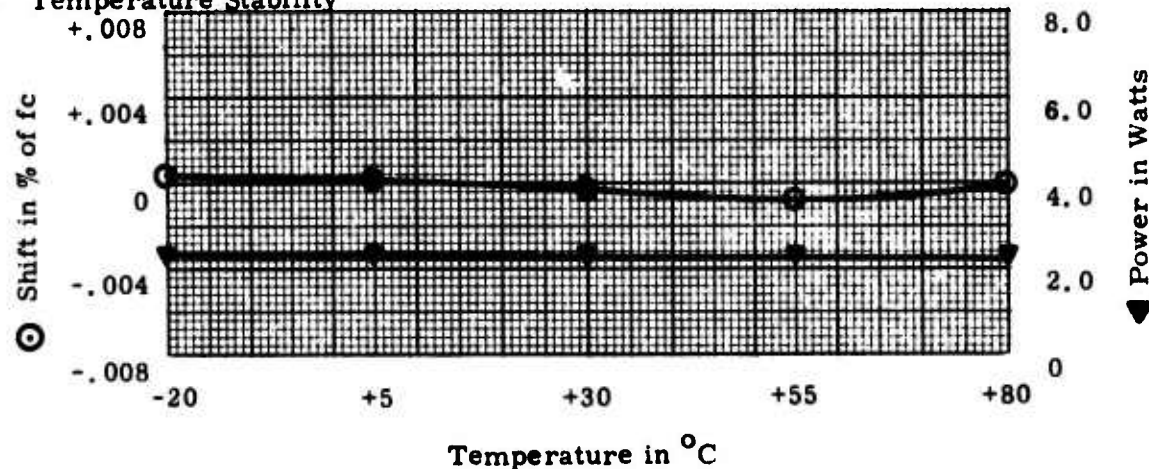

III. B⁺ Voltage Regulation

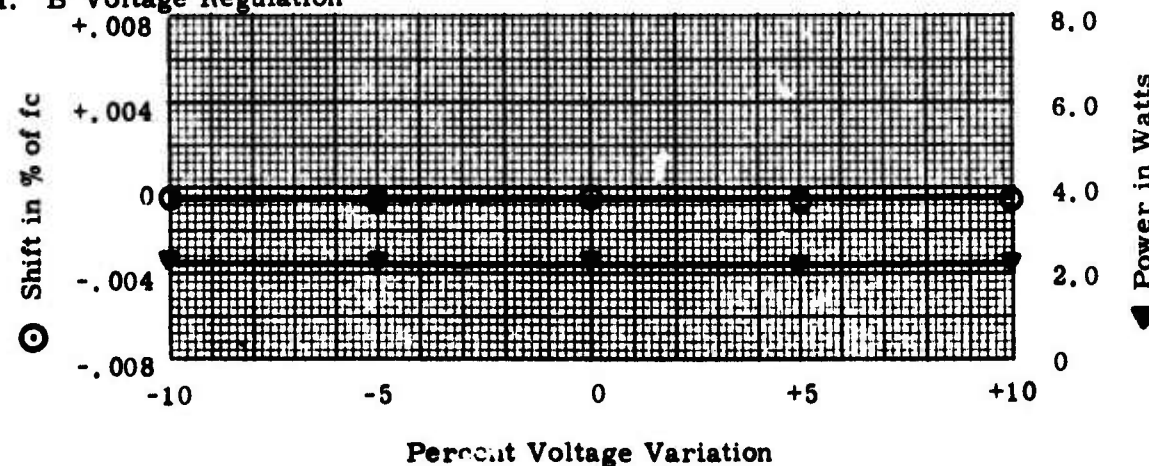

NORTHEASTERN UNIVERSITY

Evaluation Tests - RF Telemetry Transmitter - Sheet 2

Make: Conic ; Type: CTS-402 ; Serial Number: 4021103 ;
Carrier Frequency f_c : 2259.5 MHz; Date: 6/23/75 ; By: PJR ;

IV. Modulation Response vs. Temperature

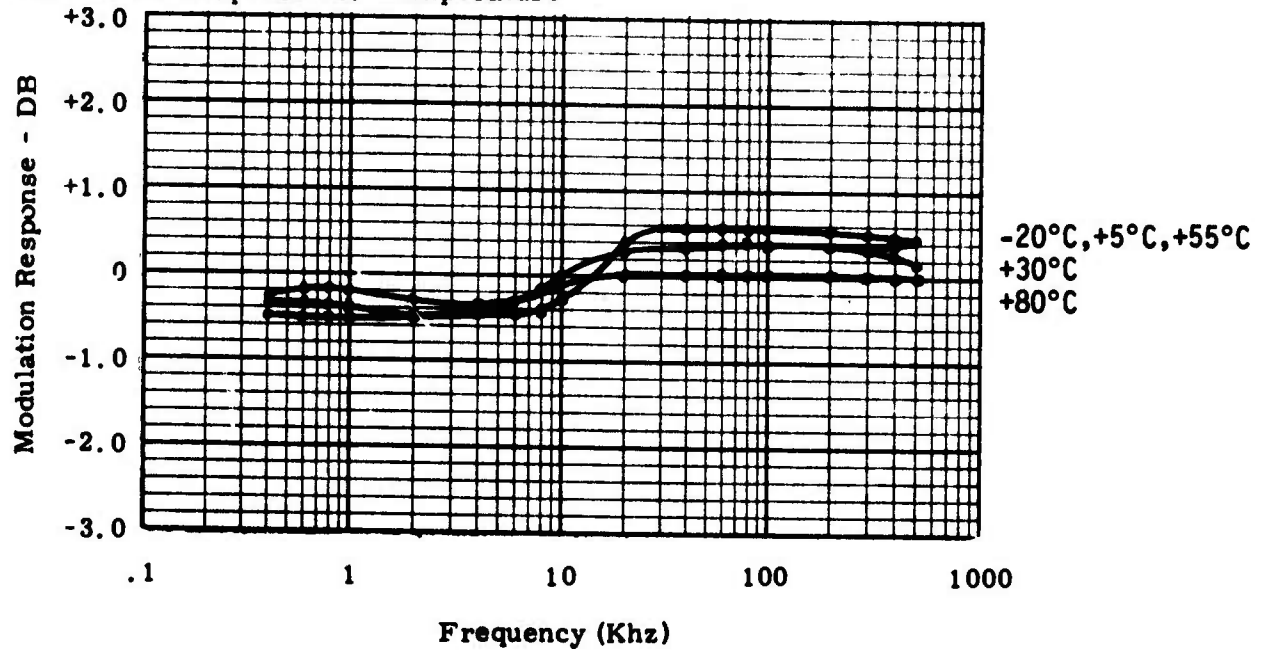

V. Linearity at Ambient

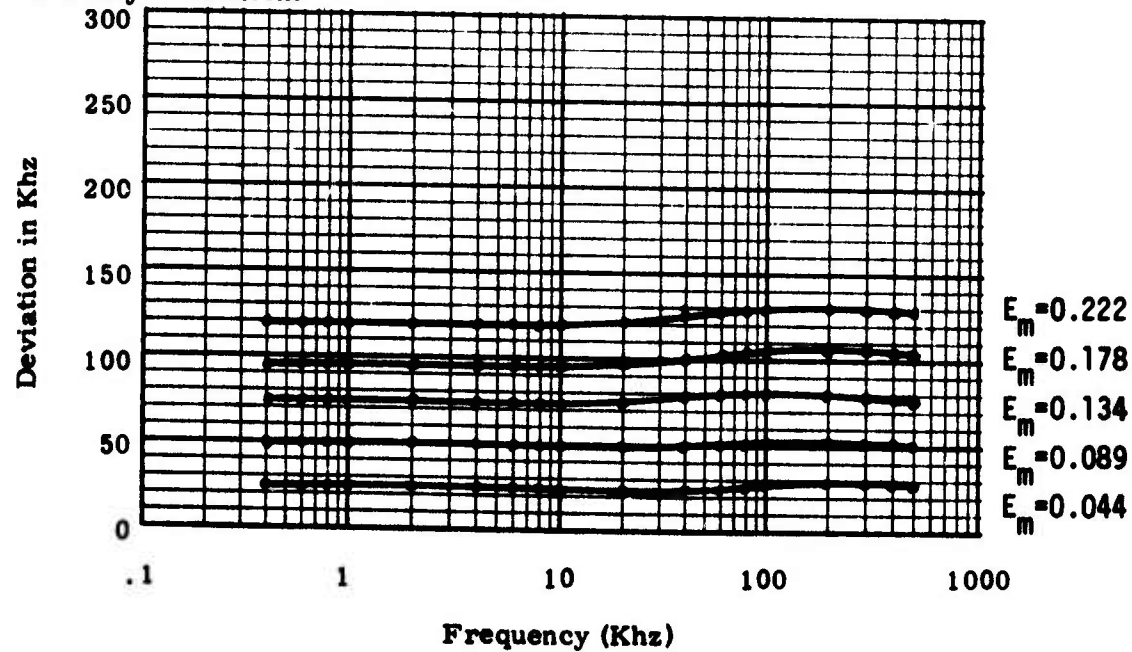

NORTHEASTERN UNIVERSITY

Evaluation Tests - RF Telemetry Transmitter - Sheet 3

Make: CONIC ; Type: CTS-402 ; Serial Number: 4021103 ;
 Carrier Frequency f_c : 2259.5 MHz; Date: 6/23/75 ; By: PJR ;

VI. Spurious Emission (Antenna Conducted)

Frequency Mhz	DB Down from f_c	Identification
1506	85 ± 3	2 f_c /3
2016	103 ± 3	$f_c - 18f_x$
2245	93 ± 3	$f_c - f_x$
2259.5	0	carrier frequency
2273	93 ± 3	$f_c + f_x$
3389	83 ± 3	3 f_c /2
4519	63 ± 3	2 f_c

NOTE: W. S. M. R. Regulation No. 105-2-60 requirement is $55 + 10 \log P_t$ DB Down from carrier.

VII. Miscellaneous

1. Maximum Distortion <2.0%
2. Incidental FM <500 Hz PEAK
3. Power Requirement 16.8 watts
4. Efficiency 12.4%
5. O.C. & S.C. Protection OK
6. Other Checks freq at 5:1 VSWR = 2259.4908
carrier shift = -0.000619% of f_c for 5:1 VSWR

NORTHEASTERN UNIVERSITY

Evaluation Tests - RF Telemetry Transmitter - Sheet 1

Make: CONIC ; Type: CTS-402 ; Serial Number: 4021104 ;

Carrier Frequency f_c : 2269.5 MHz; Date: 7/1/75 ; By: JFE ;

I. Time Drift

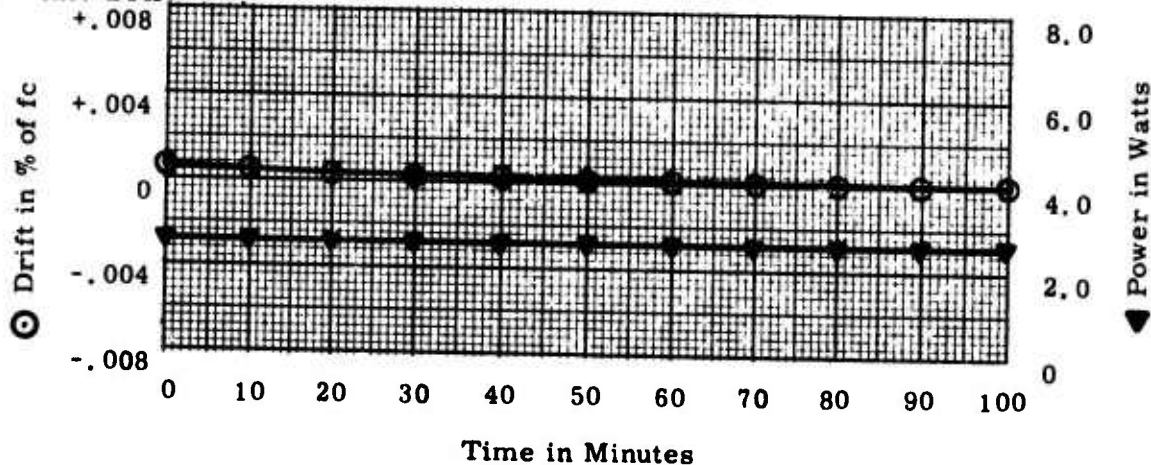

II. Temperature Stability

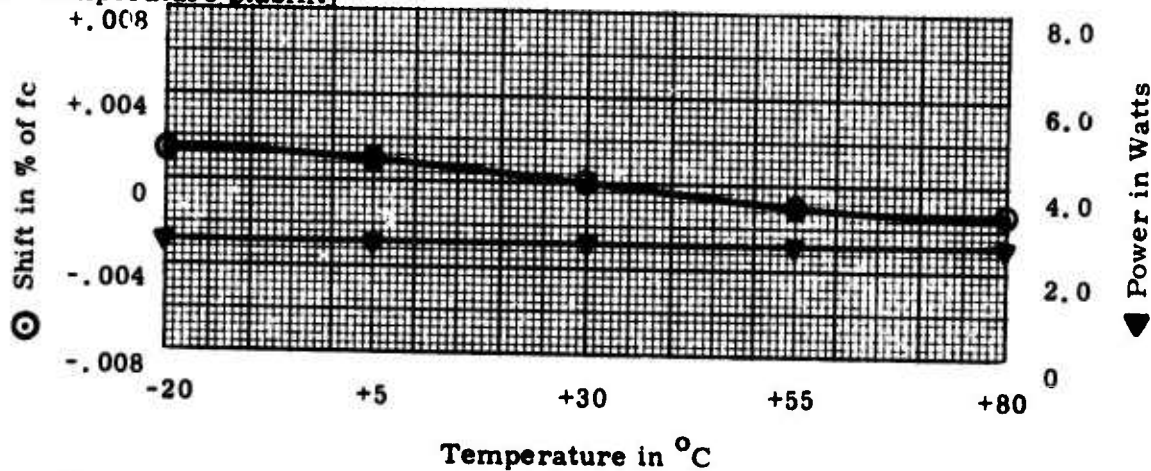

III. B⁺ Voltage Regulation

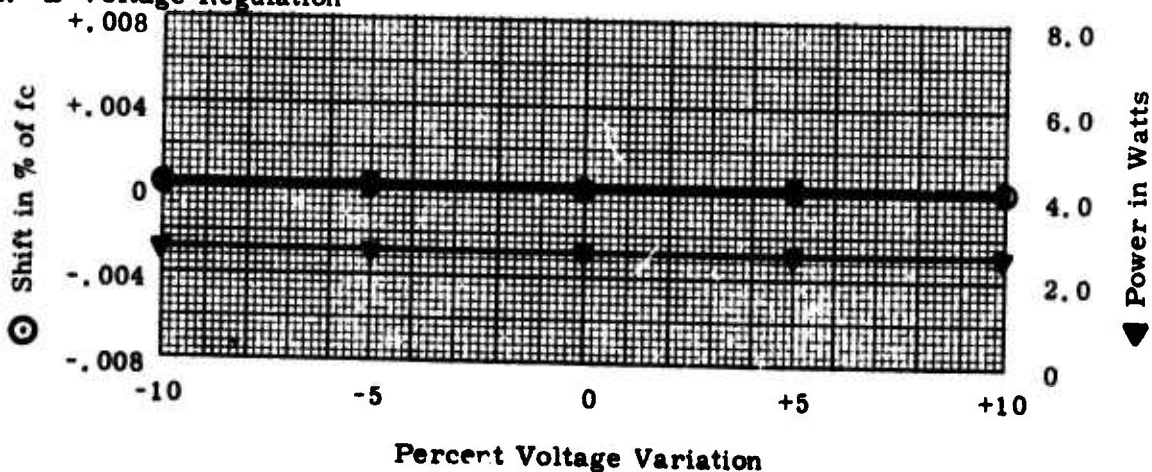

NORTHEASTERN UNIVERSITY

Evaluation Tests - RF Telemetry Transmitter - Sheet 2

Make: CONIC ; Type: CTS-402 ; Serial Number: 4021104 ;
Carrier Frequency f_c : 2269.5 MHz; Date: 7/1/75 ; By: JFE ;

IV. Modulation Response vs. Temperature

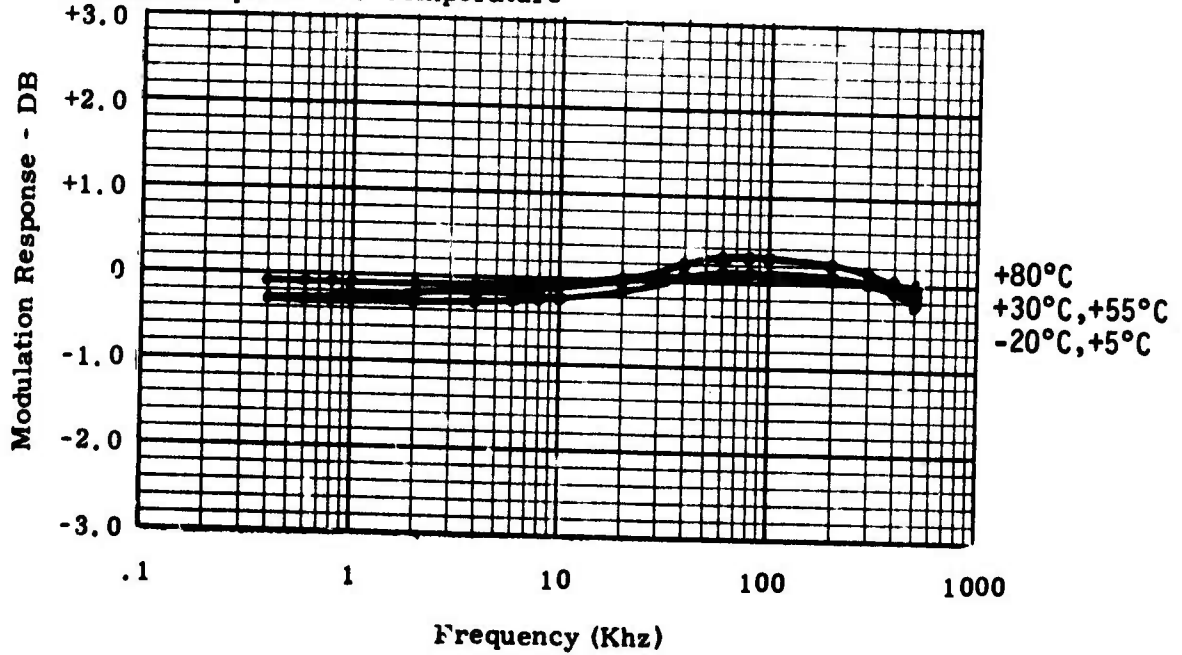

V. Linearity at Ambient

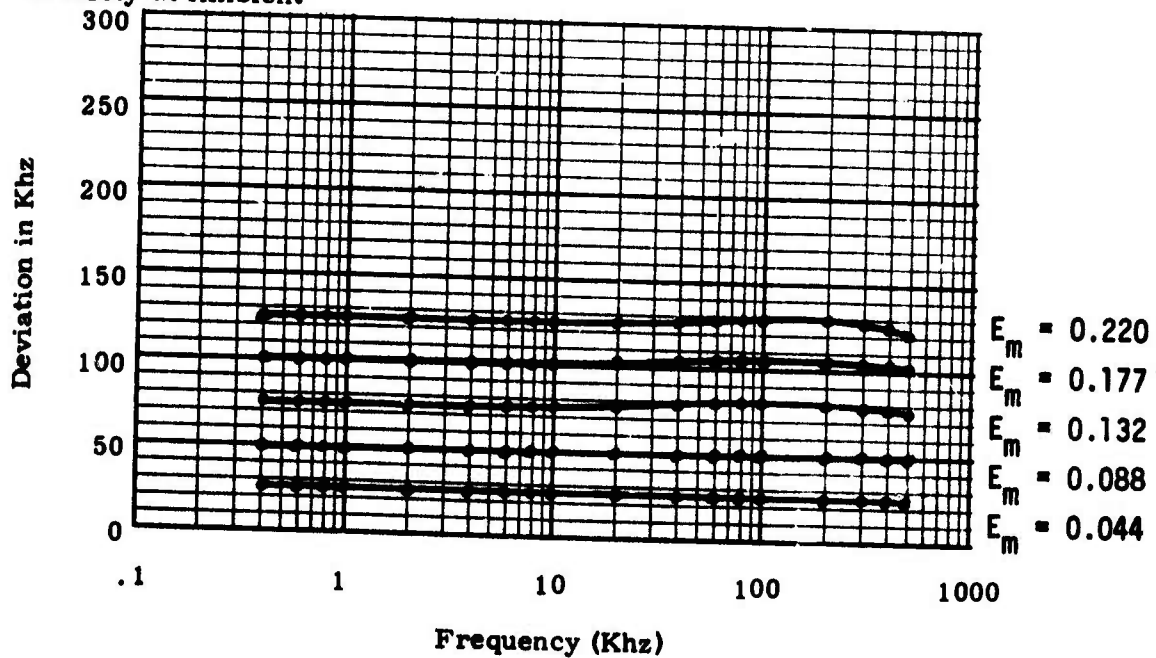

NORTHEASTERN UNIVERSITY

Evaluation Tests - RF Telemetry Transmitter - Sheet 3

Make: CONIC ; Type: CTS-402 ; Serial Number: 4021104 ;
 Carrier Frequency f_c : 2269.5 MHz; Date: 7/1/75 ; By: JFE ;

VI. Spurious Emission (Antenna Conducted)

Frequency Mhz	DB Down from f_c	Identification
1139.5	82 ± 3	$f_c/2$
2143.5	94 ± 3	$f_c - 9f_x$
2255.5	97 ± 3	$f_c - f_x$
2269.5	0	carrier frequency
2283.5	102 ± 3	$f_c + f_x$
2395.5	106 ± 3	$f_c + 9f_x$
3404	88 ± 3	$3f_c/2$
4539	59 ± 3	$2f_c$

NOTE: W.S.M.R. Regulation No. 105-2-60 requirement is $55+10 \log P_t$ DB Down from carrier.

VII. Miscellaneous

1. Maximum Distortion <2.0%
2. Incidental FM <500 Hz PEAK
3. Power Requirement 15.4 watts
4. Efficiency 16.8%
5. O.C. & S.C. Protection OK
6. Other Checks freq at 5:1 VSWR = 2269.5019
carrier shift = +0.0000837% of f_c for 5:1 VSWR

NORTHEASTERN UNIVERSITY

Evaluation Tests - RF Telemetry Transmitter - Sheet 1

Make: CONIC ; Type: CTS-402 ; Serial Number: 4021106 ;
 Carrier Frequency f_c : 2269.5 MHz; Date: 7/1/75 ; By: JFE ;

I. Time Drift

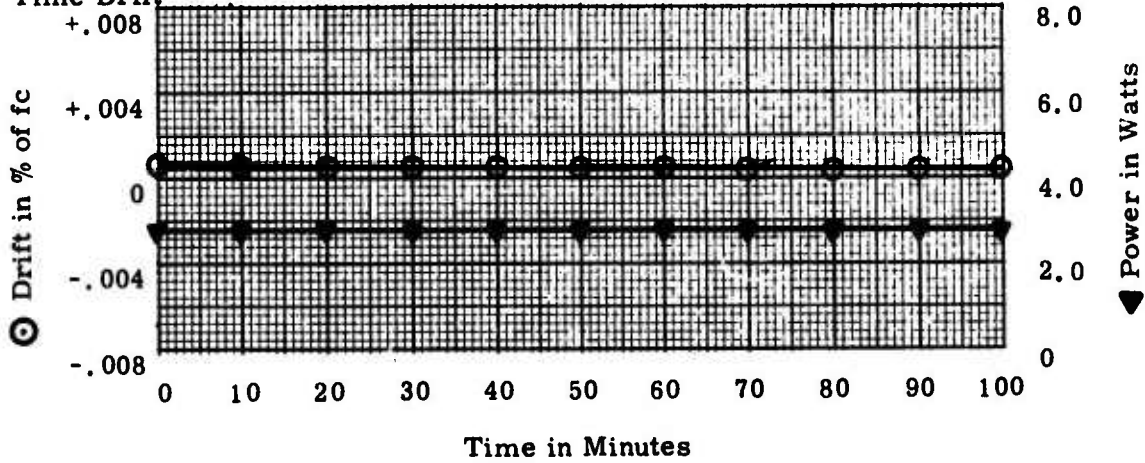

II. Temperature Stability

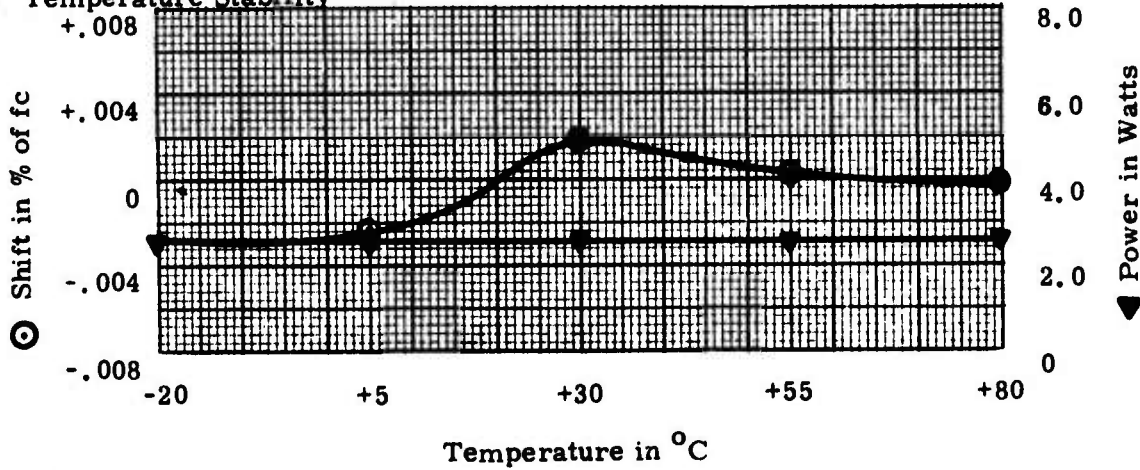

III. B⁺ Voltage Regulation

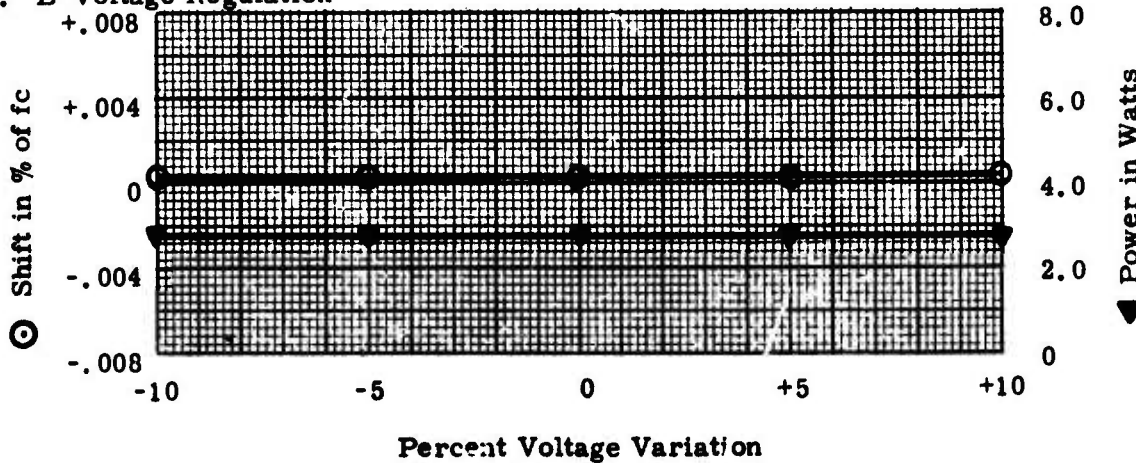

NORTHEASTERN UNIVERSITY

Evaluation Tests - RF Telemetry Transmitter - Sheet 2

Make: CONIC; Type: CTS-402; Serial Number: 4021106
Carrier Frequency f_c : 2269.5 MHz; Date: 7/1/75; By: JFE

IV. Modulation Response vs. Temperature

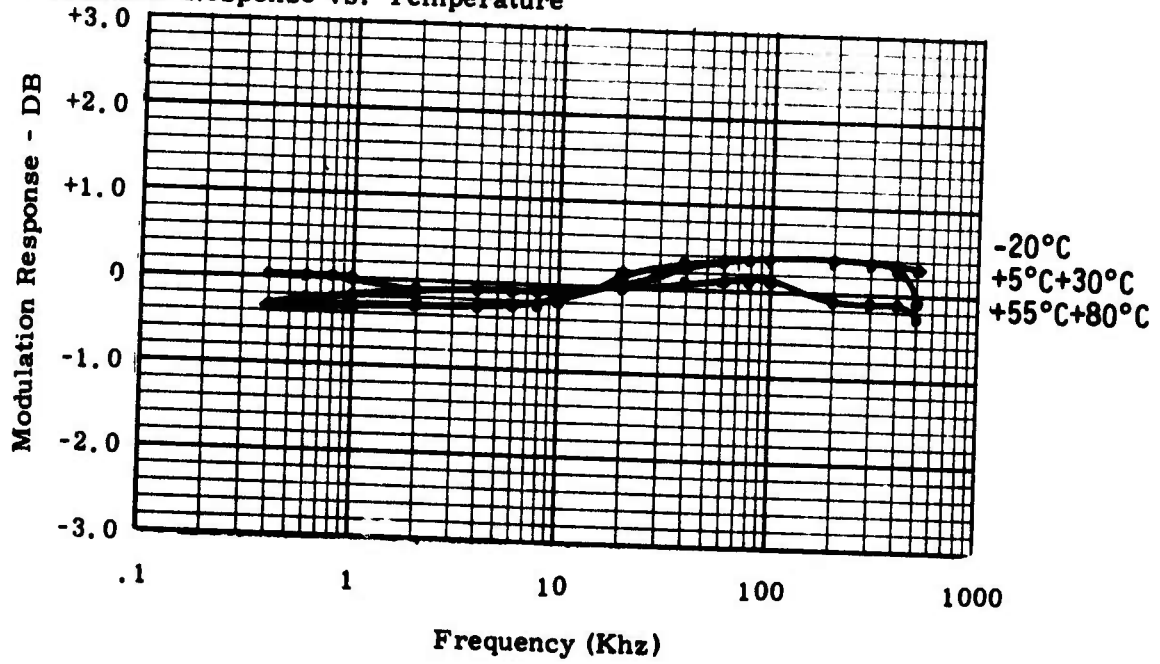

V. Linearity at Ambient

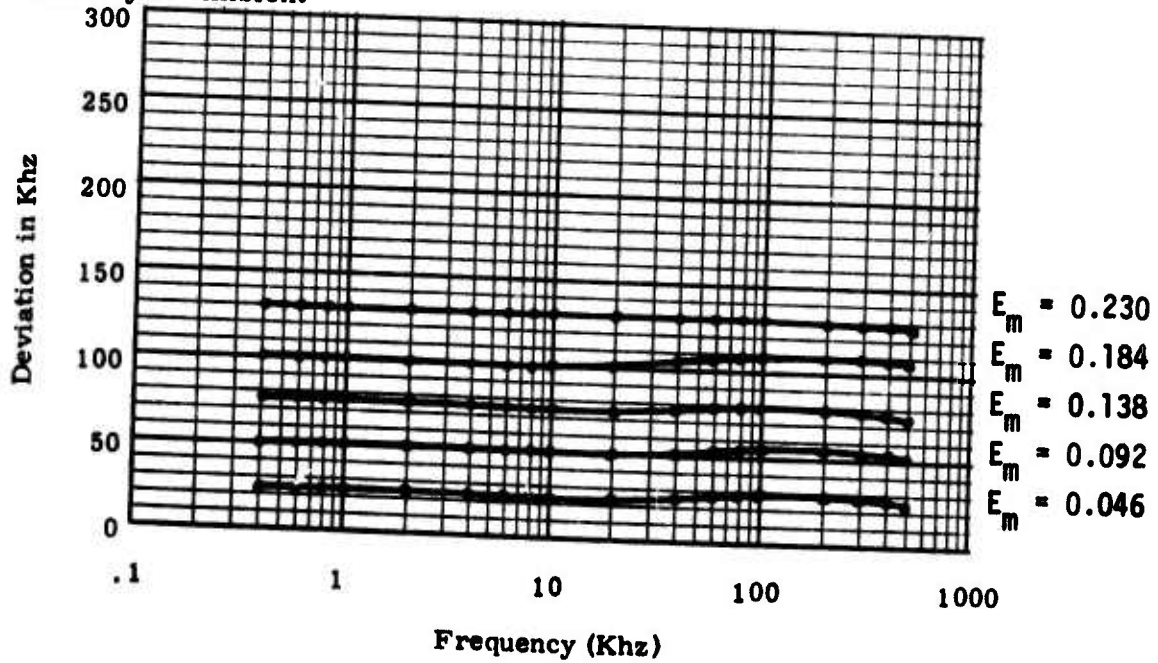

NORTHEASTERN UNIVERSITY

Evaluation Tests - RF Telemetry Transmitter - Sheet 3

Make: CONIC ; Type: CTS-402 ; Serial Number: 4021106
 Carrier Frequency fc: 2269.5 MHz; Date: 7/1/75 ; By: JFE

VI. Spurious Emission (Antenna Conducted)

Frequency Mhz	DB Down from fc	Identification
1135	82 ± 3	fc/2
1602.5	95 ± 3	fc - 58fx
2146	92 ± 3	fc - 11fx
2269.5	0	carrier frequency
2303	70 ± 3	fc + 3fx
2315	88 ± 3	fc + 4fx
2396	103 ± 3	fc + 11fx
3404	77 ± 3	3fc/2
4539	60 ± 3	2fc
4665.5	57 ± 3	2fc + 11fx

NOTE: W. S. M. R. Regulation No. 105-2-60 requirement is $55+10 \log P_t$ DB Down from carrier.

VII. Miscellaneous

1. Maximum Distortion <2.0%
2. Incidental FM <500 Hz PEAK
3. Power Requirement 19.6 watts
4. Efficiency 14.28 %
5. O.C. & S.C. Protection OK
6. Other Checks freq at 5:1 VSWR = 2269.5069
carrier shift = +0.000304% of fc for 5:1 VSWR

NORTHEASTERN UNIVERSITY

Evaluation Tests - RF Telemetry Transmitter - Sheet 1

Make: CONIC ; Type: CTS-402 ; Serial Number: 4021107 ;
 Carrier Frequency f_c : 2269.5 MHz; Date: 7/1/75 ; By: JFE/MSH

I. Time Drift

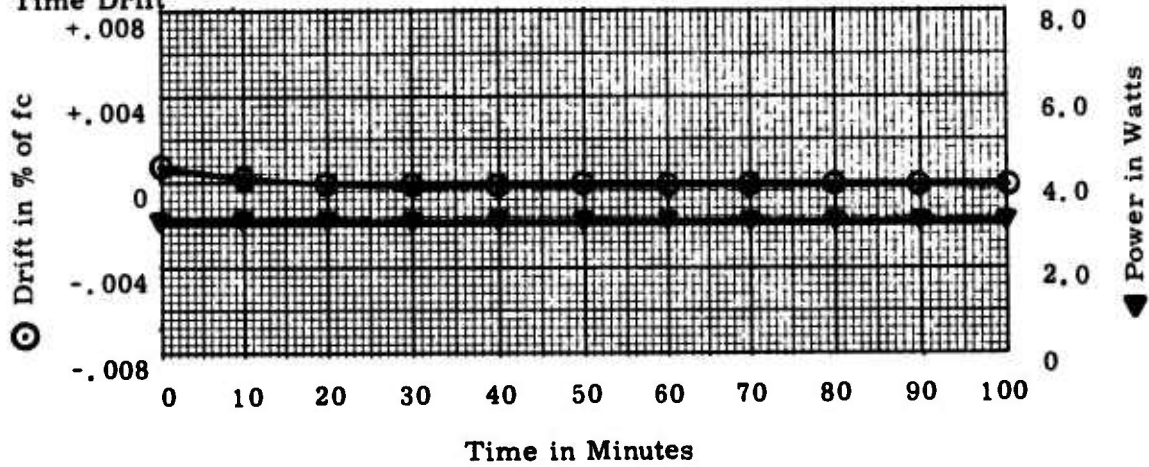

II. Temperature Stability

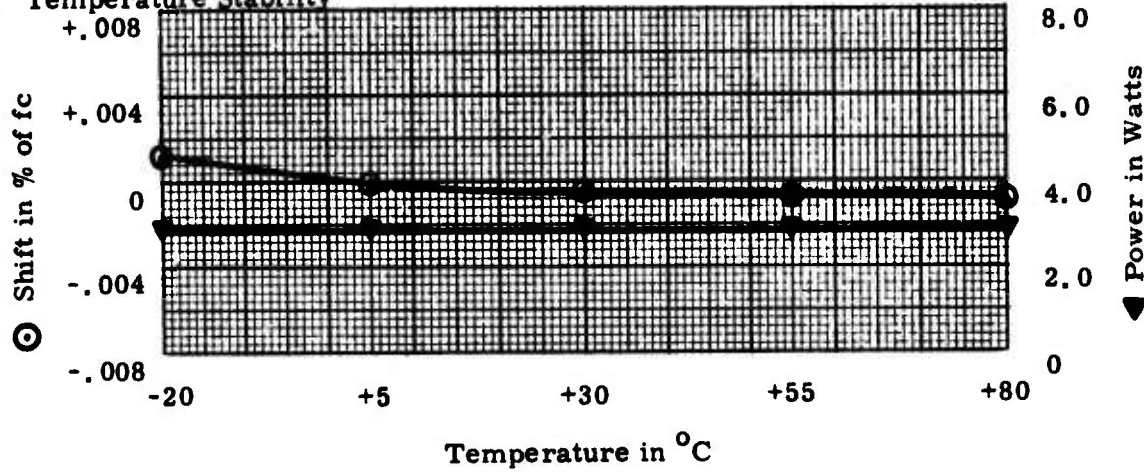

III. B⁺ Voltage Regulation

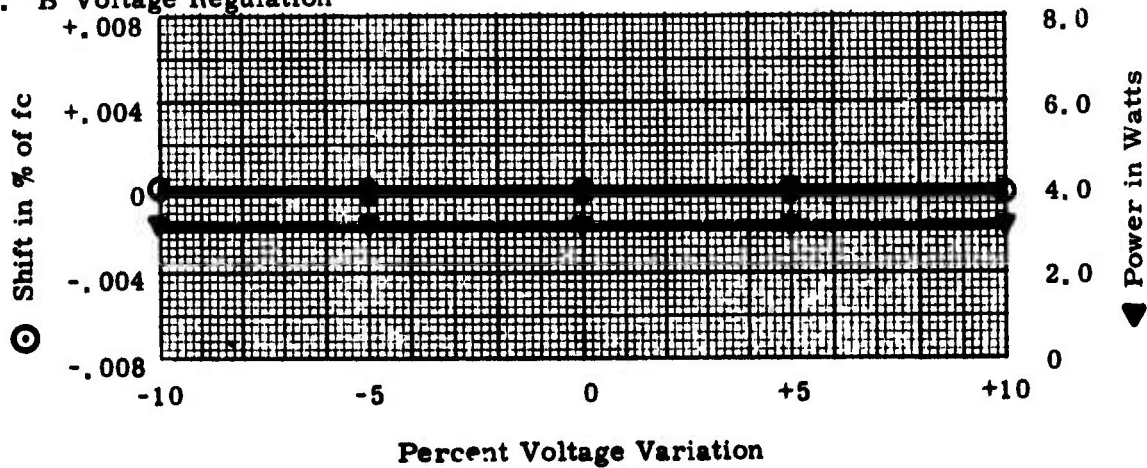

NORTHEASTERN UNIVERSITY

Evaluation Tests - RF Telemetry Transmitter - Sheet 2

Make: CONIC ; Type: CTS-402 ; Serial Number: 4021107 ;
Carrier Frequency f_c : 2269.5 MHz; Date: 7/1/75 ; By: JFE/MSH ;

IV. Modulation Response vs. Temperature

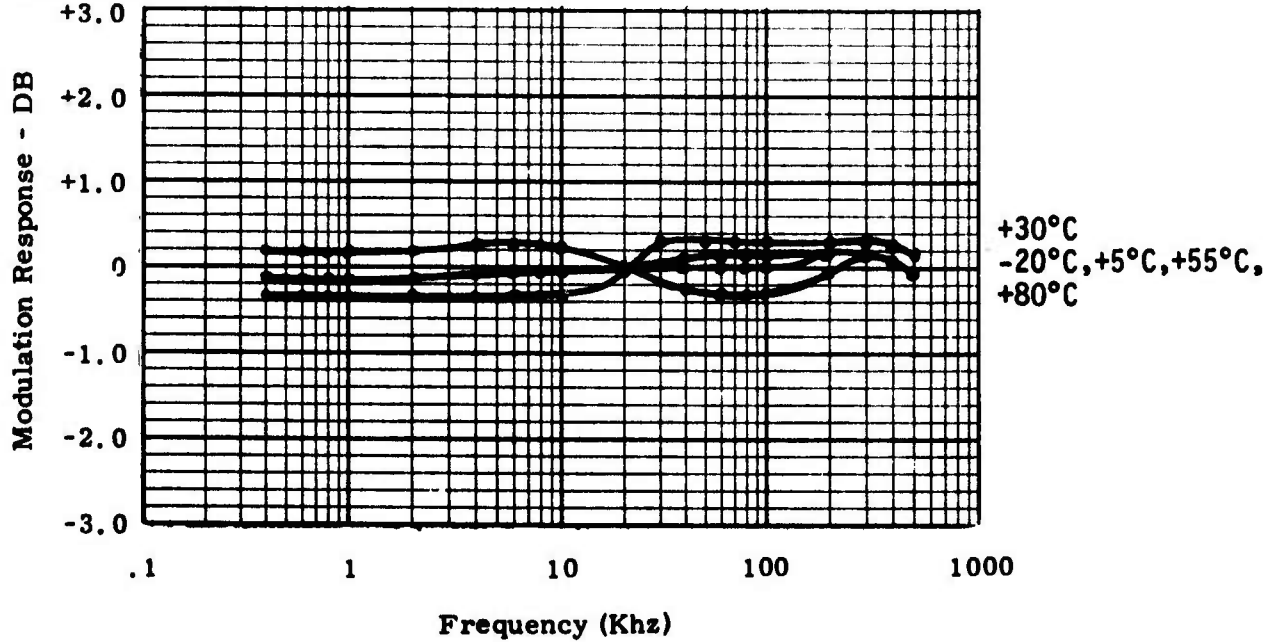

V. Linearity at Ambient

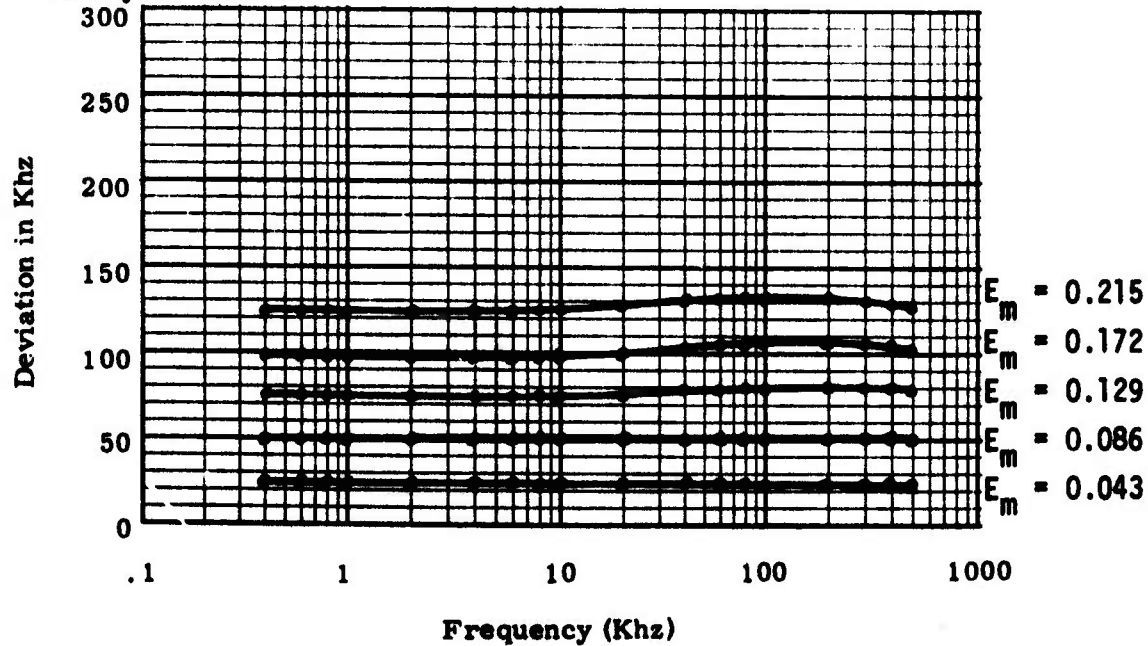

NORTHEASTERN UNIVERSITY

Evaluation Tests - RF Telemetry Transmitter - Sheet 3

Make: CONIC; Type: CTS-402; Serial Number: 4021107
 Carrier Frequency f_c : 2269.5 MHz; Date: 7/1/75; By: JFE/MSH

VI. Spurious Emission (Antenna Conducted)

Frequency Mhz	DB Down from f_c	Identification
1135	89 ± 3	$f_c/2$
2139	85 ± 3	$f_c - 9f_x$
2255	86 ± 3	$f_c - f_x$
2269.5	0	carrier frequency
2284	85 ± 3	$f_c + f_x$
2400	87 ± 3	$f_c + 9f_x$
3304	81 ± 3	$3f_c/2$
4539	62 ± 3	$2f_c$

NOTE: W.S.M.R. Regulation No. 105-2-60 requirement is $55+10 \log P_t$ DB Down from carrier.

VII. Miscellaneous

1. Maximum Distortion <2.0%
2. Incidental FM <500 Hz PEAK
3. Power Requirement 20.7 watts
4. Efficiency 13.9%
5. O.C. & S.C. Protection OK
6. Other Checks freq. at 5:1 VSWR 2269.4958
carrier shift = -0.000185% of f_c for 5:1 VSWR

Evaluation Test - Proprietary Information Sheet

RF Telemetry Transmitters

Make: Raytheon;

Type: T-201;

Manufacturer's Specifications

<u>Frequency:</u>	2.2 to 2.3 GHz
<u>Frequency Stability:</u>	±0.003%
<u>Output Power:</u>	2 watts minimum
<u>Output Impedance:</u>	50 ohms nominal.
<u>Load VSWR:</u>	Stable into any load. No damage by operating into an open or short circuit.
<u>Harmonic & Spurious Outputs:</u>	Meets IRIG 106-73.
<u>Incidental FM:</u>	Less than 500 Hz P/P quiescent; (DC to 1 MHz bandwidth). Less than 2 KHz P/P maximum; (DC to 1 MHz bandwidth).
<u>Incidental AM:</u>	1% maximum.
<u>Frequency Response:</u>	±1.0 db (DC to 1 MHz).
<u>Deviation Linearity:</u>	±1% best straight line.
<u>Harmonic Distortion:</u>	1% maximum (±500 KHz deviation).
<u>Deviation Sensitivity:</u>	Up to 2 MHz/volt.
<u>Input Impedance:</u>	100K ohms shunted by less than 10 pf.
<u>Voltage:</u>	+24 to +35 VDC.
<u>Current:</u>	Less than 0.55 amp.
<u>Reverse Voltage:</u>	No damage by -35 VDC.
<u>Temperature:</u>	-40°C to +85°C base plate temperature.
<u>Altitude:</u>	Unlimited.
<u>Shock:</u>	3 shocks of 100g for 11 msec along each of 3 mutually perpendicular axes.
<u>Acceleration:</u>	100g in any 3 mutually perpendicular planes.
<u>Vibration:</u>	Sine, 20 Hz to 2 KHz, 20g peak.

NORTHEASTERN UNIVERSITY

Evaluation Tests - RF Telemetry Transmitter - Sheet 1

Make: RAYTHEON ; Type: T-201 ; Serial Number: 020 ;

Carrier Frequency f_c : 2228.5 MHz; Date: 1/5/76 ; By: DAC & KYL ;

I. Time Drift

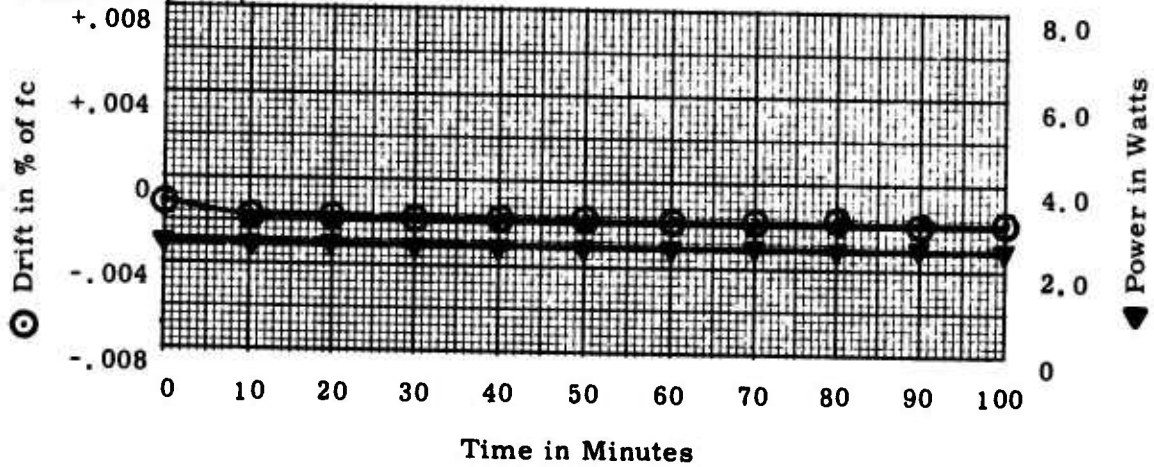

II. Temperature Stability

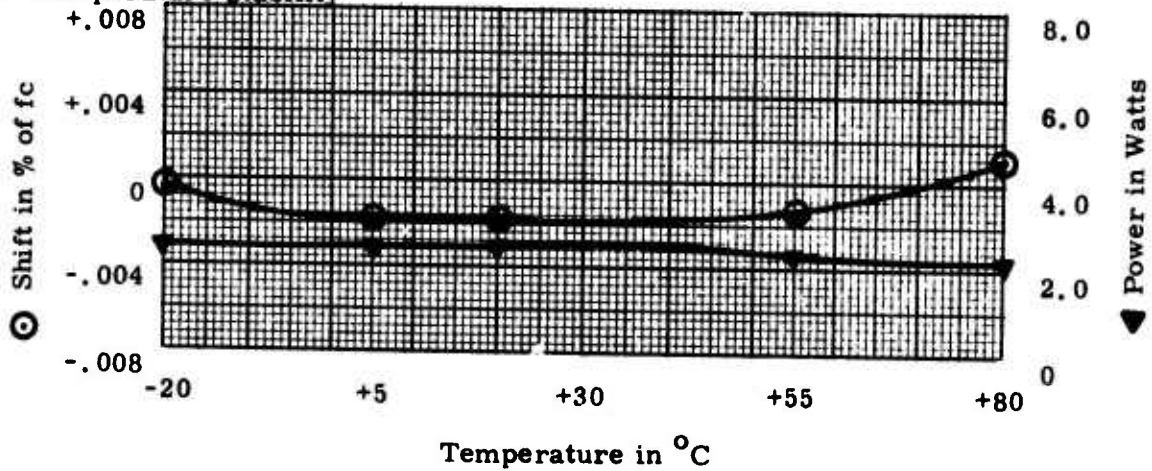

III. B⁺ Voltage Regulation

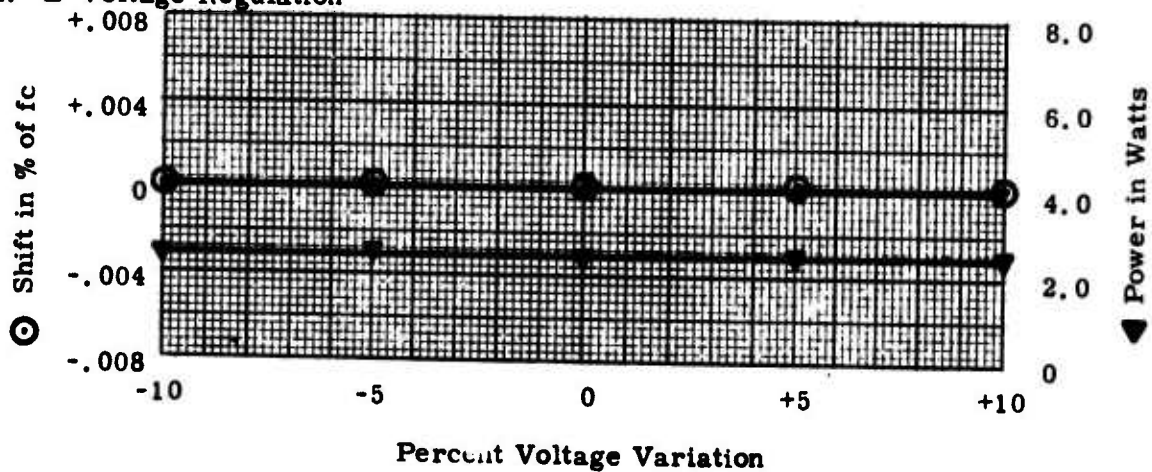

NORTHEASTERN UNIVERSITY

Evaluation Tests - RF Telemetry Transmitter - Sheet 2

Make: RAYTHEON ; Type: T-201 ; Serial Number: 020 ;

Carrier Frequency f_c : 2228.5 MHz; Date: 1/5/76 ; By: DAC & KYL ;

IV. Modulation Response vs. Temperature

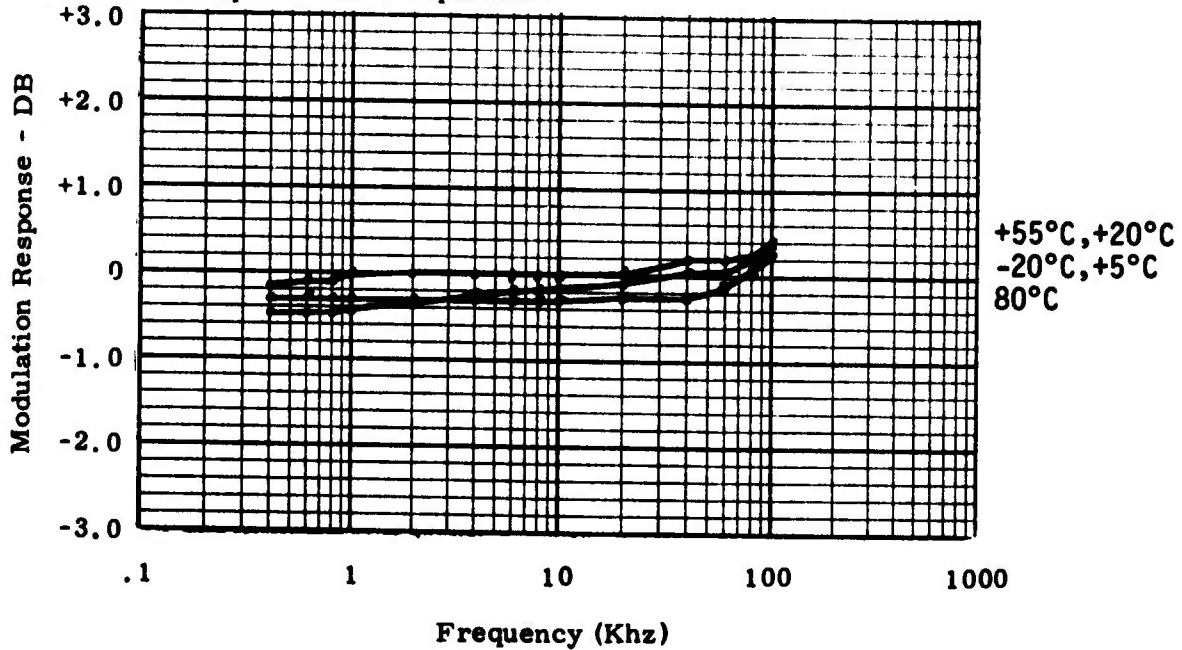

V. Linearity at Ambient

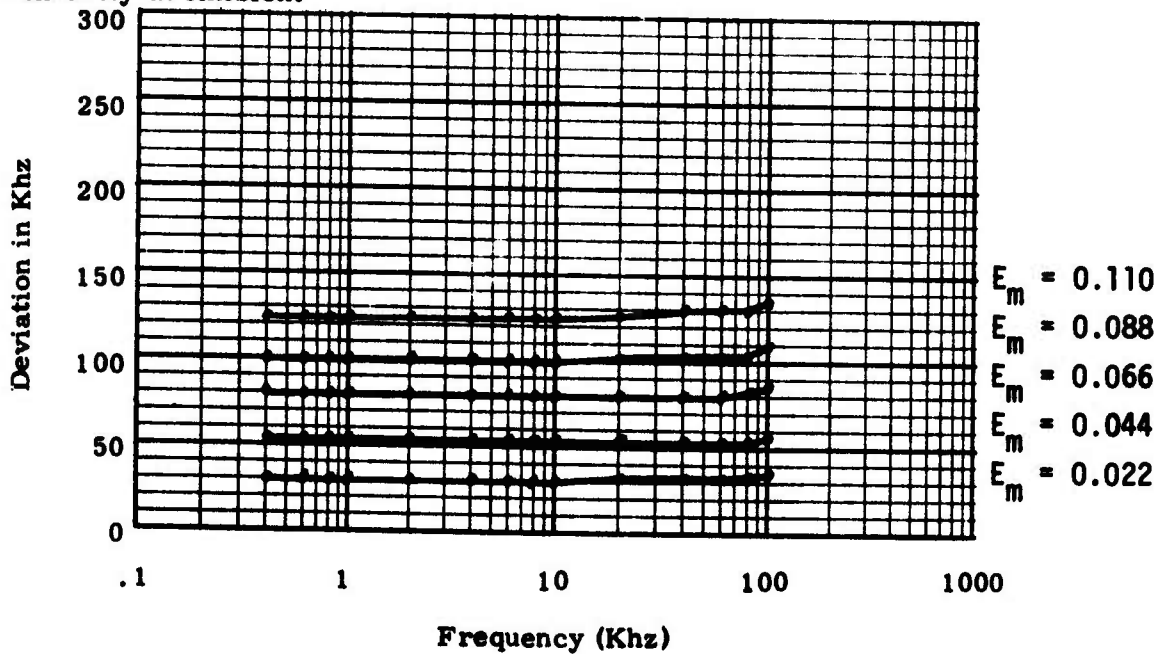

NORTHEASTERN UNIVERSITY

Evaluation Tests - RF Telemetry Transmitter - Sheet 3

Make: RAYTHEON ; Type: T-201 ; Serial Number: 020 ;
 Carrier Frequency fc: 2228.5 MHz; Date: 1/5/76 ; By: DAC & KYL ;

VI. Spurious Emission (Antenna Conducted)

Frequency Mhz	DB Down from fc	Identification
2193	104 ± 3	fc - 3.5fx
2200	62 ± 3	fc - 2.75fx
2208	91 ± 3	fc - 2fx
2218	69 ± 3	fc - fx
2228.5	0	carrier frequency
2239	71 ± 3	fc + fx
2249	92 ± 3	fc + 2fx
2257	64 ± 3	fc + 2.75fx
2264	104 ± 3	fc + 3.5fx
4420	54 ± 3	2fc
6662	51 ± 3	3fc

NOTE: W. S. M. R. Regulation No. 105-2-60 requirement is $55+10\log P_t$ DB Down from carrier.

VII. Miscellaneous

1. Maximum Distortion 0.59%
2. Incidental FM <500 Hz PEAK
3. Power Requirement 14.0 watts
4. Efficiency 18.0%
5. O.C. & S.C. Protection OK
6. Other Checks freq at 5:1 VSWR
no carrier shift for 5:1 VSWR

NORTHEASTERN UNIVERSITY

Evaluation Tests - RF Telemetry Transmitter - Sheet 1

Make: RAYTHEON ; Type: T-201 ; Serial Number: 022 ;

Carrier Frequency f_c : 2219.5 MHz; Date: 1/29/76 ; By: KYL ;

I. Time Drift

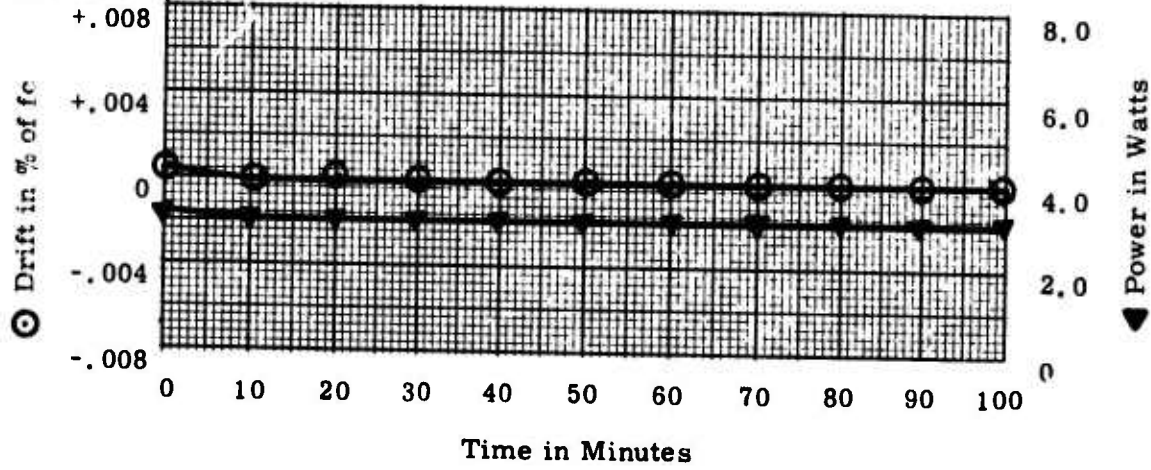

II. Temperature Stability

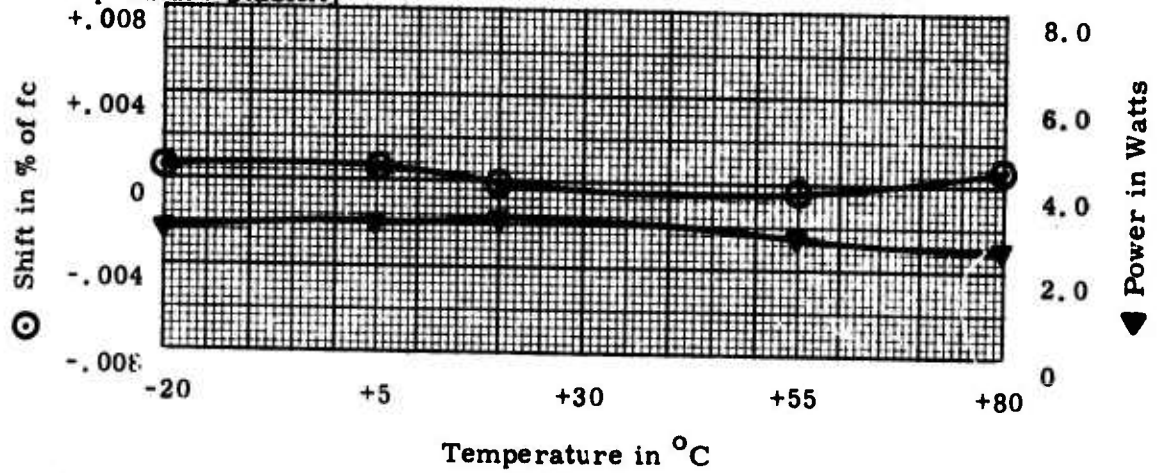

III. B⁺ Voltage Regulation

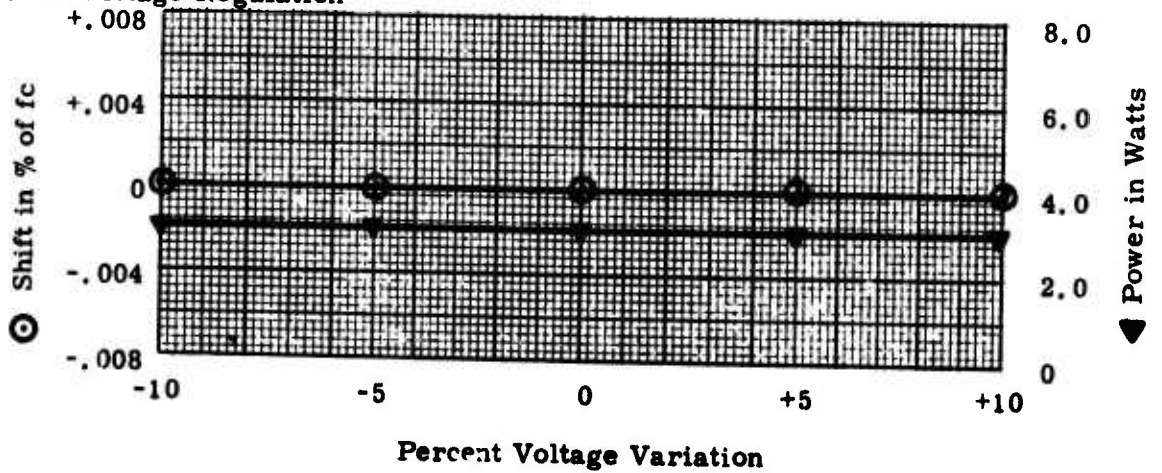

NORTHEASTERN UNIVERSITY

Evaluation Tests - RF Telemetry Transmitter - Sheet 2

Make: RAYTHEON ; Type: T-201 ; Serial Number: 022 ;
Carrier Frequency f_c : 2219.5 MHz ; Date: 1/29/76 ; By: KYL ;

IV. Modulation Response vs. Temperature

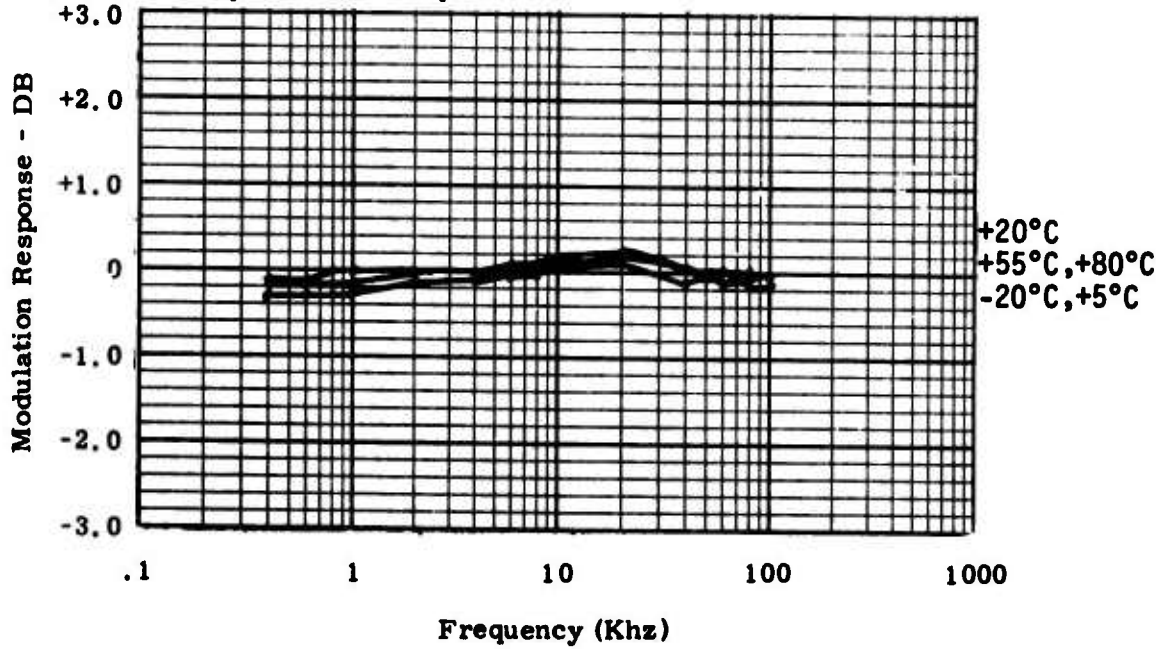

V. Linearity at Ambient

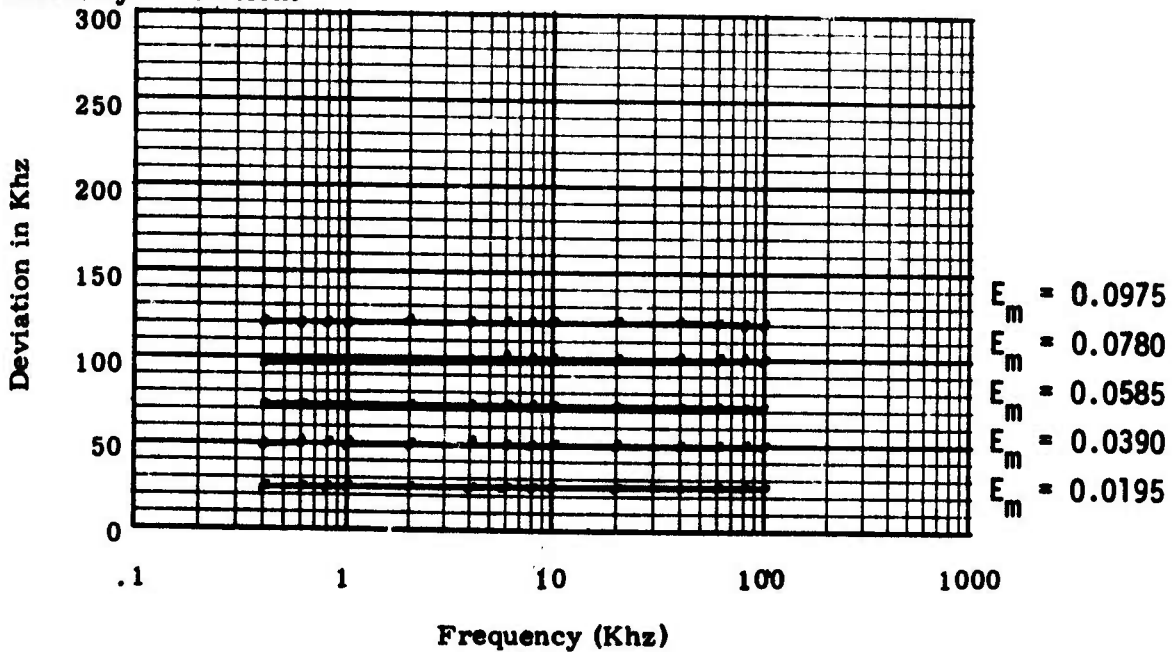

NORTHEASTERN UNIVERSITY

Evaluation Tests - RF Telemetry Transmitter - Sheet 3

Make: RAYTHEON ; Type: T-201 ; Serial Number: 022 ;
 Carrier Frequency fc: 2219.5 MHz; Date: 1/29/76 ; By: KYL ;

VI. Spurious Emission (Antenna Conducted)

Frequency Mhz	DB Down from fc	Identification
2129.5	83 ± 3	fc - 10fx
2165.5	85 ± 3	fc - 6fx
2192.5	72 ± 3	fc - 3fx
2210.5	83 ± 3	fc - fx
2219.5	0	carrier frequency
2228.5	83 ± 3	fc + fx
2246.5	72 ± 3	fc + 3fx
2255.5	86 ± 3	fc + 4fx
2273.5	84 ± 3	fc + 6fx
2309.5	82 ± 3	fc + 10fx

NOTE: W. S. M. R. Regulation No. 105-2-60 requirement is $55+10 \log P_t$ DB Down from carrier.

VII. Miscellaneous

1. Maximum Distortion 0.53%
2. Incidental FM <500 Hz PEAK
3. Power Requirement 14.0 watts
4. Efficiency 22.0%
5. O.C. & S.C. Protection OK
6. Other Checks 5:1 VSWR Test
no carrier shift with 5:1 VSWR.

Evaluation Tests - Proprietary Information Sheet

RF Telemetry Transmitters

Make: Vector;

Type: T105S;

Manufacturer's Specifications

<u>RF Power Output</u>	5 watts minimum into 50 ohm load with VSWR up to 1.5:1
<u>RF Load</u>	Stable operation into any load impedance. Output circulator allows continuous operation into open or short circuit.
<u>Output Frequency</u>	Crystal controlled center frequency for S-band (between 2200-2300 MHz)
<u>Output Frequency Stability</u>	$\pm 0.003\%$ of specified, including setting tolerance and drift due to environment
<u>Harmonic and Spurious Outputs</u>	In accordance with IRIG 106-69
<u>Modulation Type</u>	FM (PM available)
<u>Input Impedance</u>	50 ohms to 100 kilohm
<u>Deviation Sensitivity</u>	T-105S, up to ± 750 kHz/volt rms.
<u>Frequency Response</u>	DC to 1 MHz ± 1.0 dB.
<u>Deviation Capability</u>	T-105S, ± 900 kHz maximum
<u>Linearity</u>	1.0% maximum, best straight line for; T-105S, ± 750 kHz deviation
<u>Total Harmonic Distortion</u>	1.0% maximum for; T-105S, ± 500 kHz deviation
<u>Input Voltage</u>	28 \pm 4 volts. Reverse polarity protection provided.
<u>Input Current</u>	2.0 A maximum
<u>Weight</u>	16 oz. maximum
<u>Vibration</u>	Sinusoidal at 20 g from 20 to 200 cps in each axis
<u>Shock</u>	1/2 sine at 50g for 11 milliseconds in each axis
<u>Altitude</u>	Unlimited.

NORTHEASTERN UNIVERSITY

Evaluation Tests - RF Telemetry Transmitter - Sheet 1

Make: Vector ; Type: T 105 S ; Serial Number: 550 ;

Carrier Frequency f_c : 2259.5 MHz ; Date: Jan. 23, 1976 ; By: KYL ;

I. Time Drift

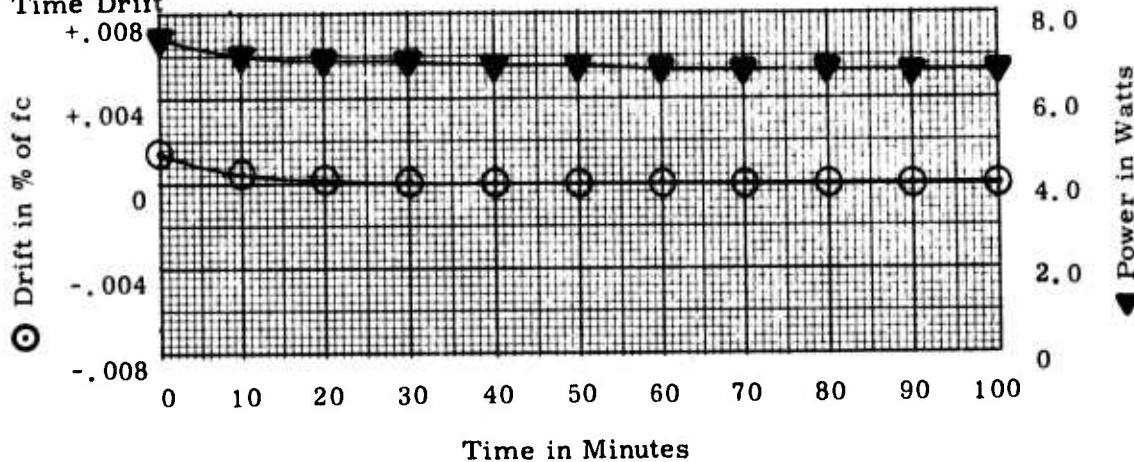

II. Temperature Stability

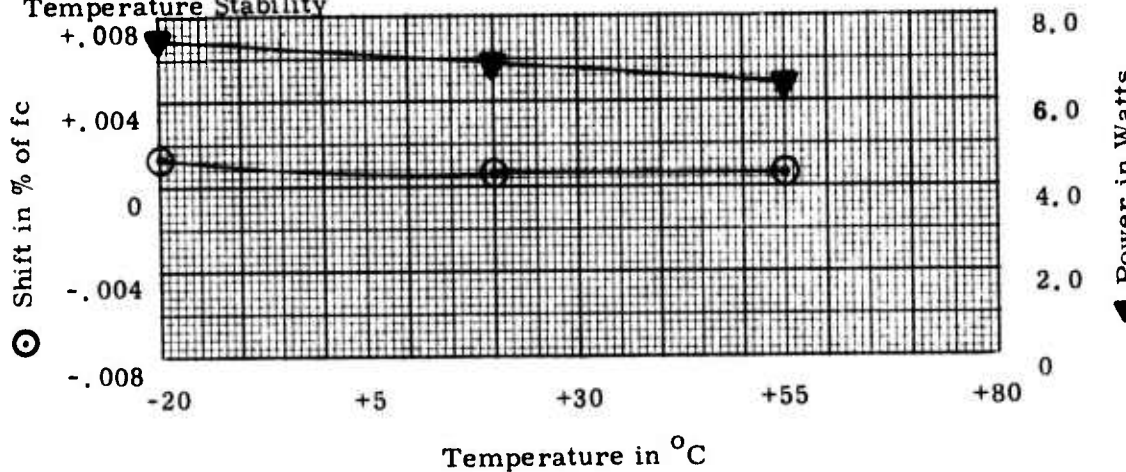

III. B^+ Voltage Regulation

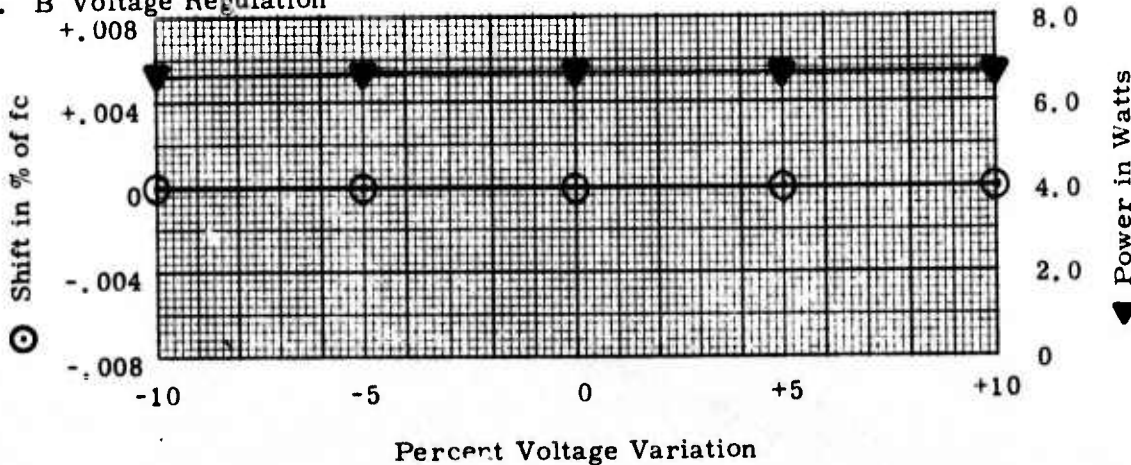

NORTHEASTERN UNIVERSITY

Evaluation Tests - RF Telemetry Transmitter - Sheet 2

Make: Vector ; Type: T 105 S ; Serial Number: 550 ;
Carrier Frequency f_c : 2259.5 MHz; Date: Jan. 23, 1976 By: KYL

IV. Modulation Response vs. Temperature

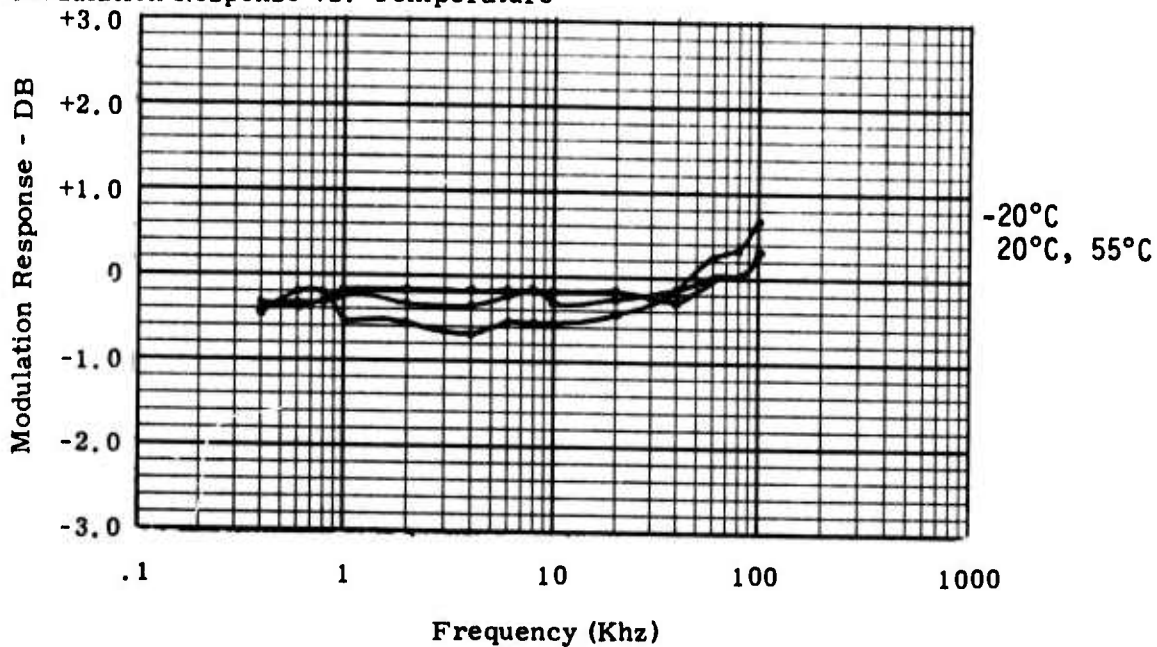

V. Linearity at Ambient

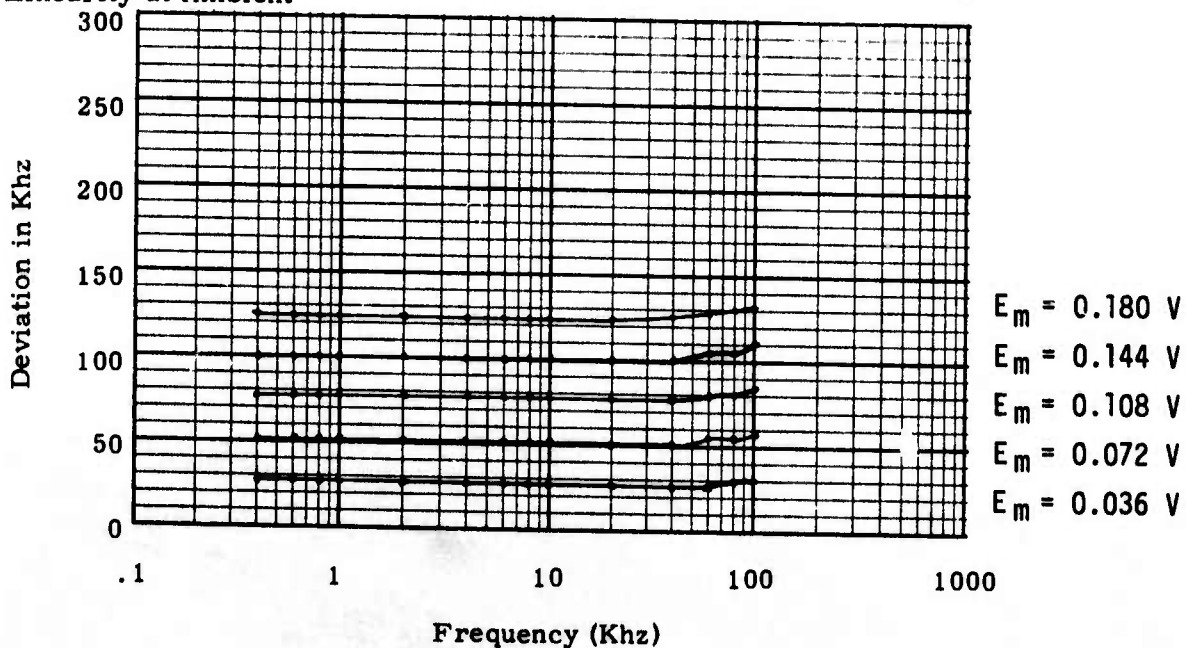

NORTHEASTERN UNIVERSITY

Evaluation Tests - RF Telemetry Transmitter - Sheet 3

Make: VECTOR ; Type: T 105 S ; Serial Number: 550 ;
 Carrier Frequency f_c : 2259.5 MHz; Date: 1/23/76 ; By: KYL ;

VI. Spurious Emission (Antenna Conducted)

Frequency Mhz	DB Down from f_c	Identification
2075	94 ± 3	$f_c - 9f_x$
2239	72 ± 3	$f_c - f_x$
2259.5	0	carrier frequency
2280	72 ± 3	$f_c + f_x$
2444	97 ± 3	$f_c + 9f_x$

NOTE: W. S. M. R. Regulation No. 105-2-60 requirement is $55 + 10 \log P_t$ DB Down from carrier.

VII. Miscellaneous

1. Maximum Distortion 0.90%
2. Incidental FM <500 Hz PEAK
3. Power Requirement 47.6 watts
4. Efficiency 14.0%
5. O.C. & S.C. Protection OK
6. Other Checks 5:1 VSWR Test
no carrier shift for 5:1 VSWR

Evaluation Tests - Proprietary Information Sheet

RF Telemetry Transmitters

Make: Vector

Type: T-202S;

Manufacturer's Specifications

<u>RF Power Output:</u>	2 watts minimum into 50 ohm load with VSWR up to 1.5:1.
<u>RF Load:</u>	Stable operation into any load impedance. Output circulator allows continuous operation into open or short circuit.
<u>Output Frequency:</u>	Crystal controlled center frequency for S-band (between 2200-2300 MHz).
<u>Output Frequency Stability:</u>	±0.003% of specified, including setting tolerance and drift due to environment.
<u>Harmonic and Spurious Outputs:</u>	In accordance with IRIG 106-71.
<u>Modulation Type:</u>	FM (PM available).
<u>Input Impedance:</u>	50 ohms to 100 kilohm.
<u>Deviation Sensitivity:</u>	Up to ±750 kHz/volt rms.
<u>Frequency Response:</u>	DC to 1 MHz ±1.5dB.
<u>Deviation Capability:</u>	±1000 kHz maximum.
<u>Linearity:</u>	1.0% maximum, best straight line.
<u>Total Harmonic Distortion:</u>	1.0% maximum for; ±500 KHz deviation.
<u>Input Voltage:</u>	28±4 volts, with reverse polarity protection.
<u>Input Current:</u>	1.0 amp maximum.
<u>Baseplate Temperature:</u>	-25°C to +85°C.
<u>Vibration:</u>	Sinusoidal at 20g from 20 to 2000 cps in each axis.
<u>Acceleration:</u>	100g, each axis.
<u>Altitude:</u>	Unlimited.

NORTHEASTERN UNIVERSITY

Evaluation Tests - RF Telemetry Transmitter - Sheet 1

Make: Vector ; Type: T202S ; Serial Number: 201 ;

Carrier Frequency f_c : 2220.5 MHz ; Date: 6/13/75 ; By: PJR ;

I. Time Drift

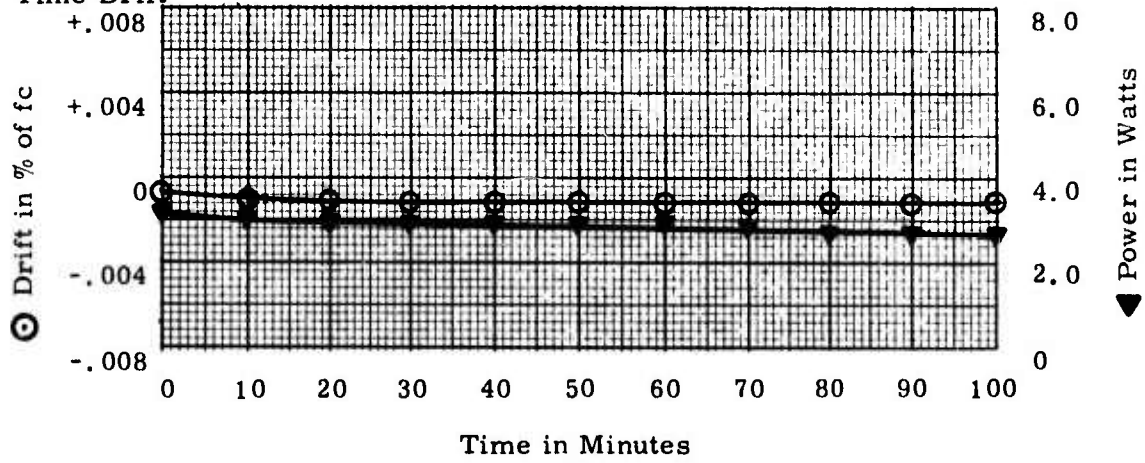

II. Temperature Stability

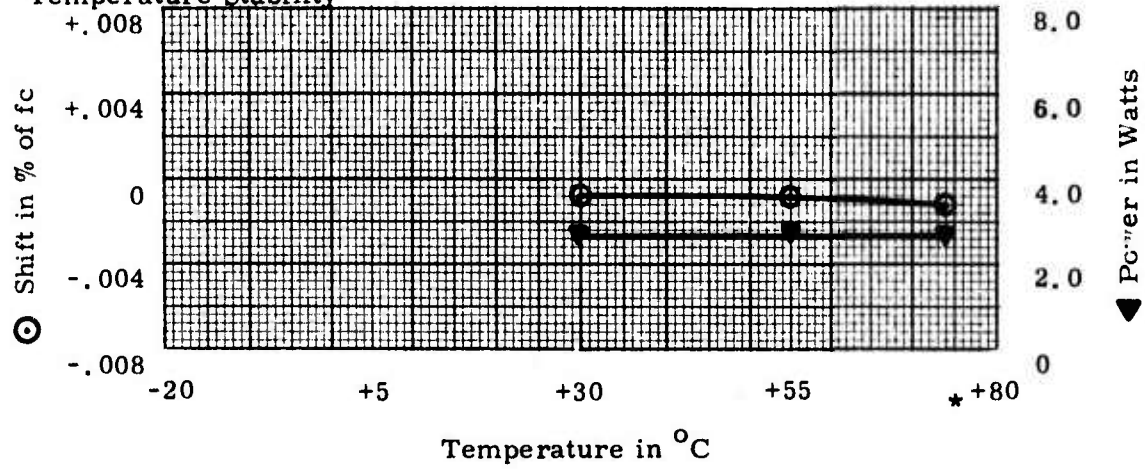

III. B⁺ Voltage Regulation

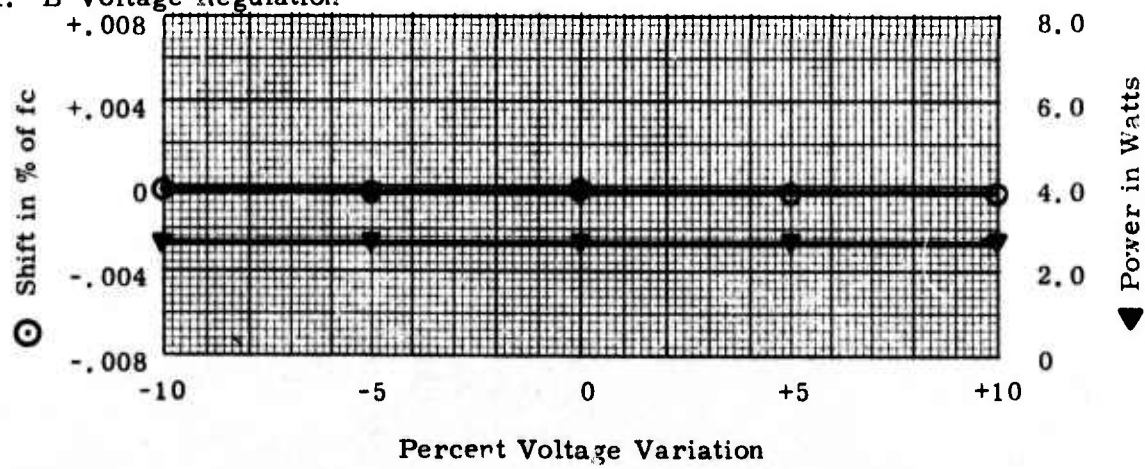

NORTHEASTERN UNIVERSITY

Evaluation Tests - RF Telemetry Transmitter - Sheet 2

Make: Vector ; Type: T202S ; Serial Number: 201 ;
 Carrier Frequency f_c : 2220.5 MHz; Date: 5/13/75 ; By: PJR ;

IV. Modulation Response vs. Temperature

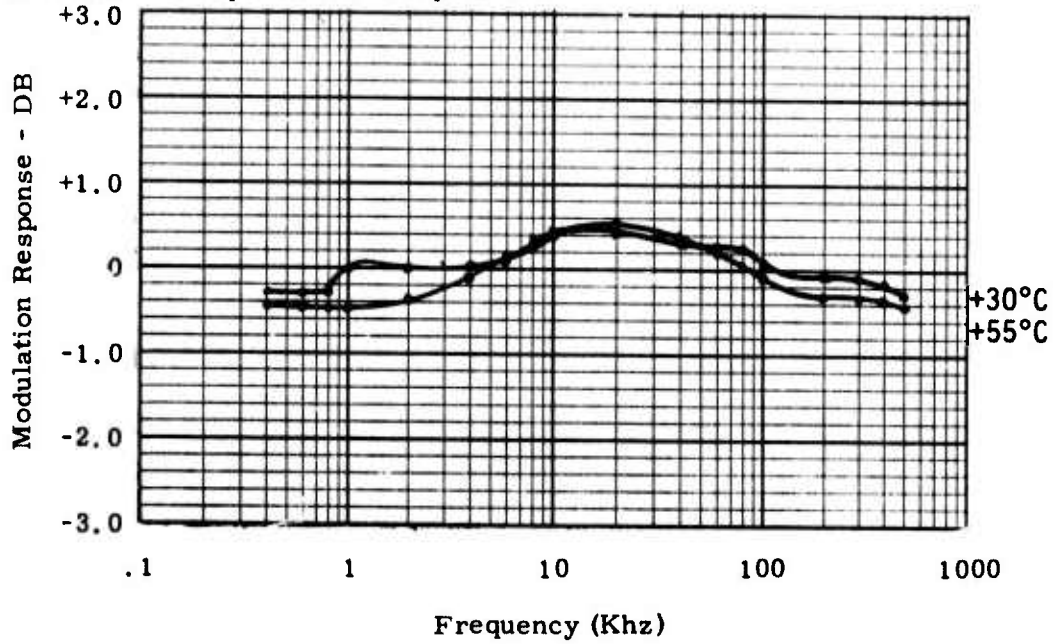

V. Linearity at Ambient

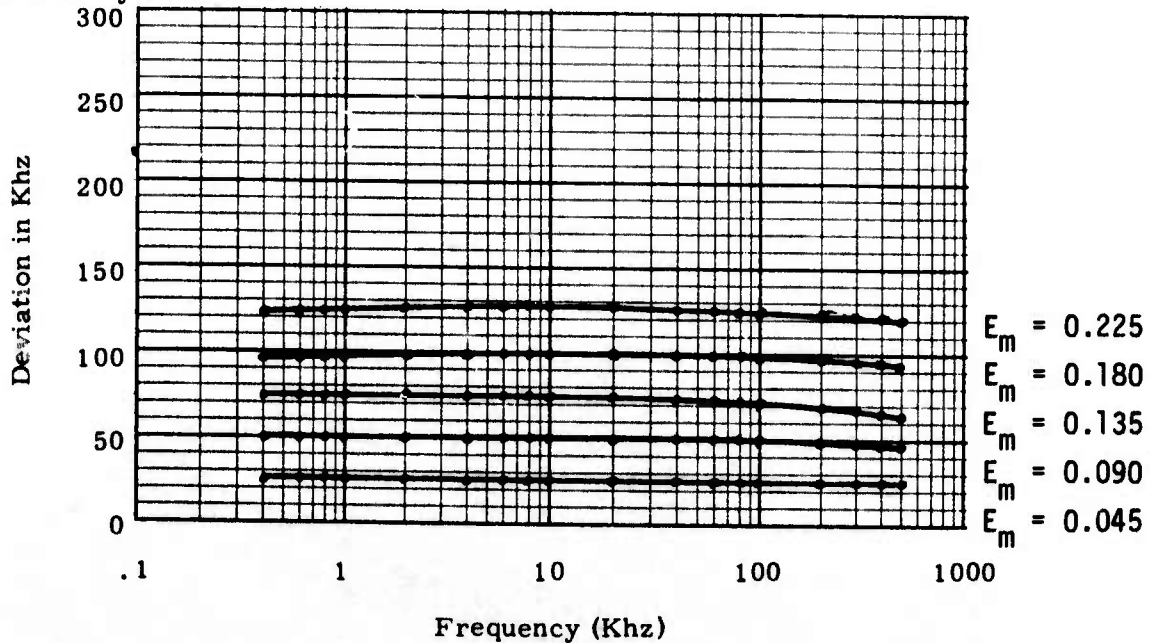

NORTHEASTERN UNIVERSITY

Evaluation Tests - RF Telemetry Transmitter - Sheet 3

Make: VECTOR ; Type: T 202 S ; Serial Number: 201 ;
 Carrier Frequency f_c : 2220.5 MHz; Date: 5/13/75 ; By: PJR ;

VI. Spurious Emission (Antenna Conducted)

Frequency Mhz	DB Down from f_c	Identification
Spurious Emissions not tested due to loss of power.		

NOTE: W.S.M.R. Regulation No. 105-2-60 requirement is $55+10 \log P_t$ DB Down from carrier.

VII. Miscellaneous

1. Maximum Distortion <2.0%
2. Incidental FM <500 Hz PEAK
3. Power Requirement 25.2 watts
4. Efficiency 10.7%
5. O.C. & S.C. Protection OK
6. Other Checks freq at 5:1 VSWR = 2220.4816
carrier shift = -0.0000045% of f_c for 5:1 VSWR

* complete loss of power at 74°C

NORTHEASTERN UNIVERSITY

Evaluation Tests - RF Telemetry Transmitter - Sheet 1

Make: Vector ; Type: T202S ; Serial Number: 202

Carrier Frequency f_c : 2220.5 MHz; Date: 6/23/75 ; By: PJR

I. Time Drift

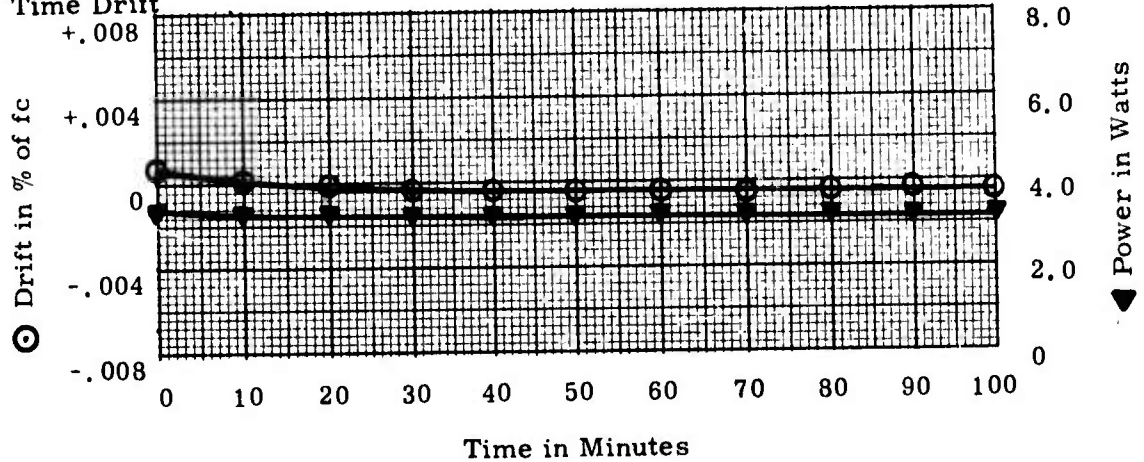

II. Temperature Stability

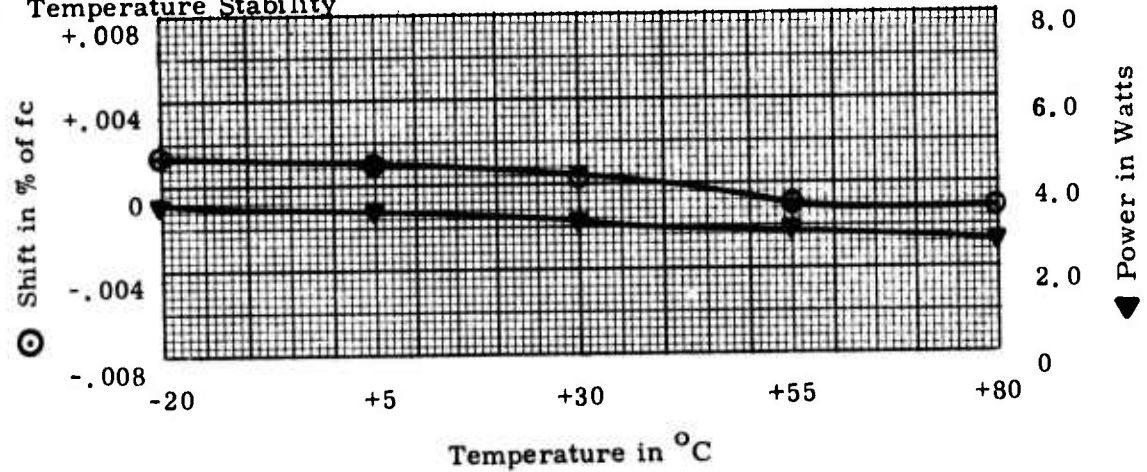

III. B⁺ Voltage Regulation

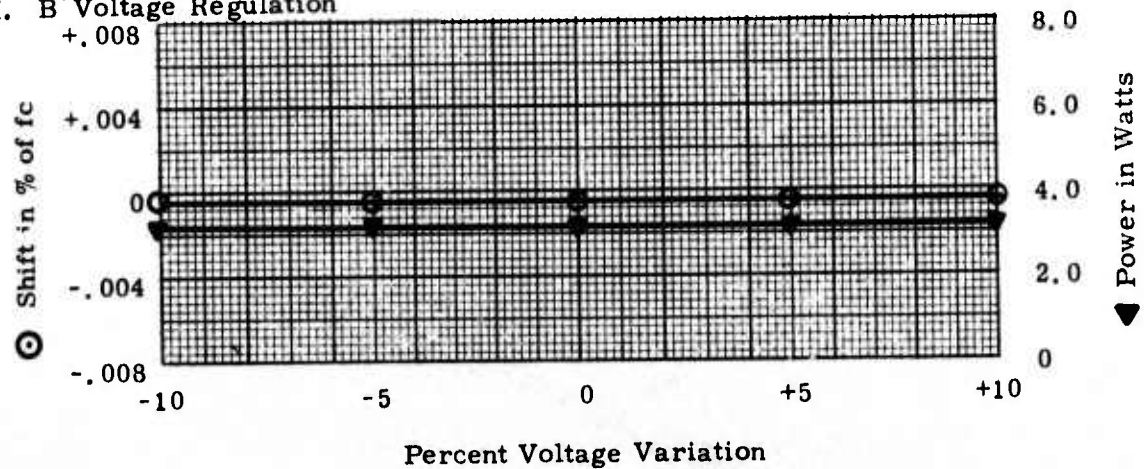

NORTHEASTERN UNIVERSITY

Evaluation Tests - RF Telemetry Transmitter - Sheet 2

Make: Vector ; Type: T202S ; Serial Number: 202 ;
Carrier Frequency f_c : 2220.5 MHz; Date: 6/23/75 ; By: PJR

IV. Modulation Response vs. Temperature

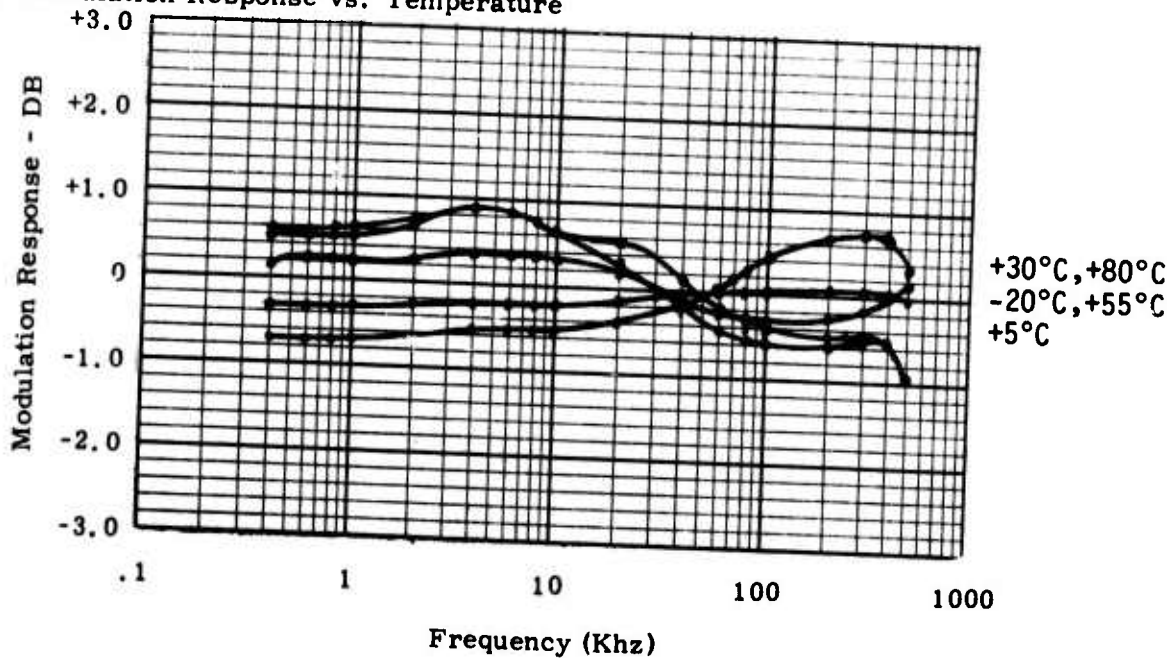

V. Linearity at Ambient

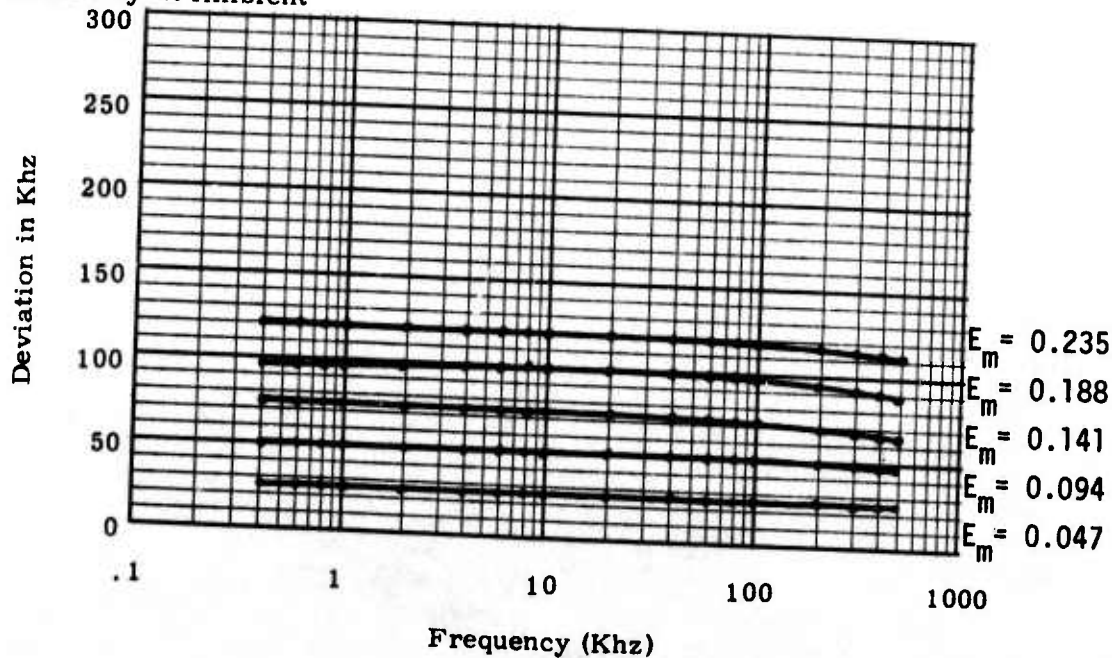

NORTHEASTERN UNIVERSITY

Evaluation Tests - RF Telemetry Transmitter - Sheet 3

Make: VECTOR ; Type: T 202 S ; Serial Number: 202 ;
 Carrier Frequency f_c : 2220.5 MHz; Date: 6/23/75 ; By: PJR ;

VI. Spurious Emission (Antenna Conducted)

Frequency Mhz	DB Down from f_c	Identification
1943	63 ± 3	$7/8 f_c$
2153	63 ± 3	$f_c - 15f_x$
2175	78 ± 3	$f_c - 10f_x$
2220.5	0	carrier frequency
2225	65 ± 3	$f_c + f_x$
2265	80 ± 3	$f_c + 10f_x$
3330	101 ± 3	$3f_c/2$
4441	74 ± 3	$2f_c$

NOTE: W. S. M. R. Regulation No. 105-2-60 requirement is $55+10 \log P_t$ DB Down from carrier.

VII. Miscellaneous

1. Maximum Distortion <2.0%
2. Incidental FM <500 Hz PEAK
3. Power Requirement 28.0 watts
4. Efficiency 11.6%
5. O.C. & S.C. Protection OK
6. Other Checks freq at 5:1 VSWR = 2220.4986
carrier shift = -0.0000135% of f_c for 5:1 VSWR

CHAPTER II

VOLTAGE-CONTROLLED SUBCARRIER OSCILLATORS

A. Evaluation Test Procedure for Voltage-Controlled Subcarrier Oscillators

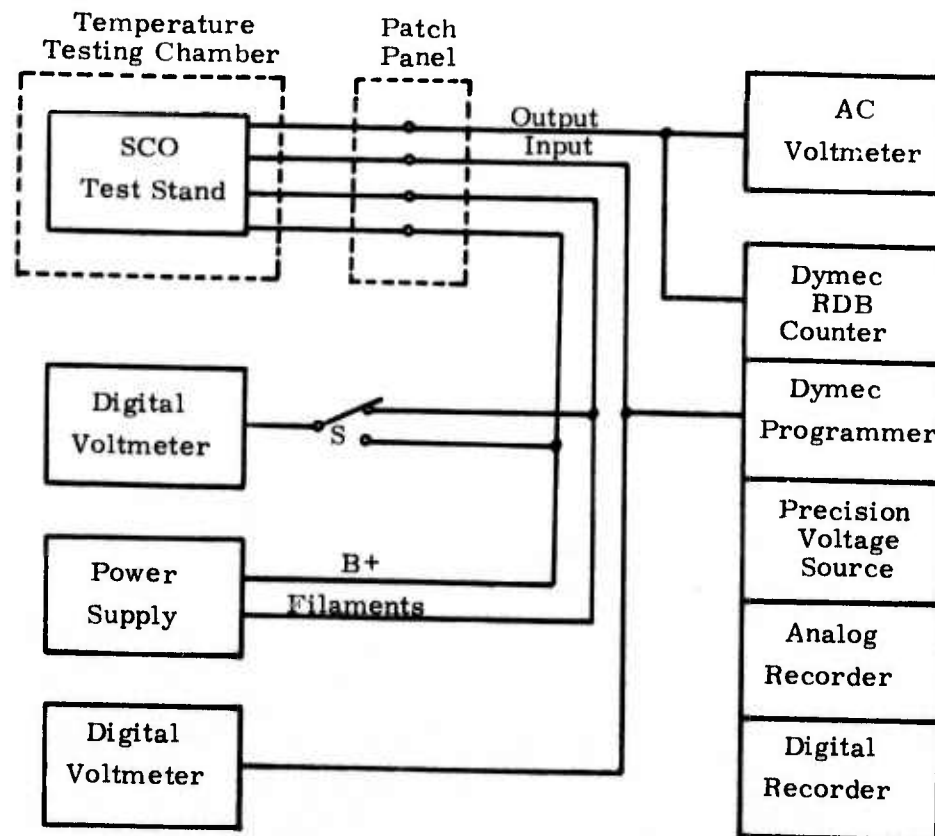

Figure 1

Initial Settings: Band-Edge Deviation Adjustments

- Step 1. Mount the voltage-controlled subcarrier oscillators on the SCO test stand, place the test stand inside the temperature testing chamber, and wire the test equipment as shown in Figure 1. Apply the specified supply voltage and set the chamber temperature at $+30^{\circ}\text{C}$. Allow sufficient warm-up time (refer to equipment specification) before proceeding to Step 2.
- Step 2. Adjust the SCO output control for maximum a-c voltage. Apply the specified input voltage which corresponds to the low band edge by depressing the zero push button selector (refer to Appendix "A" in Dymec manual for operating instructions) on the Dymec programmer. Adjust the low band-edge control to meet the low band-edge frequency limit specified by IRIG standards. That is, -7.5% of f_c for bands 1 - 21 and -15.0% of f_c for bands A - H.

- Step 3. Apply the specified input voltage which corresponds to the high band-edge by depressing push button selector #10. Adjust the high band-edge control to meet the high band-edge frequency limit specified by IRIG standards. That is, +7.5% for f_c for bands 1 - 21 and +15.0% of f_c for bands A - H. Do not readjust the SCO output control.
- Step 4. Apply the specified input voltage which corresponds to the center frequency of the band under test by depressing push button selector #5 and check to see that the center frequency is within manufacturer's specifications. If it is not, repeat steps 1 through 4 and adjust for the best tolerance limits possible.

Test I. Time Drift

- Step 1. Use the equipment set-up shown in Figure 1 and set the oven temperature at +30°C. Apply the recommended supply voltages. Without allowing a warm-up period for the SCO, apply the input voltages corresponding to the center frequency of the band under test. With the analog-recorder drive on low speed, obtain a continuous recording (Data Sheet I) of the center frequency "Drift in % of FBW" and record the output a-c voltage at regular intervals until the SCO has stabilized.
- Step 2. Calculations and Results
 (a) Plot "Drift in % of FBW" versus "Time" (using information on Data Sheet I) on Graph Sheet 1.
 (b) Plot "Output Voltage" versus "Time" on Graph Sheet 1.

Test II, III. Temperature Stability and Amplitude Modulation

- Step 1. Use the equipment set-up shown in Figure 1. Apply recommended supply voltages and check that the band-edges have been adjusted properly as per the initial setting procedures.
- Step 2. With the temperature of the testing chamber at +30°C set the Dymec programmer in the "Automatic Stepping Mode". The input d-c voltage is automatically varied from the low to the high band-edge in eleven equal steps by depressing the "Automatic Scan" push button selector. During the automatic scan enter the maximum and minimum values of the a-c output voltage swing on Data Sheet II.
- Step 3. Repeat Step 2 for each of the following sequence of oven temperatures: -20°C, +5°C, +30°C, +55°C, +80°C. Be sure to allow sufficient time (10 minutes or more) for all components of the SCO to reach each new temperature before making measurements. This can be done by monitoring the center frequency shift, on the chart-recorder, during the cooling and heating periods until the output frequency has stabilized. Note that two sets of data should be taken at the +30°C temperature, one immediately after the time drift test has been made and a second during the temperature transition from -20°C to +80°C. This is to obtain an indication of how well the characteristics of the SCO repeat with temperature.

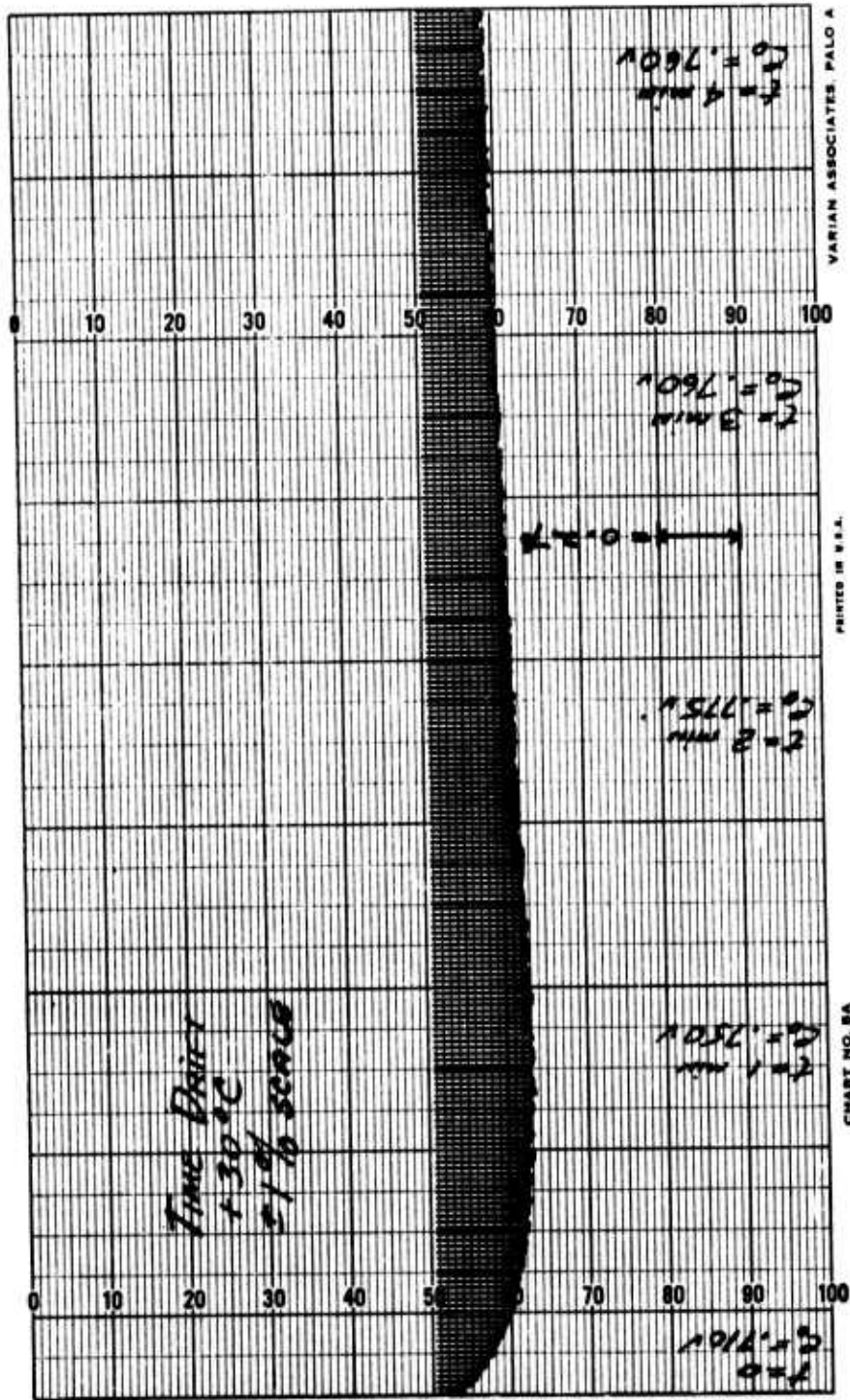

SAMPLE
DATA SHEET 1 - TIME DRIFT

NORTHEASTERN UNIVERSITY

Evaluation Tests - Voltage Controlled Oscillators - Sheet 1

Make: _____; Type: _____; Serial Number: _____;

IRIG Band Number: _____; FBW: _____ Hz; Date: _____; By: _____;

I. Time Drift

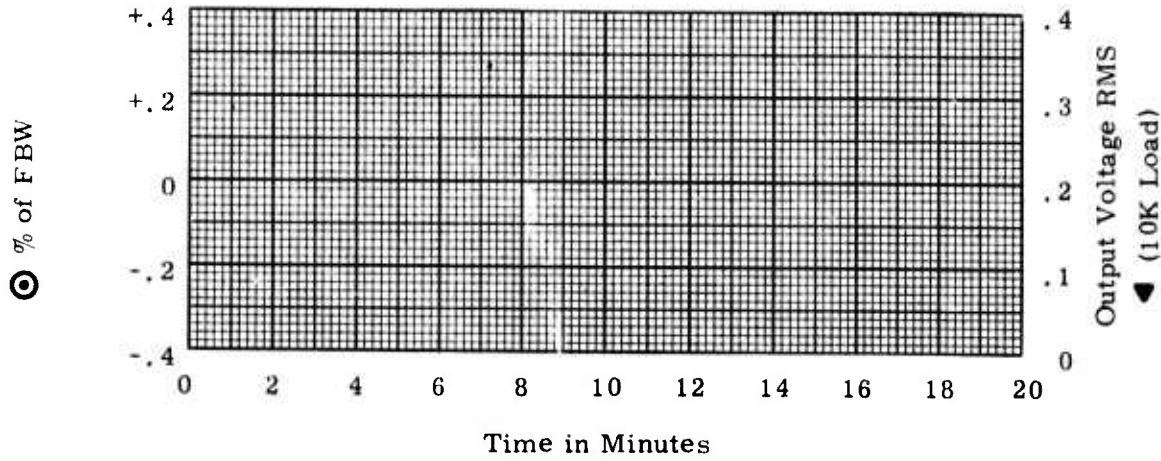

II. Temperature Stability

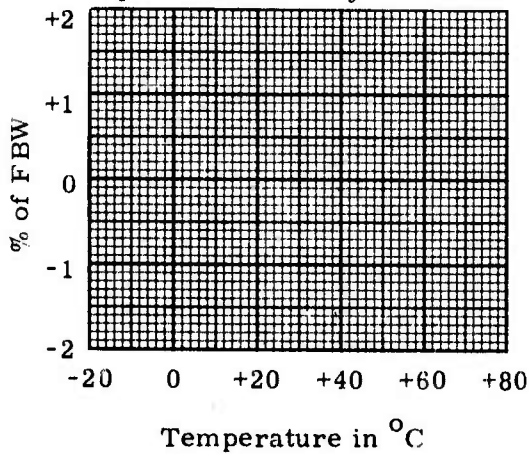

III. Amplitude Modulation

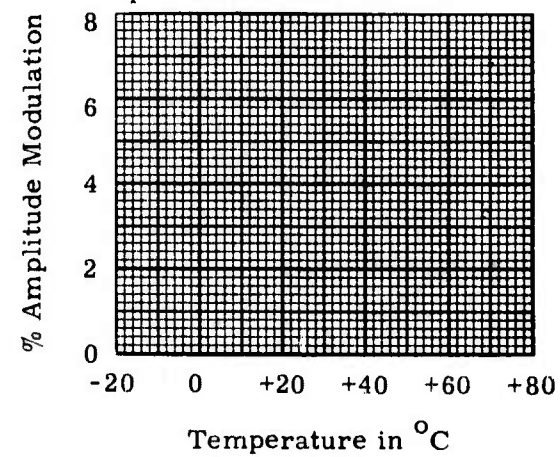

IV. Effects of Source Impedence at Ambient

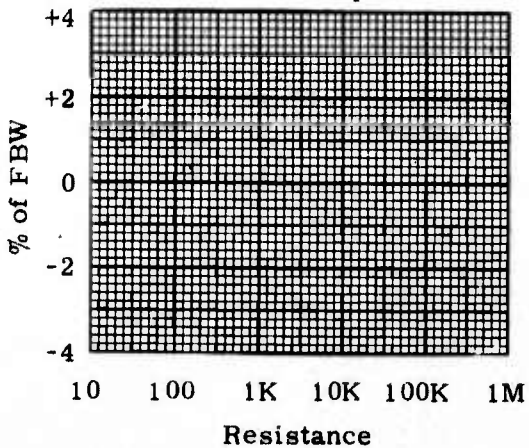

V. B+ Voltage Regulation at Ambient

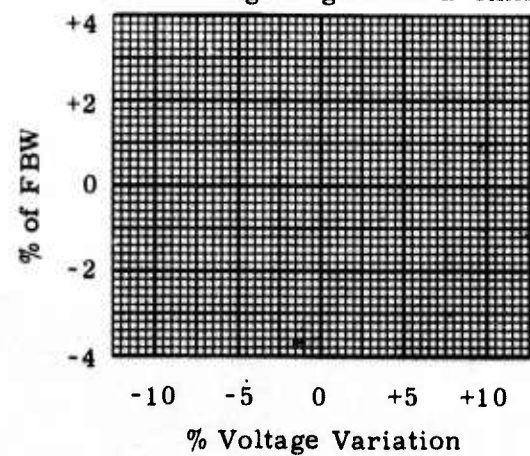

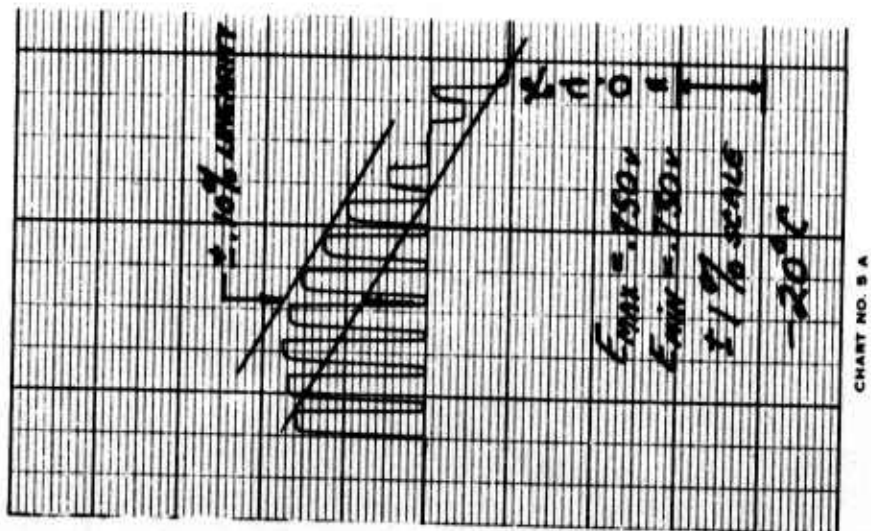
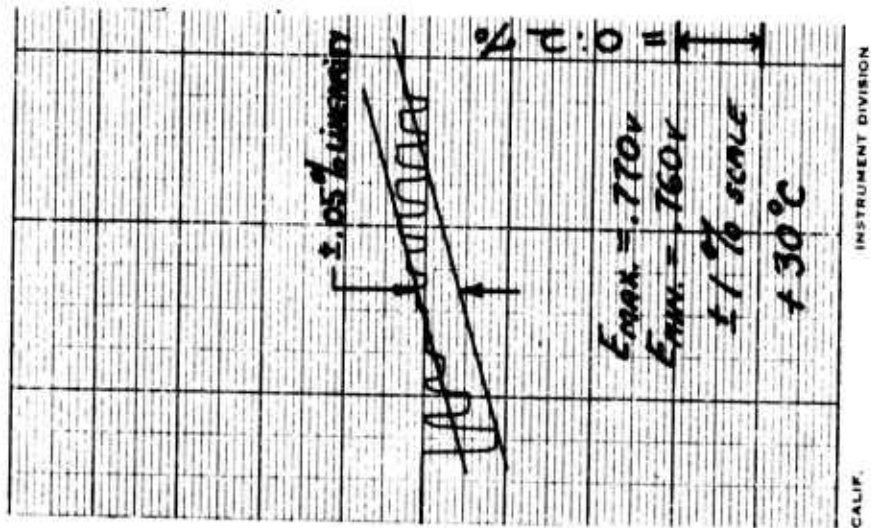
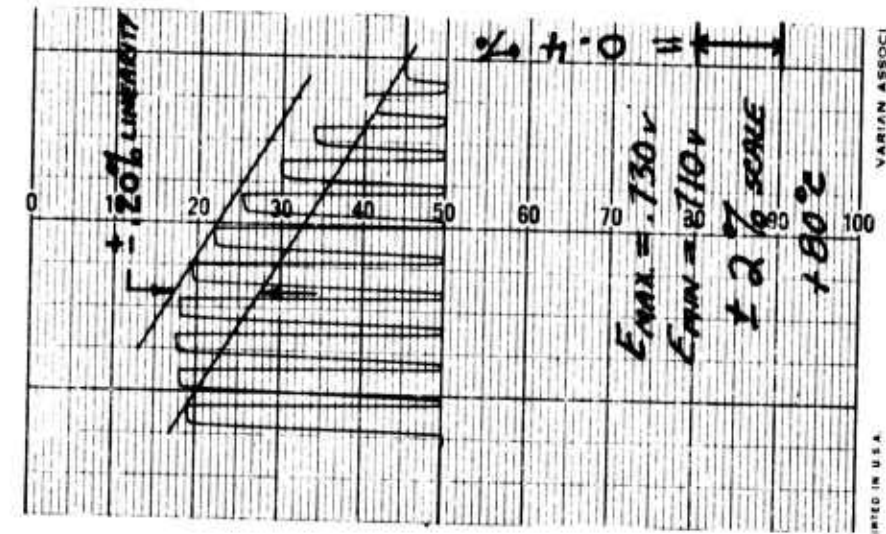

SAMPLE
 DATA SHEET II

- Step 4. Calculations and Results
- (a) Amplitude Modulation - Plot % amplitude modulation versus temperature on Graph Sheet 1 using the relation:
- $$\% \text{ Amp. Mod.} = \frac{E_{\text{max}} - E_{\text{min}}}{E_{\text{max}} + E_{\text{min}}} \times 100\%$$
- (b) Temperature Stability - The temperature stability is obtained directly in % of FBW for zero percent deviation from band center (using information in Data Sheet II recorded for the various temperatures). Plot temperature stability in % of FBW versus temperature on Graph Sheet 1.

Test IV. Effect of Source Impedance

- Step 1. Use equipment set-up shown in Figure 2. Set the oven temperature at +30°C.
- Step 2. Set the Dymec programmer in the "Manual" operating mode. Depress the zero push button selector. With the analog recorder drive on low speed, obtain a recording of % frequency shift due to back current, for source impedances of 10, 100, 1K, 10K, 100K and 1M. (data Sheet III).
- Step 3. Calculations and Results
Plot frequency shift in % of FBW versus source impedances on Graph Sheet 1.

Test V. Voltage Regulation

- Step 1. Use the equipment set-up shown in Figure 1 and set the oven temperature at +30°C.
- Step 2. With the Dymec programmer set in the "Manual" operating mode, apply the specified input voltage which corresponds to the center frequency of the band under test by depressing push button selector #5. With the analog recorder drive on low speed, vary the B+ supply voltage from -10% to +10% of recommended B+ in five equal steps. Obtain a "% frequency shift" recording versus % B+ voltage variation (Data Sheet IV).
- Step 3. Calculations and Results
Plot frequency shift in % of FBW versus % B+ voltage variation on Graph Sheet 1.

Test VI. Linearity

- Step 1. Use the equipment set-up as shown in Figure 1. Set the oven temperature at +30°C.
- Step 2. Put the Dymec programmer in the "Automatic Stepping Mode". With the analog recorder drive on high speed, obtain a linearity recording as seen on Data Sheet II.

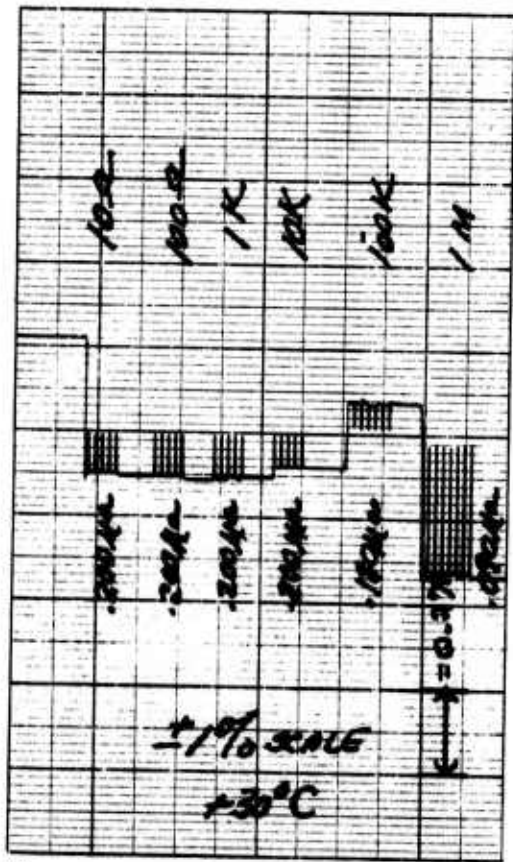

INSTRUMENT DIVISION

SAMPLE
 DATA SHEET III - SOURCE IMPEDANCE

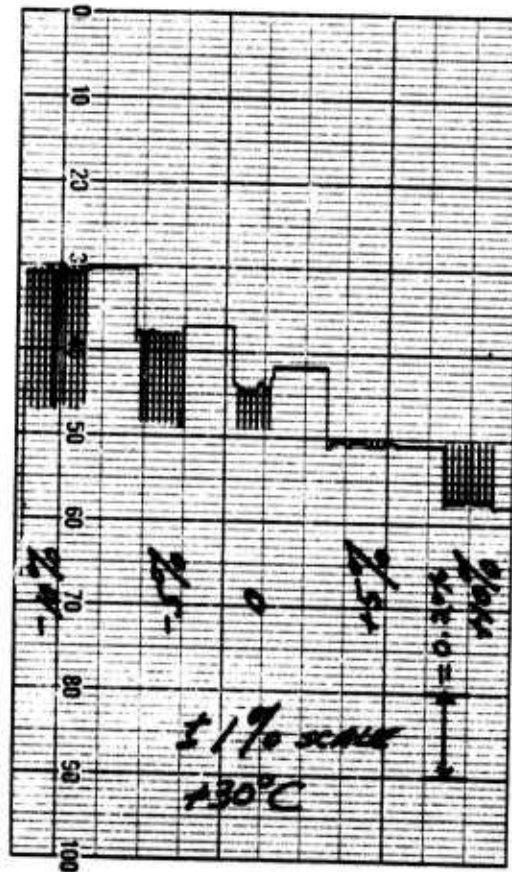

CHART NO. 8 A

SAMPLE
 DATA SHEET IV - VOLTAGE REGULATION

Step 3. Repeat Step 2 for each of the following sequence of oven temperatures: -20°C , $+5^{\circ}\text{C}$, $+30^{\circ}\text{C}$, $+55^{\circ}\text{C}$, $+80^{\circ}\text{C}$.

Step 4. Calculations and Results

Plot linearity in % of FBW versus theoretical deviation in % of FBW for zero percent deviation from band center (using information in Data Sheet II recorded for the various temperatures). Plot on Graph Sheet 2.

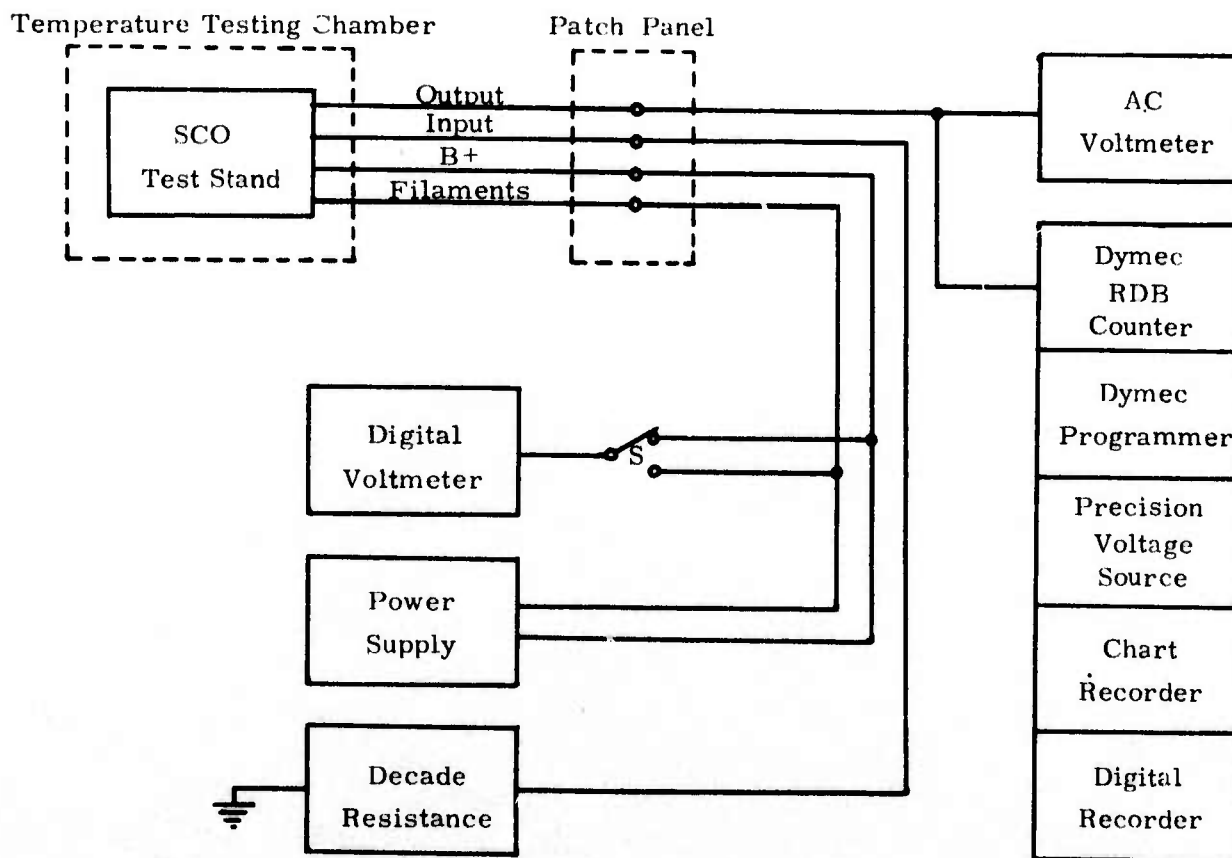

Figure 2

NORTHEASTERN UNIVERSITY

Evaluation Tests - Voltage Controlled Oscillators - Sheet 2

Make: _____; Type: _____; Serial Number: _____;
 IRIG Band Number: _____; FBW: _____ Hz; Date: _____; By: _____

VI. Linearity vs. Temperature

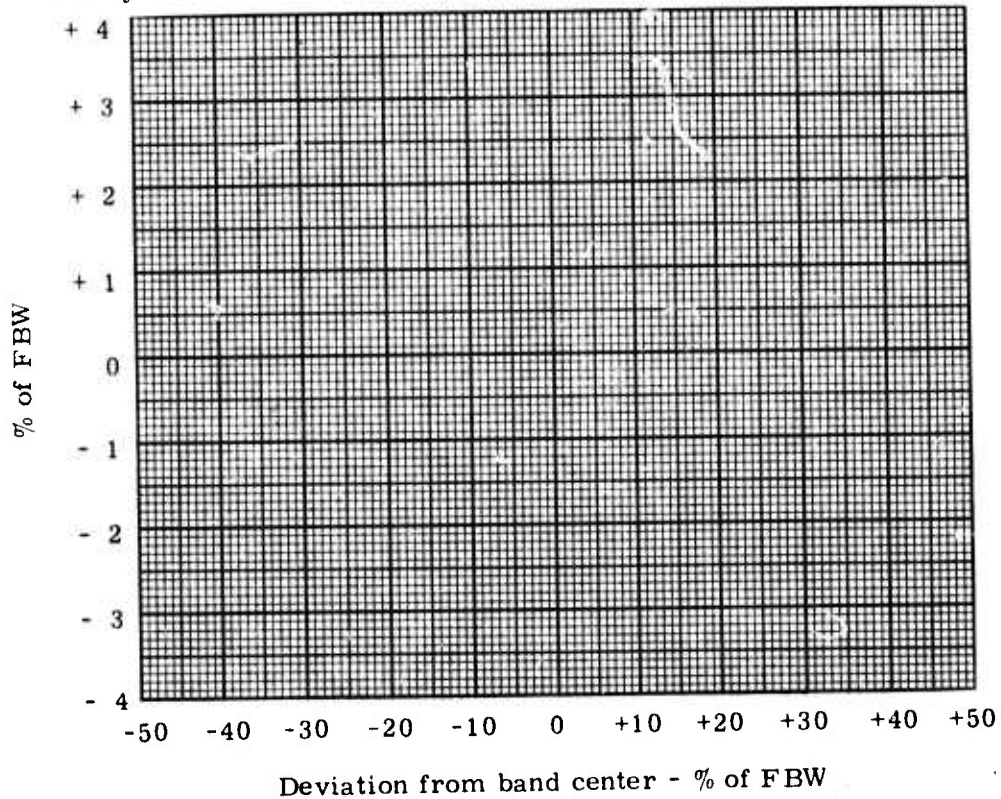

VII. Miscellaneous

1. Power Requirements _____
 2. Input Impedence _____
 3. Output Impedence _____
 4. Harmonic Distortion _____
 5. Other Checks _____
- | | | |
|-------|------------------|----------|
| | LINEARITY | |
| -20°C | ± | from BSL |
| +5°C | ± | from BSL |
| +30°C | ± | from BSL |
| +55°C | ± | from BSL |
| +80°C | ± | from BSL |

B. Test Results for Voltage Controlled Subcarrier Oscillators

Table II contains information with regard to the manufacture, type and number of SCO's tested during the period of 9 January 1975 through 13 February 1976. The remainder of this chapter contains the test results for each SCO in the order listed in the table.

Table II

<u>Manufacturer</u>	<u>Type</u>	<u>Number Tested</u>
Omnitek	40A1	6
Vector	MMO-11	14
Vector	MTS-42	13

Evaluation Tests - Proprietary Information Sheet

Voltage Controlled Subcarrier Oscillators

Make: Omnitek;

Type: 40A1;

Manufacturer's Specifications

Band Edge Accuracy: $\pm 1.5\%$ dbw.
Linearity: ± 0.2 dbw, best straight line, maintained from -40°C to $+85^{\circ}\text{C}$.
Time Stability: $\pm 0.25\%$ dbw for 8 hours @ 25°C after 1 minute.
Distortion: $< 1.0\%$ anywhere within the passband from -40°C to $+85^{\circ}\text{C}$.
Amplitude Modulation: $< 5.0\%$.
Intelligence Frequency Response: ± 0.1 dB of DC response for a Modulation Index of 5 or greater.
Input Impedance: 500 K Ω 's $+10\%$ -0% .
Input Voltage: Any 5 volt range from -5 to +5 volts.
Source Impedance Sensitivity: $< 1.0\%$ dbw for source impedance change of zero to infinity.
Output Impedance: 47 K Ω 's, $\pm 10\%$.
Output Voltage: 0.325 ± 0.025 volts RMS at center frequency into a load of 10 K Ω 's shunted by 40pf.
Modulation Feedthrough: 40 dB below output signal level.
Power Requirements: $+28 \pm 10$ volts @ 3.0 ma. max.
B+ Stability: A ± 10 volt change in the B+ supply will cause a frequency change of less than $\pm 0.5\%$ dbw.
Voltage Protection: ± 40 volt supply voltage will not damage the unit.

NORTHEASTERN UNIVERSITY

Evaluation Tests - Voltage Controlled Oscillators - Sheet 1

Make: Omnitek ; Type: 40A1 ; Serial Number: 3168 ;
 IRIG Band Number: 6 ; FBW: 256 Hz ; Date: 4/28/75 ; By: PJR

I. Time Drift

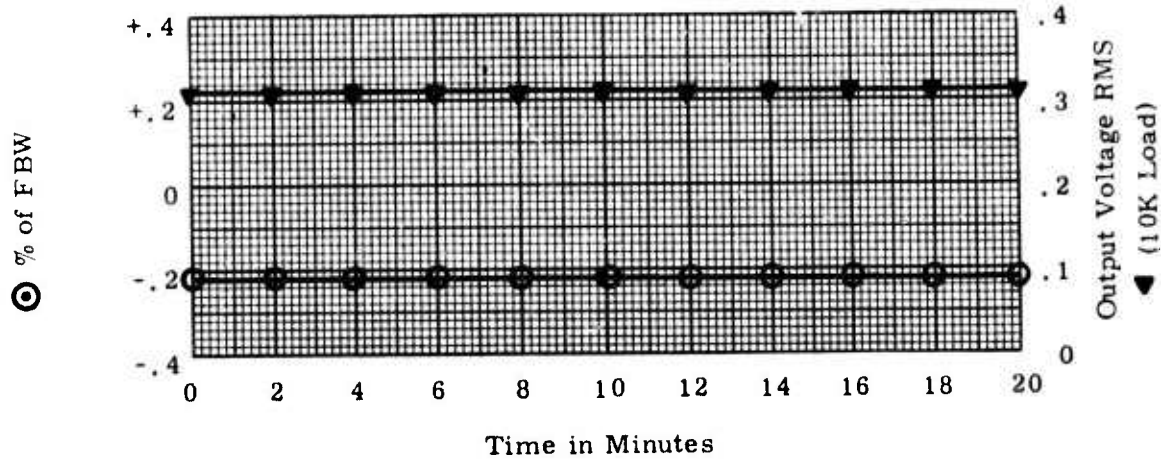

II. Temperature Stability

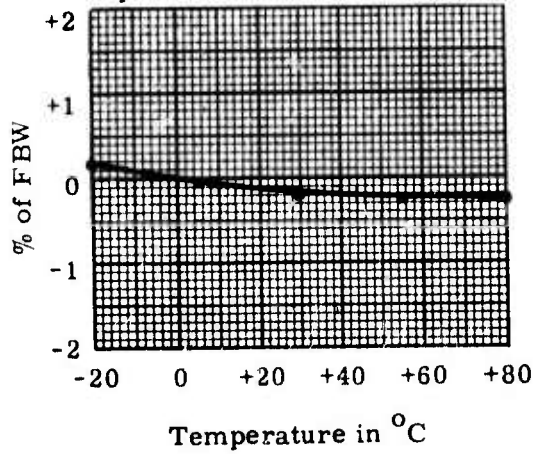

III. Amplitude Modulation

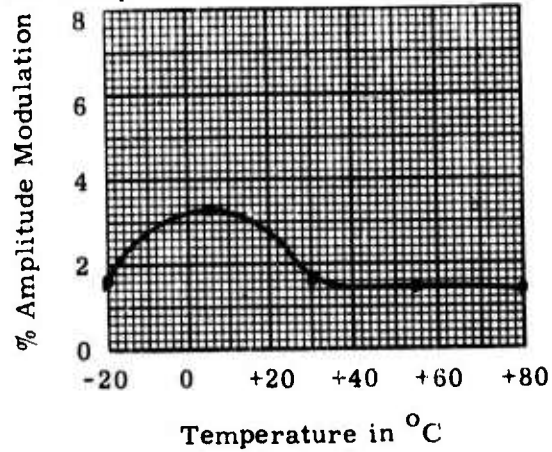

IV. Effects of Source Impedance at Ambient

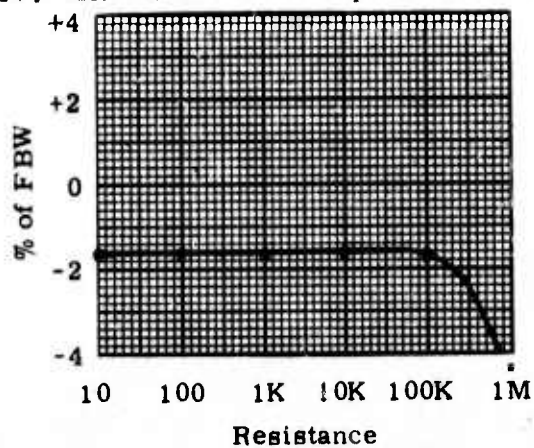

V. B+ Voltage Regulation at Ambient

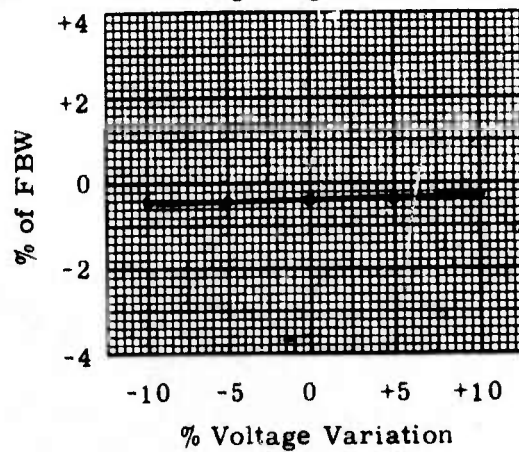

NORTHEASTERN UNIVERSITY

Evaluation Tests - Voltage Controlled Oscillators - Sheet 2

Make: Omnitek ; Type: 40A1 ; Serial Number: 3168 ;
 IRIG Band Number: 6 ; FBW: 256 Hz ; Date: 4/28/75 ; By: PJR ;

VI. Linearity vs. Temperature

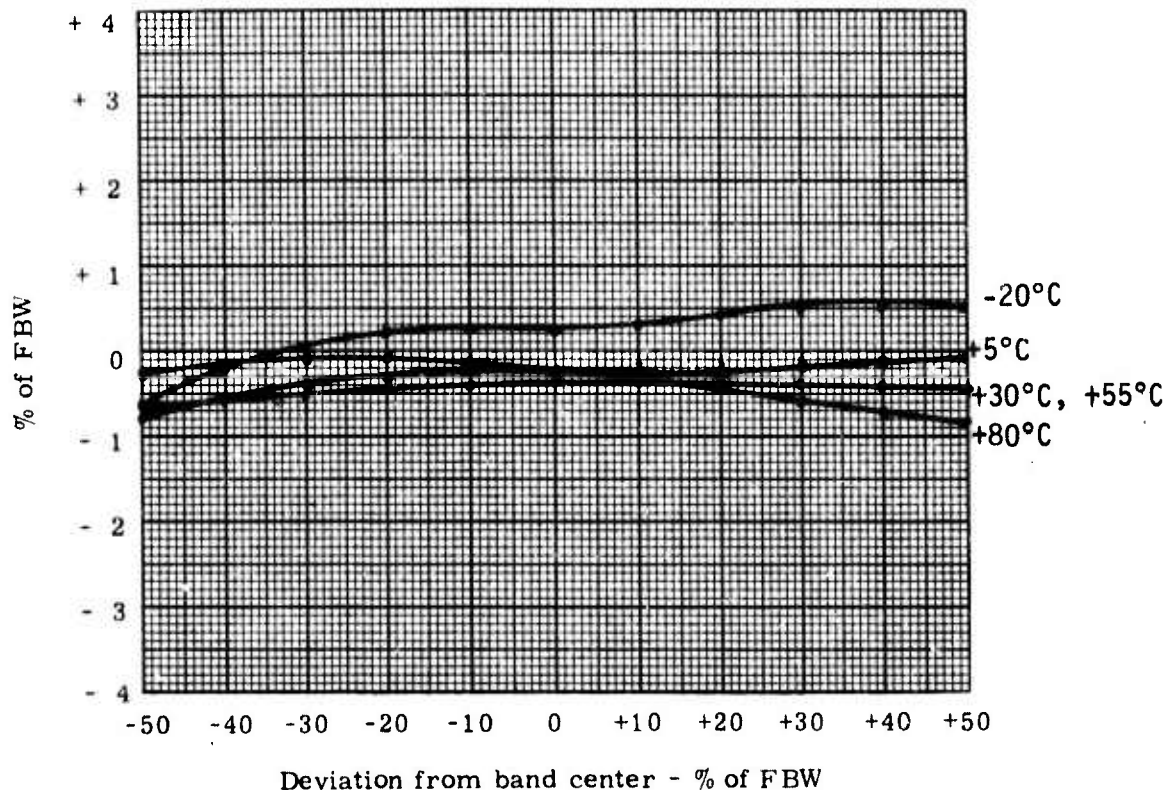

VII. Miscellaneous

1. Power Requirements 76mw
2. Input Impedance >600KΩ
3. Output Impedance <50KΩ
4. Harmonic Distortion .29%
5. Other Checks LINEARITY

-20°C	±	0.17%	from BSL
+5°C	±	0.10%	from BSL
+30°C	±	0.12%	from BSL
+55°C	±	0.16%	from BSL
+80°C	±	0.10%	from BSL

NORTHEASTERN UNIVERSITY

Evaluation Tests - Voltage Controlled Oscillators - Sheet 1

Make: **Omnitek** ; Type: **40A1** ; Serial Number: **3169**
 IRIG Band Number: **6** ; FBW: **256** Hz; Date: **4/28/75** ; By: **PJR**

I. Time Drift

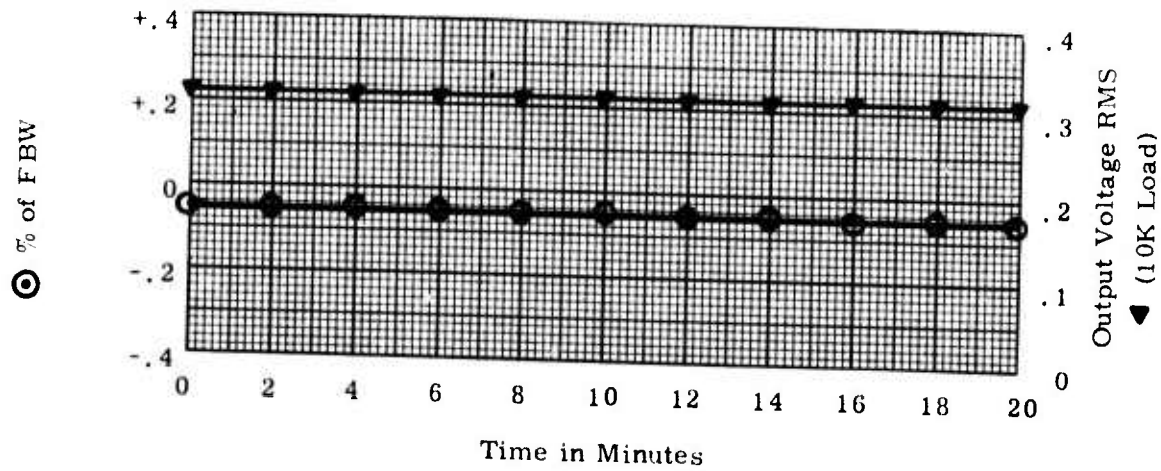

II. Temperature Stability

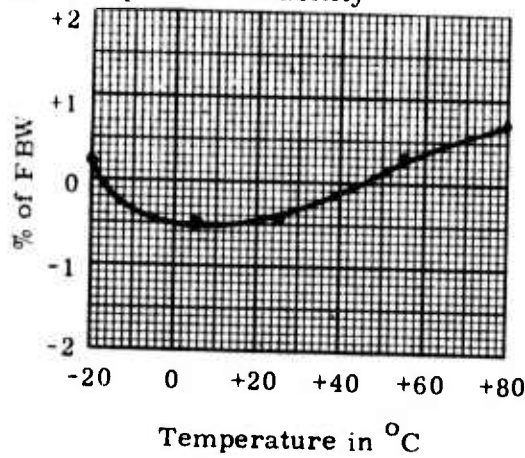

III. Amplitude Modulation

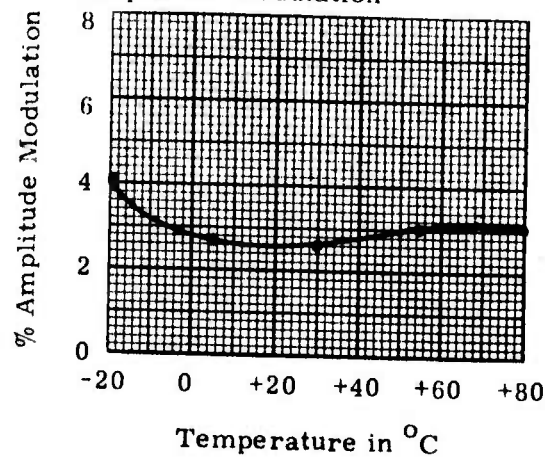

IV. Effects of Source Impedance at Ambient

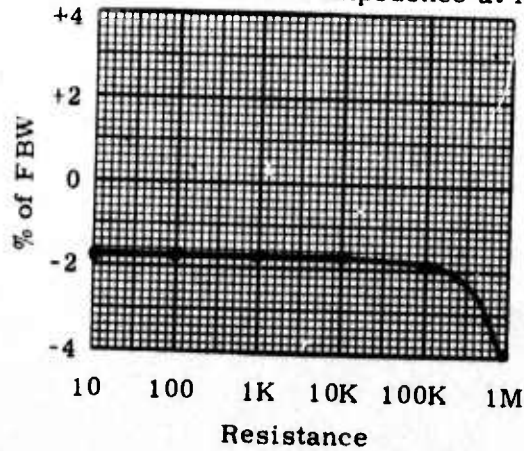

V. B+ Voltage Regulation at Ambient

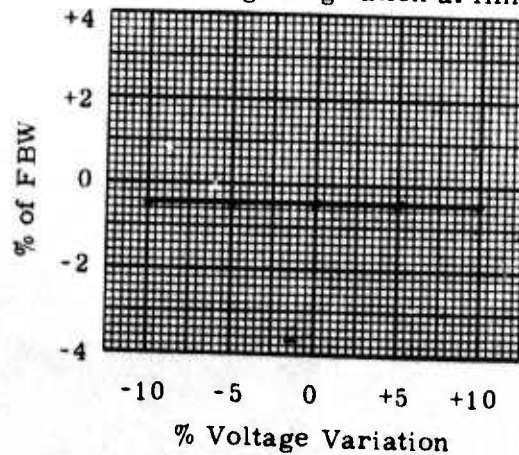

NORTHEASTERN UNIVERSITY

Evaluation Tests - Voltage Controlled Oscillators - Sheet 2

Make: Omnitek ; Type: 40A1 ; Serial Number: 3169
 IRIG Band Number: 6 ; FBW: 256 Hz; Date: 4/28/75 ; By: PJR

VI. Linearity vs. Temperature

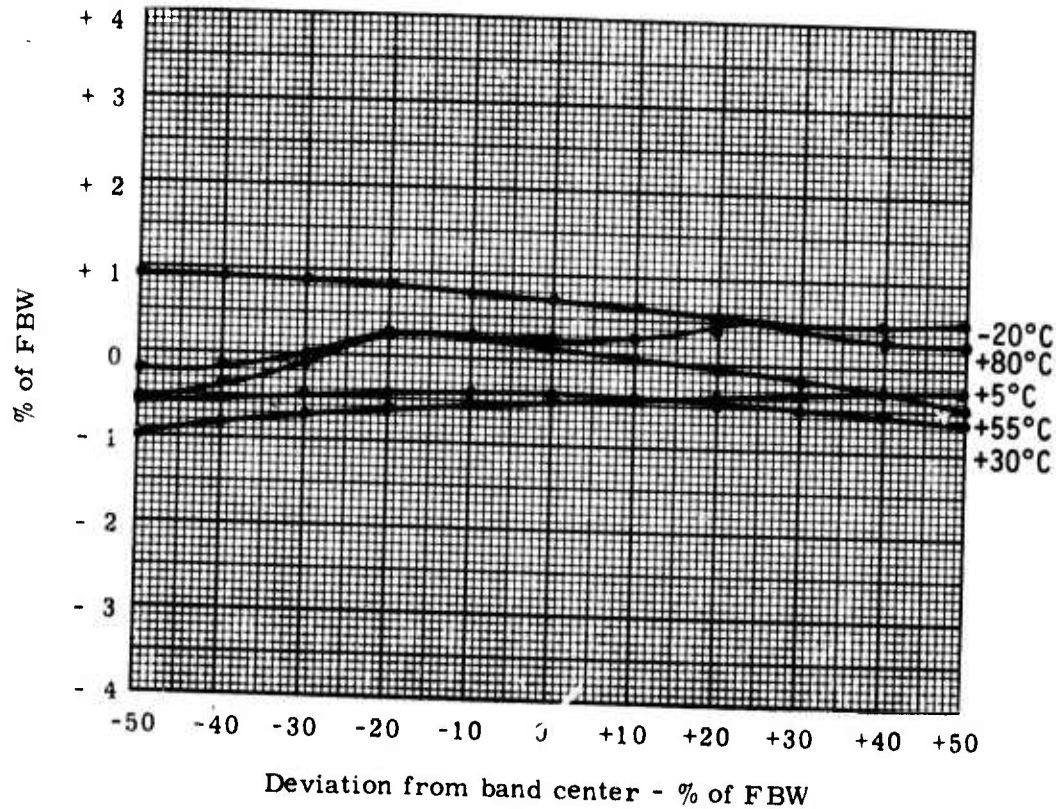

VII. Miscellaneous

1. Power Requirements 76mw
2. Input Impedence >600KΩ
3. Output Impedence <50KΩ
4. Harmonic Distortion .24%
5. Other Checks LINEARITY

-20°C	±	0.16%	from BSL
+5°C	±	0.09%	from BSL
+30°C	±	0.10%	from BSL
+55°C	±	0.26%	from BSL
+80°C	±	0.06%	from BSL

NORTHEASTERN UNIVERSITY

Evaluation Tests - Voltage Controlled Oscillators - Sheet 1

Make: Omnitek ; Type: 40A1 ; Serial Number: 3170 ;
 IRIG Band Number: 13 ; FBW: 220 Hz; Date: 4/28/75 ; By: PJR

I. Time Drift

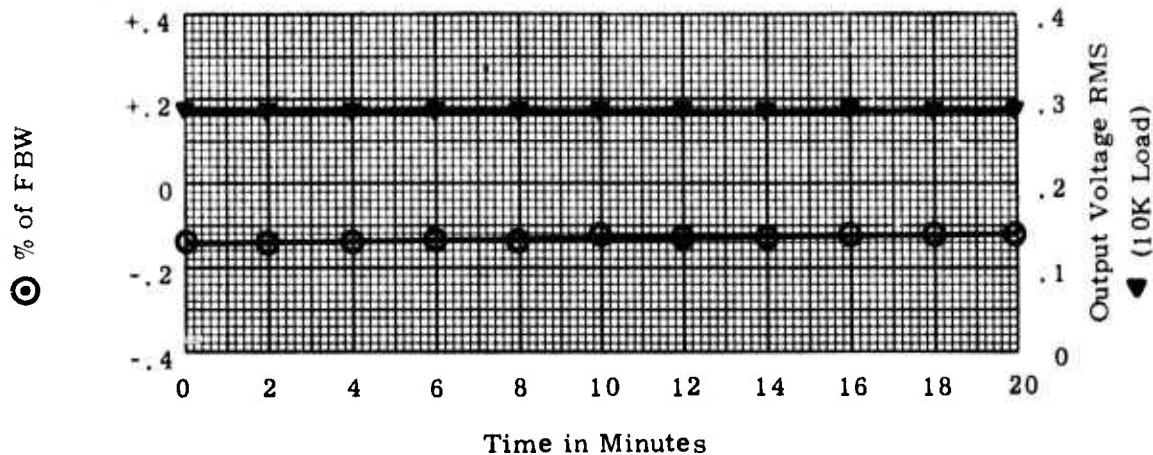

II. Temperature Stability

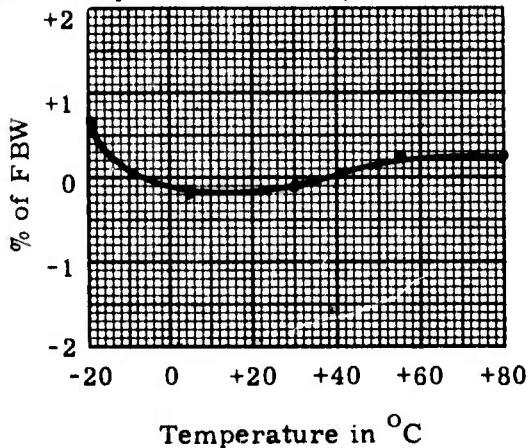

III. Amplitude Modulation

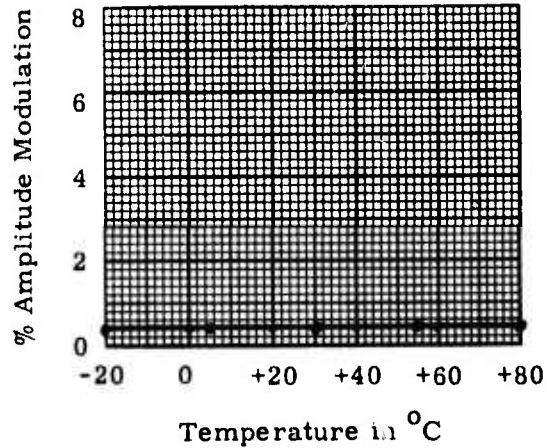

IV. Effects of Source Impedance at Ambient

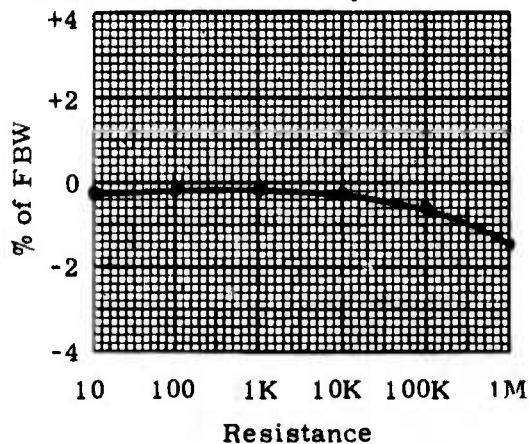

V. B+ Voltage Regulation at Ambient

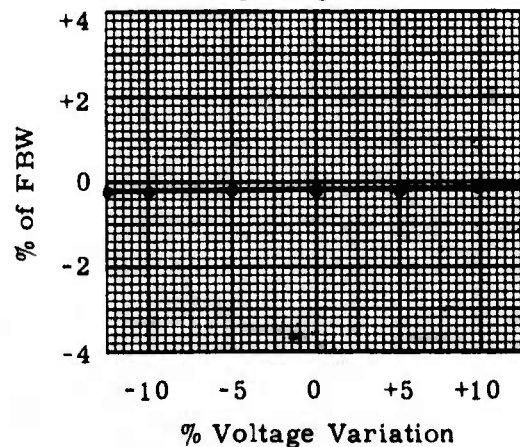

NORTHEASTERN UNIVERSITY

Evaluation Tests - Voltage Controlled Oscillators - Sheet 2

Make: Omnitek ; Type: 40A1 ; Serial Number: 3170 ;
 IRIG Band Number: 13 ; FBW: 220 Hz ; Date: 4/28/75 ; By: PJR ;

VI. Linearity vs. Temperature

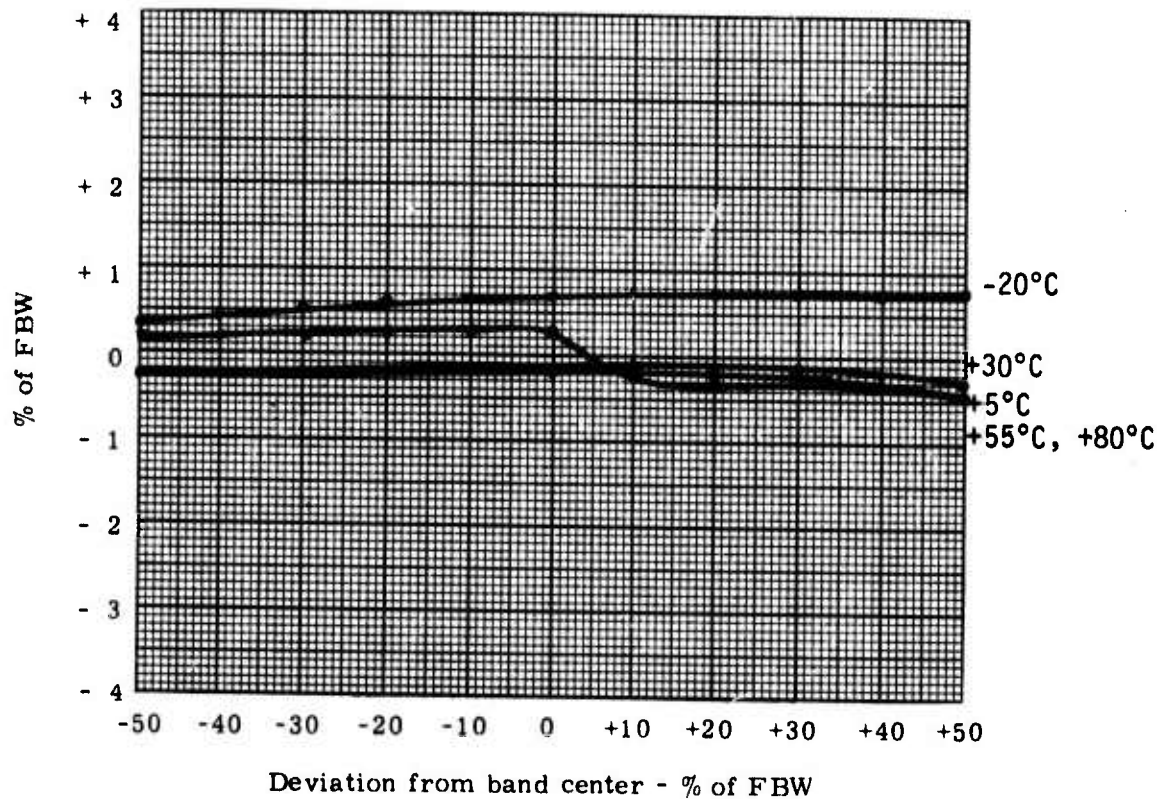

VII. Miscellaneous

1. Power Requirements 78mw
2. Input Impedance >500KΩ
3. Output Impedance <50KΩ
4. Harmonic Distortion .23%
5. Other Checks LINEARITY

-20°C	±	0.06%	from BSL
+5°C	±	0.07%	from BSL
+30°C	±	0.07%	from BSL
+55°C	±	0.17%	from BSL
+80°C	±	0.16%	from BSL

NORTHEASTERN UNIVERSITY

Evaluation Tests - Voltage Controlled Oscillators - Sheet 1

Make: Omnitek ; Type: 40A1 ; Serial Number: 3171 ;
 IRIG Band Number: 13 ; FBW: 220 Hz; Date: 4/28/75 ; By: PJR ;

I. Time Drift

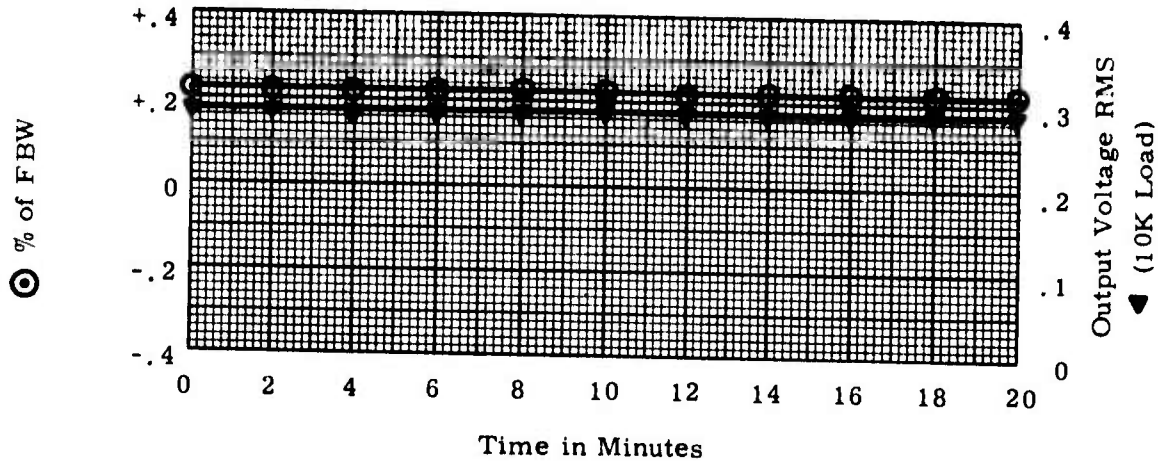

II. Temperature Stability

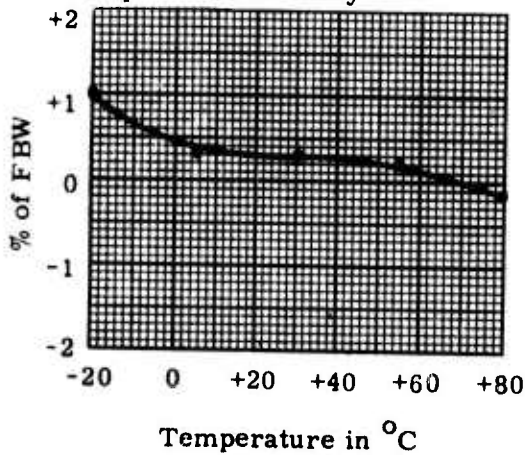

III. Amplitude Modulation

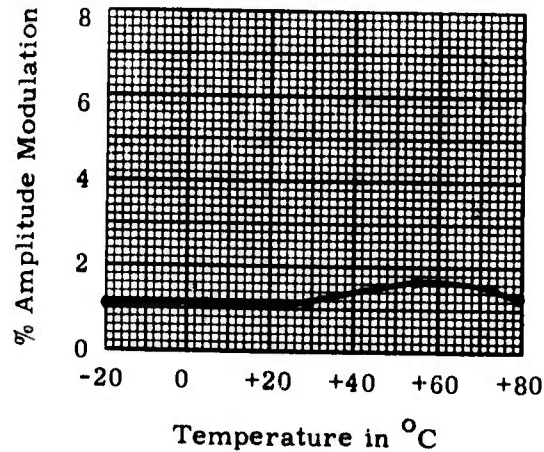

IV. Effects of Source Impedance at Ambient

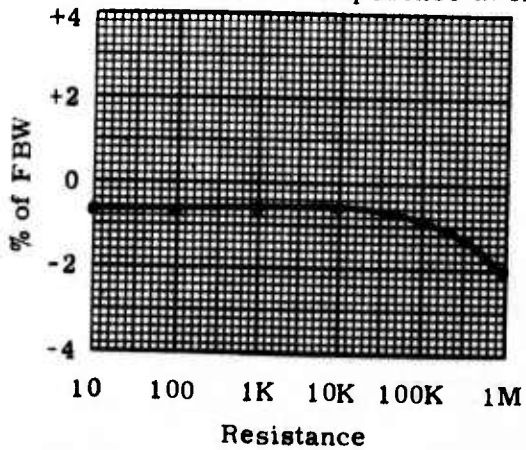

V. B+ Voltage Regulation at Ambient

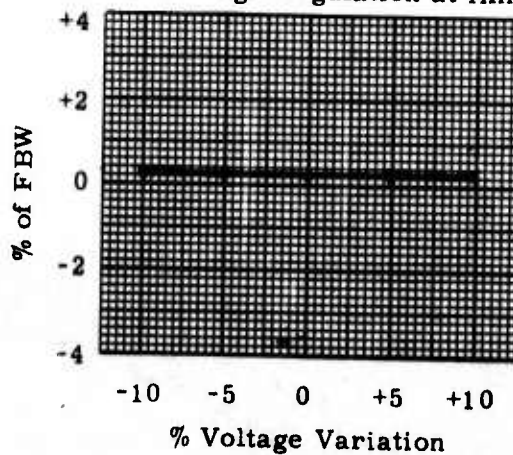

NORTHEASTERN UNIVERSITY

Evaluation Tests - Voltage Controlled Oscillators - Sheet 2

Make: Omnitek ; Type: 40A1 ; Serial Number: 3171
 IRIG Band Number: 13 ; FBW: 220 Hz; Date: 4/28/75 ; By: PJR

VI. Linearity vs. Temperature

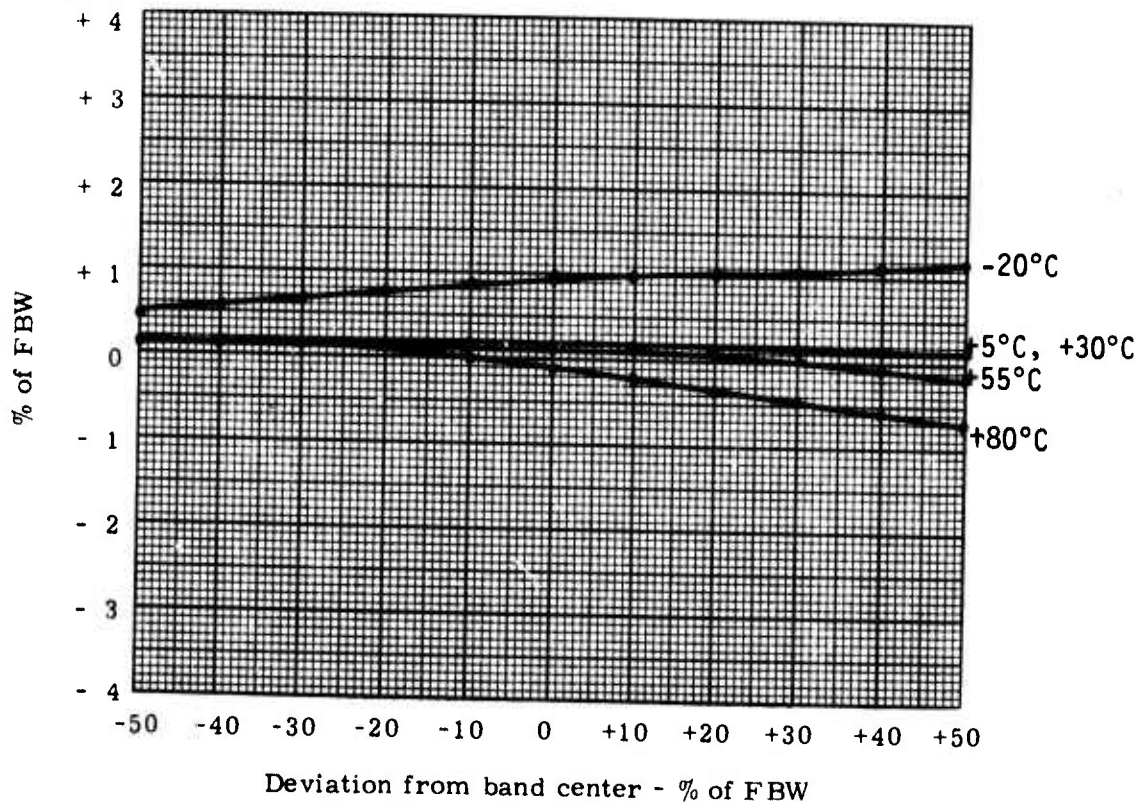

VII. Miscellaneous

1. Power Requirements	<u>76mw</u>
2. Input Impedence	<u>>500KΩ</u>
3. Output Impedence	<u><50KΩ</u>
4. Harmonic Distortion	<u>.275%</u>
5. Other Checks	<u>LINEARITY</u>
-20°C	± 0.06% from BSL
+5°C	± 0.03% from BSL
+30°C	± 0.03% from BSL
+55°C	± 0.19% from BSL
+80°C	± 0.19% from BSL

NORTHEASTERN UNIVERSITY

Evaluation Tests - Voltage Controlled Oscillators - Sheet 1

Make: Omnitek ; Type: 40A1 ; Serial Number: 3172 ;
 IRIG Band Number: 18 ; FBW: 10500 Hz; Date: 4/25/75 ; By: PJR

I. Time Drift

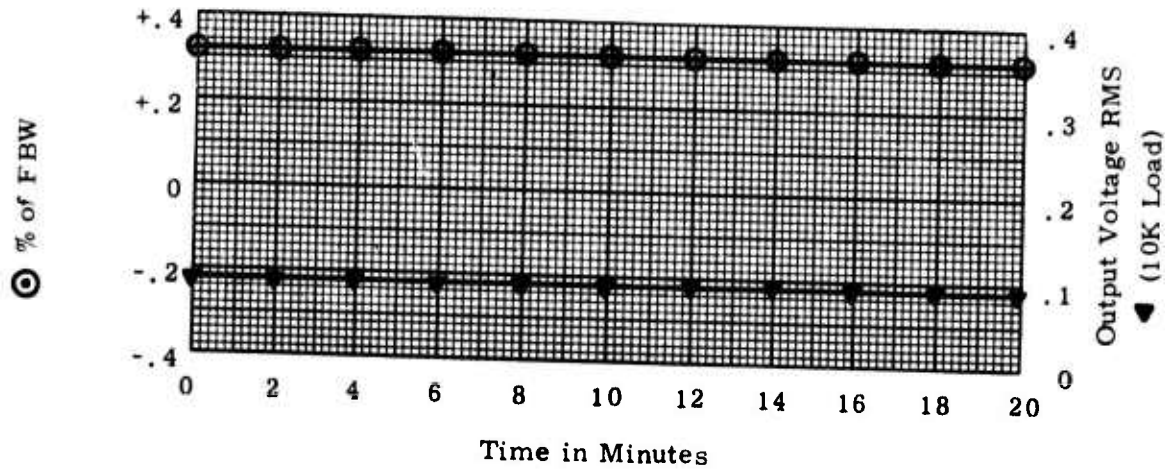

II. Temperature Stability

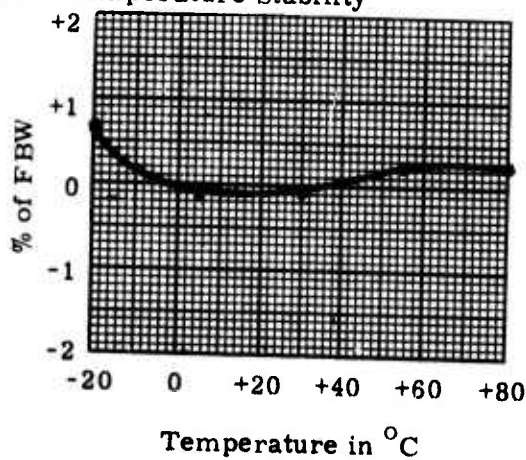

III. Amplitude Modulation

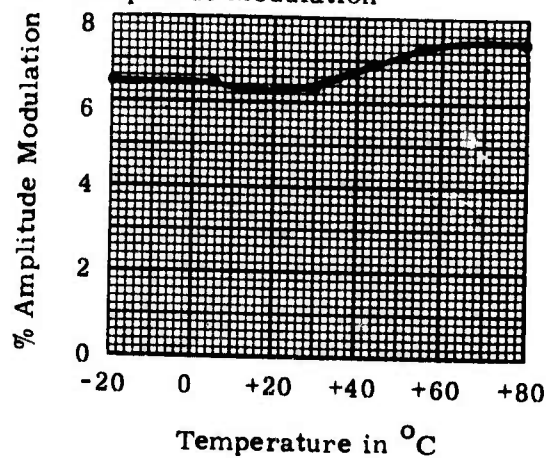

IV. Effects of Source Impedance at Ambient

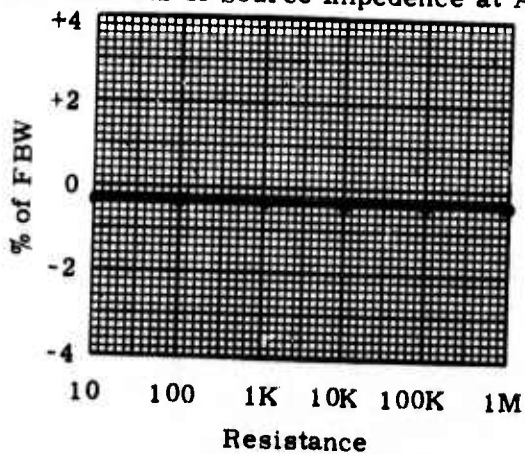

V. B+ Voltage Regulation at Ambient

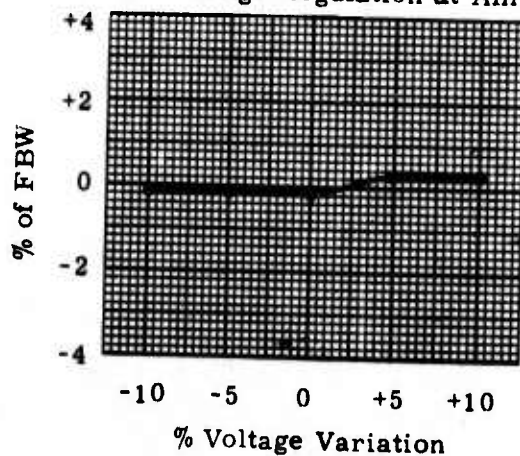

NORTHEASTERN UNIVERSITY

Evaluation Tests - Voltage Controlled Oscillators - Sheet 2

Make: Omnitek ; Type: 40A1 ; Serial Number: 3172
 IRIG Band Number: 18 ; FBW: 10500 Hz ; Date: 4/25/75 ; By: PJR

VI. Linearity vs. Temperature

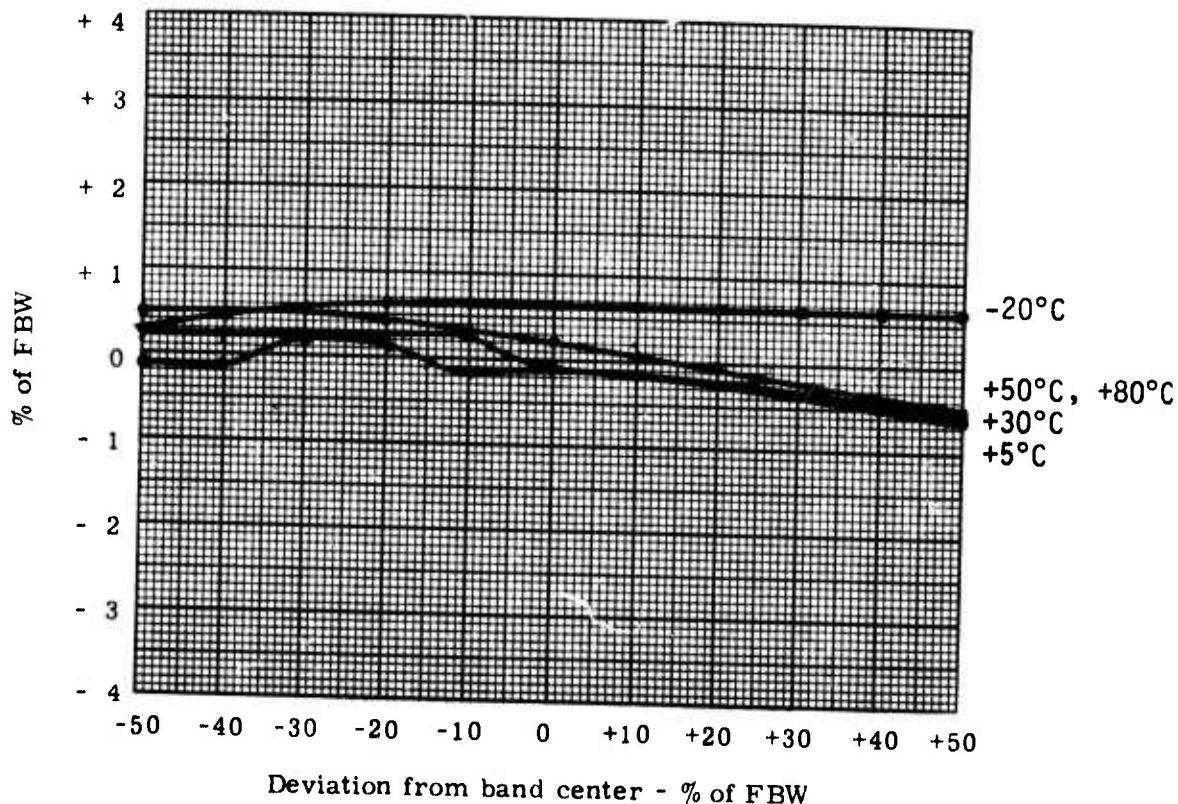

VII. Miscellaneous

1. Power Requirements	<u>78.4 mw</u>
2. Input Impedence	<u>>500KΩ</u>
3. Output Impedence	<u><50KΩ</u>
4. Harmonic Distortion	<u>.22%</u>
5. Other Checks	<u>LINEARITY</u>
-20°C	<u>± 0.12% from BSL</u>
+5°C	<u>± 0.22% from BSL</u>
+30°C	<u>± 0.32% from BSL</u>
+55°C	<u>± 0.18% from BSL</u>
+80°C	<u>± 0.17% from BSL</u>

NORTHEASTERN UNIVERSITY

Evaluation Tests - Voltage Controlled Oscillators - Sheet 1

Make: Omnitek ; Type: 40A1 ; Serial Number: 3173 ;
 IRIG Band Number: 18 ; FBW: 10500 Hz ; Date: 4/24/75 ; By: PJR ;

I. Time Drift

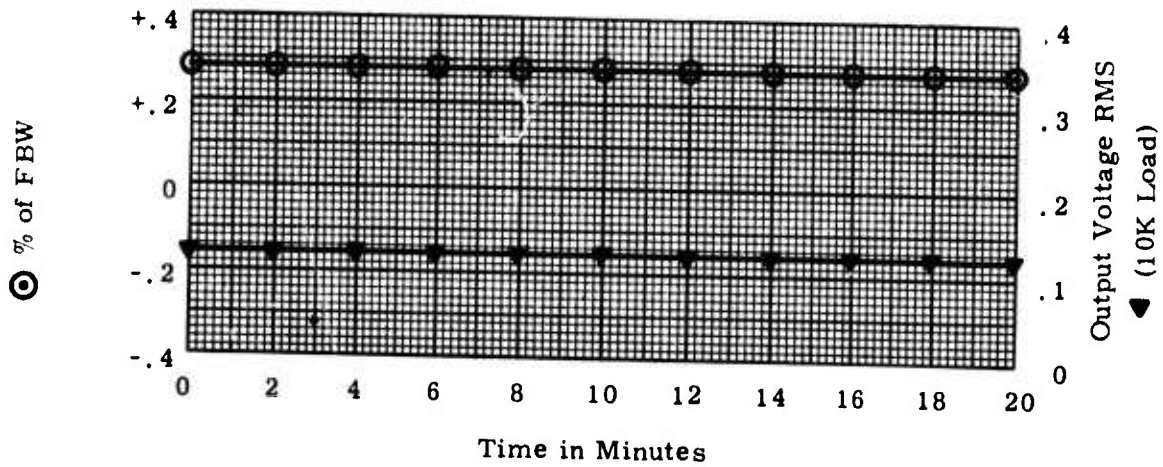

II. Temperature Stability

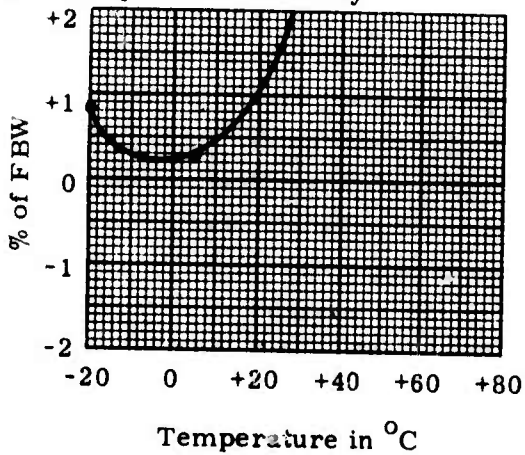

III. Amplitude Modulation

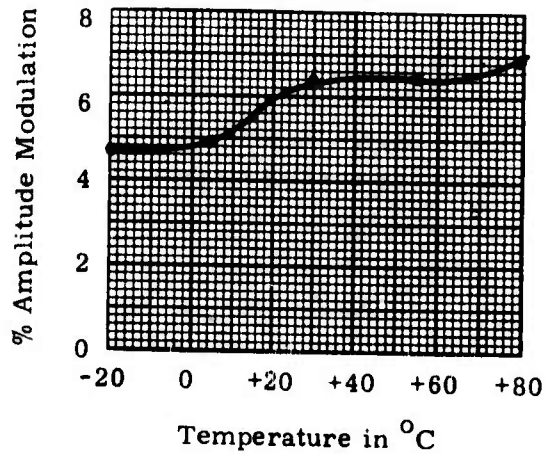

IV. Effects of Source Impedance at Ambient

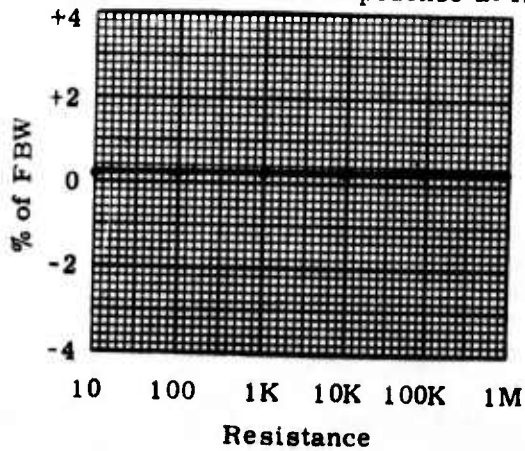

V. B+ Voltage Regulation at Ambient

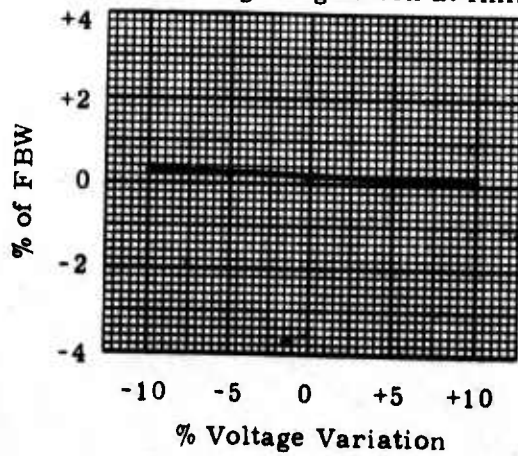

NORTHEASTERN UNIVERSITY

Evaluation Tests - Voltage Controlled Oscillators - Sheet 2

Make: Omnitek ; Type: 40A1 ; Serial Number: 3173 ;
 IRIG Band Number: 18 ; FBW: 10500 Hz; Date: 4/24/75 ; By: PJR

VI. Linearity vs. Temperature

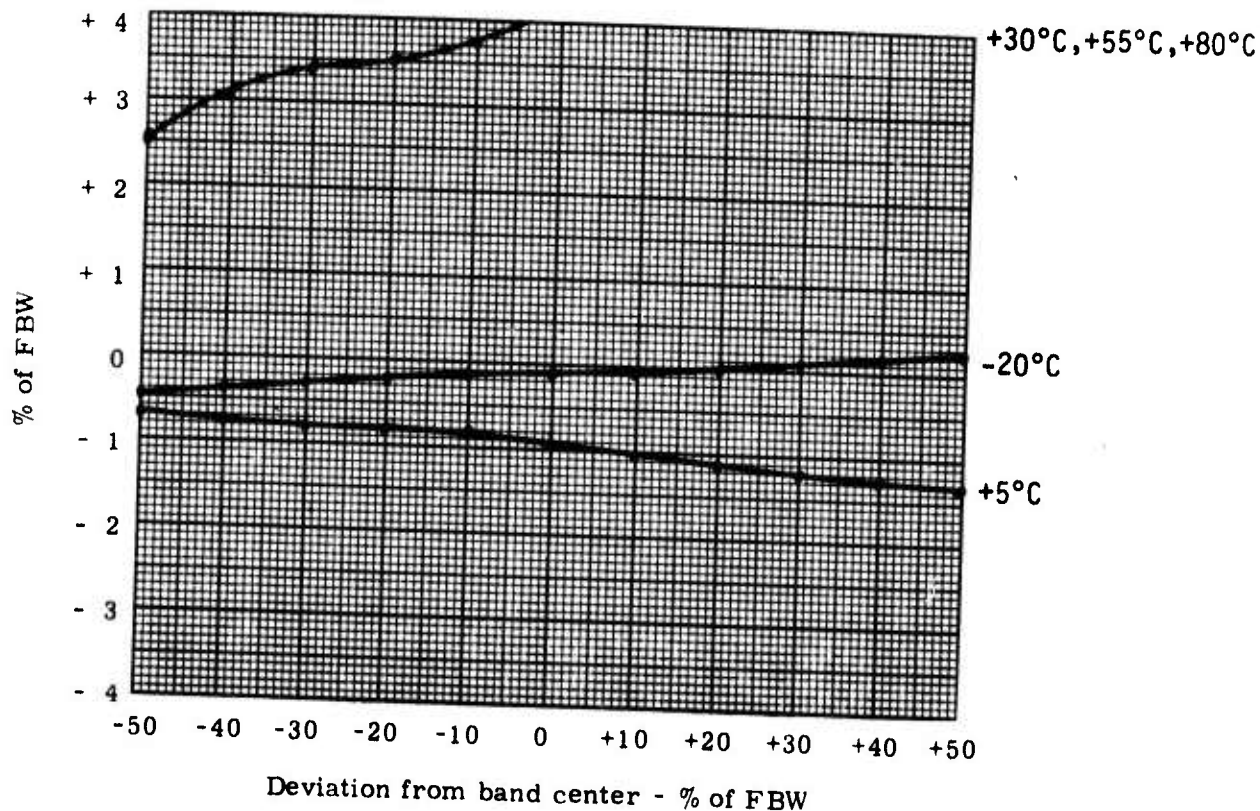

VII. Miscellaneous

1. Power Requirements >3mw
2. Input Impedence >500KΩ
3. Output Impedence <50KΩ
4. Harmonic Distortion .32%
5. Other Checks LINEARITY

-20°C	± 0.04%	from BSL
+5°C	± 0.11%	from BSL
+30°C	± 0.15%	from BSL
+55°C	± 0.10%	from BSL
+80°C	± 0.12%	from BSL

Evaluation Tests - Proprietary Information Sheet

Voltage Controlled Subcarrier Oscillators

Make: Vector;

Type: MMO-11;

Manufacturer's Specifications

<u>Input Voltage</u>	0 to 5 volts or ± 2.5 volts.
<u>Input Impedance</u>	500K ohms minimum.
<u>Available Channels</u>	All IRIG channels.
<u>Source Sensitivity</u>	Changing the source impedance from zero to infinity varies the frequency less than 1.5% of design bandwidth.
<u>Linearity</u>	Less than $\pm 0.25\%$ of design bandwidth for best straight line.
<u>Output Voltage</u>	0.85 volts peak to peak minimum into 10K ohm load.
<u>Drift</u>	Less than $\pm 0.25\%$ of design bandwidth for a period of 8 hours at ambient temperature following a warm-up period of 15 minutes.
<u>Temperature</u>	Output frequency is stable within $\pm 3\%$ of a design bandwidth (based on best reference) for a temperature change of -20°C to $+80^{\circ}\text{C}$.
<u>Power Requirements</u>	28 volts DC $\pm 10\%$ at 5 ma nominal.
<u>Amplitude Modulation</u>	Less than $\pm 5\%$.
<u>Harmonic Distortion</u>	At center frequency less than 0.75%.
<u>Weight</u>	0.134 ounce nominal.
<u>Vibration</u>	Center frequency is stable within $\pm 0.5\%$ of design bandwidth when subjected to 30g RMS vibration from 55 to 2000 Hz in each major axis.
<u>Altitude</u>	With constant temperature and at any altitude from sea level up, center frequency is stable within $\pm 0.5\%$ of design bandwidth.

NORTHEASTERN UNIVERSITY

Evaluation Tests - Voltage Controlled Oscillators - Sheet 1

Make: Vector ; Type: MMO-11 ; Serial Number: 24774
 IRIG Band Number: 18 ; FBW: 10500 Hz ; Date: 5/6/75 ; By: PJR

I. Time Drift

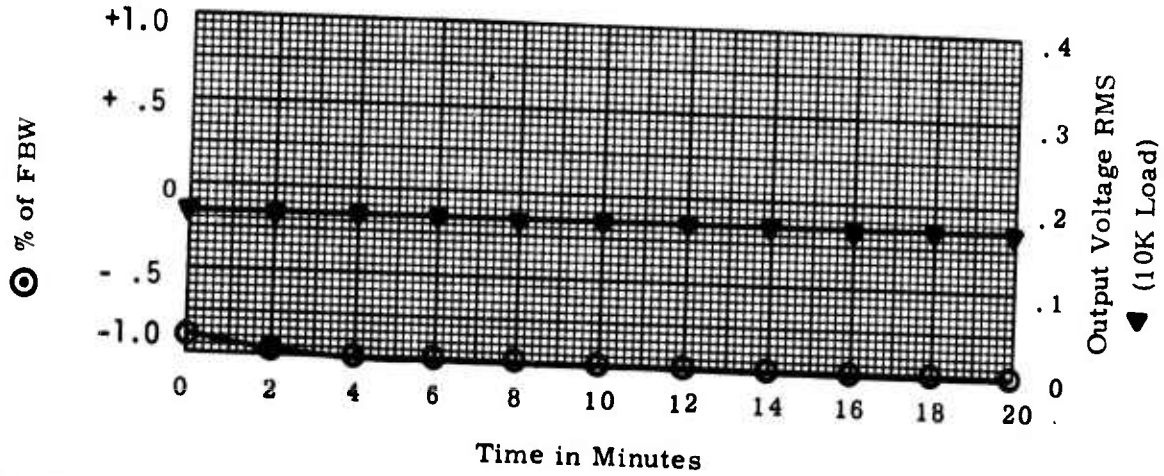

II. Temperature Stability

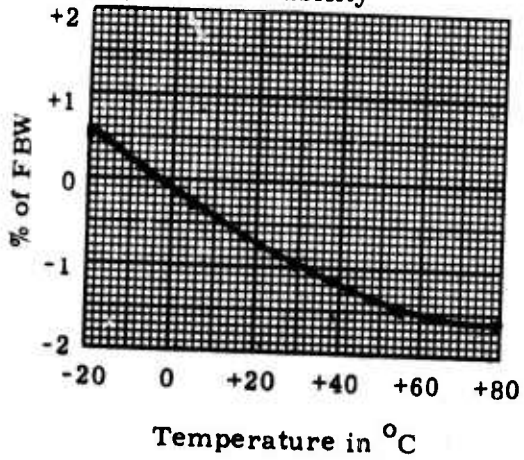

III. Amplitude Modulation

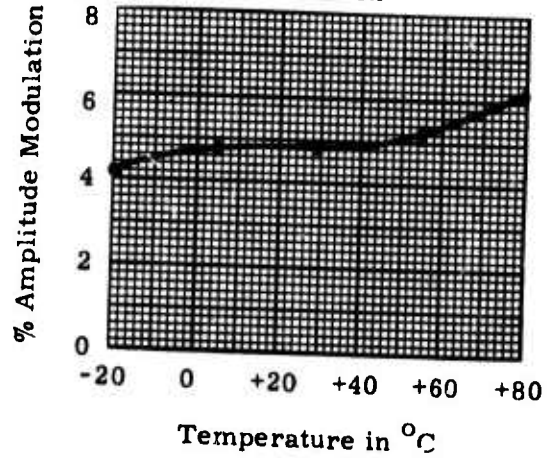

IV. Effects of Source Impedance at Ambient

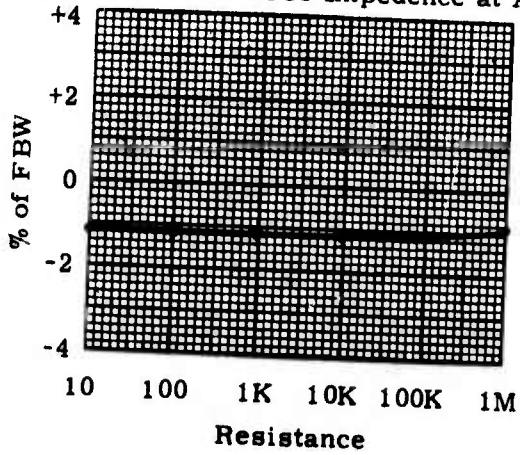

V. B+ Voltage Regulation at Ambient

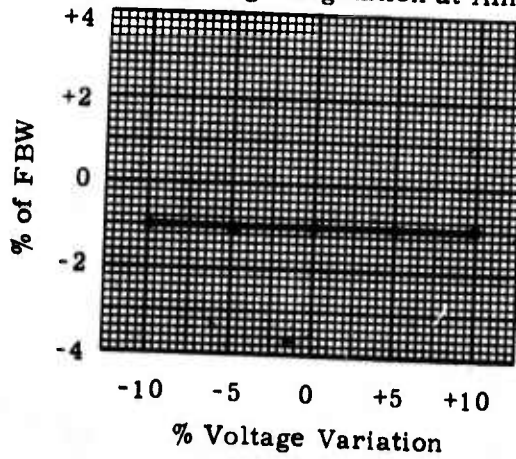

NORTHEASTERN UNIVERSITY

Evaluation Tests - Voltage Controlled Oscillators - Sheet 2

Make: Vector ; Type: MMO-11 ; Serial Number: 24774
 IRIG Band Number: 18 ; FBW: 10500 Hz; Date: 5/6/75 ; By: PJR

VI. Linearity vs. Temperature

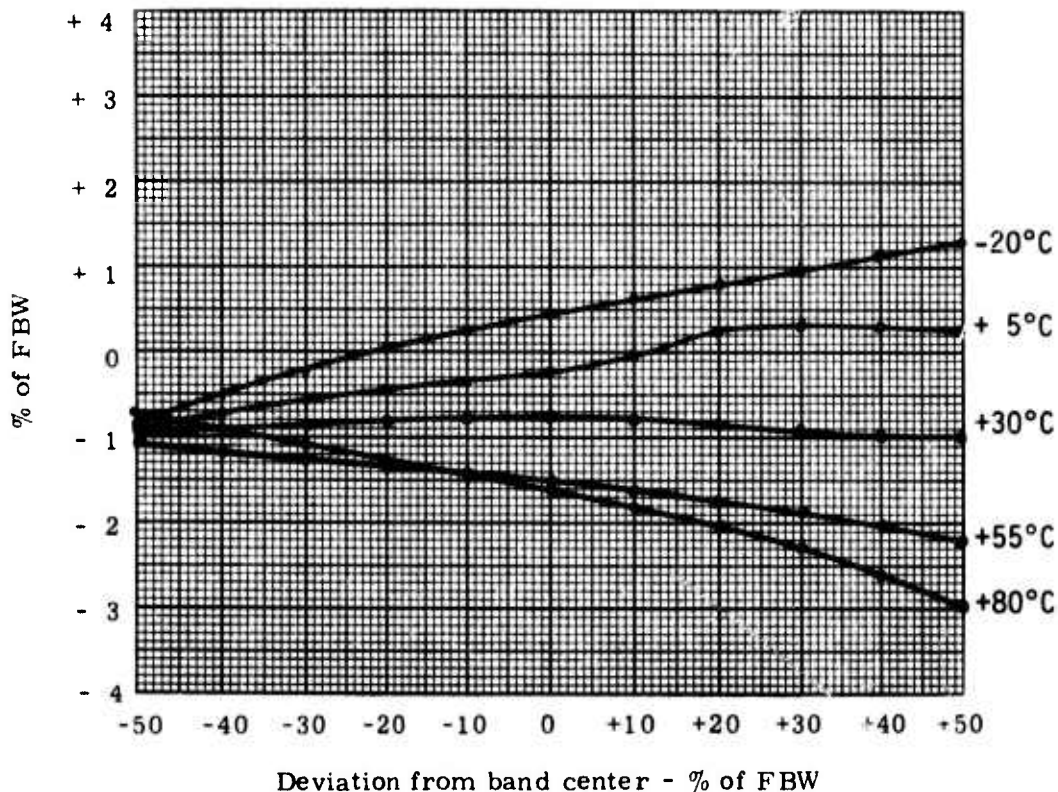

VII. Miscellaneous

1. Power Requirements 185mw
2. Input Impedence >500KΩ
3. Output Impedence <50KΩ
4. Harmonic Distortion .54%
5. Other Checks LINEARITY

-20°C	± 0.12%	from BSL
+5°C	± 0.13%	from BSL
+30°C	± 0.12%	from BSL
+55°C	± 0.09%	from BSL
+80°C	± 0.18%	from BSL

NORTHEASTERN UNIVERSITY

Evaluation Tests - Voltage Controlled Oscillators - Sheet 1

Make: Vector ; Type: MMO-11 ; Serial Number: 32493
 IRIG Band Number: 16 ; FBW: 6000 Hz; Date: 5/2/75 ; By: PJR

I. Time Drift

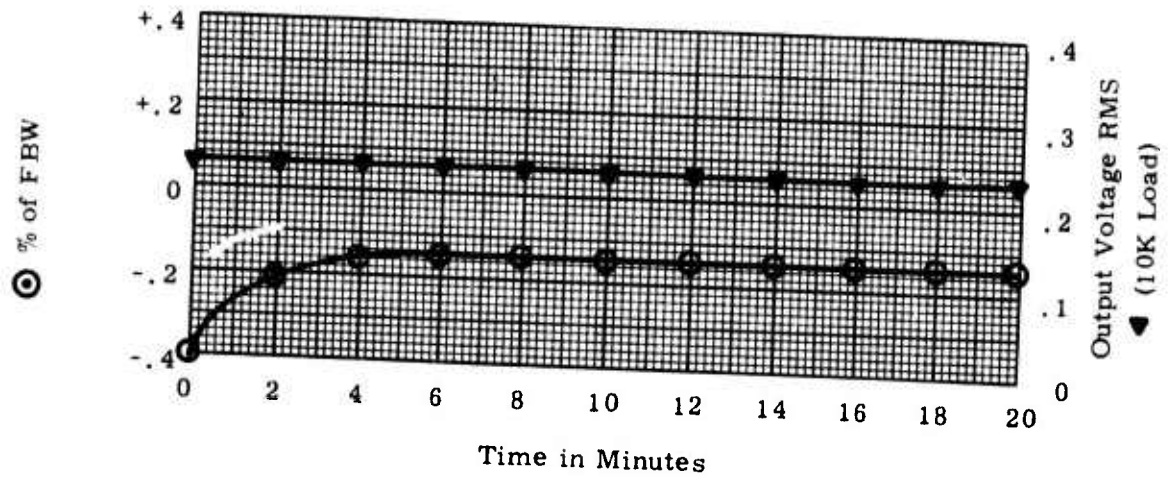

II. Temperature Stability

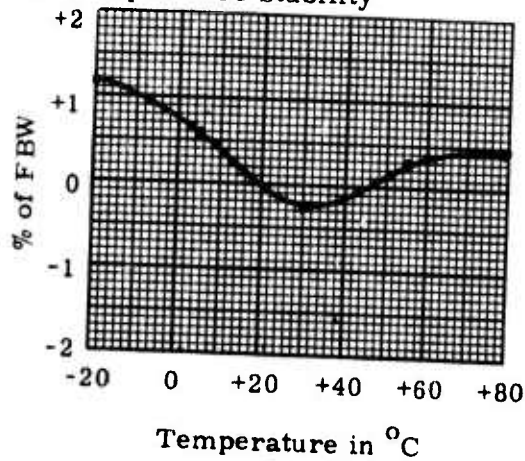

III. Amplitude Modulation

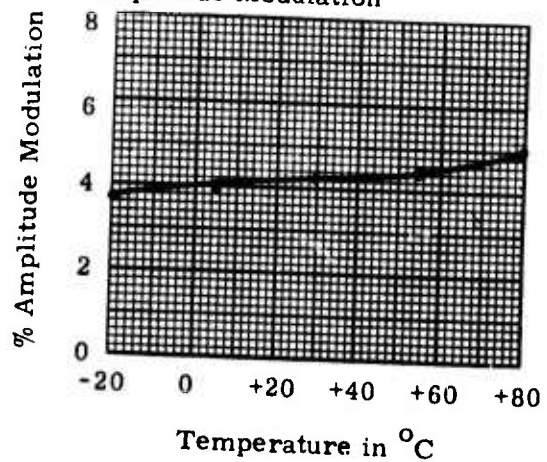

IV. Effects of Source Impedence at Ambient

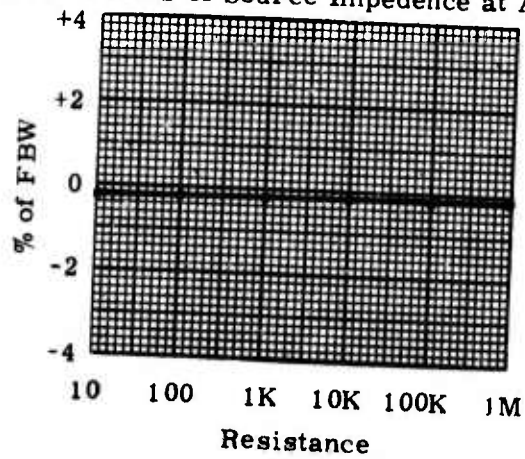

V. B+ Voltage Regulation at Ambient

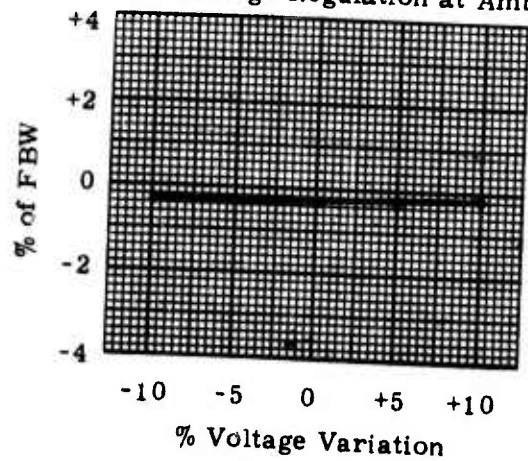

NORTHEASTERN UNIVERSITY

Evaluation Tests - Voltage Controlled Oscillators - Sheet 2

Make: Vector ; Type: MMO-11 ; Serial Number: 32493 ;
 IRIG Band Number: 16 ; FBW: 6000 Hz ; Date: 5/2/75 ; By: PJR ;

VI. Linearity vs. Temperature

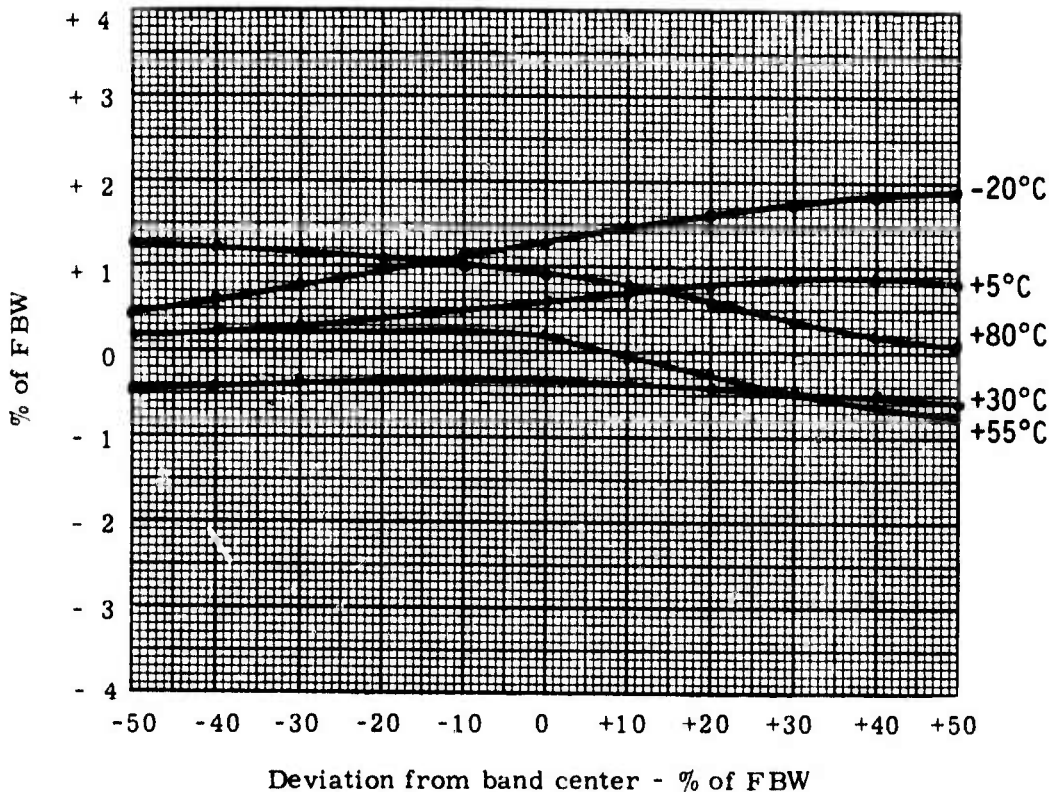

VII. Miscellaneous

1. Power Requirements 173mw
2. Input Impedence >500KΩ
3. Output Impedence <50KΩ
4. Harmonic Distortion .26%
5. Other Checks LINEARITY

-20°C	±	0.09%	from BSL
+5°C	±	0.05%	from BSL
+30°C	±	0.09%	from BSL
+55°C	±	0.2%	from BSL
+80°C	±	0.06%	from BSL

NORTHEASTERN UNIVERSITY

Evaluation Tests - Voltage Controlled Oscillators - Sheet 1

Make: Vector; Type: MMO-11; Serial Number: 51409
 IRIG Band Number: 12; FBW: 1576 Hz; Date: 5/2/75; By: PJR

I. Time Drift

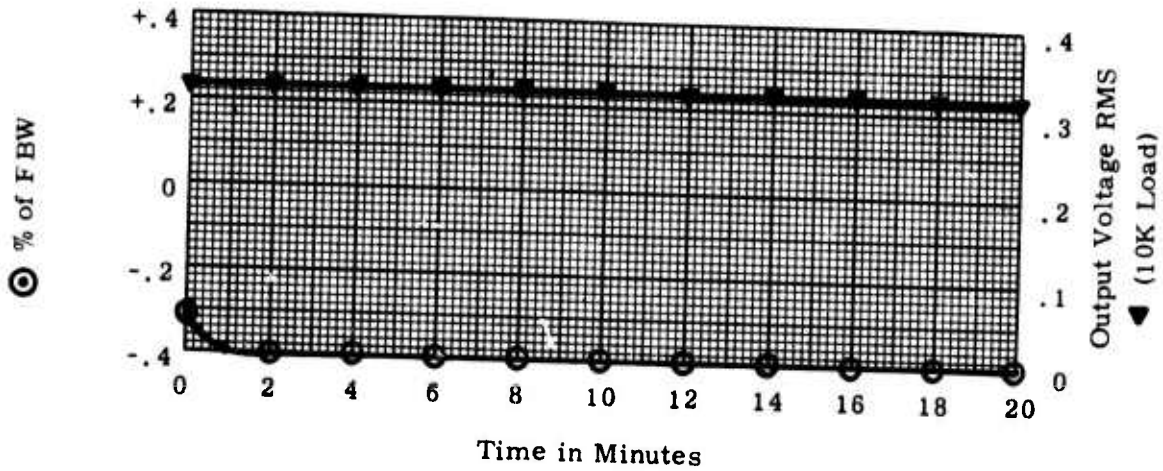

II. Temperature Stability

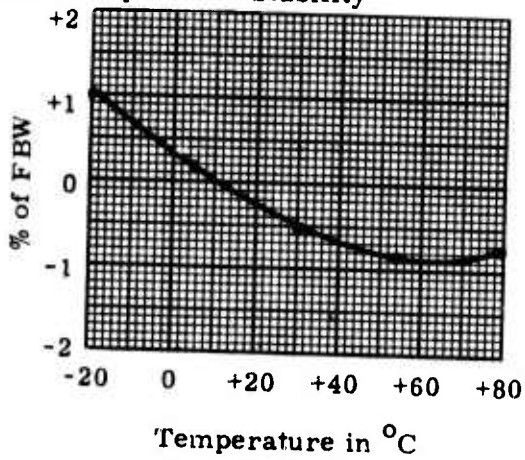

III. Amplitude Modulation

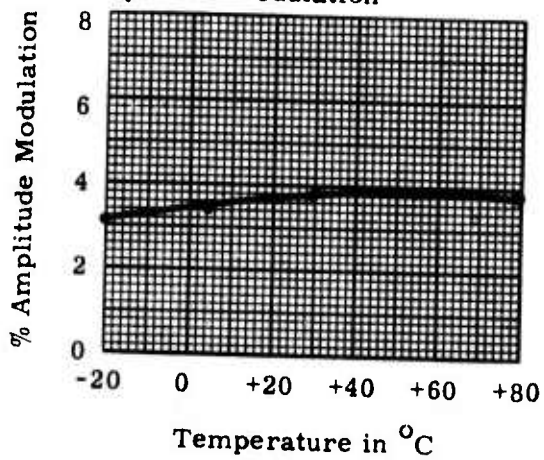

IV. Effects of Source Impedance at Ambient

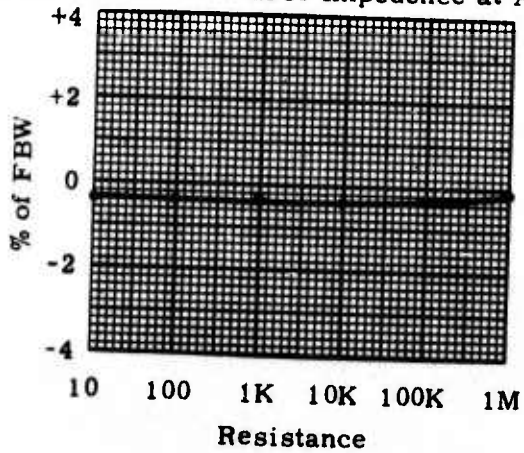

V. B+ Voltage Regulation at Ambient

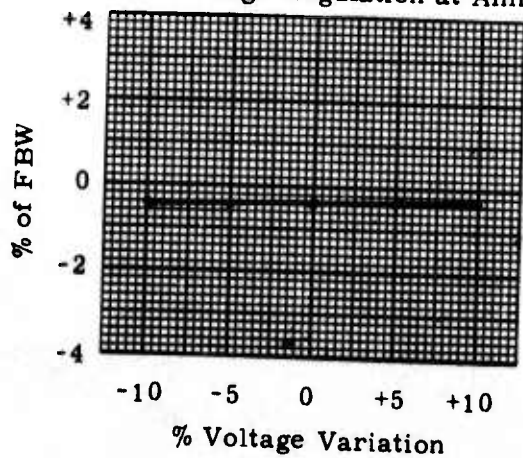

NORTHEASTERN UNIVERSITY

Evaluation Tests - Voltage Controlled Oscillators - Sheet 2

Make: Vector ; Type: MMO-11 ; Serial Number: 51409
 IRIG Band Number: 12 ; FBW: 1576 Hz; Date: 5/2/75 ; By: PJR

VI. Linearity vs. Temperature

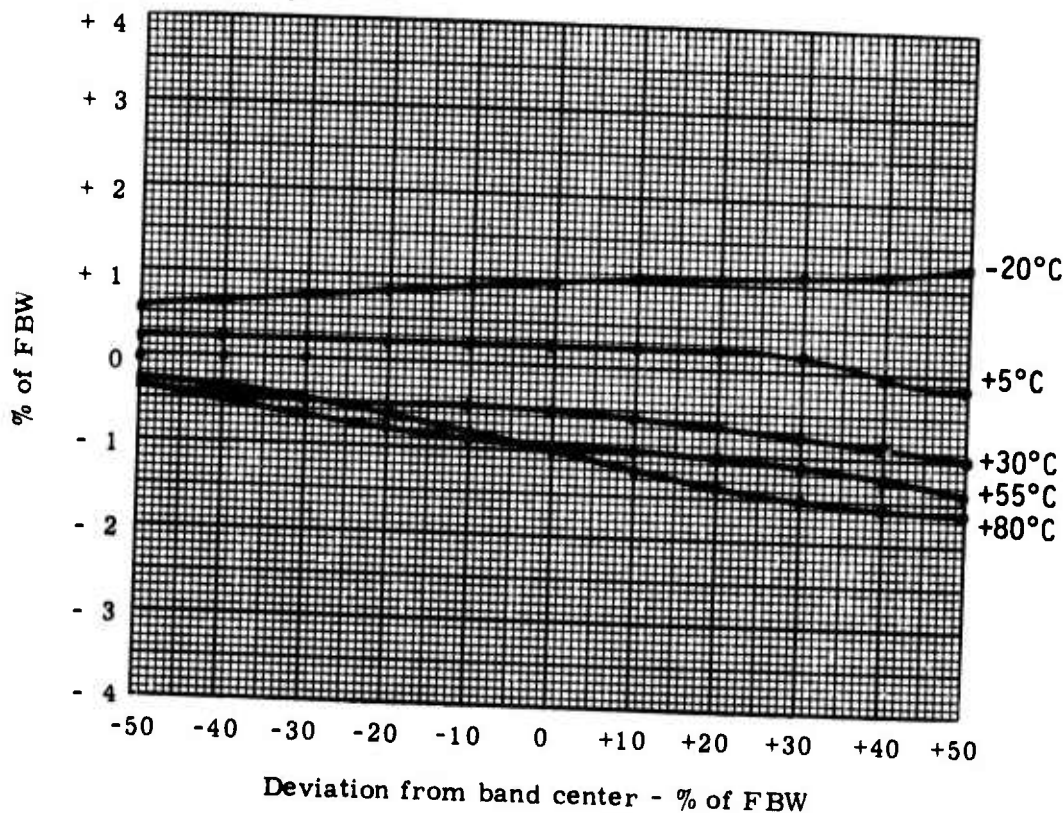

VII. Miscellaneous

1. Power Requirements 173mw
2. Input Impedence >500KΩ
3. Output Impedence <50KΩ
4. Harmonic Distortion .34%
5. Other Checks LINEARITY

-20°C	± 0.05%	from BSL
+5°C	± 0.05%	from BSL
+30°C	± 0.12%	from BSL
+55°C	± 0.07%	from BSL
+80°C	± 0.05%	from BSL

NORTHEASTERN UNIVERSITY

Evaluation Tests - Voltage Controlled Oscillators - Sheet 1

Make: Vector ; Type: MMO-11 ; Serial Number: 51432 ;
 IRIG Band Number: 12 ; FBW: 1576 Hz; Date: 5/2/75 ; By: PJR ;

I. Time Drift

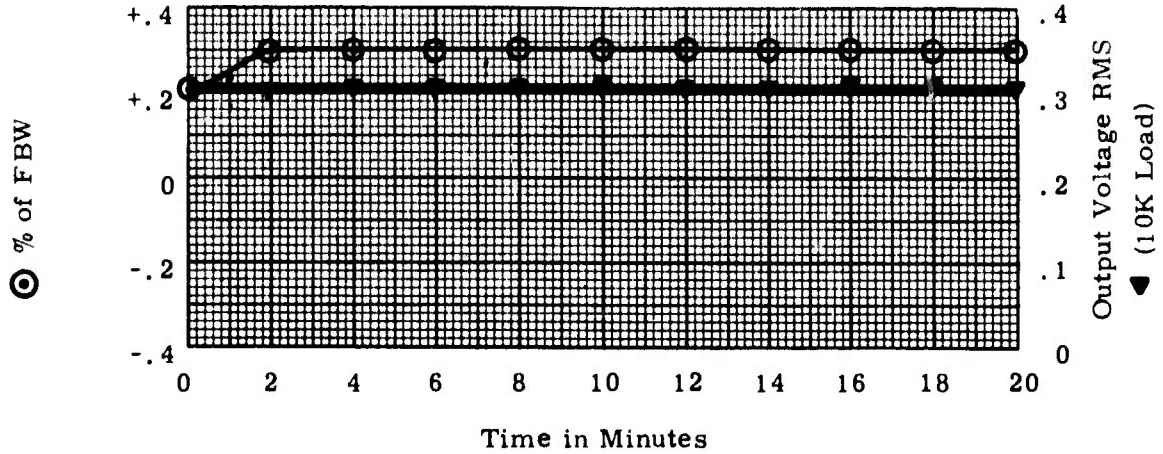

II. Temperature Stability

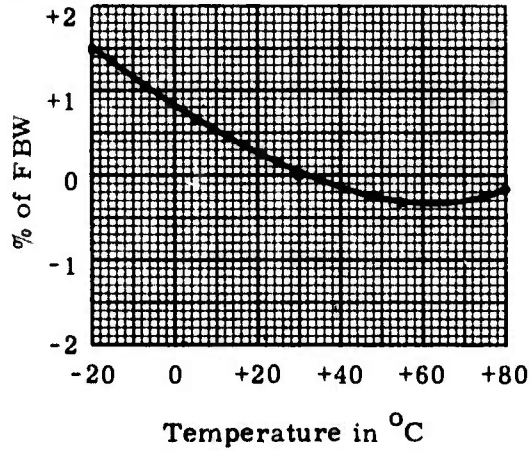

III. Amplitude Modulation

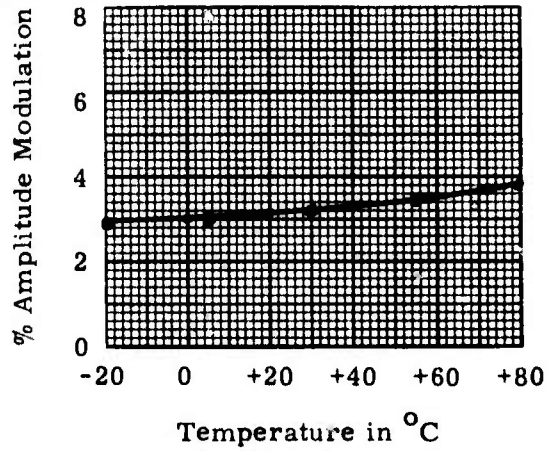

IV. Effects of Source Impedence at Ambient

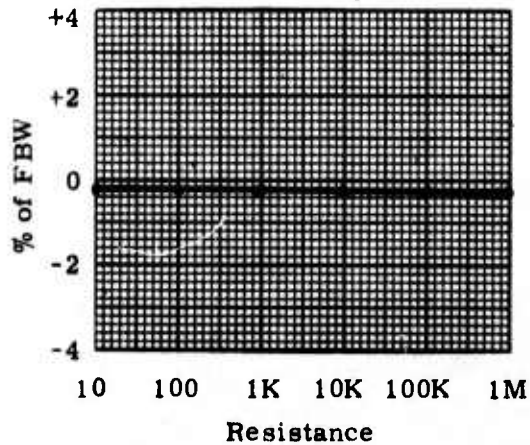

V. B+ Voltage Regulation at Ambient

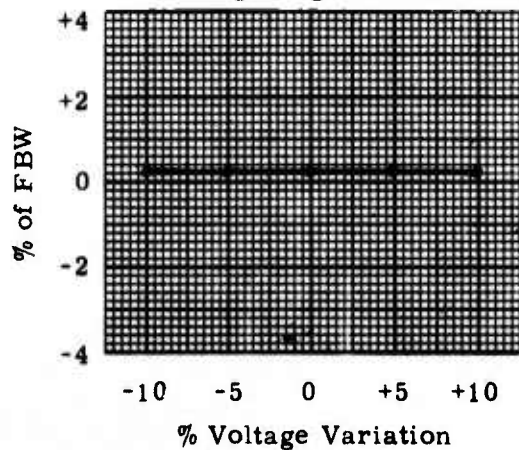

NORTHEASTERN UNIVERSITY

Evaluation Tests - Voltage Controlled Oscillators - Sheet 2

Make: Vector ; Type: MMO-11 ; Serial Number: 51432 ;
 IRIG Band Number: 12 ; FBW: 1576 Hz ; Date: 5/2/75 ; By: PJR ;

VI. Linearity vs. Temperature

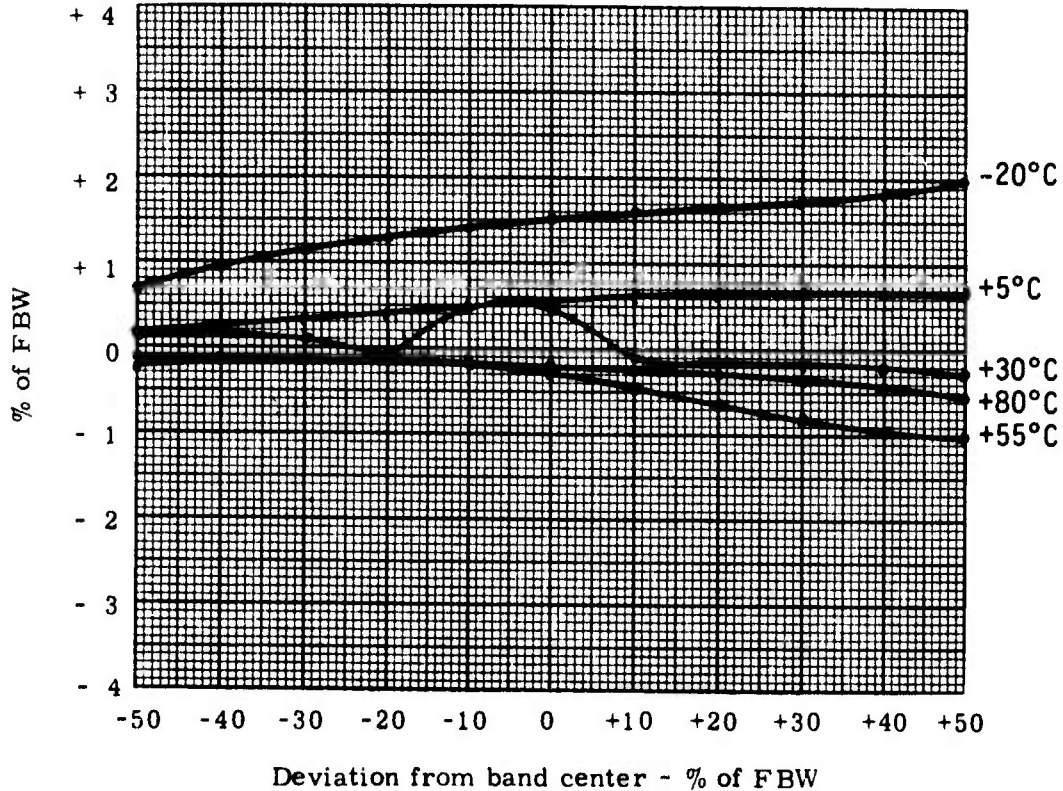

VII. Miscellaneous

1. Power Requirements 176 mw
2. Input Impedence >500KΩ
3. Output Impedence <50KΩ
4. Harmonic Distortion .52%
5. Other Checks LINEARITY

-20°C	±	0.10	from BSL
+5°C	±	0.06	from BSL
+30°C	±	0.30	from BSL
+55°C	±	0.10	from BSL
+80°C	±	0.13	from BSL

NORTHEASTERN UNIVERSITY

Evaluation Tests - Voltage Controlled Oscillators - Sheet 1

Make: Vector ; Type: MMO-11 ; Serial Number: 51491 ;
 IRIG Band Number: 14 ; FBW: 3300 Hz; Date: 5/2/75 ; By: PJR ;

I. Time Drift

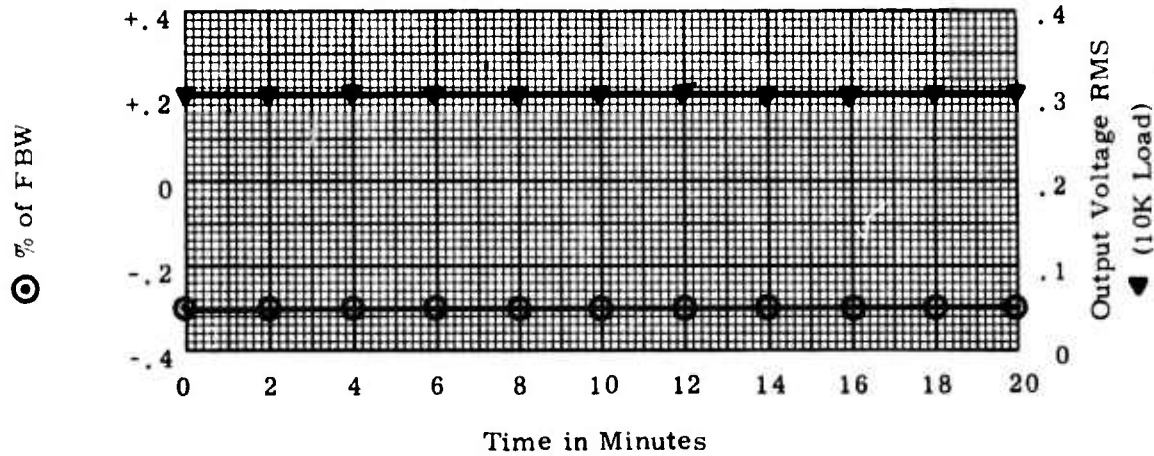

II. Temperature Stability

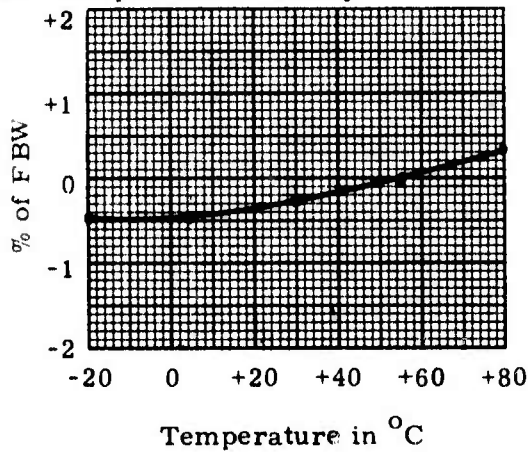

III. Amplitude Modulation

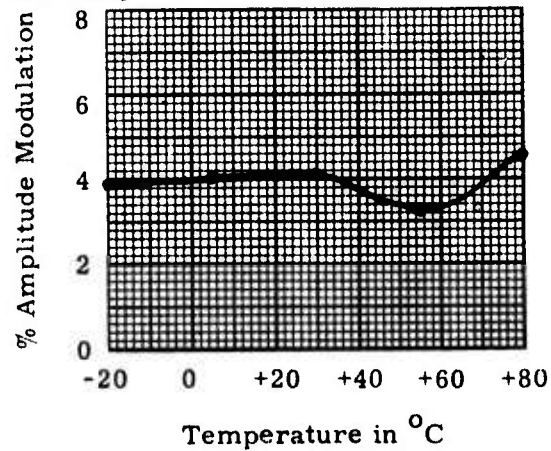

IV. Effects of Source Impedance at Ambient

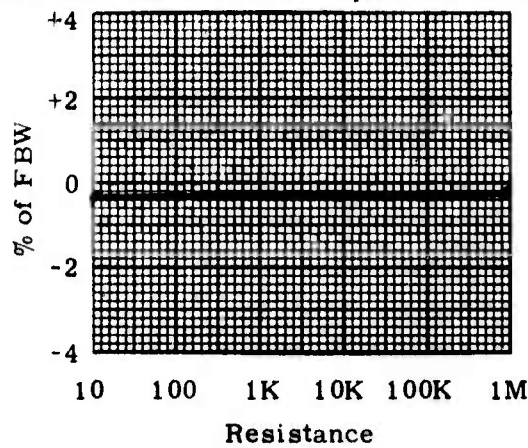

V. B+ Voltage Regulation at Ambient

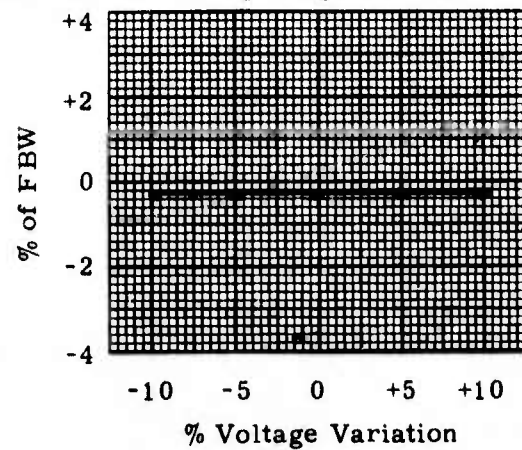

NORTHEASTERN UNIVERSITY

Evaluation Tests - Voltage Controlled Oscillators - Sheet 2

Make: Vector ; Type: MMO-11 ; Serial Number: 51491 ;
 IRIG Band Number: 14 ; FBW: 3300 Hz ; Date: 5/2/75 ; By: PJR ;

VI. Linearity vs. Temperature

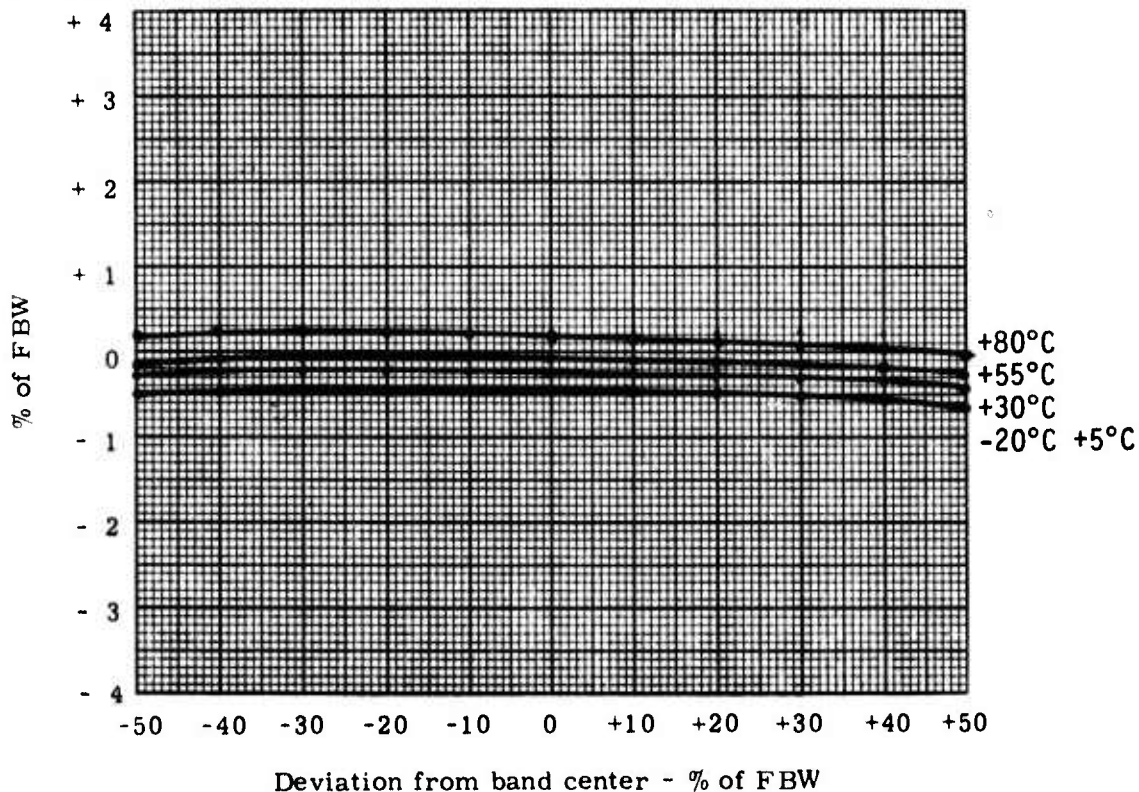

VII. Miscellaneous

1. Power Requirements 173
2. Input Impedence >500KΩ
3. Output Impedence <50KΩ
4. Harmonic Distortion .45%
5. Other Checks LINEARITY

-20°C	±	0.06%	from BSL
+5°C	±	0.09%	from BSL
+30°C	±	0.07%	from BSL
+55°C	±	0.06%	from BSL
+80°C	±	0.10%	from BSL

NORTHEASTERN UNIVERSITY

Evaluation Tests - Voltage Controlled Oscillators - Sheet 1

Make: Vector ; Type: MMO-11 ; Serial Number: 51518 ;
 IRIG Band Number: 14 ; FBW: 3300 Hz ; Date: 5/2/75 ; By: PJR ;

I. Time Drift

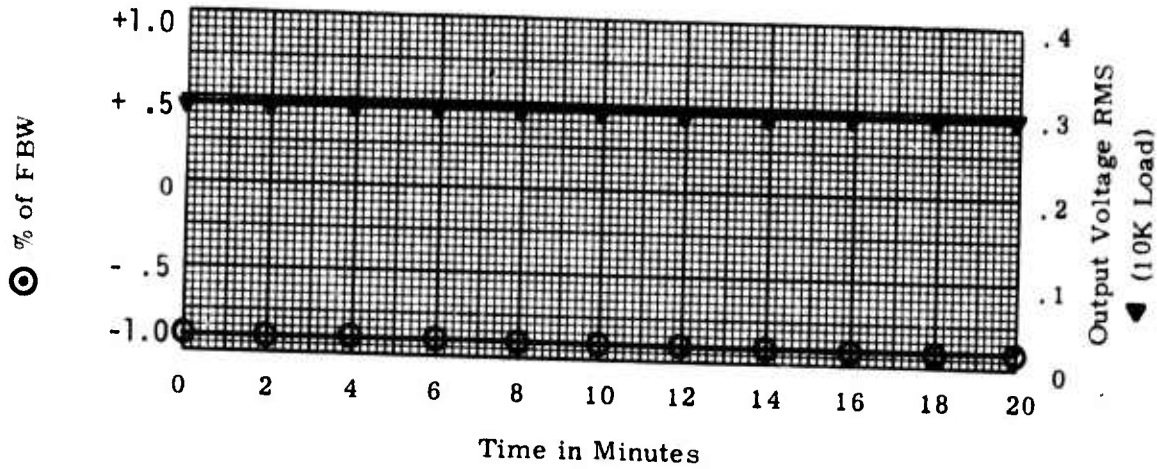

II. Temperature Stability

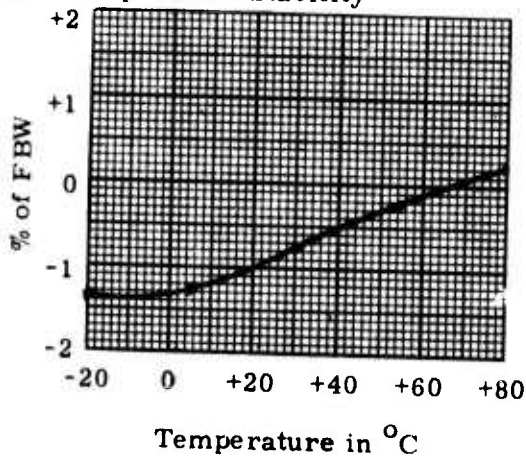

III. Amplitude Modulation

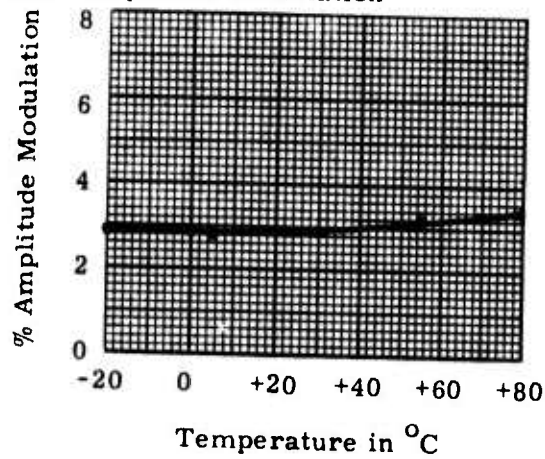

IV. Effects of Source Impedance at Ambient

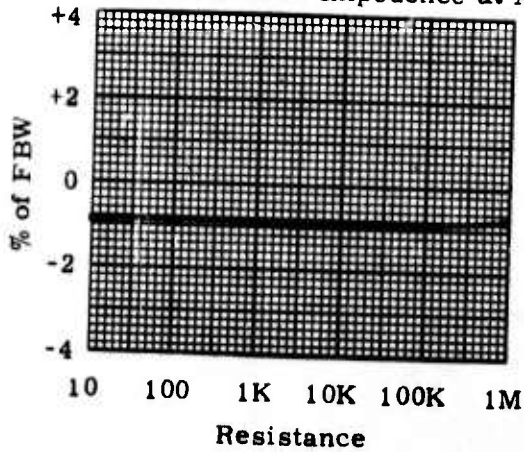

V. B+ Voltage Regulation at Ambient

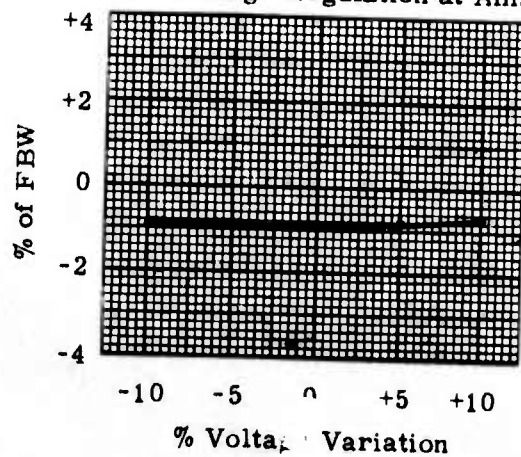

NORTHEASTERN UNIVERSITY

Evaluation Tests - Voltage Controlled Oscillators - Sheet 2

Make: Vector ; Type: MMO-11 ; Serial Number: 51518 ;
 IRIG Band Number: 14 ; FBW: 3300 Hz; Date: 5/2/75 ; By: PJR

VI. Linearity vs. Temperature

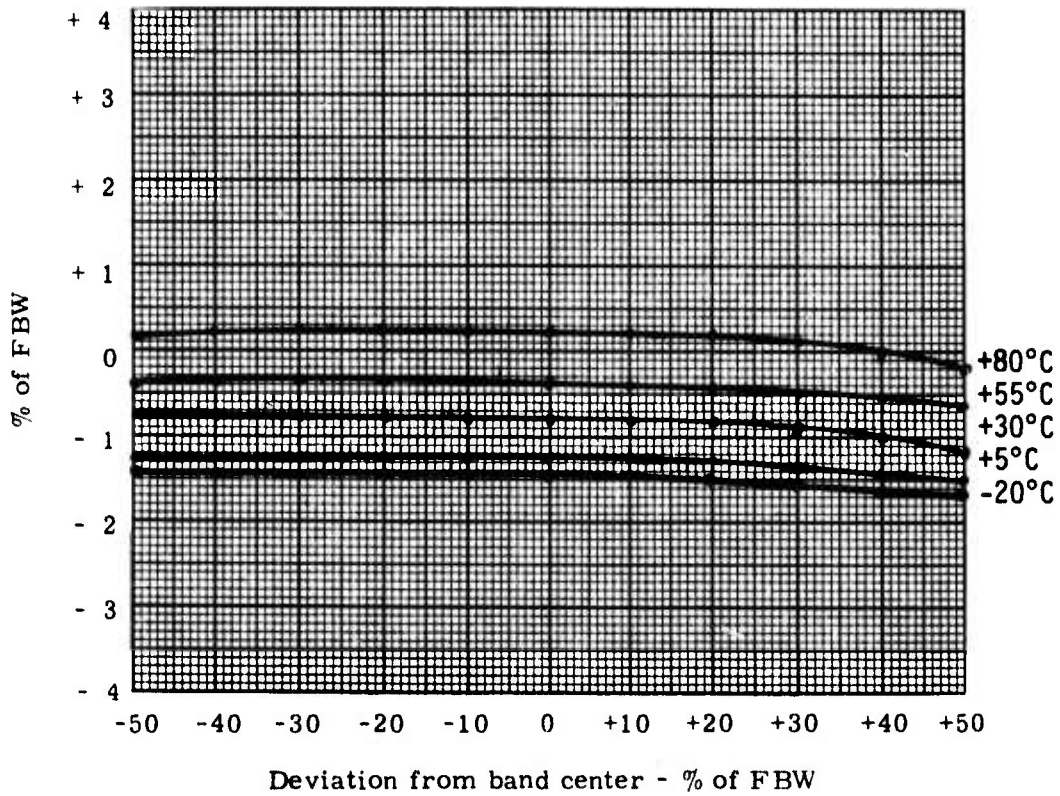

VII. Miscellaneous

1. Power Requirements 157 mw
2. Input Impedence >500KΩ
3. Output Impedence <50KΩ
4. Harmonic Distortion .21%
5. Other Checks LINEARITY

-20°C	± 0.06%	from BSL
+5°C	± 0.06%	from BSL
+30°C	± 0.06%	from BSL
+55°C	± 0.07%	from BSL
+80°C	± 0.19%	from BSL

NORTHEASTERN UNIVERSITY

Evaluation Tests - Voltage Controlled Oscillators - Sheet 1

Make: Vector ; Type: MMO-11 ; Serial Number: 51661 ;
 IRIG Band Number: 16 ; FBW: 6000 Hz; Date: 5/2/75 ; By: PJR ;

I. Time Drift

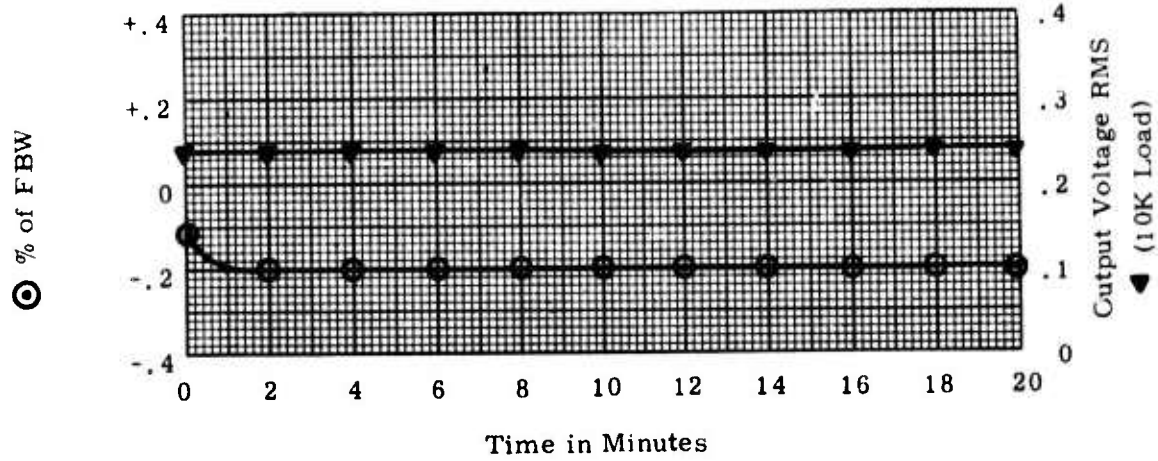

II. Temperature Stability

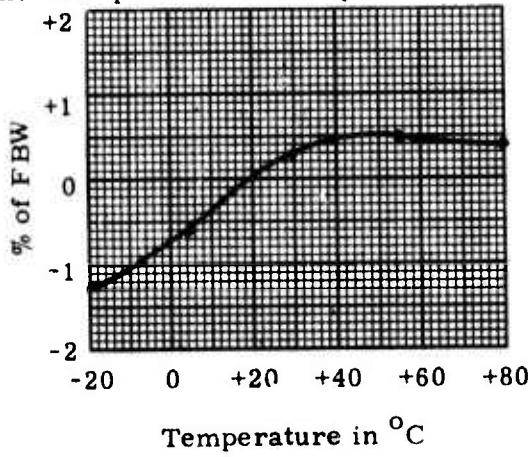

III. Amplitude Modulation

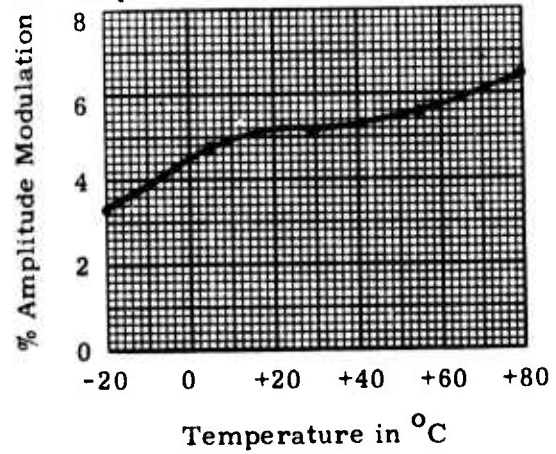

IV. Effects of Source Impedence at Ambient

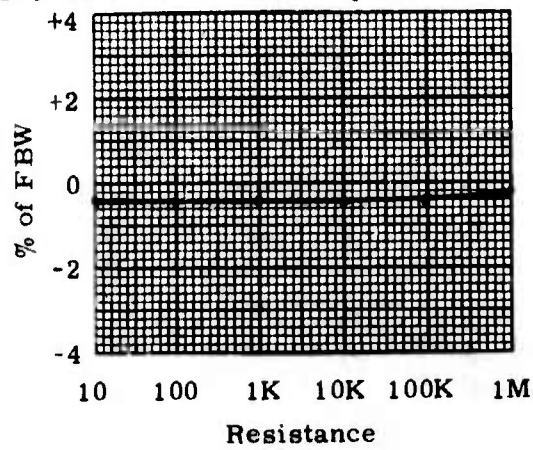

V. B+ Voltage Regulation at Ambient

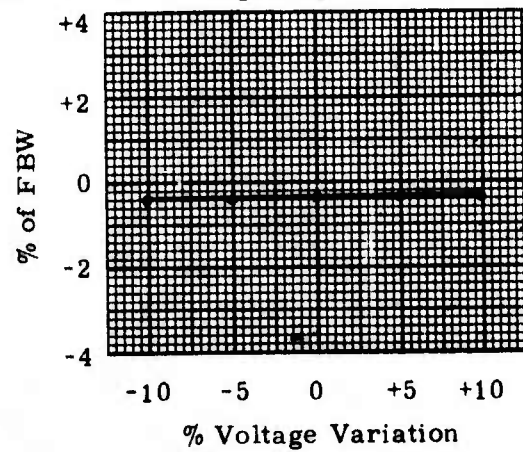

NORTHEASTERN UNIVERSITY

Evaluation Tests - Voltage Controlled Oscillators - Sheet 2

Make: Vector ; Type: MMO-11 ; Serial Number: 51661 ;
 IRIG Band Number: 16 ; FBW: 6000 Hz ; Date: 5/2/75 ; By: PJR ;

VI. Linearity vs. Temperature

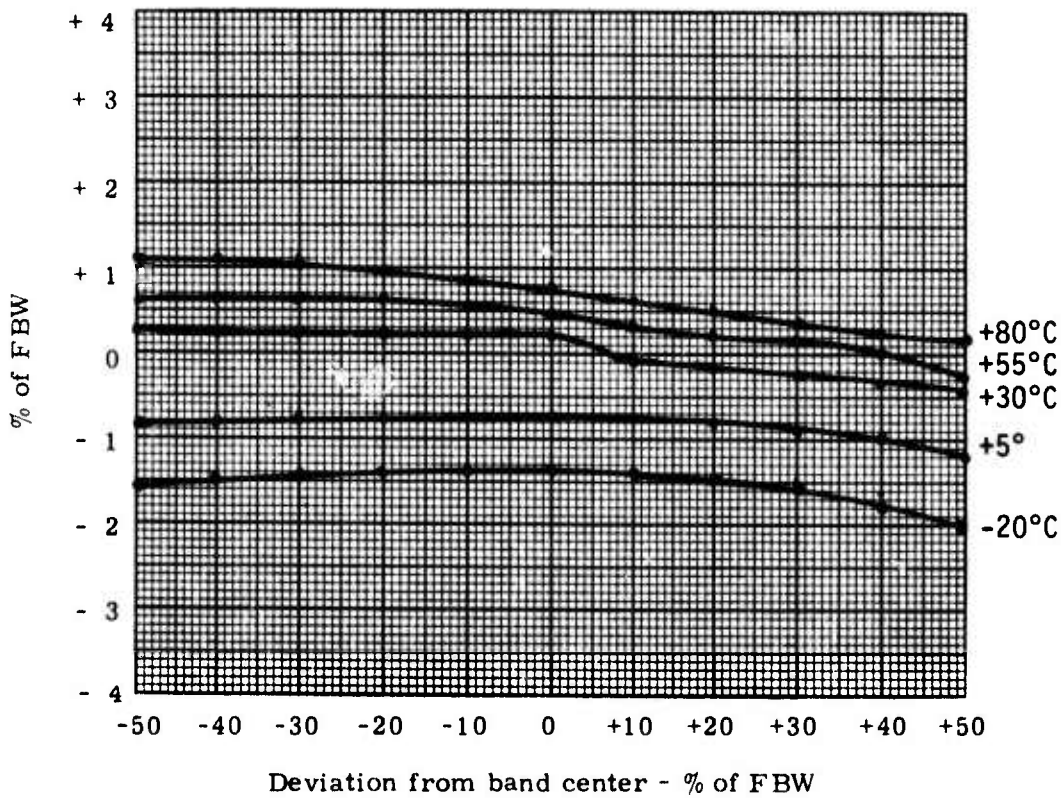

VII. Miscellaneous

1. Power Requirements 168mw
2. Input Impedence >500KΩ
3. Output Impedence <50KΩ
4. Harmonic Distortion .46
5. Other Checks LINEARITY

-20°C	± 0.20	from BSL
+5°C	± 0.09	from BSL
+30°C	± 0.15	from BSL
+55°C	± 0.15	from BSL
+80°C	± 0.11	from BSL

NORTHEASTERN UNIVERSITY

Evaluation Tests - Voltage Controlled Oscillators - Sheet 1

Make: Vector ; Type: MMO-11 ; Serial Number: 51940 ;
 IRIG Band Number: 15 ; FBW: 4500 Hz; Date: 5/6/75 ; By: PJR ;

I. Time Drift

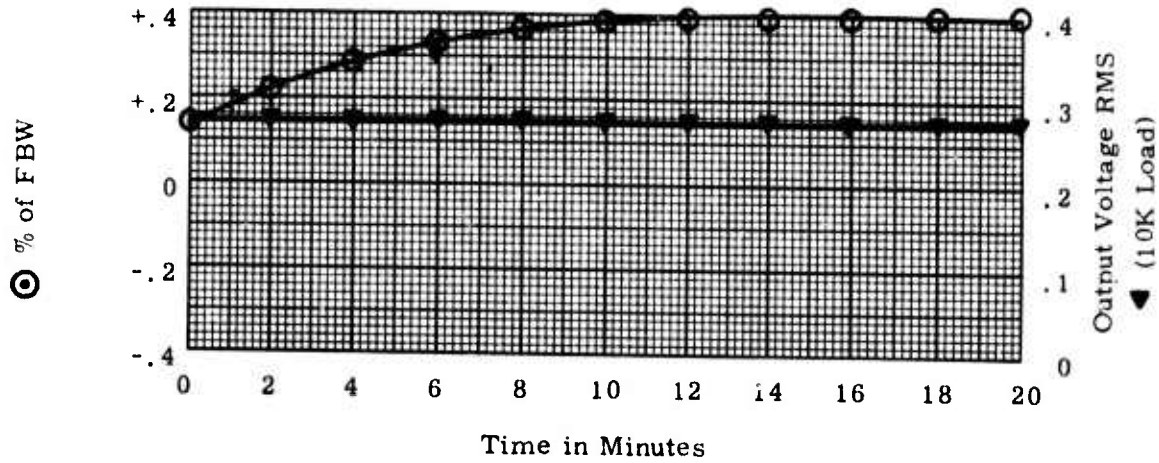

II. Temperature Stability

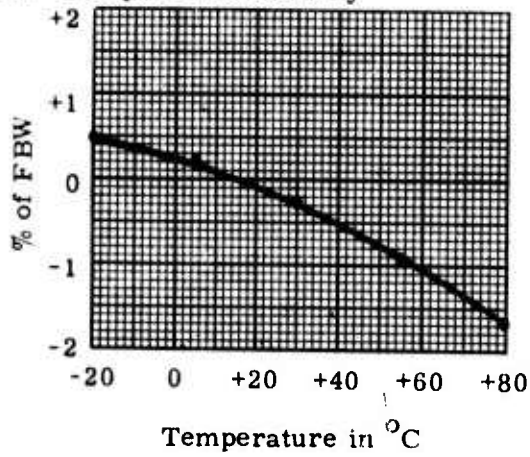

III. Amplitude Modulation

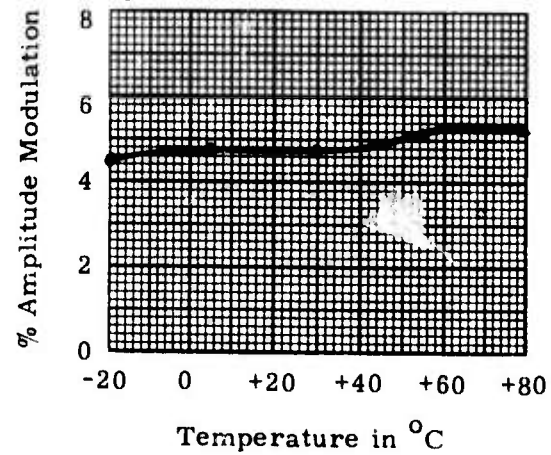

IV. Effects of Source Impedance at Ambient

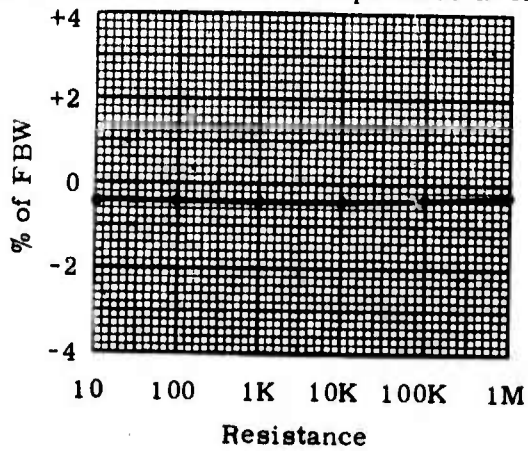

V. B+ Voltage Regulation at Ambient

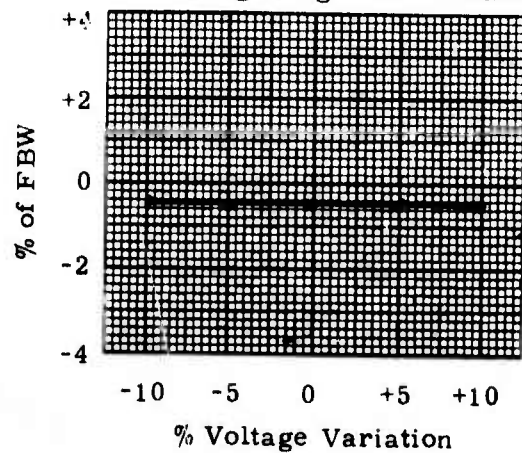

NORTHEASTERN UNIVERSITY

Evaluation Tests - Voltage Controlled Oscillators - Sheet 2

Make: Vector ; Type: MMO-11 ; Serial Number: 51940 ;
 IRIG Band Number: 15 ; FBW: 4500 Hz; Date: 5/6/75 ; By: PJR ;

VI. Linearity vs. Temperature

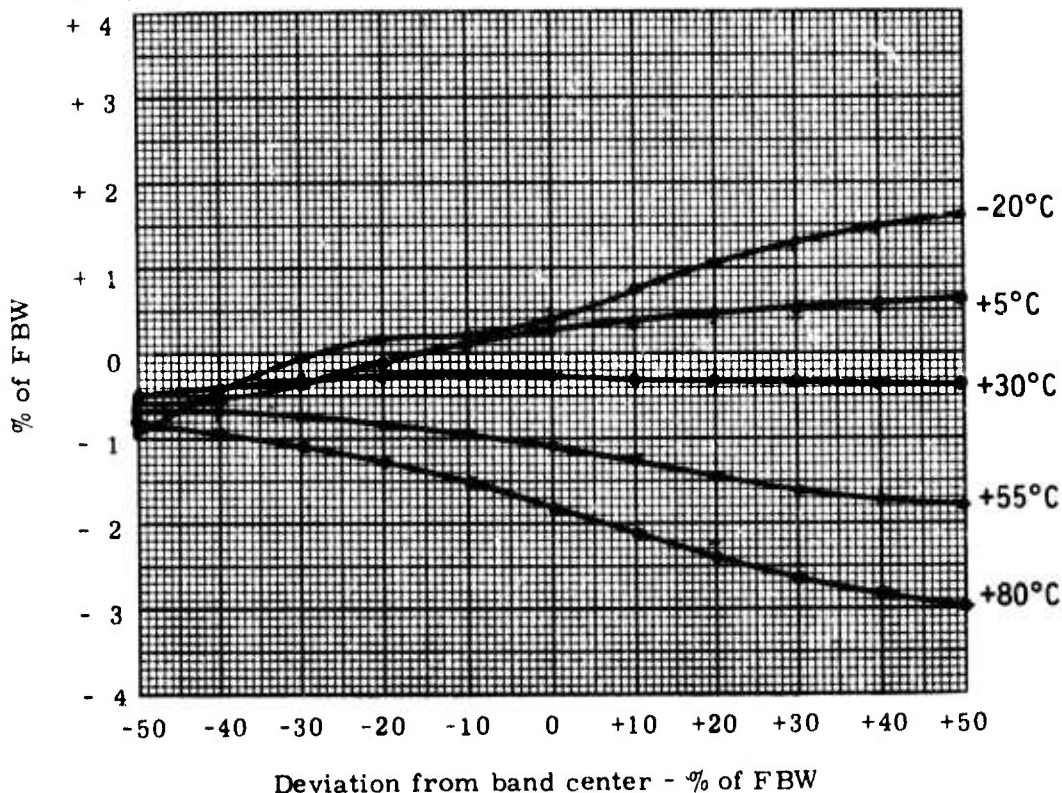

VII. Miscellaneous

1. Power Requirements 173mW
2. Input Impedence >500KΩ
3. Output Impedence <50KΩ
4. Harmonic Distortion .35%
5. Other Checks LINEARITY

-20°C	±	0.10%	from BSL
+5°C	±	0.10%	from BSL
+30°C	±	0.08%	from BSL
+55°C	±	0.06%	from BSL
+80°C	±	0.09%	from BSL

NORTHEASTERN UNIVERSITY

Evaluation Tests - Voltage Controlled Oscillators - Sheet 1

Make: Vector ; Type: MMO-11 ; Serial Number: 51954 ;
 IRIG Band Number: 15 ; FBW: 4500 Hz; Date: 5/6/75 ; By: PJR ;

I. Time Drift

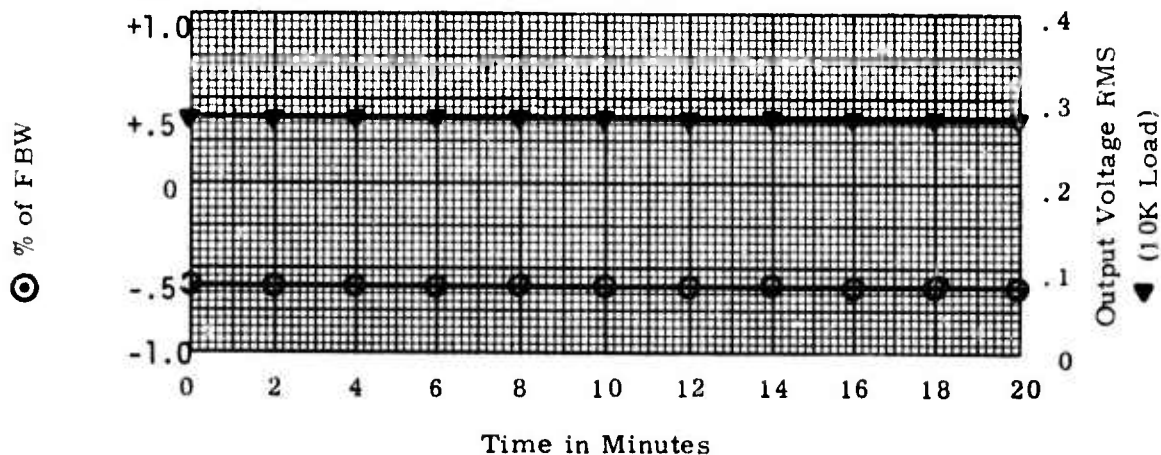

II. Temperature Stability

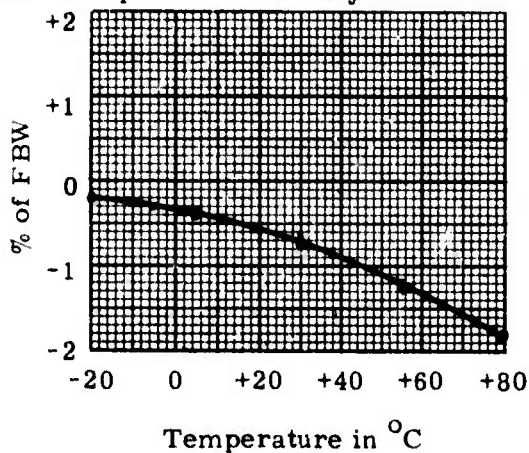

III. Amplitude Modulation

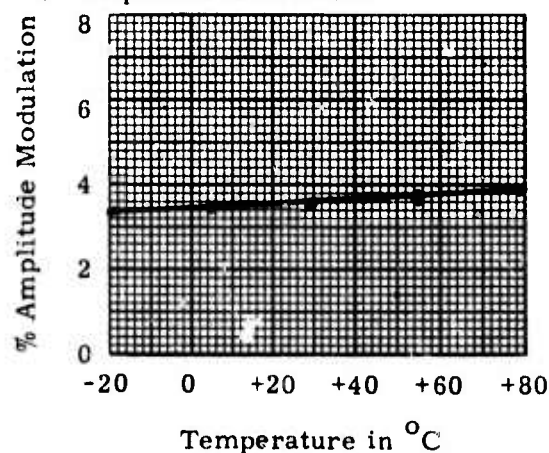

IV. Effects of Source Impedence at Ambient

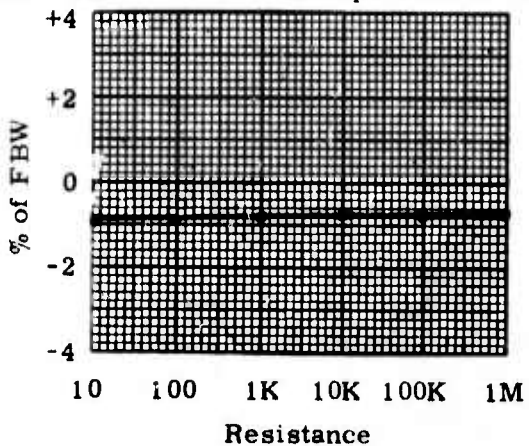

V. B+ Voltage Regulation at Ambient

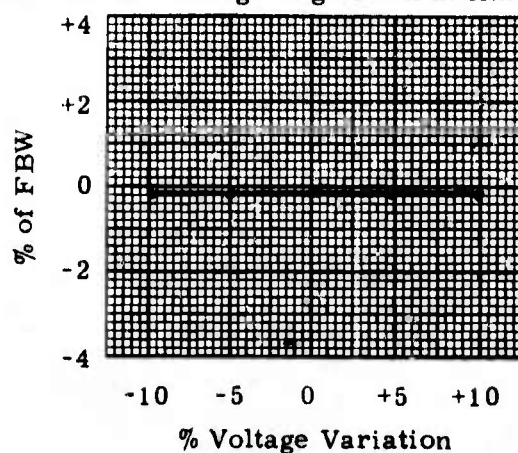

NORTHEASTERN UNIVERSITY

Evaluation Tests - Voltage Controlled Oscillators - Sheet 2

Make: Vector ; Type: MMO-11 ; Serial Number: 51954 ;
 IRIG Band Number: 15 ; FBW: 4500 Hz ; Date: 5/6/75 ; By: PJR ;

VI. Linearity vs. Temperature

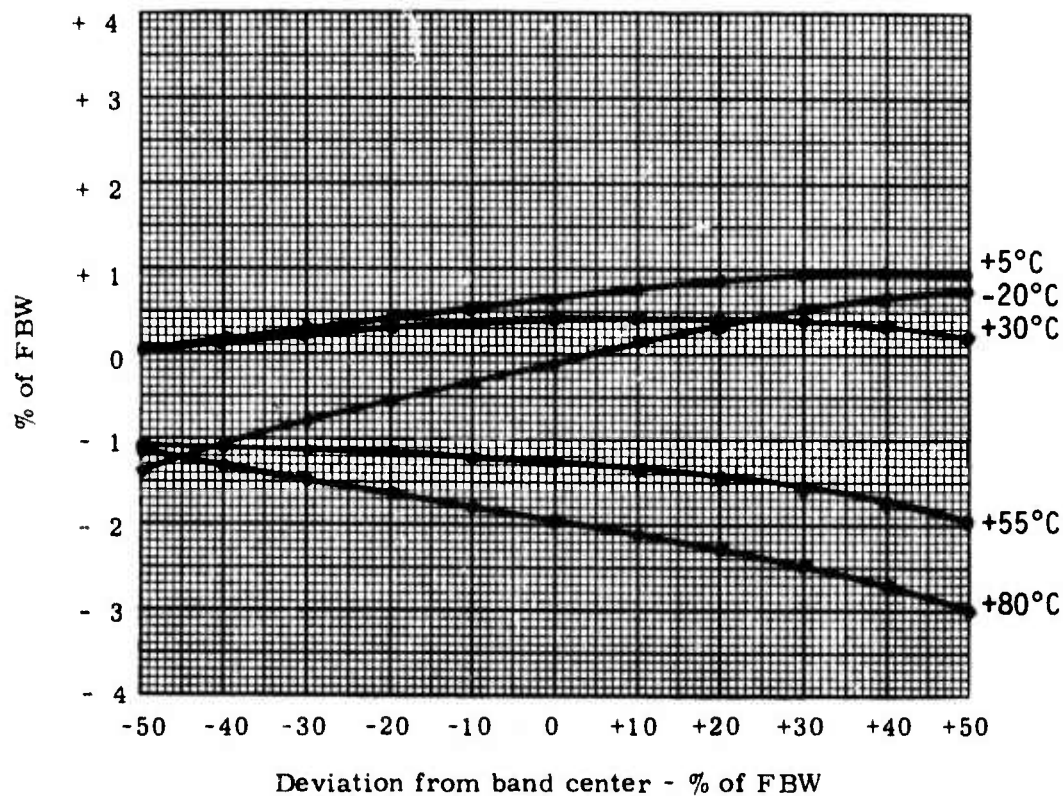

VII. Miscellaneous

1. Power Requirements 179 mw
2. Input Impedence >500KΩ
3. Output Impedence <50KΩ
4. Harmonic Distortion .68%
5. Other Checks LINEARITY

-20°C	±	0.19%	from BSL
+5°C	±	0.09%	from BSL
+30°C	±	0.11%	from BSL
+55°C	±	0.06%	from BSL
+80°C	±	0.05%	from BSL

NORTHEASTERN UNIVERSITY

Evaluation Tests - Voltage Controlled Oscillators - Sheet 1

Make: Vector ; Type: MMO-11 ; Serial Number: 52377 ;
 IRIG Band Number: 13 ; FBW: 2176 Hz; Date: 5/6/75 ; By: PJR ;

I. Time Drift

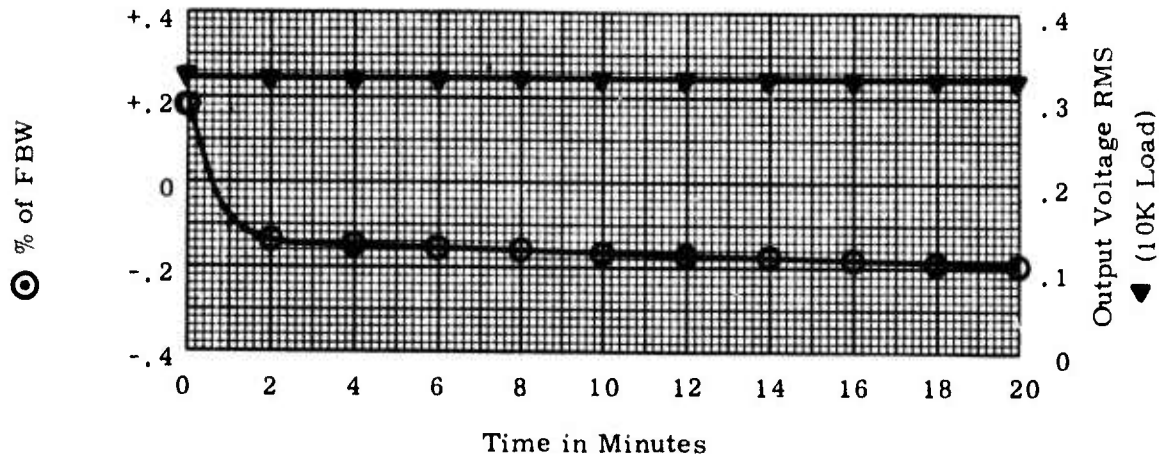

II. Temperature Stability

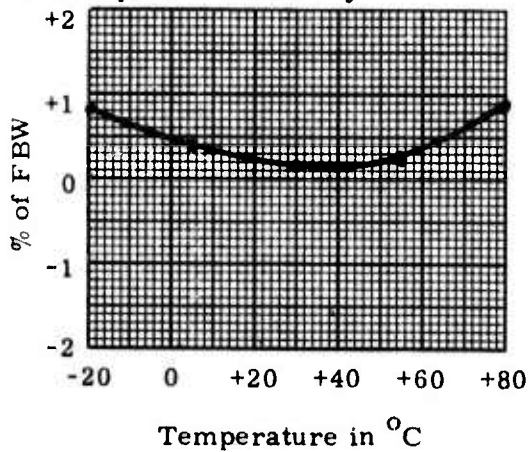

III. Amplitude Modulation

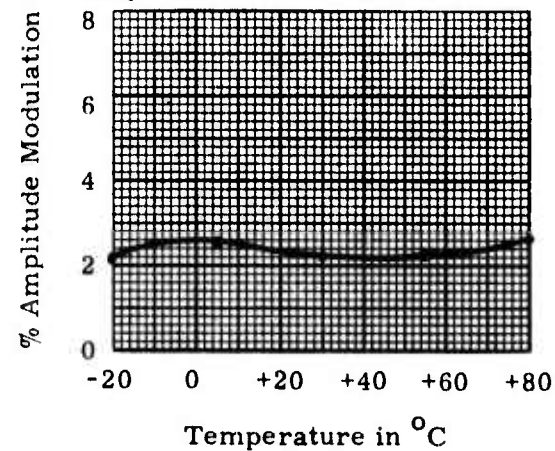

IV. Effects of Source Impedance at Ambient

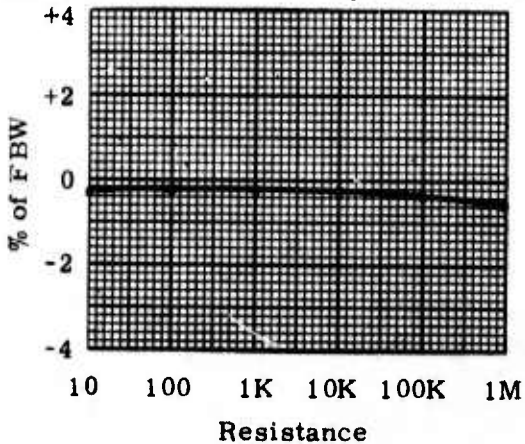

V. B+ Voltage Regulation at Ambient

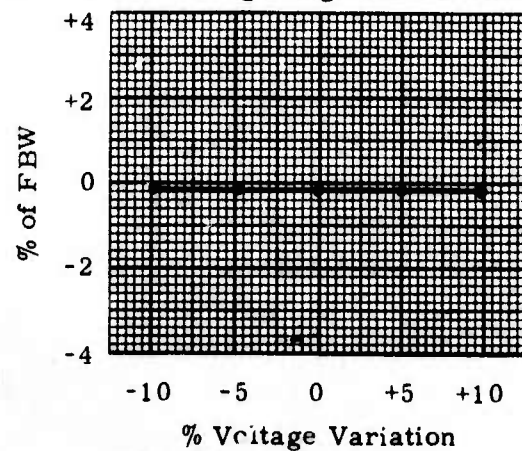

NORTHEASTERN UNIVERSITY

Evaluation Tests - Voltage Controlled Oscillators - Sheet 2

Make: Vector ; Type: MMO-11 ; Serial Number: 52377 ;
 IRIG Band Number: 13 ; FBW: 2176 Hz ; Date: 5/6/75 ; By: PJR

VI. Linearity vs. Temperature

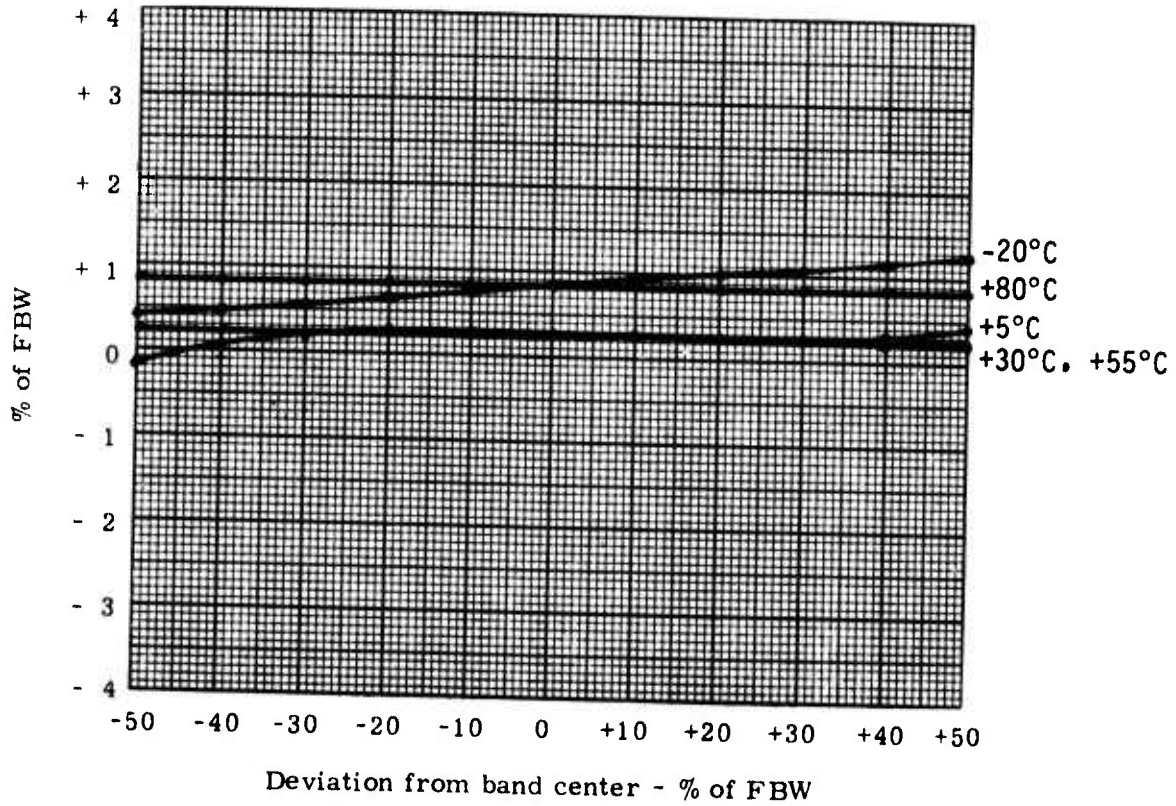

VII. Miscellaneous

1. Power Requirements 176mw
2. Input Impedence >500KΩ
3. Output Impedence <50KΩ
4. Harmonic Distortion .56%
5. Other Checks LINEARITY

-20°C	± 0.04%	from BSL
+5°C	± 0.12%	from BSL
+30°C	± 0.12%	from BSL
+55°C	± 0.04%	from BSL
+80°C	± 0.04%	from BSL

NORTHEASTERN UNIVERSITY

Evaluation Tests - Voltage Controlled Oscillators - Sheet 1

Make: Vector ; Type: MMO-11 ; Serial Number: 52378 ;
 IRIG Band Number: 13 ; FBW: 2176 Hz ; Date: 5/6/75 ; By: PJR ;

I. Time Drift

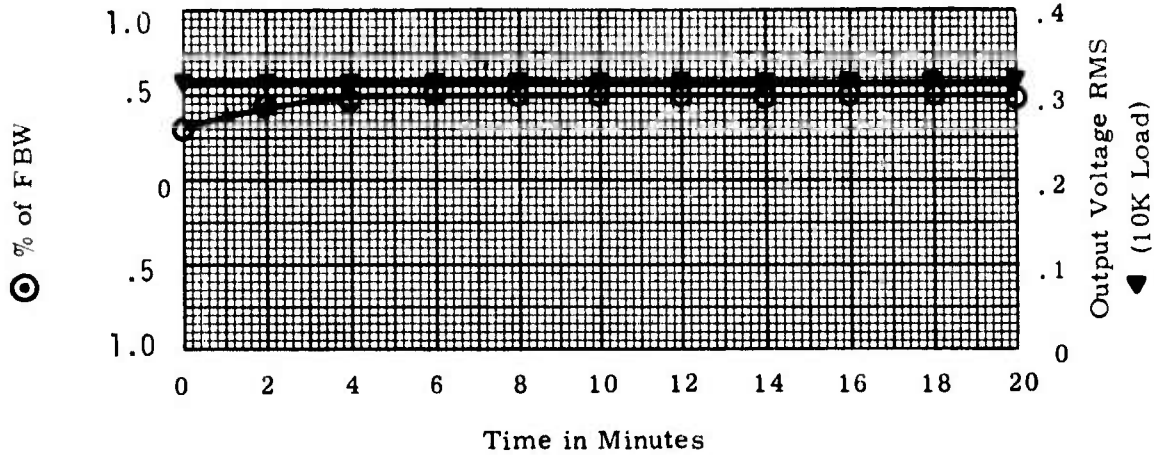

II. Temperature Stability

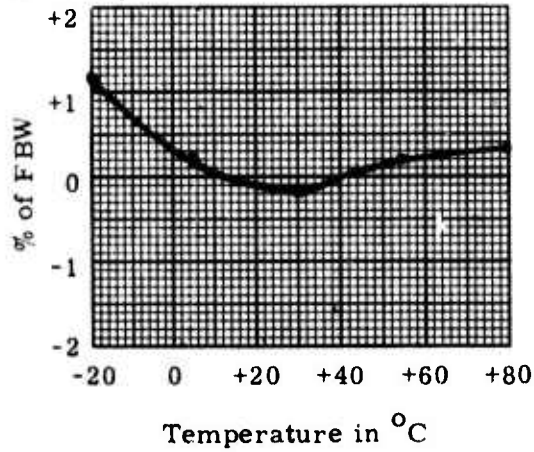

III. Amplitude Modulation

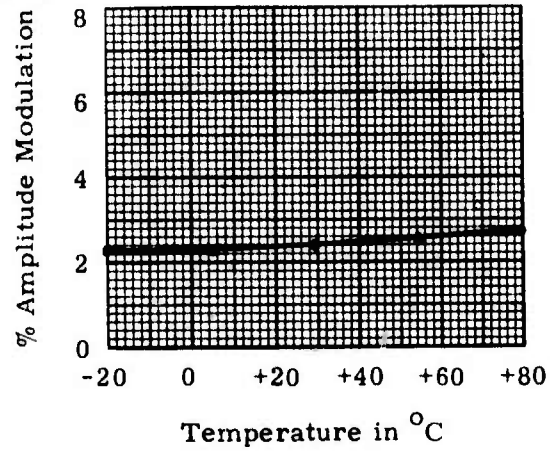

IV. Effects of Source Impedance at Ambient

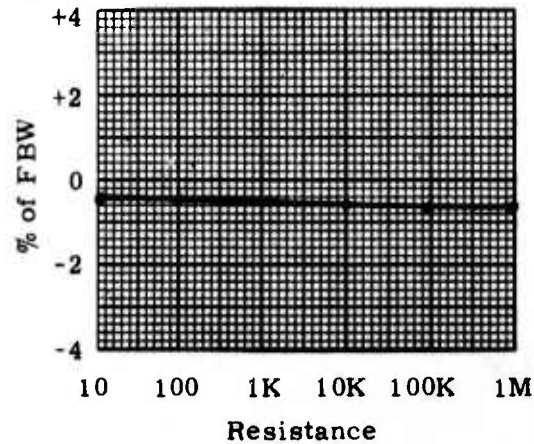

V. B+ Voltage Regulation at Ambient

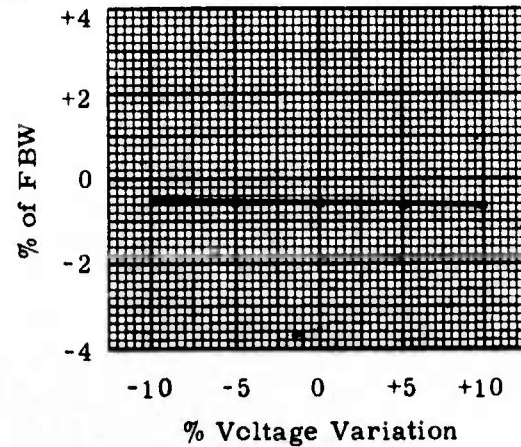

NORTHEASTERN UNIVERSITY

Evaluation Tests - Voltage Controlled Oscillators - Sheet 2

Make: Vector ; Type: MMO-11 ; Serial Number: 52378 ;
 IRIG Band Number: 13 ; FBW: 2176 Hz ; Date: 5/6/75 ; By: PJR ;

VI. Linearity vs. Temperature

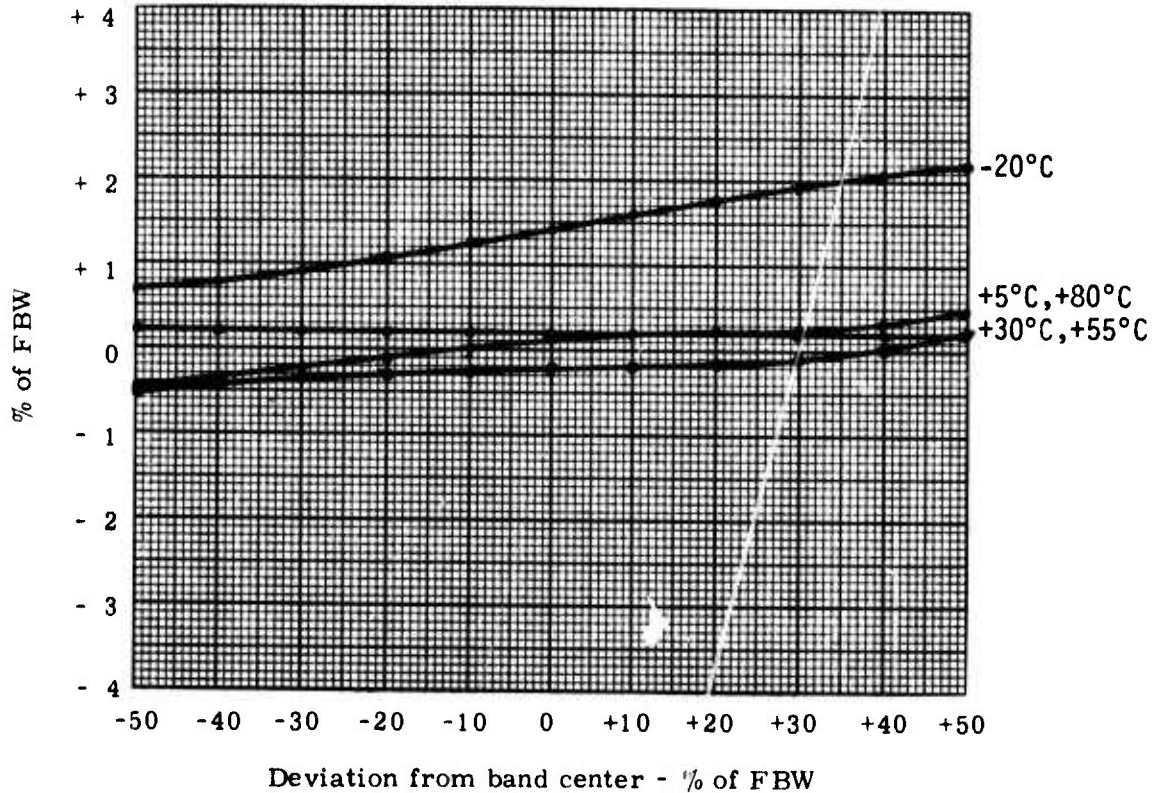

VII. Miscellaneous

1. Power Requirements	<u>176 mw</u>
2. Input Impedence	<u>>500KΩ</u>
3. Output Impedence	<u><50KΩ</u>
4. Harmonic Distortion	<u>.23%</u>
5. Other Checks	<u>LINEARITY</u>
-20°C ±	<u>0.04% from BSL</u>
+5°C ±	<u>0.09% from BSL</u>
+30°C ±	<u>0.08% from BSL</u>
+55°C ±	<u>0.02% from BSL</u>
+80°C ±	<u>0.03% from BSL</u>

NORTHEASTERN UNIVERSITY

Evaluation Tests - Voltage Controlled Oscillators - Sheet 1

Make: Vector ; Type: MMO-11 ; Serial Number: 52406 ;
 IRIG Band Number: 17 ; FBW: 7880 Hz; Date: 5/6/75 ; By: PJR ;

I. Time Drift

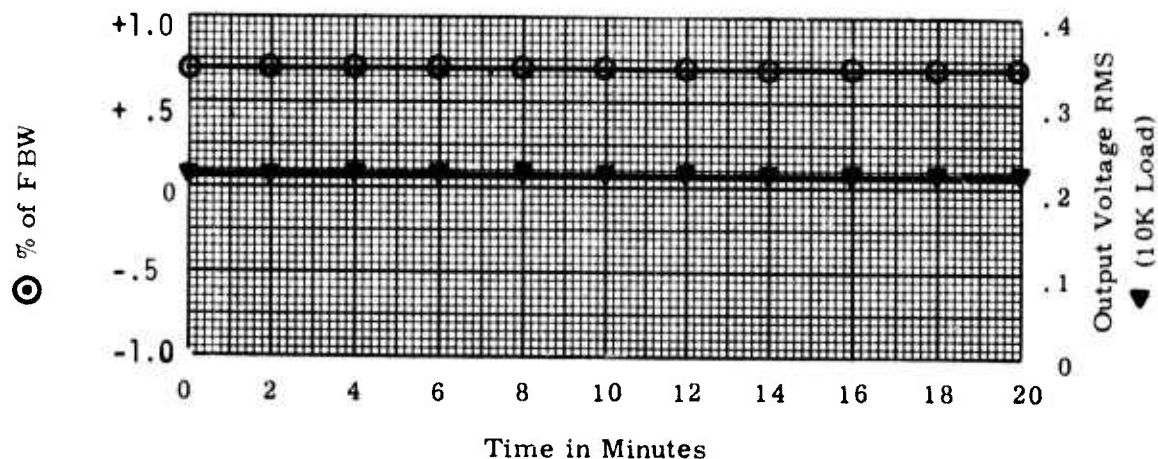

II. Temperature Stability

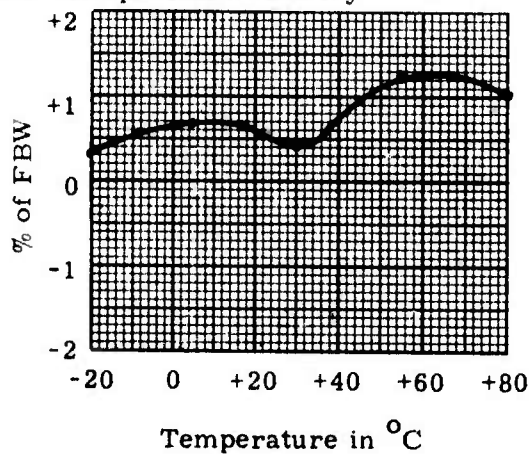

III. Amplitude Modulation

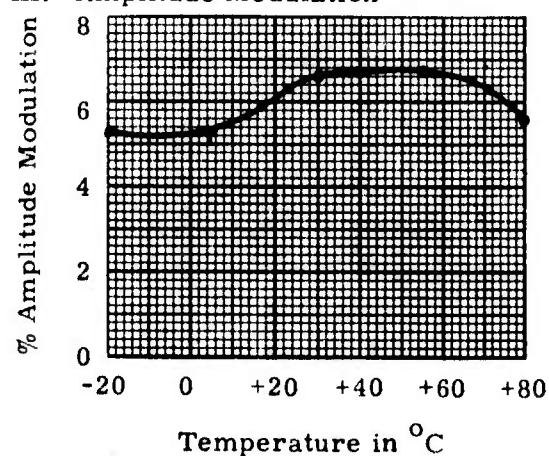

IV. Effects of Source Impedance at Ambient

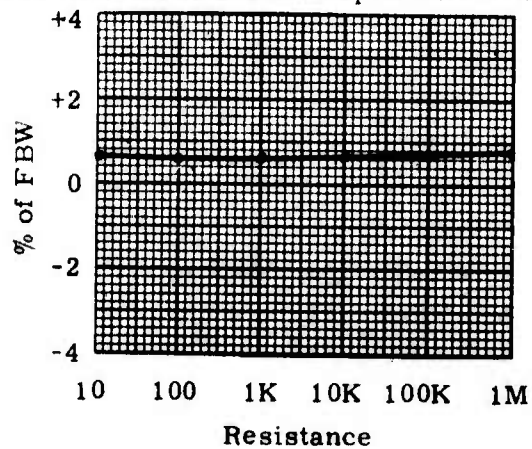

V. B+ Voltage Regulation at Ambient

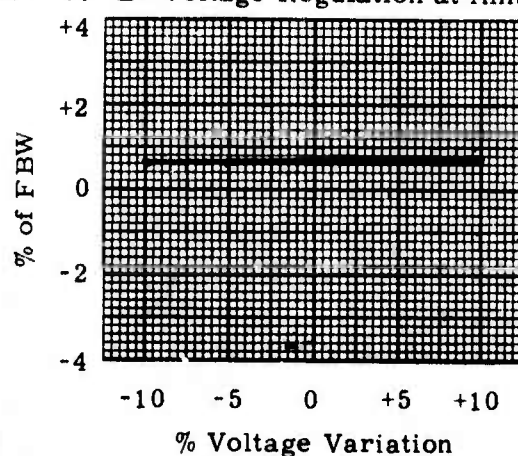

NORTHEASTERN UNIVERSITY

Evaluation Tests - Voltage Controlled Oscillators - Sheet 2

Make: Vector ; Type: MMO-11 ; Serial Number: 52406 ;
 IRIG Band Number: 17 ; FBW: 7880 Hz ; Date: 5/6/75 ; By: PJR ;

VI. Linearity vs. Temperature

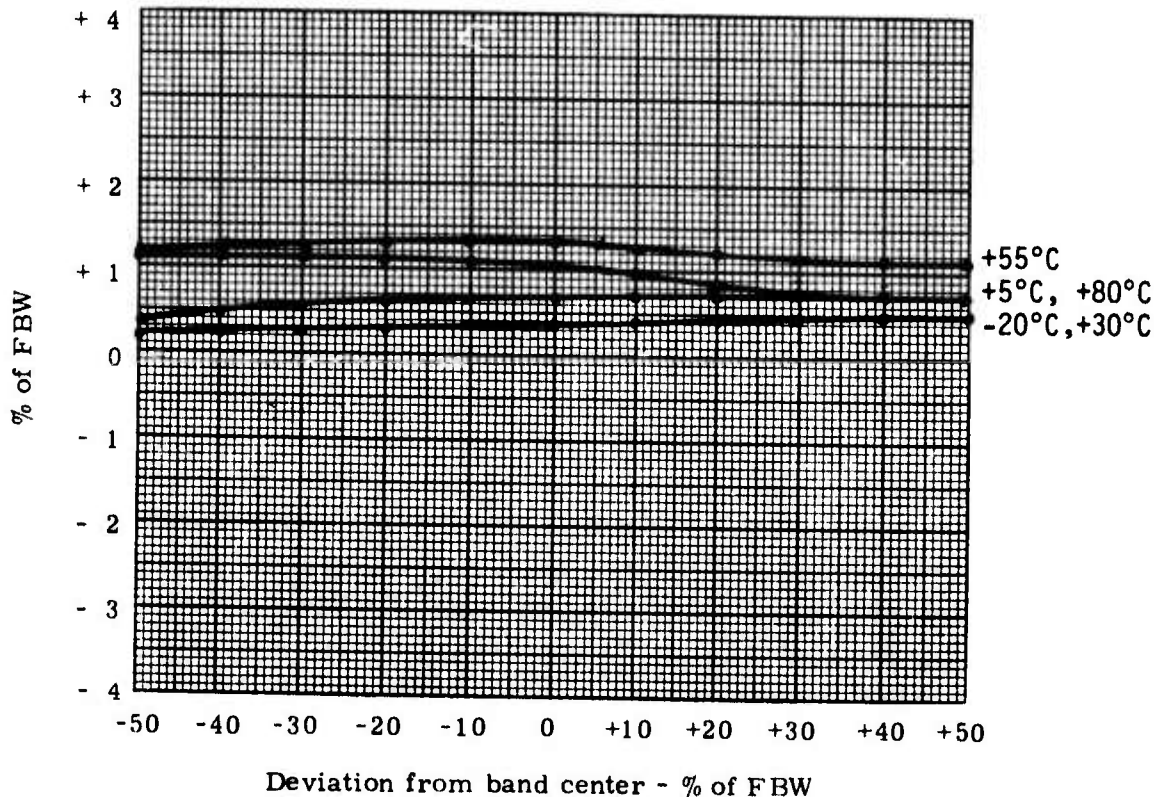

VII. Miscellaneous

1. Power Requirements	<u>168mw</u>
2. Input Impedence	<u>>500KΩ</u>
3. Output Impedence	<u><50KΩ</u>
4. Harmonic Distortion	<u>.23%</u>
5. Other Checks	<u>LINEARITY</u>
-20°C	<u>± 0.11% from BSL</u>
+5°C	<u>± 0.07% from BSL</u>
+30°C	<u>± 0.03% from BSL</u>
+55°C	<u>± 0.07% from BSL</u>
+80°C	<u>± 0.07% from BSL</u>

NORTHEASTERN UNIVERSITY

Evaluation Tests - Voltage Controlled Oscillators - Sheet 1

Make: Vector ; Type: MMO-11 ; Serial Number: 52422
 IRIG Band Number: 17 ; FBW: 7880 Hz; Date: 5/6/75 ; By: PJR

I. Time Drift

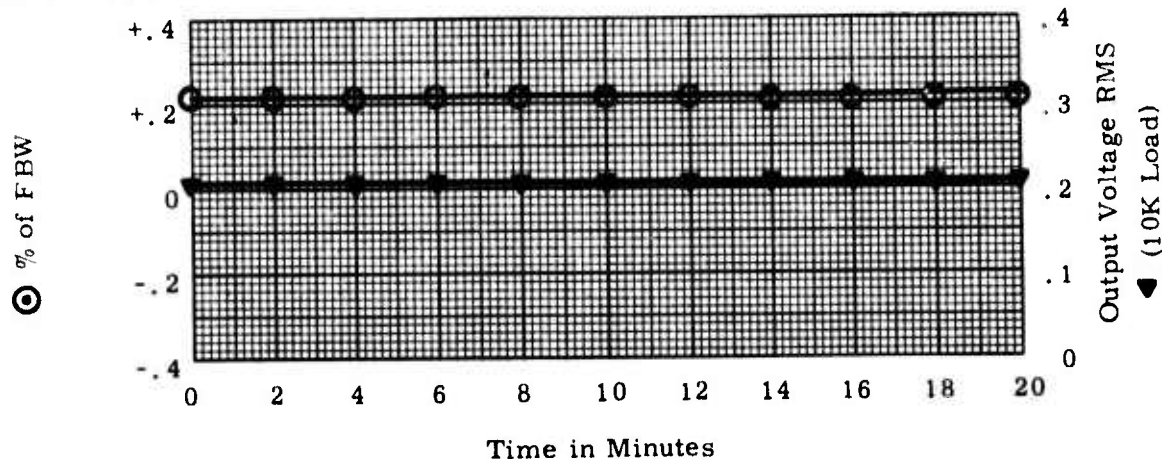

II. Temperature Stability

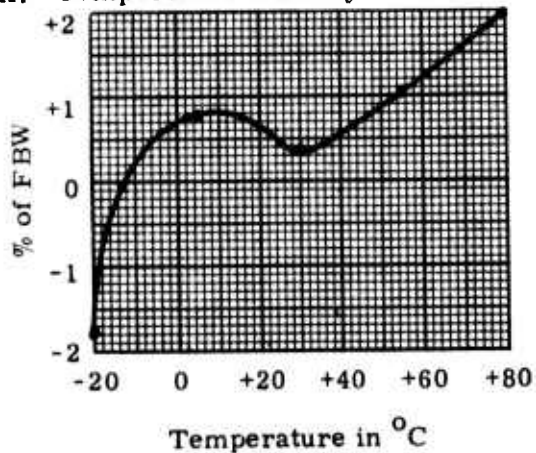

III. Amplitude Modulation

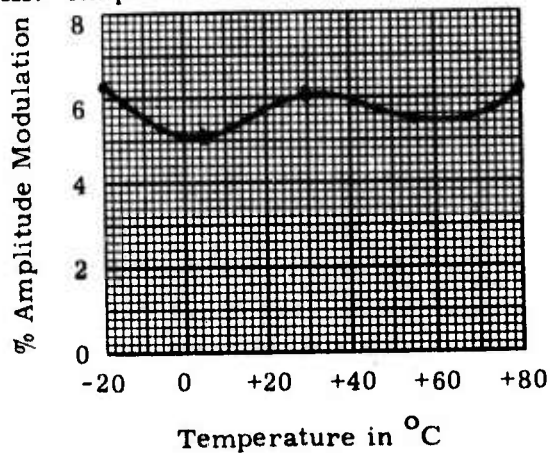

IV. Effects of Source Impedance at Ambient

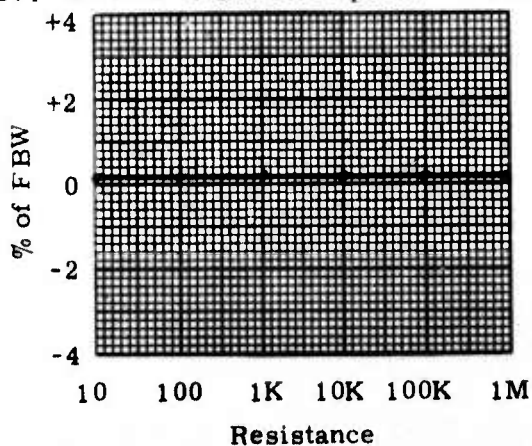

V. B+ Voltage Regulation at Ambient

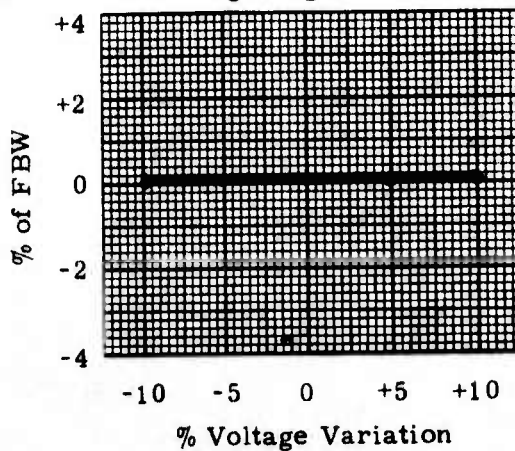

NORTHEASTERN UNIVERSITY

Evaluation Tests - Voltage Controlled Oscillators - Sheet 2

Make: Vector ; Type: MMO-11 ; Serial Number: 52422 ;
 IRIG Band Number: 17 ; FBW: 7880 Hz; Date: 5/6/75 ; By: PJR

VI. Linearity vs. Temperature

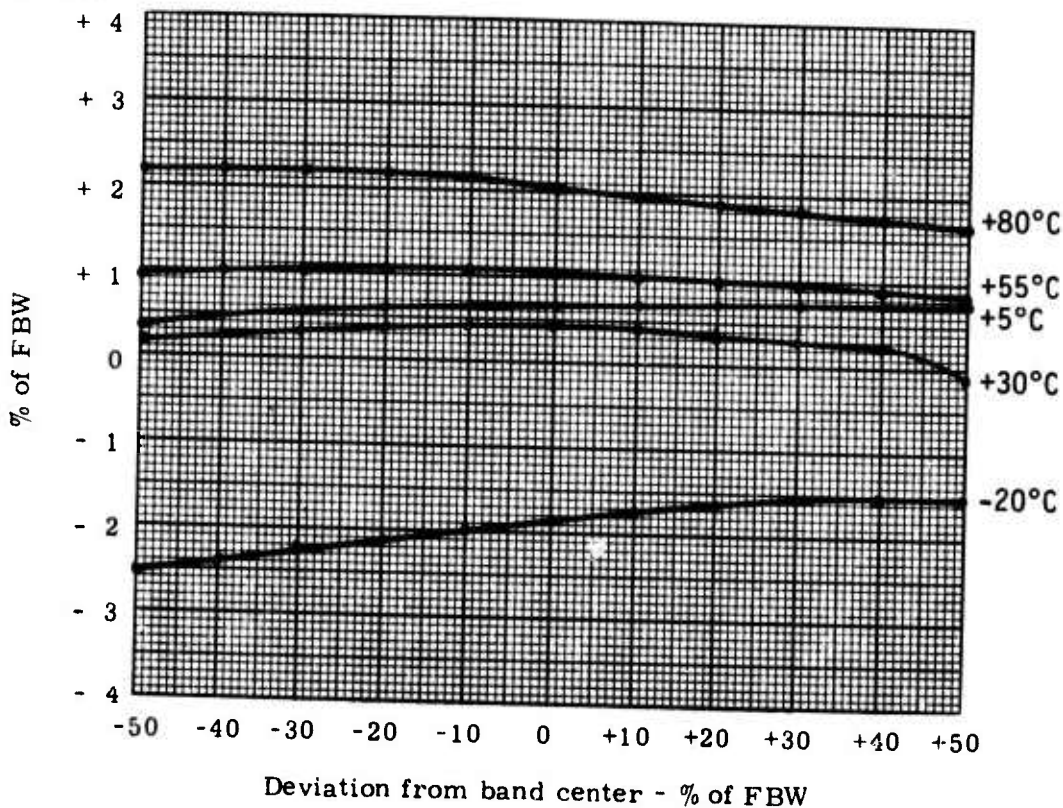

VII. Miscellaneous

1. Power Requirements 175mw
2. Input Impedence >500KΩ
3. Output Impedence <50KΩ
4. Harmonic Distortion .31%
5. Other Checks LINEARITY

-20°C	± 0.11%	from BSL
+5°C	± 0.07%	from BSL
+30°C	± 0.25%	from BSL
+55°C	± 0.15%	from BSL
+80°C	± 0.17%	from BSL

NORTHEASTERN UNIVERSITY

Evaluation Tests - Voltage Controlled Oscillators - Sheet 1

Make: Vector ; Type: MMO-11 ; Serial Number: 54168 ;
 IRIG Band Number: 18 ; FBW: 10500 Hz ; Date: 5/6/75 ; By: PJR ;

I. Time Drift

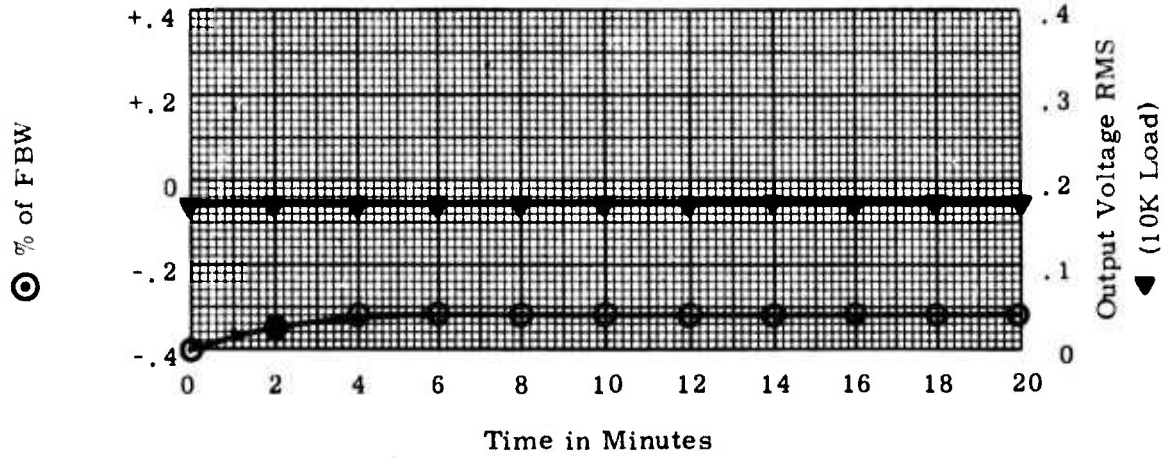

II. Temperature Stability

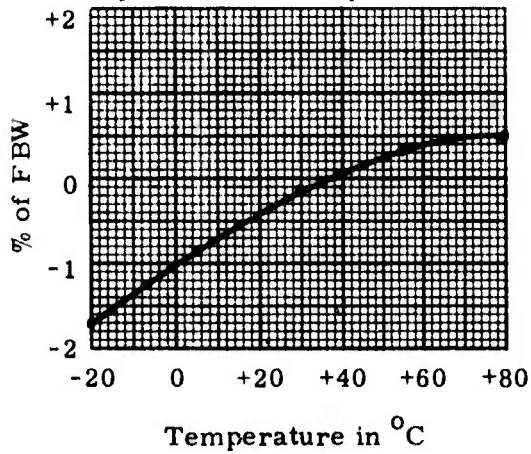

III. Amplitude Modulation

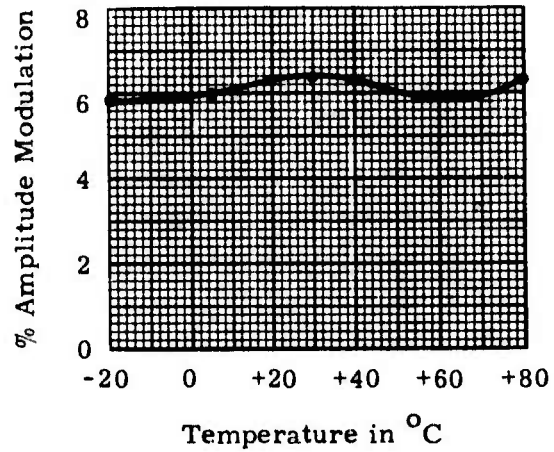

IV. Effects of Source Impedance at Ambient

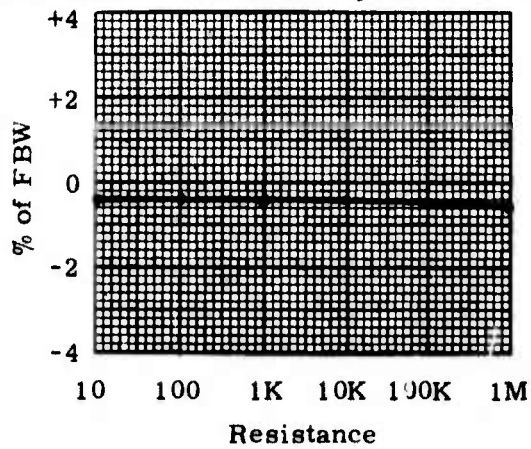

V. B+ Voltage Regulation at Ambient

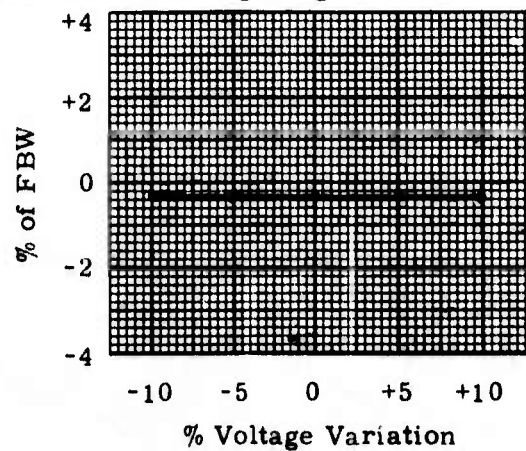

NORTHEASTERN UNIVERSITY

Evaluation Tests - Voltage Controlled Oscillators - Sheet 2

Make: Vector ; Type: MMO-11 ; Serial Number: 54168 ;
 IRIG Band Number: 18 ; FBW: 10500 Hz ; Date: 5/6/75 ; By: PJR ;

VI. Linearity vs. Temperature

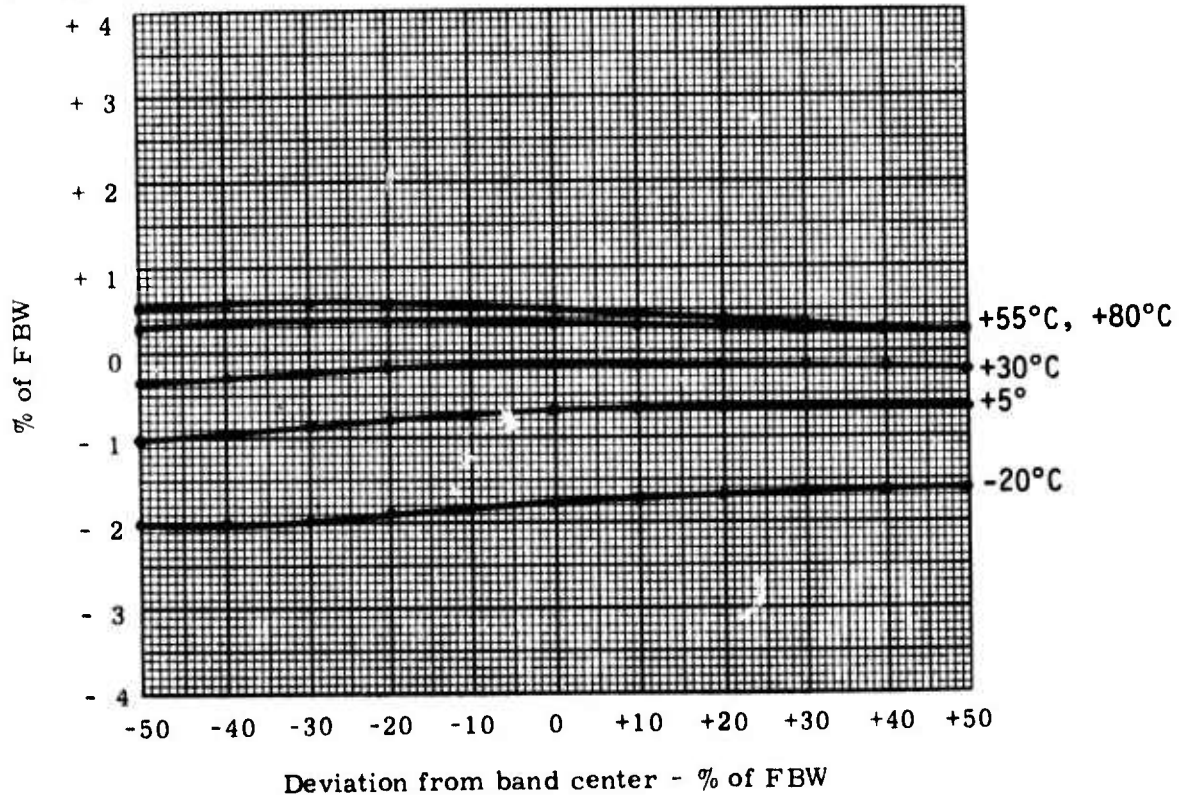

VII. Miscellaneous

1. Power Requirements	<u>172 mw</u>
2. Input Impedence	<u>>500KΩ</u>
3. Output Impedence	<u><50KΩ</u>
4. Harmonic Distortion	<u>.14%</u>
5. Other Checks	<u>LINEARITY</u>
-20°C	<u>± 0.04% from BSL</u>
+5°C	<u>± 0.06% from BSL</u>
+30°C	<u>± 0.08% from BSL</u>
+55°C	<u>± 0.04% from BSL</u>
+80°C	<u>± 0.06% from BSL</u>

Evaluation Tests - Proprietary Information Sheet

Voltage Controlled Subcarrier Oscillators

Make: Vector;

Type: MTS-42;

Manufacturer's Specifications

Frequency Response: For a modulation index of 5.0 or greater, the intelligence frequency response is within 0.1 dB of the dc response.

Linearity: Less than $\pm 0.25\%$ of design bandwidth deviation from best straight line.

Stability: A change in supply voltage of $\pm 15\%$ will vary the center frequency less than $\pm 0.25\%$ of design bandwidth.

Input Voltage: Any 5 volt range between -2.5 V and +5.0 Vdc.

Input Impedance: 500 kilohm minimum for $\pm 7.5\%$ deviation.

Source Impedance Sensitivity: Changing the source impedance from zero to infinity varies the frequency less than 0.5% of design bandwidth.

Amplitude Modulation: Less than 5%.

Harmonic Distortion: At center frequency, the total harmonic distortion of output signal is less than 0.75%.

Intelligence Frequency Component In Output: Harmonics of intelligence frequency are suppressed 40 dB below output signal.

Output Voltage: 0.85 volt p-p minimum with 10 kilohm load. 0 to 2 volt rms at test point.

Output Impedance: 47 kilohms nominal.

Output Impedance Sensitivity: 10 to 1 change in the load impedance will cause less than 1% change in output frequency.

Power Requirements: 28 volts dc $\pm 15\%$ at 6.5 mA nominal, 11 mA maximum.

NORTHEASTERN UNIVERSITY

Evaluation Tests - Voltage Controlled Oscillators - Sheet 1

Make: Vector ; Type: MTS-42 ; Serial Number: 7499 ;
 IRIG Band Number: 12 ; FBW: 1576 Hz; Date: 5/19/75 ; By: PJR ;

I. Time Drift

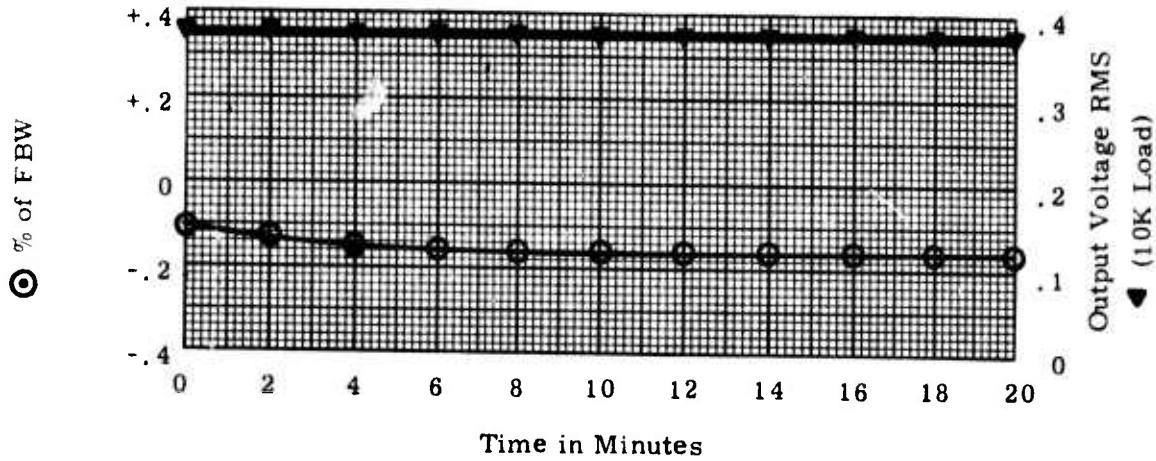

II. Temperature Stability

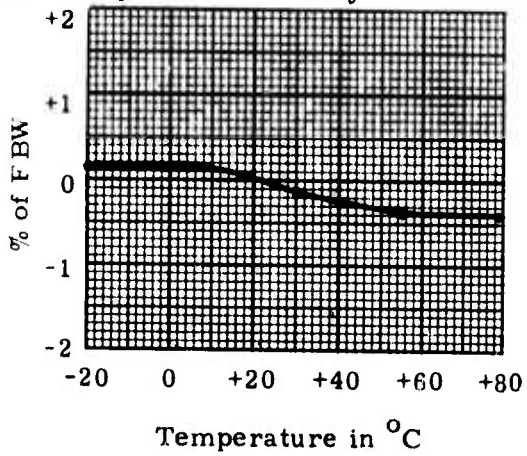

III. Amplitude Modulation

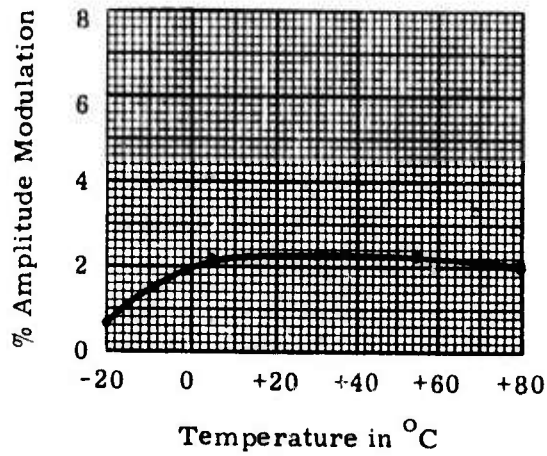

IV. Effects of Source Impedance at Ambient

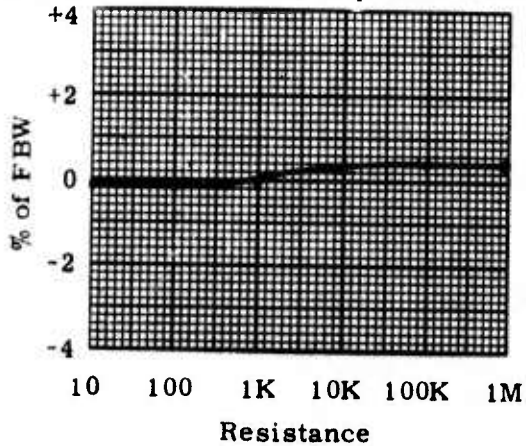

V. B+ Voltage Regulation at Ambient

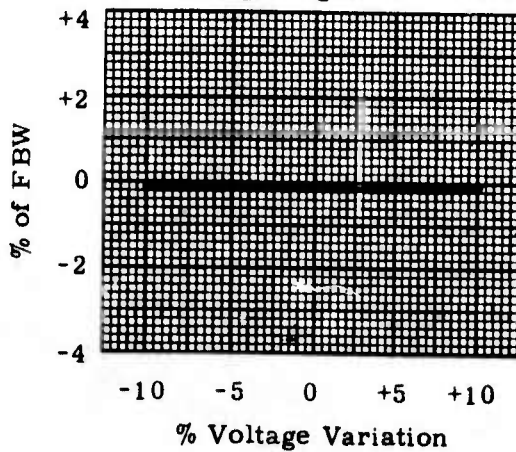

BANK

PAGE

NORTHEASTERN UNIVERSITY

Evaluation Tests - Voltage Controlled Oscillators - Sheet 2

Make: vector ; Type: MTS-42 ; Serial Number: 7499 ;
 IRIG Band Number: 12 ; FBW: 1576 Hz ; Date: 5/19/75 ; By: PJR ;

VI. Linearity vs. Temperature

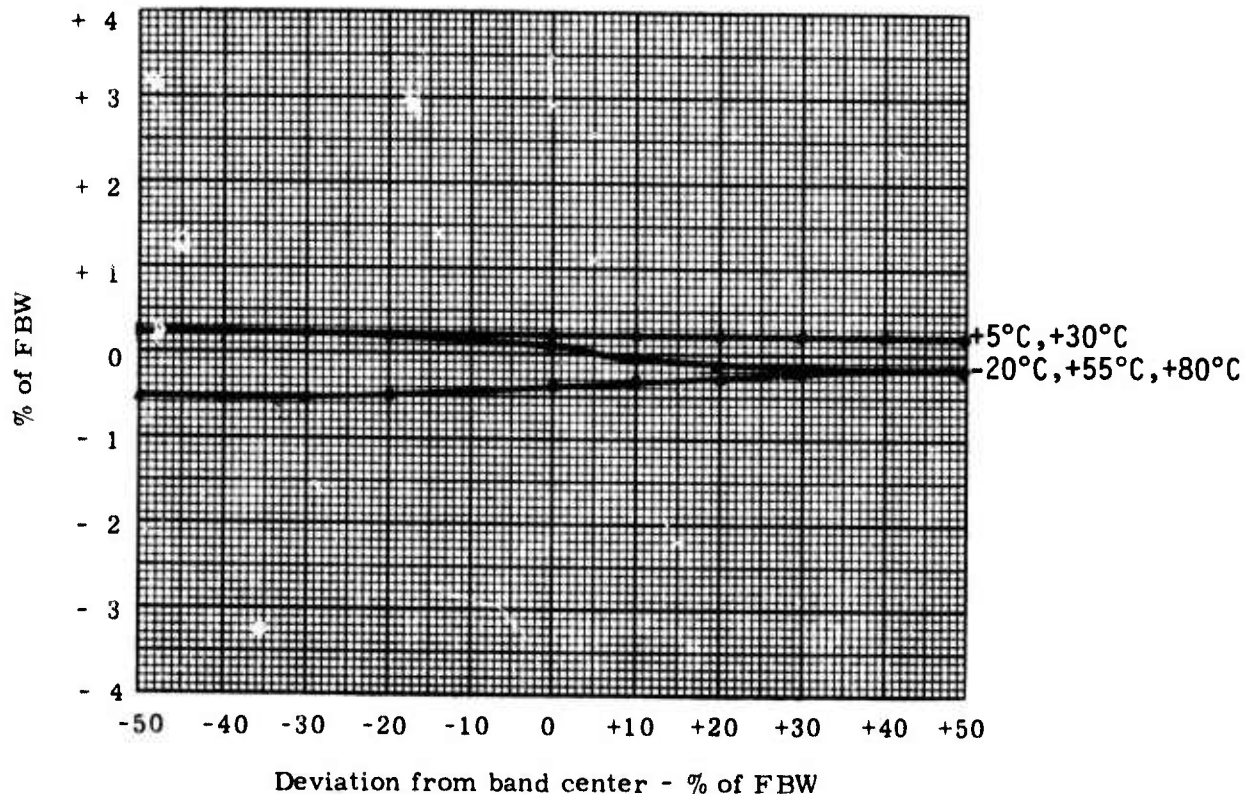

VII. Miscellaneous

1. Power Requirements 123 mW
2. Input Impedance >500KΩ
3. Output Impedance <50KΩ
4. Harmonic Distortion 0.5%
5. Other Checks LINEARITY

-20°C	±	0.13%	from BSL
+5°C	±	0.03%	from BSL
+30°C	±	0.03%	from BSL
+55°C	±	0.03%	from BSL
+80°C	±	0.03%	from BSL

NORTHEASTERN UNIVERSITY

Evaluation Tests - Voltage Controlled Oscillators - Sheet 1

Make: Vector ; Type: MTS-42 ; Serial Number: 7744
 IRIG Band Number: 7 ; FBW: 346 Hz ; Date: 5/19/75 ; By: PJR

I. Time Drift

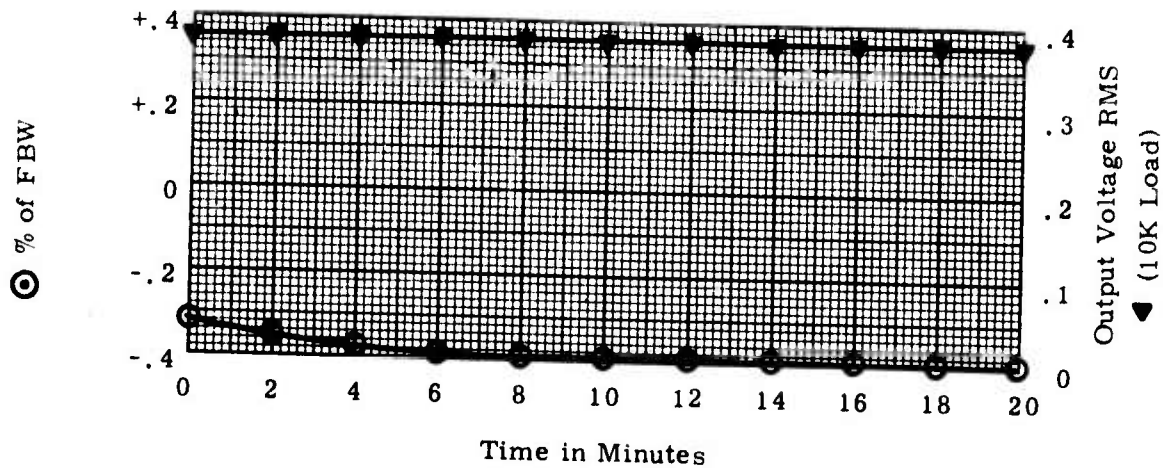

II. Temperature Stability

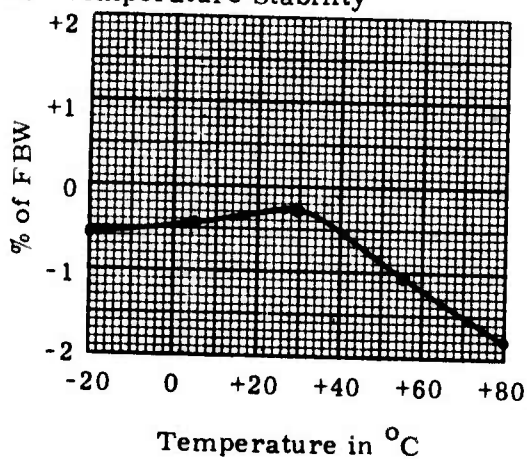

III. Amplitude Modulation

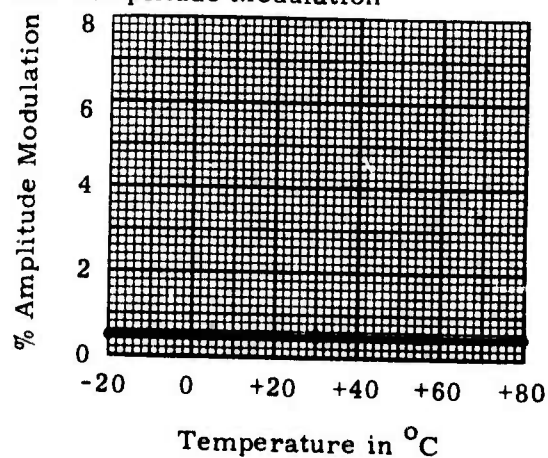

IV. Effects of Source Impedence at Ambient

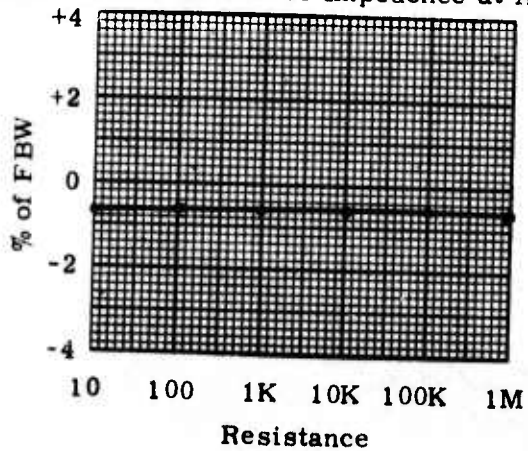

V. B+ Voltage Regulation at Ambient

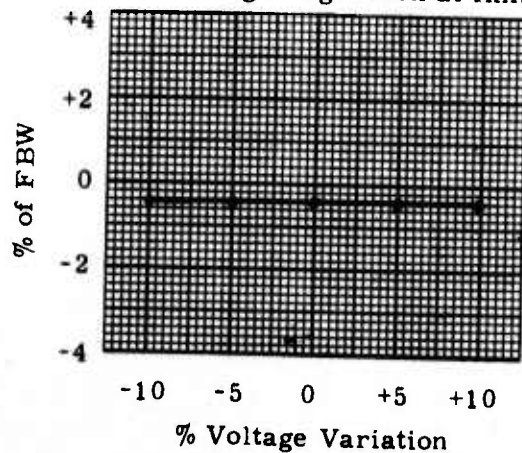

NORTHEASTERN UNIVERSITY

Evaluation Tests - Voltage Controlled Oscillators - Sheet 2

Make: Vector ; Type: MTS-42 ; Serial Number: 7744 ;
 IRIG Band Number: 7 ; FBW: 346 Hz ; Date: 5/19/75 ; By: PJR ;

VI. Linearity vs. Temperature

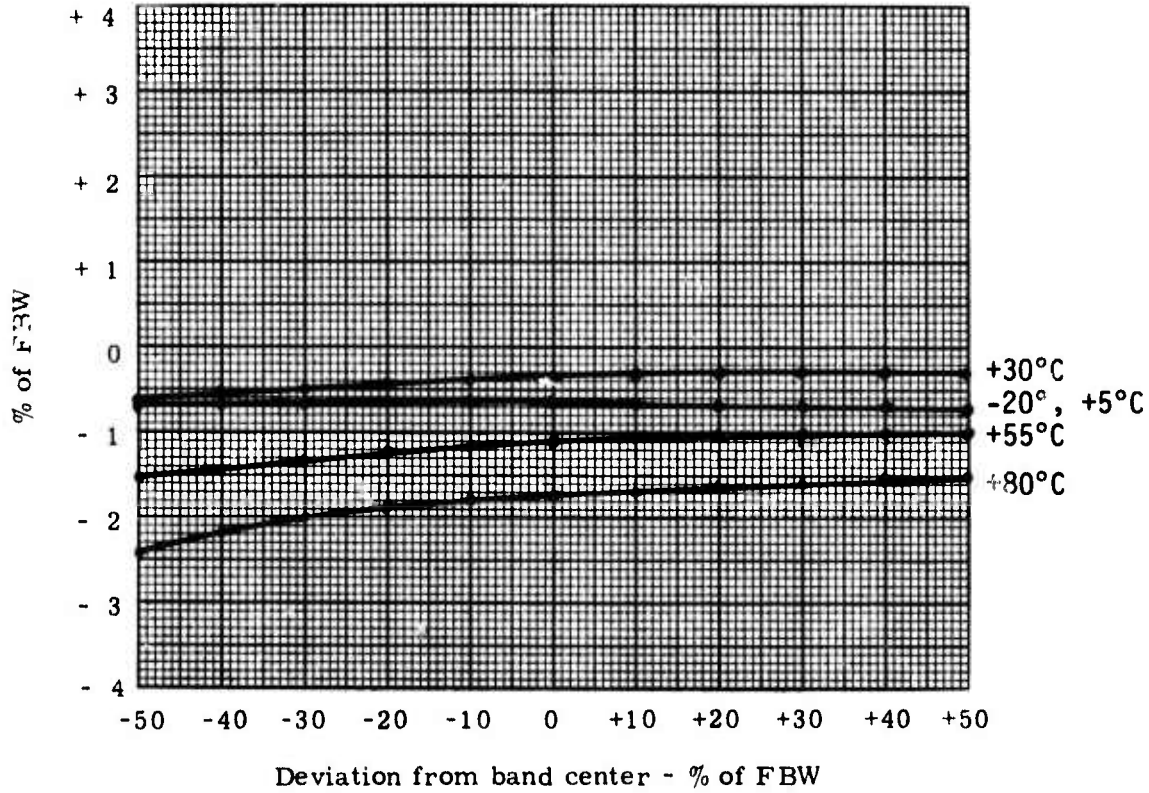

VII. Miscellaneous

1. Power Requirements 120 mw
2. Input Impedence >500KΩ
3. Output Impedence <50KΩ
4. Harmonic Distortion 0.26%
5. Other Checks LINEARITY

-20°C	± 0.05%	from BSL
+5°C	± 0.05%	from BSL
+30°C	± 0.07%	from BSL
+55°C	± 0.05%	from BSL
+80°C	± 0.07%	from BSL

NORTHEASTERN UNIVERSITY

Evaluation Tests - Voltage Controlled Oscillators - Sheet 1

Make: Vector; Type: MTS-42; Serial Number: 7762
 IRIG Band Number: 7; FBW: 346 Hz; Date: 5/19/75; By: PJR

I. Time Drift

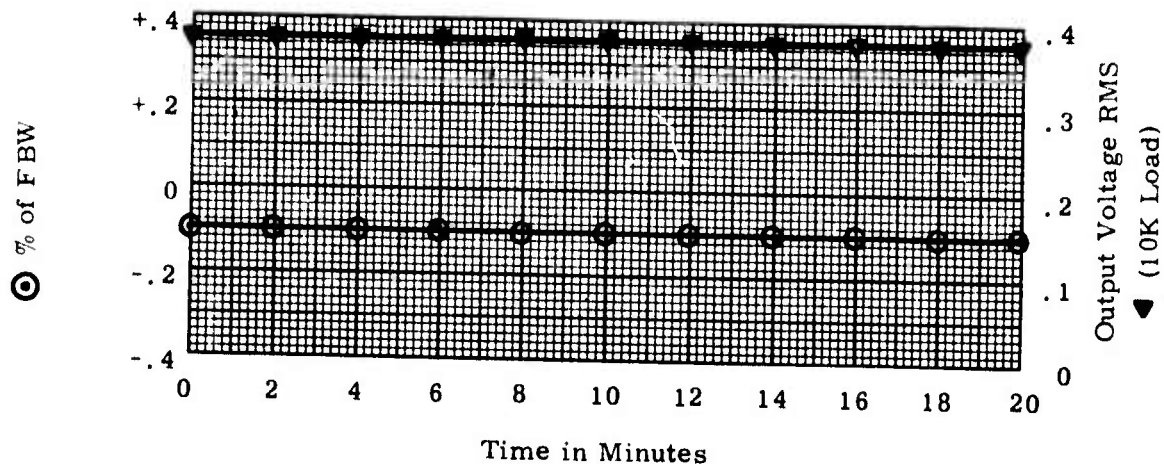

II. Temperature Stability

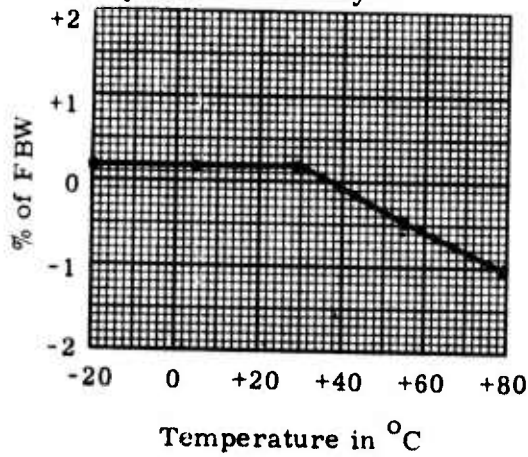

III. Amplitude Modulation

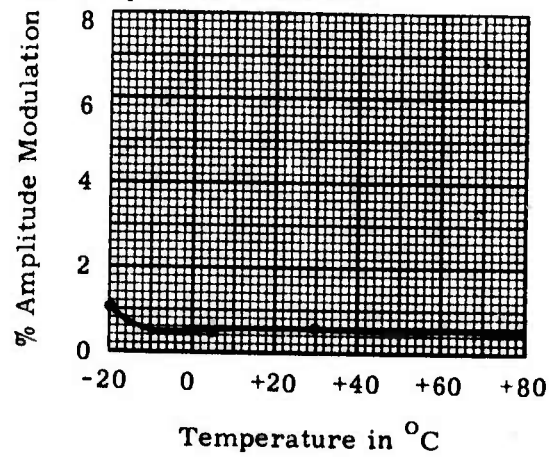

IV. Effects of Source Impedence at Ambient

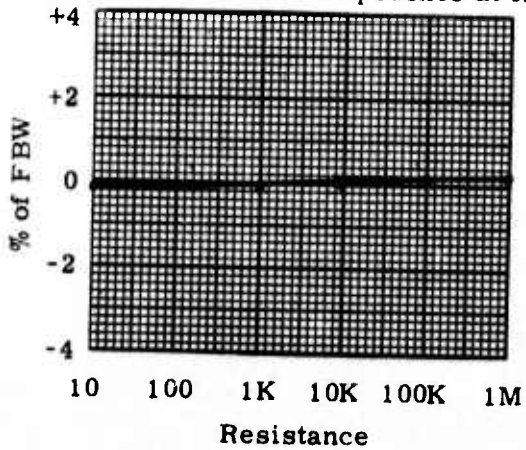

V. B+ Voltage Regulation at Ambient

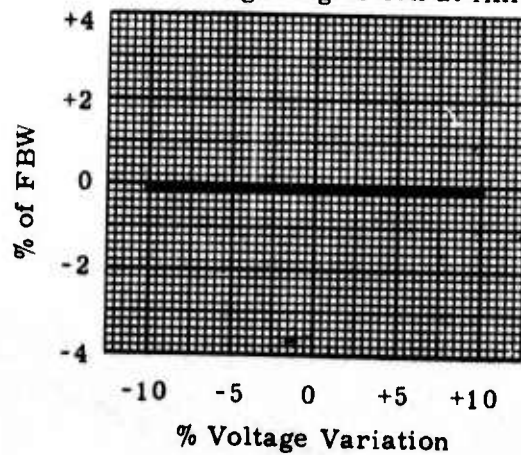

NORTHEASTERN UNIVERSITY

Evaluation Tests - Voltage Controlled Oscillators - Sheet 2

Make: Vector ; Type: MTS-42 ; Serial Number: 7762 ;
 IRIG Band Number: 7 ; FBW: 346 Hz ; Date: 5/19/75 ; By: PJR ;

VI. Linearity vs. Temperature

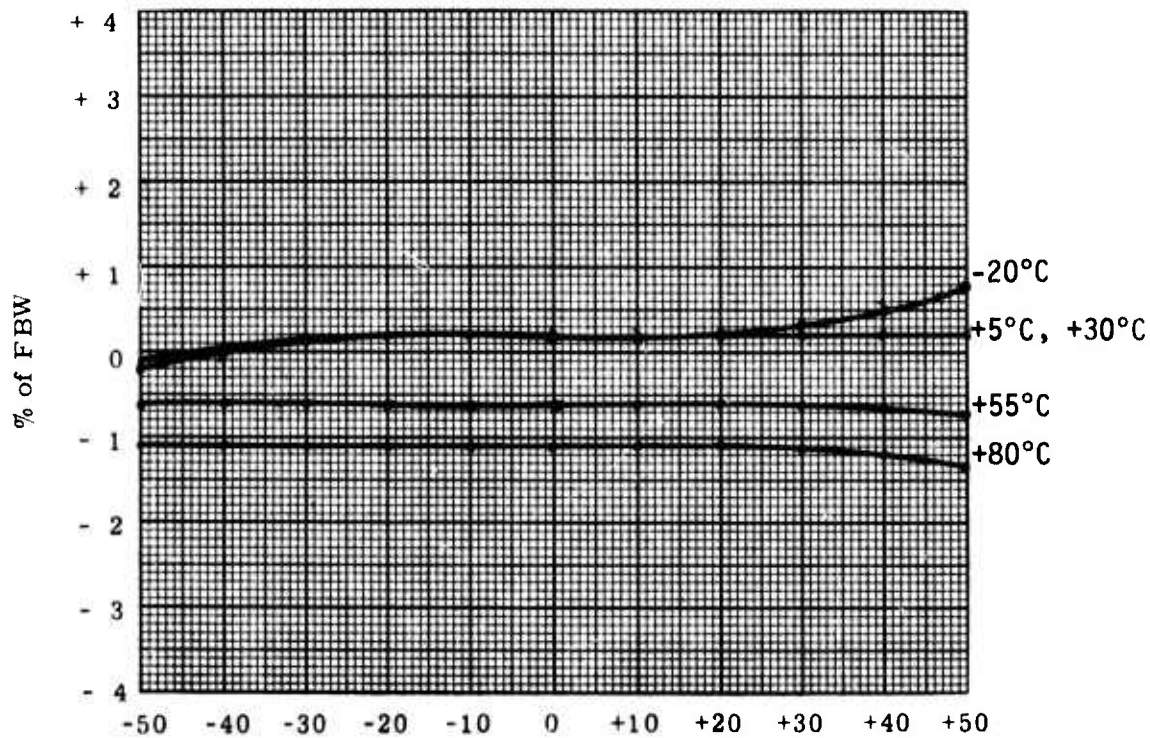

Deviation from band center - % of FBW

VII. Miscellaneous

1. Power Requirements 123 mw
2. Input Impedence >500KΩ
3. Output Impedence <50KΩ
4. Harmonic Distortion 0.19%
5. Other Checks LINEARITY

-20°C	±	0.09%	from BSL
+5°C	±	0.15%	from BSL
+30°C	±	0.16%	from BSL
+55°C	±	0.05%	from BSL
+80°C	±	0.15%	from BSL

NORTHEASTERN UNIVERSITY

Evaluation Tests - Voltage Controlled Oscillators - Sheet 1

Make: Vector; Type: MTS-42; Serial Number: 7854
 IRIG Band Number: 12; FBW: 1576 Hz; Date: 5/19/75; By: PJR

I. Time Drift

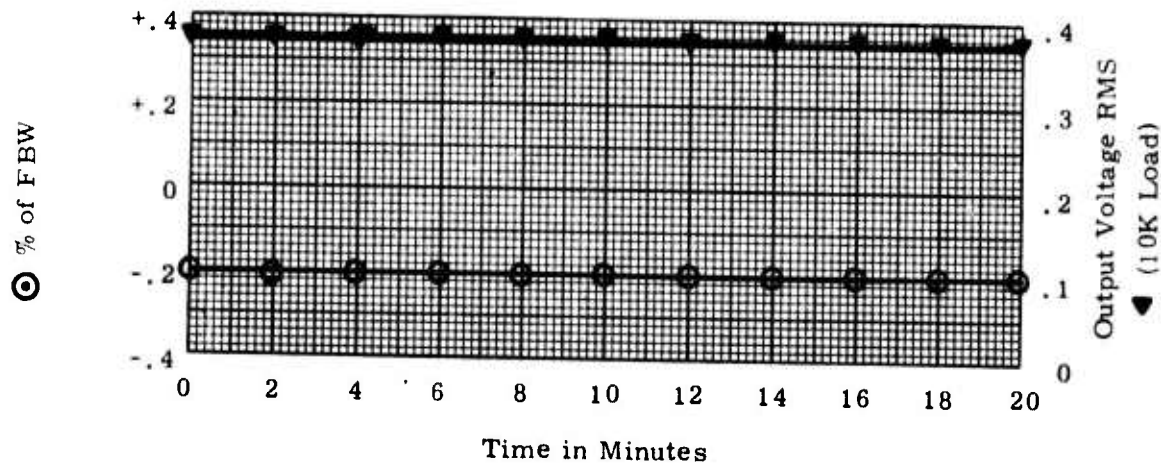

II. Temperature Stability

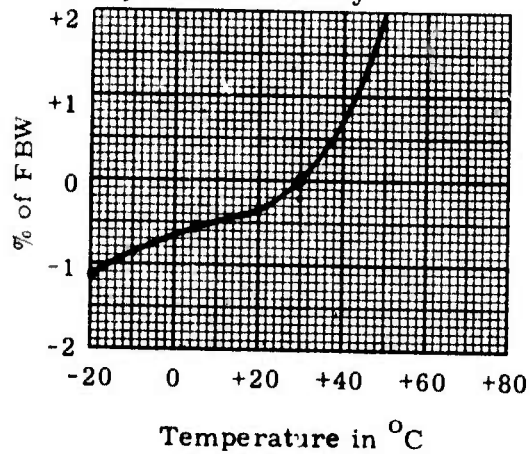

III. Amplitude Modulation

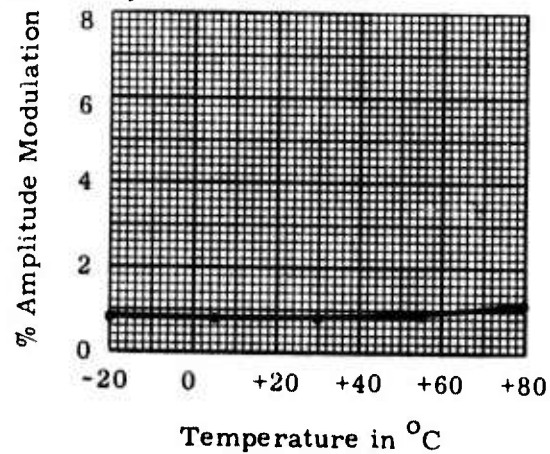

IV. Effects of Source Impedance at Ambient

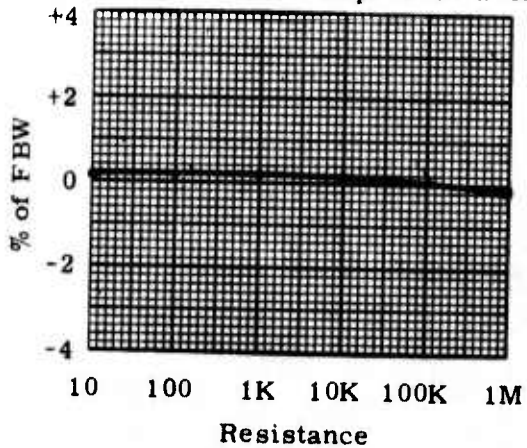

V. B+ Voltage Regulation at Ambient

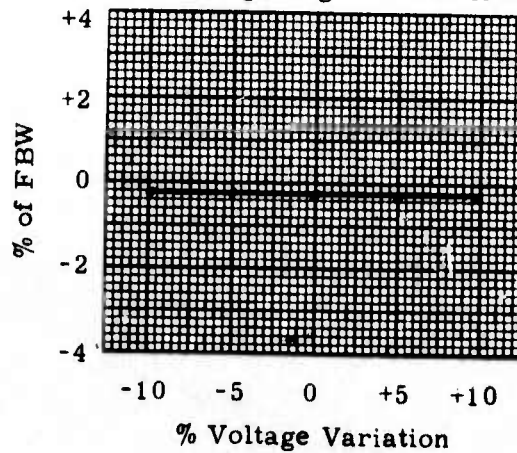

NORTHEASTERN UNIVERSITY

Evaluation Tests - Voltage Controlled Oscillators - Sheet 2

Make: Vector ; Type: MTS-42 ; Serial Number: 7854 ;
 IRIG Band Number: 12 ; FBW: 1576 Hz ; Date: 5/19/75 ; By: PJR ;

VI. Linearity vs. Temperature

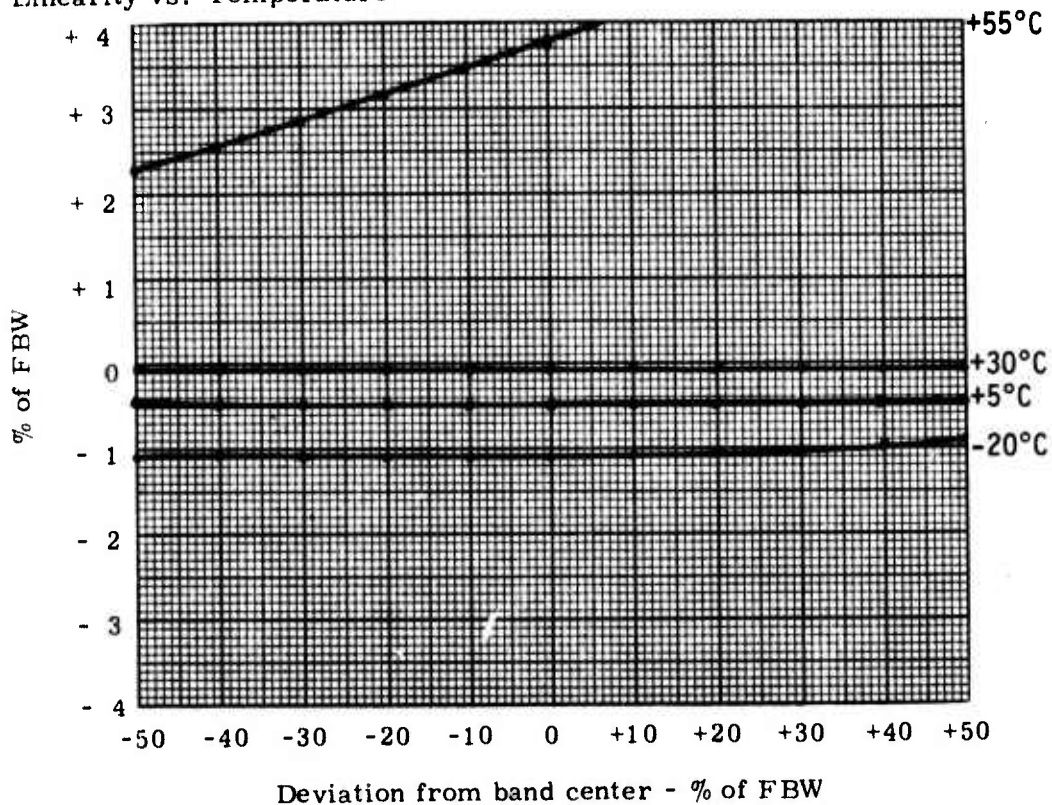

VII. Miscellaneous

1. Power Requirements 123 mW
2. Input Impedance >500KΩ
3. Output Impedance <50KΩ
4. Harmonic Distortion 0.09%
5. Other Checks LINEARITY

-20°C	± 0.05%	from BSL
+5°C	± 0.04%	from BSL
+30°C	± 0.02%	from BSL
+55°C	± 0.25%	from BSL
+80°C	± 2.0%	from BSL

out of specifications at 55°C

NORTHEASTERN UNIVERSITY

Evaluation Tests - Voltage Controlled Oscillators - Sheet 1

Make: Vector ; Type: MTS-42 ; Serial Number: 7880 ;
 IRIG Band Number: 13 ; FBW: 2176 Hz ; Date: 5/19/75 ; By: PJR

I. Time Drift

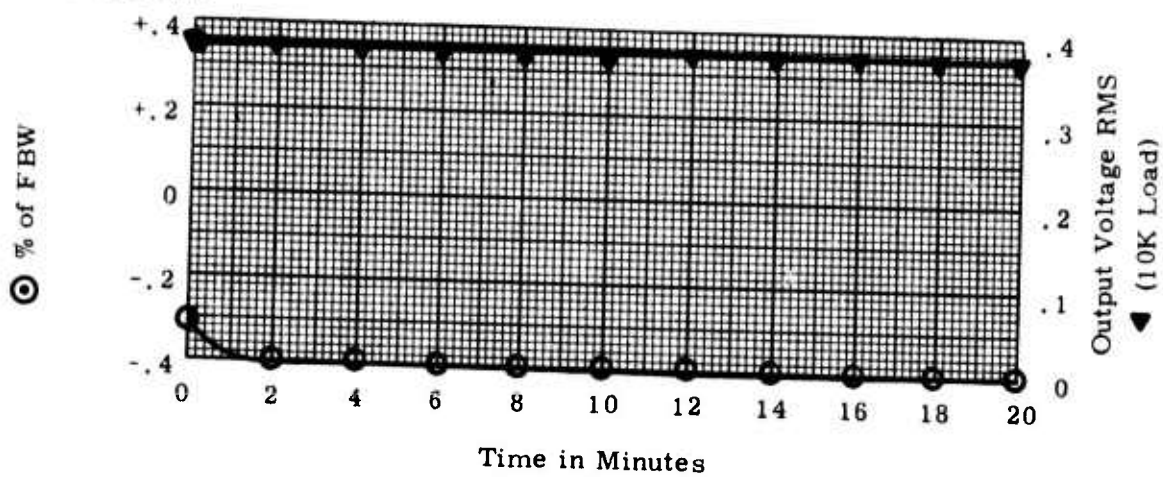

II. Temperature Stability

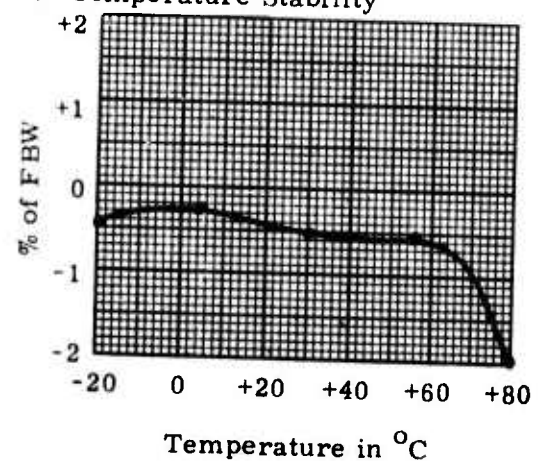

III. Amplitude Modulation

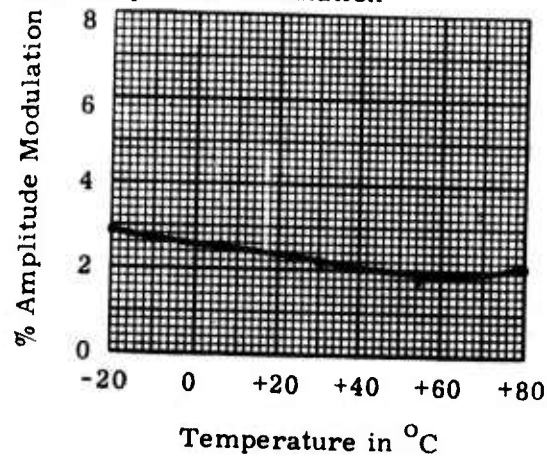

IV. Effects of Source Impedance at Ambient

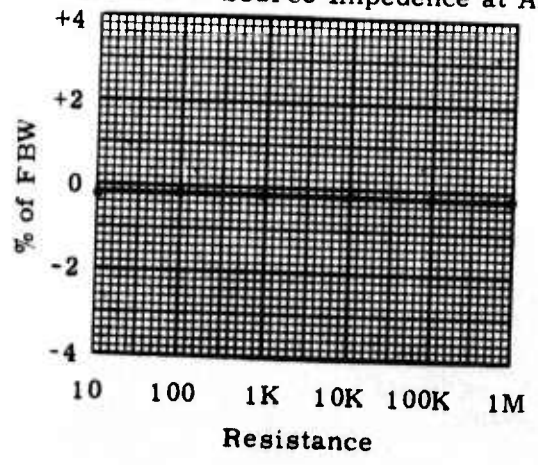

V. B+ Voltage Regulation at Ambient

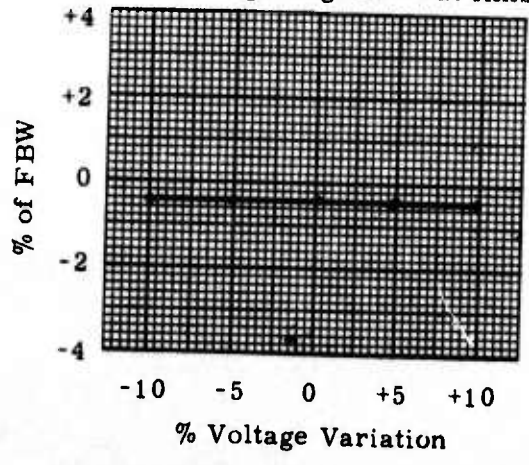

NORTHEASTERN UNIVERSITY

Evaluation Tests - Voltage Controlled Oscillators - Sheet 2

Make: Vector ; Type: MTS-42 ; Serial Number: 7880
 IRIG Band Number: 13 ; FBW: 2176 Hz ; Date: 5/19/75 ; By: PJR

VI. Linearity vs. Temperature

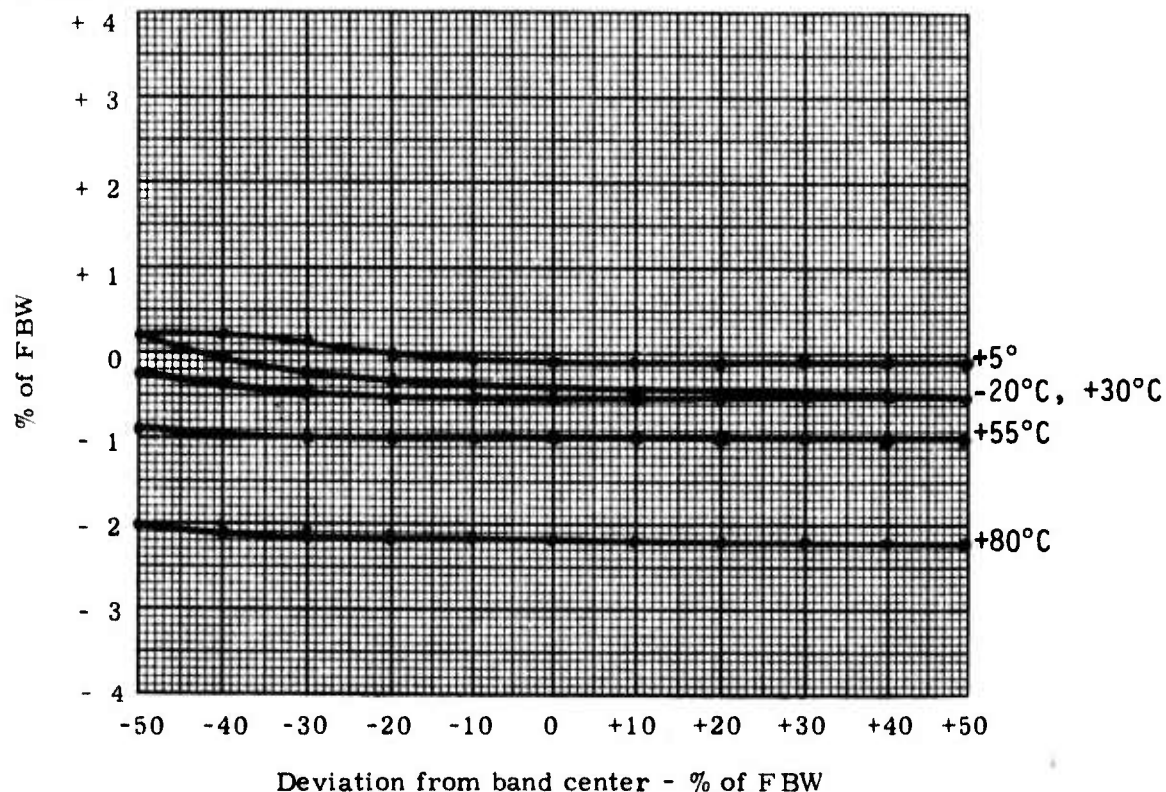

VII. Miscellaneous

1. Power Requirements 115 mw
2. Input Impedence >500K Ω
3. Output Impedence <50K Ω
4. Harmonic Distortion 0.09%
5. Other Checks LINEARITY

-20°C	±	0.12%	from BSL
+5°C	±	0.09%	from BSL
+30°C	±	0.06%	from BSL
+55°C	±	0.05%	from BSL
+80°C	±	0.10%	from BSL

NORTHEASTERN UNIVERSITY

Evaluation Tests - Voltage Controlled Oscillators - Sheet 1

Make: Vector ; Type: MTS-42 ; Serial Number: 7922
 IRIG Band Number: 15 ; FBW: 4500 Hz; Date: 4/23/75 ; By: PJR

I. Time Drift

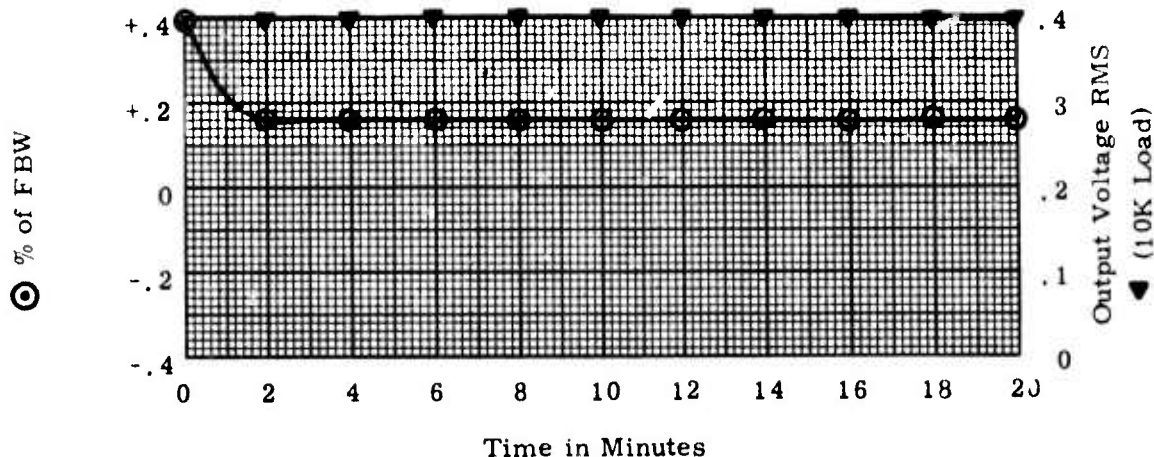

II. Temperature Stability

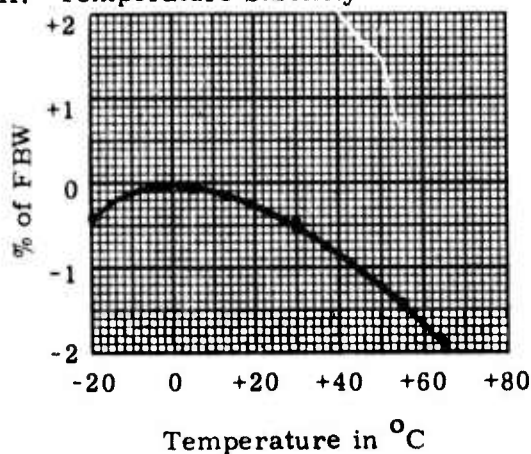

III. Amplitude Modulation

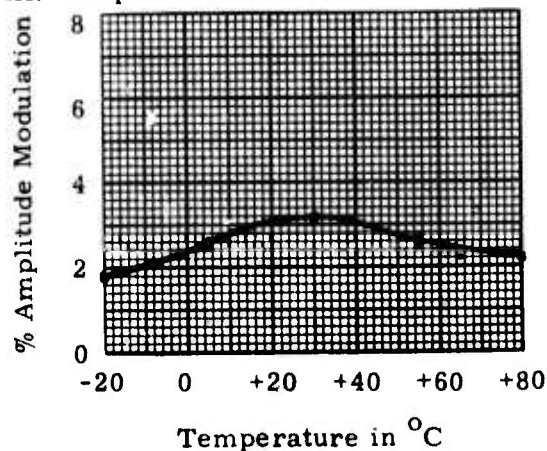

IV. Effects of Source Impedance at Ambient

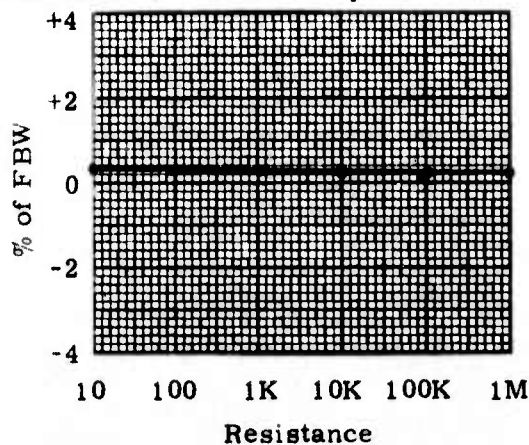

V. B+ Voltage Regulation at Ambient

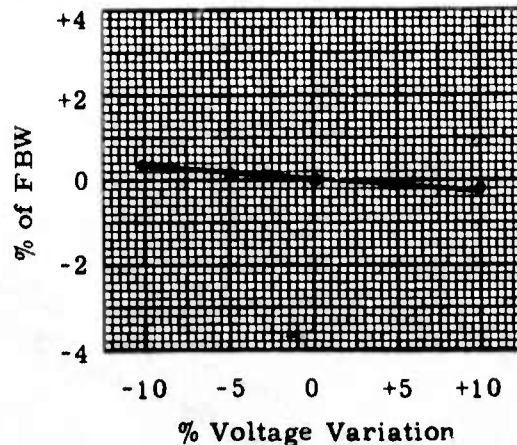

NORTHEASTERN UNIVERSITY

Evaluation Tests - Voltage Controlled Oscillators - Sheet 2

Make: Vector ; Type: MTS-42 ; Serial Number: 7922
 IRIG Band Number: 15 ; FBW: 4500 Hz; Date: 4/23/75 ; By: PJR

VI. Linearity vs. Temperature

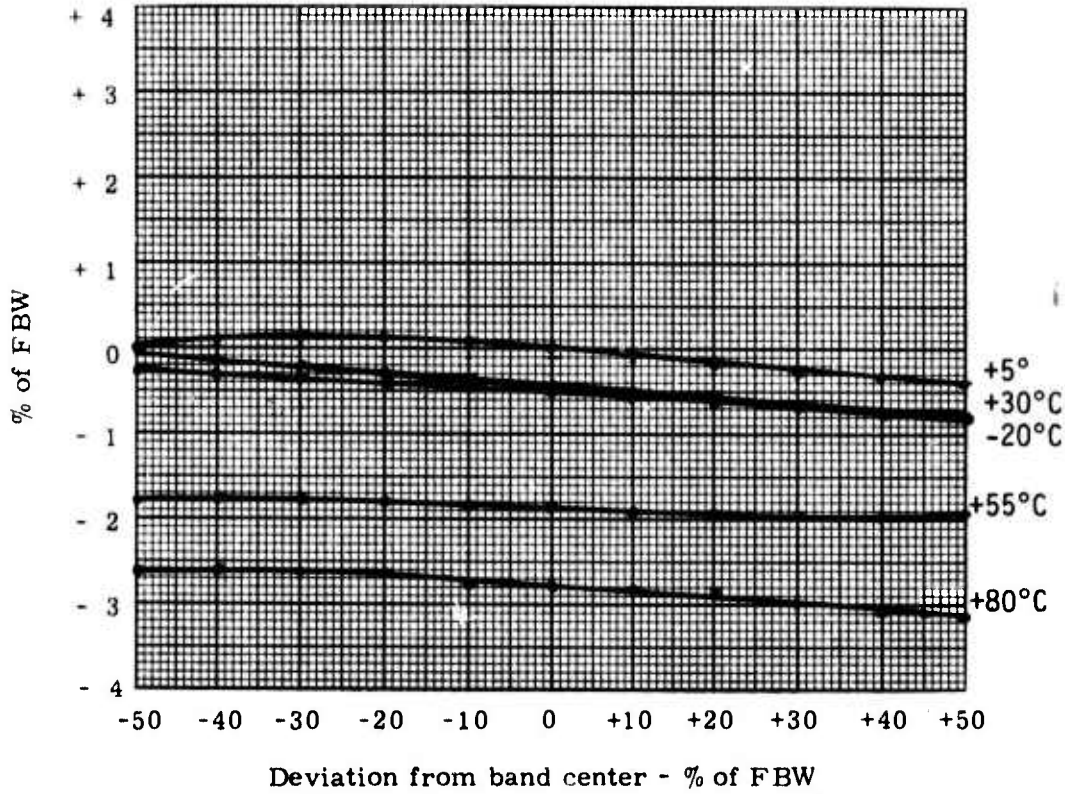

VII. Miscellaneous

1. Power Requirements 117 mw
2. Input Impedence >1MΩ
3. Output Impedence <50KΩ
4. Harmonic Distortion .12%
5. Other Checks LINEARITY

-20°C	±	0.03%	from BSL
+5°C	±	0.14%	from BSL
+30°C	±	0.04%	from BSL
+55°C	±	0.03%	from BSL
+80°C	±	0.02%	from BSL

NORTHEASTERN UNIVERSITY

Evaluation Tests - Voltage Controlled Oscillators - Sheet 1

Make: Vector ; Type: MTS-42 ; Serial Number: 7956 ;
 IRIG Band Number: 17 ; FBW: 7880 Hz; Date: 5/19/75 ; By: PJR

I. Time Drift

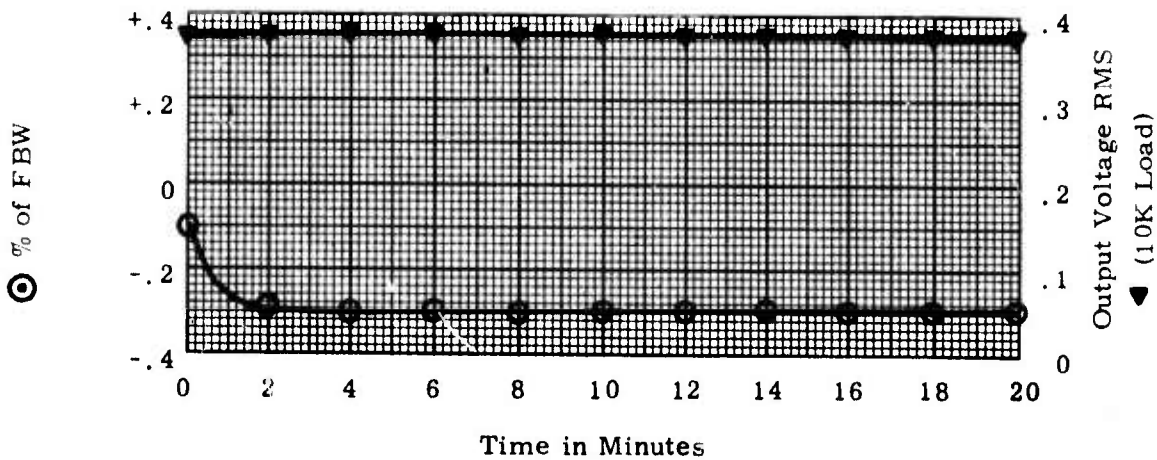

II. Temperature Stability

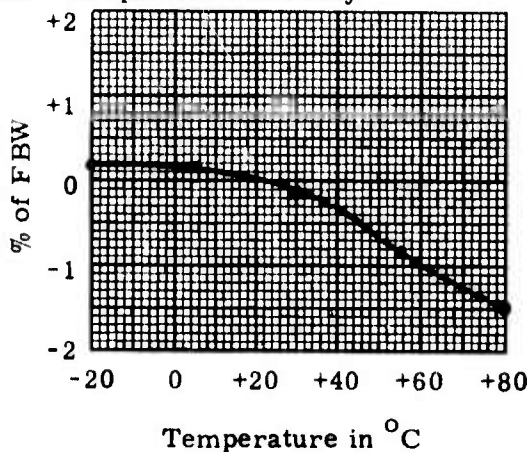

III. Amplitude Modulation

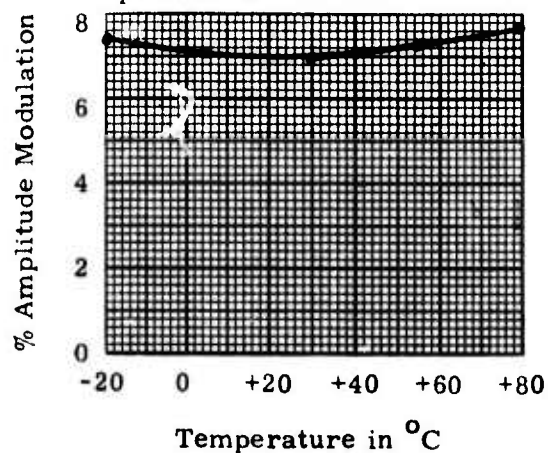

IV. Effects of Source Impedance at Ambient

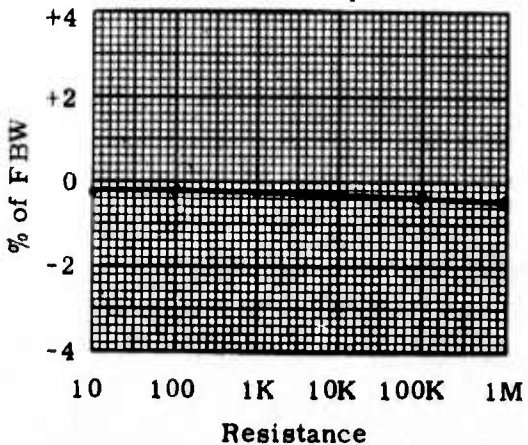

V. B+ Voltage Regulation at Ambient

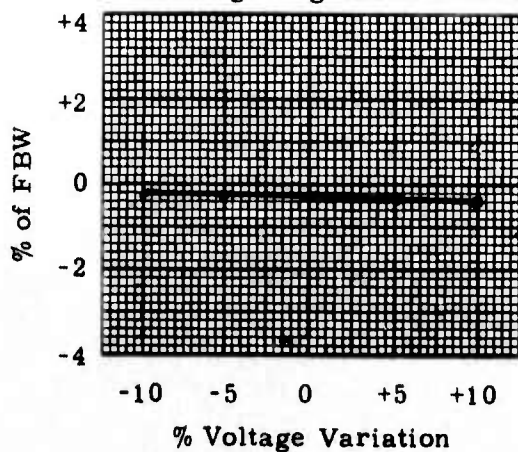

NORTHEASTERN UNIVERSITY

Evaluation Tests - Voltage Controlled Oscillators - Sheet 2

Make: Vector ; Type: MTS-42 ; Serial Number: 7956
 IRIG Band Number: 17 ; FBW: 7880 Hz; Date: 5/19/75 ; By: PJR

VI. Linearity vs. Temperature

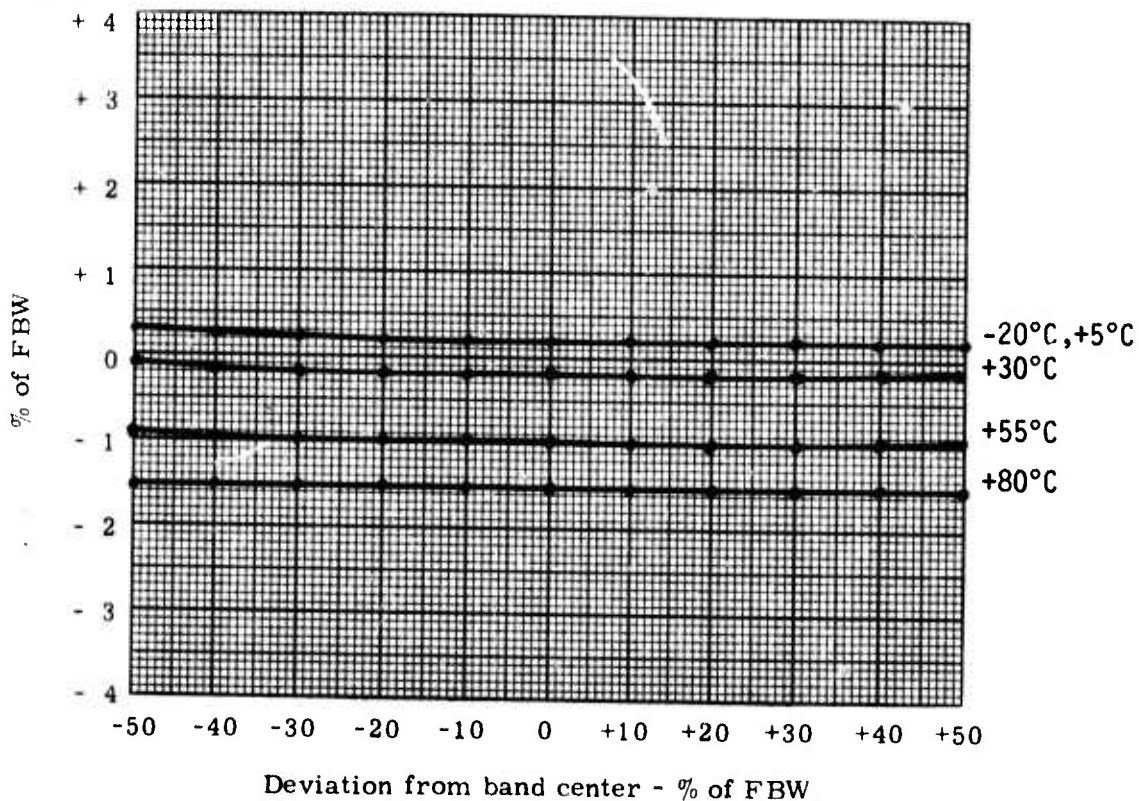

VII. Miscellaneous

1. Power Requirements 120 mw
2. Input Impedance >500KΩ
3. Output Impedance <50KΩ
4. Harmonic Distortion .12%
5. Other Checks LINEARITY

-20°C	±	0.02%	from BSL
+5°C	±	0.02%	from BSL
+30°C	±	0.05%	from BSL
+55°C	±	0.02%	from BSL
+80°C	±	0.01%	from BSL

NORTHEASTERN UNIVERSITY

Evaluation Tests - Voltage Controlled Oscillators - Sheet 1

Make: Vector ; Type: MTS-42 ; Serial Number: 8826
 IRIG Band Number: 10 ; FBW: 810 Hz; Date: 5/19/75 ; By: PJR

I. Time Drift

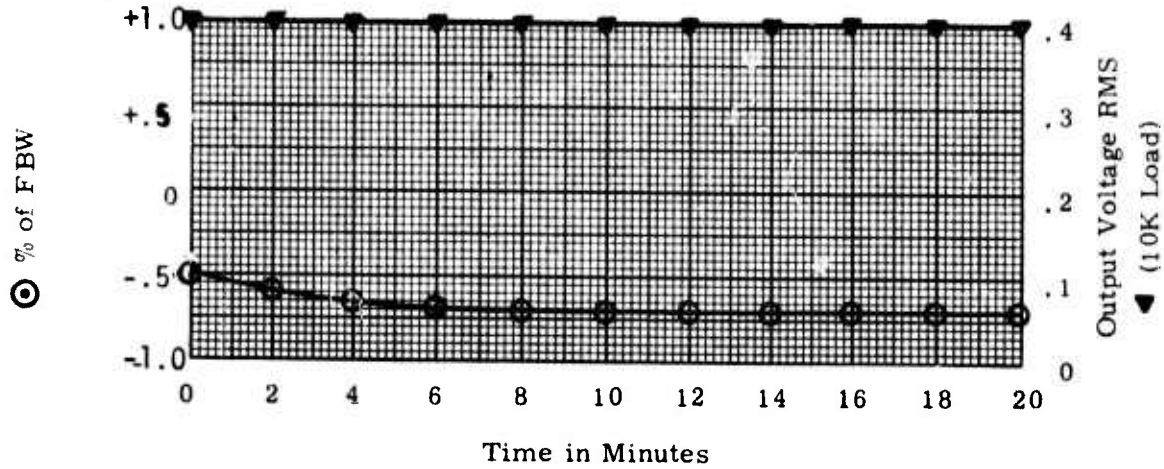

II. Temperature Stability

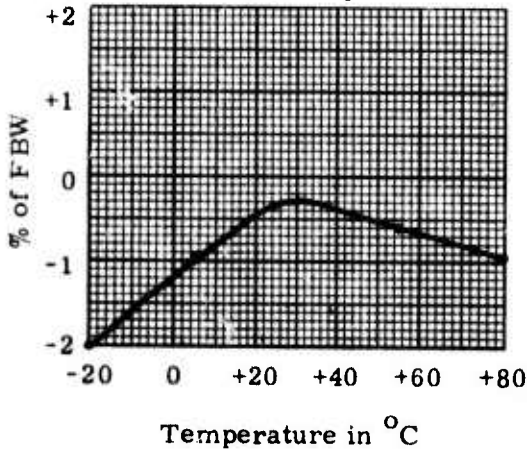

III. Amplitude Modulation

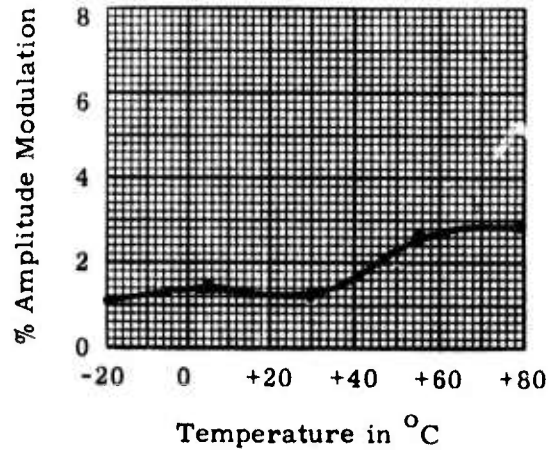

IV. Effects of Source Impedance at Ambient

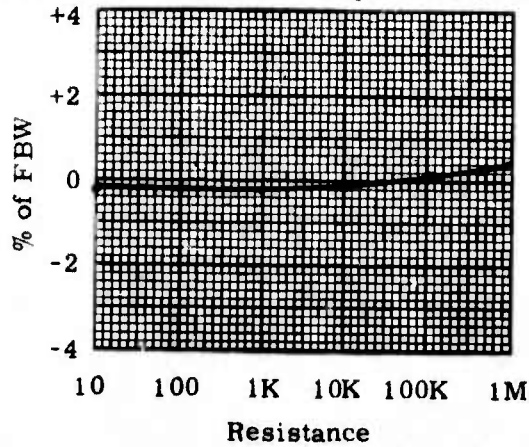

V. B+ Voltage Regulation at Ambient

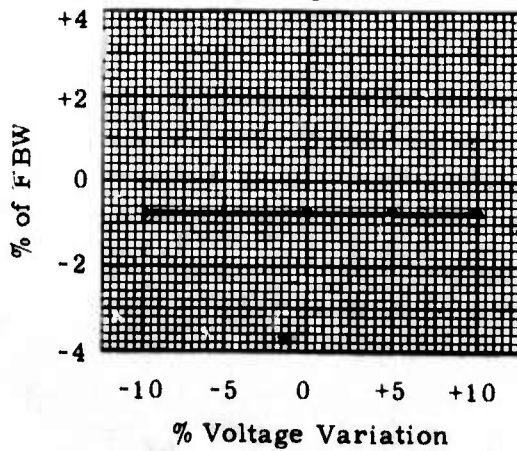

NORTHEASTERN UNIVERSITY

Evaluation Tests - Voltage Controlled Oscillators - Sheet 2

Make: Vector ; Type: MTS-42 ; Serial Number: 8826 ;
 IRIG Band Number: 10 ; FBW: 810 Hz; Date: 5/19/75 ; By: PJR ;

VI. Linearity vs. Temperature

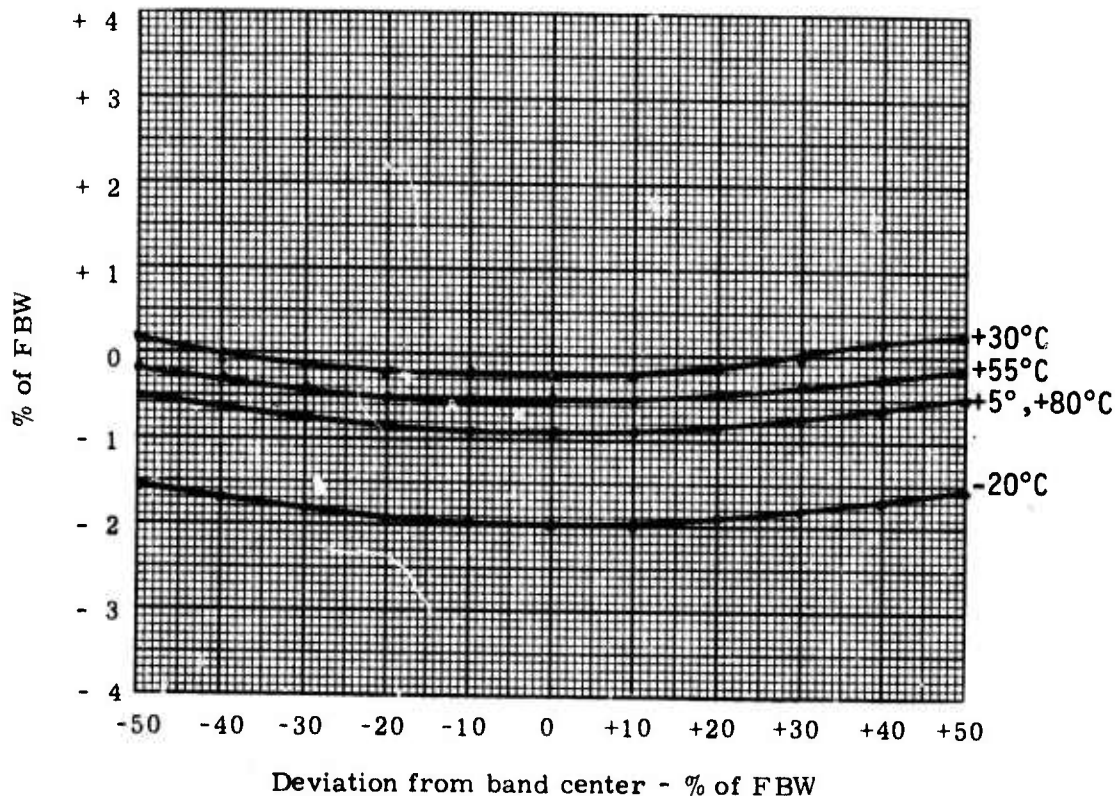

VII. Miscellaneous

1. Power Requirements 112 mw
2. Input Impedence >500KΩ
3. Output Impedence <50KΩ
4. Harmonic Distortion 0.27%
5. Other Checks LINEARITY

-20°C	±	0.45%	from BSL
+5°C	±	0.10%	from BSL
+30°C	±	0.30%	from BSL
+55°C	±	0.15%	from BSL
+80°C	±	0.10%	from BSL

NORTHEASTERN UNIVERSITY

Evaluation Tests - Voltage Controlled Oscillators - Sheet 1

Make: Vector ; Type: MTS-42 ; Serial Number: 8831 ;
 IRIG Band Number: 10 ; FBW: 810 Hz ; Date: 5/19/75 ; By: PJR

I. Time Drift

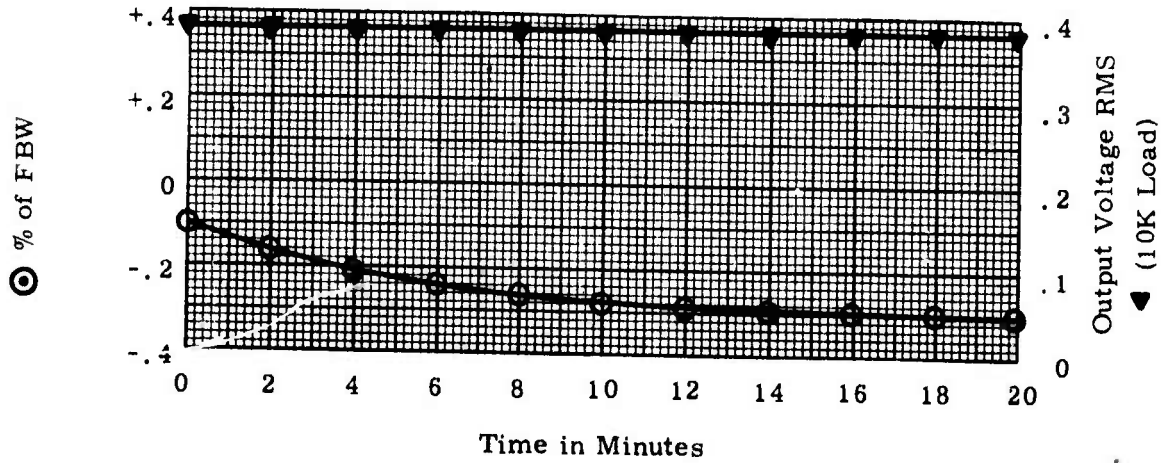

II. Temperature Stability

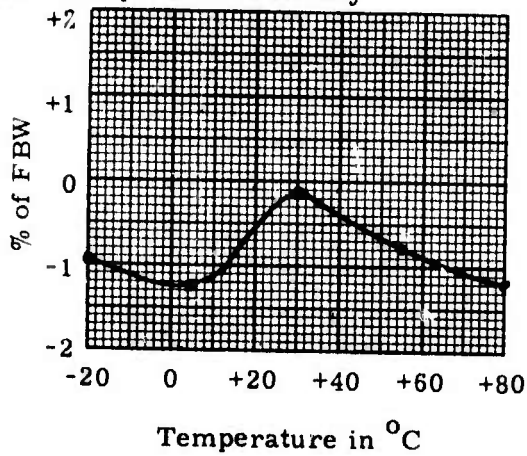

III. Amplitude Modulation

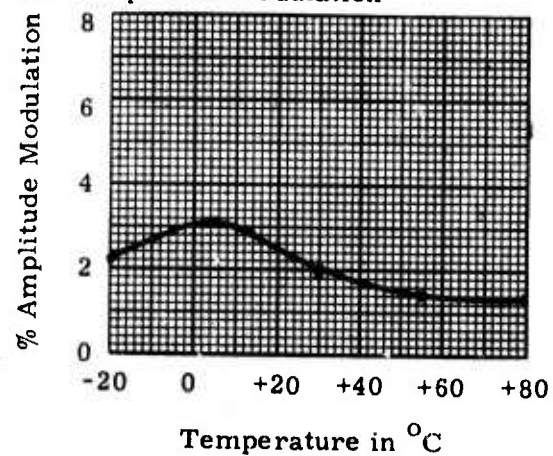

IV. Effects of Source Impedance at Ambient

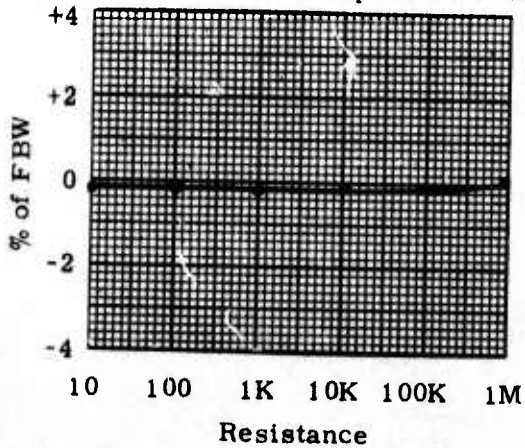

V. B+ Voltage Regulation at Ambient

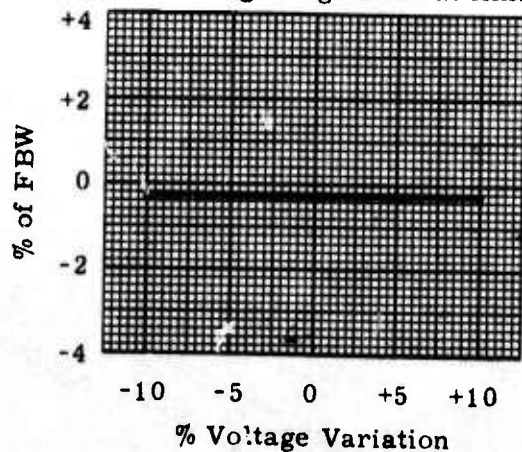

NORTHEASTERN UNIVERSITY

Evaluation Tests - Voltage Controlled Oscillators - Sheet 2

Make: Vector ; Type: MTS-42 ; Serial Number: 8831 ;
 IRIG Band Number: 10 ; FBW: 810 Hz; Date: 5/19/75 ; By: PJR ;

VI. Linearity vs. Temperature

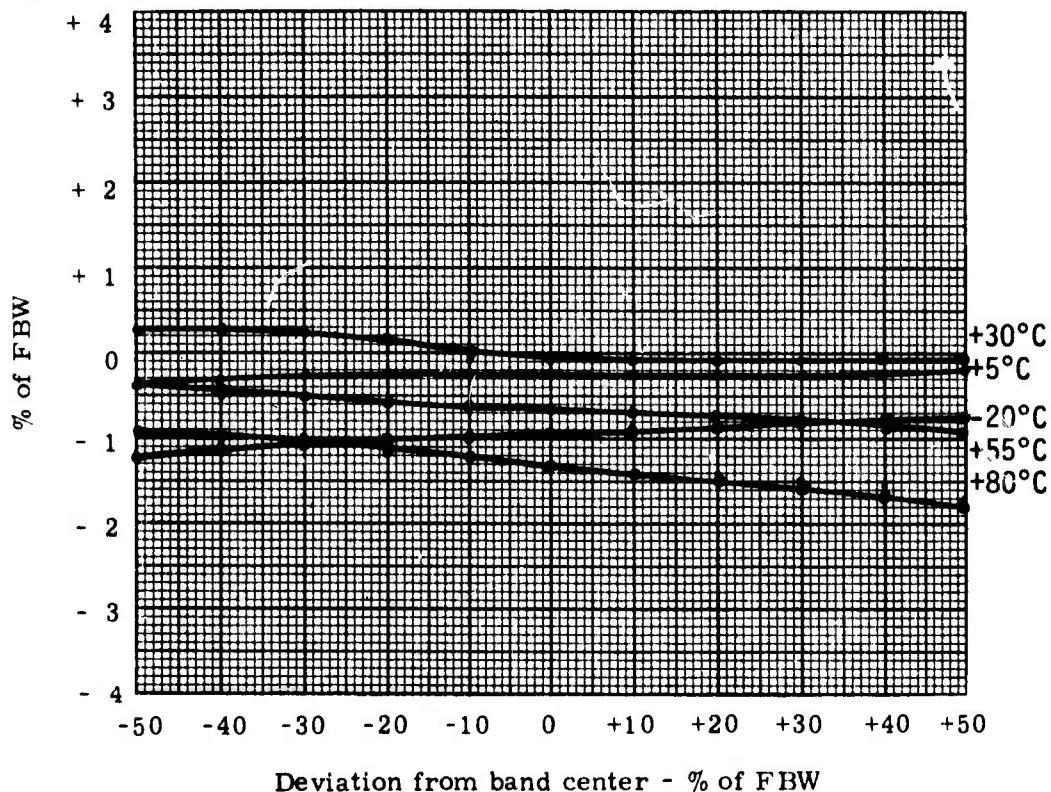

VII. Miscellaneous

1. Power Requirements 131 mw
2. Input Impedence >500KΩ
3. Output Impedence <50KΩ
4. Harmonic Distortion 0.11%
5. Other Checks LINEARITY

-20°C	±	0.09%	from BSL
+5°C	±	0.09%	from BSL
+30°C	±	0.10%	from BSL
+55°C	±	0.05%	from BSL
+80°C	±	0.05%	from BSL

NORTHEASTERN UNIVERSITY

Evaluation Tests - Voltage Controlled Oscillators - Sheet 1

Make: Vector ; Type: MTS-42 ; Serial Number: 8894 ;
 IRIG Band Number: 13 ; FBW: 2176 Hz ; Date: 5/19/75 ; By: PJR ;

I. Time Drift

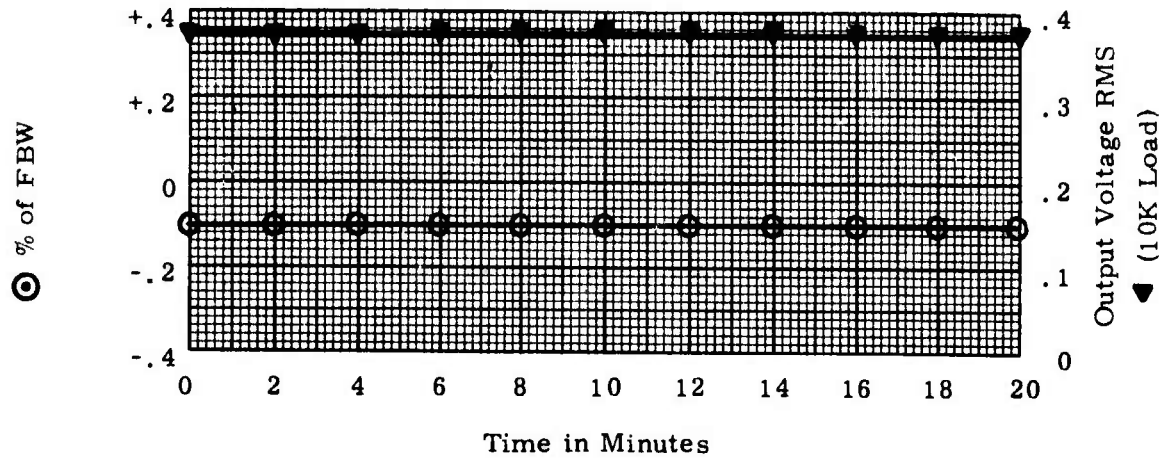

II. Temperature Stability

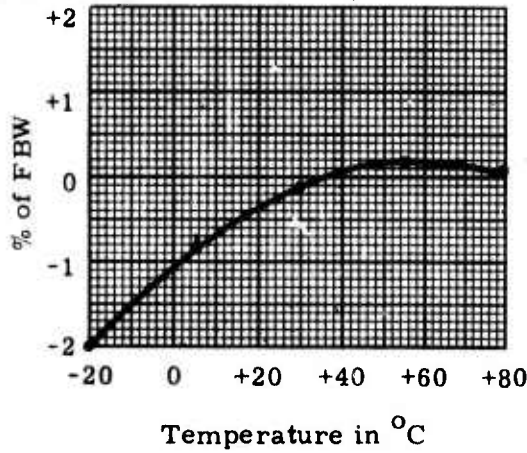

III. Amplitude Modulation

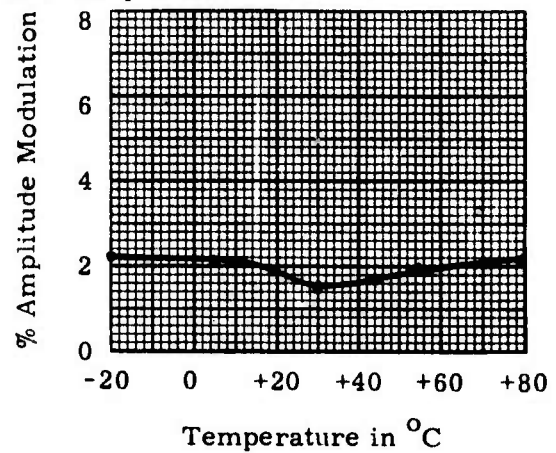

IV. Effects of Source Impedence at Ambient

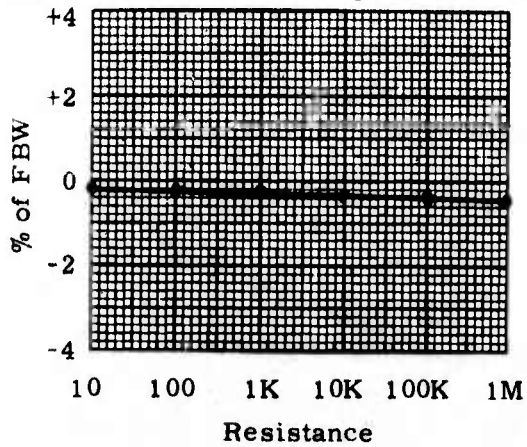

V. B+ Voltage Regulation at Ambient

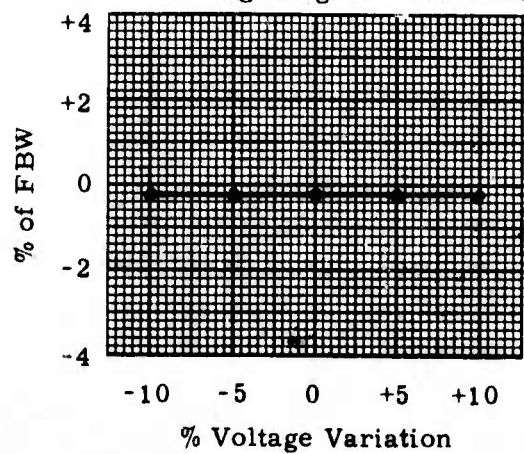

NORTHEASTERN UNIVERSITY

Evaluation Tests - Voltage Controlled Oscillators - Sheet 2

Make: Vector ; Type: MTS-42 ; Serial Number: 8894 ;
 IRIG Band Number: 13 ; FBW: 2176 Hz ; Date: 5/19/75 ; By: PJR ;

VI. Linearity vs. Temperature

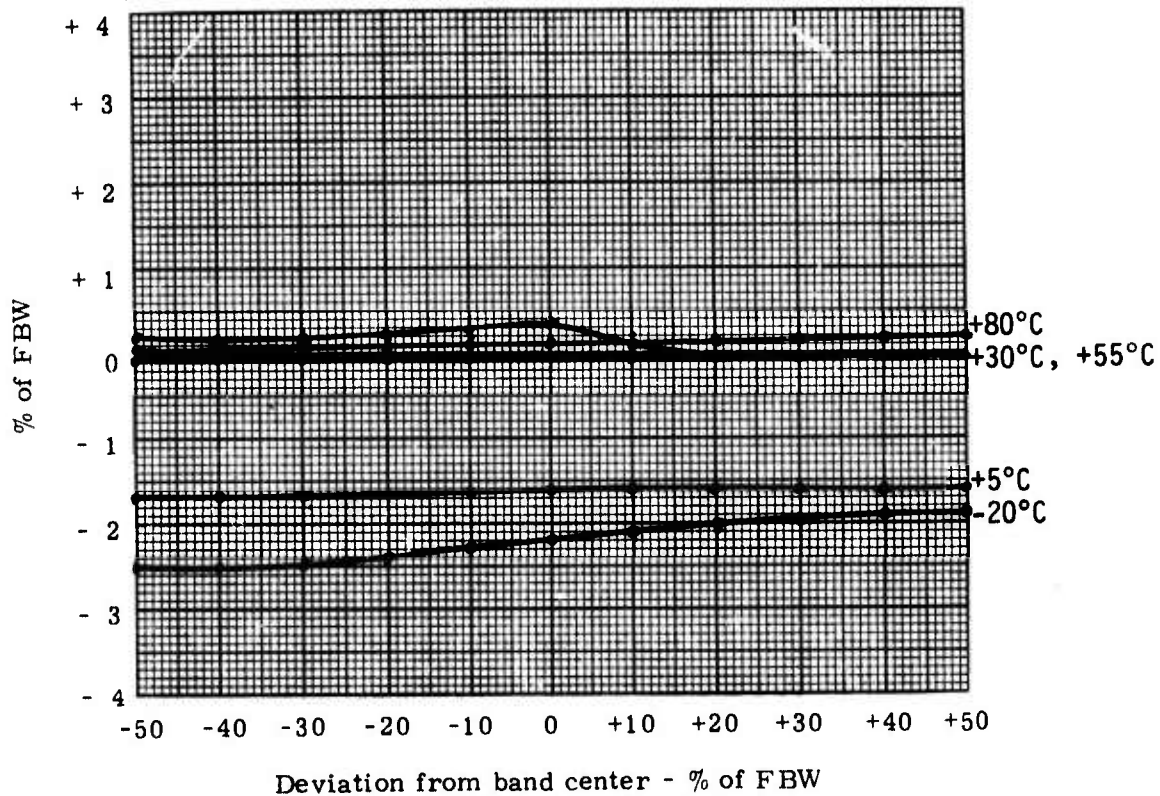

VII. Miscellaneous

1. Power Requirements 126 mw
2. Input Impedence >500KΩ
3. Output Impedence <50KΩ
4. Harmonic Distortion 0.18%
5. Other Checks LINEARITY

-20°C	± 0.15%	from BSL
+5°C	± 0.04%	from BSL
+30°C	± 0.04%	from BSL
+55°C	± 0.15%	from BSL
+80°C	± 0.05%	from BSL

NORTHEASTERN UNIVERSITY

Evaluation Tests - Voltage Controlled Oscillators - Sheet 1

Make: Vector ; Type: MTS-42 ; Serial Number: 8918 ;
 IRIG Band Number: 15 ; FBW: 4500 Hz ; Date: 5/19/75 ; By: PJR

I. Time Drift

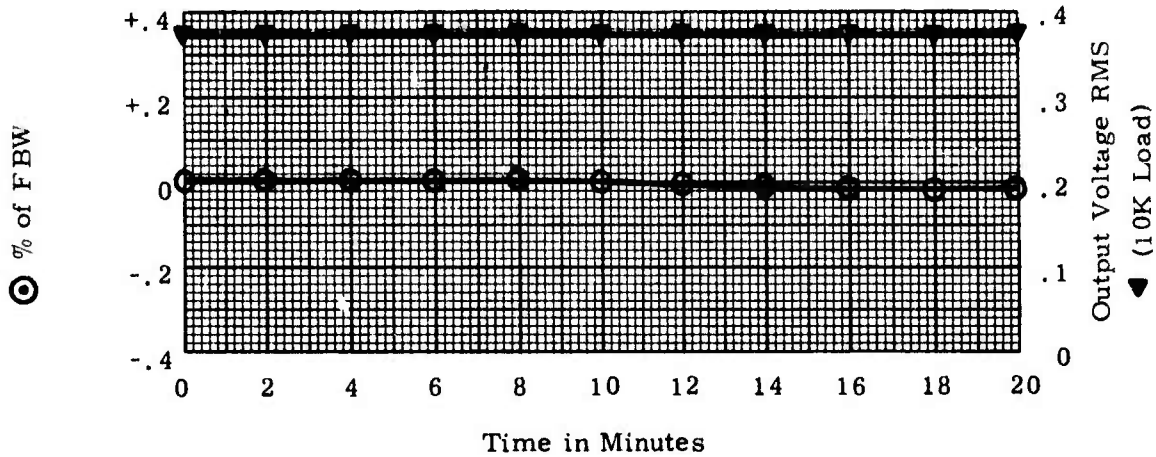

II. Temperature Stability

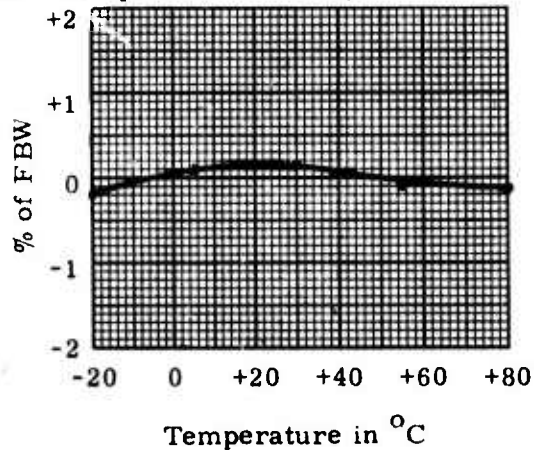

III. Amplitude Modulation

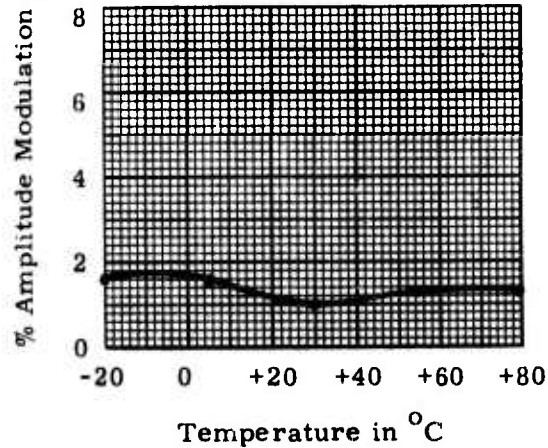

IV. Effects of Source Impedance at Ambient

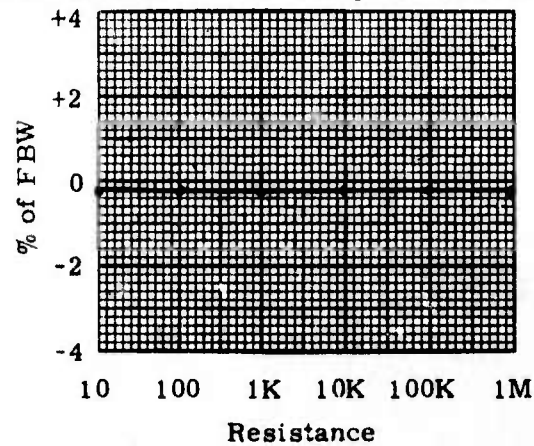

V. B+ Voltage Regulation at Ambient

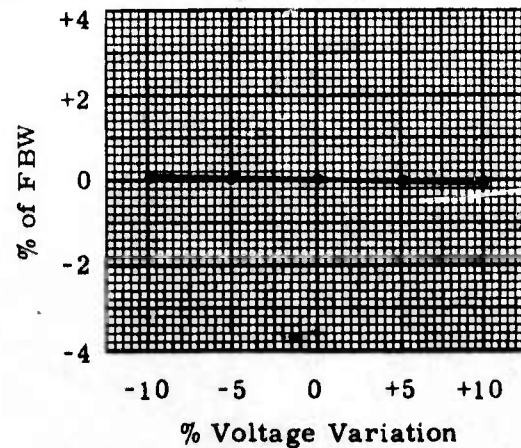

NORTHEASTERN UNIVERSITY

Evaluation Tests - Voltage Controlled Oscillators - Sheet 2

Make: Vector ; Type: MTS-42 ; Serial Number: 8918 ;
 IRIG Band Number: 15 ; FBW: 4500 Hz ; Date: 5/19/75 ; By: PJR

VI. Linearity vs. Temperature

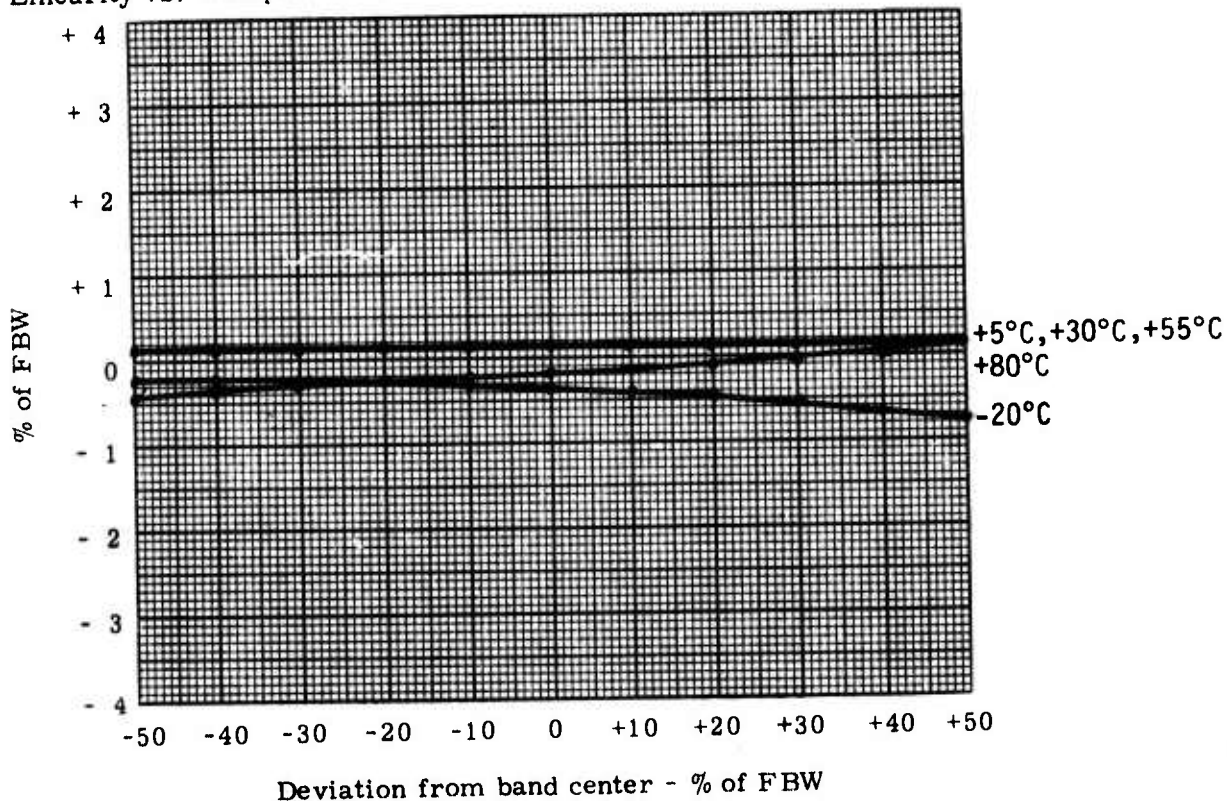

VII. Miscellaneous

1. Power Requirements 123 mw
2. Input Impedence >500KΩ
3. Output Impedence <50KΩ
4. Harmonic Distortion 0.31%
5. Other Checks LINEARITY

-20°C	±	0.09%	from BSL
+5°C	±	0.02%	from BSL
+30°C	±	0.02%	from BSL
+55°C	±	0.08%	from BSL
+80°C	±	0.12%	from BSL

NORTHEASTERN UNIVERSITY

Evaluation Tests - Voltage Controlled Oscillators - Sheet 1

Make: Vector ; Type: MTS-42 ; Serial Number: 8935
 IRIG Band Number: 15 ; FBW: 4800 Hz ; Date: 5/19/75 ; By: PJR

I. Time Drift

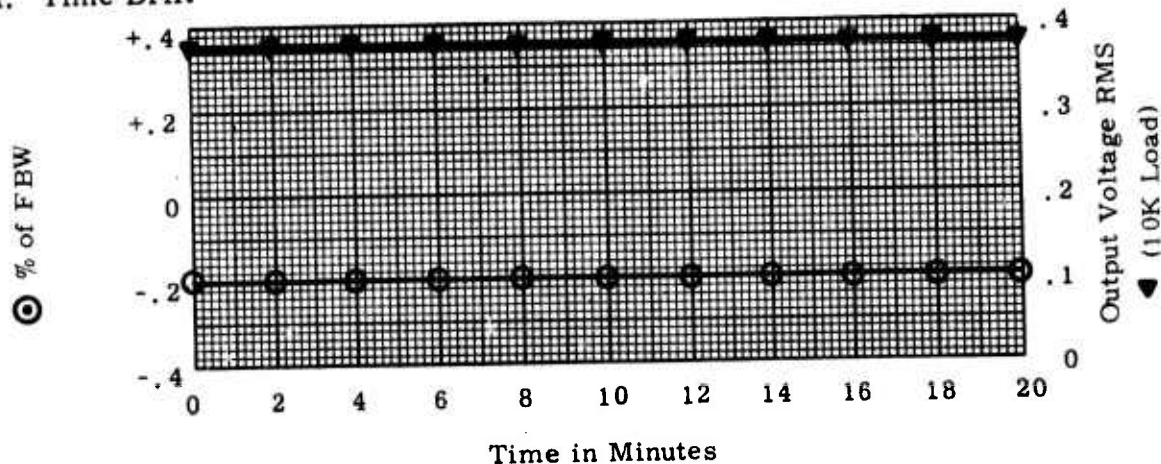

II. Temperature Stability

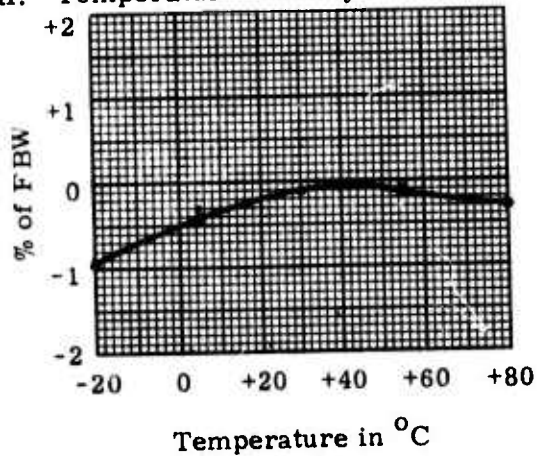

III. Amplitude Modulation

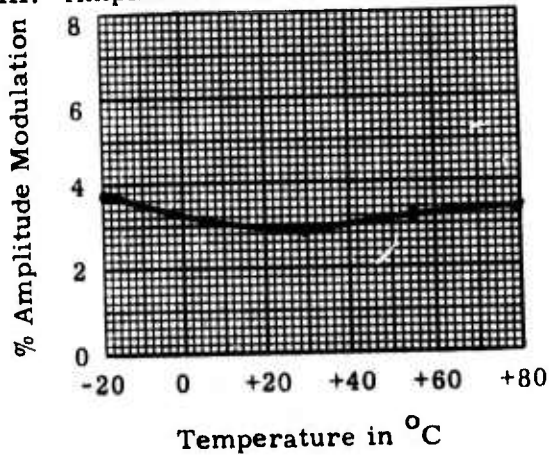

IV. Effects of Source Impedance at Ambient

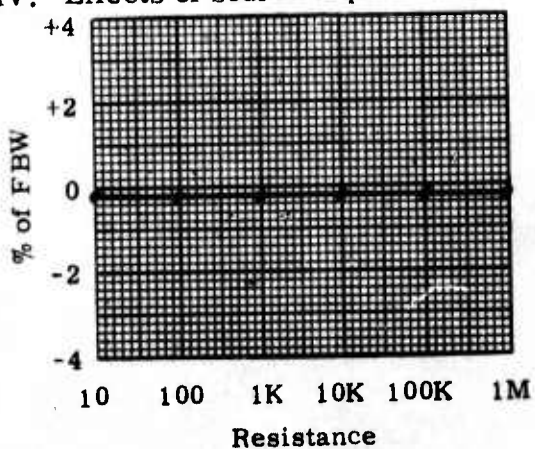

V. B+ Voltage Regulation at Ambient

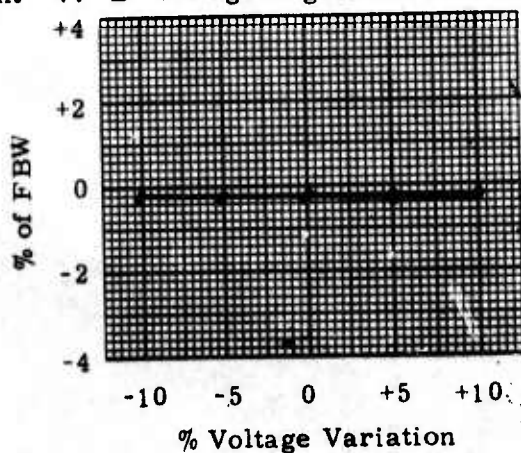

NORTHEASTERN UNIVERSITY

Evaluation Tests - Voltage Controlled Oscillators - Sheet 2

Make: Vector ; Type: MTS-42 ; Serial Number: 8935
 IRIG Band Number: 15 ; FBW: 4800 Hz ; Date: 5/19/75 ; By: PJR

VI. Linearity vs. Temperature

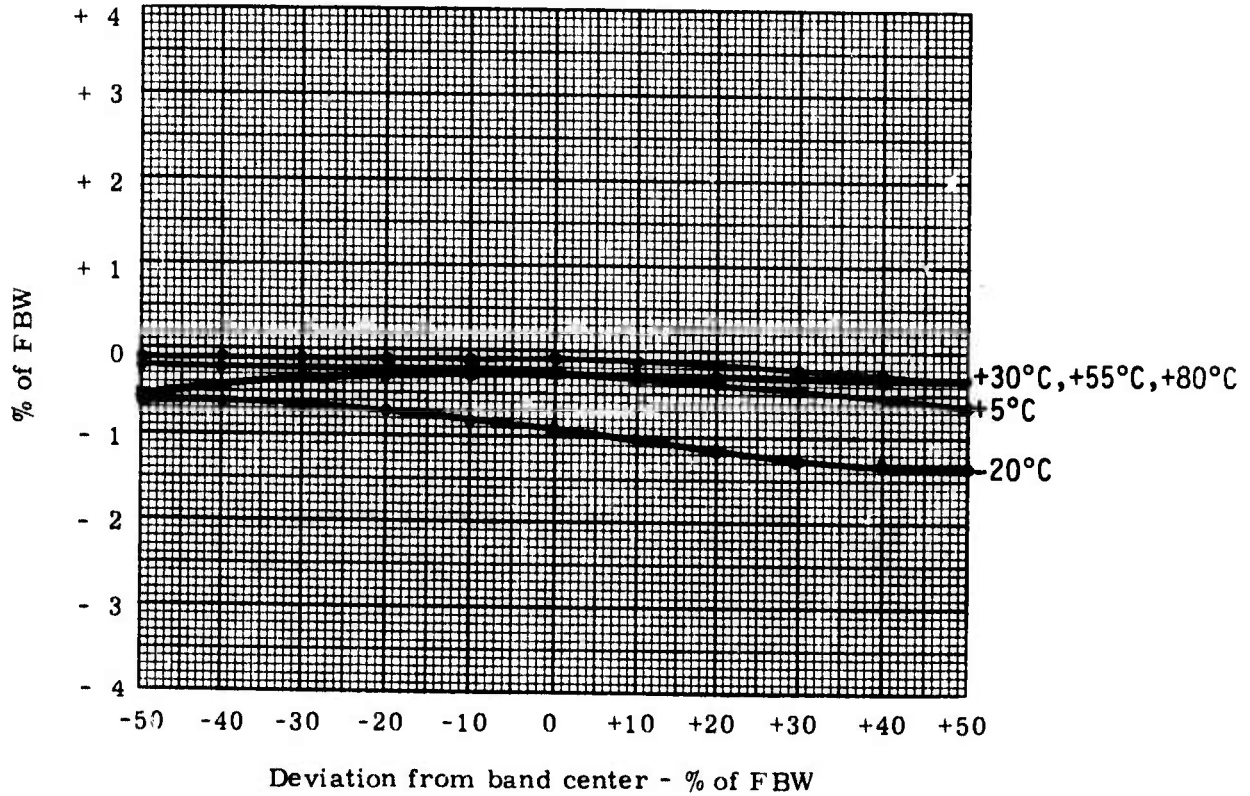

VII. Miscellaneous

1. Power Requirements 126 mW
2. Input Impedance >500KΩ
3. Output Impedance <50KΩ
4. Harmonic Distortion 0.3%
5. Other Checks LINEARITY

-20°C	±	0.04%	from BSL
+5°C	±	0.04%	from BSL
+30°C	±	0.06%	from BSL
+55°C	±	0.07%	from BSL
+80°C	±	0.11%	from BSL

NORTHEASTERN UNIVERSITY

Evaluation Tests - Voltage Controlled Oscillators - Sheet 1

Make: Vector; Type: MTS-42; Serial Number: 8964
 IRIG Band Number: 17; FBW: 7880 Hz; Date: 5/19/75; By: PJR

I. Time Drift

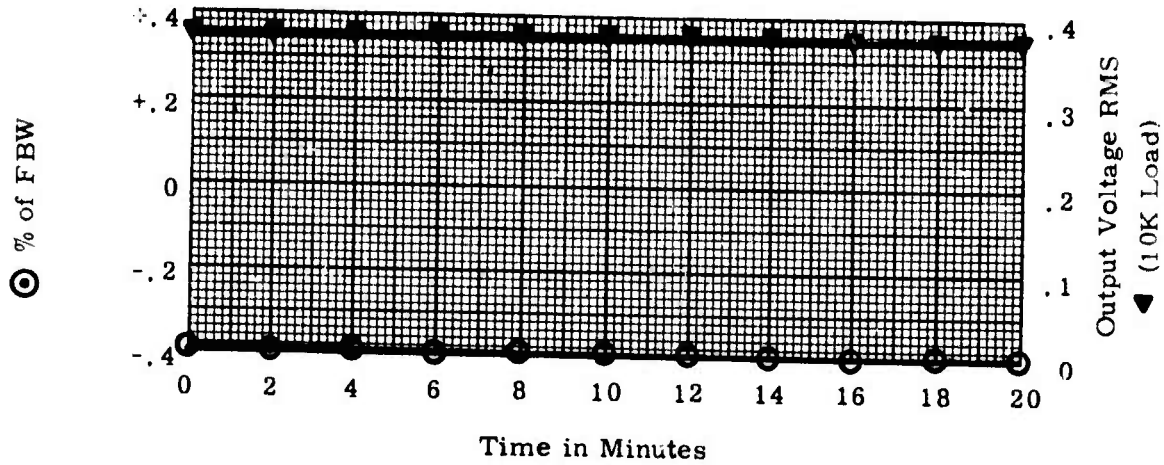

II. Temperature Stability

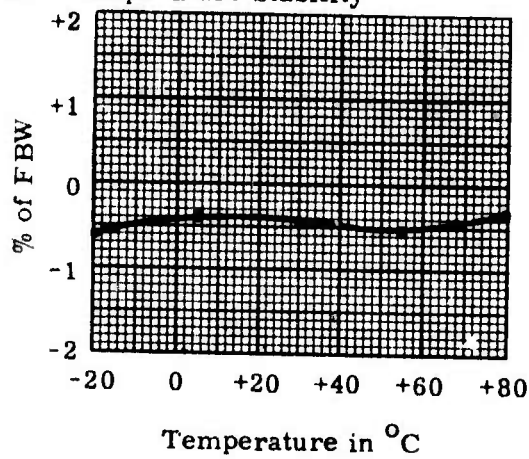

III. Amplitude Modulation

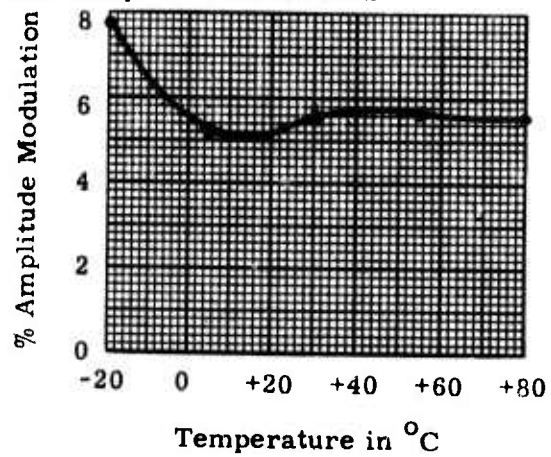

IV. Effects of Source Impedance at Ambient

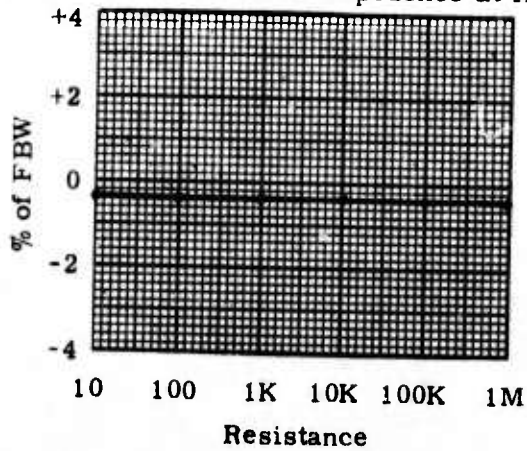

V. B+ Voltage Regulation at Ambient

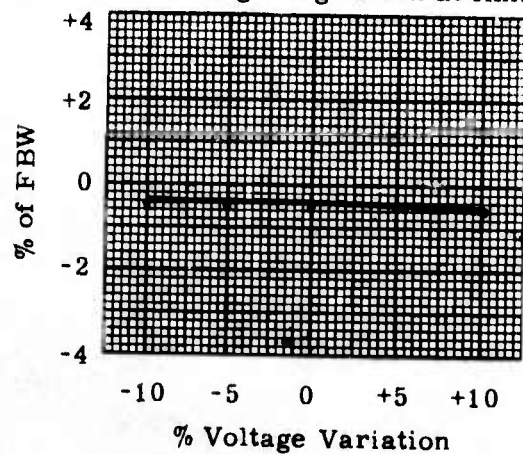

NORTHEASTERN UNIVERSITY

Evaluation Tests - Voltage Controlled Oscillators - Sheet 2

Make: Vector ; Type: MTS-42 ; Serial Number: 8964 ;
 IRIG Band Number: 17 ; FBW: 7880 Hz ; Date: 5/19/75 ; By: PJR ;

VI. Linearity vs. Temperature

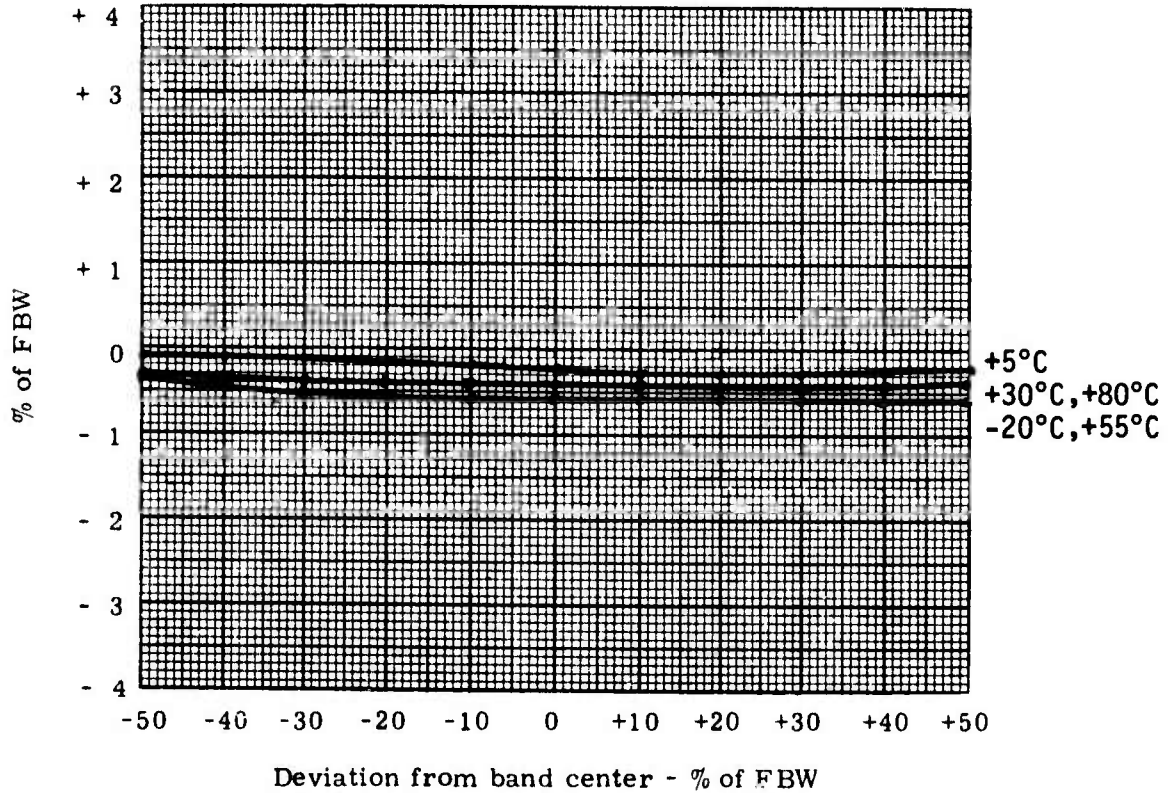

VII. Miscellaneous

1. Power Requirements	<u>126 mw</u>
2. Input Impedence	<u>>500 KΩ</u>
3. Output Impedence	<u><50KΩ</u>
4. Harmonic Distortion	<u>0.075%</u>
5. Other Checks	<u>LINEARITY</u>
-20°C ±	<u>0.06% from BSL</u>
+5°C ±	<u>0.05% from BSL</u>
+30°C ±	<u>0.05% from BSL</u>
+55°C ±	<u>0.06% from BSL</u>
+80°C ±	<u>0.05% from BSL</u>

PERSONNEL

J. Spencer Rochefort, Professor of Electrical Engineering, Principal Investigator.

Lawrence J. O'Connor, Senior Research Associate of Electrical Engineering, Eng.

Richard H. Marks, Technician, Electrical Engineering.

John F. Eschle, Project Assistant.

David A. Chase, Project Assistant.

Mark Soo Hoo, Project Assistant.

Phyllip J. Ryan, Project Assistant.

Kwang Y. Lee, Project Assistant.

SUPPLEMENTARY

INFORMATION

AD-13012 292

TABLE OF CONTENTS

TITLE PAGE - - - - -	Page
DISTRIBUTION - - - - -	i
ABSTRACT - - - - -	ii
TABLE OF CONTENTS - - - - -	iii
INTRODUCTION - - - - -	iv
	1

RF Telemetry Transmitters

CHAPTER I.	A. Evaluation Test Procedures for RF Telemetry Transmitters - - - - -	2
	B. Test Results for RF Telemetry Transmitters - - - - -	12

<u>Manufacturer</u>	<u>Type</u>	<u>Serial No.</u>	<u>Freq. (MHz)</u>	
CONIC	CTP-402	402P191	234.0	13
CONIC	CTP-402	402P192	234.0	17
CONIC	CTP-402	402P193	240.2	20
CONIC	CTP-402	402P194	240.2	23
CONIC	CTP-402	402P195	244.3	26
CONIC	CTP-402	402P196	244.3	29
CONIC	CTS-402	4020319	2259.5	32
CONIC	CTS-402	4020558	2251.5	36
CONIC	CTS-402	4020599	2251.5	39
CONIC	CTS-402	4021093	2251.5	42
CONIC	CTS-402	4021094	2251.5	45
CONIC	CTS-402	4021095	2251.5	48
CONIC	CTS-402	4021096	2279.5	51
CONIC	CTS-402	4021097	2279.5	54
CONIC	CTS-402	4021098	2279.5	57
CONIC	CTS-402	4021099	2259.5	60
CONIC	CTS-402	4021100	2259.5	63
CONIC	CTS-402	4021101	2259.5	66
CONIC	CTS-402	4021102	2259.5	69
CONIC	CTS-402	4021103	2259.5	72
CONIC	CTS-402	4021104	2269.5	75
CONIC	CTS-402	4021106	2269.6	78
CONIC	CTS-402	4021107	2269.5	81

TABLE OF CONTENTS (continued)

<u>Manufacturer</u>	<u>Type</u>	<u>Serial No.</u>	<u>Freq.(MHz)</u>	<u>Page</u>
RAYTHEON	T-201	020	2228.5	84
RAYTHEON	T-201	022	2219.5	88
VECTOR	T105S	550	2259.5	91
VECTOR	T202S	201	2220.5	95
VECTOR	T202S	202	2220.5	99

CHAPTER II. Voltage - Controlled Subcarrier Oscillators

A. Evaluation Test Procedure for Voltage - Controlled Subcarrier Oscillators - - - - -	102
B. Test Results for Voltage - Controlled Subcarrier Oscillators - - - - -	112

<u>Manufacturer</u>	<u>Type</u>	<u>Serial No.</u>	<u>Band</u>	
OMNITEK	40A1	3168	6	113
OMNITEK	40A1	3169	6	116
OMNITEK	40A1	3170	13	118
OMNITEK	40A1	3171	13	120
OMNITEK	40A1	3172	18	122
OMNITEK	40A1	3173	18	124
VECTOR	MMO-11	24774	18	126
VECTOR	MMO-11	32493	16	129
VECTOR	MMO-11	51409	12	131
VECTOR	MMO-11	51432	12	133
VECTOR	MMO-11	51491	14	135
VECTOR	MMO-11	51518	14	137
VECTOR	MMO-11	51661	16	139
VECTOR	MMO-11	51940	15	141
VECTOR	MMO-11	51954	15	143
VECTOR	MMO-11	52377	13	145
VECTOR	MMO-11	52378	13	147
VECTOR	MMO-11	52406	17	149
VECTOR	MMO-11	52422	17	151
VECTOR	MMO-11	54168	18	153
VECTOR	MTS-42	7499	12	155
VECTOR	MTS-42	7744	7	158
VECTOR	MTS-42	7762	7	160

Page 30 is not available.