

UNCLASSIFIED

AD NUMBER

ADB016691

LIMITATION CHANGES

TO:

Approved for public release; distribution is unlimited.

FROM:

Distribution authorized to U.S. Gov't. agencies only; Test and Evaluation; NOV 1976. Other requests shall be referred to Air Force Weapons Lab., Kirtland AFB, NM 87117.

AUTHORITY

AFWL ltr 7 Nov 1986

THIS PAGE IS UNCLASSIFIED

AD Bo 16691

AUTHORITY:

AFWL etc,

7 NOV 86



L

AFWL-TR-75-249, Vol. II

(2)

FG

AFWL-TR-75-249
Vol. II

ADB016691

HARD PAN I TEST SERIES-TEST AND INSTRUMENTATION PLANS

Volume II
Instrumentation Plan

G.E. TEMPO (DASIAC)
Albuquerque, New Mexico 87110

November 1976

Final Report

**COPY AVAILABLE TO DDC DOES NOT
PERMIT FULLY LEGIBLE PRODUCTION**



Distribution limited to US Government agencies only because test and evaluation information concerning military systems is discussed in the report (Nov 76). Other requests for this document must be referred to AFWL/DEP, Kirtland AFB, NM 87117.

This research was sponsored by the Defense Nuclear Agency under Subtask L35JAXYX971, Work Unit 01, Work Unit Title, Construction Support for SAMSO Structure Program.

Prepared for
Director
DEFENSE NUCLEAR AGENCY
Washington, DC 20305

SPACE AND MISSILE SYSTEMS ORGANIZATION
Los Angeles, CA 90009

AIR FORCE WEAPONS LABORATORY
Air Force Systems Command
Kirtland Air Force Base, NM 87117

**DDC
RECEIVED
FEB 28 1977
A**

AD No. []
DDC FILE COPY

This final report was prepared by G.E. TEMPO, Albuquerque, New Mexico, under Contract DNA-001-75-C-0056, Job Order 133B1412 with the Air Force Weapons Laboratory, Kirtland Air Force Base, New Mexico. Captain McNickle (DEP) was the Laboratory Project Officer-in-Charge.

When US Government agencies, specifications, or other data are used for any purpose other than a definitely related Government procurement operation, the Government thereby incurs no responsibility nor any obligation whatsoever, and the fact that the Government may have formulated, furnished, or in any way supplied the said drawings, specifications, or other data is not to be regarded by implication or otherwise as in any manner licensing the holder or any other person or corporation or conveying any rights or permission to manufacture, use, or sell any patented invention that may in any way be related thereto.

This technical report has been reviewed and is approved for publication.

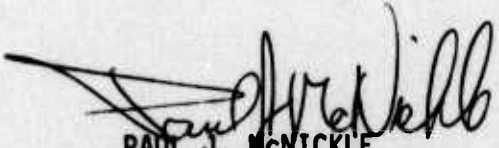
PAUL J. McNICKLE
Captain, USAF
Project Officer

FOR THE COMMANDER

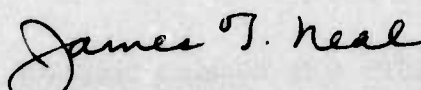
JAMES T. NEAL
Lt Colonel, USAF
Chief, Special Projects Branch

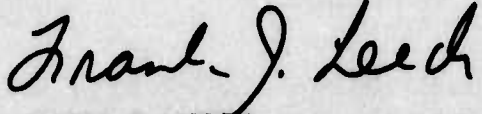
FRANK J. LEECH
Lt Colonel, USAF
Chief, Civil Engineering Research Division

DO NOT RETURN THIS COPY. RETAIN OR DESTROY.



UNCLASSIFIED

SECURITY CLASSIFICATION OF THIS PAGE (When Data Entered)

REPORT DOCUMENTATION PAGE		READ INSTRUCTIONS BEFORE COMPLETING FORM
1. REPORT NUMBER AFWL-TR-75-249, Vol. II	2. GOVT ACCESSION NO.	3. REPORT'S CATALOG NUMBER 9
4. TITLE (and Subtitle) HARD PAN I TEST SERIES - TEST AND INSTRUMENTATION PLANS. Volume II, Instrumentation Plan.		5. TYPE OF REPORT & PERIOD COVERED Final Report
7. AUTHOR(s) Stephen G. McGrath, USAF		6. PERFORMING ORG. REPORT NUMBER
9. PERFORMING ORGANIZATION NAME AND ADDRESS GE TEMPO (DASIAC) 7800 Marble N.E. Albuquerque, NM 87110		8. CONTRACT OR GRANT NUMBER(s) DNA 001-75-C-0056
11. CONTROLLING OFFICE NAME AND ADDRESS AF Weapons Laboratory SAMS0 Kirtland AFB, NM 87117 WWPC Los Angeles, CA 90009		10. PROGRAM ELEMENT, PROJECT, TASK AREA & WORK UNIT NUMBERS 11213F 133B1412
14. MONITORING AGENCY NAME & ADDRESS (if different from Controlling Office) Director Defense Nuclear Agency Washington, D.C. 20305		12. REPORT DATE November 76
16. DISTRIBUTION STATEMENT (of this Report) Distribution limited to US Government agencies only because test and evaluation information concerning military systems is discussed in the report (Nov 76). Other requests for this document must be referred to AFWL (DEP), Kirtland AFB, NM 87117.		13. NUMBER OF PAGES 196
17. DISTRIBUTION STATEMENT (of the abstract entered in block 20, if different from Report) AFWL TR-75-249-Vol-2		14. SECURITY CLASS. (of this report) UNCLASSIFIED
18. SUPPLEMENTARY NOTES This research was sponsored by the Defense Nuclear Agency under Subtask L35JAXYX971. Work Unit 01, Work Unit Title: Construction Support for SAMS0 Structure Program.		15a. DECLASSIFICATION/DOWNGRADING SCHEDULE
19. KEY WORDS (Continue on reverse side if necessary and identify by block number) Nuclear Weapons Effects Airblast Structure Response Ground Shock Silos Nuclear Weapons Simulation Launch Facilities High-explosive Structure Medium Interaction (SMI)		
20. ABSTRACT (Continue on reverse side if necessary and identify by block number) The objective, test configurations, and instrumentation implementation of the HARD PAN I test series are presented in three volumes. Volume I describes the high-explosive test events (5 major and 13 calibration events) performed to obtain experimental measurements of the shock environment in the vicinity of a test structure in a layered geology due to a simulated near-surface nuclear detonation. The test geology was clay over interbedded limestone and shale. Structure medium interaction (SMI) data obtained in the test series is to be		

DD FORM 1473 1 JAN 73 EDITION OF 1 NOV 68 IS OBSOLETE

UNCLASSIFIED

SECURITY CLASSIFICATION OF THIS PAGE (When Data Entered)

409 448

Handwritten signature

UNCLASSIFIED

SECURITY CLASSIFICATION OF THIS PAGE(When Data Entered)

(Blk 20)

used in development of prediction codes for use in analyses relating to facility design, modification, and hardness validation and/or assessment. Berm-loaded explosive simulation technique (BLEST), a new technique for high-explosive simulation of nuclear detonation effects, is described. The first use of BLEST was in the HARD PAN I series where it augmented the more precise HEST used to provide direct airblast loading, and increased total simulation times at acceptable additional cost. Volume I also includes specific operational plans (safety, communications, security) and data analysis requirements. Volume II (Appendix P) describes the instrumentation systems used to obtain motion, stress, and strain data from free-field and structure locations in the first three major events and the calibration events. Measurements lists are included. Volume III (Appendix P, continued) describes the instrumenting of the final two major events and lists all measurements.

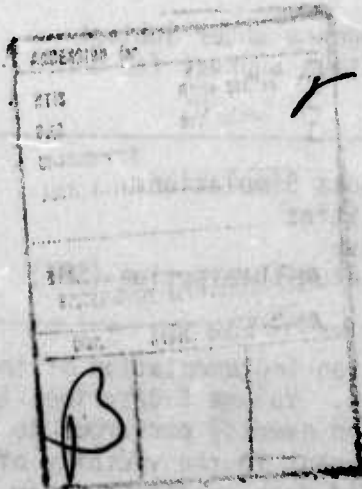

UNCLASSIFIED

SECURITY CLASSIFICATION OF THIS PAGE(When Data Entered)

CONTENTS

Volume 2

<u>Part</u>		<u>Page</u>
1	HARD PAN I-1 EVENT	2
	1. Test Site Layout	2
	2. Measurement Requirements	3
	3. Channel Record Assignments	6
2	HARD PAN I-2A EVENT	39
	1. Test Site Layout	39
	2. Coordinate Systems	39
	3. Measurement Requirements	39
	4. Channel Record Assignments	43
3.	HARD PAN I SCAL EVENTS	90
	1. Description of SCAL Tests	90
	2. SCAL I Instrumentation	90
	3. SCAL II Instrumentation	91
	4. SCAL III Instrumentation	91
	5. SCAL IV Instrumentation	91
4.	HARD PAN ICAL EVENTS	118
	1. Description of Tests	118
	2. Instrumentation	119
5.	HARD PAN HBL EVENTS	152
	1. Description of HBL I	152
	2. Instrumentation of HBL I Event	152
	3. Description of HBL II	152
	4. Instrumentation of HBL II Event	153
	5. Description of HBL III	153
	6. Instrumentation of HBL III Event	154

APPENDIX P

HARD PAN I INSTRUMENTATION PLANS

This Appendix describes the instrumentation of the HARD PAN I series of high explosive tests conducted near Trading Post, Kansas in the period October 1974 to December 1975. Since Volume I (the Test Plan) of this series describes the configurations and objectives of the individual events in considerable detail these considerations will not be addressed here at length.

The HARD PAN series consisted of a total of 17 events, four of which were major tests. The first two major events (HP I-1 and HP I-2A) were separated from the final two major events (HP I-2B and HP I-3) by several sets of calibration events (SCAL, ICAL, HBL and SICAL) to aid in the final design of the main event (HP I-3). With the exception of two of the calibration events extensive instrumentation was employed to measure ground and structure motions, oil stress, structure/medium stresses, structural strains, and blast pressure.

The Appendix is in eight parts and each, except for Part 8, addresses an individual major event or a set of similar calibration events. Part 8 is concerned with instrumentation topics generally common to all of the tests. Because of its length the instrumentation appendix is published in two volumes.

PART I

HARD PAN I-1 EVENT

1. TEST SITE LAYOUT

Figure P-1 is a plan view of the HP I-1 event showing the HEST cavity outline in relation to the test structure, the instrumentation holes, and the cable trenching. Instrumentation holes are designated by the letter L followed by arabic numerals.

2. MEASUREMENT REQUIREMENTS

a. Blast Pressure

In order to measure the overpressures developed at the floor surface of the HEST cavity a total of 20 blast pressure gages were fielded. Six of these gages were installed in the top surface of the LER in redundant pairs. The other fourteen were arranged along three radials out to a distance of 45 ft from SGZ. Table P-1 gives a listing of the blast pressure measurements, including predictions. Figure P-2 shows the location of the gage installations.

b. Free Field Accelerations

Acceleration measurements are divided into two groups: free field measurements which are beyond a nominal 10 ft from the test structure center line or deeper than the base of the structure, and near field measurements which are in the immediate neighborhood of the structure.

Free field acceleration transducers were installed in epoxy canisters and emplaced in instrumentation holes, drilled either vertically or at a nominal angle of 45°. A total of 86 free field acceleration measurements were made out to 110 ft in range and 66 ft deep. Table P-2 lists the various acceleration measurements in the far field. Elevation views of the various instrumentation holes are shown in Figure P-3. Specific measurement numbers are identified in this figure, together with instrumentation hole numbers. These instrumentation holes are also identified in the plan view of figure P-1.

c. Structure and Near Field Accelerations

A total of 57 structure and near field acceleration measurements were made. Of these, 26 were in the near field soil and the transducers were installed in epoxy canisters. Thirty one measurements were made at various places on the structure. The structure transducers were installed in mounts built into the structure.

Table P-3 lists the structure and near field acceleration measurements. Their locations are shown in figure P-4.

d. Free Field Velocity

Twenty velocity transducers were emplaced in the free field at locations shown in figure P-3. These measurements are listed in table P-4.

e. Structure Velocity

Vertical velocity transducers were attached to built-in mounts at seven locations in the interior of the structure as shown in figure P-4. In addition, three developmental relative velocity transducers intended to measure relative motion between the structure and the surrounding medium were fielded. Their locations are also shown in figure P-4. Table P-5 lists the measurement numbers and the expected velocities.

f. Strain Measurements

During construction of the model structure, redundant sets of strain gages were bonded to the steel rebar at various locations. Figure P-5 shows the locations of those gages which were used for strain measurements in the DISC HEST event. A total of 67 steel strain measurements were made. These are listed in table P-6.

g. Structural Relative Displacement

Four active relative displacement measurements were made. Two of these were to measure the vertical displacement of the upper structure relative to the lower. The other two were intended to measure the diametral distortion of the upper portion of the lower structure. Locations of these four measurements are shown in figure P-6, and their listings are in table P-7.

Additionally, there were a number of passive "scratch" gages installed to measure relative displacements. Four of these gages were intended to indicate the relative vertical and radial displacements of the upper structure with respect to the lower, and two to indicate the diametral distortion of the upper portion of the lower structure. The locations of those sensing devices are shown in figure P-6. They are listed in table P-8.

h. Media Displacement

Thirty-six media displacement profile indicator rods were installed

in each of two planar arrays extending outward from the structure to a distance of 10 ft. These arrays were on opposite sides of the structure and each consisted of three rows of twelve rods, each now being buried at a different depth as shown in figure P-6.

Accurate pre and post shot measurements of the locations and orientation of the indicator rods were to provide a means for determining the net displacement profiles of the soil medium resulting from the explosive event.

i. Structure/Medium Displacement

A total of twelve relative slip gages were attached to the outer wall of the upper structure at locations indicated in figure P-6. These passive "scratch" gages were intended to show the extent of the relative motion of the structure with respect to the surrounding medium.

j. Stress Measurements

A total of thirty-six stress measurements were made. Twelve of these were to measure stress in the medium surrounding the structure and the remainder to measure stress exerted on the structure by the surrounding medium. Eighteen of the latter measurements were of normal stress on the structure. The other six measurements were made with a developmental gage designed to measure both normal stress and shear stress.

All stress measurements are listed in table P-9 and their locations are shown in figure P-7.

k. Experimental Measurements (PACI)

The PACI (Programmable Accelerometer Conditioner Integrator) experiment add-on to the HARD PAN I-1 event was an attempt to gather comparative data on ground motion.

PACI is an electronics package designed for use with a piezo-resistive accelerometer. It contains circuitry for calibration, differential input amplification, integration, and double integration.

Three accelerometers were to be fielded. These are identified by the basic measurement numbers 901, 902, and 903. Pertinent measurement data are listed in table P-10. Locations at which the measurements were taken are shown in figure P-3c.

Four PACI outputs were to be processed from each of the basic accelerometer output signals. They are: (1) amplified acceleration, (2) velocity 1, (3) velocity 2, and (4) displacement.

The integrating circuitry of the PACI package is operable over three programmable ranges. Range 1 integrates from 0.5 Hz to gage cut off frequency. Range 2 integrates from 5 Hz to gage cut off frequency. Range 3 integrates from 50 Hz to gage cut off frequency. For the HARD PAN I-1 test, velocity 1 used range 2 and velocity 2 used range 3. The displacement output also used range 2.

1. Logarithmic Amplification of Acceleration Signals

For the HARD PAN I-1 test, logarithmic amplifiers were added in parallel with the PACI amplifiers to provide logarithmically amplified acceleration outputs. These measurements are identified as 901C, 902C and 903C.

3. CHANNEL RECORD ASSIGNMENTS

AFWL Instrumentation Vans E-3 and E-5 were used for recording of all active instrumentation signals. In both vans recording was done on CEC VR 3700B 14-track recorders. Signals were multiplexed and recorded as shown in tables P-11 and P-12.

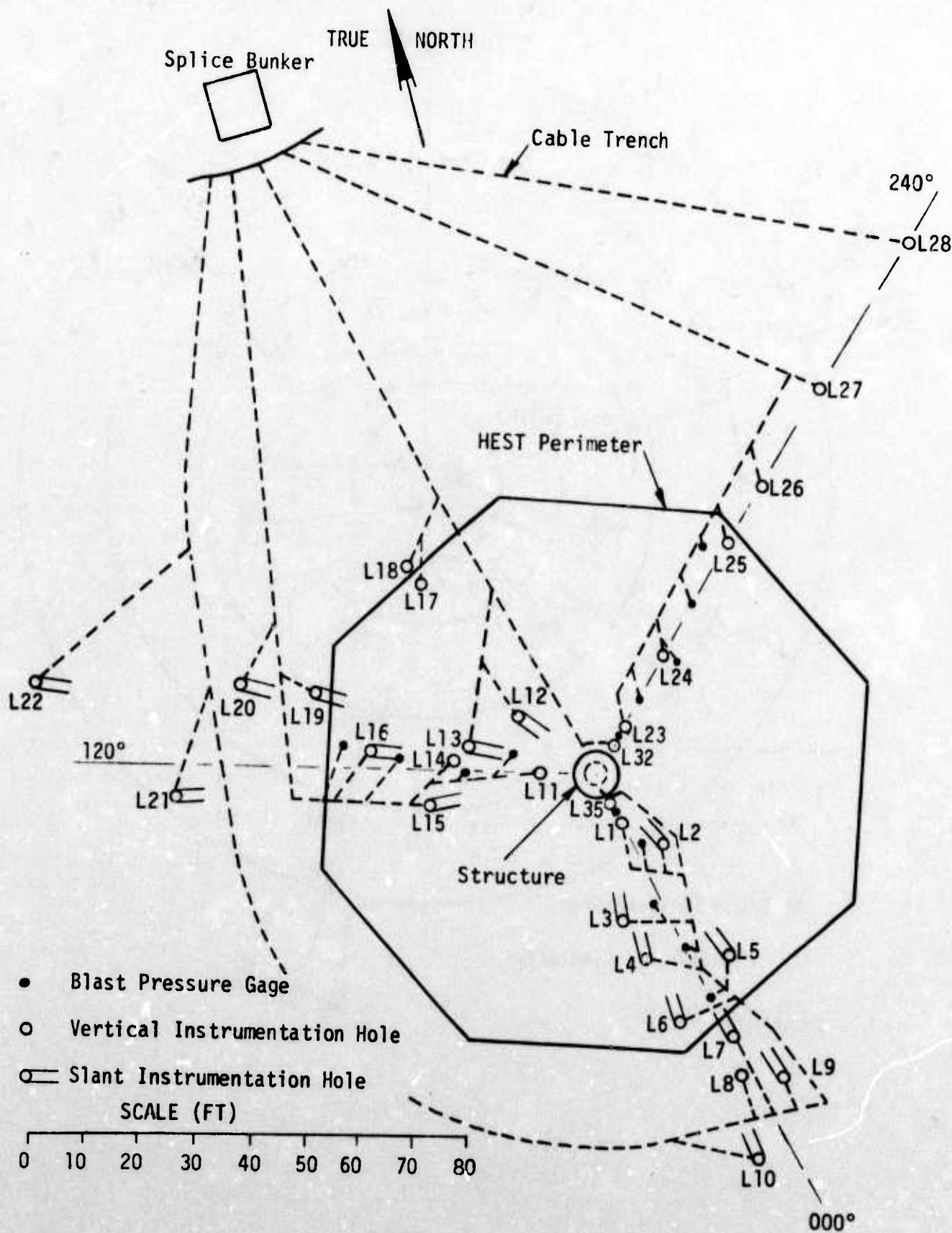

Figure P-1. HARD PAN I-1 Site Layout

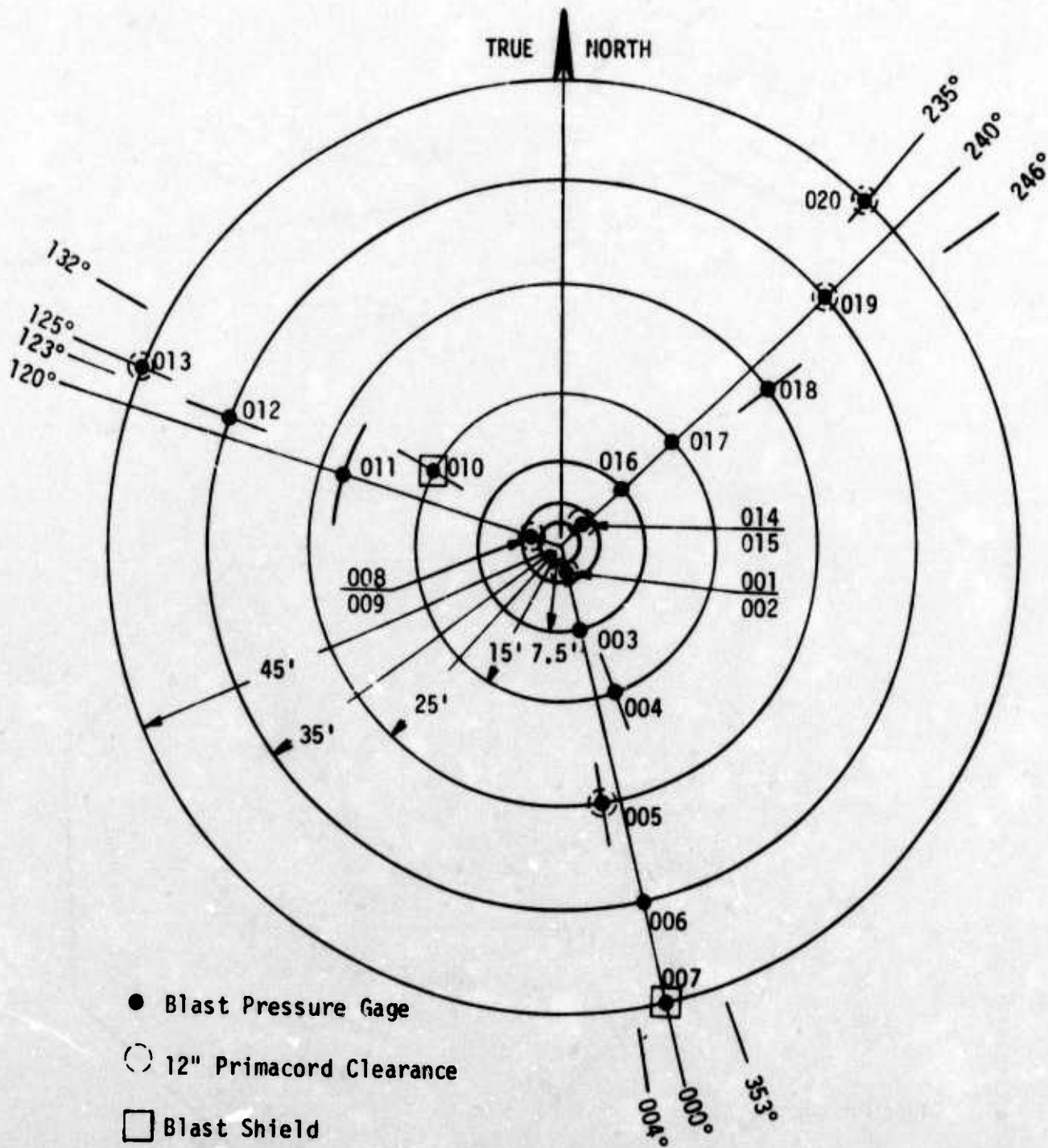

Figure P-2. Blast Pressure Gage Locations

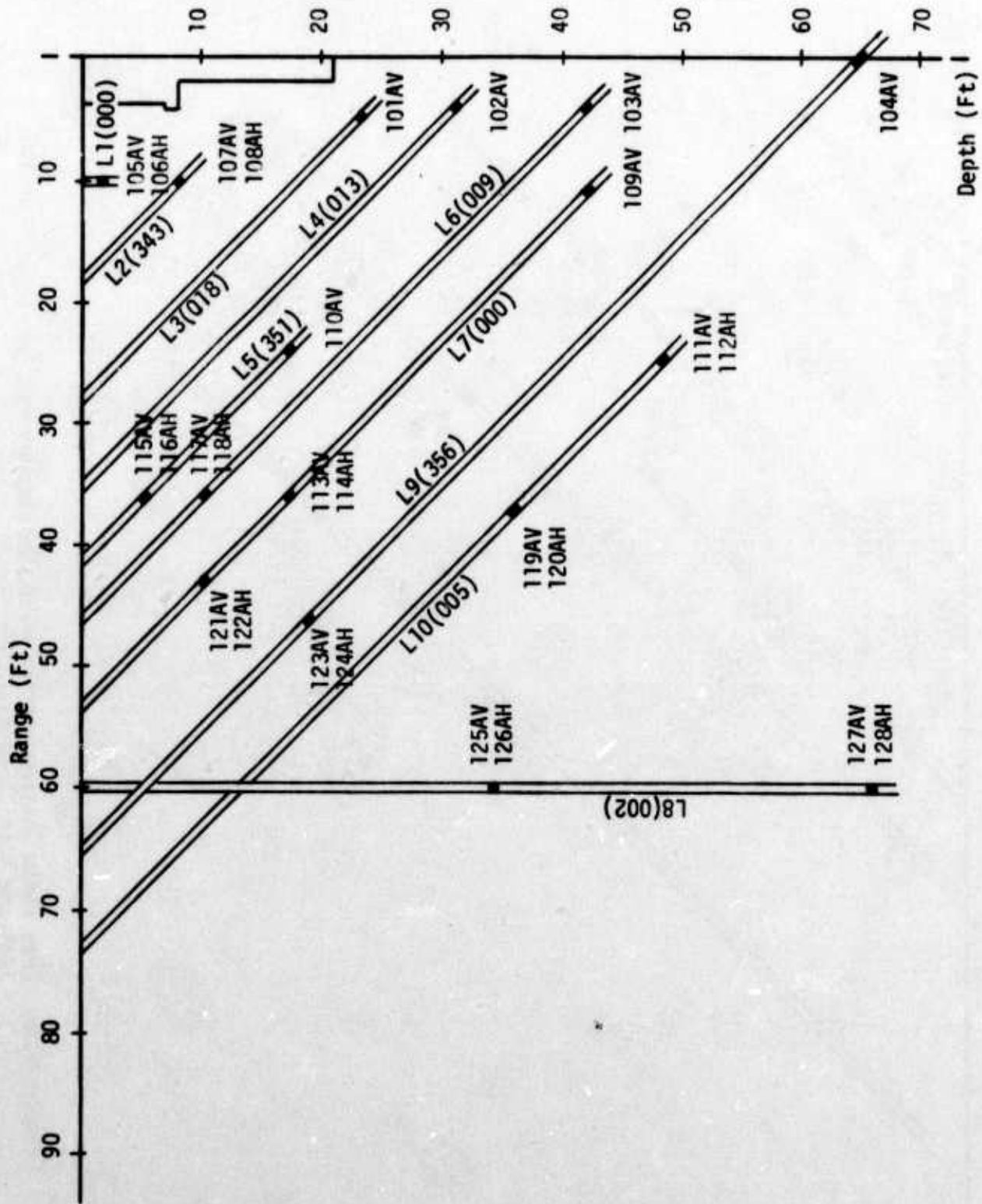

Figure P-3a. Free Field Instrumentation Holes and Measurement Locations - HP I-1
000° and Associated Radials

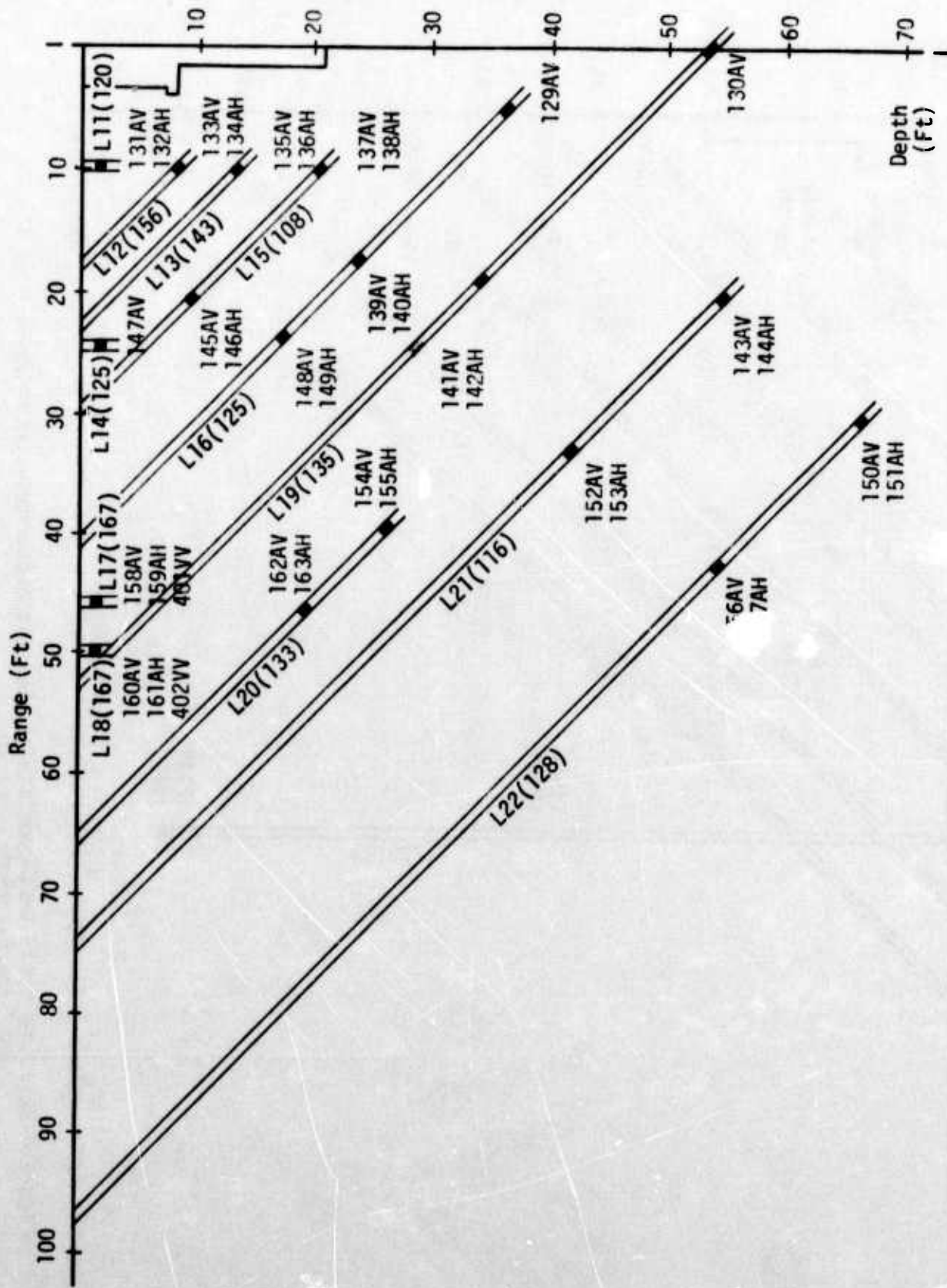

Figure P-3b. Free Field Instrumentation Holes and Measurement Locations - HP I-1
120° and Associated Radials

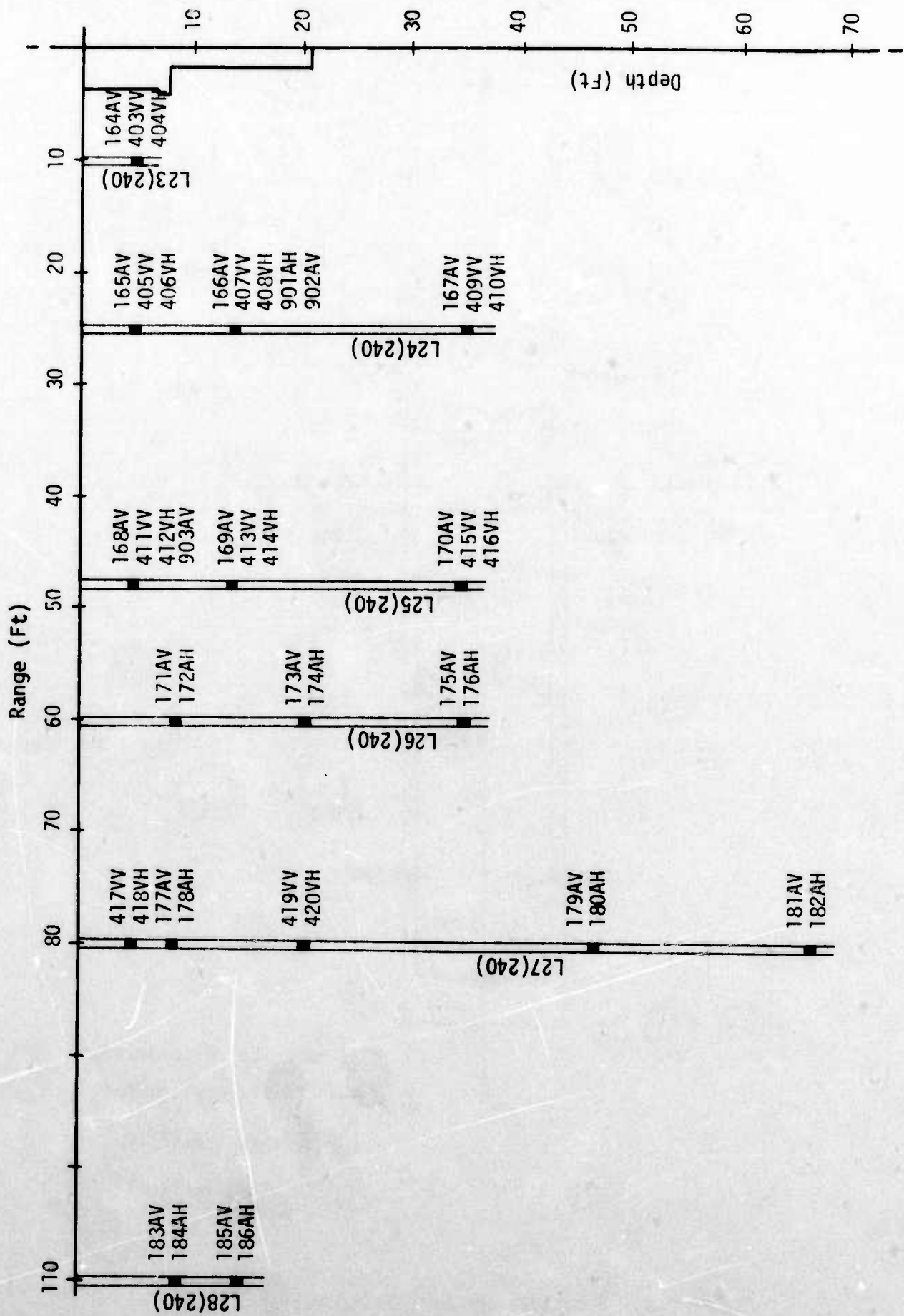

Figure P-3c. Free Field Instrumentation Holes and Measurement Locations - HP I-1
240° Radial

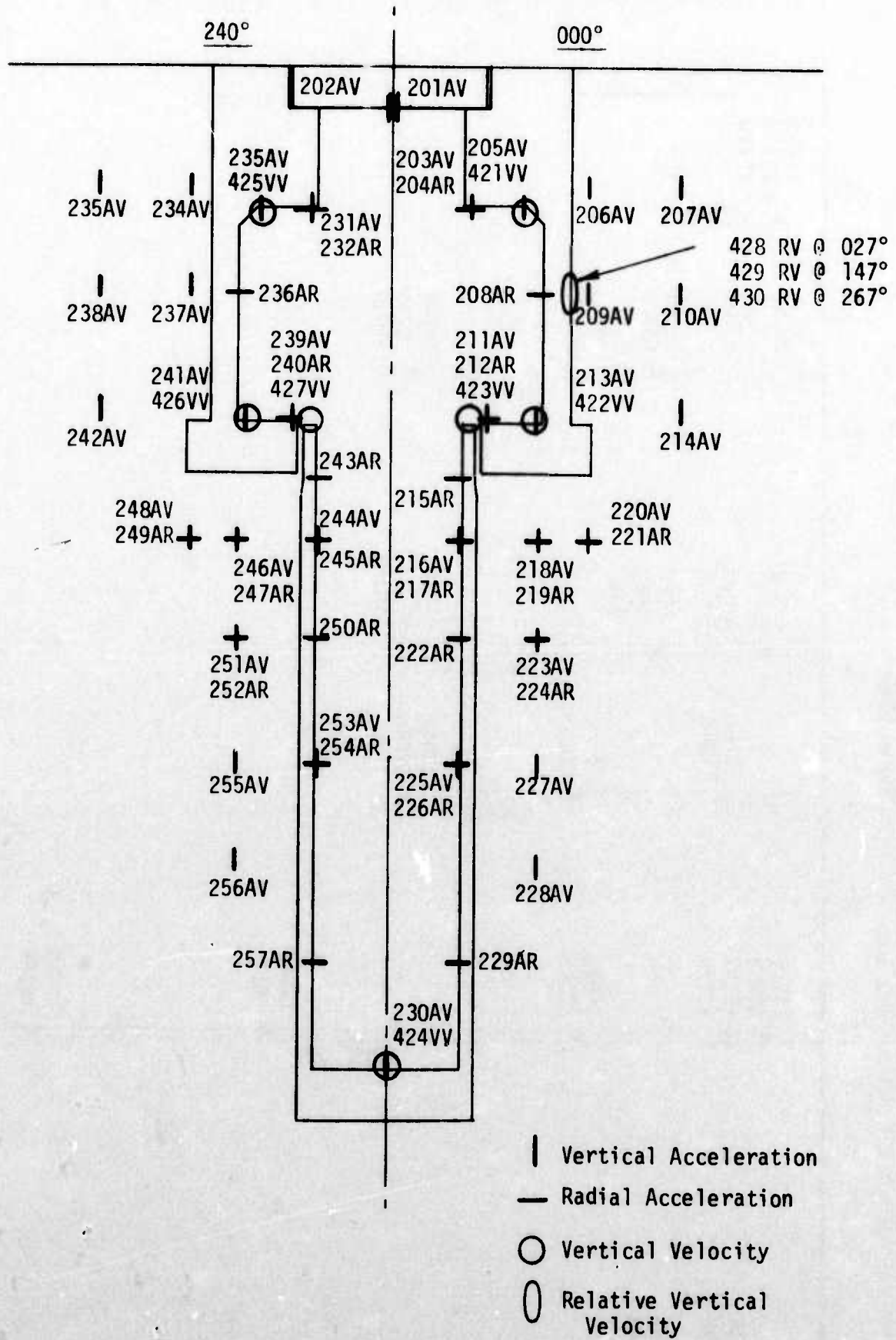

Figure P-4. Structure and Near Field Motion Measurements

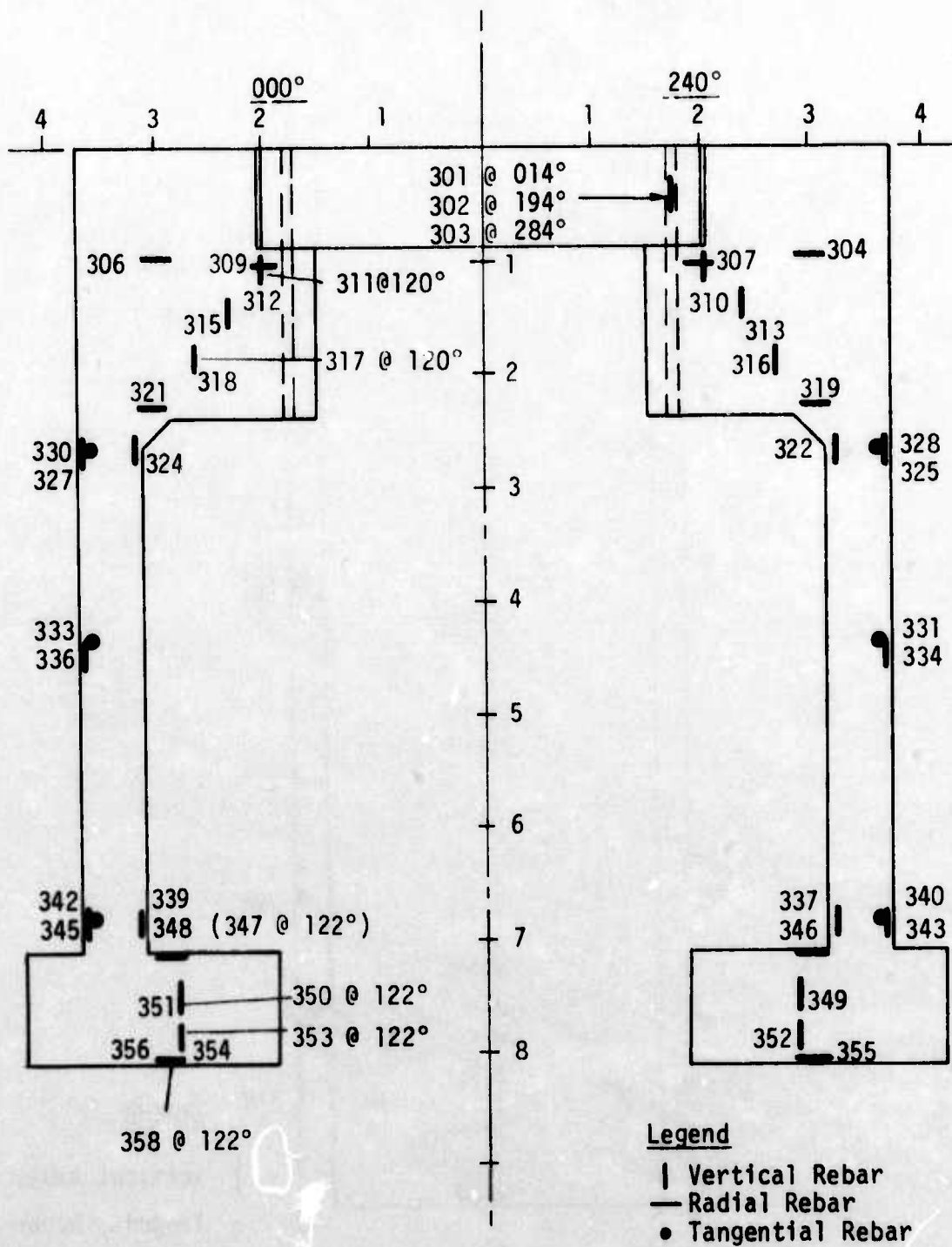

Figure P-5a. Structure Strain Measurements - Upper Structure

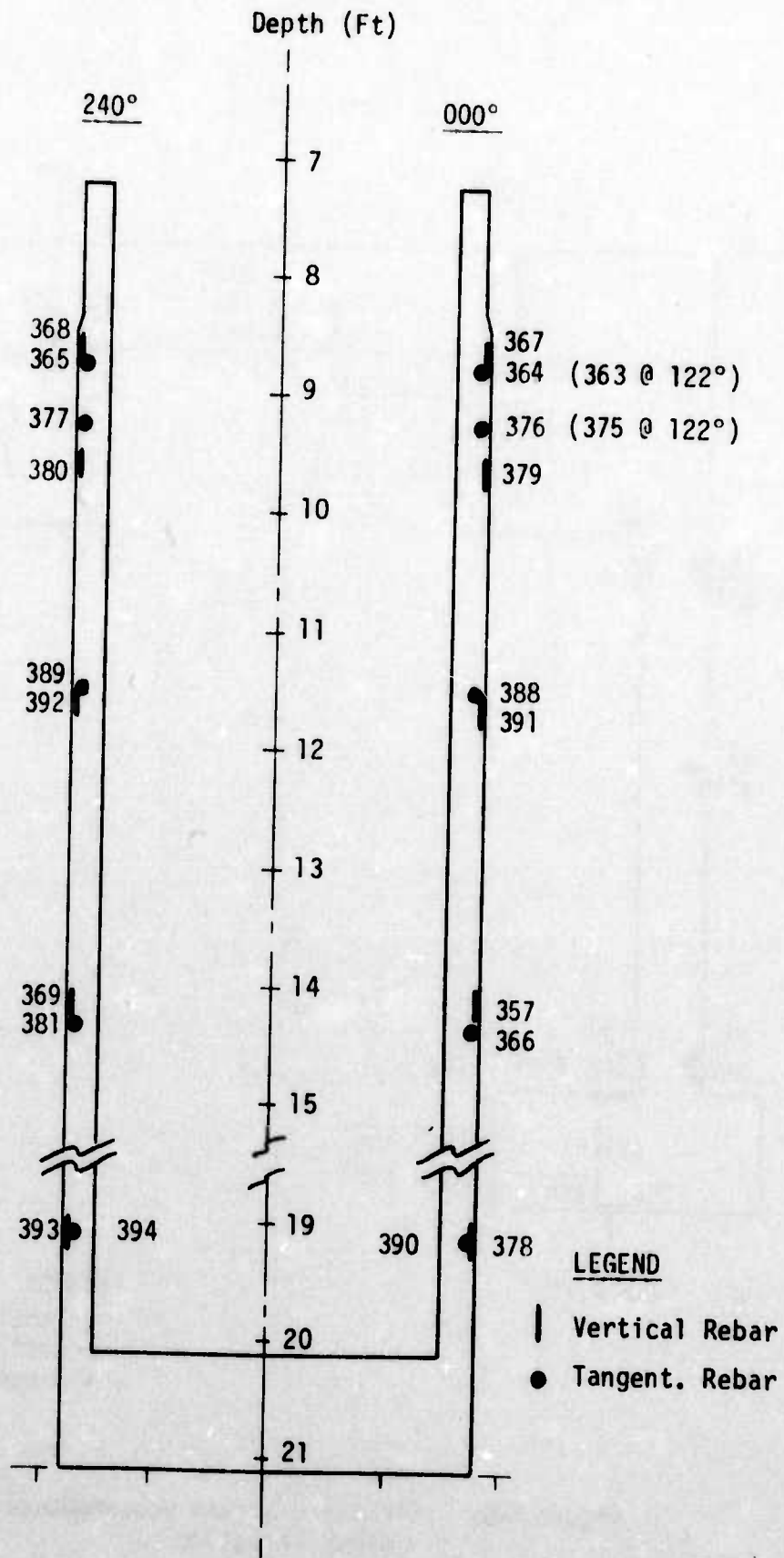

Figure P-5b. Structure Strain Measurements - Lower Structure

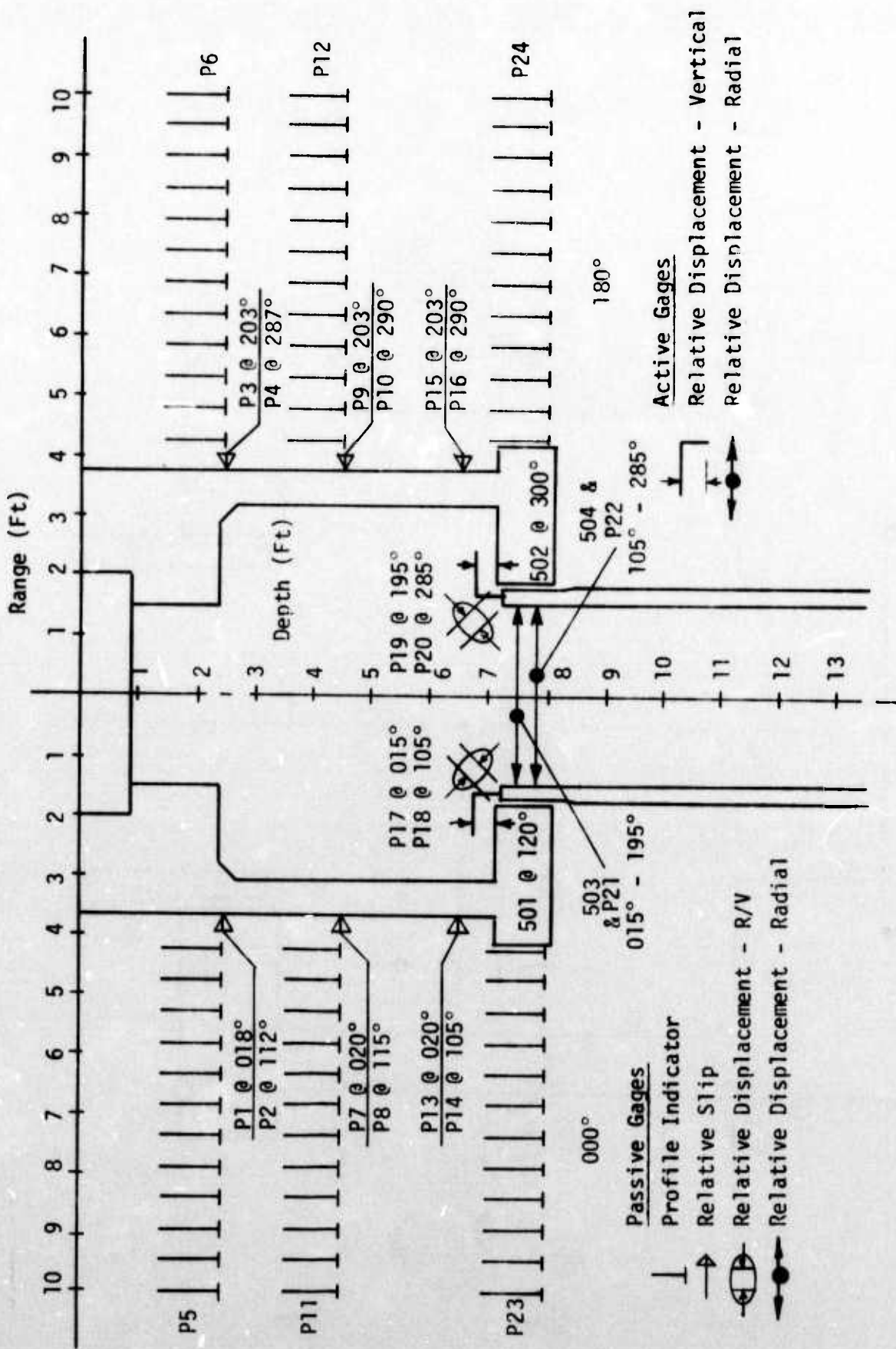

Figure P-6. Passive Gage and Relative Displacement Gage Locations

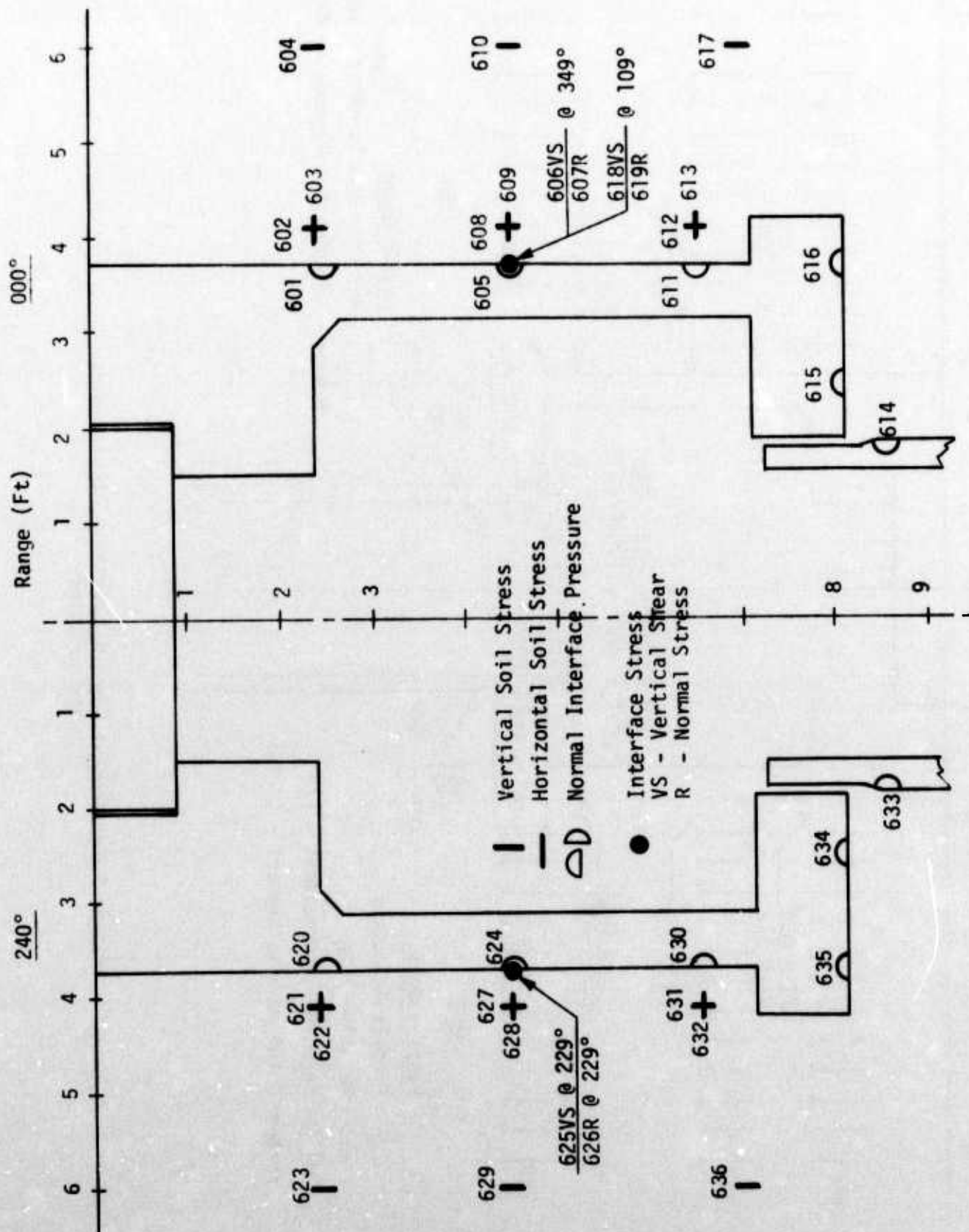

Figure P-7. Structure Stress Measurement Locations

Table P-1. Blast Pressure Measurements - HP I-1

Measure. Number	Br	Rec	Genl	Loc	Depth (ft)	Measurement Designation				Sens. Axis	Pred. Level (psi)	Xducer Nom Range (psi)	Xducer Ser. No.
						Rec	Genl	Azimuth (degrees)	Range (ft)				
001	S	E	LER	00.0	0	2.6	BP	V	1200	10000	SE026		
002	S	E	LER	00.0	0	2.6	BP	V	1200	5000	SD024		
003	F	E	FF	0	000	7.2	BP	V	1200	5000	SD010		
004	F	E	FF	0	353	15.1	BP	V	1200	5000	SD016		
005	F	E	FF	0	004	25.1	BP	V	1200	10000	SE002		
006	F	E	FF	0	000	35	BP	V	1200	5000	SD013		
007	F	E	FF	0	000	45.1	BP	V	1200	10000	SE004		
008	S	E	LER	00.0	120	2.6	BP	V	1200	10000	SE035		
009	S	E	LER	00.0	120	2.6	BP	V	1200	5000	SD023		
010	F	E	FF	0	132	15	BP	V	1200	10000	SE003		
011	F	E	FF	0	120	23	BP	V	1200	5000	SD009		
012	F	E	FF	0	123	35	BP	V	1200	5000	SD018		
013	F	E	FF	0	125	45	BP	V	1200	10000	SE006		
014	S	E	LER	00.0	240	2.6	BP	V	1200	10000	SE020		
015	S	E	LER	00.0	240	2.6	BP	V	1200	5000	SD022		
016	F	E	FF	0	240	7.6	BP	V	1200	5000	SD014		
017	F	E	FF	0	240	15.6	BP	V	1200	5000	SD019		
018	F	E	FF	0	246	25.1	BP	V	1200	5000	SD020		
019	F	E	FF	0	240	35.2	BP	V	1200	10000	SE005		
020	F	E	FF	0	235	45	BP	V	1200	10000	SE008		

Table P-2. Free Field Acceleration - HP I-1

Hole Number	Measure. Number	Br	Rec	Genl Loc	Depth (ft)	Measurement Designation				Pred. Level (g)	Xducer Nom Range (g)	Xducer Ser. No.
						Azimuth (degrees)	Range (ft)	Meas. Type	Sens. Axis			
L3	101	F	E	FF	23	018	4.0	A	V	400	500	132
L4	102	F	E	FF	31	013	3.67	A	V	300	500	118
L6	103	F	E	FF	42	009	4.25	A	V	200	250	BF85
L9	104	F	E	FF	66.5	356	0.00	A	V	150	250	BD41
L1	105	F	E	FF	1.5	000	10	A	V	3000	10000	AA06
L1	106	F	E	FF	1.5	000	10	A	H	1500	2500	DJ09
L2	107	F	E	FF	8	343	9.92	A	V	2000	2500	DF56
L2	108	F	E	FF	8	343	9.92	A	H	1000	2500	DE12
L7	109	F	E	FF	42	000	11.42	A	V	400	500	122
L5	110	F	E	FF	17	351	24.17	A	V	1200	2500	DF55
L10	111	F	E	FF	48.5	005	25.16	A	V	200	500	131
L10	112	F	E	FF	48.5	005	25.16	A	H	200	500	130
L7	113	F	E	FF	17	000	36.42	A	V	500	1000	153
L7	114	F	E	FF	17	000	36.42	A	H	500	1000	156
L5	115	F	E	FF	5.0	351	36.17	A	V	2000	2500	DE13
L5	116	F	E	FF	5.0	351	36.17	A	H	1000	2500	DF47
L6	117	F	E	FF	10	009	36.25	A	V	2000	2500	DH55
L6	118	F	E	FF	10	009	36.25	A	H	1000	2500	DC29
L10	119	F	E	FF	36	005	37.67	A	V	250	500	126
L10	120	F	E	FF	36	005	37.67	A	H	400	1000	154
L7	121	F	E	FF	10	000	43.42	A	V	2000	2500	DJ25

Table P-2. Free Field Acceleration - HP I-1 (Continued)

Hole Number	Measure. Number	Br	Rec	Genl	Loc	Measurement Designation					Sens. Axis	Pred. Level (g)	Xducer Nom Range (g)	Xducer Ser. No.
						Depth (ft)	Azimuth (degrees)	Range (ft)	Meas. Type	Range (ft)				
L7	122	F	E	FF		10	000	43.42	A		H	1000	2500	AT95
L9	123	F	E	FF		19	356	45.92	A		V	1000	1000	152
L9	124	F	E	FF		19	356	45.92	A		H	1000	1000	145
L8	125	F	E	FF		34.5	002	60	A		V	250	500	135
L8	126	F	E	FF		34.5	002	60	A		H	250	500	159
L8	127	F	E	FF		66.0	002	60	A		V	150	250	BD13
L8	128	F	E	FF		66.0	002	60	A		H	250	250	BF87
L16	129	F	E	FF		36	125	4.84	A		V	200	500	103
L19	130	F	E	FF		53.97	135	0.00	A		V	150	250	BF57
L11	131	F	E	FF		1.5	120	9.92	A		V	2000	2500	AT72
L11	132	F	E	FF		1.5	120	9.92	A		H	1000	2500	AU08
L12	133	F	E	FF		8	156	10.00	A		V	2000	2500	DH64
L12	134	F	E	FF		8	156	10.00	A		H	1000	2500	DF45
L13	135	F	E	FF		13.5	143	10	A		V	2000	5000	AB87
L13	136	F	E	FF		13.5	143	10	A		H	1000	2500	DF27
L15	137	F	E	FF		20	108	9.92	A		V	500	1000	162
L15	138	F	E	FF		20	108	9.92	A		H	500	1000	149
L16	139	F	E	FF		23.5	125	17.34	A		V	400	500	127
L16	140	F	E	FF		23.5	125	17.34	A		H	400	1000	160
L19	141	F	E	FF		33.71	135	19.54	A		V	300	500	128
L19	142	F	E	FF		33.71	135	19.54	A		H	300	500	136

Table P-2. Free Field Acceleration - HP I-1 (Continued)

Hole Number	Measure. Number	Br	Rec	Genl	Loc	Measurement Designation						Xducer Nom Range (g)	Xducer Ser. No.
						Depth (ft)	Azimuth (degrees)	Range (ft)	Meas. Type	Sens. Axis	Pred. Level (g)		
L21	143	F	E	FF		54	116	20.39	A	V	200	500	124
L21	144	F	E	FF		54	116	20.39	A	H	200	500	139
L15	145	F	E	FF		9	108	20.92	A	V	2000	2500	DC95
L15	146	F	E	FF		9	108	20.92	A	H	1000	2500	AR85
L14	147	F	E	FF		1.5	125	24.75	A	V	2000	2500	DF52
L16	148	F	E	FF		17	125	23.84	A	V	1000	2500	DF53
L16	149	F	E	FF		17	125	23.84	A	H	1000	2500	DH60
L22	150	F	E	FF		66	128	30.44	A	V	150	250	BF94
L22	151	F	E	FF		66	128	30.44	A	H	150	250	BF82
L21	152	F	E	FF		41.5	116	32.90	A	V	250	500	120
L21	153	F	E	FF		41.5	116	32.90	A	H	250	500	116
L20	154	F	E	FF		25	133	39.55	A	V	500	1000	151
L20	155	F	E	FF		25	133	39.55	A	H	500	1000	138
L22	156	F	E	FF		54	128	42.39	A	V	200	500	105
L22	157	F	E	FF		54	128	42.39	A	H	200	500	107
L17	158	F	E	FF		1.5	167	46.0	A	V	2000	5000	AC22
L17	159	F	E	FF		1.5	167	46.0	A	H	2000	5000	AC07
L18	160	F	E	FF		1.5	167	50.0	A	V	2000	5000	AB84
L18	161	F	E	FF		1.5	167	50.0	A	H	2000	5000	AB82
L20	162	F	E	FF		18	133	46.55	A	V	2000	2500	DE88
L20	163	F	E	FF		18	133	46.55	A	H	1000	2500	DJ27

Table P-2. Free Field Acceleration - HP I-1 (Continued)

Hole Number	Measure. Number	Br	Rec	Genl Loc	Measurement Designation					Sens. Axis	Pred. Level (g)	Xducer Nom Range (g)	Xducer Ser. No.
					Depth (ft)	Azimuth (degrees)	Range (ft)	Meas. Type	Range (ft)				
L23	164	F	E	FF	4.92	240	10.17	A	V	2000	2500	DG29	
L24	165	F	E	FF	4.92	240	25	A	V	2000	5000	AC35	
L24	166	F	E	FF	13.92	240	25	A	V	1000	2500	DH82	
L24	167	F	E	FF	34.92	240	25	A	V	300	500	AC96	
L25	168	F	E	FF	4.92	240	48	A	V	2000	2500	DF33	
L25	169	F	E	FF	13.92	240	48	A	V	500	1000	165	
L25	170	F	E	FF	34.92	240	48	A	V	300	500	111	
L26	171	F	E	FF	8.42	240	60.17	A	V	250	500	123	
L26	172	F	E	FF	8.42	240	60.17	A	H	500	1000	144	
L26	173	F	E	FF	20.42	240	60.17	A	V	300	500	109	
L26	174	F	E	FF	20.42	240	60.17	A	H	600	1000	146	
L26	175	F	E	FF	34.92	240	60.17	A	V	300	500	110	
L26	176	F	E	FF	34.92	240	60.17	A	H	600	1000	148	
L27	177	F	E	FF	8.42	240	80.25	A	V	15	25	BC47	
L27	178	F	E	FF	8.42	240	80.25	A	H	30	250	BF46	
L27	179	F	E	FF	46.5	240	80.25	A	V	100	250	BF77	
L27	180	F	E	FF	46.5	240	80.25	A	H	200	500	112	
L27	181	F	E	FF	66.0	240	80.25	A	V	50	250	BF55	
L27	182	F	E	FF	66.0	240	80.25	A	H	100	250	BF62	
L28	183	F	E	FF	9.4	240	110.17	A	V	.5	25	BC28	
L28	184	F	E	FF	9.4	240	110.17	A	H	30	250	BF99	

Table P-2. Free Field Acceleration - HP I-1 (Continued)

Hole Number	Measure. Number	Br	Rec	Gen1	Loc	Measurement Designation					Pred. Level (g)	Xducer Nom Range (g)	Xducer Ser. No.
						Depth (ft)	Azimuth (degrees)	Range (ft)	Meas. Type	Sens. Axis			
L28	185	F	E	FF	14.1	240	110.17	A	V	50	250	BF66	
L28	186	F	E	FF	14.1	240	110.17	A	H	100	250	RG12	

Table P-3. Near Field & Structure Accelerations - HP I-1

Measure. Number	Br	Rec	Genl Loc	Measurement Designation					Sens. Axis	Pred. Level (g)	Xducer Nom Range (g)	Xducer Ser. No.
				Depth (ft)	Azimuth (degrees)	Range (ft)	Meas. Type	Meas. Type				
201	S	E	CL	0.9	0	0.1	A	V	3000	5000	AC99	
202	S	E	CL	0.9	0	0.1	A	V	3000	10000	AC06	
203	S	E	LER	2.48	0	1.6	A	V	2000	5000	AC83	
204	S	E	LER	2.48	0	1.54	A	R	2000	5000	AC92	
205	S	E	LER	2.48	356	2.7	A	V	1500	2500	DG33	
206	S	E	NF	2.4	7	4.6	A	V	3000	5000	AB86	
207	S	E	NF	2.4	0	6.0	A	V	3000	5000	AC47	
208	S	E	LER	4.6	359	3.1	A	R	1500	2500	DG42	
209	S	E	NF	4.5	7	4.6	A	V	2000	5000	AC60	
210	S	E	NF	4.5	0	6.0	A	V	2000	5000	AC58	
211	S	E	LER	7.15	348	2.0	A	V	1500	2500	DG39	
212	S	E	LER	7.15	348	2.0	A	R	1500	2500	DG37	
213	S	E	LER	7.15	348	2.9	A	V	1500	2500	DG32	
214	S	E	NF	7.0	0	6.0	A	V	2000	5000	AC62	
215	S	E	LT	8.1	005	1.5	A	R	300	500	104	
216	S	E	LT	9.5	005	1.5	A	V	300	500	125	
217	S	E	LT	9.6	005	1.5	A	R	300	500	134	
218	S	E	NF	9.5	0	3.1	A	V	1000	2500	DG51	
219	S	E	NF	9.5	0	3.13	A	R	1000	2500	DH75	
220	S	E	NF	9.5	0	4.1	A	V	1000	2500	DH88	
221	S	E	NF	9.5	0	4.1	A	R	1000	2500	DG30	
222	S	E	LT	11.6	005	1.5	A	R	300	500	108	

Table P-3. Near Field & Structure Accelerations - HP I-1 (Continued)

Measure. Number	Measurement Designation										Xducer Nom Range (g)	Xducer Ser. No.
	Br	Rec	Genl Loc	Depth (ft)	Azimuth (degrees)	Range (ft)	Meas. Type	Sens. Axis	Pred. Level (g)			
223	S	E	NF	11.5	0	3.1	A	V	1000	2500	DH79	
224	S	E	NF	11.5	0	3.13	A	R	500	1000	141	
225	S	E	LT	14.1	005	1.5	A	V	300	500	121	
226	S	E	LT	14.1	005	1.5	A	R	300	500	133	
227	S	E	NF	14.0	0	3.1	A	V	1000	2500	AT70	
228	S	E	NF	16.0	0	3.1	A	V	1000	2500	DB76	
229	S	E	LT	18.1	5	1.5	A	R	500	1000	174	
230	S	E	LT	20.1	0	0.0	A	V	500	1000	173	
231	S	E	LER	2.48	240	1.6	A	V	2000	5000	AD57	
232	S	E	LER	2.48	240	1.54	A	R	2000	5000	AD45	
233	S	E	LER	2.48	236	2.7	A	V	1500	2500	DG43	
234	S	E	NF	2.4	247	4.6	A	V	3000	5000	AC40	
235	S	E	NF	2.4	240	6.0	A	V	3000	5000	AC45	
236	S	E	LER	4.6	240	3.1	A	R	1500	2500	DG34	
237	S	E	NF	4.5	247	4.6	A	V	2000	5000	AC66	
238	S	E	NF	4.5	240	6.0	A	V	2000	5000	AC43	
239	S	E	LER	7.15	231	2.0	A	V	1500	2500	DG35	
240	S	E	LER	7.15	231	2.0	A	R	1500	2500	DG36	
241	S	E	LER	7.15	229	2.9	A	V	1500	2500	DG45	
242	S	E	NF	7.0	240	6.0	A	V	2000	5000	AC46	
243	S	E	LT	8.1	244	1.5	A	R	300	500	115	

Table P-3. Near Field & Structure Accelerations - HP I-1 (Continued)

Measure. Number	Br Rec Gen1 Loc			Measurement Designation				Pred. Level (g)	Xducer Nom Range (g)	Xducer Ser. No.		
	Br	Rec	Gen1	Loc	Depth (ft)	Azimuth (degrees)	Range (ft)				Meas. Type	Sens. Axis
244	S	E	LT		9.5	244	1.5	A	V	300	500	177
245	S	E	LT		9.5	244	1.5	A	R	300	500	175
246	S	E	NF		9.5	240	3.1	A	V	1000	2500	DJ10
247	S	E	NF		9.5	240	3.1	A	R	1000	2500	DG31
248	S	E	NF		9.5	240	4.1	A	V	1000	2500	DH91
249	S	E	NF		9.5	240	4.1	A	R	1000	2500	DJ07
250	S	E	LT		11.6	244	1.5	A	R	300	1000	178
251	S	E	NF		11.5	240	3.1	A	V	1000	2500	DH59
252	S	E	NF		11.5	240	3.13	A	R	500	1000	155
253	S	E	LT		14.0	244	1.5	A	V	300	1000	171
254	S	E	LT		14.1	244	1.5	A	R	300	500	172
255	S	E	NF		14.0	240	3.1	A	V	1000	2500	DJ08
256	S	E	NF		16.0	240	3.1	A	V	1000	2500	DJ49
257	S	E	LT		18.1	244	1.5	A	R	500	1000	179

Table P-4. Free Field Velocity Measurements - HP I-1

Hole Number	Measure. Number	Br	Rec	Gen	Loc	Depth (ft)	Measurement Designation				Pred Level (fps)	Xducer Damping Fluid (cs)	Xducer Ser. No.
							Azimuth (degrees)	Range (ft)	Meas. Type	Sens. Axis			
L17	401	F	E	FF	1.5	120	48	V	V	100	7000	2822	
L18	402	F	E	FF	1.5	120	52	V	V	100	7000	2821	
L23	403	F	E	FF	4.5	240	10	V	V	40	3000	2874	
L23	404	F	E	FF	4.5	240	10	V	H	25	3000	2894	
L24	405	F	E	FF	4.5	240	25	V	V	40	3000	2876	
L24	406	F	E	FF	4.5	240	25	V	H	25	3000	2887	
L24	407	F	E	FF	20	240	25	V	V	20	3000	1086	
L24	408	F	E	FF	20	240	25	V	H	20	3000	2885	
L24	409	F	E	FF	34.5	240	25	V	V	15	3000	2877	
L24	410	F	E	FF	34.5	240	25	V	H	15	3000	2895	
L25	411	F	E	FF	4.5	240	50	V	V	40	3000	2871	
L25	412	F	E	FF	4.5	240	50	V	H	40	3000	2890	
L25	413	F	E	FF	20	240	50	V	V	15	3000	2828	
L25	414	F	E	FF	20	240	50	V	H	30	3000	2884	
L25	415	F	E	FF	34.5	240	50	V	V	10	2000	2817	
L25	416	F	E	FF	34.5	240	50	V	H	20	3000	2893	
L27	417	F	E	FF	4.5	240	80	V	V	5	1000	2825	
L27	418	F	E	FF	4.5	240	80	V	H	5	1000	2889	
L27	419	F	E	FF	20	240	80	V	V	5	1000	2827	
L27	420	F	E	FF	20	240	80	V	H	5	1000	2821	

Table P-5. Structure Velocity Measurements - HP I-1

Measure. Number	Br	Rec	Genl Loc	Measurement Designation					Pred Level (fps)	Xducer Damping Fluid (cs)	Xducer Ser. No.
				Depth (ft)	Azimuth (degrees)	Range (ft)	Meas. Type	Sens. Axis			
421	S	E	LER	2.5	2	2.7	V	V	3000	2872	
422	S	E	LER	7.1	351.7	2.9	V	V	3000	2873	
423	S	E	LT	7.3	3	1.7	V	V	2000	2812	
424	S	E	LT	20.1	0	0.0	V	V	2000	2815	
425	S	E	LER	2.5	240	2.7	V	V	3000	2874	
426	S	E	LER	7.1	232.6	2.9	V	V	3000	2879	
427	S	E	LT	7.3	245.2	1.7	V	V	2000	2816	
428	S	E	LER	4.5	027	3.7	RV	V	30		
429	S	E	LER	4.5	147	3.7	RV	V	30		
430	S	E	LER	4.5	267	3.7	RV	V	30		

Table P-6. Steel Strain Measurements - HP I-1

Measure. Number	Measurement Designation										Pred Level (µε)	Xducer Serial Number	Comm.
	Br	Rec	Gen	Loc	Depth (ft)	Azimuth (degrees)	Range (ft)	Meas. Type	Sens. Axis				
301	S	E	CL	CL	.4	014.03	1.75	SE	V		-	5	Dual Range Record 500/2000
302	S	E	CL	CL	.4	194.03	1.75	SE	V		-	4	
303	S	E	CL	CL	.4	284.03	1.75	SE	V		-	7	
304	S	E	LER	LER	.96	240	3.0	SE	R		1000		
306	S	E	LER	LER	.96	0	3.0	SE	R		1000		
307	S	E	LER	LER	1.03	240	2.0	SE	R		1000		
309	S	E	LER	LER	1.03	0	2.0	SE	R		1000		
310	S	E	LER	LER	1.09	240	2.15	SE	V		2000		
311	S	E	LER	LER	1.09	120	2.15	SE	V		2000		
312	S	E	LER	LER	1.09	0	2.15	SE	V		2000		
313	S	E	LER	LER	1.43	240	2.4	SE	V		2000		
315	S	E	LER	LER	1.43	0	2.4	SE	V		2000		
316	S	E	LER	LER	1.80	240	2.7	SE	V		2000		
317	S	E	LER	LER	1.80	120	2.7	SE	V		2000		
318	S	E	LER	LER	1.80	0	2.7	SE	V		2000		
319	S	E	LER	LER	2.28	240	3.0	SE	R		500		
321	S	E	LER	LER	2.28	0	3.0	SE	R		500		
322	S	E	LER	LER	2.70	240	3.19	SE	V		1500		
324	S	E	LER	LER	2.70	0	3.19	SE	V		1500		
325	S	E	LER	LER	2.70	240	3.61	SE	T		1000		
327	S	E	LER	LER	2.70	2	3.61	SE	T		1000		

Table P-6. Steel Strain Measurements - HP I-1 (Continued)

Measure. Number	Measurement Designation										Pred Xducer Level (µε)	Serial Number	Comm.
	Br	Rec	Genl	Loc	Depth (ft)	Azimuth (degrees)	Range (ft)	Meas. Type	Sens. Axis				
328	S	E	LER		2.70	240	3.63	SE	V		1500		
330	S	E	LER		2.70	0	3.63	SE	V		1500		
331	S	E	LER		4.39	240	3.61	SE	T		1500		
333	S	E	LER		4.39	2	3.61	SE	T		1500		
334	S	E	LER		4.49	240	3.63	SE	V		1500		
336	S	E	LER		4.49	0	3.63	SE	V		1500		
337	S	E	LER		6.87	240	3.19	SE	V		1500		
339	S	E	LER		6.87	0	3.19	SE	V		1500		
340	S	E	LER		6.87	240	3.61	SE	T		1000		
342	S	E	LER		6.87	0	3.61	SE	T		1000		
343	S	E	LER		6.87	240	3.63	SE	V		1500		
345	S	E	LER		6.87	0	3.63	SE	V		1500		
346	S	E	LER		7.16	238	2.98	SE	R		2000		
347	S	E	LER		7.16	122	2.98	SE	R		2000		
348	S	E	LER		7.16	2	2.98	SE	R		2000		
349	S	E	LER		7.50	238	2.85	SE	V		2000		
350	S	E	LER		7.50	122	2.85	SE	V		2000		
351	S	E	LER		7.50	2	2.85	SE	V		2000		
352	S	E	LER		7.79	238	2.85	SE	V		2000		
353	S	E	LER		7.79	122	2.85	SE	V		2000		
354	S	E	LER		7.79	2	2.85	SE	V		2000		

Table P-6. Steel Strain Measurements - HP I-1 (Continued)

Measure. Number	Measurement Designation			Depth (ft)	Azimuth (degrees)	Range (ft)	Meas. Type	Sens. Axis	Pred Level ($\mu\epsilon$)	Xducer Serial Number	Comm.
	Br	Rec	Gen1 Loc								
355	S	E	LER	8.07	238	2.98	SE	R	2000		
356	S	E	LER	8.07	2	2.98	SE	R	2000		
357	S	E	LT	14.1	0	1.75	SE	V	1000		
358	S	E	LER	8.07	122	2.98	SE	R	2000		
363	S	E	LT	8.7	122	1.73	SE	T	500		
364	S	E	LT	8.7	0	1.73	SE	T	500		
365	S	E	LT	8.7	242	1.73	SE	T	500		
366	S	E	LT	14.3	0	1.73	SE	T	1000		
367	S	E	LT	8.6	0	1.75	SE	V	500		
368	S	E	LT	8.6	240	1.75	SE	V	500		
369	S	E	LT	14.1	240	1.75	SE	V	1000		
375	S	E	LT	9.3	122	1.73	SE	T	500		
376	S	E	LT	9.3	0	1.73	SE	T	500		
377	S	E	LT	9.3	242	1.73	SE	T	500		
378	S	E	LT	19.1	0	1.75	SE	V	1000		
379	S	E	LT	9.6	0	1.75	SE	V	500		
380	S	E	LT	9.6	240	1.75	SE	V	500		
381	S	E	LT	14.3	242	1.73	SE	T	1000		
388	S	E	LT	11.5	0	1.73	SE	T	500		
389	S	E	LT	11.5	242	1.73	SE	T	500		
390	S	E	LT	19.1	0	1.73	SE	T	1000		

Table P-6. Steel Strain Measurements - HP I-1 (Continued)

Measure. Number	Measurement Designation											
	Br	Rec	Gen	Loc	Depth (ft)	Azimuth (degrees)	Range (ft)	Meas. Type	Sens. Axis	Pred Level ($\mu\epsilon$)	Xducer Serial Number	Comm.
391	S	E	LT		11.6	0	1.75	SE	V	1000		
392	S	E	LT		11.6	240	1.75	SE	V	1000		
393	S	E	LT		19.1	240	1.75	SE	V	1000		
394	S	E	LT		19.1	245	1.73	SE	T	1000		

Table P-7. Structure Displacement Measurements - HP I-1

Measure. Number	Measurement Designation											
	Br	Rec	Genl	Loc	Depth (ft)	Azimuth (degrees)	Range (ft)	Meas. Type	Sens. Axis	Pred Level (in)	Xducer Nom Range (in)	Xducer Ser. No.
501	S	E	LER		7.0	120	1.9	RD	V	6	±7	6448-17
502	S	E	LER		7.0	300	1.9	RD	V	6	±7	6448-32
503	S	E	LT		7.5	15-195	1.5	RD	R	1	±2	22510115
504	S	E	LT		7.8	105-285	1.5	RD	R	1	±2	22510113

Table P-8. Passive Gages - Event #1 - HP I-1

Measurement No.			Loc.	Depth (ft)	Azimuth (Degrees)	Range (Ft)	Type	Sense
P1	S	M	LER	2.4	018	3.7	ID	V
P2	S	M	LER	2.4	112	3.7	ID	V
P3	S	M	LER	2.4	203	3.7	ID	V
P4	S	M	LER	2.4	287	3.7	ID	V
P5	S	S	NF	2.4	090	4.5'-10'	PR	V
P6	S	S	NF	2.4	270	4.5'-10'	PR	V
P7	S	M	LER	4.5	020	3.7	ID	V
P8	S	M	LER	4.5	115	3.7	ID	V
P9	S	M	LER	4.5	203	3.7	ID	V
P10	S	M	LER	4.5	290	3.7	ID	V
P11	S	S	NF	4.5	090	4.5'-10'	PR	V
P12	S	S	NF	4.5	270	4.5'-10'	PR	V
P13	S	M	LER	6.5	020	3.7	ID	V
P14	S	M	LER	6.5	105	3.7	ID	V
P15	S	M	LER	6.5	203	3.7	ID	V
P16	S	M	LER	6.5	290	3.7	ID	V
P17	S	M	LER/LT	7.0	015	1.8	RD	R/V
P18	S	M	LER/LT	7.0	105	1.8	RD	R/V
P19	S	M	LER/LT	7.0	195	1.8	RD	R/V
P20	S	M	LER/LT	7.0	285	1.8	RD	R/V
P21	S	M	LT/LT	7.5	15-195	1.5	RD	R
P22	S	M	LT/LT	7.8	105-285	1.5	RD	R
P23	S	S	NF	8.0	090	4.5'-10'	PR	V
P24	S	S	NF	8.0	270	4.5'-10'	PR	V
P26	S	M	NF	0-21	060	6.0	W	V
P30	S	M	NF	0-21	300	19.5	W	V
P32	S	M	NF	0-21	300	40.0	W	V

Table P-9. Structure and Near Field Stress Measurements - HP I-1

Measure. Number	Measurement Designation										Xducer Nom Range (psi)	Xducer Ser. No.
	Br	Rec	Genl Loc	Depth (ft)	Azimuth (degrees)	Range (ft)	Meas. Type	Sens. Axis	Pred Level (psi)			
601	S	E	LER	2.5	0	3.7	IP	R	1500		004	
602	S	E	NF	2.65	7	4.0	FS	V	1500		107	
603	S	E	NF	2.15	7	4.0	FS	R	1500		111	
604	S	E	NF	2.4	7	6.0	FS	V	1500		114	
605	S	E	LER	4.5	354	3.7	IP	R	1500		007	
606	S	E	LER	4.5	349	3.7	IS	VS	1000		674011	
607	S	E	LER	4.5	349	3.7	IS	R	1500		674011	
608	S	E	NF	4.75	7	4.0	FS	V	1500		109	
609	S	E	NF	4.25	7	4.0	FS	R	1500		103	
610	S	E	NF	4.5	7	6.0	FS	V	1500		214	
611	S	E	LER	6.5	348	3.7	IP	R	1500		005	
612	S	E	NF	6.75	7	4.0	FS	V	1500		113	
613	S	E	NF	6.25	7	4.0	FS	R	1500		211	
614	S	E	LT	8.5	0	1.8	IP	R	2000		012	
615	S	E	LER	8.1	0	2.5	IP	V	2500		015	
616	S	E	LER	8.1	0	3.7	IP	V	2500		006	
617	S	E	NF	7.0	7	6.0	FS	V	1500		147	
618	S	E	LER	4.5	109	3.7	IS	VS	1000		674014	
619	S	E	LER	4.5	109	3.7	IS	R	1500		674014	
620	S	E	LER	2.5	243	3.7	IP	R	1500		011	
621	S	E	NF	2.65	233	4.0	FS	V	1500		112	

Table P-9. Structure and Near Field Stress Measurements - HP I-1 (Continued)

Measure. Number	Measurement Designation										Xducer Ser. No.
	Br	Rec	Genl	Loc	Depth (ft)	Azimuth (degrees)	Range (ft)	Meas. Type	Sens. Axis	Pred Level (psi)	
622	S	E	NF		2.15	233	4.0	FS	R	1500	142
623	S	E	NF		2.4	233	6.0	FS	V	1500	104
624	S	E	LER		4.5	249	3.7	IP	R	1000	003
625	S	E	LER		4.5	229	3.7	IS	VS	1500	674012
626	S	E	LER		4.5	229	3.7	IS	R	1500	674012
627	S	E	NF		4.75	233	4.0	FS	V	1500	110
628	S	E	NF		4.25	233	4.0	FS	R	1500	217
629	S	E	NF		4.5	233	6.0	FS	V	1500	149
630	S	E	LER		6.5	249	3.7	IP	R	1500	001
631	S	E	NF		6.75	233	4.0	FS	V	1500	101
632	S	E	NF		6.25	233	4.0	FS	R	1500	218
633	S	E	LT		8.5	240	1.8	IP	R	2000	013
634	S	E	LER		8.1	240	2.5	IP	V	2500	008
635	S	E	LER		8.1	240	3.7	IP	V	2500	014
636	S	E	NF		7.0	233	6.0	FS	V	1500	213

Table P-10. Experimental Measurements - HP I-1

Measurements Designation													
Hole Number	Measure. Number	Br	Rec	Genl	Loc	Depth (ft)	Azimuth (degrees)	Range (ft)	Meas. Type	Sens. Axis	Pred Level	Xducer Nom Range	Comments
L24	901	X	E	FF		13.5	240	25	A	H	750g	2500g	AJ69 Lin Amp Accel
L24	901A	X	E	FF		13.5	240	25	V	H	25fps	-	Calc Velocity 1
L24	901B	X	E	FF		13.5	240	25	V	H	25fps	-	Calc Velocity 2
L24	901C	X	E	FF		13.5	240	25	A	H	750g	-	Log Amp Accel
L24	901D	X	E	FF		13.5	240	25	D	H	-	-	Calc Displacement
L24	902	X	E	FF		13.5	240	25	A	V	1000g	2500g	AC96 Lin Amp Accel
L24	902A	X	E	FF		13.5	240	25	V	V	25fps	-	Calc Velocity 1
L24	902B	X	E	FF		13.5	240	25	V	V	25fps	-	Calc Velocity 2
L24	902C	X	E	FF		13.5	240	25	A	V	1000g	-	Log Amp Accel
L24	902D	X	E	FF		13.5	240	25	D	V	-	-	Calc Displacement
L25	903	X	E	FF		4.5	240	48	A	V	2000g	2500g	AA56 Lin Amp Accel
L25	903A	X	E	FF		4.5	240	48	V	V	48fps	-	Calc Velocity 1
L25	903B	X	E	FF		4.5	240	48	V	V	48fps	-	Calc Velocity 2
L25	903C	X	E	FF		4.5	240	48	A	V	2000g	-	Log Amp Accel
L25	903D	X	E	FF		4.5	240	48	D	V	-	-	Calc Displacement
L25	904	X	E	LER		7.0	180	3.0	N	0	20mV	-	
L25	905	X	E	LER		7.0	185	3.0	N	0	20mV	-	

Table P-11. Record Assignment Table - Van 3 - Recorders 1 & 2 - HP I-1

MUX	TRACK	NUMBER																		
		VCO DATA BANDWIDTH (kHz)																		
		1	2	3	4	5	6	7	8	9	10	11	12	13	14	15	16	17	18	
	1																			
	2																			
1	3	201	202	203	204	205	206	207	208	209	210	211	212	213	214	215	216	217	218	
2	4	219	220	221	222	223	224	225	226	227	228	229	230	231	232	233	234	235	236	
3	5	237	238	239	240	241	242	243	244	245	246	247	248	249	250	251	252	253	254	
4	6	255	256	257	301	302	303	304	306	307	309	310	312	313	315	316	318	319	321	
VIDAR	7	IRIG A		FIDU		IRIG B														
5	8	322	324	325	327	328	330	331	333	334	336	337	339	340	342	343	345	346	348	
6	9	349	351	352	354	355	356	357	301A	302A		364	365	366	367	368	369	303A		
7	10	IRIG B	FIDU	376	377	378	379	380	381	388	389	390	391	392	393	394	601	602	603	
8	11	604	605	606	607	608	609	610	611	612	613	614	615	616	617	618	619	620	621	
9	12	622	623	624	625	626	627	628	629	630	631	632	633	634	635	636				
	13																			
	14																			

Table P-12. Record Assignment Table - Van 5 - HP I-1

MUX	T R A C K	NUMBER																
		DATA BANDWIDTH (kHz)																
		VCO																
		1	2	3	4	5	6	7	8	9	10	11	12	13	14	15	16	17
		$\frac{1}{1}$	$\frac{2}{1}$	$\frac{3}{1}$	$\frac{4}{1}$	$\frac{5}{1}$	$\frac{6}{2}$	$\frac{7}{2}$	$\frac{8}{2}$	$\frac{9}{4}$	$\frac{10}{4}$	$\frac{11}{4}$	$\frac{12}{8}$	$\frac{13}{8}$	$\frac{14}{8}$	$\frac{15}{16}$	$\frac{16}{16}$	$\frac{17}{16}$
1	1	401	402	403	404	405	-	-	904	102	103	104	105	106	107	108	110	
2	2	406	407	408	409	410			109	111	112	119	113	114	905	116	117	
3	3	411	412	413	414	415			125	123	124	126	118	120	121	128	127	901
4	4	416	417	418	419	420				128	129	130	131	132	133	134	135	IRIG A
5	5	421	422	423	424	425				139	141	142	136	137	138	001	002	IRIG B
6	6	426	427	428	429	430					143	150	140	145	146	003	004	FIDU
7	7									151	152	153	147	148	149	005	006	FIDU
8	8									156	157	166	154	155	158	007	008	IRIG B
9	9									167	169	170	159	160	161	009	010	IRIG A
10	10									171	173	175	162	163	164	011	012	902
11	11									177	178	179	165	168	172	013	014	903
12	12	901A	901B	902A	902B	903A				180	181	182	174	317	347	015	016	901C
13	13	903B	901D	902D	903D					183	184	176	350	353	363	017	018	902C
14	14		501	502	503	504				185	186	-	358	375	311	019	020	903C

PART 2

HARD PAN I-2A EVENT

1. TEST SITE LAYOUT

Figure P-8 is a plan view of the event test site showing the HEST and BLEST areas, instrumentation placement locations in the BLEST area, and the BLEST overhead cable scheme. Figure P-9 shows the instrumentation hole locations in the HEST area, blast pressure gage locations, and the trenching plan.

2. COORDINATE SYSTEMS

HARD PAN I-2A used two different coordinate systems to locate points in the field. They were a rectangular Cartesian coordinate system with origin at one corner (the easternmost) of the HEST cavity, and a cylindrical coordinate system centered on the structure model.

In the rectangular coordinate system the positive X-direction was horizontal at 330° True from the origin, and the positive Y-direction was horizontal at 240° True. The positive Z-direction was vertically downward from the reference plane at 783.50 ft above mean sea level.

The origin of the cylindrical coordinate system was at $X=24$ ft, $Y=32$ ft, and $Z=0$ ft in the rectangular system. The positive Z-axis is downward and parallel to that of the rectangular system. Azimuths are measured clockwise from 330° True. Range is measured horizontally from the symmetry axis of the system.

Structure and near field measurement point locations are specified in the cylindrical coordinate system. All other measurement locations are specified in the rectangular coordinate system.

3. MEASUREMENT REQUIREMENTS

a. Blast Pressure

Twenty-six blast pressure gages were fielded for the HARD PAN I-2A event. Six of these were installed flush with the upper surface of the upper

structure in a manner similar to that in the HP I-1 event. The others were installed in the HEST area, with the sensing surfaces flush with the floor of the HEST cavity. Figure P-9 shows in plan view the gage locations in the HEST area. Figure P-10 shows the locations of the blast pressure gages in the top of the structure. Table P-13 lists the pertinent blast pressure measurement requirements.

b. Free Field Accelerations and Velocities

A total of 113 accelerometers and 103 velocity gages were emplaced for free field ground motion measurements at locations shown in figure P-9. These transducers (in epoxy canisters) were installed at the depths indicated in tables P-14 and P-17 in instrumentation holes drilled specifically for their placement. Table P-14 lists the pertinent free field acceleration measurement requirements and table P-17 the velocity measurement requirements.

c. Structure and Near Field Accelerations and Velocities

Seventy-six accelerometers monitored structure and near field motions for HP I-2A. Of these, 12 were attached to mounts installed in the upper structure, 20 to mounts in the lower structure, and 44 were in epoxy canisters in the near field of the structure. Four velocity gages were installed in the upper structure and four were in the lower structure. The locations of the accelerometers and velocity gages are shown on figure P-10. Tables P-15 and P-18 list the measurement requirements for the accelerations and velocities, respectively. In addition, two measurements were made of the velocity of the upper structure relative to the surrounding media. Requirements for these measurements are contained in table P-18 and their locations shown in figure P-10.

d. Relative Displacement

Ten active relative displacement measurements were made in HP I-2A. Of these, 4 were to measure the relative diametral distortion of the lower structure at two different depths; 4 to measure the vertical displacement of the upper structure relative to the lower; and 2 to measure radial displacements of the upper structure relative to the lower. The locations at which these measurements were to be made are shown in figure P-10. The measurement

requirements are listed in table P-20.

e. Strain Measurements

Strain gages were bonded to the steel rebar at various locations in the structure during its construction. Figure P-11 shows the locations at which strain measurements were made and table P-16 lists specific measurement requirements.

f. Structure and Near Field Stress

In the near field, 30 WES SE gages were emplaced to measure stresses (FS) developed in the media. Sixteen WAM interface pressure gages measured normal stresses between the medium and the structure. Four CERF interface stress gages measured both normal stress (IS-R) and vertical shear (IS-VS). The location of each of the measurement points is shown in figure P-10. The measurement requirements are listed in table P-21.

g. BLEST Field Acceleration and Velocity Measurements

Three velocity measurements were made at each of four locations in the BLEST field. These measured motions at a depth of 23 ft in the vertical, horizontal (X), and transverse (Y) directions, respectively. The measurement requirements are listed in table P-19 and the measurement locations are shown in figure P-8.

Sixteen measurements of vertical acceleration were made at the surface of the BLEST field. Table P-22 lists the measurement requirements. The accelerometers will be mounted in the bases of the photo poles to be deployed in the BLEST field at locations shown in figure P-8.

h. Experimental Measurements

Eighteen experimental measurements were made for HP I-2. These included six blast pressure measurements to be made in the HEST cavity using S^3 transducers embedded in surgical gel in depressions in the cavity floor, and one blast pressure measurement using a piezoelectric polymer transducer, also embedded in surgical gel.

Two other piezoelectric polymer gages were emplaced at a depth of 6 ft to measure soil stress and acceleration, respectively. These were located outside of the BLEST area.

To obtain seismic motion data three orthogonal acceleration measurements were made at each of three locations along, roughly, a radial extending northward from the model structure at distances of 860, 1540, and 2700 ft.

The measurement requirements for the experimental measurements are listed in table P-23 and their locations (except for the seismic) are shown in figures P-8 and P-9.

i. Passive Measurements - Structure and Near Field

Figure P-12 indicates the locations at which passive measurements were made in the structure and near field. These measurements are also listed in table P-24.

Two planar arrays of profile indicator rods at 020° and 290° were to be augmented by three layers of colored sand extending outward from the model structure at 110° for media displacement (PR) data. Twelve relative slip gages measured interface displacement (ID).

Three penetrations (C) of the upper structure were modelled. These were at 6.5 ft below the surface at 030°, 120°, and 300°. Four 21 ft holes were drilled for water level measurement (W) prior to test execution.

Four relative displacement gages were installed to measure diametral distortion of the lower structure at 8.2 and 12 ft depths. Four relative displacement gages measured relative movement between the lower and upper structure.

j. Passive Measurements - Free Field and BLEST Field

Table P-24 lists the passive measurement requirements for the Free Field (HEST area) and the BLEST field. Measurement locations are as indicated in figures P-8 and P-9.

In the HEST area three grout columns extended to a depth of 60 ft to measure horizontal media displacements. Also in the HEST area were emplaced a total of eight splice cases to test the ability of standard splices to withstand high stress and motion environments.

The passive measurement configurations in the BLEST field consisted of 24 sand columns ranging in depth from 6 ft to 13.5 ft. Metal plates (4 in by 4 in) were placed in these sand columns at 6 in intervals. Each of these plates was positively identified by sand column number and vertical depth. This series of measurements was intended to trace the BLEST overburden movement.

k. Photo Poles

Nineteen photo poles were fielded in locations shown in figure P-8. Sixteen of them were in the BLEST field and three in the HEST area. Except for two in the HEST area each 6 ft pole extended vertically upwards from a flat 2 ft by 2 ft plate resting on the surface of the ground or overburden.

Photo pole F17 was supported by a column extending through the HEST cavity to a depth of 2 ft below the cavity floor. At that depth it was supported by the standard flat plate. Photo pole F18 was supported by a column extending through the HEST overburden to a flat plate resting on the bottom of an overburden sand box.

4. CHANNEL RECORD ASSIGNMENTS

AFWL Instrumentation Vans E-1, E-3, and E-5 were used for the recording of all active instrumentation signals. Signals were multiplexed and recorded as shown in tables P-27 through P-30.

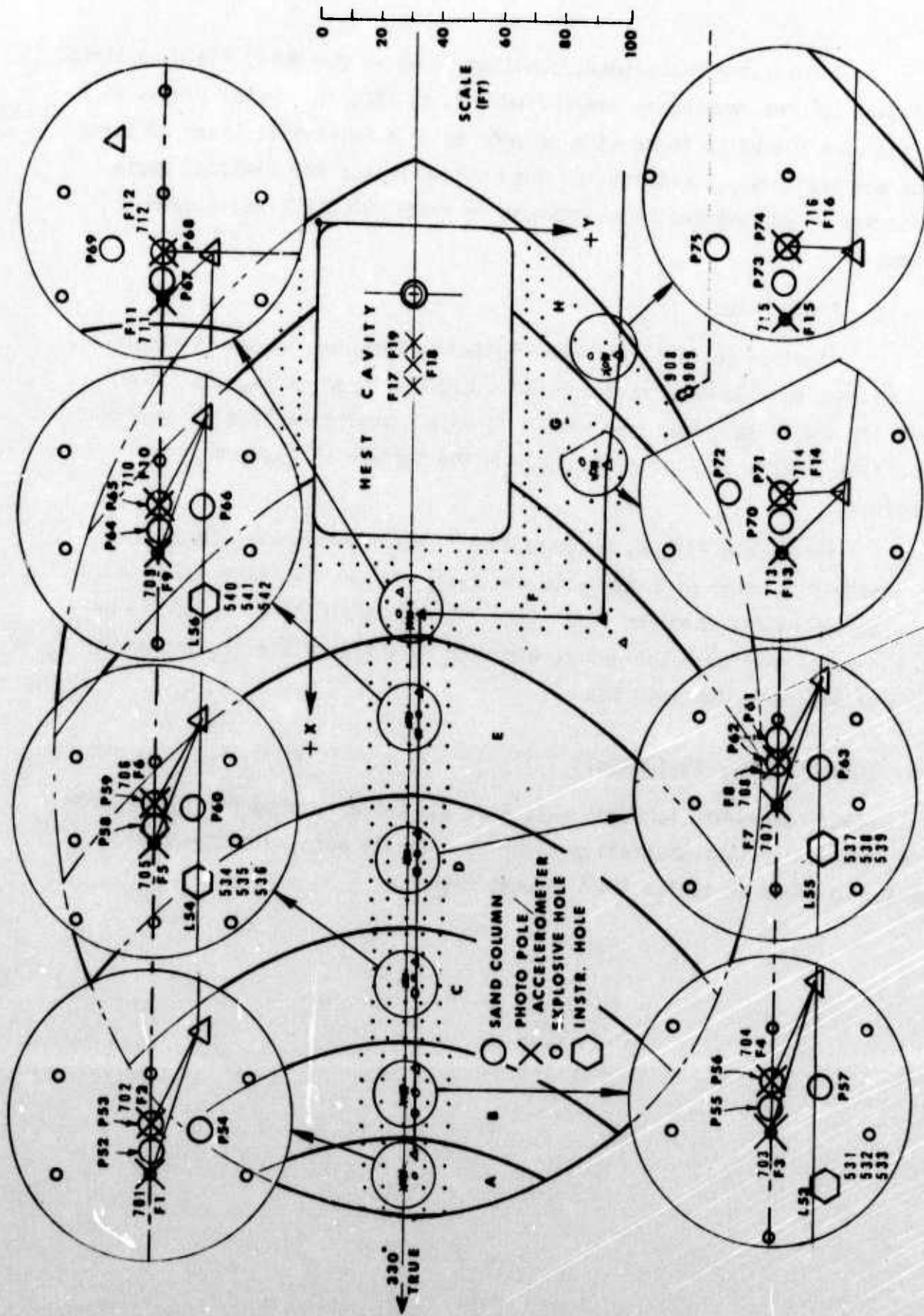

Figure P-8. HARD PAN I-2A Test Configuration Showing BLEST Area Instrumentation Locations and Photo Poles

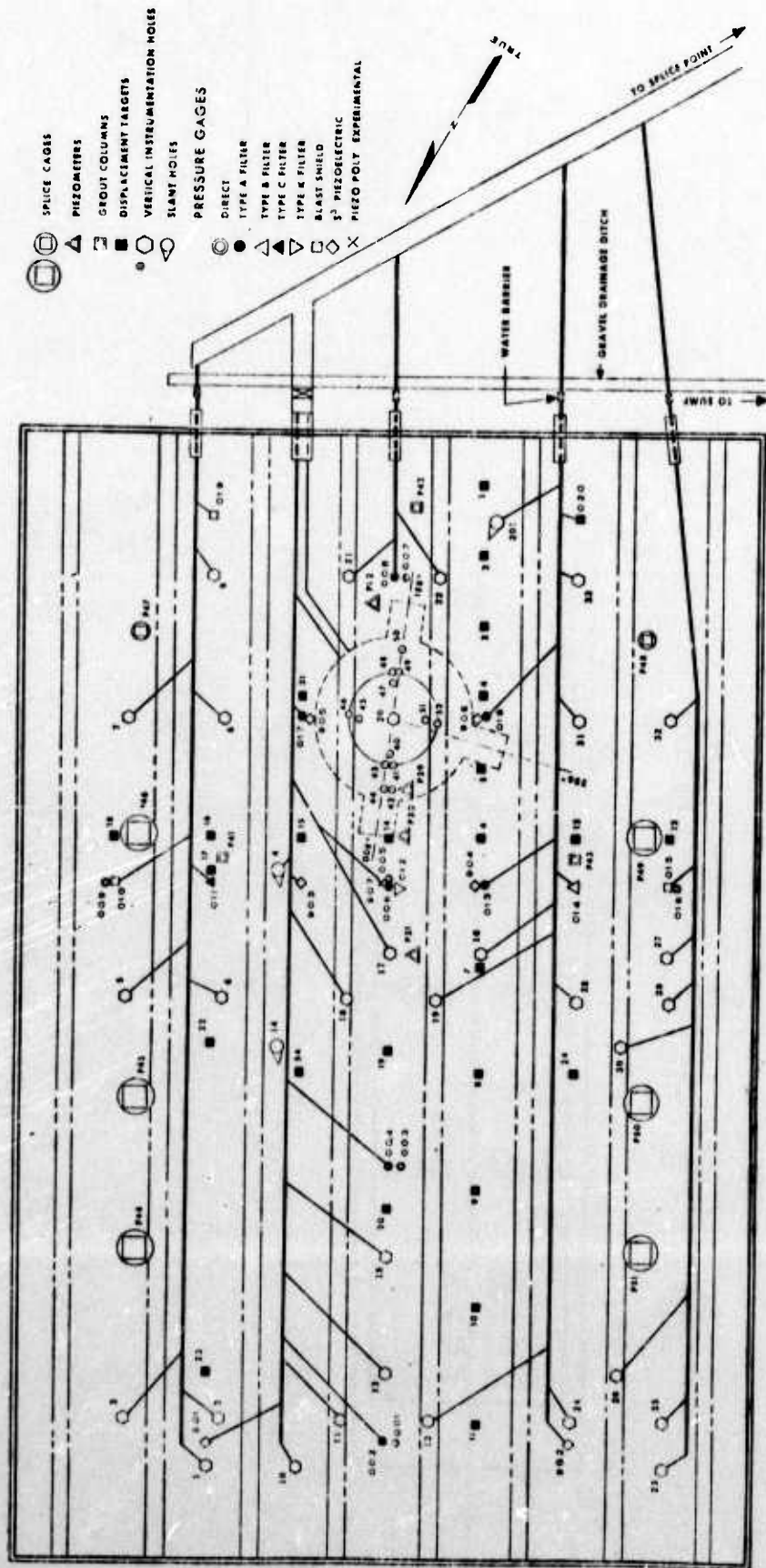

Figure P-9. HARD PAN I-2A Free Field Instrumentation Layout

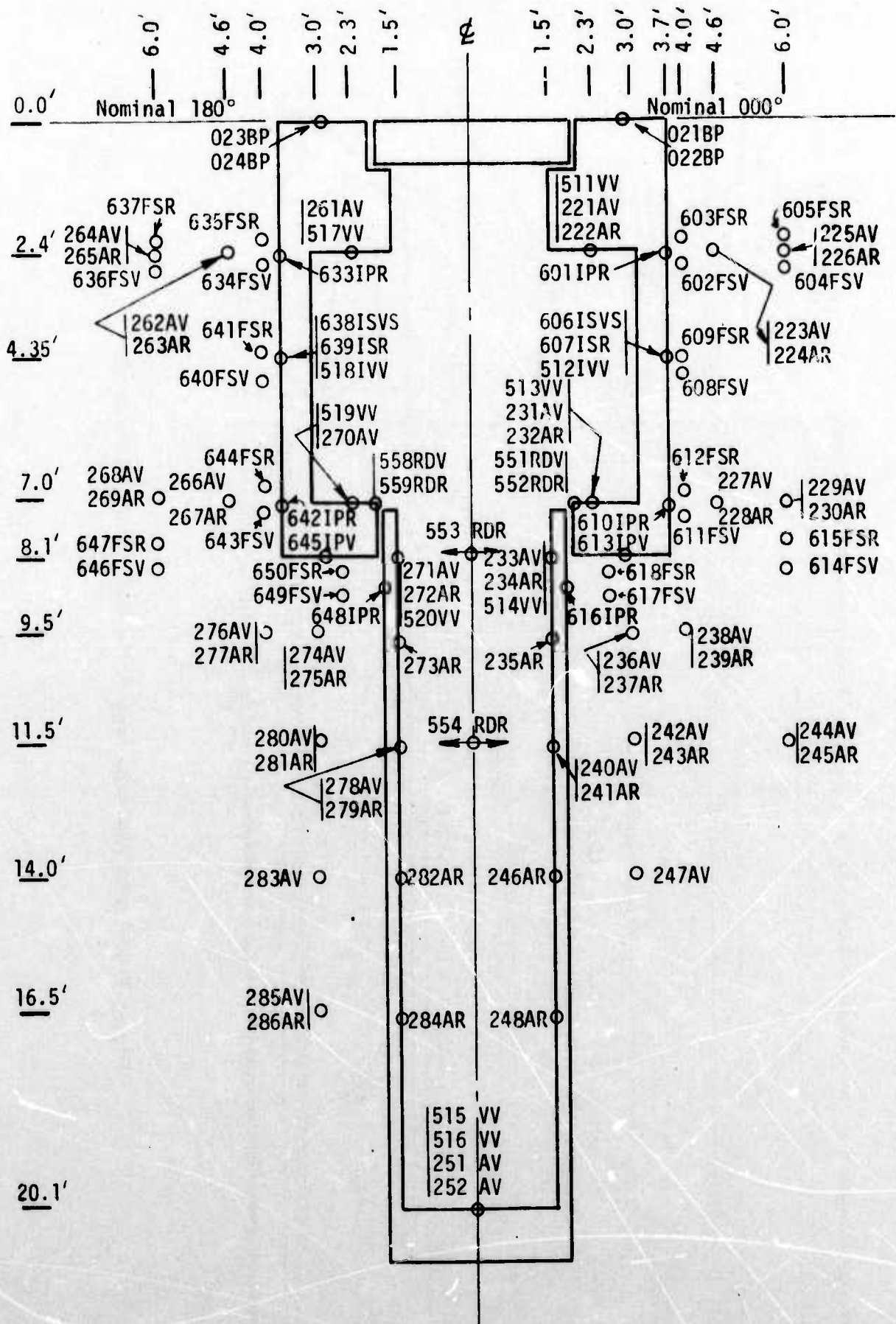

Figure P-10. Structure and Near Field Motion and Stress Measurements - HP I-2A (000° and 180° Radials)

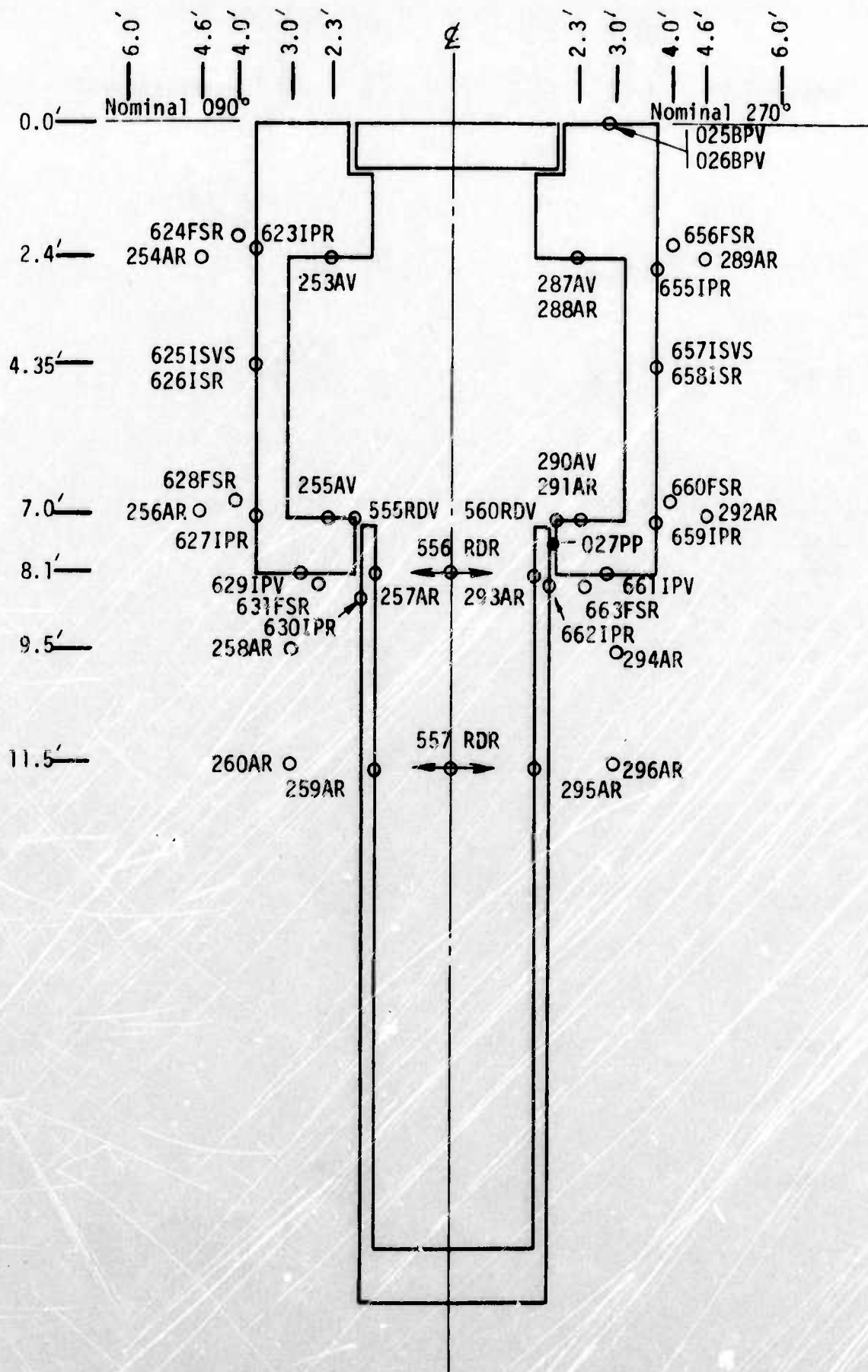

Figure P-10. Structure and Near Field Motion and Stress Measurements - HP I-2A (090° and 270° Radials) (Continued)

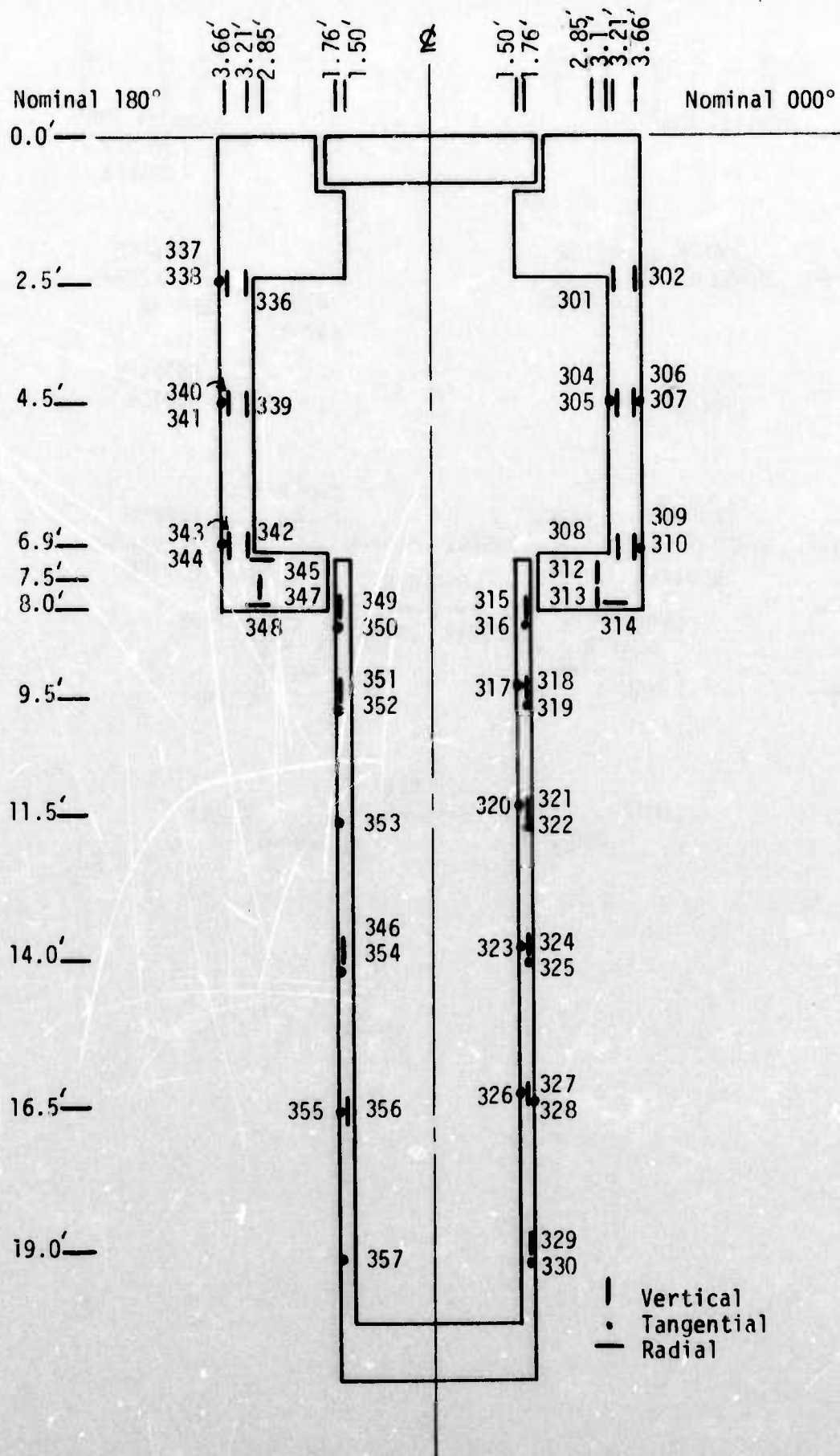

Figure P-11. Steel Strain Measurements - HP I-2A
(000° and 180° Radials)

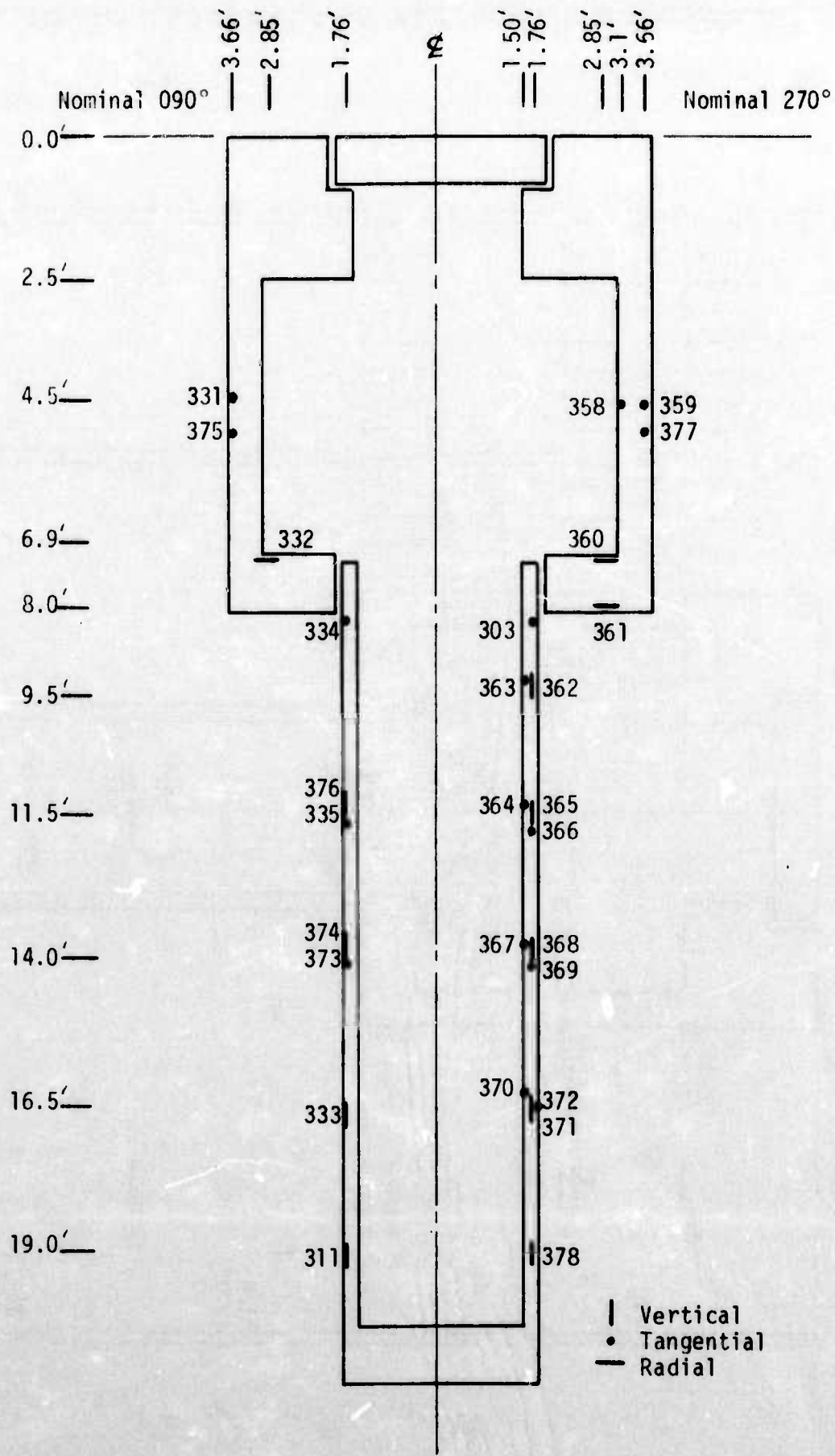

Figure P-11. Steel Strain Measurements - HP I-2A
(090° and 270° Radials)(Continued)

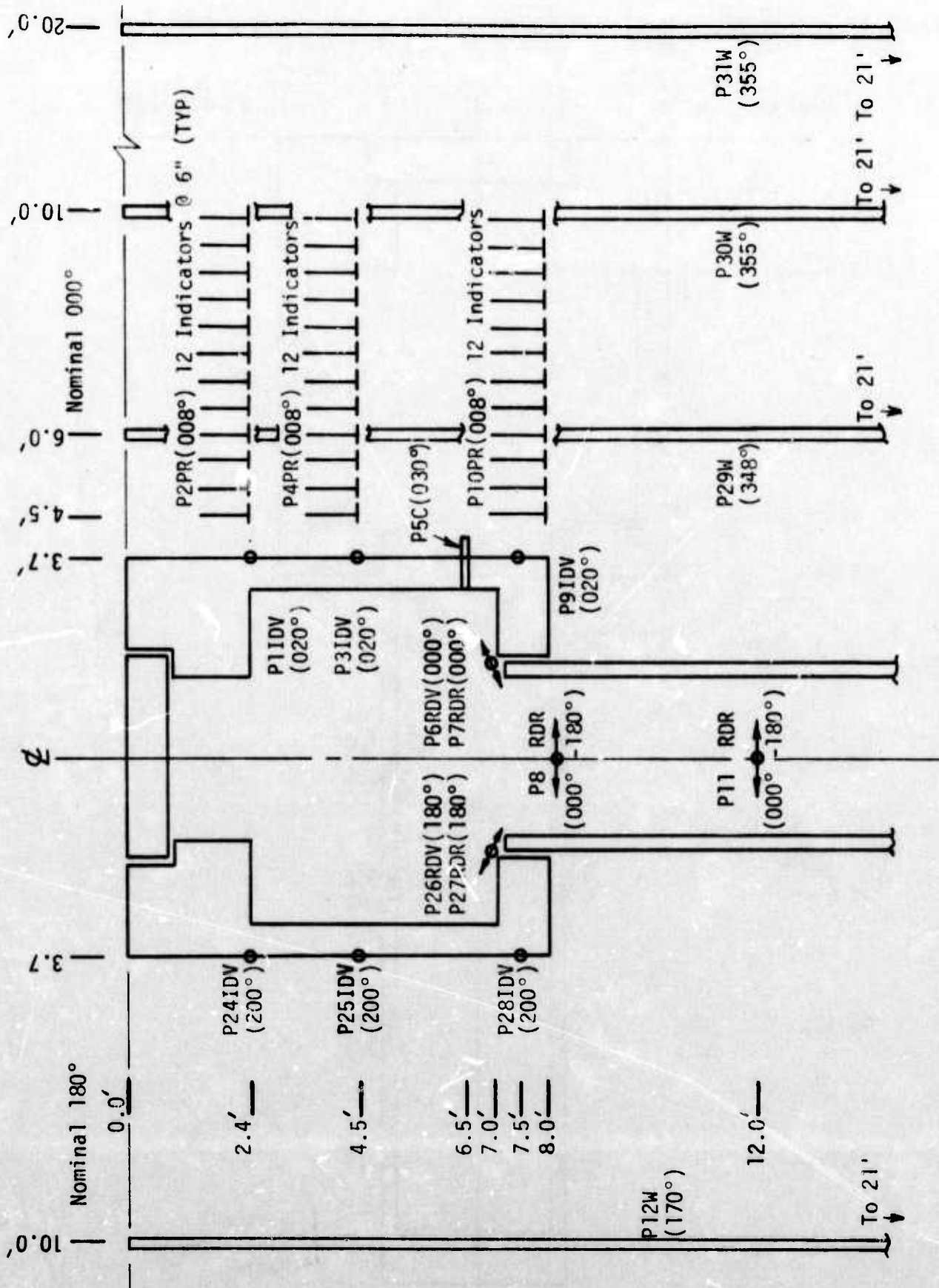

Figure P-12. Structure and Near Field Passive Measurements - HP I-2A (000° and 180° Radials)

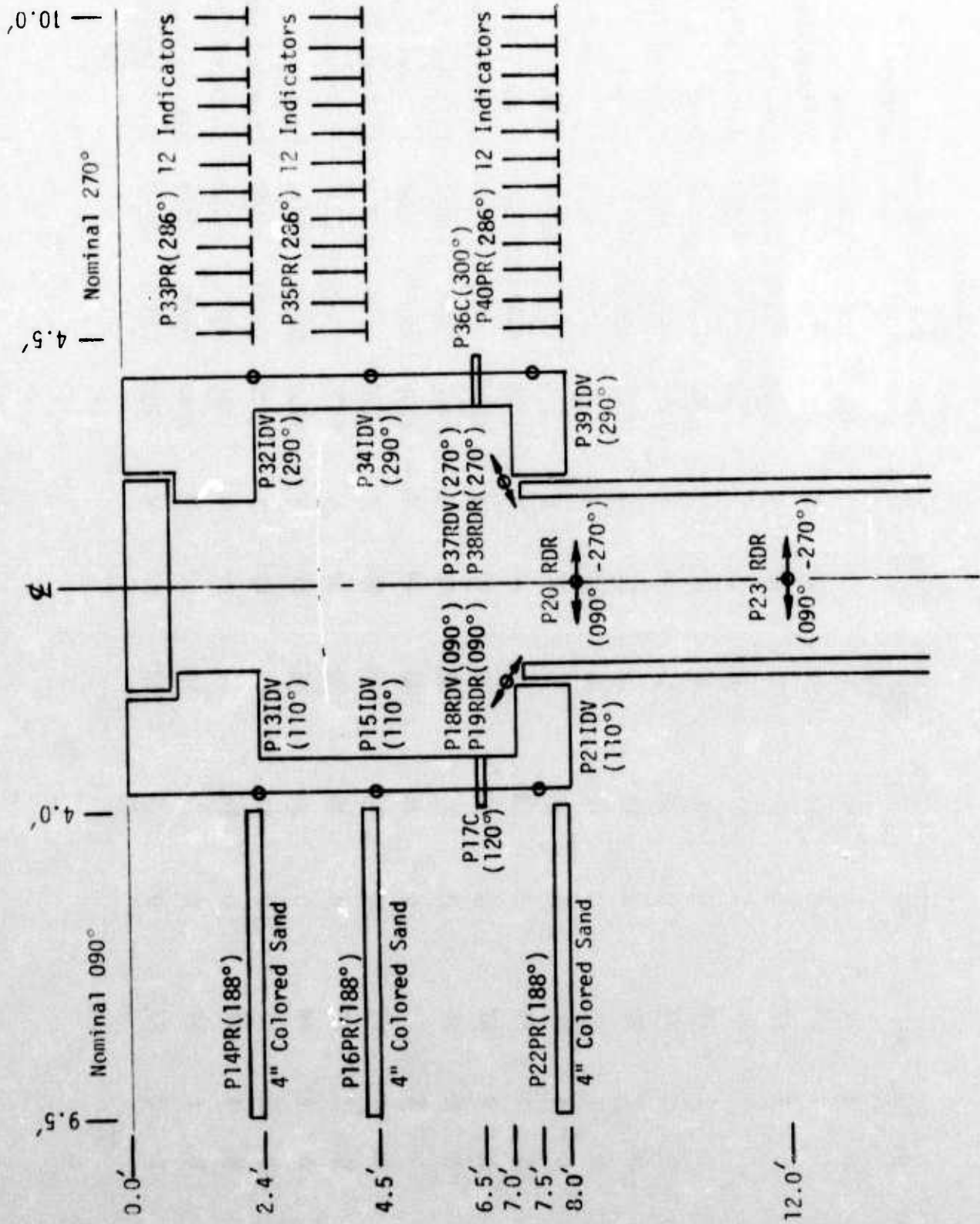

Figure P-12. Structure and Near Field Passive Measurements - HP I-2A (090° and 270° Radials) (Continued)

Table P-13. Blast Pressure Measurements - HP I-2A

Measure Number	Br	Rec	Gen	Loc	Depth (ft)	X-Coord. (ft)	Y-Coord. (ft)	Meas. Type	Sens. Axis	Pred. Level (psi)	Xducer Nom Range (psi)	Xducer S/N	Comments
001	D	E	FF	FF	0	86	32	BP	V	1200	10000	8-41	Direct
002	D	E	FF	FF	0	86	32	BP	V	1200	5000	SD014	Filtered-Type A
003	D	E	FF	FF	0	62	32	BP	V	1200	10000	SE013	Direct
004	D	E	FF	FF	0	62	32	BP	V	1200	5000	SD009	Filtered-Type A
005	D	E	FF	FF	0	38	32	BP	V	1200	10000	SE022	Direct
006	D	E	FF	FF	0	38	32	BP	V	1200	5000	SE018	Filtered-Type A
007	D	E	FF	FF	0	12	32	BP	V	1200	10000	6-15	Direct
008	D	E	FF	FF	0	12	32	BP	V	1200	5000	SD016	Filtered-Type A
009	D	E	FF	FF	0	38	8	BP	V	1200	10000	SE032	Direct
010	D	E	FF	FF	0	38	8	BP	V	1200	10000	SE028	Blast Shielded
011	D	E	FF	FF	0	38	16	BP	V	1200	5000	SD013	Filtered-Type C
012	D	E	FF	FF	0	38	32	BP	V	1200	5000	SD010	Filtered-Type K
013	D	E	FF	FF	0	38	40	BP	V	1200	10000	SE004	Filtered-Type A
014	D	E	FF	FF	0	38	48	BP	V	1200	10000	SE002	Filtered-Type B
015	D	E	FF	FF	0	38	56	BP	V	1200	10000	SE031	Blast Shielded
016	D	E	FF	FF	0	38	56	BP	V	1200	10000	SE014	Direct
017	D	E	FF	FF	0	24	24	BP	V	1200	10000	SE008	Filtered-Type A
018	D	E	FF	FF	0	24	40	BP	V	1200	10000	SE003	Filtered-Type A
019	D	E	FF	FF	0	7	16	BP	V	1200	10000	SE039	Blast Shielded
020	D	E	FF	FF	0	7	42	BP	V	1200	10000	SE040	Blast Shielded

Table P-13. Blast Pressure Measurements - HP I-2A (Continued)

Measure. Number	Br	Rec	Genl Loc	Depth (ft)	Azimuth (degrees)	Range (ft)	Meas. Type	Sens. Axis	Pred. Level (psi)	Xducer Nom Range (psi)	Xducer S/N
021	S	E	US	00.0	000	2.9	BP	V	1200	10000	SE016
022	S	E	US	00.0	000	2.9	BP	V	1200	10000	SE017
023	S	E	US	00.0	180	2.9	BP	V	1200	10000	SE029
024	S	E	US	00.0	180	2.9	BP	V	1200	10000	SE034
025	S	E	US	00.0	270	2.9	BP	V	1200	10000	SE036
025	S	E	US	00.0	270	2.9	BP	V	1200	10000	SE037
027	S	E	US	7.3	270	1.7	PP	0	50	100	B-18

Table P-14. Free Field Acceleration - HP I-2A

Canister Number	Measure. Number	Br	Rec	Genl Loc	Depth (ft)	X-Coord. (ft)	Y-Coord. (ft)	Meas. Type	Sens. Axis	Pred. Level (g)	Xducer Nom Range (g)	Xducer S/N
1	101	F	E	FF	1.5	88	16	A	V	2000	2500	DJ26
1	102	F	E	FF	1.5	88	16	A	H	1000	2500	DF89
2	103	F	E	FF	19.5	84	9	A	V	2000	2500	DF66
2	104	F	E	FF	19.5	84	9	A	H	1000	1000	166
3	105	F	E	FF	33.5	84	9	A	V	400	500	AC10
3	106	F	E	FF	33.5	84	9	A	H	400	500	AC13
4	107	F	E	FF	56	84	9	A	V	200	250	BF57
4	108	F	E	FF	56	84	9	A	H	200	250	BG36
6	109	F	E	FF	26	84	17	A	V	500	500	AC14
6	110	F	E	FF	26	84	17	A	H	500	500	AC15
7	111	F	E	FF	38.5	84	17	A	V	300	500	240
7	112	F	E	FF	38.5	84	17	A	H	300	500	249
8	113	F	E	FF	63.5	84	17	A	V	150	200	DJ86
8	114	F	E	FF	63.5	84	17	A	H	150	200	DJ89
9	115	F	E	FF	48	84	22	A	V	250	250	BF09
9	116	F	E	FF	48	84	22	A	H	250	250	BF81
10	117	F	E	FF	11	48	22	A	V	2000	2500	DF75
10	118	F	E	FF	11	48	22	A	H	1000	1000	167
11	119	F	E	FF	6.6	48	9	A	V	2000	2500	DF73
11	120	F	E	FF	6.6	48	9	A	H	1000	2500	DF69
13	121	F	E	FF	37	48	9	A	V	300	500	113
13	122	F	E	FF	37	48	9	A	H	300	500	129

Table P-14. Free Field Acceleration - HP I-2A (Continued)

Canister Number	Measure. Number	Br	Rec	Genl Loc	Depth (ft)	X-Coord. (ft)	Y-Coord. (ft)	Meas. Type	Sens. Axis	Pred. Level (g)	Xducer Nom Range (g)	Xducer S/N
14	123	F	E	FF	54.5	48	9	A	V	200	250	BG56
14	124	F	E	FF	54.5	48	9	A	H	200	250	BG52
15	125	F	E	FF	18	48	17	A	V	2000	2500	DE17
15	126	F	E	FF	18	48	17	A	H	1000	1000	187
20	127	F	E	FF	36.5	24	9	A	V	400	5000	AC18
20	128	F	E	FF	36.5	24	9	A	H	400	5000	AC26
23	129	F	E	FF	40.5	24	17	A	V	300	500	250
23	130	F	E	FF	40.5	24	17	A	H	300	500	237
25	131	F	E	FF	8	12	16	A	V	2000	2500	DJ23
25	132	F	E	FF	8	12	16	A	H	1000	1000	168
29	133	F	E	FF	1.5	88	24	A	V	2000	2500	DE71
29	134	F	E	FF	1.5	88	24	A	H	1000	2500	DA21
30	135	F	E	FF	20	84	28	A	V	2000	2500	DE41
30	136	F	E	FF	20	84	28	A	H	1000	1000	CM01 (F)
31	137	F	E	FF	38	84	28	A	V	300	500	239
31	138	F	E	FF	38	84	28	A	H	300	500	233
32	139	F	E	FF	58	84	28	A	V	175	200	DJ90
32	140	F	E	FF	58	84	28	A	H	175	200	DJ96
33	141	F	E	FF	6	84	36	A	V	2000	2500	DJ20
33	142	F	E	FF	6	84	36	A	H	1000	2500	DJ22
34	143	F	E	FF	23.5	84	36	A	V	1000	1000	164
34	144	F	E	FF	23.5	84	36	A	H	1000	1000	142

Table P-14. Free Field Acceleration - HP I-2A (Continued)

Canister Number	Measure. Number	Br	Rec	Genl Loc	Depth (ft)	X-Coord. (ft)	Y-Coord. (ft)	Meas. Type	Sens. Axis	Pred. Level (g)	Xducer Nom Range (g)	Xducer S/N
35	145	F	E	FF	47	84	36	A	V	250	250	BG85
35	146	F	E	FF	47	84	36	A	H	250	250	BG63
36	147	F	E	FF	29.5	80	32	A	V	450	5000	AC38
36	148	F	E	FF	29.5	80	32	A	H	450	5000	AC41
37	149	F	E	FF	55.5	80	32	A	V	200	200	DK02
37	150	F	E	FF	55.5	80	32	A	H	200	250	BG86
38	151	F	E	FF	65	80	32	A	V	150	200	DK06
38	152	F	E	FF	65	80	32	A	H	150	200	DK08
39	153	F	E	FF	34	71	22	A	V	400	5000	AC53
39	154	F	E	FF	34	71	22	A	H	400	5000	AC56
40	155	F	E	FF	14	66	22	A	V	2000	2500	DF70
40	156	F	E	FF	14	66	22	A	H	1000	1000	150
41	157	F	E	FF	1.5	70	32	A	V	2000	2500	DF32
41	158	F	E	FF	1.5	70	32	A	H	1000	1000	192
42	159	F	E	FF	1.5	44	40	A	V	2000	2500	DE03
42	160	F	E	FF	1.5	44	40	A	H	1000	2500	DE05
43	161	F	E	FF	18.5	44	32	A	V	2000	2500	DA36
43	162	F	E	FF	18.5	44	32	A	H	1000	1000	193
45	163	F	E	FF	58.5	44	32	A	V	175	200	DK24
45	164	F	E	FF	58.5	44	32	A	H	175	200	DK26

Table P-14. Free Field Acceleration - HP I-2A (Continued)

Canister Number	Measure. Number	Br	Rec	Genl Loc	Depth (ft)	X-Coord. (ft)	Y-Coord. (ft)	Meas. Type	Sens. Axis	Pred. Level (g)	Xducer Nom Range (g)	Xducer S/N
46	165	F	E	FF	6	48	28	A	V	2000	2500	DF34
46	166	F	E	FF	6	48	28	A	H	1000	2500	DJ53
47	167	F	E	FF	23	48	28	A	V	1150	2500	DF38
47	168	F	E	FF	23	48	28	A	H	1150	2500	DF40
49	169	F	E	FF	58.5	48	28	A	V	175	200	DK30
49	170	F	E	FF	58.5	48	28	A	H	175	200	DA32
50	171	F	E	FF	29	48	36	A	V	450	5000	AC63
50	172	F	E	FF	29	48	36	A	H	450	5000	AC64
53	173	F	E	FF	63.5	48	36	A	V	150	200	DA33
54	174	F	E	FF	33.5	24	32	A	V	400	500	223
54	175	F	E	FF	33.5	24	32	A	H	400	500	251
55	176	F	E	FF	40.5	24	32	A	V	300	500	220
55	177	F	E	FF	40.5	24	32	A	H	300	500	222
57	178	F	E	FF	53	24	32	A	V	200	250	BG42
57	179	F	E	FF	53	24	32	A	H	200	250	BG41
58	180	F	E	FF	8	12	28	A	V	2000	2500	DJ21
58	181	F	E	FF	8	12	28	A	H	1000	2500	DJ24
59	182	F	E	FF	32	12	28	A	V	400	5000	AC70
59	183	F	E	FF	32	12	28	A	H	400	5000	AC72
60	184	F	E	FF	46.5	12	28	A	V	250	250	BG37

Table P-14. Free Field Acceleration - HP I-2A (Continued)

Canister Number	Measure. Number	Br	Rec	Genl Loc	Depth (ft)	X-Coord. (ft)	Y-Coord. (ft)	Meas. Type	Sens. Axis	Pred. Level (g)	Xducer Nom Range (g)	Xducer S/N
60	185	F	E	FF	46.5	12	28	A	H	250	250	BG64
61	186	F	E	FF	63.5	12	28	A	V	150	200	DA80
61	187	F	E	FF	63.5	12	28	A	H	150	200	DC40
62	188	F	E	FF	26.5	12	36	A	V	500	5000	AC76
62	189	F	E	FF	26.5	12	36	A	H	500	5000	AC79
63	190	F	E	FF	36	12	36	A	V	300	500	232
63	191	F	E	FF	36	12	36	A	H	300	500	231
64	192	F	E	FF	53.5	12	36	A	V	200	200	DJ57
64	193	F	E	FF	53.5	12	36	A	H	200	200	DJ59
69	194	F	E	FF	6	84	56	A	V	2000	2500	DF67
69	195	F	E	FF	6	84	56	A	H	1000	2500	DF68
77	196	F	E	FF	37	48	48	A	V	300	500	229
77	197	F	E	FF	37	48	48	A	H	300	500	228
78	198	F	E	FF	63.5	48	48	A	V	150	200	DJ64
78	199	F	E	FF	63.5	48	48	A	H	150	200	DJ76
80	200	F	E	FF	27	48	56	A	V	500	5000	AC82
80	201	F	E	FF	27	48	56	A	H	500	5000	AC84
82	202	F	E	FF	8	52	52	A	V	2000	2500	DF71
82	203	F	E	FF	8	52	52	A	H	1000	2500	DF72

Table P-14. Free Field Acceleration - HP I-2A (Continued)

Canister Number	Measure. Number	Br	Rec	Genl Loc	Depth (ft)	X-Coord. (ft)	Y-Coord. (ft)	Meas. Type	Sens. Axis	Pred. Level (g)	Xducer Nom Range (g)	Xducer S/N
83	204	F	E	FF	35.5	52	52	A	V	400	5000	AC87
83	205	F	E	FF	35.5	52	52	A	H	400	5000	AC88
85	206	F	E	FF	8	24	48	A	V	2000	2500	DF76
85	207	F	E	FF	8	24	48	A	H	1000	2500	DF61
86	208	F	E	FF	40	24	48	A	V	300	500	226
86	209	F	E	FF	40	24	48	A	H	300	500	263
87	210	F	E	FF	53.5	24	48	A	V	200	200	DK01
87	211	F	E	FF	53.5	24	48	A	H	200	250	BG97
89	212	F	E	FF	49.5	24	56	A	V	200	250	BG92
89	213	F	E	FF	49.5	24	56	A	H	200	250	BH09

Table P-15. Near Field and Structure Accelerations - HP I-2A

Canister Number	Measure. Number	Br	Rec	Genl Loc	Depth (ft)	Azimuth (degrees)	Range (ft)	Meas. Type	Sens. Axis	Pred. Level (g)	Xducer Nom Range (g)	Xducer S/N
	221	S	E	US	2.4	000	2.3	A	V	2000	5000	BA45
	222	S	E	US	2.4	000	2.3	A	R	2000	5000	BA44
100	223	S	E	NF	2.4	000	4.6	A	V	2000	5000	AE21S
100	224	S	E	NF	2.4	000	4.6	A	R	2000	2500	DF79S
101	225	S	E	NF	2.4	000	6.0	A	V	2000	5000	BA42S
101	226	S	E	NF	2.4	000	6.0	A	R	2000	2500	DH54S
102	227	S	E	NF	7.0	000	4.6	A	V	2000	2500	DG44S
102	228	S	E	NF	7.0	000	4.6	A	R	2000	2500	DG49S
103	229	S	E	NF	7.0	000	6.0	A	V	2000	2500	DH92S
103	230	S	E	NF	7.0	000	6.0	A	R	2000	2500	DF83S
	231	S	E	US	7.18	000	2.3	A	V	2000	2500	DA30
	232	S	E	US	7.18	000	2.3	A	R	2000	2500	DA26
	233	S	E	LS	8.1	000	1.5	A	V	500	5000	AD78
	234	S	E	LS	8.1	000	1.5	A	R	500	5000	AD98
	235	S	E	LS	9.6	000	1.5	A	R	500	5000	AE13
104	236	S	E	NF	9.5	000	3.0	A	V	1000	2500	DJ14S
104	237	S	E	NF	9.5	000	3.0	A	R	1000	2500	DH69S
105	238	S	E	NF	9.5	000	4.0	A	V	1000	2500	DE02S
105	239	S	E	NF	9.5	000	4.0	A	R	1000	2500	DJ15
	240	S	E	LS	11.6	000	1.5	A	V	500	5000	AC28

Table P-15. Near Field and Structure Accelerations - HP I-2A (Continued)

Canister Number	Measure. Number	Br	Rec	Genl Loc	Depth (ft)	Azimuth (degrees)	Range (ft)	Meas. Type	Sens. Axis	Pred. Level (g)	Xducer Nom Range (g)	Xducer S/N
	241	S	E	LS	11.6	000	1.5	A	R	500	5000	AD51
106	242	S	E	NF	11.5	000	3.0	A	V	1000	2500	DE24
106	243	S	E	NF	11.5	000	3.0	A	R	1000	2500	DJ13
107	244	S	E	NF	11.5	000	6.0	A	V	1000	2500	DB81
107	245	S	E	NF	11.5	000	6.0	A	R	1000	2500	DE29
	246	S	E	LS	14.1	000	1.5	A	R	500	1000	AD59
108	247	S	E	NF	14.0	000	3.0	A	V	1000	2500	DF49
	248	S	E	LS	16.6	000	1.5	A	R	750	1000	AC97
	249	S	E	NF	16.5	000	2.5	A	V	1000	2500	DF97
	250	S	E	NF	16.5	000	2.5	A	R	1000	2500	DF57
	251	S	E	LS	20.1	000	0.0	A	V	1000	5000	AE17
	252	S	E	LS	20.1	000	0.0	A	V	2000	5000	AD56
	253	S	E	US	2.4	090	2.3	A	V	2000	5000	AD82
110	254	S	E	NF	2.4	090	4.6	A	R	2000	2500	DJ12
	255	S	E	US	7.18	090	2.3	A	V	2000	5000	AD61
111	256	S	E	NF	7.0	090	4.6	A	R	2000	2500	DF65
	257	S	E	LS	8.1	090	1.5	A	R	500	5000	AD75
112	258	S	E	NF	9.5	090	3.0	A	R	1000	2500	DJ11
	259	S	E	LS	11.6	090	1.5	A	R	500	5000	AC98
113	260	S	E	NF	11.5	090	3.0	A	R	1000	2500	DF60

Table P-15. Near Field and Structure Accelerations - HP I-2A (Continued)

Canister Number	Measure. Number	Br	Rec	Genl Loc	Depth (ft)	Azimuth (degrees)	Range (ft)	Meas. Type	Sens. Axis	Pred. Level (g)	Xducer Nom Range (g)	Xducer S/N
	261	S	E	US	2.4	180	2.3	A	V	2000	5000	AD97
114	262	S	E	NF	2.4	180	4.6	A	V	2000	5000	AC48
114	263	S	E	NF	2.4	180	4.6	A	R	2000	2500	DF30
115	264	S	E	NF	2.4	180	6.0	A	V	2000	5000	AD67
115	265	S	E	NF	2.4	180	6.0	A	R	2000	2500	DJ29
116	266	S	E	NF	7.0	180	4.6	A	V	2000	2500	DF36
116	267	S	E	NF	7.0	180	4.6	A	R	2000	2500	DF62
117	268	S	E	NF	7.0	180	6.0	A	V	2000	2500	DE61
117	269	S	E	NF	7.0	180	6.0	A	R	2000	2500	DB86
	270	S	E	US	7.18	180	2.3	A	V	2000	5000	AD58
	271	S	E	LS	8.1	180	1.5	A	V	500	5000	AD02
	272	S	E	LS	8.1	180	1.5	A	R	500	5000	AD25
	273	S	E	LS	9.6	180	1.5	A	R	500	5000	AD47
118	274	S	E	NF	9.5	180	3.0	A	V	1000	2500	DF63
118	275	S	E	NF	9.5	180	3.0	A	R	1000	2500	DG28
119	276	S	E	NF	9.5	180	4.0	A	V	1000	2500	DJ16
119	277	S	E	NF	9.5	180	4.0	A	R	1000	2500	DF46
	278	S	E	LS	11.6	180	1.5	A	V	500	5000	AD29
	279	S	E	LS	11.6	180	1.5	A	R	500	5000	AD44
120	280	S	E	NF	11.5	180	3.0	A	V	1000	2500	DE48

Table P-15. Near Field and Structure Accelerations - HP i-2A (Continued)

Canister Number	Measure. Number	Br	Rec	Genl Loc	Depth (ft)	Azimuth (degrees)	Range (ft)	Meas. Type	Sens. Axis	Pred. Level (g)	Xducer Nom Range (g)	Xducer S/N
120	281	S	E	NF	11.5	180	3.0	A	R	1000	2500	DE82
	282	S	E	LS	14.1	180	1.5	A	R	500	5000	AD33
121	283	S	E	NF	14.0	180	3.0	A	V	1000	2500	DF59
	284	S	E	LS	16.6	180	1.5	A	R	750	5000	AD32
122	285	S	E	NF	16.5	180	3.0	A	V	1000	2500	DE30
122	286	S	E	NF	16.5	180	3.0	A	R	1000	2500	DD88
	287	S	E	US	2.4	270	2.3	A	V	2000	5000	AD69
	288	S	E	US	2.4	270	2.3	A	R	2000	5000	AD90
123	289	S	E	NF	2.4	270	4.6	A	R	2000	2500	DF58
	290	S	E	US	7.18	270	2.3	A	V	2000	5000	AC94
	291	S	E	US	7.18	270	2.3	A	R	2000	5000	AC90
124	292	S	E	NF	7.0	270	4.6	A	R	2000	2500	DF95
	293	S	E	LS	8.1	270	1.5	A	R	500	5000	AD30
125	294	S	E	NF	9.5	270	3.0	A	R	1000	2500	DF28
	295	S	E	LS	11.6	270	1.5	A	R	500	5000	AD19
126	296	S	E	NF	11.5	270	3.0	A	R	1000	2500	DF50

Table P-16. Structure Steel Strain Measurements - HP I-2A

Measure Number	CERF Tag No.	Br	Rec	Genl Loc	Depth (ft)	Azimuth (degrees)	Range (ft)	Meas. Type	Sens. Axis	Pred. Level ($\mu\epsilon$)	Comments
301	3	S	E	US	2.5	000	3.21	SE	V	1500	Amplifier
302	1	S	E	US	2.5	000	3.66	SE	V	1500	
303	37	S	E	LS	8.17	270	1.76	SE	T	1000	
304	6	S	E	US	4.5	000	3.21	SE	V	1500	
305	34	S	E	US	4.5	000	3.21	SE	T	1500	
306	4	S	E	US	4.5	000	3.66	SE	V	1500	Amplifier
307	5	S	E	US	4.5	000	3.66	SE	T	1500	Amplifier
308	9	S	E	US	6.9	000	3.21	SE	V	1500	
309	7	S	E	US	6.9	000	3.66	SE	V	1500	
310	8	S	E	US	6.9	000	3.66	SE	T	1500	
311	24	S	E	LS	18.95	090	1.76	SE	V	1000	
312	12	S	E	US	7.5	000	2.85	SE	V	1000	
313	13	S	E	US	7.75	000	2.85	SE	V	1000	Amplifier
314	11	S	E	US	8.0	000	3.1	SE	R	2000	Amplifier
315	1	S	E	LS	7.98	000	1.76	SE	V	1000	Amplifier
316	2	S	E	LS	8.17	000	1.76	SE	T	1000	
317	49	S	E	LS	9.35	000	1.5	SE	T	1000	
318	3	S	E	LS	9.41	000	1.76	SE	V	1000	
319	4	S	E	LS	9.6	000	1.76	SE	T	1000	
320	50	S	E	LS	11.35	000	1.5	SE	T	1000	
321	5	S	E	LS	11.5	000	1.76	SE	V	1000	
322	6	S	E	LS	11.6	000	1.76	SE	T	1000	

Table P-16. Structure Steel Strain Measurements - HP I-2A (Continued)

Measure Number	CERF Tag No.	Br	Rec	Gen1	Loc	Depth (ft)	Azimuth (degrees)	Range (ft)	Meas. Type	Sens. Axis	Pred. Level ($\mu\epsilon$)	Comments
323	51	S	E	LS	LS	13.85	000	1.5	SE	T	1000	
324	7	S	E	LS	LS	13.93	000	1.76	SE	V	1000	
325	8	S	E	LS	LS	14.0	000	1.76	SE	T	1000	
326	52	S	E	LS	LS	16.35	000	1.5	SE	T	1000	
327	9	S	E	LS	LS	16.55	000	1.76	SE	V	1000	
328	10	S	E	LS	LS	16.55	000	1.76	SE	T	1000	
329	11	S	E	LS	LS	18.95	000	1.76	SE	V	1000	
330	12	S	E	LS	LS	19.1	000	1.76	SE	T	1000	
331	14	S	E	US	US	4.5	090	3.66	SE	T	1500	
332	15	S	E	US	US	7.05	090	3.1	SE	R	1500	
333	22	S	E	LS	LS	16.55	090	1.76	SE	V	1000	
334	13	S	E	LS	LS	8.17	090	1.76	SE	T	1000	
335	17	S	E	LS	LS	11.6	090	1.76	SE	T	1000	
336	17	S	E	US	US	2.5	180	3.21	SE	V	1500	Amplifier
337	19	S	E	US	US	2.5	180	3.66	SE	V	1500	
338	18	S	E	US	US	2.5	180	3.66	SE	T	1000	
339	20	S	E	US	US	4.5	180	3.21	SE	V	1500	
340	22	S	E	US	US	4.5	180	3.66	SE	V	1500	
341	21	S	E	US	US	4.5	180	3.66	SE	T	1500	
342	23	S	E	US	US	6.9	180	3.21	SE	V	1500	
343	25	S	E	US	US	6.9	180	3.66	SE	V	1500	
344	24	S	E	US	US	6.9	180	3.66	SE	T	1500	

Table P-16. Structure Steel Strain Measurements - HP I-2A (Continued)

Measure Number	CERF Tag No.	Br	Rec	Gen	Loc	Depth (ft)	Azimuth (degrees)	Range (ft)	Meas. Type	Sens. Axis	Pred. Level ($\mu\epsilon$)	Comments
345	26	S	E	US	US	7.05	180	3.1	SE	R	1500	
346	31	S	E	LS	LS	13.93	180	1.76	SE	V	1000	
347	29	S	E	US	US	7.75	180	2.85	SE	V	1000	
348	27	S	E	US	US	8.0	180	3.1	SE	R	2000	Amplifier
349	25	S	E	LS	LS	7.98	180	1.76	SE	V	1000	Amplifier
350	26	S	E	LS	LS	8.17	180	1.76	SE	T	1000	
351	27	S	E	LS	LS	9.41	180	1.76	SE	V	1000	
352	28	S	E	LS	LS	9.6	180	1.76	SE	T	1000	
353	30	S	E	LS	LS	11.6	180	1.76	SE	T	1000	
354	32	S	E	LS	LS	14.0	180	1.76	SE	T	1000	
355	34	S	E	LS	LS	16.55	180	1.76	SE	T	1000	
356	33	S	E	LS	LS	16.55	180	1.76	SE	V	1000	
357	36	S	E	LS	LS	19.1	180	1.76	SE	T	1000	
358	30	S	E	US	US	4.5	270	3.21	SE	T	1500	
359	31	S	E	US	US	4.5	270	3.66	SE	T	1500	
360	32	S	E	US	US	7.05	270	3.1	SE	R	1500	
361	33	S	E	US	US	8.0	270	3.1	SE	R	2000	Amplifier
362	40	S	E	LS	LS	9.41	270	1.76	SE	V	1000	
363	53	S	E	LS	LS	9.35	270	1.5	SE	T	1000	
364	54	S	E	LS	LS	11.35	270	1.5	SE	T	1000	
365	42	S	E	LS	LS	11.5	270	1.76	SE	V	1000	
366	41	S	E	LS	LS	11.6	270	1.76	SE	T	1000	

Table P-16. Structure Steel Strain Measurements - HP I-2A (Continued)

Measure Number	CERF Tag No.	Br	Rec	Genl Loc	Depth (ft)	Azimuth (degrees)	Range (ft)	Meas. Type	Sens. Axis	Pred. Level ($\mu\epsilon$)	Comments
367	55	S	E	LS	13.85	270	1.5	SE	T	1000	
368	44	S	E	LS	13.93	270	1.76	SE	V	1000	
369	43	S	E	LS	14.0	270	1.76	SE	T	1000	
370	56	S	E	LS	16.35	270	1.5	SE	T	1000	
371	46	S	E	LS	16.55	270	1.76	SE	V	1000	
372	45	S	E	LS	16.55	270	1.76	SE	T	1000	
373	19	S	E	LS	14.0	090	1.76	SE	T	1000	
374	20	S	E	LS	13.93	090	1.76	SE	V	1000	
375	43	S	E	US	5.0	090	3.66	SE	L	1500	Connected as full-bridge transducer*
		S	E	US	5.0	090	3.66	SE	C		
		S	E	US	5.04	090	3.66	SE	L		
		S	E	US	5.04	090	3.66	SE	C		
376	18	S	E	LS	11.50	090	1.76	SE	V	1000	
		S	E	US	5.0	270	3.21	SE	L		
377	52	S	E	US	5.0	270	3.21	SE	C	1500	Connected as full-bridge transducer*
		S	E	US	5.04	270	3.21	SE	L		
		S	E	US	5.04	270	3.21	SE	C		
		S	E	US	5.04	270	3.21	SE	C		
378	48	S	E	LS	18.95	270	1.76	SE	V	1000	

*Each full bridge transducer consists of four single SE-type strain gages, mounted on a horizontal "hoop" rebar at approximately 5' depth in the US. Each full bridge is oriented tangentially, the individual legs being longitudinal (L=green-white leads) or circumferential (C=black-white leads) on the rebar. Red-white leads are common.

Table P-17. Free Field Velocity Measurements - HP I-2A

Canister Number	Measure. Number	Br	Rec	Gen1 Loc	Depth (ft)	X-Coord. (ft)	Y-Coord. (ft)	Meas. Type	Sens. Axis	Pred. Level (fps)	Xducer Damping Fluid (cs)	Xducer S/N
3	401	F	E	FF	33.5	84	9	V	V	15	3000	2907
3	402	F	E	FF	33.5	84	9	V	H	7.5	2000	1619
4	403	F	E	FF	56	84	9	V	V	8	2000	2819
4	404	F	E	FF	56	84	9	V	H	4	2000	0202
5	405	F	E	FF	6	84	17	V	V	27	3000	2309
5	406	F	E	FF	6	84	17	V	H	9	2000	1840
8	407	F	E	FF	63.5	84	17	V	V	5	1000	2911
8	408	F	E	FF	63.5	84	17	V	H	2.5	1000	2965
12	409	F	E	FF	25	48	9	V	V	20	3000	0638
12	410	F	E	FF	25	48	9	V	H	10	2000	1552
16	411	F	E	FF	33	48	17	V	H	15	2000	2939
16	412	F	E	FF	33	48	17	V	H	7.5	2000	2334
17	413	F	E	FF	48	48	17	V	V	10	2000	2928
17	414	F	E	FF	48	48	17	V	H	5	1000	2892
18	415	F	E	FF	63.5	48	17	V	V	5	1000	2914
18	416	F	E	FF	63.5	48	17	V	H	2.5	1000	2983
19	417	F	E	FF	8	24	9	V	V	25	3000	2957
19	418	F	E	FF	6.8	24	9	V	H	10	2000	0571
19	419	F	E	FF	6.8	24	9	V	T	10	2000	1541
21	420	F	E	FF	46.5	24	9	V	V	10	2000	2923
21	421	F	E	FF	46.5	24	9	V	H	5	2000	1859

Table P-17. Free Field Velocity Measurements - HP I-2A (Continued)

Canister Number	Measure. Number	Br	Rec	Genl Loc	Depth (ft)	X-Coord. (ft)	Y-Coord. (ft)	Meas. Type	Sens. Axis	Pred. Level (fps)	Xducer Damping Fluid (cs)	Xducer S/N
22	422	F	E	FF	25.5	24	17	V	V	20	2000	2930
22	423	F	E	FF	25.5	24	17	V	H	10	2000	1534
22	424	F	E	FF	25.5	24	17	V	T	10	2000	2059
24	425	F	E	FF	63.5	24	17	V	V	5	1000	2902
24	426	F	E	FF	63.5	24	17	V	H	2.5	1000	2974
26	427	F	E	FF	24	12	16	V	V	20	3000	2927
26	428	F	E	FF	24	12	16	V	H	10	2000	2049
27	429	F	E	FF	40.5	12	16	V	V	10	3000	2203
27	430	F	E	FF	40.5	12	16	V	H	5	2000	0924
28	431	F	E	FF	53.5	12	16	V	V	7.5	3000	2304
28	432	F	E	FF	53.5	12	16	V	H	4	2000	1598
29	433	F	E	FF	1.5	88	24	V	V	30	3000	2943
29	434	F	E	FF	1.5	88	24	V	H	10	2000	2886
30	435	F	E	FF	20	84	28	V	V	26	3000	2940
30	436	F	E	FF	20	84	28	V	H	8.7	2000	1529
31	437	F	E	FF	38	84	28	V	V	10	2000	2925
31	438	F	E	FF	38	84	28	V	H	5	1000	2985
36	439	F	E	FF	29.5	80	32	V	V	17.6	3000	2951
36	440	F	E	FF	29.5	80	32	V	H	8.8	2000	2330
37	441	F	E	FF	55.5	80	32	V	H	3.8	1000	2964

Table P-17. Free Field Velocity Measurements - HP I-2A (Continued)

Canister Number	Measure. Number	Br	Rec	Genl Loc	Depth (ft)	X-Coord. (ft)	Y-Coord. (ft)	Meas. Type	Sens. Axis	Pred. Level (fps)	Xducer Damping Fluid (cs)	Xducer S/N
38	442	F	E	FF	65	80	32	V	V	5	1500	2915
38	443	F	E	FF	65	80	32	V	H	25	1000	2883
43	444	F	E	FF	18.5	44	32	V	V	16	2000	2938
43	445	F	E	FF	18.5	44	32	V	H	8	1000	2977
44	446	F	E	FF	33	44	32	V	V	15	2000	2956
44	447	F	E	FF	33	44	32	V	H	7.5	1000	2971
46	448	F	E	FF	6	48	28	V	T	10	1000	2975
47	449	F	E	FF	23	48	28	V	H	10.75	1000	2967
48	450	F	E	FF	41.5	48	28	V	V	10	2000	2942
48	451	F	E	FF	41.5	48	28	V	H	5	1000	2962
50	452	F	E	FF	8	48	36	V	V	25	3000	2218
50	453	F	E	FF	8	48	36	V	H	10	1000	2979
51	454	F	E	FF	29	48	36	V	H	8.75	1000	2978
52	455	F	E	FF	48	48	36	V	V	10	2000	2919
52	456	F	E	FF	48	48	36	V	H	5	1000	2961
53	457	F	E	FF	63.5	48	36	V	H	2.5	1000	2969
53	458	F	E	FF	63.5	48	36	V	V	2.5	1000	2918
54	459	F	E	FF	33.5	24	32	V	V	15	3000	1400
54	460	F	E	FF	33.5	24	32	V	H	7.5	2000	0843
56	461	F	E	FF	46.5	24	32	V	V	10	3000	2813
56	462	F	E	FF	46.5	24	32	V	H	5	2000	1821

Table P-17. Free Field Velocity Measurements - HP I-2A (Continued)

Canister Number	Measure. Number	Br	Rec	Genl Loc	Depth (ft)	X-Coord. (ft)	Y-Coord. (ft)	Meas. Type	Sens. Axis	Pred. Level (fps)	Xducer Damping Fluid (cs)	Xducer S/N
65	463	F	E	FF	1.5	88	56	V	V	30	3000	2312
65	464	F	E	FF	1.5	88	56	V	H	10	2000	2336
66	465	F	E	FF	23	84	48	V	V	21.4	2000	2944
66	466	F	E	FF	23	84	48	V	H	10.7	2000	1786
67	467	F	E	FF	41.5	84	48	V	V	10	2000	2933
67	468	F	E	FF	41.5	84	48	V	H	5	1000	2981
68	469	F	E	FF	63.5	84	48	V	V	5	1000	2908
68	470	F	E	FF	63.5	84	48	V	H	2.5	1000	2963
70	471	F	E	FF	26.5	84	56	V	V	20	3000	1087
70	472	F	E	FF	26.5	84	56	V	H	10	2000	0846
71	473	F	E	FF	46.5	84	56	V	V	10	3000	2170
71	474	F	E	FF	46.5	84	56	V	H	5	2000	1802
72	475	F	E	FF	18.5	80	52	V	V	23	3000	2958
72	476	F	E	FF	18.5	80	52	V	H	7.6	2000	2888
73	477	F	E	FF	36	80	52	V	V	15	3000	2949
73	478	F	E	FF	36	80	52	V	H	7.5	2000	2243
74	479	F	E	FF	55	80	52	V	V	7.3	3000	2948
74	480	F	E	FF	55	80	52	V	H	3.65	2000	0189
75	481	F	E	FF	1.5	44	56	V	V	30	3000	2281
75	482	F	E	FF	1.5	44	56	V	H	10	2000	1671
76	483	F	E	FF	20	48	48	V	V	23	3000	2945

Table P-17. Free Field Velocity Measurements - HP I-2A (Continued)

Canister Number	Measure. Number	Br	Rec	Gen1 Loc	Depth (ft)	X-Coord. (ft)	Y-Coord. (ft)	Meas. Type	Sens. Axis	Pred. Level (fps)	Xducer Damping Fluid (cs)	Xducer S/N
76	484	F	E	FF	20	48	48	V	H	7.6	2000	1832
77	485	F	E	FF	37	48	48	V	V	10	2000	2920
79	486	F	E	FF	6	48	56	V	V	28.5	3000	2954
79	487	F	E	FF	6	48	56	V	H	9.5	2000	1616
81	488	F	E	FF	49	48	56	V	V	10	2000	2878
81	489	F	E	FF	49	48	56	V	H	5	1000	2976
84	490	F	E	FF	54.5	52	52	V	V	7.3	2000	2935
84	491	F	E	FF	54.5	52	52	V	H	3.65	1000	2982
85	492	F	E	FF	8	24	48	V	T	10	1000	2881
88	493	F	E	FF	27.5	24	56	V	V	20	3000	0142
88	494	F	E	FF	27.5	24	56	V	H	10	2000	1561
88	495	F	E	FF	27.5	24	56	V	T	10	2000	1787
90	496	F	E	FF	64	24	56	V	V	5	2000	2814
90	497	F	E	FF	64	24	56	V	H	2.5	2000	1793
91	498	F	E	FF	8	12	48	V	V	25	2000	2946
91	499	F	E	FF	8	12	48	V	H	8.3	2000	2039
92	500	F	E	FF	32	12	48	V	V	15	2000	2921
92	501	F	E	FF	32	12	48	V	H	7.5	1000	2970
93	502	F	E	FF	46	12	48	V	V	10	2000	2941
93	503	F	E	FF	46	12	48	V	H	5	1000	2984

Table P-18. Structure Velocity Measurements - HP I-2A

Measure. Number	Br	Rec	Gen1 Loc	Depth (ft)	Azimuth (degrees)	Range (ft)	Meas. Type	Sens. Axis	Pred. Level (fps)	Xducer Damping Fluid (cs)	Xducer S/N
511	S	E	US	2.4	000	2.3	V	V	30	3000	2952
512	S	E	US	4.35	008	3.7	IV	V	10		
513	S	E	US	7.18	000	2.3	V	V	30	3000	2937
514	S	E	LS	8.1	000	1.5	V	V	10	2000	2934
515	S	E	LS	20.1	000	0.0	V	V	10	3000	2176
516	S	E	LS	20.1	000	0.0	V	V	10	2000	2947
517	S	E	US	2.4	180	2.3	V	V	30	3000	2936
518	S	E	US	4.35	189	3.7	IV	V	10		
519	S	E	US	7.18	180	2.3	V	V	30	3000	2313
520	S	E	LS	8.1	180	1.5	V	V	10	2000	2924

Table P-19. BLEST Field Velocity Measurements - HP I-2A

Measure Number	Br	Rec	Gen1 Loc	Depth (ft)	X-Coord. (ft)	Y-Coord. (ft)	Meas. Type	Sens. Axis	Pred. Level (fps)	Xducer Damping Fluid (cs)	Xducer S/N
531	D	E	BL	23.0	278.9	35.6	V	V	20	3000	2026
532	D	E	BL	23.0	278.9	35.6	V	H	20	3000	2052
533	D	E	BL	23.0	278.9	35.6	V	T	20	3000	2238
534	D	E	BL	23.0	241.5	34.7	V	V	20	3000	2179
535	D	E	BL	23.0	241.5	34.7	V	H	20	3000	2043
536	D	E	BL	23.0	241.5	34.7	V	T	20	3000	2038
537	D	E	BL	23.0	202.6	34.9	V	V	20	3000	2198
538	D	E	BL	23.0	202.6	34.9	V	H	20	3000	2033
539	D	E	BL	23.0	202.6	34.9	V	T	20	3000	2061
540	D	E	BL	23.0	170.0	35.2	V	V	20	3000	2183
541	D	E	BL	23.0	170.0	35.2	V	H	20	3000	2048
542	D	E	BL	23.0	170.0	35.2	V	T	20	3000	2037

Table P-20. Structure Displacement Measurements - HP I-2

Measure. Number	Br	Rec	Genl Loc	Depth (ft)	Azimuth (degrees)	Range (ft)	Meas. Type	Sens. Axis	Pred. Level (in)	Xducer Nom Range (in)	Xducer S/N
551	S	E	US/LS	7.0	339	1.9	RD	V	+6,-0	10	1243326
552	S	E	US/LS	6.75	000	1.9	RD	R	+2,-1	4	2251091
553	S	E	LS	7.6	000-180	1.5	RD	R	-3,+1	6	170328
554	S	E	LS	12.0	000-180	1.5	RD	R	-3,+1	6	170304
555	S	E	US/LS	7.0	113	1.9	RD	V	+6,-0	10	1243330
556	S	E	LS	7.6	090-270	1.5	RD	R	-3,+1	6	170302
557	S	E	LS	12.0	090-270	1.5	RD	R	-3,+1	6	170344
558	S	E	US/LS	7.0	160	1.9	RD	V	+6,-0	10	1243329
559	S	E	US/LS	6.8	180	1.9	RD	R	+2,-1	4	2251080
560	S	E	US/LS	7.0	293	1.9	RD	V	+6,-0	10	1243328

Table P-21. Structure and Near Field Stress Measurements - HP I-2A

Measure. Number	Br	Rec	Genl Loc	Depth (ft)	Azimuth (degrees)	Range (ft)	Meas. Type	Sens. Axis	Pred. Level (psi)	Xducer Nom Range (psi)	Xducer S/N
601	S	E	US	2.47	000	3.7	IP	R	1500		35
602	S	E	NF	2.65	355	4.0	FS	V	1500		164
603	S	E	NF	2.15	355	4.0	FS	R	1500		206
604	S	E	NF	2.65	355	6.0	FS	V	1500		156
605	S	E	NF	2.15	355	6.0	FS	R	1500		137
606	S	E	US	4.35	354	3.7	IS	V	500		
607	S	E	US	4.35	354	3.7	IS	R	1500		
608	S	E	NF	4.75	000	4.0	FS	V	1500		
609	S	E	NF	4.25	000	4.0	FS	R	1500		
610	S	E	US	7.1	000	3.7	IP	R	1500		
611	S	E	NF	7.25	355	4.0	FS	V	1500		
612	S	E	NF	6.75	355	4.0	FS	R	1500		
613	S	E	US	8.18	000	2.9	IP	V	2000		
614	S	E	NF	8.25	000	6.0	FS	V	1500		
615	S	E	NF	7.75	000	6.0	FS	R	1500		
616	S	E	LS	8.65	000	1.8	IP	R	1500		
617	S	E	NF	8.75	000	2.5	FS	V	2000		
618	S	E	NF	8.33	000	2.5	FS	R	2000		
623	S	E	US	2.37	090	3.7	IP	R	1500		
624	S	E	NF	2.15	085	4.0	FS	R	1500		
625	S	E	US	4.35	085	3.7	IS	V	500		
626	S	E	US	4.35	085	3.7	IS	R	1500		

{ 9-74-030

{ 9-74-031

Table P-21. Structure and Near Field Stress Measurements - HP I-2A (Continued)

Measure. Number	Br	Rec	Genl Loc	Depth (ft)	Azimuth (degrees)	Range (ft)	Meas. Type	Sens. Axis	Pred. Level (psi)	Xducer Nom Range (psi)	Xducer S/N
627	S	E	US	7.1	090	3.7	IP	R	1500		30
628	S	E	NF	6.75	085	4.0	FS	R	1500		202
629	S	E	US	8.18	090	2.9	IP	V	2000		28
630	S	E	LS	8.65	090	1.8	IP	R	1500		41
631	S	E	NF	8.33	090	2.5	FS	R	2000		204
633	S	E	US	2.47	180	3.7	IP	R	1500		43
634	S	E	NF	2.65	173	4.0	FS	V	1500		116
635	S	E	NF	2.15	173	4.0	FS	R	1500		205
636	S	E	NF	2.65	175	6.0	FS	V	1500		129
637	S	E	NF	2.15	175	6.0	FS	R	1500		169
638	S	E	US	4.36	173	3.7	IS	V	500		} 9-74-034
639	S	E	US	4.36	173	3.7	IS	R	1500		
640	S	E	NF	4.75	180	4.0	FS	V	1500		178
641	S	E	NF	4.25	180	4.0	FS	R	1500		191
642	S	E	US	7.1	180	3.7	IP	R	1500		21
643	S	E	NF	7.25	175	4.0	FS	V	1500		190
644	S	E	NF	6.75	175	4.0	FS	R	1500		177
645	S	E	US	8.18	180	2.9	IP	V	2000		23
646	S	E	NF	8.25	180	6.0	FS	V	1500		189
647	S	E	NF	7.75	173	6.0	FS	R	1500		194

Table P-21. Structure and Near Field Stress Measurements - HP I-2A (Continued)

Measure. Number	Br	Rec	Gen1 Loc	Depth (ft)	Azimuth (degrees)	Range (ft)	Meas. Type	Sens. Axis	Pred. Level (psi)	Xducer Nom Range (psi)	Xducer S/N
648	S	E	LS	8.65	180	1.8	IP	R	1500		40
649	S	E	NF	8.75	180	2.5	FS	V	2000		228
650	S	E	NF	8.33	180	2.5	FS	R	2000		162
655	S	E	US	2.47	270	3.7	IP	R	1500		34
656	S	E	NF	2.15	265	4.0	FS	R	1500		188
657	S	E	US	4.39	262	3.7	IS	V	500		9-74-033
658	S	E	US	4.39	262	3.7	IS	R	1500		
659	S	E	US	7.1	270	3.7	IP	R	1500		
660	S	E	NF	6.75	265	4.0	FS	R	1500		20
661	S	E	US	8.18	270	2.9	IP	V	2000		163
662	S	E	LS	8.33	270	1.8	IP	R	1500		32
663	S	E	NF	8.5	270	2.5	FS	R	2000		44
											153

Table P-22. BLEST Field Acceleration - HP I-2A

Measure Number	Br	Rec	Gen1 Loc	Depth (ft)	X-Coord. (ft)	Y-Coord. (ft)	Meas. Type	Sens. Axis	Pred. Level (g)	Xducer Nom Range (g)	Xducer S/N
701	G	E	BL	0.0	302.2	32.0	A	V	2500	5000	AD06
702	G	E	BL	0.0	298.8	32.0	A	V	2500	5000	AD48
703	G	E	BL	0.0	275.3	32.0	A	V	2500	5000	AF47
704	G	E	BL	0.0	271.6	32.0	A	V	2500	5000	AF57
705	G	E	BL	0.0	238.8	32.0	A	V	2500	5000	AC05
706	G	E	BL	0.0	236.0	32.0	A	V	2500	5000	AC54
707	G	E	BL	0.0	199.8	32.0	A	V	2500	5000	AC50
708	G	E	BL	0.0	196.9	32.0	A	V	2500	5000	AC01
709	G	E	BL	0.0	166.8	32.0	A	V	2500	5000	AC59
710	G	E	BL	0.0	163.5	32.0	A	V	2500	5000	AC04
711	G	E	BL	0.0	118.2	32.0	A	V	2500	5000	AC12
712	G	E	BL	0.0	114.6	32.0	A	V	2500	5000	AC61
713	G	E	BL	0.0	76.5	90.1	A	V	2500	5000	AC80
714	G	E	BL	0.0	72.3	90.1	A	V	2500	5000	AC21
715	G	E	BL	0.0	43.8	92.9	A	V	2500	5000	AC19
716	G	E	BL	0.0	38.6	92.9	A	V	2500	5000	AC09

Table P-23. Experimental Measurements - HP I-2A

Measure. Number	Br	Rec	Genl Loc	Depth (ft)	X-Coord. (ft)	Y-Coord. (ft)	Meas. Type	Sens. Axis	Pred. Level	Xducer Mom Range	Xducer S/N	Comments
901	X	E	FF	0.0	85.7	16.3	BP	V	1200 psi	4000 psi		S ³ *
902	X	E	FF	0.0	86.3	47.9	BP	V	1200 psi	4000 psi		S ³
903	X	E	FF	0.0	37.8	27.3	BP	V	1200 psi	4000 psi		S ³
904	X	E	FF	0.0	41.3	40.6	BP	V	1200 psi	4000 psi		S ³
905	X	E	FF	0.0	26.0	23.5	BP	V	1200 psi	4000 psi		S ³
906	X	E	FF	0.0	21.8	40.8	BP	V	1200 psi	4000 psi		S ³
907	X	E	FF	0.0	41.0	32.0	BP	V	1200 psi	3000 psi	#1	Piezo Poly
908	X	E	BL	6.0	47.5	114.6	A	H	1000 g		#2	Piezo Poly
909	X	E	BL	6.0	47.5	114.6	FS	H	1000 psi	3000 psi	#3	Piezo Poly
910	X	E	FR	0.0	615	-583	A	V	2.5 g	5 g		Seismic
911	X	E	FR	0.0	615	-583	A	L	2.5 g	5 g		Seismic
912	X	E	FR	0.0	615	-583	A	T	2.5 g	5 g		Seismic
913	X	E	FR	0.0	916	-1234	A	V	0.5 g	1 g		Seismic
914	X	E	FR	0.0	916	-1234	A	L	0.5 g	1 g		Seismic
915	X	E	FR	0.0	916	-1234	A	T	0.5 g	1 g		Seismic
916	X	E	FR	0.0	487	-2495	A	V	0.25 g	0.5 g		Seismic
917	X	E	FR	0.0	487	-2495	A	L	0.25 g	0.5 g		Seismic
918	X	E	FR	0.0	487	-2495	A	T	0.25 g	0.5 g		Seismic
					Azimuth (degrees)	Range (ft)						
919	X	E	US	7.0	180	3.0	N	0	20mV			350Ω Bridge
920	X	E	US	7.0	180	3.0	N	0	20mV			1000Ω Bridge

*Systems Science and Software

Table P-24. Passive Gages - Structure and Near Field - HP I-2A

Measure. Number	Br	Rec	Gen1 Loc	Depth (ft)	Azimuth (degrees)	Range (ft)	Meas. Type	Sens. Axis	Pred. Level	Comments
P1	S	M	US	2.4	020	3.7	ID	V	6	
P2	S	C	NF	2.4	008	4.5-10.0	PR	V	3	
P3	S	M	US	4.5	020	3.7	ID	V	6	
P4	S	O	NF	4.5	008	4.5-10.0	PR	V	3	
P5	S	M	US	6.5	030	3.7	C	R	NA	
P6	S	M	US	7.0	000	1.8	RD	V	4	
P7	S	M	US	7.0	000	1.8	RD	R	2	
P8	S	M	LS	8.2	000-180	1.5	RD	R	2	
P9	S	M	US	7.5	020	3.7	ID	V	6	
P10	S	O	NF	8.0	008	4.5-10.0	PR	V	3	
P11	S	M	LS	12.0	000-180	1.5	RD	R	2	
P12	S	M	NF	0-21.0	170	10.0	W	V	NA	
P13	S	M	US	2.4	110	3.7	ID	V	6	
P14	S	O	NF	2.4	188	4.0-9.5	PR	V		4" colored sand layer
P15	S	M	US	4.5	110	3.7	ID	V	6	
P16	S	O	NF	4.5	188	4.0-9.5	PR	V		4" colored sand layer
P17	S	M	US	6.5	120	3.7	C	R	NA	
P18	S	M	US	7.0	90	1.8	RD	V	4	
P19	S	M	US	7.0	90	1.8	RD	R	2	
P20	S	M	LS	8.2	090-270	1.5	RD	R	2	
P21	S	M	US	7.5	110	3.7	ID	V	6	

Table P-24. Passive Gages - Structure and Near Field - HP I-2A (Continued)

Measure. Number	Br	Rec	Gen1 Loc	Depth (ft)	Azimuth (degrees)	Range (ft)	Meas. Type	Sens. Axis	Pred. Level	Comments
P22	S	0	NF	8.0	188	4.0-9.5	PR	V		4" colored sand layer
P23	S	M	LS	12.0	090-270	1.5	RD	R	2	
P24	S	M	US	2.4	200	3.7	ID	V	6	
P25	S	M	US	4.5	200	3.7	ID	V	6	
P26	S	M	US	7.0	180	1.8	RD	V	4	
P27	S	M	US	7.0	180	1.8	RD	R	2	
P28	S	M	US	7.5	200	3.7	ID	V	6	
P29	S	M	NF	0-21.0	348	6.0	W	V	NA	
P30	S	M	NF	0-21.0	355	10.0	W	V	NA	
P31	S	M	NF	0-21.0	355	20.0	W	V	NA	
P32	S	M	US	2.4	290	3.7	ID	V	6	
P33	S	0	NF	2.4	286	4.5-10.0	PR	V	3	
P34	S	M	US	4.5	290	3.7	ID	V	6	
P35	S	0	NF	4.5	286	4.5-10.0	PR	V	3	
P36	S	M	US	6.5	300	3.7	C	R	NA	
P37	S	M	US	7.0	270	1.8	RD	V	4	
P38	S	M	US	7.0	270	1.8	RD	R	2	
P39	S	M	US	7.5	290	3.7	ID	V	6	
P40	S	0	NF	8.0	286	4.5-10.0	PR	V	3	

Table P-25. Passive Gages - Free Field and BLEST Field - HP I-2A

Measure. Number	Br	Rec	Genl Loc	Depth (ft)	X (feet)	Y (feet)	Meas. Type	Sens. Axis	Pred. Level	Comments	
P41	D	0	FF	0-60.0	36.0	17.0	GD			Grout Column	
P42	D	0	FF	0-60.0	6.0	34.0	GD			Grout Column	
P43	D	0	FF	0-60.0	36.0	48.0	GD			Grout Column	
P44	P	0	FF	4.0	92.0	6.0	SC			Major axes of Splice Cases parallel to X-axis	
P45	P	0	FF	4.0	84.0	6.0	SC				
P46	P	0	FF	0.5	76.0	6.0	SC				
P47	P	0	FF	4.0	67.0	6.0	SC				
P48	P	0	FF	4.0	58.0	6.0	SC				
P49	P	0	FF	0.5	50.0	6.0	SC				
P50	P	0	FF	4.0	28.0	6.0	SC				
P51	P	0	FF	4.0	20.0	6.0	SC				
P52	D	0	BL	6.0-10.0*	300.5	32.0	SD				8 Plates
P53	D	0	BL	6.0-13.5	298.8	32.0	SD				27 Plates
P54	D	0	BL	.5-13.5	298.8	35.4	SD			27 Plates	
P55	D	0	BL	6.0-10.5	273.5	32.0	SD			8 Plates	
P56	D	0	BL	.5-13.5	271.6	32.0	SD			27 Plates	
P57	D	0	BL	.5-13.5	271.6	32.0	SD			27 Plates	
P58	D	0	BL	.5-11.5	237.4	32.0	SD			23 Plates	

*P52-P75 depths are measured from BLEST surface

Table P-25. Passive Gages - Free Field and BLEST Field - HP I-2A (Continued)

Measure. Number	Br	Rec	Genl Loc	Depth (ft)	X (feet)	Y (feet)	Meas. Type	Sens. Axis	Pred. Level	Comments
P59	D	0	BL	4.0-9.0	236.0	32.0	SD			11 Plates
P60	D	0	BL	.5-11.5	236.0	34.7	SD			23 Plates
P61	D	0	BL	.5-11.5	195.5	32.0	SD			23 Plates
P62	D	0	BL	4.0-6.0	196.9	32.0	SD			5 Plates
P63	D	0	BL	.5-11.5	196.9	34.9	SD			23 Plates
P64	D	0	BL	4.0-9.0	165.1	32.0	SD			11 Plates
P65	D	0	BL	.5-11.5	163.5	32.0	SD			23 Plates
P66	D	0	BL	.5-11.5	163.5	35.2	SD			23 Plates
P67	D	0	BL	.5-11.5	123.5	32.0	SD			23 Plates
P68	D	0	BL	4.0-9.0	121.8	32.0	SD			11 Plates
P69	D	0	BL	.5-11.5	121.8	35.6	SD			23 Plates
P70	D	0	BL	4.0-9.0	74.4	90.1	SD			11 Plates
P71	D	0	BL	4.0-9.0	72.3	90.1	SD			11 Plates
P72	D	0	BL	4.0-9.0	72.3	94.2	SD			11 Plates
P73	D	0	BL	4.0-9.0	41.4	92.9	SD			11 Plates
P74	D	0	BL	4.0-8.5	39.0	92.9	SD			10 Plates
P75	D	0	BL	4.0-8.5	39.0	88.0	SD			10 Plates

Table P-26. Photo Poles - HP I-2A

<u>Pole No.</u>	<u>X (ft)</u>	<u>Y (ft)</u>	<u>Comments</u>
F1	302.2	32.0	
F2	298.8	32.0	
F3	275.3	32.0	
F4	271.6	32.0	
F5	238.8	32.0	
F6	236.0	32.0	
F7	199.8	32.0	
F8	196.9	32.0	
F9	166.8	32.0	
F10	163.5	32.0	
F11	118.2	32.0	
F12	114.6	32.0	
F13	76.5	90.1	
F14	72.3	90.1	
F15	43.8	92.9	
F16	39.0	92.9	
F17	54.0	32.0	
F18	48.0	32.0	
F19	42.0	32.0	

Table P-27. RECORD ASSIGNMENT TABLES - VAN E 1 - HP I-2A

RECORDER NO. 1

Channel	1	2	3	4	5
Center Freq. (kHz)	62.5	100	137.5	175	212.5
Deviation (kHz)	± 10	± 10	± 10	± 10	± 10
Bandwidth (kHz)	5	5	5	5	5
T R A C K	4	910	911	912	913
	5	914	915	916	917
	6	314	348	361	301
	7	307	336	313	315
	8	←		VOICE	→
	9	←		IRIG A	→

RECORDER NO. 5

TRACK	20 kHz FM Record
1	901
2	902
3	903
4	904
5	905
6	906
7	907
8	908
9	909
10	IRIG A

Table P-28. RECORD ASSIGNMENT TABLE - VAN 3 - RECORDER 1 - HP I-2A

MUX	T R A C K	VCO NUMBER DATA BANDWIDTH (kHz)																	
		1 10	2 10	3 10	4 10	5 10	6 10	7 10	8 10	9 10	10 10	11 10	12 10	13 10	14 10	15 10	16 10	17 10	18 10
	1																		
	2																		
1	3	101	102	103	104	105	106	107	108	109	110	111	112	113	114	115	116	154**	118*
2	4	119	120	121	122	123	124	125	126	127	128	129	130	131	132	133	134	135	136
3	5	137	138	139	140	141	142	143	144	145	146	173	174	175	176	177	178	179	180
4	6	181	182	183	184	185	186	187	188	189	190	191	192	193	194	195	196	197	198
VIDAR	7	IRIG A		FIDU		IRIG B													
5	8	199	200	201	202	203	204	205	206	207	208	209	210	211	212	213	221	222	223
6	9	224	225	226	227	228	229	230	231	232	233	234	235	236	237	238	239	240	241
7	10	242	243	244	245	246	247	248	249*	250*	251	252	253	254	255	256	257	258	259
8	11	260	261	262	263	264	265	266	267	268	269	270	271	272	273	274	275	276	277
9	12	278	279	280	281	282	283	284	285	286	287	288	289	290	291	292	293	IRIG B	FIDU
	13																		
	14																		

*Deleted prior to test
**Was 117*

Table P-29. RECORD ASSIGNMENT TABLE - VAN 3 - RECORDER 2 - HP I-2A

MUX	T R A C K	NUMBER																	
		DATA BANDWIDTH (kHz)																	
		VCO																	
		1	2	3	4	5	6	7	8	9	10	11	12	13	14	15	16	17	18
		$\frac{1}{10}$	$\frac{2}{10}$	$\frac{3}{10}$	$\frac{4}{10}$	$\frac{5}{10}$	$\frac{6}{10}$	$\frac{7}{10}$	$\frac{8}{10}$	$\frac{9}{10}$	$\frac{10}{10}$	$\frac{11}{10}$	$\frac{12}{10}$	$\frac{13}{10}$	$\frac{14}{10}$	$\frac{15}{10}$	$\frac{16}{10}$	$\frac{17}{10}$	$\frac{18}{10}$
	1																		
	2																		
1	3	294	295	296	701	702	702	704	705	706	707	708	709	710	711	712	713	714	715
2	4	716	302	303	304	305	308	309	310	311	312	316	317	318	319	320	321	322	323
3	5	324	325*	326*	327	328	329	330	331	332	333*	334	335	337	338	339	342	343	344
4	6	345	346	347	340	350	351	352	353	354	355	356	357	358	359	360	341	362	363
VIDAR	7	IRIG A		FIDU		IRIG B													
5	8	364	365	366	367	368	369	370	371*	372	373	374	375	376	377	378*	601	602	603
6	9	604	605	606	607	608	609	610	611	612	613	614	615	616	617	618	623	624	625
7	10	626	627	628	629	630	631	633	634	635	636	637	638	639	640	641	642	643	644
8	11																		
9	12	645	646	647	648	649	650	655	656	657	658	659	660	661	662	663	639	IRIG B	FIDU
	13																		
	14																		

*deleted prior to test

Table P-30. RECORD ASSIGNMENT TABLE - VAN 5 - HP I-2A

MUX	T R A C K	NUMBER DATA BANDWIDTH (kHz)																
		VCO																
		1 1	2 1	3 1	4 1	5 1	6 2	7 2	8 2	9 4	10 4	11 4	12 8	13 8	14 8	15 16	16 16	17 16
1	1	401	402	403	404	405	406	407	408	409	149	150				919	920	027
2	2	410	411	412	413	414	415	416	417	418	151	152				001	002	
3	3	419	420	421	422	423	424	425	426	427	156	158				003	004	
4	4	428	429	430	431	432	433	434	435	436	162	163		147	148	005	006	IRIG A
5	5	437	438	439	440	441	442	443	444	445	164	169	153		171	007	008	
6	6	446	447	448	449	450	451	452	453	454	170		172	155		009	010	FIDU
7	7	455	456	457	458	459	460	461	462	463	IRIG B		551	552	553	011	012	FIDU
8	8	464	465	466	467	468	469	470	471	472*	IRIG B		554	555	556	013	014	
9	9	473	474	475	476	477	478	479	480	481			557	558	559	021	022	IRIG A
10	10	482	483	484	485	486	487	488	489	490			560	159	160	023	024	
11	11	491	492	493	494	495	496	497	498	499			161	165	166	025	026	
12	12	500	501	502	503	511	513	514	515	516			167*	168		015	016	
13	13	517	519	520	531	532	533	534	535	536						017	018	
14	14	537	538	539	540	541	542	512	518				157			019	020	

*deleted prior to test

PART 3

HARD PAN I SCAL EVENTS

1. DESCRIPTION OF SCAL TESTS

The SCAL series is composed of four single shot tests. In each of them a 50 lb charge of ammonium nitrate slurry was detonated. The charges were placed at a depth of 3 ft below the existing ground surface, the explosive holes were backfilled and overburden laid on the surface to a depth of 3.75 ft. To insure uniformity in the overburden, it was laid in several courses and compacted between each course. The radius to which the overburden was deposited was such as to insure that the resulting crater was within the overburden. Two of the SCAL shots (SCAL II and SCAL IV) were decoupled ones. For these events the 50 lb AN slurry charge was placed at the bottom of a 55 gal drum to provide a decoupling cavity. The charge center on these shots was at the same depth below the overburden surface as for the coupled SCAL tests. Acceleration and soil stress instrumentation were used to evaluate the test results. Photographic coverage was also provided.

2. SCAL I INSTRUMENTATION

Six accelerometers and four soil stress gages were fielded for the SCAL I test. Their locations in plan view are shown in figure P-13. Table P-31 lists the measurements and their coordinates together with predicted measurand peak values and gage information.

Although only ten transducers were fielded, a total of 34 channels of data were recorded. A PACI amplification and integration package was used with each of the accelerometers to yield an amplified acceleration signal and a velocity signal. Solid state PACI amplifiers were also used to amplify the soil stress signals. Some of the signals were recorded on a recorder located at the splice bunker in order to obtain higher frequency response through the use of shorter lines. Table P-32 lists these various measurement recordings and table P-33 presents the record assignments in tabular form.

3. SCAL II INSTRUMENTATION

In the SCAL II test six accelerometers and five soil stress gages were fielded. The measurement locations are shown in plan view in figure P-14. The basic measurements are listed and described in table P-34.

A total of 32 signals were recorded as described in table P-35. Again, these were recordings of the basic signals processed in various ways as described in the table. Table P-36 is the record assignment for the test.

4. SCAL III INSTRUMENTATION

In the SCAL III test 26 stress measurements and 9 acceleration measurements were made at locations shown in P-15. In addition, 9 strong motion seismic (acceleration) measurements were made. These basic measurements are listed in table P-37.

A total of 92 signals were recorded, as listed in table P-38. These were, as before, recordings of various treatments of the basic transducer outputs. Table P-39 is the record assignment in tabular form.

5. SCAL IV INSTRUMENTATION

Ten accelerometers and nine soil stress gages were fielded in the SCAL IV test. In addition, 3 strong motion seismic measurements were made at each of three locations. The basic measurement locations are shown in figure P-16 and their descriptions are contained in table P-40.

Thirty five signals were recorded as shown in table P-41. Redundant recordings were made of the WES SE soil gage outputs only. Table P-42 is the record assignment table for this test.

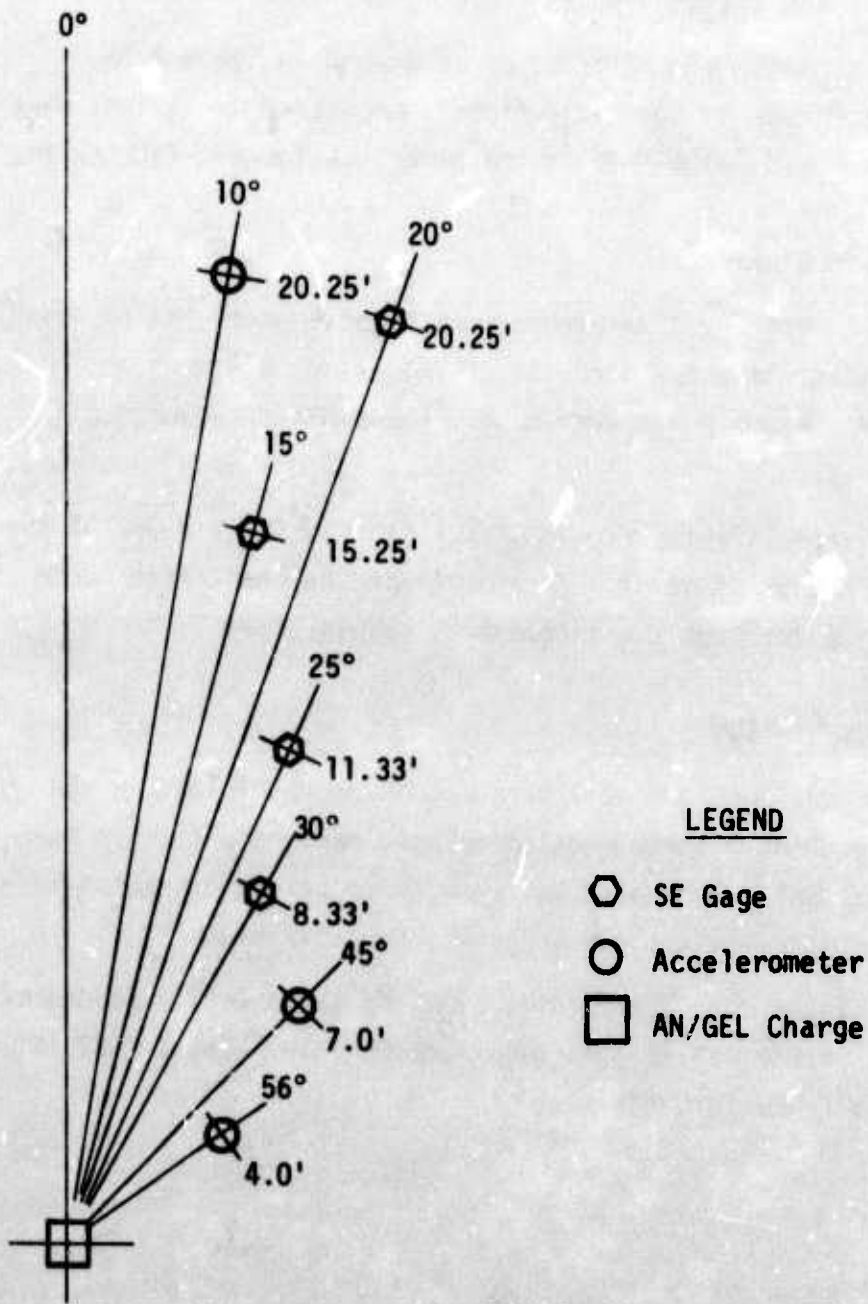

Figure P-13. SCAL I Instrumentation Layout

**THIS REPORT HAS BEEN DELIMITED
AND CLEARED FOR PUBLIC RELEASE
UNDER DOD DIRECTIVE 5200.20 AND
NO RESTRICTIONS ARE IMPOSED UPON
ITS USE AND DISCLOSURE.**

DISTRIBUTION STATEMENT A

**APPROVED FOR PUBLIC RELEASE,
DISTRIBUTION UNLIMITED.**

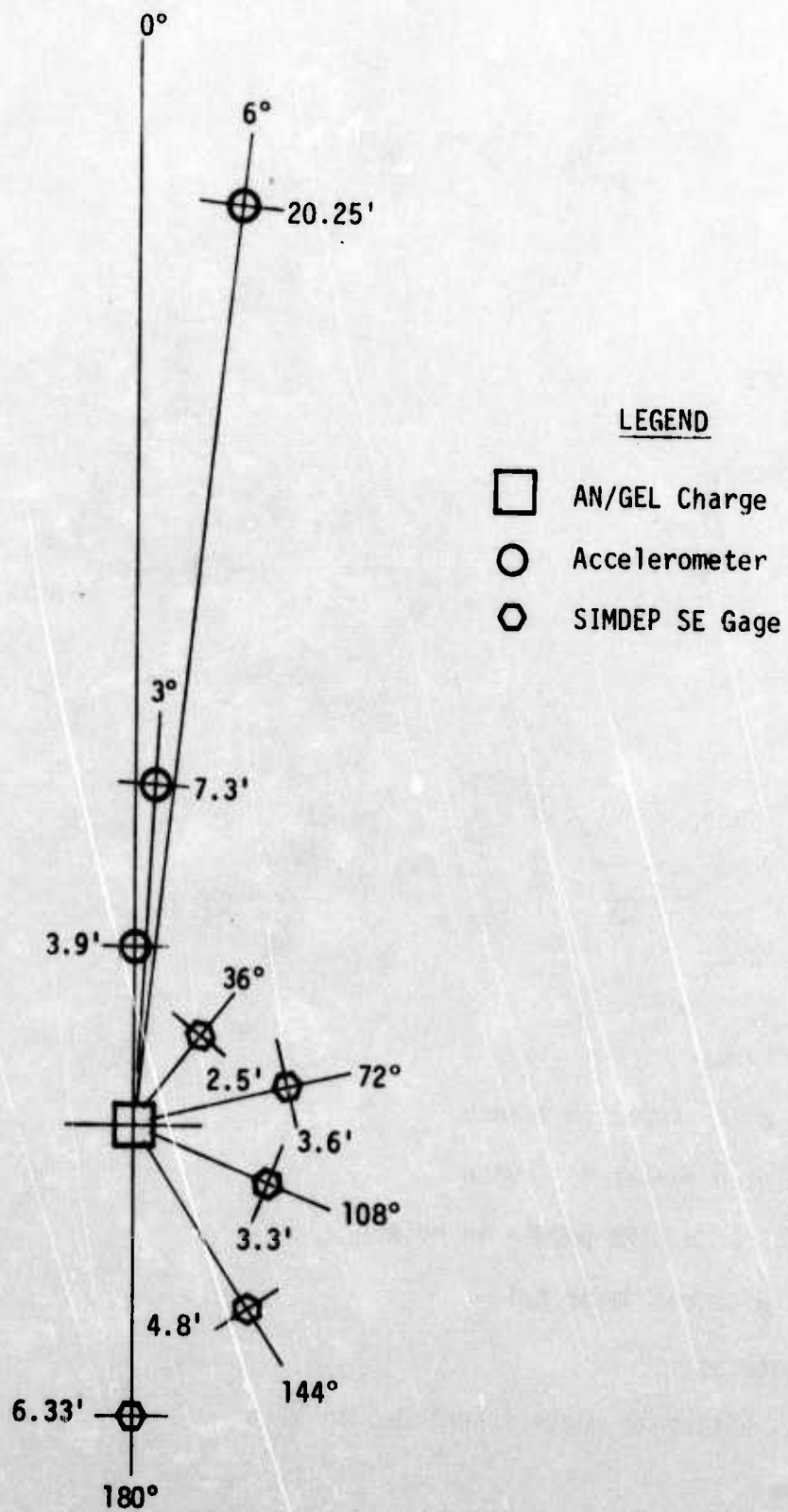

Figure P-14. SCAL II Instrumentation Layout

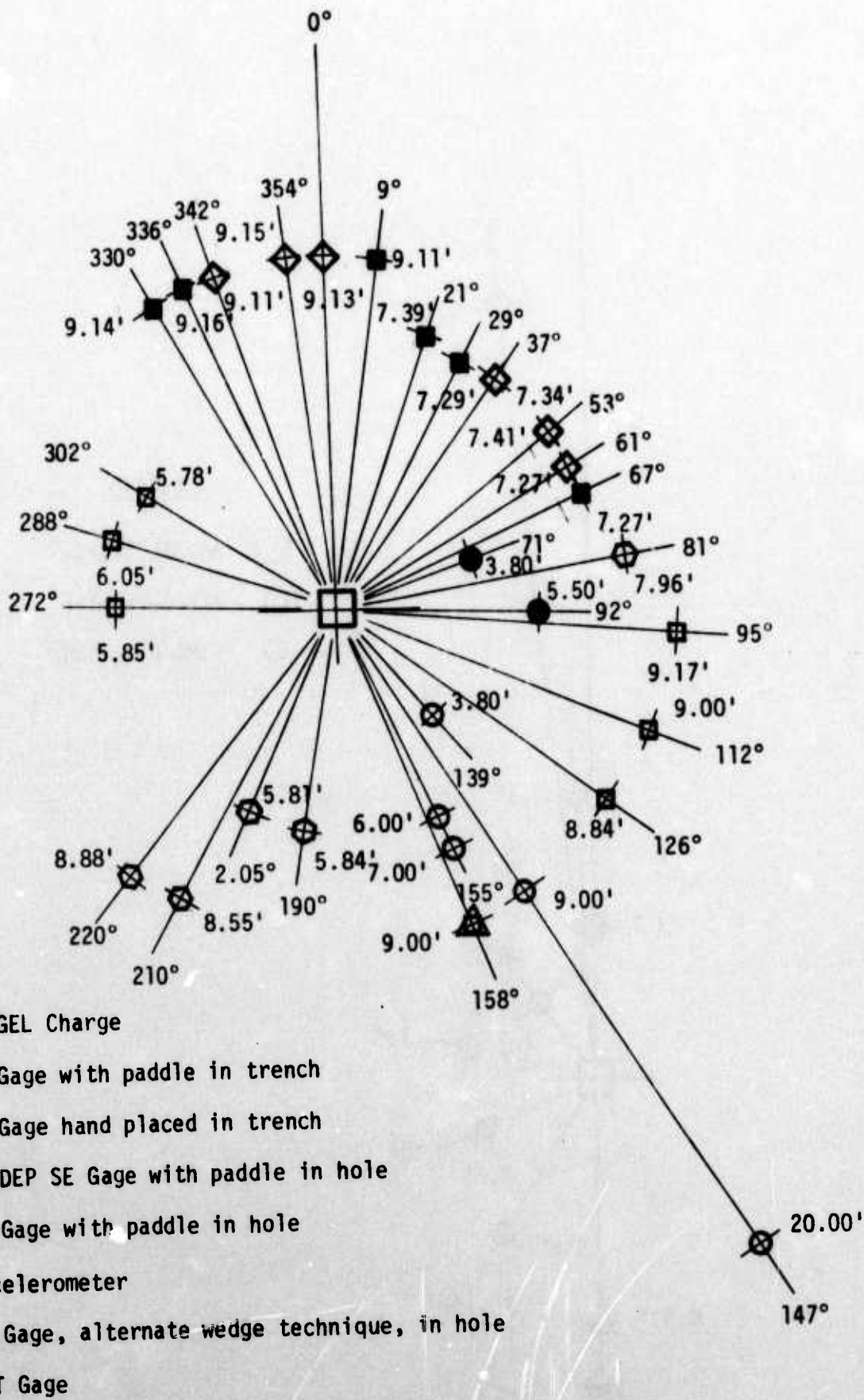
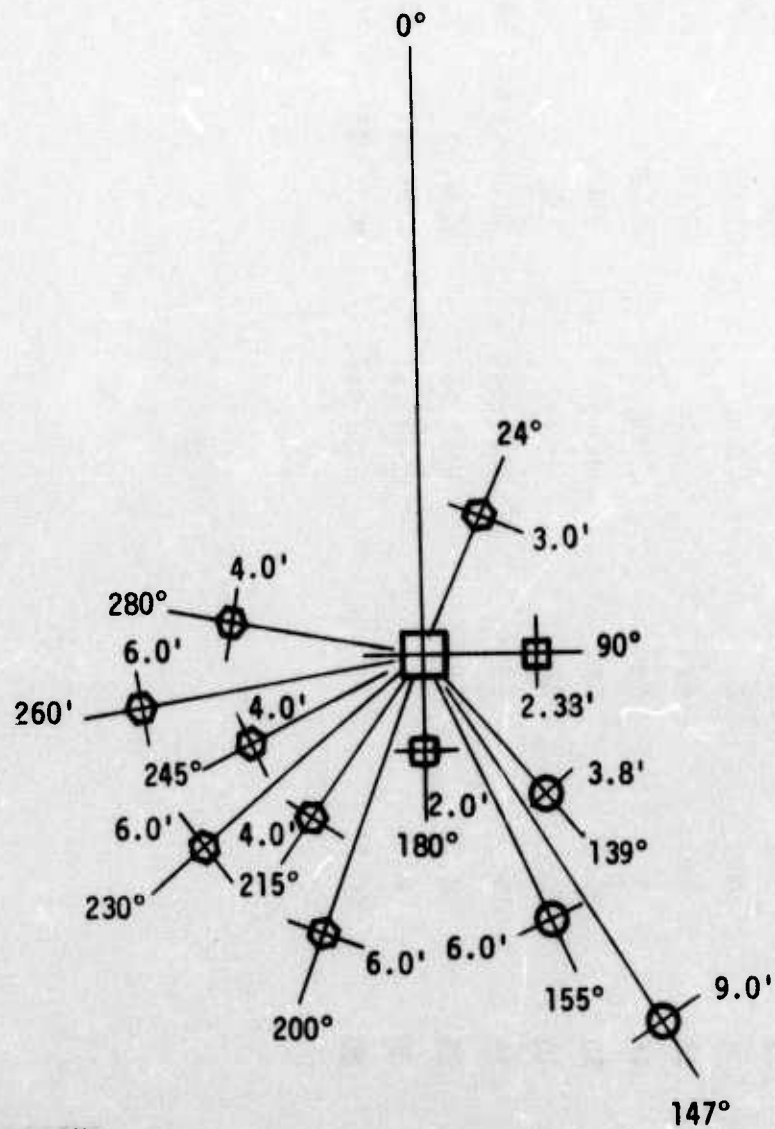

Figure P-15. SCAL III Instrumentation Layout



LEGEND

- AN/GEL Charge
- ⬡ SE Gage
- Accelerometer
- ◻ GRT Gage

Figure P-16. SCAL IV Instrumentation Layout

Table P-31. Measurement List for SCAL I

<u>Measurement Number</u>	<u>Br</u>	<u>Depth (feet)</u>	<u>Azimuth (degrees)</u>	<u>Range (feet)</u>	<u>Measurement Type</u>	<u>Predicted Level</u>	<u>Xducer Nominal Range</u>	<u>Xducer Serial Number</u>
001	F	3.0	56	4.0	AV	3000g	5000g	AD49
002	F	3.0	56	4.0	AH	4000g	10000g	AB97
003	F	3.0	45	7.0	AV	500g	5000g	AG47
004	F	3.0	45	7.0	AH	700g	5000g	AG50
005	F	3.0	10	20.25	AV	100g	250g	AC77
006	F	3.0	10	20.25	AH	150g	250g	AE41
007	X	3.0	15	15.25	FS	4000 psi	500 psi	144
008	X	3.0	25	11.33	FS	1000 psi	4000 psi	233
009	X	3.0	30	8.33	FS	2000 psi	4000 psi	215
010	X	3.0	20	20.25	FS	300 psi	4000 psi	181

Table P-32. Measurement Recording List - SCAL I

Measure Number	Measurement Designation	Recorder	Track	VCO	Cal. Level Actual (EU)	% Bandedge @ Cal. Level	Notes
001	HP-I SCAL I-F-E-3-56-4.0-A-V	1	3	1	2988.8g	50	1,3
001A	HP-I SCAL I-F-E-3-56-4.0-A-V	1	5	1	2988.8g	50	2,4
001B	HP-I SCAL I-F-E-3-56-4.0-V-V	1	5	3	1.0	50	7
002	HP-I SCAL I-F-E-3-56-4.0-A-H	1	3	3	4045.7g	50	1,3
002A	HP-I SCAL I-F-E-3-56-4.0-A-H	1	5	5	4045.7g	50	2,4
002B	HP-I SCAL I-F-E-3-56-4.0-V-H	1	5	7	1.0	50	7
003	HP-I SCAL I-F-E-3-45-7.0-A-V	1	3	5	508.5	50	1,3
003A	HP-I SCAL I-F-E-3-45-7.0-A-V	1	5	9	508.5	50	2,4
003B	HP-I SCAL I-F-E-3-45-7.0-V-V	1	6	1	1.0	50	7
004	HP-I SCAL I-F-E-3-45-7.0-A-H	1	3	7	695.1g	50	1,3
004A	HP-I SCAL I-F-E-3-45-7.0-A-H	1	6	3	695.1g	50	2,4
004B	HP-I SCAL I-F-E-3-45-7.0-V-H	1	6	5	1.0	50	7
005	HP-I SCAL I-F-E-3-10-20.25-A-V	1	3	9	100.3g	50	1,3
005A	HP-I SCAL I-F-E-3-10-20.25-A-V	1	6	7	100.3g	50	2,4
005B	HP-I SCAL I-F-E-3-10-20.25-V-V	1	6	9	1.0	50	7
006	HP-I SCAL I-F-E-3-10-20.25-A-H	1	4	1	147.8g	50	1,3
006A	HP-I SCAL I-F-E-3-10-20.25-A-H	1	9	1	147.8g	50	2,4
006B	HP-I SCAL I-F-E-3-10-20.25-V-H	1	9	3	1.0	50	7
007	HP-I SCAL I-F-E-3-15-15.25-FS	1	4	3	501.4 psi	50	1,3
007A	HP-I SCAL I-F-E-3-15-15.25-FS	1	9	5	501.4 psi	25	1,3,6
007B	HP-I SCAL I-F-E-3-15-15.25-FS	2	2	-	501.4 psi	50	2,5
007C	HP-I SCAL I-F-E-3-15-15.25-FS	1	10	3	501.4 psi	50	2,4

Table P-32. Measurement Recording List - SCAL I (Continued)

Measure Number	Measurement Designation	Recorder	Track	VCO	Cal. Level Actual (EU)	% Bandedge @ Cal. Level	Notes
008	HP-I SCAL I-F-E-3-25-11.33-FS	1	4	5	967.5 psi	50	1,3
008A	HP-I SCAL I-F-E-3-25-11.33-FS	1	9	7	967.5 psi	25	1,3,6
008B	HP-I SCAL I-F-E-3-25-11.33-FS	2	4	-	967.5 psi	50	2,5
008C	HP-I SCAL I-F-E-3-25-11.33-FS	1	10	5	967.5 psi	50	2,4
009	HP-I SCAL I-F-E-3-30-8.33-FS	1	4	7	1991.2 psi	50	1,3
009A	HP-I SCAL I-F-E-3-30-8.33-FS	1	9	9	1991.2 psi	25	1,3,6
009B	HP-I SCAL I-F-E-3-30-8.33-FS	2	6	-	1991.2 psi	50	2,5
009C	HP-I SCAL I-F-E-3-30-8.33-FS	1	10	7	1991.2 psi	50	2,4
010	HP-I SCAL I-F-E-3-20-20.25-FS	1	4	9	308 psi	50	1,3
010A	HP-I SCAL I-F-E-3-20-20.25-FS	1	10	1	308 psi	25	1,3,6
010B	HP-I SCAL I-F-E-3-20-20.25-FS	2	8	-	308 psi	50	2,5
010C	HP-I SCAL I-F-E-3-20-20.25-FS	1	10	9	308 psi	50	2,4

NOTES:

1. Low Level - Signal not amplified prior to transmission over long lines.
2. High Level - Signal amplified at the splice bunker.
3. Low Frequency - Signal recorded on a channel where the 3 db point is at 2.5 - 3 KHz.
4. Medium Frequency - Signal recorded on a channel where the 3 db point is approximately 8 KHz.
5. High Frequency - Signal recorded on a channel where the 3 db point is above 15 KHz.
6. Low Gain - Signal recorded such that the calibration level produces a VCO deviation of 25% of maximum deviation available.
7. Electronic integration of acceleration signal.

Table P-33. Record Assignment Table - SCAL I

Van 3 - Recorder 1

Mini-Van

T R K	VCO (Note)									Recorder 2 CP 100
	1	3	5	7	9					
1										
2										007B
3	001	002	003	004	005					
4	006	007	008	009	010					008B
5	001A	001B	002A	002B	003A					
6	003B	004A	004B	005A	005B					009B
7	IRIG B	FIDU	IRIG A							
8	IRIG B	FIDU	IRIG A							010B
9	006A	006B	007A	008A	009A					
10	010A	007C	008C	009C	010C					FIDU
11										
12										IRIG B
13										
14										

NOTE: 1. 10 kHz Data bandwidth

Table P-34. Measurement List for SCAL II

<u>Measurement Number</u>	<u>Br</u>	<u>Depth (feet)</u>	<u>Azimuth (degrees)</u>	<u>Range (feet)</u>	<u>Measurement Type</u>	<u>Predicted Level</u>	<u>Xducer Nominal Range</u>	<u>Xducer Serial Number</u>
001	F	3.0	0	3.9	AV	3000g	5000g	AF13
002	F	3.0	0	3.9	AH	4000g	10000g	AH01
003	F	3.0	3	7.3	AV	500g	5000g	AF63
004	F	3.0	3	7.3	AH	700g	5000g	AF77
005	F	3.0	6	20.25	AV	100g	250g	AA97
006	F	3.0	6	20.25	AH	150g	250g	AE08
007	A	3.0	36	2.5	FS	10000 psi	75000g	GRT/AQ201
008	A	3.0	72	3.6	FS	4000 psi	75000g	GRT/AQ212
009	A	2.7	108	3.3	FS	4000 psi	4000g	145
010	A	2.9	144	4.8	FS	2000 psi	4000g	161
011	A	2.8	180	6.3	FS	1000 psi	4000g	148

Table P-35. Measurement Recording List - SCAL II

Measure Number	Measurement Designation	Recorder	Track	VCO	Cal. Level Actual (EU)	% Bandedge @ Cal. Level	Notes
001	HP-I SCAL II-F-E-3.0-0-3.9-A-V	1	3	1	3079.79g	50	1,3
001A	HP-I SCAL II-F-E-3.0-0-3.9-A-V	1	5	1	3079.79g	50	2,4
001B	HP-I SCAL II-F-E-3.0-0-3.9-V-V	1	5	3	1.0	50	6
001C	HP-I SCAL II-F-E-3.0-0-3.9-A-V	2	3	-	3079.79g	50	2,5
002	HP-I SCAL II-F-E-3.0-0-3.9-A-H	1	3	3	3965.28g	50	1,3
002A	HP-I SCAL II-F-E-3.0-0-3.9-A-H	1	5	5	3965.28g	50	2,4
002B	HP-I SCAL II-F-E-3.0-0-3.9-V-H	1	5	7	1.0	50	6
002C	HP-I SCAL II-F-E-3.0-0-3.9-A-H	2	4	-	3965.28g	50	2,5
003	HP-I SCAL II-F-E-3.0-3-7.3-A-V	1	3	5	473.68g	50	1,3
003A	HP-I SCAL II-F-E-3.0-3-7.3-A-V	1	5	9	473.68g	50	2,4
003B	HP-I SCAL II-F-E-3.0-3-7.3-V-V	1	6	1	1.0	50	6
003C	HP-I SCAL II-F-E-3.0-3-7.3-A-V	2	5	-	473.68g	50	2,5
004	HP-I SCAL II-F-E-3.0-3-7.3-A-H	1	3	7	648.15g	50	1,3
004A	HP-I SCAL II-F-E-3.0-3-7.3-A-H	1	6	3	648.15g	50	2,4
004B	HP-I SCAL II-F-E-3.0-3-7.3-V-H	1	6	5	1.0	50	6
004C	HP-I SCAL II-F-E-3.0-3-7.3-A-H	2	6	-	648.15g	50	2,5
005	HP-I SCAL II-F-E-3.0-6-20.25-A-V	1	3	9	93.68g	50	1,3
005A	HP-I SCAL II-F-E-3.0-6-20.25-A-V	1	6	7	93.68g	50	2,4
005B	HP-I SCAL II-F-E-3.0-6-20.25-V-V	1	6	9	1.0	50	6
006	HP-I SCAL II-F-E-3.0-6-20.25-A-H	1	4	1	141.56g	50	1,3
006A	HP-I SCAL II-F-E-3.0-6-20.25-A-H	1	9	1	141.56g	50	2,4
006B	HP-I SCAL II-F-E-3.0-6-20.25-V-H	1	9	3	1.0	50	6
007A	HP-I SCAL II-F-E-3.0-36-2.5-FS	2	1	-	42,000 psi	100	2

Table P-35. Measurement Recording List - SCAL II (Continued)

Measure Number	Measurement Designation	Recorder	Track	VCO	Cal. Level Actual (EU)	% Bandedge @ Cal. Level	Notes
008A	HP-I SCAL II-F-E-3.0-72-3.6-FS	2	2	-	16,000 psi	100	2
009	HP-I SCAL II-F-E-2.7-108-3.3-FS	1	4	7	16,025.75 psi	50	1,3
009A	HP-I SCAL II-F-E-2.7-108-3.3-FS	2	11	-	16,025.75 psi	50	2,4
010	HP-I SCAL II-F-E-2.9-144-4.8-FS	1	4	9	5,281.93 psi	50	1,3
010A	HP-I SCAL II-F-E-2.9-144-4.8-FS	2	12	-	5,281.93 psi	50	2,4
011	HP-I SCAL II-F-E-2.8-180-6.33-FS	1	4	3	2,151.01 psi	50	1,3
011A	HP-I SCAL II-F-E-2.8-180-6.33-FS	2	13	-	2,151.01 psi	50	2,4

NOTES:

1. Low Level - Signal not amplified prior to transmission over long lines.
2. High Level - Signal amplified at the splice bunker.
3. Low Frequency - Signal recorded on a channel where the 3 db point is at 2.5 - 3 KHz.
4. Medium Frequency - Signal recorded on a channel where the 3 db point is approximately 8 KHz.
5. High Frequency - Signal recorded on a channel where the 3 db point is above 15 KHz.
6. Electronic integration of acceleration signal.

Table P-36. Record Assignment Table - SCAL II

Van 3 - Recorder 1

Mini-Van

T R K	VCO (Note)									Recorder 2 CP 100
	1	3	5	7	9					
1										007A
2										008A
3	001	002	003	004	005					001C
4	006	011		009	010					002C
5	001A	001B	002A	002B	003A					003C
6	003B	004A	004B	005A	005B					004C
7	IRIG B	FIDU	IRIG A							
8	IRIG B	FIDU	IRIG A							FIDU
9	006A	006B								IRIG B
10										IRIG B
11										009A
12										010A
13										011A
14										

NOTE: 1. 10 kHz Data bandwidth

Table P-37. Measurement List for SCAL III

Measurement Number	Br	Depth (feet)	Azimuth (degrees)	Range (feet)	Measurement Type	Predicted Level	Xducer Nominal Range	Xducer Serial Number
001	F	2.76	21	7.39	FS	900 psi	4000 psi	115
002	F	2.96	29	7.29	FS	900 psi	4000 psi	117
003	F	3.0	67	7.27	FS	900 psi	4000 psi	199
004	F	3.06	330	9.14	FS	400 psi	4000 psi	123
005	F	3.11	336	9.16	FS	400 psi	4000 psi	136
006	F	3.08	9	9.11	FS	400 psi	4000 psi	143
007	F	3.0	37	7.34	FS	900 psi	4000 psi	176
008	F	3.0	53	7.41	FS	900 psi	3000 psi	221
009	F	3.0	61	7.27	FS	900 psi	4000 psi	150
010	F	3.0	342	9.11	FS	400 psi	4000 psi	151
011	F	3.0	354	9.15	FS	400 psi	4000 psi	122
012	F	3.0	0	9.13	FS	400 psi	4000 psi	234
013	F	3.30	272	5.85	FS	1800 psi	4000 psi	168
014	F	3.07	288	6.05	FS	1800 psi	4000 psi	171
015	F	3.37	302	5.78	FS	1800 psi	4000 psi	175
016	F	3.0	95	9.17	FS	400 psi	4000 psi	172
017	F	3.10	112	9	FS	400 psi	4000 psi	184
018	F	3.25	126	8.84	FS	400 psi	4000 psi	197
019	F	3.0	158	9	FS	400 psi	3000 psi	140

Table P-37. Measurement List for SCAL III (Continued)

<u>Measurement Number</u>	<u>Br</u>	<u>Depth (feet)</u>	<u>Azimuth (degrees)</u>	<u>Range (feet)</u>	<u>Measurement Type</u>	<u>Predicted Level</u>	<u>Xducer Nominal Range</u>	<u>Xducer Serial Number</u>
020	A	2.875	71	3.8	FS	10000 psi	75000 psi	GRT/AQ213
021	A	2.73	92	5.5	FS	4000 psi	75000 psi	GRT/AQ200
023	A	3.08	81	7.96	FS	500 psi	4000 psi	209
025	F	13.3	139	3.8	AV	270g	500g	AE47
026	F	13.3	139	3.8	AH	75g	250g	AE30
027	F	3.0	139	3.8	AH	4000g	10000g	AD62
028	F	13.3	155	7.0	AV	180g	500g	AE40
029	F	13.3	155	7.0	AH	110g	250g	AE20
030	F	3.0	155	6.0	AH	1000g	5000g	AF11
031	F	13.3	147	20.0	AV	57g	250g	AD61
032	F	13.3	147	20.0	AH	75g	250g	AD81
033	F	3.0	147	9.0	AH	200g	250g	AA82
034	F	3.03	190	5.84	FS	1800 psi	4000 psi	139
035	F	3.09	205	5.81	FS	1800 psi	4000 psi	174
036	F	3.29	210	8.55	FS	400 psi	4000 psi	203
037	F	3.38	220	8.88	FS	400 psi	4000 psi	219
038	F	0.0	300	500	SVT	.25g	.5g	
039	F	0.0	300	500	SHL	.25g	.5g	
040	F	0.0	300	500	SHT	.25g	.5g	
041	F	0.0	300	250	SVT	.50g	1.0g	

Table P-37. Measurement List for SCAL III (Continued)

<u>Measurement Number</u>	<u>Br</u>	<u>Depth (feet)</u>	<u>Azimuth (degrees)</u>	<u>Range (feet)</u>	<u>Measurement Type</u>	<u>Predicted Level</u>	<u>Xducer Nominal Range</u>	<u>Xducer Serial Number</u>
042	F	0.0	300	250	SHL	.50g	1.0g	
043	F	0.0	300	250	SHT	.50g	1.0g	
044	F	0.0	300	100	SVT	2.5 g	5.0g	
045	F	0.0	300	100	SHL	2.5 g	5.0g	
046	F	0.0	300	100	SHT	2.5 g	5.0g	

Table P-38. Measurement Recording List - SCAL III

Measure Number	Measurement Designation	Recorder	Track	VCO	Cal. Level Actual (EU)	% Bandedge @ Cal. Level	Notes
001	HP-I SCAL III-F-E-2.76-21-7.39-FS	1	3	1	899.15	50	1,3
001A	HP-I SCAL III-F-E-2.76-21-7.39-FS	2	3	-	899.15	50	2,5
002	HP-I SCAL III-F-E-2.96-29-7.29-FS	1	3	3	910.07	50	1,3
002A	HP-I SCAL III-F-E-2.96-29-7.29-FS	2	4	-	910.07	50	2,5
003	HP-I SCAL III-F-E-3.0-67-7.27-FS	1	3	5	900.45	50	1,3
003A	HP-I SCAL III-F-E-3.0-67-7.27-FS	2	5	-	900.45	50	2,5
004	HP-I SCAL III-F-E-3.06-330-9.14-FS	1	3	7	398.51	50	1,3
004A	HP-I SCAL III-F-E-3.06-330-9.14-FS	2	6	-	398.51	50	2,5
005	HP-I SCAL III-F-E-3.11-336-9.16-FS	1	3	9	401.60	50	1,3
005A	HP-I SCAL III-F-E-3.11-336-9.16-FS	2	7	-	401.60	50	2,5
006	HP-I SCAL III-F-E-3.08-9-9.11-FS	1	3	11	399.01	50	1,3
006A	HP-I SCAL III-F-E-3.08-9-9.11-FS	2	8	-	399.01	50	2,5
007	HP-I SCAL III-F-E-3.0-37-7.34-FS	1	3	13	910.08	50	1,3
007A	HP-I SCAL III-F-E-3.0-37-7.34-FS	2	9	-	910.08	50	2,5
008	HP-I SCAL III-F-E-3.0-53-7.41-FS	1	3	15	891.48	50	1,3
008A	HP-I SCAL III-F-E-3.0-53-7.41-FS	2	10	-	891.48	50	2,5
009	HP-I SCAL III-F-E-3.0-61-7.27-FS	1	3	17	908.31	50	1,3
009A	HP-I SCAL III-F-E-3.0-61-7.27-FS	2	11	-	908.31	50	2,5
010	HP-I SCAL III-F-E-3.0-342-9.11-FS	1	4	1	408.37	50	1,3
010A	HP-I SCAL III-F-E-3.0-342-9.11-FS	1	11	11	408.37	50	2,5
011	HP-I SCAL III-F-E-3.0-354-9.15-FS	1	4	3	413.10	50	1,3
011A	HP-I SCAL III-F-E-3.0-354-9.15-FS	1	11	13	413.10	50	2,5
012	HP-I SCAL III-F-E-3.0-0-9.13-FS	1	4	5	394.16	50	1,3
012A	HP-I SCAL III-F-E-3.0-0-9.13-FS	2	12	-	394.16	50	2,5

Table P-38. Measurement Recording List - SCAL III (Continued)

Measure Number	Measurement Designation	Recorder	Track	VCO	Cal. Level Actual (EU)	% Bandedge @ Cal. Level	Notes
013	HP-I SCAL III-F-E-3.3-272-5.85-FS	1	4	7	1812.22	50	1,3
013A	HP-I SCAL III-F-E-3.3-272-5.85-FS	3	1	-	1812.22	50	2,5
014	HP-I SCAL III-F-E-3.07-288-6.05-FS	1	4	9	1835.05	50	1,3
014A	HP-I SCAL III-F-E-3.07-288-6.05-FS	3	2	-	1835.05	50	2,5
015	HP-I SCAL III-F-E-3.37-302-5.78-FS	1	4	11	1742.39	40	1,3
015A	HP-I SCAL III-F-E-3.37-302-5.78-FS	3	3	-	1742.39	50	2,5
015B	HP-I SCAL III-F-E-3.37-302-5.78-FS	1	5	3	1742.39	80	1,3,6
016	HP-I SCAL III-F-E-3.0-95-9.17-FS	1	4	13	385.02	40	1,3
016A	HP-I SCAL III-F-E-3.0-95-9.17-FS	3	4	-	385.02	50	2,5
016B	HP-I SCAL III-F-E-3.0-95-9.17-FS	1	5	7	385.02	80	1,3,6
017	HP-I SCAL III-F-E-3.10-112-9.0-FS	1	4	15	402.04	50	1,3
017A	HP-I SCAL III-F-E-3.10-112-9.0-FS	3	5	-	402.04	50	2,5
018	HP-I SCAL III-F-E-3.25-126-8.84-FS	1	4	17	391.84	50	1,3
018A	HP-I SCAL III-F-E-3.25-126-8.84-FS	3	6	-	391.84	50	2,5
019	HP-I SCAL III-F-E-3.0-158-9.0-FS	1	5	1	380.54	50	1,3
019A	HP-I SCAL III-F-E-3.0-158-9.0-FS	3	7	-	380.54	50	2,5
020A	HP-I SCAL III-F-E-2.87-71-3.8-FS	2	1	-	8000	50	5
021A	HP-I SCAL III-F-E-2.73-92-5.5-FS	2	2	-	1800	50	5
023	HP-I SCAL III-F-E-3.08-81-7.96-FS	1	5	5	507.45	50	1,3
023A	HP-I SCAL III-F-E-3.08-81-7.96-FS	3	8	-	507.45	50	2,5
025	HP-I SCAL III-F-E-13.3-139-3.8-A-V	1	5	9	269.62	30	1,3
025A	HP-I SCAL III-F-E-13.3-139-3.8-A-V	1	9	1	269.62	30	2,4
025B	HP-I SCAL III-F-E-13.3-139-3.8-V-V	1	9	3	1.0	30	7

Table P-38. Measurement Recording List - SCAL III (Continued)

Measure Number	Measurement Designation	Recorder	Track	VCO	Cal. Level Actual (EU)	% Bandedge @ Cal. Level	Notes
026	HP-I SCAL III-F-E-13.3-139-3.8-A-H	1	5	11	74.71	30	1,3
026A	HP-I SCAL III-F-E-13.3-139-3.8-A-H	1	9	5	74.71	30	2,4
026B	HP-I SCAL III-F-E-13.3-139-3.8-V-H	1	9	7	1.0	30	7
027	HP-I SCAL III-F-E-3.0-139-3.8-A-H	1	5	13	4056.74	30	1,3
027A	HP-I SCAL III-F-E-3.0-139-3.8-A-H	1	9	9	4056.74	30	2,4
027B	HP-I SCAL III-F-E-3.0-139-3.8-V-H	1	9	11	1.0	30	7
028	HP-I SCAL III-F-E-13.3-155-7.0-A-V	1	5	15	180.90	30	1,3
028A	HP-I SCAL III-F-E-13.3-155-7.0-A-V	1	9	13	180.90	30	2,4
028B	HP-I SCAL III-F-E-13.3-155-7.0-V-V	1	9	15	1.0	30	7
029	HP-I SCAL III-F-E-13.3-155-7.0-A-H	1	5	17	111.08	30	1,3
029A	HP-I SCAL III-F-E-13.3-155-7.0-A-H	1	9	17	111.08	30	2,4
029B	HP-I SCAL III-F-E-13.3-155-7.0-V-H	1	10	1	1.0	30	7
030	HP-I SCAL III-F-E-3.0-155-6.0-A-H	1	6	1	1007.77	30	1,3
030A	HP-I SCAL III-F-E-3.0-155-6.0-A-H	1	10	3	1007.77	30	2,4
030B	HP-I SCAL III-F-E-3.0-155-6.0-V-H	1	10	5	1.0	30	7
031	HP-I SCAL III-F-E-13.3-147-20.0-A-V	1	6	3	56.76	30	1,3
031A	HP-I SCAL III-F-E-13.3-147-20.0-A-V	1	10	7	56.76	30	2,4
031B	HP-I SCAL III-F-E-13.3-147-20.0-V-V	1	10	9	1.0	30	7
032	HP-I SCAL III-F-E-13.3-147-20.0-A-H	1	6	5	73.87	30	1,3
032A	HP-I SCAL III-F-E-13.3-147-20.0-A-H	1	10	11	73.87	30	2,4
032B	HP-I SCAL III-F-E-13.3-147-20.0-V-H	1	10	13	1.0	30	7

Table P-38. Measurement Recording List - SCAL III (Continued)

Measure Number	Measurement Designation	Recorder	Track	VCO	Cal. Level Actual (EU)	% Bandedge @ Cal. Level	Notes
033	HP-I SCAL III-F-E-3.0-147-9-A-H	1	6	7	200.64	30	1,3
033A	HP-I SCAL III-F-E-3.0-147-9-A-H	1	10	15	200.64	30	2,4
033B	HP-I SCAL III-F-E-3.0-147-9-V-H	1	10	17	1.0	30	7
034	HP-I SCAL III-F-E-3.03-190-5.84-FS	1	6	9	1811.94	40	1,3,8
034A	HP-I SCAL III-F-E-3.03-190-5.84-FS	3	9	-	1811.94	50	2,5,8
034B	HP-I SCAL III-F-E-3.03-190-5.84-FS	1	11	1	1811.94	80	1,3,6,8
035	HP-I SCAL III-F-E-3.09-205-5.81-FS	1	6	11	1783.15	40	1,3,9
035A	HP-I SCAL III-F-E-3.09-205-5.81-FS	3	10	-	1783.15	50	2,5,9
035B	HP-I SCAL III-F-E-3.09-205-5.81-FS	1	11	3	1783.15	80	1,3,6,9
036	HP-I SCAL III-F-E-3.29-210-8.55-FS	1	6	13	407.24	40	1,3,8
036A	HP-I SCAL III-F-E-3.29-210-8.55-FS	3	11	-	407.24	50	2,5,8
036B	HP-I SCAL III-F-E-3.29-210-8.55-FS	1	11	5	407.24	80	1,3,6,8
037	HP-I SCAL III-F-E-3.38-220-8.88-FS	1	6	15	396.26	40	1,3,9
037A	HP-I SCAL III-F-E-3.38-220-8.88-FS	3	12	-	396.26	50	2,5,9
037B	HP-I SCAL III-F-E-3.38-220-8.88-FS	1	11	7	396.26	80	1,3,6,9
038	HP-I SCAL III-F-E-0.0-300-500-SVT	1	12	1	.25g	50	3
039	HP-I SCAL III-F-E-0.0-300-500-SHL	1	12	3	.25g	50	3
040	HP-I SCAL III-F-E-0.0-300-500-SHT	1	12	5	.25g	50	3
041	HP-I SCAL III-F-E-0.0-300-250-SVT	1	12	7	.5g	50	3
042	HP-I SCAL III-F-E-0.0-300-250-SHL	1	12	9	.5g	50	3
043	HP-I SCAL III-F-E-0.0-300-250-SHT	1	12	11	.5g	50	3
044	HP-I SCAL III-F-E-0.0-300-100-SVT	1	12	13	2.5g	50	3

Table P-38. Measurement Recording List - SCAL III (Continued)

Measure Number	Measurement Designation	Recorder	Track	VCO	Cal. Level Actual (EU)	% Bandedge @ Cal. Level	Notes
045	HP-I SCAL III-F-E-0.0-300-100-SHL	1	12	15	2.5g	50	3
046	HP-I SCAL III-F-E-0.0-300-100-SHT	1	12	17	2.5g	50	3

NOTES:

1. Low Level - Signal not amplified prior to transmission over long lines.
2. High Level - Signal amplified at the splice bunker.
3. Low Frequency - Signal recorded on a channel where the 3 db point is at 2.5 - 3 KHz.
4. Medium Frequency - Signal recorded on a channel where the 3 db point is approximately 8 KHz.
5. High Frequency - Signal recorded on a channel where the 3 db point is above 15 KHz.
6. High Gain - Signal recorded such that the predicted level produces a VCO deviation of 80% of maximum deviation available.

7. Electronic Integration

8. 45° CW Orientation

9. 90° CW Orientation

Table P-39. Record Assignment Table - SCAL III

Van 3 - Recorder 1

Mini-Van

T R K	VCO (Note 1)													
	1	3	5	7	9	11	13	15	17					
1														
2														
3	001	002	003	004	005	006	007	008	009					
4	010	011	012	013	014	015	016	017	018					
5	019	015B	023	016B	025	026	027	028	029					
6	030	031	032	033	034	035	036	037						
7	IRIG B	FIDU	IRIG A											
8	IRIG B	FIDU	IRIG A											
9	025A	025B	026A	026B	027A	027B	028A	028B	029A					
10	029B	030A	030B	031A	031B	032A	032B	033A	033B					
11	034B	035B	036B	037B		010A	011A							
12	038	039	040	041	042	043	044	045	046					
13														
14														

T R K	Recorder 2	Recorder 3
1	CP 100	FR 1300
2	010A	013A
3	021A	014A
4	001A	015A
5	002A	016A
6	003A	017A
7	004A	018A
8	005A	019A
9	006A	023A
10	007A	034A
11	008A	035A
12	009A	036A
13	012A	037A
14	IRIG B	IRIG B
	Note 2	Note 2

- NOTES: 1. 10 kHz Data bandwidth
 2. IRIG B (VCO-192 kHz CF, ±8 kHz Dev.), FIDU (VCO-160 kHz CF, ±8 kHz Dev.),
 Voice (VCO-256 kHz CF, ±16 kHz Dev.)

Table P-40. Measurement List for SCAL IV

<u>Measurement Number</u>	<u>Br</u>	<u>Depth (feet)</u>	<u>Azimuth (degrees)</u>	<u>Range (feet)</u>	<u>Measurement Type</u>	<u>Predicted Level</u>	<u>Xducer Nominal Range</u>	<u>Xducer Serial Number</u>
001	F	15.0	139	3.8	AV	270g	500g	AA87
002	F	15.0	139	3.8	AH	75g	250g	AA60
003	F	3.0	139	3.8	AH	4000g	10000g	AB41
004	F	15.0	155	6.0	AV	180g	500g	AA52
005	F	15.0	155	6.0	AH	110g	250g	AB68
006	F	3.0	155	6.0	AH	1000g	5000g	AD70
007	F	15.0	147	9.0	AV	57g	250g	AA57
008	F	15.0	147	9.0	AH	75g	250g	AB09
009	F	3.0	147	9.0	AH	200g	250g	AC37
010	X	-3.9	0	0.0	AV	6000g	10000g	AG91
011	F	3.0	280	4.0	FS	1900 psi	4000 psi	127
012	F	3.25	215	4.0	FS	1900 psi	4000 psi	118
013	F	3.0	245	4.0	FS	1900 psi	4000 psi	226
014	F	3.25	200	6.0	FS	800 psi	4000 psi	121
015	F	3.25	230	6.0	FS	800 psi	4000 psi	125
016	F	3.25	260	6.0	FS	800 psi	4000 psi	126
017	A	3.0	180	2.0	FS	8000 psi	75000 psi	GRT/AQ211
018	A	3.0	90	2.33	FS	6000 psi	75000 psi	GRT/AQ214
019	A	3.0	24	3.0	FS	3500 psi	4000 psi	186
020	F	0.0	300	140	SVT	.25g		
021	F	0.0	300	140	SHL	.25g		
022	F	0.0	300	140	SHT	.25g		
023	F	0.0	300	75	SVT	.5 g		

Table P-40. Measurement List for SCAL IV (Continued)

<u>Measurement Number</u>	<u>Br</u>	<u>Depth (feet)</u>	<u>Azimuth (degrees)</u>	<u>Range (feet)</u>	<u>Measurement Type</u>	<u>Predicted Level</u>	<u>Xducer Nominal Range</u>	<u>Xducer Serial Number</u>
024	F	0.0	300	75	SHL	.5 g		
025	F	0.0	300	75	SHT	.5 g		
026	F	0.0	300	30	SVT	2.5 g		
027	F	0.0	300	30	SHL	2.5 g		
028	F	0.0	300	30	SHT	2.5 g		

Table P-41. Measurement Recording List - SCAL IV

Measure Number	Measurement Designation	Recorder	Track	VCO	Cal. Level Actual (EU)	% Bandedge @ Cal. Level	Notes
001	HP-I SCAL-IV-F-E-15.0-139-3.8-A-V	1	3	1	265.98g	50	1,2
002	HP-I SCAL-IV-F-E-15.0-139-3.8-A-H	1	3	3	77.03g	50	1,2
003	HP-I SCAL-IV-F-E-3.0-139-3.8-A-H	1	3	5	3994.41g	50	1,2
004	HP-I SCAL-IV-F-E-15.0-155-6.0-A-V	1	3	7	181.56g	50	1,2
005	HP-I SCAL-IV-F-E-15.0-155-6.0-A-H	1	3	9	108.32g	50	1,2
006	HP-I SCAL-IV-F-E-3.0-155-6.0-A-H	1	4	1	1006.47g	50	1,2
007	HP-I SCAL-IV-F-E-15.0-147-9.0-A-V	1	4	3	57.82g	50	1,2
008	HP-I SCAL-IV-F-E-15.0-147-9.0-A-H	1	4	5	75.59g	50	1,2
009	HP-I SCAL-IV-F-E-3.0-147-9.0-A-H	1	4	7	200.30g	50	1,2
010	HP-I SCAL-IV-F-E-(-3.9)-0-0.0-A-V	1	4	9	5980.89g	50	1,2
011	HP-I SCAL-IV-F-E-3.0-280-4.0-FS	1	5	1	1858.46 psi	50	1,2
011A	HP-I SCAL-IV-F-E-3.0-280-4.0-FS	2	3	-	1858.46 psi	50	3
012	HP-I SCAL-IV-F-E-3.25-215-4.0-FS	1	5	3	1927.14 psi	50	1,2
012A	HP-I SCAL-IV-F-E-3.25-215-4.0-FS	2	4	-	1927.14 psi	50	3
013	HP-I SCAL-IV-F-E-3.0-245-4.0-FS	1	5	5	1906.88 psi	50	1,2
013A	HP-I SCAL-IV-F-E-3.0-245-4.0-FS	2	5	-	1906.88 psi	50	3
014	HP-I SCAL-IV-F-E-3.25-200-6.0-FS	1	5	7	775.17 psi	50	1,2
014A	HP-I SCAL-IV-F-E-3.25-200-6.0-FS	2	6	-	775.17 psi	50	3
015	HP-I SCAL-IV-F-E-3.25-230-6.0-FS	1	5	9	796.32 psi	50	1,2
015A	HP-I SCAL-IV-F-E-3.25-230-6.0-FS	2	7	-	796.32 psi	50	3
016	HP-I SCAL-IV-F-E-3.25-260-6.0-FS	1	6	1	795.15 psi	50	1,2
016A	HP-I SCAL-IV-F-E-3.25-260-6.0-FS	2	8	-	795.15 psi	50	3

Table P-41. Measurement Recording List - SCAL IV (Continued)

Measure Number	Measurement Designation	Recorder	Track	VCO	Cal. Level Actual (EU)	% Bandedge @ Cal. Level	Notes
017	HP-I SCAL-IV-F-E-3.0-180-2.0-FS	2	1	-	8000.00 psi	50	3
018	HP-I SCAL-IV-F-E-3.0-90-2.33-FS	2	2	-	6000.00 psi	50	3
019	HP-I SCAL-IV-F-E-3.0-24-3.0-FS	1	6	3	3606.72 psi	50	1,2
019A	HP-I SCAL-IV-F-E-3.0-24-3.0-FS	2	9	-	3606.72 psi	50	1,2
020	HP-I SCAL-IV-F-E-0.0-300-140-SVT	1	9	1	.25g	50	1,2
021	HP-I SCAL-IV-F-E-0.0-300-140-SHL	1	9	3	.25g	50	1,2
022	HP-I SCAL-IV-F-E-0.0-300-140-SHT	1	9	5	.25g	50	1,2
023	HP-I SCAL-IV-F-E-0.0-300-75-SVT	1	9	7	.5g	50	1,2
024	HP-I SCAL-IV-F-E-0.0-300-75-SHL	1	9	9	.5g	50	1,2
025	HP-I SCAL-IV-F-E-0.0-300-75-SHT	1	9	11	.5g	50	1,2
026	HP-I SCAL-IV-F-E-0.0-300-30-SVT	1	9	13	2.5g	50	1,2
027	HP-I SCAL-IV-F-E-0.0-300-30-SHL	1	9	15	2.5g	50	1,2
028	HP-I SCAL-IV-F-E-0.0-300-30-SHT	1	9	17	2.5g	50	1,2

NOTES:

1. Low Level - Signal not amplified prior to transmission over long lines.
2. Low Frequency - Signal recorded on a channel where the 3 db point is at 2.5 - 3 KHz.
3. High Frequency - Signal recorded on a channel where the 3 db point is above 15 KHz.

Table P-42. Record Assignment Table - SCAL IV

Van 3 - Recorder 1

T R K	VCO (Note)													
	1	3	5	7	9	11	13	15	17					
1														
2														
3	001	002	003	004	005									
4	006	007	008	009	010									
5	011	012	013	014	015									
6	016	019												
7	IRIG B	FIDU	IRIG A											
8	IRIG B	FIDU	IRIG A											
9	020	021	022	023	024	025	026	027	028					
10														
11														
12														
13														
14														

Mini-Van

T R K	Recorder 2 CP 100
1	017
2	018
3	011A
4	012A
5	013A
6	014A
7	015A
8	016A
9	019A
10	FIDU
11	FIDU
12	IRIG B
13	IRIG B
14	Voice

NOTE: 1. 10 kHz Data bandwidth

PART 4

HARD PAN ICAL EVENTS

1. DESCRIPTION OF TESTS

The ICAL series of events is a set of four tests involving the detonation of nine buried charges in simulation of a portion of a BLEST array. The objectives of the tests are to (1) evaluate the empirical impulse prediction procedures for the HARD PAN I site and (2) to verify the impulse simulation for the major areas of the HARD PAN I-3 impulse design.

In each of the test events the ammonium nitrate slurry charges were buried to a depth (center of charge) of 3.0 ft below the existing grade. The area containing the charges, and to a distance of 15 ft beyond, was overlaid with surcharge to a depth sufficient to take the total depth of burial to that listed in table P-43.

Table P-43. ICAL Event Parameters

<u>Event</u>	Spacing (ft)	Depth (ft)	Charge Size (lb)	Impulse (psi-sec)
ICAL I	5	6.75	50	19.2
ICAL II	10	6.75	50	7.8
ICAL III	7	6.75	50	12.5
ICAL IV	7	8.4	100	21.4

All four of the tests were heavily instrumented to obtain motion and soil stress measurements. In addition, on two of the events (ICAL III and IV) small cylindrical test structures were emplaced. These structures were instrumented to yield soil medium interaction data. These structures and their placements are described elsewhere.*

In order to determine the efficacy of backfill techniques, 3 of the

*Memorandum for the Record, Subject: 2X3 Cylindrical Test Structures for Use in ICAL and HBL Events, P. J. McNickle, 7 March 1975 (AFWL/DEV).

ICAL events (ICAL I, II and III) included backfill experiments. Figure P-17 shows a cross section of the 6 ft deep backfill hole with soil stress gage placement.

2. INSTRUMENTATION

a. Transducer Location

Figures P-18 through P-25 present plan and elevation views for each of the four ICAL events. Instrumentation holes are identified by a double digit number preceded by the letter L. Transducer locations are shown in these figures together with the corresponding measurement numbers.

b. Measurement Lists

Tables P-44 through P-47 are the measurement lists for the ICAL events and list transducer locations, type of measurements, predicted levels, and other pertinent data.

c. Measurement Recording

Van E-9 was used for recording and signal conditions of all measurement signals. All signals were recorded at 60 inches per second. At that tape speed the bandwidth capability was 20 KHz. Tables P-48 through P-51 present the measurement recording data.

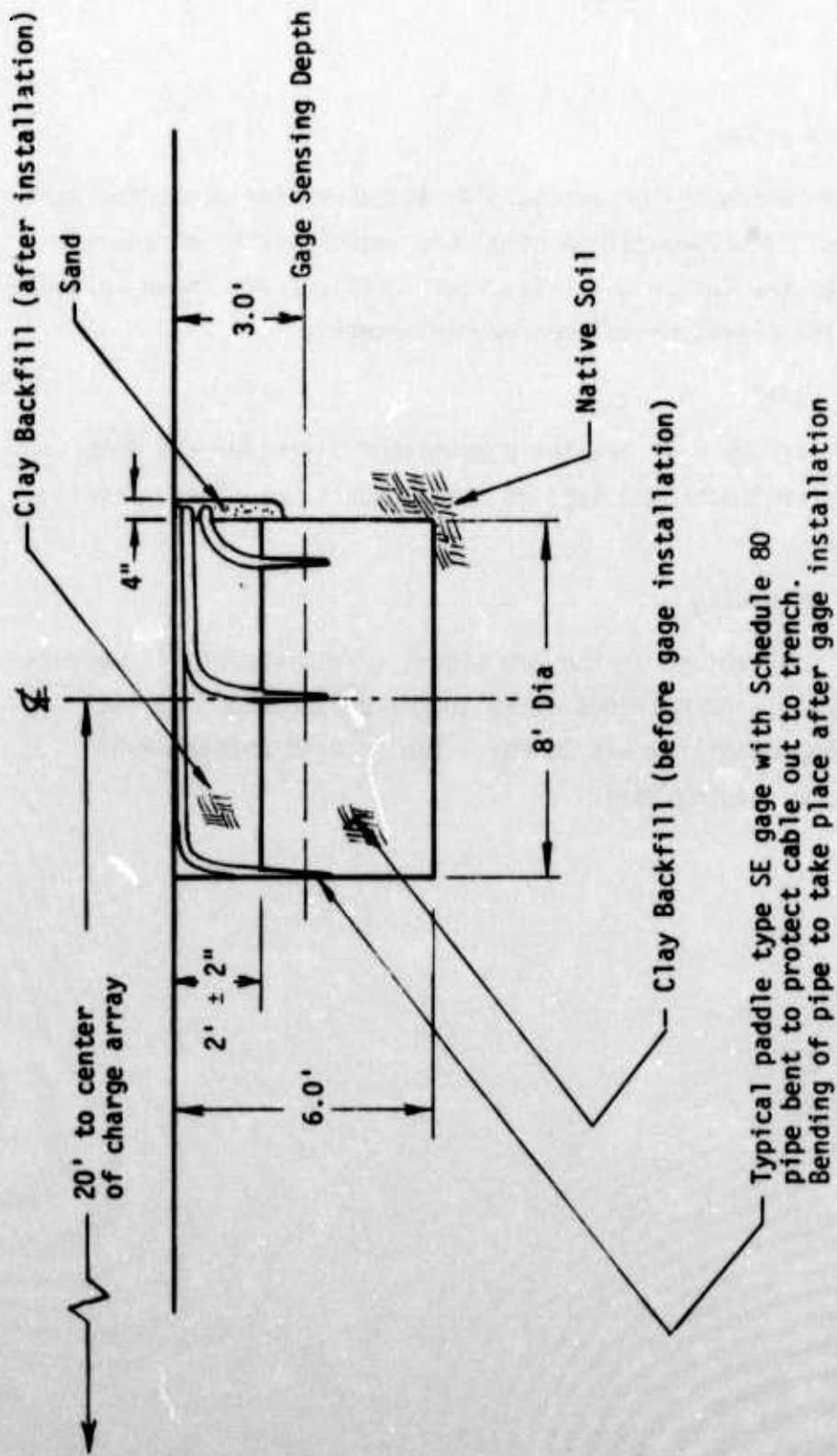

Figure P-17. ICAL Backfill Experiment

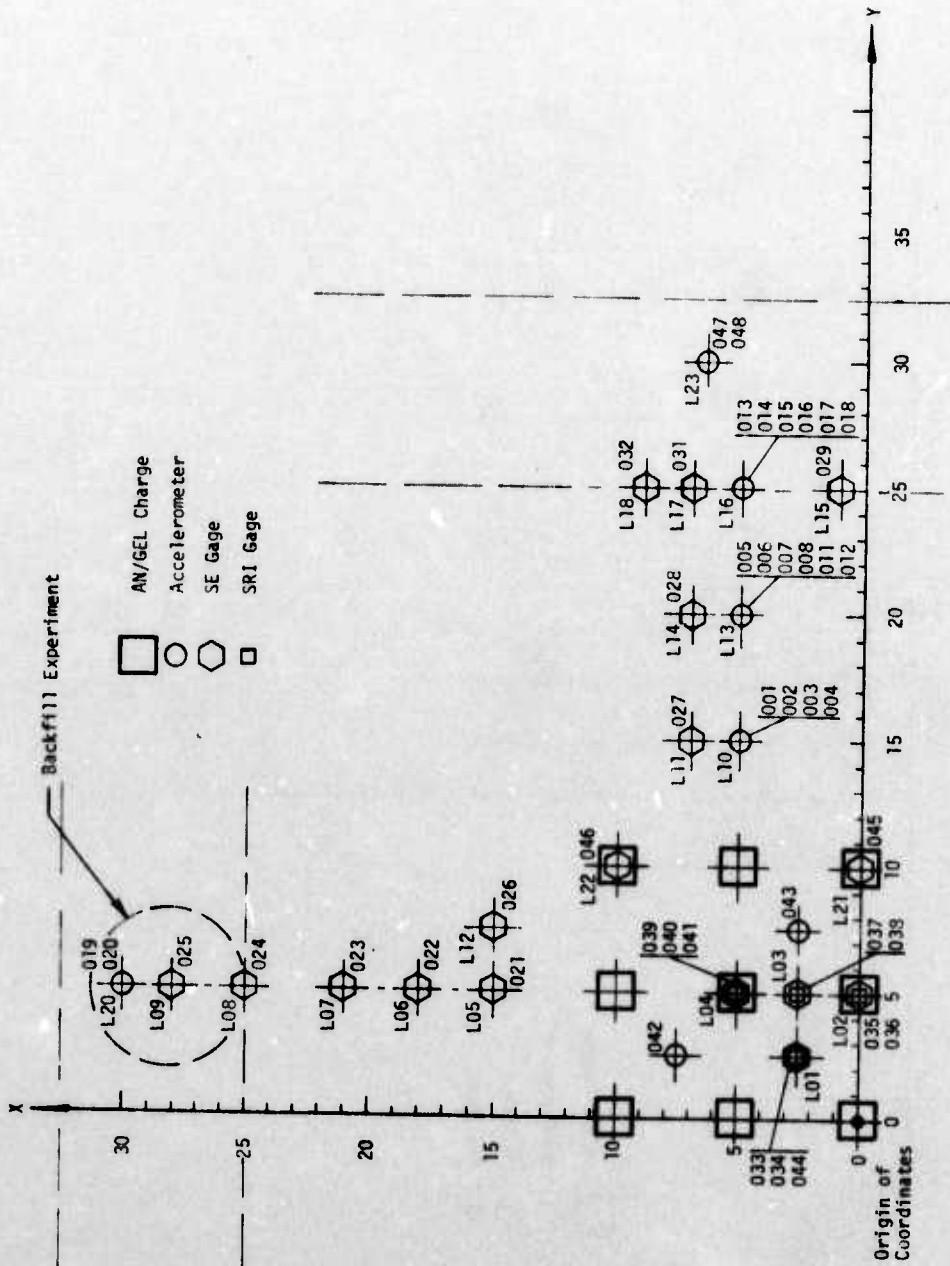

Figure P-18. Plan View of ICAL I Site

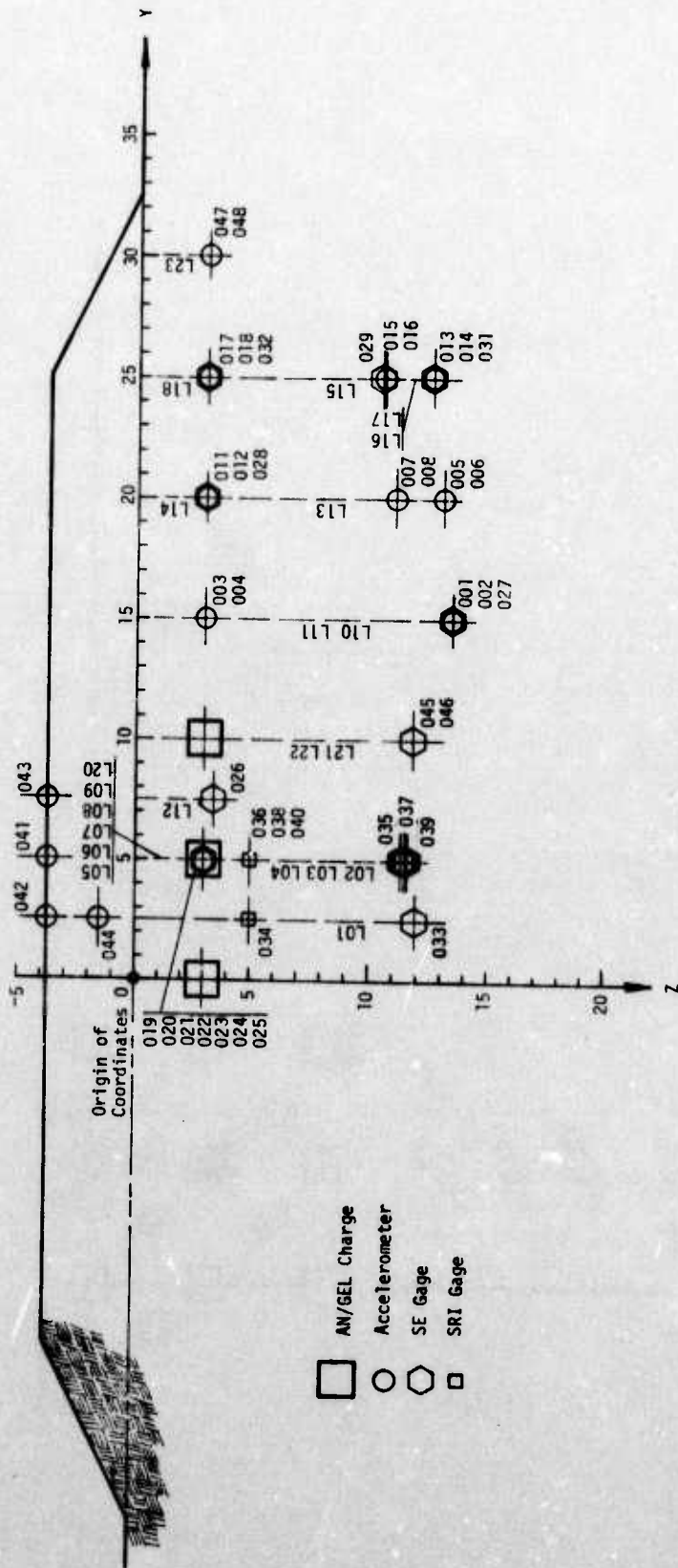

Figure P-19. Elevation View of ICAL I Site

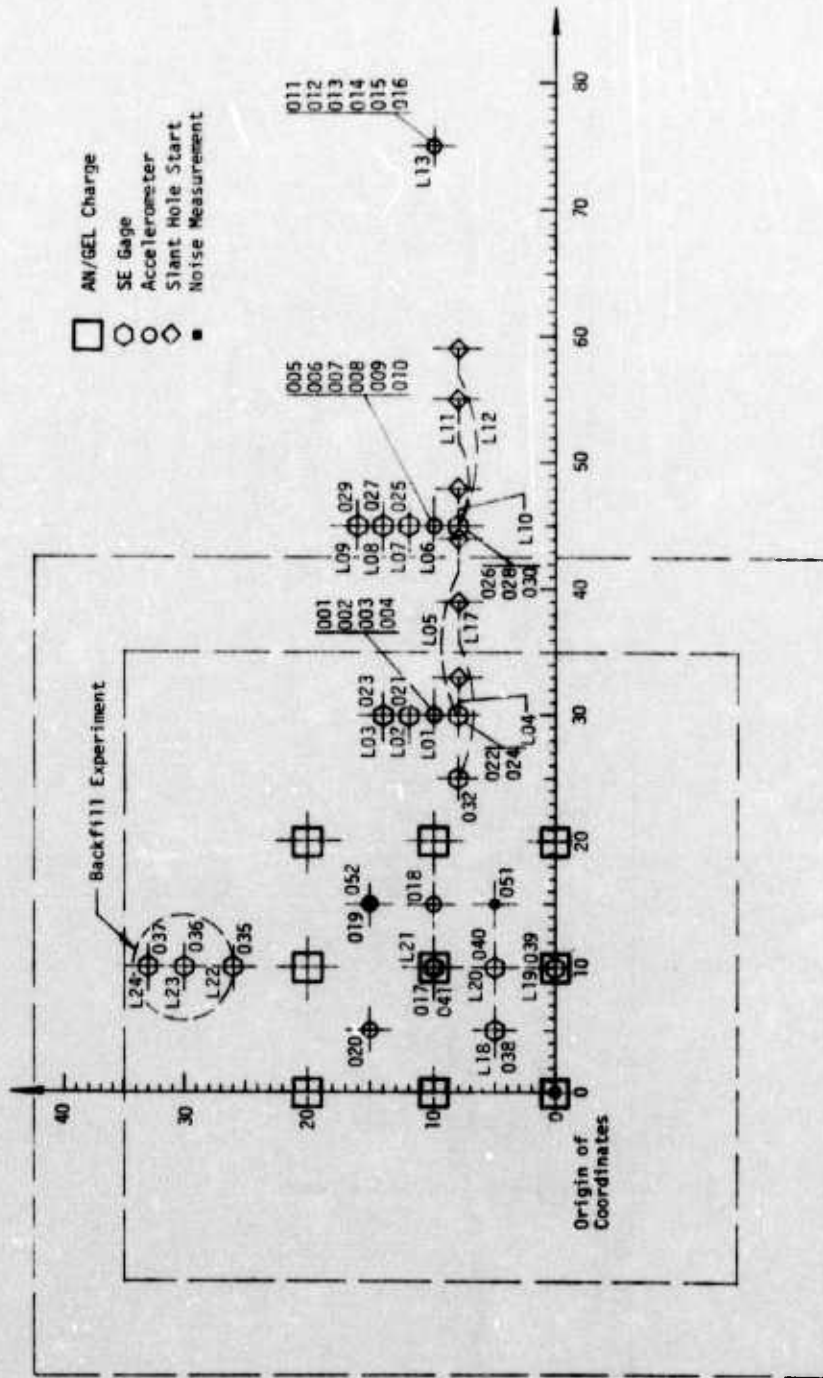

Figure P-20. Plan View of ICAL II Site

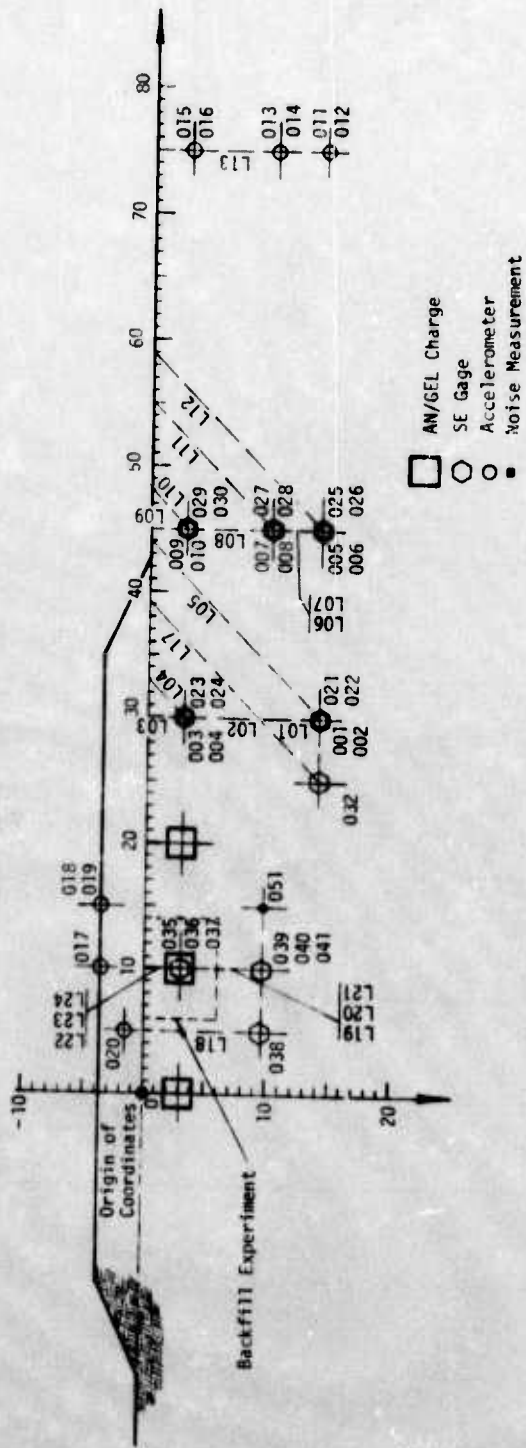
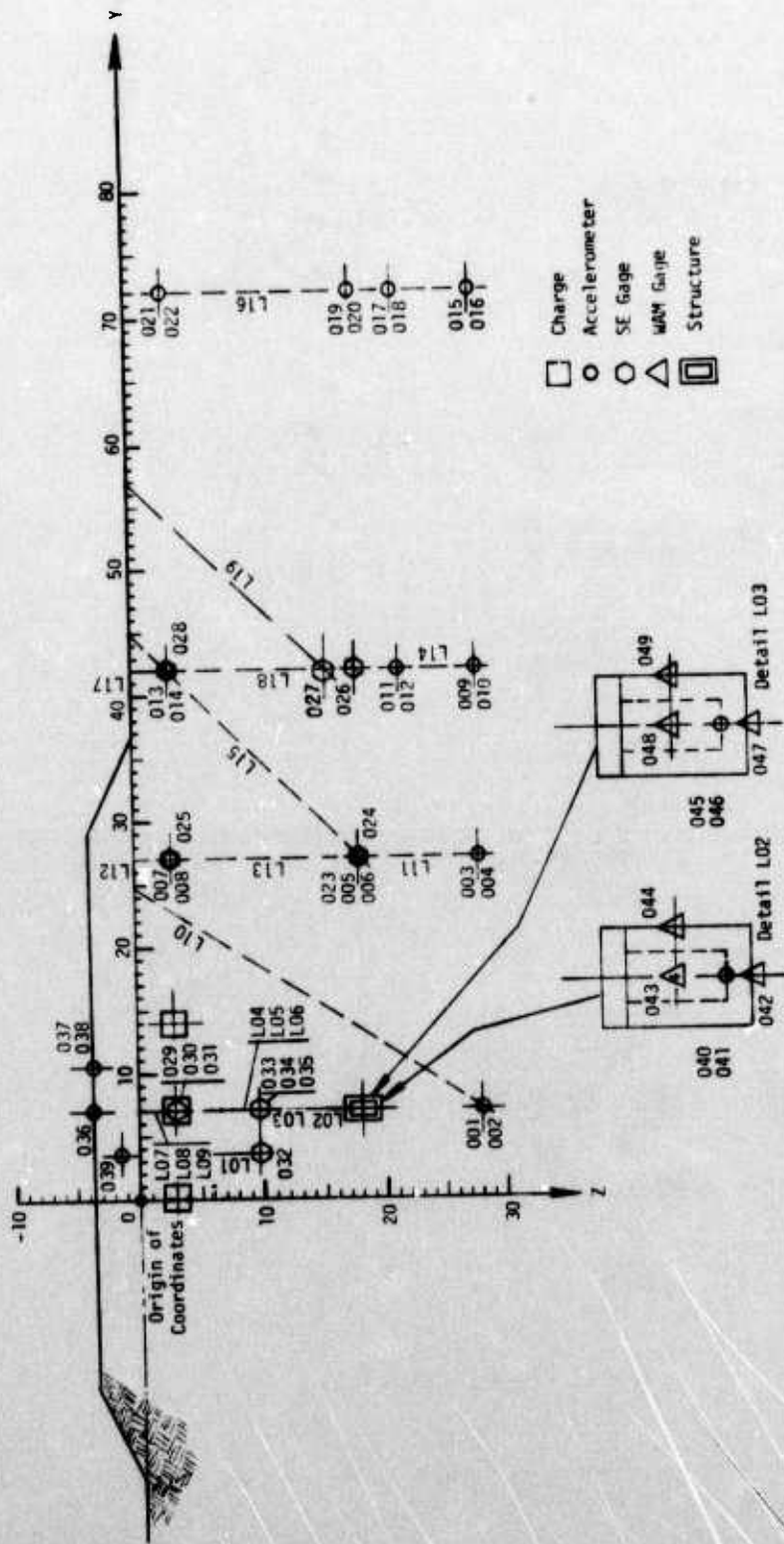

Figure P-21. Elevation View of ICAL II Site



- Charge
- Accelerometer
- SE Gage
- △ W/M Gage
- Structure

Figure P-23. Elevation View of ICAL III Test Site

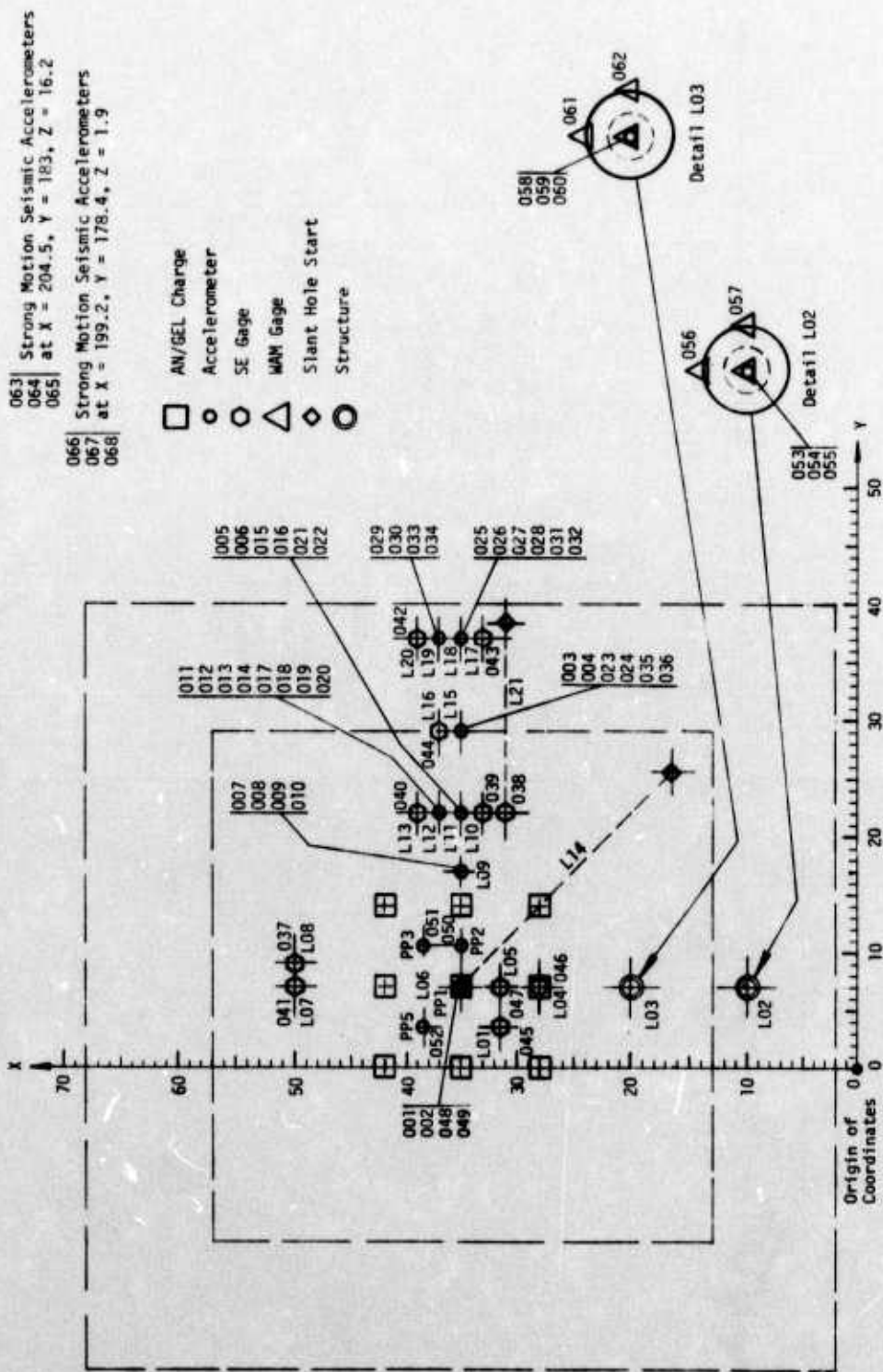

Figure P-24. Plan View of ICAL IV Site

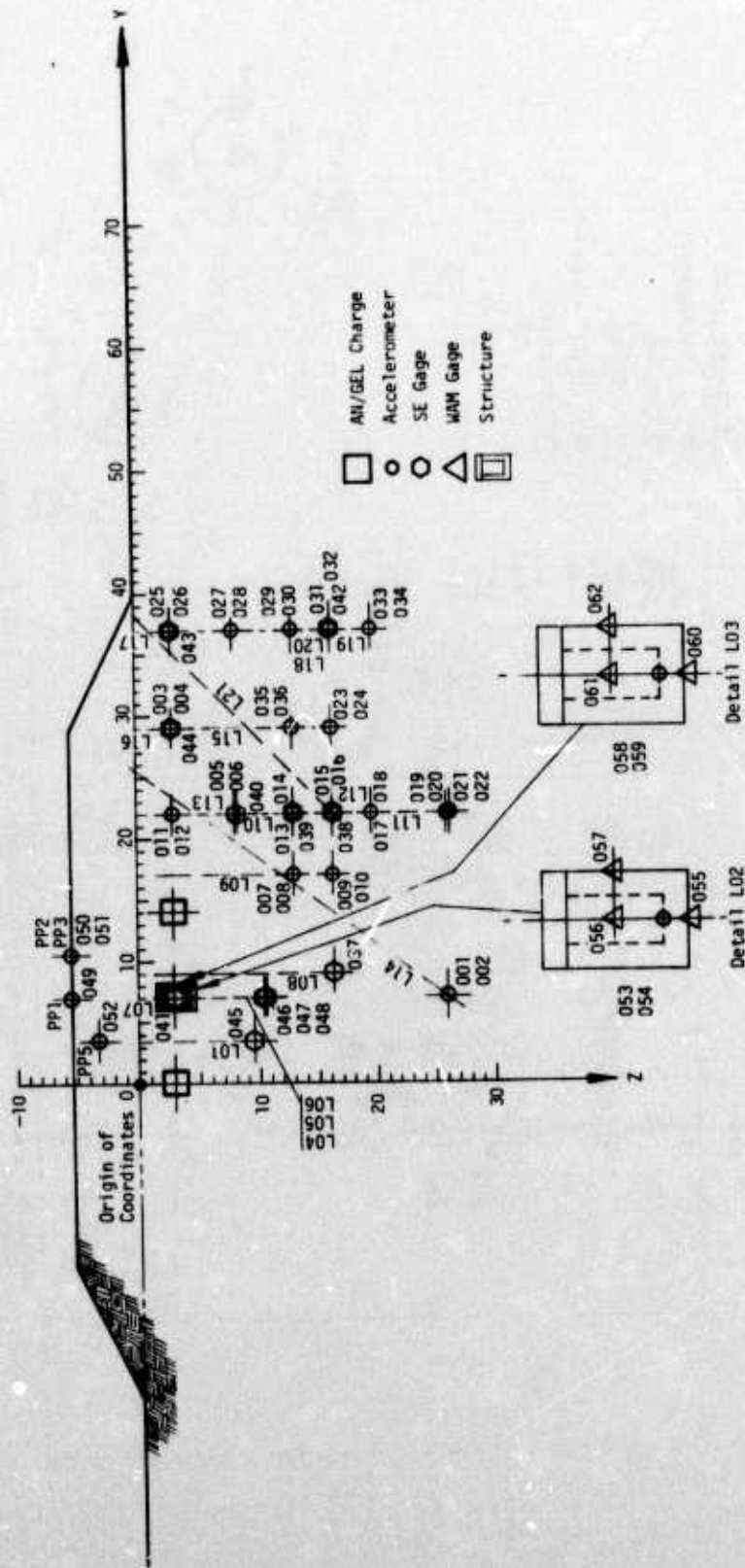

Figure P-25. Elevation View of ICAL IV Site

Table P-44. Measurement List for ICAL I

Measurement Number	Hole Number	Location		Depth Z (ft)	Measure. Type	Predicted Level	Xducer Nominal Range	Xducer Model	Xducer Serial Number
		X (ft)	Y (ft)						
001	L10	5	15	13.4	AV	4500g	10000g	2261C	AJ23
002	L10	5	15	13.4	AH	4000g	10000g	2261C	AH78
003	L10	5	15	3	AV	7000g	10000g	2261C	AK31
004	L10	5	15	3	AH	9000g	10000g	2261C	AG24
005	L13	5	20	13.0	AV	1300g	5000g	2264A	AG42
006	L13	5	20	13.0	AH	1500g	5000g	2264A	AG56
007	L13	5	20	11.0	AV	2400g	5000g	2264A	AG61
008	L13	5	20	11.0	AH	4400g	10000g	2261C	AA07
011	L13	5	20	3	AV	3000g	5000g	2264A	AH59
012	L13	5	20	3	AH	6000g	10000g	2261C	AA55
013	L16	5	25	12.5	AV	100g	500g	2260C	AE03
014	L16	5	25	12.5	AH	200g	500g	2260C	AD92
015	L16	5	25	10.5	AV	100g	500g	2260C	AB92
016	L16	5	25	10.5	AH	200g	500g	2260C	AB58
017	L16	5	25	3	AV	200g	500g	2260C	AB53
018	L16	5	25	3	AH	200g	500g	2260C	AA94
019	L20	30	5	3	AH	500g	5000g	2264A	AG13*
020	L20	30	5	3	AH	500g	5000g	2264A	AG49
021	L05	15	5	3	FS-H	1700 psi	4000 psi	SE	199
022	L06	18	5	3	FS-H	400 psi	2000 psi	SE	205
023	L07	21	5	3	FS-H	500 psi	2000 psi	SE	281
024	L08	25	5	3	FS-H	300 psi	2000 psi	SE	236

*with amplifier

Table P-44. Measurement List for ICAL I (Continued)

Measurement Number	Hole Number	Location		Depth Z (ft)	Measure. Type	Predicted Level	Xducer Nominal Range	Xducer Model	Xducer Serial Number
		X (ft)	Y (ft)						
025	L09	28	5	3	FS-H	200 psi	2000 psi	SE	185
026	L12	15	7.5	3.36	FS-45	1700 psi	4000 psi	SE	203
027	L11	7	15	13.4	FS-H	1700 psi	4000 psi	SE	132
028	L14	7	20	3	FS-H	1000 psi	2000 psi	SE	284
029	L15	1	25	10.4	FS-H	400 psi	2000 psi	SE	201
031	L17	7	25	12.5	FS-H	400 psi	2000 psi	SE	262
032	L18	9	25	3	FS-H	400 psi	2000 psi	SE	282
033	L01	2.5	2.5	11.92	FS-V	2000 psi	4000 psi	SE	128
034	L01	2.5	2.5	5.00	FS-V			SRI	
035	L02	0	5	11.33	FS-V	2000 psi	4000 psi	SE	120
036	L02	0	5	5.0	FS-V			SRI	
037	L03	2.5	5	11.50	FS-V	2000 psi	4000 psi	SE	124
038	L03	2.5	5	5.0	FS-V			SRI	
039	L04	5	5	11.60	FS-V	2000 psi	4000 psi	SE	229
040	L04	5	5	5.0	FS-V			SRI	
041	Photo Pole	5	5	-3.75	AV	5000g	50000g	SE	AD05
042	Photo Pole	7.5	2.5	-3.75	AV	5000g	10000g	2261C	AD78
043	Photo Pole	2.5	7.5	-3.75	AV	5000g	10000g	2261C	AA95
044	Photo Pole	2.5	2.5	-1.54	AV	5000g	10000g	2261C	AA93
045	L21	0	10	11.75	FS-45	2000 psi	4000 psi	SE	222
046	L22	10	10	11.75	FS-45	2000 psi	4000 psi	SE	154
047	L23	7	30	3	AH	500g	5000g	2264A	AG31*
048	L23	7	30	3	AH	500g	5000g	2264A	AG29

*with amplifier

Table P-45. Measurement List for ICAL II

Measurement Number	Hole Number	Location X (ft) Y (ft)	Depth Z (ft)	Measure. Type	Predicted Level	Xducer Nominal Range	Xducer Model	Xducer Serial Number
001	L01	10 30	14	AV	6000g	10000g	2264A	AB95
002	L01	10 30	14	AH	6000g	10000g	2264A	AB92
003	L01	10 30	3	AV	6000g	10000g	2261C 10K mi	AB88
004	L01	10 30	3	AH	6000g	10000g	2261C 10K mi	AA61
005	L06	10 45	14	AV	1800g	5000g	2264A	AG51
006	L06	10 45	14	AH	1800g	5000g	2264A	AH40
007	L06	10 45	10	AV	1800g	5000g	2264A	AH49
008	L06	10 45	10	AH	1800g	5000g	2264A	AH52
009	L06	10 45	3	AV	1800g	5000g	2264A	AE94
010	L06	10 45	3	AH	1800g	5000g	2264A	AG97
011	L13	10 75	14	AV	550g	5000g	2264A	AH27
012	L13	10 75	14	AH	550g	5000g	2264A	AH90
013	L13	10 75	10	AV	550g	5000g	2264A	AH74
014	L13	10 75	10	AH	550g	5000g	2264A	AH51
015	L13	10 75	3	AV	550g	5000g	2264A	AH56
016	L13	10 75	3	AH	550g	5000g	2264A	AF87
017	PP*	10 10	-3.75	AV	5000g	10000g	2264A	AB79
018	PP*	10 15	-3.75	AV	5000g	10000g	2264A	AC13
019	PP*	15 15	-3.75	AV	5000g	10000g	2261C	AA79
020	PP*	15 5	-1.54	AV	5000g	10000g	2261C	AB32

*Photo Pole

Table P-45. Measurement List for ICAL II (Continued)

Measurement Number	Hoie Number	Location X (ft)	Location Y (ft)	Depth Z (ft)	Measure. Type	Predicted Level	Xducer Nominal Range	Xducer Model	Xducer Serial Number
021	L02	12	30	14	FS-H	700 psi	4000 psi	SE	221
022	L05	8	30	14	FS-45	700 psi	3000 psi	SE	200
023	L03	14	30	3	FS-H	700 psi	3000 psi	SE	220
024	L04	8	30	3	FS-45	700 psi	3000 psi	SE	159
025	L07	12	45	14	FS-H	200 psi	4000 psi	SE	158
026	L12	8	45	14	FS-45	200 psi	4000 psi	SE	225
027	L08	14	45	10	FS-H	200 psi	4000 psi	SE	198
028	L11	8	45	10	FS-45	200 psi	4000 psi	SE	152
029	L09	16	45	3	FS-H	200 psi	4000 psi	SE	180
030	L10	8	45	3	FS-45	200 psi	3000 psi	SE	167
032	L17	8	25	14	FS-45	1200 psi	4000 psi	SE	224
035	L22	26	10	3	FS-H	1200 psi	3000 psi	SE	212
036	L23	30	10	3	FS-H	700 psi	3000 psi	SE	130
037	L24	33	10	3	FS-H	450 psi	3000 psi	SE	133
038	L18	5	5	9.75	FS-V	3000 psi	4000 psi	SE	223
039	L19	0	10	9.75	FS-V ²⁰⁰	3000 psi	4000 psi	SE	219
040	L20	5	10	9.75	FS-V	3000 psi	4000 psi	SE	135
041	L21	10	10	9.75	FS-V	3000 psi	4000 psi	SE	192

Table P-45. Measurement List for ICAL II (Continued)

Measurement Number	Hole Number	Location X (ft) Y (ft)	Depth Z (ft)	Measure. Type	Predicted Level	Xducer Nominal Range	Xducer Model	Xducer Serial Number
042	N/A	10 410	0	AVT	.25g	.5g		
043	N/A	10 410	0	AHL	.25g	.5g		
044	N/A	10 410	0	AHT	.25g	.5g		
045	N/A	10 260	0	AVT	.5g	1.0g		
046	N/A	10 260	0	AHL	.5g	1.0g		
047	N/A	10 260	0	AHT	.5g	1.0g		
048	N/A	10 110	0	AVT	2.5g	5.0g		
049	N/A	10 110	0	AHL	2.5g	5.0g		
050	N/A	10 110	0	AHT	2.5g	5.0g		
051	L25	5 15	9.75	Noise	20 mv			350Ω Bridge
052	L26	15 15	9.75	Noise	20 mv			350Ω Bridge

Table P-46. Measurement List for ICAL III

Measurement Number	Hole Number	X (ft)	Y (ft)	Z (ft)	Measure. Type	Predicted Level	Xducer Nominal Range	Xducer Model	Xducer Serial Number
001	L10	35	7	30.7	AV	600g	5000g	2264A	AH53
002	L10	35	7	30.7	AH	600g	5000g	2264A	AG82
003	L11	35	27	30.7	AV	300g	5000g	2264A	AG91
004	L11	35	27	30.7	AH	300g	5000g	2264A	AG90
005	L11	35	27	19.8	AV	600g	5000g	2264A	AH06
006	L11	35	27	19.8	AH	600g	5000g	2264A	AH48
007	L11	35	27	3	AV	1200g	10000g	2261C	AC30
008	L11	35	27	3	AH	1200g	10000g	2261C	AF12
009	L14	35	42	23.3	AV	100g	5000g	2264A	AG77
010	L14	35	42	23.3	AH	100g	5000g	2264A	AG79
011	L14	35	42	17.5	AV	120g	5000g	2264A	AG46
012	L14	35	42	17.5	AH	120g	5000g	2264A	AE35
013	L14	35	42	3	AV	350g	5000g	2264A	AD89
014	L14	35	42	3	AH	350g	5000g	2264A	AE91
015	L16	35	72	26	AV	25g	250g	2260C	AE81
016	L16	35	72	26	AH	25g	250g	2260C	AD91
017	L16	35	72	22.3	AV	40g	500g	2260C	AF02
018	L16	35	72	22.3	AH	40g	500g	2260C	AE74
019	L16	35	72	15.1	AV	60g	500g	2260C	AE87
020	L16	35	72	15.1	AH	60g	500g	2260C	AC95
021	L16	35	72	3	AV	110g	5000g	2264A	AH30

Table P-46. Measurement List for ICAL III (Continued)

Measurement Number	Hole Number	Location		Z (ft)	Measure. Type	Predicted Level	Xducer Nominal Range	Xducer Model	Xducer Serial Number
		X (ft)	Y (ft)						
022	L16	35	72	3	AH	110g	5000g	2264A	AG02
023	L13	39	27	19.8	FS-H	700 psi	2000 psi	SE	167
024	L15	33	27	19.8	FS-45	700 psi	2000 psi	SE	117
025	L12	37	27	3	FS-H	700 psi	2000 psi	SE	115
026	L18	39	42	18	FS-H	200 psi	2000 psi	SE	110
027	L19	33	42	14.7	FS-45	200 psi	2000 psi	SE	106
028	L17	37	42	3.25	FS-H	200 psi	2000 psi	SE	182
029	L07	51	7	3	FS-H	1200 psi	4000 psi	SE	143
030	L08	55	7	3.08	FS-H	700 psi	2000 psi	SE	162
031	L09	58	7	3	FS-H	500 psi	2000 psi	SE	180
032	L01	31.5	3.5	9.75	FS-V	2000 psi	4000 psi	SE	123
033	L04	28	7	9.9	FS-V	2000 psi	4000 psi	SE	172
034	L05	31.5	7	9.75	FS-V	2000 psi	4000 psi	SE	184
035	L06	35	7	9.75	FS-V	2000 psi	4000 psi	SE	136
036	PP	35	7	-3.75	AV	5000g	10000g	2264A	AC18
037	PP	35	10.5	-3.75	AV	5000g	10000g	2264A	AB14
038	PP	38.5	10.5	-3.75	AV	5000g	10000g	2264A	AC15
039	PP	38.5	3.5	-1.54	AV	5000g	10000g	2261C	AG19
040	L02	0.1	7	17.1	AV	1000g	5000g	2264A	AG52

Table P-46. Measurement List for ICAL III (Continued)

Measurement Number	Hole Number	Location		Z (ft)	Measure. Type	Predicted Level	Xducer Nominal Range	Xducer Model	Xducer Serial Number
		X (ft)	Y (ft)						
041	L02	0.1	7	17.1	AH	1000g	5000g	2264A	AG58
042	L02	0.1	7	16.6	WAM-V	500 psi	4000 psi	WAM	99
043	L02	1.1	7	15.1	WAM-H	500 psi	4000 psi	WAM	62
044	L02	0.1	8	15.1	WAM-H	500 psi	4000 psi	WAM	49
045	L03	15.2	7	16.5	AV	1000g	5000g	2264A	AG53
046	L03	15.2	7	16.5	AH	1000g	5000g	2264A	AG62
047	L03	15.2	7	17	WAM-V	2000 psi	4000 psi	WAM	53
048	L03	16.2	7	15.5	WAM-H	2000 psi	4000 psi	WAM	54
049	L03	15.2	8	15.5	WAM-H	2000 psi	4000 psi	WAM	79
050		285	7	0	AVT	.25g			
051		285	7	0	AHL	.25g			
052		285	7	0	AHT	.25g			
053		210	7	0	AVT	.5g			
054		210	7	0	AHT	.5g			
055		210	7	0	AHT	.5g			
056		110	7	0	AVT	2.5g			
057		110	7	0	AHL	2.5g			
058		110	7	0	AHT	2.5g			
059		16	7	16	Strain	300 $\mu\epsilon$			
060		16	7	15	Strain	600 $\mu\epsilon$			

Table P-47. Measurement List for ICAL IV

Measurement Number	Hole Number	Location X (ft) Y (ft)	Depth Z (ft)	Measure. Type	Predicted Level	Xducer Nominal Range	Xducer Model	Xducer Serial Number
001	L14	35 7	26.2	AV	1000g	5000g	2264A	AH17
002	L14	35 7	26.2	AH	300g	5000g	2264A	AG99
003	L15	35 29	3	AV	700g	5000g	2264A	AH14
004	L15	35 29	3	AH	2200g	5000g	2264A	AH09
005	L11	35 22	8	AV	2000g	5000g	2264A	AG72
006	L11	35 22	8	AH	5500g	10000g	2261C	AB03
007	L09	35 17	13	AV	7000g	10000g	2261C	AB35
008	L09	35 17	13	AH	9000g	10000g	2261C	AA41
009	L09	35 17	16.2	AV	4500g	10000g	2261C	AA46
010	L09	35 17	16.2	AH	4000g	10000g	2261C	AB06
011	L12	37 22	3	AV	3000g	5000g	2264A	AG71
012	L12	37 22	3	AH	6000g	10000g	2261C	AG20
013	L12	37 22	13	AV	2400g	5000g	2264A	AG85
014	L12	37 22	13	AH	4400g	5000g	2264A	AH42
015	L11	35 22	16.2	AV	1300g	5000g	2264A	AH73
016	L11	35 22	16.2	AH	1500g	5000g	2264A	AH08
017	L12	37 22	19.6	AV	700g	500g	2260C	AE39
018	L12	37 22	19.6	AH	650g	5000g	2264A	AG94
019	L12	37 22	26.0	AV	350g	500g	2260C	AA72
020	L12	37 22	26.0	AH	250g	5000g	2264A	AH11
021*	L11	35 22	26.2	AV	350g	500g	2260C	AB90

*Soft grout

Table P-47. Measurement List for ICAL IV (Continued)

Measurement Number	Hole Number	X (ft)	Y (ft)	Depth Z (ft)	Measure. Type	Predicted Level	Xducer Nominal Range	Xducer Model	Xducer Serial Number
022*	L11	35	22	26.2	AH	250g	5000g	2264A	AG68
023	L15	35	29	16.2	AV	250g	500g	2260C	AE80
024	L15	35	29	16.2	AH	550g	5000g	2264A	AG64
025	L18	35	37	3	AV	200g	250g	2260C	AE79
026	L18	35	37	3	AH	200g	5000g	2264A	AH84
027	L18	35	37	8	AV	100g	250g	2260C	AC59
028	L18	35	37	8	AH	200g	5000g	2264A	AH58
029	L19	37	37	13	AV	50g	250g	2260C	AE76
030	L19	37	37	13	AH	200g	5000g	2264A	AH57
031	L18	35	37	16.2	AV	100g	250g	2260C	AE43
032	L18	35	37	16.2	AH	200g	5000g	2264A	AG74
033	L19	37	37	19.7	AV	50g	250g	2260C	AE06
034	L19	37	37	19.7	AH	100g	5000g	2264A	AG57
035	L15	35	29	13	AV	300g	250g	2260C	AE14
036	L15	35	29	13	AH	750g	5000g	2264A	AH93
037	L08	50	9	16.2	FS-H	1500 psi	2000 psi	SE	266
038	L21	31	22	16.2	FS-45	1500 psi	2000 psi	SE	291
039	L10	33	22	13.04	FS-H	1500 psi	2000 psi	SE	261
040	L13	39	22	8.17	FS-H	1500 psi	2000 psi	SE	102
041	L07	50	7	3	FS-H	1500 psi	2000 psi	SE	240
042	L20	39	37	16.2	FS-H	290 psi	2000 psi	SE	227

*Soft grout

Table P-47. Measurement List for ICAL IV (Continued)

Measurement Number	Hole Number	Location		Depth Z (ft)	Measure. Type	Predicted Level	Xducer Nominal Range	Xducer Model	Xducer Serial Number
		X (ft)	Y (ft)						
043	L17	33	37	3	FS-H	290 psi	2000 psi	SE	251
044	L16	37	29	3	FS-H	630 psi	2000 psi	SE	235
045	L01	31.5	3.5	9.44	FS-V	3000 psi	4000 psi	SE	219
046	L04	28	7	10.29	FS-V	3000 psi	4000 psi	SE	166
047	L05	31.5	7	10.4	FS-V	3000 psi	4000 psi	SE	233
048	L06	35	7	10.33	FS-V	3000 psi	4000 psi	SE	138
049	PP1	35	7	-5.4	AV	5000g	10000g	2261C	AH44
050	PP2	35	10.5	-5.4	AV	5000g	10000g	2261C	AH73
051	PP3	38.5	10.5	-5.4	AV	5000g	10000g	2261C	AH75
052	PP5	38.5	3.5	-3.19	AV	5000g	10000g	2261C	AK42
053	L02	10.15	7.18	4	AV	2000g	5000g	2264A	AH43
054	L02	10.15	7.18	4	AH	2000g	5000g	2264A	AH01
055	L02	10.15	7.18	4.5	WAM-V	1000 psi	4000 psi	WAM	48
056	L02	11.15	7.18	3	WAM-H	1000 psi	4000 psi	WAM	33
057	L02	10.15	8.18	3	WAM-H	1000 psi	4000 psi	WAM	89A
058	L03	19.75	7.26	4.01	AV	4000g	5000g	2264A	AG55
059	L03	19.75	7.26	4.01	AH	4000g	5000g	2264A	AG69
060	L03	19.75	7.26	4.51	WAM-V	2000 psi	4000 psi	WAM	24
061	L03	20.25	7.26	3.01	WAM-H	2000 psi	4000 psi	WAM	69
062	L03	19.75	8.26	3.01	WAM-H	2000 psi	4000 psi	WAM	50
063	N/A	204.5	183	16.2	AVT		1g		

Table P-47. Measurement List for ICAL IV (Continued)

Measurement Number	Hole Number	Location X (ft) Y (ft)	Depth Z (ft)	Measure. Type	Predicted Level	Xducer Nominal Range	Xducer Model	Xducer Serial Number
064	N/A	204.5 183	16.2	AHL		1g		
065	N/A	204.5 183	16.2	AHT		1g		
066	N/A	199.2 178.4	1.9	AVT		5g		
067	N/A	199.2 178.4	1.9	AHL		5g		
068	N/A	199.2 178.4	1.9	AHT		5g		

Table P-48. Measurement Recording List - ICAL I

Measure Number	Measurement Designation	Recorder	Track	VCO	Cal. Level Actual (EU)	% Bandedge @ Cal. Level
001	HP-I ICAL I-F-E-5-15-13.4-A-V	3	3	-	4513.50g	50
002	HP-I ICAL I-F-E-5-15-13.4-A-H	3	4	-	3949.07g	50
003	HP-I ICAL I-F-E-5-15-3-A-V	3	5	-	6974.02g	50
004	HP-I ICAL I-F-E-5-15-3-A-H	3	6	-	8954.68g	50
005	HP-I ICAL I-F-E-5-20-13-A-V	1	3	-	1278.63g	50
006	HP-I ICAL I-F-E-5-20-13-A-H	1	4	-	1488.98g	50
007	HP-I ICAL I-F-E-5-20-11-A-V	1	5	-	2418.00g	50
008	HP-I ICAL I-F-E-5-20-11-A-H	1	6	-	4348.35g	50
011	HP-I ICAL I-F-E-5-20-3-A-V	1	7	-	3000.83g	50
012	HP-I ICAL I-F-E-5-20-3-A-H	1	8	-	6044.17g	50
013	HP-I ICAL I-F-E-5-25-12.5-A-V	1	9	-	100.79g	50
014	HP-I ICAL I-F-E-5-25-12.5-A-H	1	10	-	201.48g	50
015	HP-I ICAL I-F-E-5-25-10.5-A-V	1	11	-	105.29g	50
016	HP-I ICAL I-F-E-5-25-10.5-A-H	1	12	-	199.47g	50
017	HP-I ICAL I-F-E-5-25-3-A-V	1	13	-	189.22g	50
018	HP-I ICAL I-F-E-5-25-3-A-H	4	10	-	200.00g	50
019	HP-I ICAL I-X-E-30-5-3-A-H	4	6	-	528.14g	35
020	HP-I ICAL I-X-E-30-5-3-A-H	4	7	-	481.63g	35
021	HP-I ICAL I-F-E-15-5-3-FS-H	3	7	-	1713.60 psi	50
022	HP-I ICAL I-F-E-18-5-3-FS-H	3	8	-	705.93 psi	100
023	HP-I ICAL I-F-E-21-5-3-FS-H	3	9	-	499.38 psi	50
024	HP-I ICAL I-F-E-25-5-3-FS-H	3	10	-	200.84 psi	30

Table P-48. Measurement Recording List - ICAL I (Continued)

Measure Number	Measurement Designation	Recorder	Track	VCO	Cal. Level Actual (EU)	% Bandedge @ Cal. Level
025	HP-I ICAL I-F-E-28-5-3-FS-H	3	11	-	199.02 psi	50
026	HP-I ICAL I-F-E-15-7.5-3-FS-45	3	12	-	1698.00 psi	50
027	HP-I ICAL I-F-E-7-15-13.4-FS-H	3	13	-	1733.63 psi	50
028	HP-I ICAL I-F-E-7-20-3-FS-H	3	14	-	995.68 psi	50
029	HP-I ICAL I-F-E-1-25-10.5-FS-H	3	15	-	400.00 psi	50
031	HP-I ICAL I-F-E-7-25-12.5-FS-H	3	16	-	398.89 psi	50
032	HP-I ICAL I-F-E-9-25-3-FS-H	3	17	-	411.14 psi	50
033	HP-I ICAL I-A-E-2.5-2.5-11.75-FS-V	3	18	-	2018.94 psi	50
034	HP-I ICAL I-SRI-2.5-2.5-5-FS-V	-	-	-	-	-
035	HP-I ICAL I-A-E-0-5-11.75-FS-V	3	19	-	2003.85 psi	50
036	HP-I ICAL I-SRI-0-5-5-FS-V	-	-	-	-	-
037	HP-I ICAL I-A-E-2.5-5-11.75-FS-V	3	20	-	1956.00 psi	50
038	HP-I ICAL I-SRI-2.5-5-5-FS-V	-	-	-	-	-
039	HP-I ICAL I-A-E-5-5-11.75-FS-V	3	21	-	1964.00 psi	50
040	HP-I ICAL I-SRI-5-5-5-FS-V	-	-	-	-	-
041	HP-I ICAL I-A-E-5-5-(-3.75)-A-V	3	22	-	4980.34 psi	50
042	HP-I ICAL I-A-E-5-7.5-(-3.75)-A-V	3	23	-	4813.18 psi	50
043	HP-I ICAL I-A-E-7.5-7.5-(-3.75)-A-V	3	24	-	5000.00 psi	50
044	HP-I ICAL I-A-E-7.5-2.5-(-1.54)-A-V	3	25	-	4976.08 psi	50
045	HP-I ICAL I-X-E-0-10-11.75-FS-45	3	26	-	2000.00 psi	50
046	HP-I ICAL I-X-E-10-10-11.75-FS-45	3	27	-	1948.76 psi	50
047	HP-I ICAL I-X-E-7-30-3-A-V	4	8	-	532.57g	35
048	HP-I ICAL I-X-E-7-30-3-A-H	4	9	-	488.93g	35

Table P-49. Measurement Recording List - ICAL II

Measure Number	Measurement Designation	Recorder	Track	VCO	Cal. Level Actual (EU)	% Bandedge @ Cal. Level
001	HP-I ICAL II-F-E-10-30-14-A-V	1	3	-	6030.48g	50
001A	HP-I ICAL II-F-E-10-30-14-A-V	2	8	-	6030.48g	75
002	HP-I ICAL II-F-E-10-30-14-A-H	3	3	-	6123.02g	50
002A	HP-I ICAL II-F-E-10-30-14-A-H	2	9	-	6123.02g	75
003	HP-I ICAL II-F-E-10-30-3-A-V	3	4	-	6077.78g	50
003A	HP-I ICAL II-F-E-10-30-3-A-V	2	11	-	6077.78g	30
004	HP-I ICAL II-F-E-10-30-3-A-H	3	5	-	6103.78g	50
004A	HP-I ICAL II-F-E-10-30-3-A-H	2	12	-	6103.78g	30
005	HP-I ICAL II-F-E-10-45-14-A-V	1	4	-	1843.00g	50
006	HP-I ICAL II-F-E-10-45-14-A-H	1	5	-	1823.76g	50
007	HP-I ICAL II-F-E-10-45-10-A-V	1	6	-	1800.22g	50
008	HP-I ICAL II-F-E-10-45-10-A-H	1	7	-	1805.28g	50
009	HP-I ICAL II-F-E-10-45-3-A-V	1	8	-	1798.08g	50
010	HP-I ICAL II-F-E-10-45-3-A-H	1	9	-	1790.74g	50
011	HP-I ICAL II-F-E-10-75-14-A-V	1	10	-	544.97g	75
012	HP-I ICAL II-F-E-10-75-14-A-H	1	11	-	543.08g	75
013	HP-I ICAL II-F-E-10-75-10-A-V	1	12	-	551.90g	75
014	HP-I ICAL II-F-E-10-75-10-A-H	1	13	-	549.30g	75
015	HP-I ICAL II-F-E-10-75-3-A-V	2	3	-	544.03g	75
016	HP-I ICAL II-F-E-10-75-3-A-H	2	4	-	534.47g	75
017	HP-I ICAL II-A-E-10-10-(-3.75)-A-V	3	6	-	5010.10g	50
018	HP-I ICAL II-A-E-10-15-(-3.75)-A-V	3	7	-	5088.53g	50

Table P-49. Measurement Recording List - ICAL II (Continued)

Measure Number	Measurement Designation	Recorder	Track	VCO	Cal. Level Actual (EU)	% Bandedge @ Cal. Level
019	HP-I ICAL II-A-E-15-15-(-3.75)-A-V	3	8	-	5003.44g	50
020	HP-I ICAL II-A-E-15-5-(-1.54)-A-V	2	5	-	5093.35g	50
021	HP-I ICAL II-F-E-12-30-14-FS-H	3	9	-	686.54 psi	50
022	HP-I ICAL II-F-E-8-30-14-FS-45	3	10	-	693.18 psi	50
023	HP-I ICAL II-F-E-14-30-3-FS-H	3	11	-	727.21 psi	50
024	HP-I ICAL II-F-E-8-30-3-FS-45	3	12	-	704.67 psi	50
025	HP-I ICAL II-F-E-12-45-14-FS-H	3	13	-	201.82 psi	50
026	HP-I ICAL II-F-E-8-45-14-FS-45	3	14	-	203.03 psi	50
027	HP-I ICAL II-F-E-14-45-10-FS-H	3	15	-	209.07 psi	50
028	HP-I ICAL II-F-E-8-45-10-FS-45	3	16	-	200.83 psi	50
029	HP-I ICAL II-F-E-16-45-3-FS-H	3	17	-	200.00 psi	50
030	HP-I ICAL II-F-E-8-45-3-FS-45	3	18	-	199.13 psi	50
031	HP-I ICAL II-F-E-12-25-14-FS-H	-	-	-	-	-
032	HP-I ICAL II-F-E-8-25-14-FS-45	3	20	-	1187.32 psi	50
035	HP-I ICAL II-F-E-26-10-3-FS-H	3	21	-	1177.98 psi	50
036	HP-I ICAL II-F-E-30-10-3-FS-H	3	22	-	688.02 psi	50
037	HP-I ICAL II-F-E-33-10-3-FS-H	3	23	-	450.26 psi	50
038	HP-I ICAL II-A-E-5-5-9.75-FS-V	3	24	-	976.98 psi	50
039	HP-I ICAL II-A-E-0-10-9.75-FS-V	3	25	-	1019.61 psi	50
040	HP-I ICAL II-A-E-5-10-9.75-FS-V	3	26	-	1000.78 psi	50
041	HP-I ICAL II-A-E-10-10-9.75-FS-V	3	27	-	994.96 psi	50
042	HP-I ICAL II-F-E-10-410-0-AVT	4	4	-	.5g	50

Table P-49. Measurement Recording List - ICAL II (Continued)

Measure Number	Measurement Designation	Recorder	Track	VCO	Cal. Level Actual (EU)	% Bandedge @ Cal. Level
043	HP-I ICAL II-F-E-10-410-0-AHL	4	5	-	.5g	50
044	HP-I ICAL II-F-E-10-410-0-AHT	4	6	-	.5g	50
045	HP-I ICAL II-F-E-10-260-0-AVT	4	7	-	1g	50
046	HP-I ICAL II-F-E-10-260-0-AHL	4	8	-	1g	50
047	HP-I ICAL II-F-E-10-260-0-AHT	4	9	-	1g	50
048	HP-I ICAL II-F-E-10-110-0-AVT	4	11	-	5g	50
049	HP-I ICAL II-F-E-10-110-0-AHL	4	12	-	5g	50
050	HP-I ICAL II-F-E-10-110-0-AHT	4	13	-	5g	50
051	HP-I ICAL II-X-E-5-15-9.75-Noise	2	6	-	20.4 mv	50
052	HP-I ICAL II-X-E-15-15-9.75-Noise	2	7	-	20.9 mv	50

Table P-50. Measurement Recording List - ICAL III

Measure Number	Measurement Designation	Recorder	Track	VCO	Cal. Level Actual (EU)	% Bandedge @ Cal. Level
001	HP-I ICAL III-F-E-35-7-30.7-A-V	3	3	-	594.49g	50
002	HP-I ICAL III-F-E-35-7-30.7-A-H	3	4	-	611.96g	50
003	HP-I ICAL III-F-E-35-27-30.7-A-V	1	3	-	300.30g	50
004	HP-I ICAL III-F-E-35-27-30.7-A-H	1	4	-	297.35g	50
005	HP-I ICAL III-F-E-35-27-19.8-A-V	3	5	-	598.93g	50
006	HP-I ICAL III-F-E-35-27-19.8-A-H	3	6	-	598.63g	50
007	HP-I ICAL III-F-E-35-27-3-A-V	3	7	-	1202.51g	50
008	HP-I ICAL III-F-E-35-27-3-A-H	3	8	-	1214.69g	50
009	HP-I ICAL III-F-E-35-42-23.3-A-V	1	5	-	95.94g	50
010	HP-I ICAL III-F-E-42-23.3-A-H	1	6	-	100.50g	50
011	HP-I ICAL III-F-E-35-42-17.5-A-V	1	7	-	117.92g	50
012	HP-I ICAL III-F-E-35-42-17.5-A-H	1	8	-	118.34g	50
013	HP-I ICAL III-F-E-35-42-3-A-V	3	9	-	344.72g	50
014	HP-I ICAL III-F-E-35-42-3-A-H	3	10	-	343.07g	50
015	HP-I ICAL III-F-E-35-72-26-A-V	1	9	-	24.55g	50
016	HP-I ICAL III-F-E-35-72-26-A-H	1	10	-	24.60g	50
017	HP-I ICAL III-F-E-35-72-22.3-A-V	1	11	-	38.96g	50
018	HP-I ICAL III-F-E-35-72-22.3-A-H	1	12	-	40.46g	50
019	HP-I ICAL III-F-E-35-72-15.1-A-V	1	13	-	59.99g	50
020	HP-I ICAL III-F-E-35-72-15.1-A-H	2	3	-	59.89g	50
021	HP-I ICAL III-F-E-35-72-3-A-V	2	4	-	110.34g	50
022	HP-I ICAL III-F-E-35-72-3-A-H	2	5	-	110.55g	50

Table P-50. Measurement Recording List - ICAL III (Continued)

Measure Number	Measurement Designation	Recorder	Track	VCO	Cal. Level Actual (EU)	% Bandedge @ Cal. Level
023	HP-I ICAL III-F-E-39-27-19.8-FS-H	3	11	-	699.84 psi	50
024	HP-I ICAL III-F-E-33-27-19.8-FS-45	3	12	-	695.56 psi	50
025	HP-I ICAL III-F-E-37-27-3-FS-H	3	13	-	701.60 psi	50
027	HP-I ICAL III-F-E-33-42-14.7-FS-45	3	15	-	200.71 psi	50
028	HP-I ICAL III-F-E-37-42-3.25-FS-H	3	16	-	207.00 psi	50
029	HP-I ICAL III-F-E-51-7-3-FS-H	3	17	-	1208.40 psi	50
030	HP-I ICAL III-F-E-55-7-3.08-FS-H	3	18	-	706.84 psi	50
031	HP-I ICAL III-F-E-58-7-3-FS-H	3	19	-	499.84 psi	50
032	HP-I ICAL III-A-E-31.5-3.5-9.75-FS-V	3	20	-	1988.52 psi	50
033	HP-I ICAL III-A-E-28-7-9.9-FS-V	3	21	-	2066.06 psi	50
034	HP-I ICAL III-A-E-31.5-7-9.75-FS-V	3	22	-	1937.73 psi	50
035	HP-I ICAL III-A-E-35-7-9.75-FS-V	3	23	-	1993.78 psi	50
036	HP-I ICAL III-A-E-35-7-(-3.75)-A-V	3	24	-	4788.42g	50
037	HP-I ICAL III-A-E-35-10.5-(-3.75)-A-V	3	25	-	4784.70g	50
038	HP-I ICAL III-A-E-38.5-10.5-(-3.75)-A-V	3	26	-	4722.04g	50
039	HP-I ICAL III-A-E-38.5-3.5-(-1.54)-A-V	3	27	-	5014.54g	50
040	HP-I ICAL III-S-E-0.1-7-17.1-A-V	2	6	-	1012.01g	50
041	HP-I ICAL III-S-E-0.1-7-17.1-A-H	2	7	-	999.96g	50
042	HP-I ICAL III-S-E-0.1-7-16.6-IPV	2	8	-	489.20 psi	50
043	HP-I ICAL III-S-E-1.1-7-15.1-IPH	2	9	-	499.13 psi	50
044	HP-I ICAL III-S-E-0.1-8-15.1-IPH	2	10	-	491.26 psi	50
045	HP-I ICAL III-S-E-15.2-7-16.5-A-V	2	11	-	1007.98g	50
047	HP-I ICAL III-S-E-15.2-7-17.0-IPV	2	13	-	2030.56 psi	50

Table P-50. Measurement Recording List - ICAL III (Continued)

Measure Number	Measurement Designation	Recorder	Track	VCO	Cal. Level Actual (EU)	% Bandedge @ Cal. Level
048	HP-I ICAL III-S-E-16.2-7-15.5-IPH	5	3	-	1983.96 psi	50
048A	HP-I ICAL III-S-E-16.2-7-15.5-IPH	5	4	-	1983.96 psi	100
049	HP-I ICAL III-S-E-15.2-8-15.5-IPV	5	5	-	1979.60 psi	50
050	HP-I ICAL III-F-E-285-7-0-AVT	4	5	-	.25g	45
051	HP-I ICAL III-F-E-285-7-0-AHL	4	6	-	.25g	45
052	HP-I ICAL III-F-E-285-7-0-AHT	4	7	-	.25g	45
053	HP-I ICAL III-F-E-210-7-0-AVT	4	8	-	.50g	45
054	HP-I ICAL III-F-E-210-7-0-AHL	4	9	-	.50g	45
055	HP-I ICAL III-F-E-210-7-0-AHT	4	10	-	.50g	45
056	HP-I ICAL III-F-E-110-7-0-AVT	4	11	-	2.5g	45
057	HP-I ICAL III-F-E-110-7-0-AHL	4	12	-	2.5g	45
058	HP-I ICAL III-F-E-110-7-0-AHT	4	13	-	2.5g	45
059	HP-I ICAL III-X-E-16-7-16-SE	4	3	-	600 µE	50
060	HP-I ICAL III-X-E-16-7-15-SE	4	4	-	300 µE	50

Table P-51. Measurement Recording List - ICAL IV

Measure Number	Measurement Designation	Recorder	Track	VCO	Cal. Level Actual (EU)	% Bandedge @ Cal. Level
001	HP-I ICAL IV-F-E-35-7-26.2-A-V	1	3	-	1004.78g	50
002	HP-I ICAL IV-F-E-35-7-26.2-A-H	1	4	-	302.72g	50
003	HP-I ICAL IV-F-E-35-29-3-A-V	1	5	-	707.34g	50
004	HP-I ICAL IV-F-E-35-29-3-A-H	1	6	-	2214.67g	50
005	HP-I ICAL IV-F-E-35-22-8-A-V	1	7	-	1995.55g	50
006	HP-I ICAL IV-F-E-35-22-8-A-H	3	3	-	5460.84g	50
007	HP-I ICAL IV-F-E-35-17-13-A-V	3	4	-	7068.22g	50
008	HP-I ICAL IV-F-E-35-17-13-A-H	3	5	-	8975.54g	50
009	HP-I ICAL IV-F-E-35-17-16.2-A-V	1	8	-	4460.06g	50
010	HP-I ICAL IV-F-E-35-17-16.2-A-H	1	9	-	4052.41g	50
011	HP-I ICAL IV-F-E-37-22-3-A-V	1	10	-	2887.62g	50
012	HP-I ICAL IV-F-E-37-22-3-A-H	1	11	-	5972.33g	50
013	HP-I ICAL IV-F-E-37-22-13-A-V	1	12	-	2398.96g	50
014	HP-I ICAL IV-F-E-37-22-13-A-H	1	13	-	4379.44g	50
015	HP-I ICAL IV-F-E-35-22-16.2-A-V	2	3	-	1309.90g	50
016	HP-I ICAL IV-F-E-35-22-16.2-A-H	2	4	-	1495.00g	50
017	HP-I ICAL IV-F-E-37-22-19.6-A-V	2	5	-	700.56g	50
018	HP-I ICAL IV-F-E-37-22-19.6-A-H	2	6	-	646.69g	50
019	HP-I ICAL IV-F-E-37-22-26.0-A-V	2	7	-	349.52g	50
020	HP-I ICAL IV-F-E-37-22-26.0-A-H	2	8	-	253.17g	50
021	HP-I ICAL IV-F-E-35-22-26.2-A-V	2	9	-	350.64g	50
022	HP-I ICAL IV-F-E-35-22-26.2-A-H	2	10	-	248.17g	50

Table P-51. Measurement Recording List - ICAL IV (Continued)

Measure Number	Measurement Designation	Recorder	Track	VCO	Cal. Level Actual (EU)	% Bandedge @ Cal. Level
023	HP-I ICAL IV-F-E-35-29-16.2-A-V	2	11	-	249.46g	50
024	HP-I ICAL IV-F-E-35-29-16.2-A-H	2	12	-	548.85g	50
025	HP-I ICAL IV-F-E-35-37-3.0-A-V	2	13	-	200.61g	50
026	HP-I ICAL IV-F-E-35-37-3.0-A-H	4	3	-	197.41g	50
027	HP-I ICAL IV-F-E-35-37-8.0-A-V	4	4	-	100.51g	50
028	HP-I ICAL IV-F-E-35-37-8.0-A-H	4	5	-	194.06g	50
029	HP-I ICAL IV-F-E-37-37-13.0-A-V	4	6	-	49.63g	50
030	HP-I ICAL IV-F-E-37-37-13.0-A-H	4	7	-	195.42g	50
031	HP-I ICAL IV-F-E-35-37-16.2-A-V	4	8	-	99.62g	50
032	HP-I ICAL IV-F-E-35-37-16.2-A-H	4	9	-	191.84g	50
033	HP-I ICAL IV-F-E-37-37-19.7-A-V	4	10	-	50.13g	50
034	HP-I ICAL IV-F-E-37-37-19.7-A-H	4	11	-	99.4g	50
035	HP-I ICAL IV-F-E-35-35-13.0-A-V	4	12	-	301.06g	50
036	HP-I ICAL IV-F-E-35-35-13.0-A-H	4	13	-	743.01g	50
037	HP-I ICAL IV-F-E-50-9-16.2-FS-H	3	6	-	1559.43 psi	50
038	HP-I ICAL IV-F-E-31-22-16.2-FS-45	3	7	-	1522.47 psi	50
039	HP-I ICAL IV-F-E-33-22-13.0-FS-H	3	8	-	1476.67 psi	50
040	HP-I ICAL IV-F-E-39-22-8.2-FS-H	3	9	-	1528.36 psi	50
042	HP-I ICAL IV-F-E-39-37-16.2-FS-H	3	11	-	288.90 psi	50
043	HP-I ICAL IV-F-E-33-37-3.0-FS-H	3	12	-	289.81 psi	50
044	HP-I ICAL IV-F-E-37-29-3.0-FS-H	3	13	-	626.11 psi	50
045	HP-I ICAL IV-A-E-31.5-3.5-9.4-FS-V	3	14	-	3031.75 psi	50

Table P-51. Measurement Recording List - ICAL IV (Continued)

Measure Number	Measurement Designation	Recorder	Track	VC0	Cal. Level Actual (EU)	% Bandedge @ Cal. Level
046	HP-I ICAL IV-A-E-28-7-10.3-FS-V	3	15	-	3001.04 psi	50
047	HP-I ICAL IV-A-E-31.5-7-10.4-FS-V	3	16	-	2973.39 psi	50
048	HP-I ICAL IV-A-E-35-7-10.3-FS-V	3	17	-	3012.22 psi	50
049	HP-I ICAL IV-A-E-35-7-(-5.4)-A-V	3	18	-	4970.10g	50
050	HP-I ICAL IV-A-E-35-10.5-(-5.4)-A-V	3	19	-	5000.21g	50
051	HP-I ICAL IV-A-E-38.5-10.5-(-5.4)-A-V	3	20	-	4991.70g	50
052	HP-I ICAL IV-A-E-38.5-3.5-(-3.2)-A-V	3	21	-	5006.94g	50
053	HP-I ICAL IV-S-E-10.2-7.2-4.0-A-V	5	3	-	1993.95g	100
054	HP-I ICAL IV-S-E-10.2-7.2-4.0-A-H	5	4	-	1990.44g	100
055	HP-I ICAL IV-S-E-10.2-7.2-4.5-IP-V	3	22	-	996.26 psi	100
056	HP-I ICAL IV-S-E-11.2-7.2-3-IP-H	3	23	-	989.69 psi	100
057	HP-I ICAL IV-S-E-10.2-8.2-3-IP-H	3	24	-	995.86 psi	100
058	HP-I ICAL IV-S-E-19.8-7.3-4-A-V	5	5	-	4061.82g	100
059	HP-I ICAL IV-S-E-19.8-7.3-4-A-H	5	6	-	4053.16g	100
060	HP-I ICAL IV-S-E-19.8-7.3-4.5-IP-V	3	25	-	2001.99 psi	100
061	HP-I ICAL IV-S-E-20.8-7.3-3.0-IP-H	3	26	-	1973.02 psi	65
062	HP-I ICAL IV-S-E-19.8-8.3-3.0-IP-H	3	27	-	2019.64 psi	65
063	HP-I ICAL IV-G-E-204.5-183-16.2-AVT	7	9	1	.5g	50
064	HP-I ICAL IV-G-E-204.5-183-16.2-AHL	7	9	3	.5g	50
065	HP-I ICAL IV-G-E-204.5-183-16.2-AHT	7	9	5	.5g	50
066	HP-I ICAL IV-G-E-199.2-178.4-1.9-AVT	7	9	7	2.5g	100
067	HP-I ICAL IV-G-E-199.2-178.4-1.9-AHL	7	9	9	2.5g	100
068	HP-I ICAL IV-G-E-199.2-178.4-1.9-AHT	7	9	11	2.5g	100

PART 5
HARD PAN HBL EVENTS

1. DESCRIPTION OF HBL I

The HBL I test consisted of the detonation of sixteen 50-lb ammonium nitrate slurry charges arranged in a 4 x 4 array at a depth of 3 ft below the existing grade. Surmounting the array was an added layer of surcharge 4.75 ft deep. The test was conducted as part of the program to evaluate the differences and similarities between HEST and BLEST induced ground motions and stresses.

Four small instrumented structures were included in the test configuration. These structures were similar to those included in the HBL III test and several of the ICAL tests.

2. INSTRUMENTATION OF HBL I EVENT

In the near field and free field there were a total of 51 accelerometers and 19 soil stress gages. Four of the photo poles used to record motion of the overburden had accelerometers attached to their bases.

The structures were instrumented (at shot time) with an aggregate of 11 WAM gages to measure normal stresses at the interfaces between structure and medium. There were also a total of five accelerometers between the four structures.

Figures P-26 and P-27 present plan and elevation views of the test configuration showing locations of each of the measurement transducers. Tables P-52 and P-54 are the measurement list and the measurement recording list for the event.

3. DESCRIPTION OF HBL II

The HBL II test consisted of the detonation of forty-nine 100-lb ammonium nitrate slurry charges arranged in a 7 x 7 array at a depth of 4.67* ft below the existing grade. Surmounting the array was an added layer of surcharge 3.75* ft deep. The test was conducted as part of the program to evaluate the differences and similarities between HEST and BLEST induced

*Shown incorrectly in figure P-29.

ground motions and stresses.

Four small instrumented structures were included in the test configuration. These structures were similar to those included in the HBL III test and several of the ICAL tests.

4. INSTRUMENTATION OF HBL II EVENT

In the near field and free field there was a total of 42 accelerometers and 19 soil stress gages. Four of the photo poles used to record motion of the overburden had accelerometers attached to their bases.

The structures were instrumented with an aggregate of 12 WAM gages to measure normal stresses at the interfaces between structure and medium. There was also a total of 8 accelerometers between the four structures, and two strain gages on one of the structures.

Figures P-28 and P-29 present plan and elevation views of the test configuration showing locations of each of the measurement transducers. Tables P-54 and P-55 are the measurement list and the measurement recording list for the event.

5. DESCRIPTION OF HBL III

The HBL III test consisted of the detonation of a 48 ft x 48 ft HEST array to evaluate the differences and similarities between HEST and BLEST induced ground motions and stresses. The HEST cavity was 1.5 ft deep and explosively loaded with detonating cord in a three dimensional fishnet weave to a density of 0.75 lb of PETN per cubic foot. The pitch of the detonating cord was designed to yield a constant horizontal propagation velocity of 12,200 feet per second. The explosive loading of the cavity, its depth, and the 4.4 ft depth of overburden were calculated to yield a peak cavity overpressure of 2700 psi. Figures 1 and 2 show plan and elevation views of the event configuration.

Four small instrumented test structures were included in the test configuration. These structures were similar to those fielded in several of the ICAL tests.

6. INSTRUMENTATION OF HBL III EVENT

HBL III was heavily instrumented with motion and stress measuring transducers. In the near field and free field there were a total of 60 accelerometers, 24 soil stress gages, and 12 blast pressure gages (of which three were experimental).

The structures were each instrumented with 2 accelerometers and 3 WAM gages. In addition, one of the structures included 2 strain gages. Locations of the various transducers are shown in figures P-30 and P-31.

Table P-56 is the measurement list for HBL III and table P-57 is the measurement recording list.

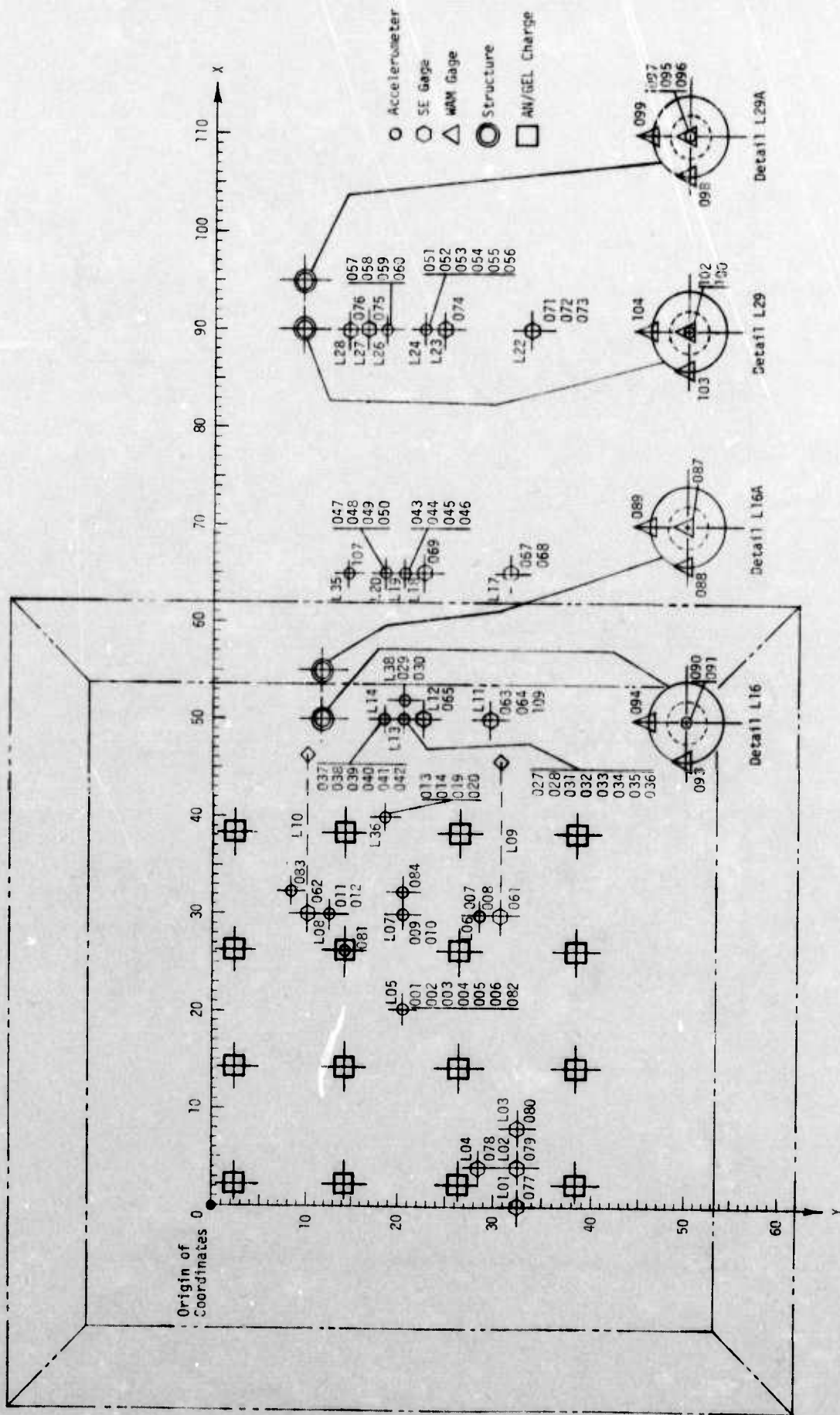

Figure P-26. Plan View of HBL I Site

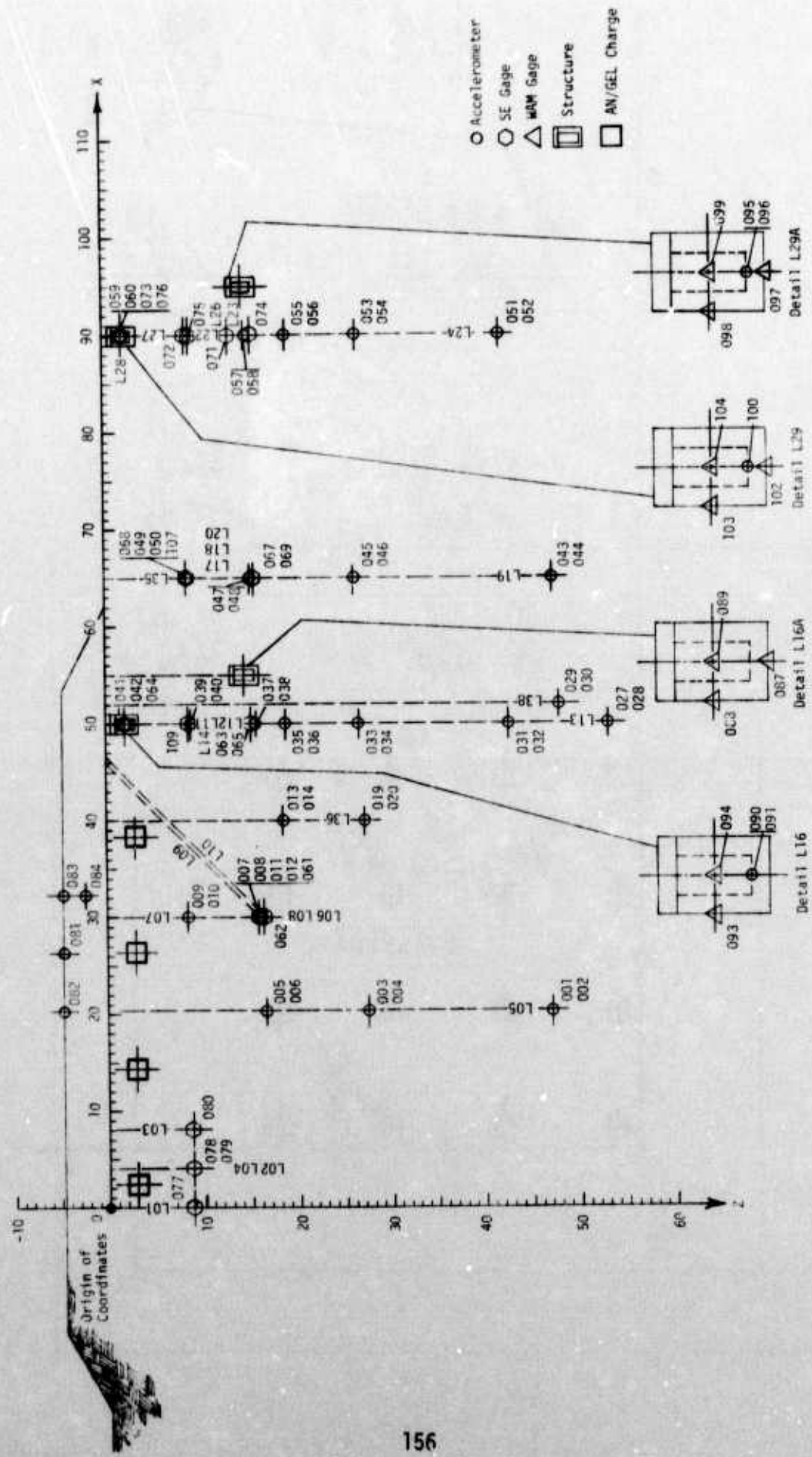

Figure P-27. Elevation View of HBL I Site

Table P-52. Measurement List for HBL I

Measurement Number	Hole Number	Location		Depth Z (ft)	Measure. Type	Predicted Level	Xducer Nominal Range	Xducer Model	Xducer Serial Number
		X (ft)	Y (ft)						
001	L05	20.3	20.3	47	AV	500	5000	2264A	AG01
002	L05	20.3	20.3	47	AH	500	5000	2264A	AE16
003	L05	20.3	20.3	27.3	AV	1000	5000	2264A	AC17
004	L05	20.3	20.3	27.3	AH	500	5000	2264A	AC57
005	L05	20.3	20.3	16.5	AV	5000	10000	2261C	AB25
006	L05	20.3	20.3	16.5	AH	3000	5000	2264A	AD09
007	L06	30	28.3	15.8	AV	5000	10000	2261C	AA83
008	L06	30	28.3	15.8	AH	3000	5000	2264A	AD13
009	L07	30	20.3	8.4	AV	5000	10000	2261C	AB57
010	L07	30	20.3	8.4	AH	4000	10000	2261C	AA14
011	L08	30	12.3	15.8	AV	5000	10000	2261C	AK76
012	L08	30	12.3	15.8	AH	3000	5000	2264A	AD50
013	L36	40	18.3	18.3	AV	1500	5000	2264A	AD53
014	L36	40	18.3	18.3	AH	2400	5000	2264A	AD72
019	L36	40	18.3	27.0	AV	500	5000	2264A	AH96
020	L36	40	18.3	27.0	AH	800	5000	2264A	AF96
027	L13	50	20.3	52.9	AV	70	500	2260C	AB88
028	L13	50	20.3	52.9	AH	100	500	2260C	AB15
029	L38	52	20.3	47.8	AV	70	500	2260C	AA90
030	L38	52	20.3	47.8	AH	115	500	2260C	AA54
031	L13	50	20.3	42.5	AV	75	500	2260C	AE55
032	L13	50	20.3	42.5	AH	125	500	2260C	AD83

Table P-52. Measurement List for HBL I (Continued)

Measurement Number	Hole Number	Location		Depth Z (ft)	Measure. Type	Predicted Level	Xducer Nominal Range	Xducer Model	Xducer Serial Number
		X (ft)	Y (ft)						
033	L13	50	20.3	26.3	AV	75	500	2260C	AD80
034	L13	50	20.3	26.3	AH	150	500	2260C	AD73
035	L13	50	20.3	18.7	AV	50	250	2260C	AE61
036	L13	50	20.3	18.7	AH	175	5000	2264A	AH16
037	L14	50	18.3	15.6	AV	75	500	2260C	AH93
038	L14	50	18.3	15.6	AH	200	5000	2264A	AH04
039	L14	50	18.3	8.8	AV	75	500	2260C	AD71
040	L14	50	18.3	8.8	AH	200	5000	2264A	AH03
041	L14	50	18.3	2	AV	75	500	2260C	AC96
042	L14	50	18.3	2	AH	200	5000	2264A	AH02
043	L19	65	20.3	47.2	AV	24.5	250	2260C	AD78
044	L19	65	20.3	47.2	AH	73.5	250	2260C	AD56
045	L19	65	20.3	26.1	AV	21	250	2260C	AE44
046	L19	65	20.3	26.1	AH	77	250	2260C	AE90
047	L20	65	18.3	15.2	AV	17.5	250	2260C	AC43
048	L20	65	18.3	15.2	AH	80.5	250	2260C	AD93
049	L20	65	18.3	8.6	AV	17.5	250	2260C	AB08
050	L20	65	18.3	8.6	AH	80.5	250	2260C	AD84
051	L24	90	22.3	41.9	AV	6	250	2260C	AD75
052	L24	90	22.3	41.9	AH	22.5	250	2260C	AD39
053	L24	90	22.3	26.5	AV	5	250	2260C	AC76
054	L24	90	22.3	26.5	AH	24.5	250	2260C	AB43

Table P-52. Measurement List for HBL I (Continued)

Measurement Number	Hole Number	Location		Depth Z (ft)	Measure Type	Predicted Level	Xducer Nominal Range	Xducer Model	Xducer Serial Number
		X (ft)	Y (ft)						
055	L24	90	22.3	19	AV	5	250	2260C	AE31
056	L24	90	22.3	19	AH	25	250	2260C	AG77
057	L26	90	18.3	14.8	AV	7.5	250	2260C	AG67
058	L26	90	18.3	14.8	AH	25	250	2260C	AG39
059	L26	90	18.3	2	AV	7.5	250	2260C	AG74
060	L26	90	18.3	2	AH	25	250	2260C	AG69
061	L09	30	30.6	15.8	FS-45	2250	4000	SE	326
062	L10	30	10	16.3	FS-45	2250	4000	SE	345
063	L11	50	29.3	15.1	FS-V	750	2000	SE	377
064	L11	50	29.3	2	FS-V	1125	4000	SE	376
065	L12	50	22.3	15.1	FS-H	750	2000	SE	395
067	L17	65	31.3	15.4	FS-V	300	2000	SE	302
068	L17	65	31.3	8.6	FS-V	300	2000	SE	332
069	L18	65	22.3	15.4	FS-H	300	2000	SE	371
071	L22	90	33.3	13.1	FS-V	100	2000	SE	380
072	L22	90	33.3	8.66	FS-V	100	2000	SE	352
073	L22	90	33.3	2	FS-V	100	2000	SE	319
074	L23	90	24.3	15.4	FS-H	100	2000	SE	312
075	L27	90	16.3	9	FS-H	100	2000	SE	310
076	L28	90	14.3	2	FS-H	100	2000	SE	389
077	L01	0	32.4	8	FS-V	4000	4000	SE	329
078	L04	4.05	28.35	8	FS-V	4000	4000	SE	301

Table P-52. Measurement List for HBL I (Continued)

Measurement Number	Hole Number	Location X (ft) Y (ft)	Depth Z (ft)	Measure. Type	Predicted Level	Xducer Nominal Range	Xducer Model	Xducer Serial Number
079	L02	4.05 32.4	8	FS-V	4000	4000	SE	331
080	L03	8.1 32.4	8	FS-V	4000	4000	SE	360
081		26.3 14.3	-4.75	AV	10000	50000	2264A	AD05
082		20.3 20.3	-4.75	AV	10000	10000	2261C	AC62
083		32.3 8.3	-4.75	AV	10000	10000	2261C	AB13
084		32.3 20.3	-2.55	AV	10000	10000	2261C	YB38
087	L16A	55 11.3	16.0	WAM-V	1000	4000	WAM	83A
088	L16A	54 11.3	14.5	WAM-H	1000	4000	WAM	77
089	L16A	55 10.3	14.5	WAM-H	1000	4000	WAM	85
090	L16	50 11.3	3	AV	3000	5000	2264A	AG80
091	L16	50 11.3	3	AH	3000	5000	2264A	AG67
093	L16	49 11.3	2	WAM-H	1500	4000	WAM	74
094	L16	50 10.3	2	WAM-H	1500	4000	WAM	42
095	L29A	95 9.3	15.6	AV	400	5000	2264A	AG65
096	L29A	95 9.3	15.6	AH	400	5000	2264A	AG63
097	L29A	95 9.3	16.1	WAM-V	200	4000	WAM	60
098	L29A	94 9.3	14.6	WAM-H	200	4000	WAM	45
099	L29A	95 8.3	14.6	WAM-H	200	4000	WAM	36
100	L29	90 9.3	3	AV	400	5000	2264A	AG60
102	L29	90 9.3	3.5	WAM-V	200	4000	WAM	47
103	L29	89 9.3	2	WAM-H	200	4000	WAM	75A

Table P-52 . Measurement List for HBL I (Continued)

Measurement Number	Hole Number	Location X (ft) Y (ft)	Depth Z (ft)	Measure. Type	Predicted Level	Xducer Nominal Range	Xducer Model	Xducer Serial Number
104	L29	90 8.3	2	WAM-H	200	4000	WAM	37
107	L35	65 14.3	8.6	AH	1500	5000	2264A	AG31
109	L11	50 29.3	8.6	FS-V	1000	4000	SE	317

Table P-53. Measurement Recording List for HBL I

Measure Number	Measurement Designation	Recorder	Track	VC0	Cal. Level Actual (EU)	% Bandedge @ Cal. Level
001	HP-I HBL I-F-E-20.3-20.3-47-A-V	1	3	-	490.62g	50
002	HP-I HBL I-F-E-20.3-20.3-47-A-H	1	4	-	500.02g	50
003	HP-I HBL I-F-E-20.3-20.3-27.3-A-V	1	5	-	995.08g	50
004	HP-I HBL I-F-E-20.3-20.3-27.3-A-H	1	6	-	504.15g	50
005	HP-I HBL I-F-E-20.3-20.3-16.5-A-V	1	7	-	5198.66g	50
006	HP-I HBL I-F-E-20.3-20.3-16.5-A-H	1	8	-	3028.65g	50
007	HP-I HBL I-F-E-30-28.3-15.8-A-V	1	9	-	4969.69g	50
008	HP-I HBL I-F-E-30-28.3-15.8-A-H	1	10	-	3038.34g	50
009	HP-I HBL I-F-E-30-20.3-8.4-A-V	5	11	-	4924.52g	50
010	HP-I HBL I-F-E-30-20.3-8.4-A-H	1	11	-	4000.0g	50
011	HP-I HBL I-F-E-30-12.3-15.8-A-V	1	12	-	5006.44g	50
012	HP-I HBL I-F-E-30-12.3-15.8-A-H	1	13	-	2963.81g	50
013	HP-I HBL I-F-E-40-18.3-18.3-A-V	2	3	-	1498.05g	50
014	HP-I HBL I-F-E-40-18.3-18.3-A-H	2	4	-	2441.44g	50
019	HP-I HBL I-F-E-40-18.3-27-A-V	2	9	-	500.0g	50
020	HP-I HBL I-F-E-40-18.3-27-A-H	2	10	-	803.58g	50
027	HP-I HBL I-F-E-50-20.3-52.9-A-V	7	3	1	68.78g	50
028	HP-I HBL I-F-E-50-20.3-52.9-A-H	7	3	3	100.0g	50
029	HP-I HBL I-F-E-52-20.3-47.8-A-V	7	3	5	68.39g	50
030	HP-I HBL I-F-E-52-20.3-47.8-A-H	7	3	7	115.11g	50
031	HP-I HBL I-F-E-50-20.3-42.5-A-V	7	3	9	74.62g	50
032	HP-I HBL I-F-E-50-20.3-42.5-A-H	7	3	11	130.17g	50

Table P-53. Measurement Recording List for HBL I (Continued)

Measure Number	Measurement Designation	Recorder	Track	YCO	Cal. Level Actual (EU)	% Bandedge @ Cal. Level
033	HP-I HBL I-F-E-50-20.3-26.3-A-V	7	3	13	104.90g	50
034	HP-I HBL I-F-E-50-20.3-26.3-A-H	7	3	15	146.52g	50
035	HP-I HBL I-F-E-50-20.3-18.7-A-V	7	3	17	46.06g	50
036	HP-I HBL I-F-E-50-20.3-18.7-A-H	4	6	-	178.68g	50
037	HP-I HBL I-F-E-50-18.3-15.6-A-V	7	4	1	74.47g	50
038	HP-I HBL I-F-E-50-18.3-15.6-A-H	4	7	-	198.57g	50
039	HP-I HBL I-F-E-50-18.3-8.8-A-V	7	4	3	75.08g	50
040	HP-I HBL I-F-E-50-18.3-8.8-A-H	7	4	5	199.61g	50
041	HP-I HBL I-F-E-50-18.3-2-A-V	7	4	7	74.45g	50
042	HP-I HBL I-F-E-50-18.3-2-A-H	7	4	9	201.19g	50
043	HP-I HBL I-F-E-65-20.3-47.2-A-V	7	4	11	25.32g	50
044	HP-I HBL I-F-E-65-20.3-47.2-A-H	7	4	13	54.21g	50
045	HP-I HBL I-F-E-65-20.3-26.1-A-V	7	4	15	20.94g	50
046	HP-I HBL I-F-E-65-20.3-26.1-A-H	7	4	17	77.61g	50
047	HP-I HBL I-F-E-65-18.3-15.2-A-V	7	5	1	17.45g	50
048	HP-I HBL I-F-E-65-18.3-15.2-A-H	7	5	3	80.38g	50
049	HP-I HBL I-F-E-65-18.3-8.6-A-V	7	5	5	17.69g	50
050	HP-I HBL I-F-E-65-18.3-8.6-A-H	7	5	7	80.44g	50
051	HP-I HBL I-F-E-90-22.3-41.9-A-V	7	5	9	5.91g	50
052	HP-I HBL I-F-E-90-22.3-41.9-A-H	7	5	11	22.62g	50
053	HP-I HBL I-F-E-90-22.3-26.5-A-V	7	5	13	5.0g	50
054	HP-I HBL I-F-E-90-22.3-26.5-A-H	7	5	15	24.89g	50

Table P-53. Measurement Recording List for HBL I (Continued)

Measure Number	Measurement Designation	Recorder	Track	VCO	Cal. Level Actual (EU)	% Bandedge @ Cal. Level
055	HP-I HBL I-F-E-90-22.3-19-A-V	7	5	17	4.97g	50
056	HP-I HBL I-F-E-90-22.3-19-A-H	7	6	1	25.0g	50
057	HP-I HBL I-F-E-90-18.3-14.8-A-V	7	6	3	7.55g	50
058	HP-I HBL I-F-E-90-18.3-14.8-A-H	7	6	5	25.0g	50
059	HP-I HBL I-F-E-90-18.3-2-A-V	7	6	7	7.47g	50
060	HP-I HBL I-F-E-90-18.3-2-A-H	7	6	9	24.16g	50
061	HP-I HBL I-F-E-30-30.6-15.8-FS-45	3	3	-	2266.44 psi	50
062	HP-I HBL I-F-E-30-10-16.3-FS-45	3	4	-	2174.54 psi	50
063	HP-I HBL I-F-E-50-29.3-15.1-FS-V	3	5	-	752.53 psi	50
064	HP-I HBL I-F-E-50-29.3-2-FS-V	3	6	-	1113.13 psi	50
065	HP-I HBL I-F-E-50-22.3-15.1-FS-H	3	7	-	751.83 psi	50
067	HP-I HBL I-F-E-65-31.3-15.4-FS-V	3	9	-	300.88 psi	50
068	HP-I HBL I-F-E-65-31.3-8.6-FS-V	3	10	-	295.54 psi	50
069	HP-I HBL I-F-E-65-22.3-15.4-FS-H	3	11	-	299.08 psi	50
071	HP-I HBL I-F-E-90-33.3-13.1-FS-V	3	13	-	98.45 psi	50
072	HP-I HBL I-F-E-90-33.3-8.66-FS-V	3	14	-	112.86 psi	50
073	HP-I HBL I-F-E-90-33.3-2-FS-V	3	15	-	104.76 psi	50
074	HP-I HBL I-F-E-90-24.3-15.4-FS-H	3	16	-	105.82 psi	55
075	HP-I HBL I-F-E-90-16.3-9-FS-H	3	17	-	97.50 psi	50
076	HP-I HBL I-F-E-90-14.3-2-FS-H	3	18	-	109.01 psi	55
077	HP-I HBL I-A-E-0-32.4-8.85-FS-V	3	19	-	3941.94 psi	50
078	HP-I HBL I-A-E-4.05-28.35-8.85-FS-V	3	20	-	3990.13 psi	50

Table P-53. Measurement Recording List for HBL I (Continued)

Measure Number	Measurement Designation	Recorder	Track	VCO	Cal. Level Actual (EU)	% Bandedge @ Cal. Level
079	HP-I HBL I-A-E-4.05-32.4-8.85-FS-V	3	21	-	4000.0 psi	50
080	HP-I HBL I-A-E-8.1-32.4-8.85-FS-V	3	22	-	4003.43 psi	50
081	HP-I HBL I-A-E-26.3-14.3-(-4.75)-A-V	3	23	-	10148.77g	50
082	HP-I HBL I-A-E-20.3-20.3-(-4.75)-A-V	3	24	-	10191.76g	50
083	HP-I HBL I-A-E-32.3-8.3-(-4.75)-A-V	3	25	-	10072.30g	50
084	HP-I HBL I-A-E-32.3-20.3-(-2.55)-A-V	5	10	-	9925.66g	50
087	HP-I HBL I-S-E-55-11.3-15.5-WAM-V	4	10	-	995.81 psi	
088	HP-I HBL I-S-E-54-11.3-15.5-WAM-H	4	11	-	985.76 psi	
088A	HP-I HBL I-S-E-54-11.3-16-WAM-H	4	12	-	985.76 psi	
089	HP-I HBL I-S-E-55-10.3-16-WAM-H	5	3	-	996.01 psi	
090	HP-I HBL I-S-E-50-11.3-3-A-V	5	4	-	2990.0g	
091	HP-I HBL I-S-E-50-11.3-3-A-H	5	5	-	3016.44g	
093	HP-I, HBL I-S-E-49-11.3-2-WAM-H	5	7	-	1517.88 psi	
093A	HP-I HBL I-S-E-49-11.3-2-WAM-H	5	8	-	1517.88 psi	
094	HP-I HBL I-S-E-50-10.3-2-WAM-H	2	7	-	1492.96 psi	
095	HP-I HBL I-S-E-95-9.3-15.6-A-V	5	12	-	405.82g	
096	HP-I HBL I-S-E-95-9.3-15.6-A-H	5	13	-	408.96g	
097	HP-I HBL I-S-E-95-9.3-16.11-WAM-V	2	5	-	199.36 psi	50
098	HP-I HBL I-S-E-94-9.3-14.6-WAM-H	2	6	-	200.97 psi	50
098A	HP-I HBL I-S-E-94-9.3-14.6-WAM-H	5	9	-	200.97 psi	50
099	HP-I HBL I-S-E-95-8.3-14.6-WAM-H	2	8	-	200.84 psi	50
100	HP-I HBL I-S-E-90-9.3-3-A-V	2	11	-	399.44g	50

Table P-53. Measurement Recording List for HBL I (Continued)

Measure Number	Measurement Designation	Recorder	Track	VC0	Cal. Level Actual (EU)	% Bandedge @ Cal. Level
102	HP-I HBL I-S-E-90-9.3-3.5-WAM-V	2	13	-	200.54 psi	50
103	HP-I HBL I-S-E-89-9.3-2-WAM-H	4	3	-	201.35 psi	50
103A	HP-I HBL I-S-E-89-9.3-2-WAM-H	5	6	-	201.35 psi	50
104	HP-I HBL I-S-E-90-8.3-2-WAM-H	4	5	-	202.59 psi	50
107	HP-I HBL I-X-E-65-14.3-8.6-A-H	4	13	-	532.57 g	20
109	HP-I HBL I-F-E-50-29.3-8.6-FS-V	3	27	-	738.22 psi	50

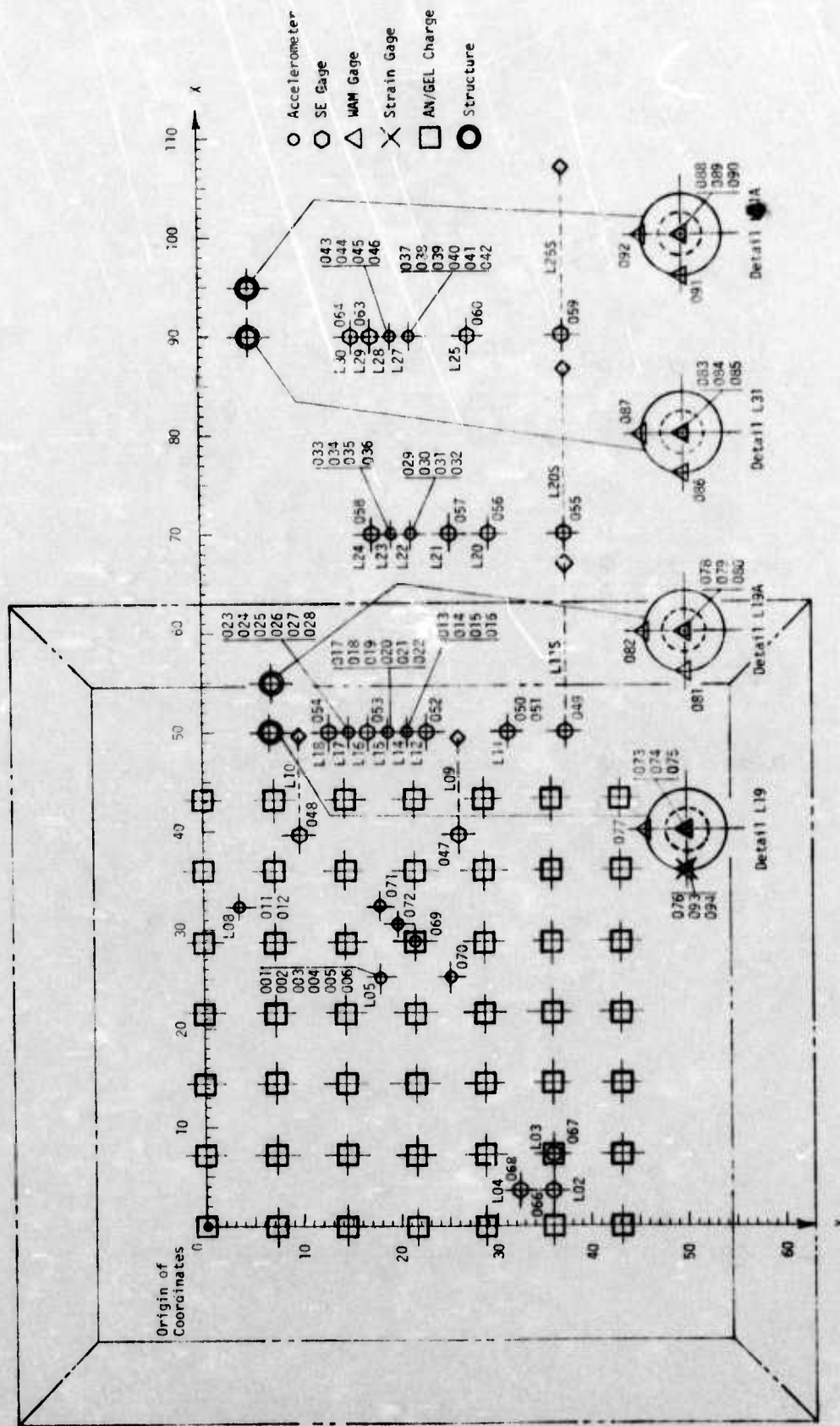

Figure P-28. Plan View of HBL II Site

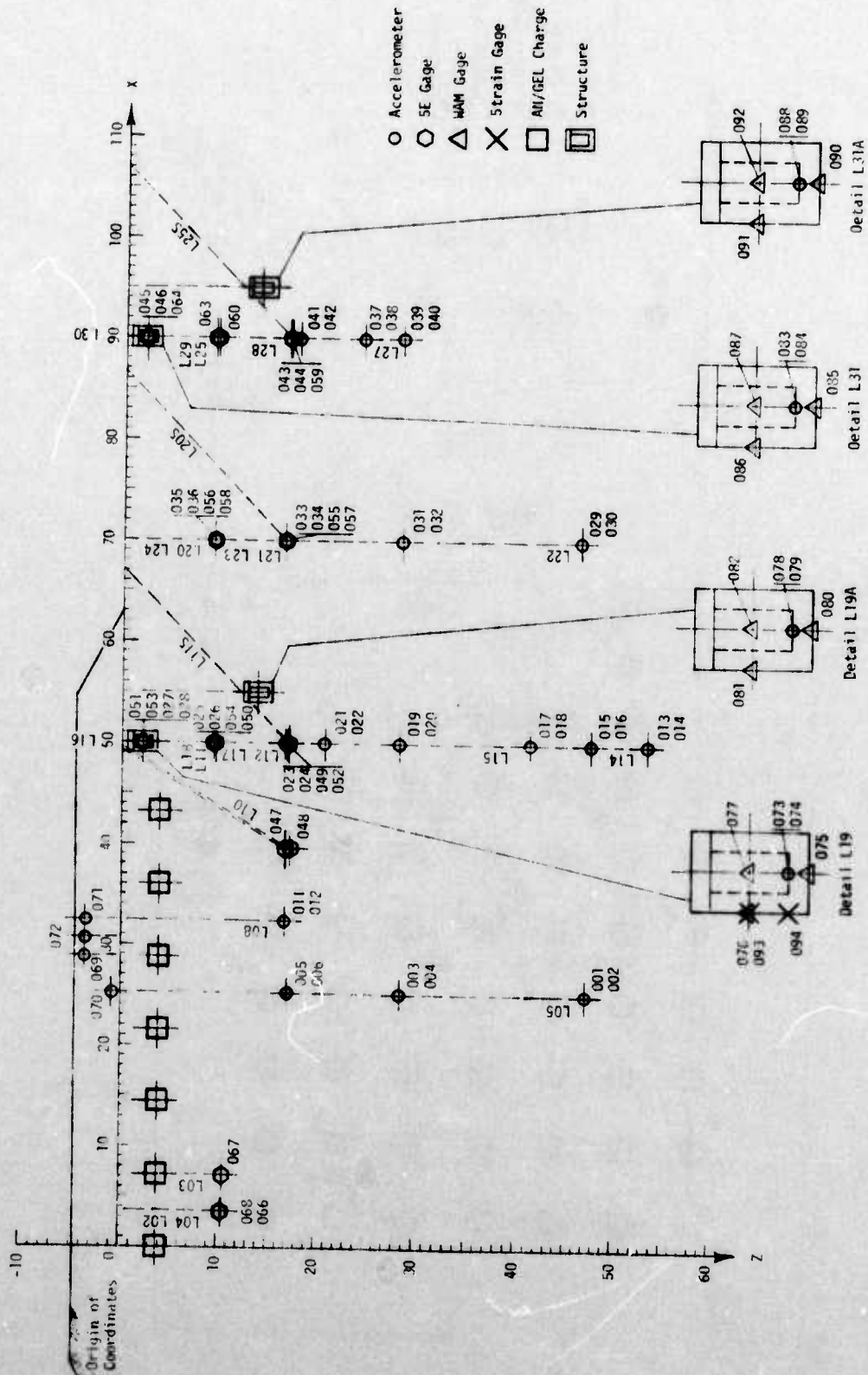

Figure P-29. Elevation View of HBL II Site

Table P-54. Measurement List for HBL II

Measurement Number	Hole Number	Location X (ft)	Location Y (ft)	Depth Z (ft)	Measure. Type	Predicted Level	Xducer Nominal Range	Xducer Model	Xducer Serial Number
001	L05	25.2	18	47.1	AV	500	5000	2264A	AE61
002	L05	25.2	18	47.1	AH	500	5000	2264A	AE37
003	L05	25.2	18	28.5	AV	1000	5000	2264A	AD35
004	L05	25.2	18	28.5	AH	500	5000	2264A	AD28
005	L05	25.2	18	17	AV	5000	10000	2261C	AB52
006	L05	25.2	18	17	AH	3000	5000	2264A	AC75
011	L08	32.4	3.6	16.7	AV	5000	10000	2261C	AE48
012	L08	32.4	3.6	16.7	AH	3000	5000	2264A	AH85
013	L14	50	21	53.3	AV	150	500	2260C	AA63
014	L14	50	21	53.3	AH	150	500	2260C	AB93
015	L14	50	21	47.5	AV	150	500	2260C	AB61
016	L14	50	21	47.5	AH	150	500	2260C	AB30
017	L15	50	19	41.2	AV	200	500	2260C	AB14
018	L15	50	19	41.2	AH	200	500	2260C	AC51
019	L15	50	19	28.3	AV	400	5000	2264A	AG41
020	L15	50	19	28.3	AH	400	5000	2264A	AH18
021	L15	50	19	20.7	AV	1500	5000	2264A	AF02
022	L15	50	19	20.7	AH	1500	5000	2264A	AF54
023	L17	50	15	16.6	AV	3000	5000	2264A	AH45
024	L17	50	15	16.6	AH	3000	5000	2264A	AH26
025	L17	50	15	9.3	AV	5000	10000	2261C	AA62
026	L17	50	15	9.3	AH	5000	10000	2261C	AD72

Table P-54. Measurement List for HBL II (Continued)

Measurement Number	Hole Number	Location		Depth Z (ft)	Measure. Type	Predicted Level	Xducer Nominal Range	Xducer Model	Xducer Serial Number
		X (ft)	Y (ft)						
027	L17	50	15	2	AV	5000	10000	2261C	AE37
028	L17	50	15	2	AH	5000	10000	2261C	AF18
029	L22	70	21.6	46.3	AV	200	500	2260C	AC10
030	L22	70	21.6	46.3	AH	200	500	2260C	AD79
031	L22	70	21.6	28.4	AV	350	5000	2264A	AH94
032	L22	70	21.6	28.4	AH	350	5000	2264A	AH62
033	L23	70	19.6	16.5	AV	500	5000	2264A	AH60
034	L23	70	19.6	16.5	AH	500	5000	2264A	AH55
035	L23	70	19.6	9.25	AV	600	5000	2264A	AD77
036	L23	70	19.6	9.25	AH	600	5000	2264A	AD93
037	L27	90	21.6	24.3	AV	50	250	2260C	AG59
038	L27	90	21.6	24.3	AH	50	250	2260C	AG71
039	L27	90	21.6	28.3	AV	70	250	2260C	AG72
040	L27	90	21.6	28.3	AH	70	250	2260C	AG60
041	L27	90	21.6	17.75	AV	80	250	2260C	AG61
042	L27	90	21.6	17.75	AH	80	250	2260C	AG64
043	L28	90	19.6	16.75	AV	80	250	2260C	AG66
044	L28	90	19.6	16.75	AH	80	250	2260C	AG70
045	L28	90	19.6	2	AV	80	250	2260C	AG41
046	L28	90	19.6	2	AH	80	250	2260C	AG42
047	L09	39.6	26.2	16.7	FS30	4000	4000	SE	337
048	L10	39.6	9.8	17.16	FS30	4000	4000	SE	363

Table P-54. Measurement List for HBL II (Continued)

Measurement Number	Hole Number	Location X (ft) Y (ft)	Depth Z (ft)	Measure. Type	Predicted Level	Xducer Nominal Range	Xducer Model	Xducer Serial Number
049	L11S	50 37.6	16.95	FS45	4000	4000	SE	323
050	L11	50 31.6	9.5	FS V	4000	4000	SE	356
051	L11	50 31.6	2	FS V	4000	4000	SE	368
052	L12	50 23	17	FS H	4000	4000	SE	386
053	L17	50 17	2	FS H	4000	4000	SE	355
054	L18	50 13	9.3	FS H	4000	4000	SE	333
055	L20S	70 37.6	16.5	FS45	1500	4000	SE	365
056	L20	70 29.6	9.25	FS V	1500	4000	SE	398
057	L21	70 25.6	16.5	FS H	1500	4000	SE	349
058	L24	70 17.6	9.25	FS H	1500	4000	SE	350
059	L25S	90 37.6	16.9	FS45	200	4000	SE	329
060	L25	90 27.6	9.42	FS V	200	4000	SE	338
063	L29	90 17.6	9.21	FS H	200	4000	SE	397
064	L30	90 15.6	2	FS H	200	4000	SE	392
066	L02	3.6 36	10.5	FS V	1600	4000	SE	315
067	L03	7.2 36	10.56	FS V	1600	4000	SE	311
068	L04	3.6 32.4	10.46	FS V	1600	4000	SE	399
069	PP	28.8 21.6	-3.75	AV	5000	10000	2261C	AE42
070	PP	25.2 25.2	- .95	AV	5000	10000	2261C	AK56
071	PP	32.4 18	-3.75	AV	5000	10000	2261C	AF13
072	PP	30.6 19.8	-3.75	AV	5000	10000	2261C	AB11
073	L19	50 6.97	3	AV	3500	5000	2264A	AD46

Table P-54. Measurement List for HBL II (Continued)

Measurement Number	Hole Number	Location		Depth Z (ft)	Measure. Type	Predicted Level	Xducer Nominal Range	Xducer Model	Xducer Serial Number
		X (ft)	Y (ft)						
074	L19	50	6.97	3	AH	3500	5000	2264A	AE85
075	L19	50	6.97	3.5	WAM V	3000	4000	WAM	101
076	L19	49	6.97	2	WAM H	1000	4000	WAM	121
077	L19	50	5.97	2	WAM H	3000	4000	WAM	24
078	L19A	55	7.13	14.85	AV	3000	5000	2264A	AH28
079	L19A	55	7.13	14.85	AH	3000	5000	2264A	AH10
080	L19A	55	7.13	15.35	WAM V	3000	4000	WAM	117
081	L19A	54	7.13	13.85	WAM H	1000	4000	WAM	69
082	L19A	55	6.13	13.85	WAM H	3000	4000	WAM	33
083	L31	90	5.05	3	AV	500	5000	2264A	AG09
084	L31	90	5.05	3	AH	500	5000	2264A	AG54
085	L31	90	5.05	3.5	WAM V	200	4000	WAM	119
086	L31	89	5.05	2	WAM H	100	4000	WAM	48
087	L31	90	4.05	2	WAM H	200	4000	WAM	67
088	L31A	95	5.05	14.88	AV	500	5000	2264A	AH91
089	L31A	95	5.05	14.88	AH	500	5000	2264A	AH88
090	L31A	95	5.05	15.38	WAM V	200	4000	WAM	83
091	L31A	94	5.05	13.88	WAM H	100	4000	WAM	118
092	L31A	95	4.05	13.88	WAM H	200	4000	WAM	124
093	L19	49	6.97	2	SE	1200	2500	Strain	T-1
094	L19	49	6.97	3	SE	1200	2500	Strain	T-2

Table P-55. Measurement Recording List for HBL II

Measure Number	Measurement Designation	Recorder	Track	VCO	Cal. Level Actual (EU)	% Bandedge @ Cal. Level
001	HP-I HBL II-F-E-25.2-18-47.1-A-V	1	3	-	497.65g	50
002	HP-I HBL II-F-E-25.2-18-47.1-A-H	1	4	-	501.96g	50
003	HP-I HBL II-F-E-25.2-18-28.5-A-V	1	5	-	1009.18g	50
004	HP-I HBL II-F-E-25.2-18-28.5-A-H	1	6	-	461.40g	50
005	HP-I HBL II-F-E-25.2-18-17-A-V	1	7	-	5000.00g	50
006	HP-I HBL II-F-E-25.2-18-17-A-H	1	8	-	3004.85g	50
011	HP-I HBL II-F-E-32.4-3.6-16.7-A-V	3	7	-	4968.34g	50
012	HP-I HBL II-F-E-32.4-3.6-16.7-A-H	3	8	-	3002.08g	50
013	HP-I HBL II-F-E-50-21-53.3-A-V	1	9	-	170.58g	50
014	HP-I HBL II-F-E-50-21-53.3-A-H	1	10	-	150.95g	50
015	HP-I HBL II-F-E-50-21-47.5-A-V	1	11	-	152.28g	50
016	HP-I HBL II-F-E-50-21-47.5-A-H	1	12	-	151.14g	50
017	HP-I HBL II-F-E-50-19-41.2-A-V	1	13	-	200.29g	50
018	HP-I HBL II-F-E-50-19-41.2-A-H	2	3	-	199.48g	50
019	HP-I HBL II-F-E-50-19-28.3-A-V	2	4	-	402.39g	50
020	HP-I HBL II-F-E-50-19-28.3-A-H	2	5	-	402.16g	50
021	HP-I HBL II-F-E-50-19-20.7-A-V	2	6	-	1504.23g	50
022	HP-I HBL II-F-E-50-19-20.7-A-H	2	7	-	1505.97g	50
023	HP-I HBL II-F-E-50-15-16.6-A-V	2	8	-	2996.74g	50
024	HP-I HBL II-F-E-50-15-16.6-A-H	2	9	-	3011.82g	50
025	HP-I HBL II-F-E-50-15-9.3-A-V	2	10	-	5099.40g	50
026	HP-I HBL II-F-E-50-15-9.3-A-H	2	11	-	4940.49g	50

Table P-55. Measurement Recording List for HBL II (Continued)

Measure Number	Measurement Designation	Recorder	Track	VC0	Cal. Level Actual (EU)	% Bandedge @ Cal. Level
027	HP-I HBL II-F-E-50-15-2-A-V	2	12	-	5081.48g	50
028	HP-I HBL II-F-E-50-15-2-A-H	2	13	-	4992.99g	50
029	HP-I HBL II-F-E-70-21.6-46.3-A-V	7	3	1	196.9g	50
030	HP-I HBL II-F-E-70-21.6-46.3-A-H	7	3	3	201.35g	50
031	HP-I HBL II-F-E-70-21.6-28.4-A-V	7	3	5	351.81g	50
032	HP-I HBL II-F-E-70-21.6-28.4-A-H	7	3	7	347.95g	50
033	HP-I HBL II-F-E-70-19.6-16.5-A-V	7	3	9	502.00g	50
034	HP-I HBL II-F-E-70-19.6-16.5-A-H	7	3	11	500.47g	50
035	HP-I HBL II-F-E-70-19.6-9.25-A-V	7	3	13	600.70g	50
036	HP-I HBL II-F-E-70-19.6-9.25-A-H	7	3	15	590.27g	50
037	HP-I HBL II-F-E-90-21.6-24.3-A-V	7	3	17	50.08g	50
038	HP-I HBL II-F-E-90-21.6-24.3-A-H	7	4	1	50.78g	50
039	HP-I HBL II-F-E-90-21.6-28.3-A-V	7	4	3	70.06g	50
040	HP-I HBL II-F-E-90-21.6-28.3-A-H	7	4	5	68.38g	50
041	HP-I HBL II-F-E-90-21.6-17.75-A-V	7	4	7	80.77g	50
042	HP-I HBL II-F-E-90-21.6-17.75-A-H	7	4	9	78.23g	50
043	HP-I HBL II-F-E-90-19.6-16.75-A-V	7	4	11	78.94g	50
044	HP-I HBL II-F-E-90-19.6-16.75-A-H	7	4	13	80.05g	50
045	HP-I HBL II-F-E-90-19.6-2-A-V	7	4	15	79.61g	50
046	HP-I HBL II-F-E-90-19.6-2-A-H	7	4	17	77.38g	50
047	HP-I HBL II-F-E-39.6-26.2-16.7-FS-30	3	9	-	4013.23 psi	50
048	HP-I HBL II-F-E-39.6-9.8-17.16-FS-30	3	10	-	4017.54 psi	50

Table P-55. Measurement Recording List for HBL II (Continued)

Measure Number	Measurement Designation	Recorder	Track	VCO	Cal. Level Actual (EU)	% Bandedge @ Cal. Level
049	HP-I HBL II-F-E-50-37.6-16.95-FS-45	3	11	-	3999.21 psi	50
050	HP-I HBL II-F-E-50-31.6-9.5-FS-V	3	12	-	3986.33 psi	50
051	HP-I HBL II-F-E-50-31.6-2-FS-V	3	13	-	4015.61 psi	50
052	HP-I HBL II-F-E-50-23-17-FS-H	3	14	-	4063.95 psi	50
053	HP-I HBL II-F-E-50-17-2-FS-H	3	15	-	3990.69 psi	50
054	HP-I HBL II-F-E-50-13-9.3-FS-H	3	16	-	3990.56 psi	50
055	HP-I HBL II-F-E-70-37.6-16.5-FS-45	3	17	-	1532.28 psi	50
056	HP-I HBL II-F-E-70-29.6-9.25-FS-V	3	18	-	1495.36 psi	50
057	HP-I HBL II-F-E-70-25.6-16.5-FS-H	3	19	-	1500.24 psi	50
058	HP-I HBL II-F-E-70-17.6-9.25-FS-H	3	20	-	1514.72 psi	50
059	HP-I HBL II-F-E-90-37.6-16.9-FS-45	7	5	1	205.35 psi	50
060	HP-I HBL II-F-E-90-27.6-9.42-FS-V	7	5	3	199.31 psi	50
063	HP-I HBL II-F-E-90-17.6-9.25-FS-H	7	5	9	198.85 psi	50
064	HP-I HBL II-F-E-90-15.6-2-FS-H	7	5	11	200.17 psi	50
066	HP-I HBL II-A-E-3.6-36-10.50-FS-V	3	21	-	1625.51 psi	50
067	HP-I HBL II-A-E-7.2-36-10.56-FS-V	3	22	-	1568.75 psi	50
068	HP-I HBL II-A-E-3.6-32.4-10.46-FS-V	3	23	-	1621.64 psi	50
069	HP-I HBL II-A-E-28.8-21.6-(-3.75)-A-V	3	24	-	5022.03g	50
070	HP-I HBL II-A-E-25.2-25.2-(-.95)-A-V	3	25	-	4986.89g	50
071	HP-I HBL II-A-E-32.4-18-(-3.75)-A-V	3	26	-	5033.82g	50
072	HP-I HBL II-A-E-30.6-19.8-(-3.75)-A-V	3	27	-	5026.69g	50
073	HP-I HBL II-S-E-50-6.97-3-A-V	4	3	-	3487.25g	50

Table P-55. Measurement Recording List for HBL II (Continued)

Measure Number	Measurement Designation	Recorder	Track	VCO	Cal. Level Actual (EU)	% Bandedge @ Cal. Level
074	HP-I HBL II-S-E-50-6.97-3-A-H	4	4	-	3475.82g	50
075	HP-I HBL II-S-E-50-6.97-3.5-WAM-V	4	5	-	2998.38 psi	50
076	HP-I HBL II-S-E-49-6.97-2-WAM-H	4	6	-	999.63 psi	16.67
076A	HP-I HBL II-S-E-49-6.97-2-WAM-H	5	12	-	999.63 psi	50
G77	HP-I HBL II-S-E-50-5.97-2-WAM-H	4	7	-	3015.00 psi	50
078	HP-I HBL II-S-E-55-7.13-14.85-A-V	4	8	-	3016.00g	50
079	HP-I HBL II-S-E-55-7.13-14.85-A-H	4	9	-	2974.64g	50
080	HP-I HBL II-S-E-55-7.13-15.35-WAM-V	4	10	-	2980.88 psi	50
081	HP-I HBL II-S-E-54-7.13-13.85-WAM-H	4	11	-	1000.40 psi	16.67
081A	HP-I HBL II-S-E-54-7.13-13.85-WAM-H	5	13	-	1000.40 psi	50
082	HP-I HBL II-S-E-55-6.13-13.85-WAM-H	4	12	-	3000.08 psi	50
083	HP-I HBL II-S-E-90-5.05-3-A-V	6	5	-	500.97g	50
084	HP-I HBL II-S-E-90-5.05-3-A-H	5	3	-	501.82g	50
085	HP-I HBL II-S-E-90-5.05-3.5-WAM-V	5	4	-	197.64 psi	50
086	HP-I HBL II-S-E-89-5.05-2-WAM-H	5	5	-	99.42 psi	10
086A	HP-I HBL II-S-E-89-5.05-2-WAM-H	6	3	-	99.42 psi	50
087	HP-I HBL II-S-E-90-4.05-2-WAM-H	5	6	-	200.02 psi	50
089	HP-I HBL II-S-E-95-5.05-14.88-A-H	5	8	-	502.87g	50
090	HP-I HBL II-S-E-95-5.05-15.38-WAM-V	5	9	-	198.12 psi	50
091	HP-I HBL II-S-E-94-5.05-13.88-WAM-H	5	10	-	100.70 psi	10
091A	HP-I HBL II-S-E-94-5.05-13.88-WAM-H	6	4	-	100.70 psi	50
092	HP-I HBL II-S-E-95-4.05-13.88-WAM-H	5	11	-	199.71 psi	50

Table P-55. Measurement Recording List for HBL II (Continued)

Measure Number	Measurement Designation	Recorder	Track	VCO	Cal. Level Actual (EU)	% Bandedge @ Cal. Level
093	HP-I HBL II-X-E-49-6.97-2-SE	7	5	15	1164.28 μ E	50
094	HP-I HBL II-X-E-49-6.97-3-SE	7	5	17	1178.25 μ E	50

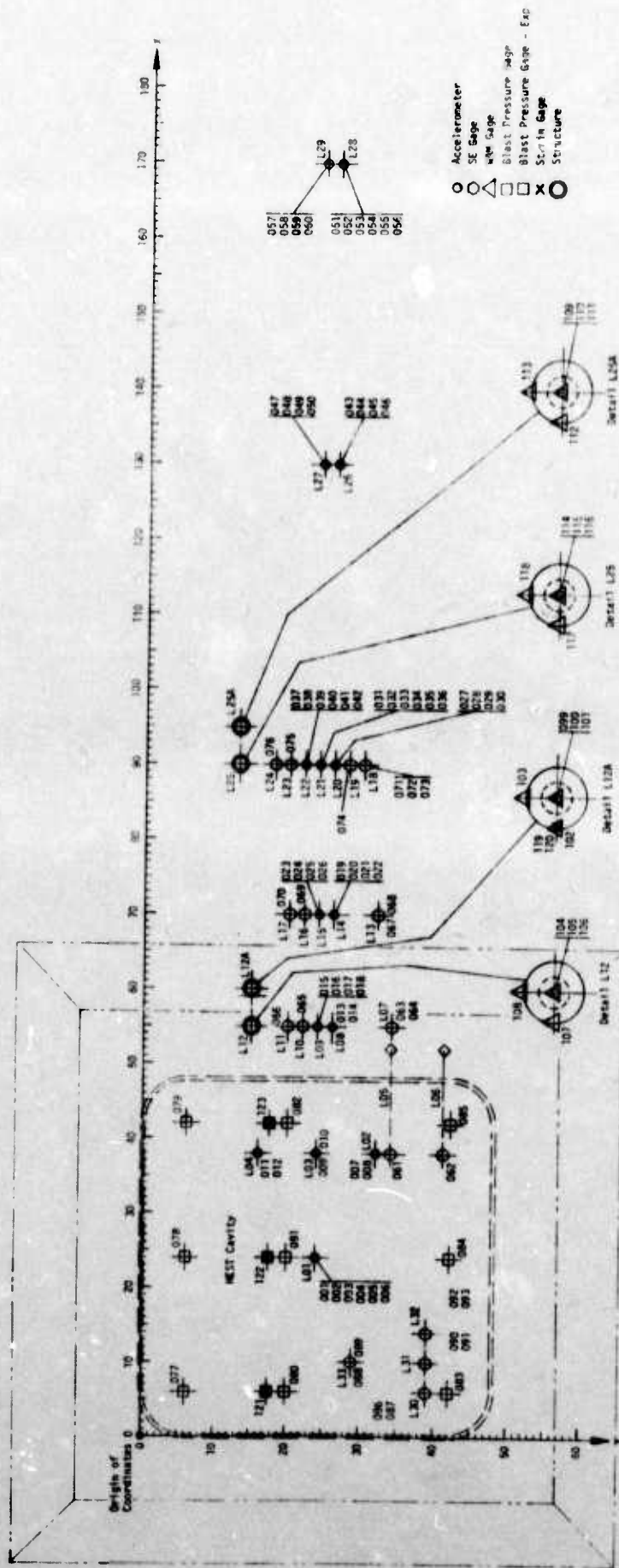

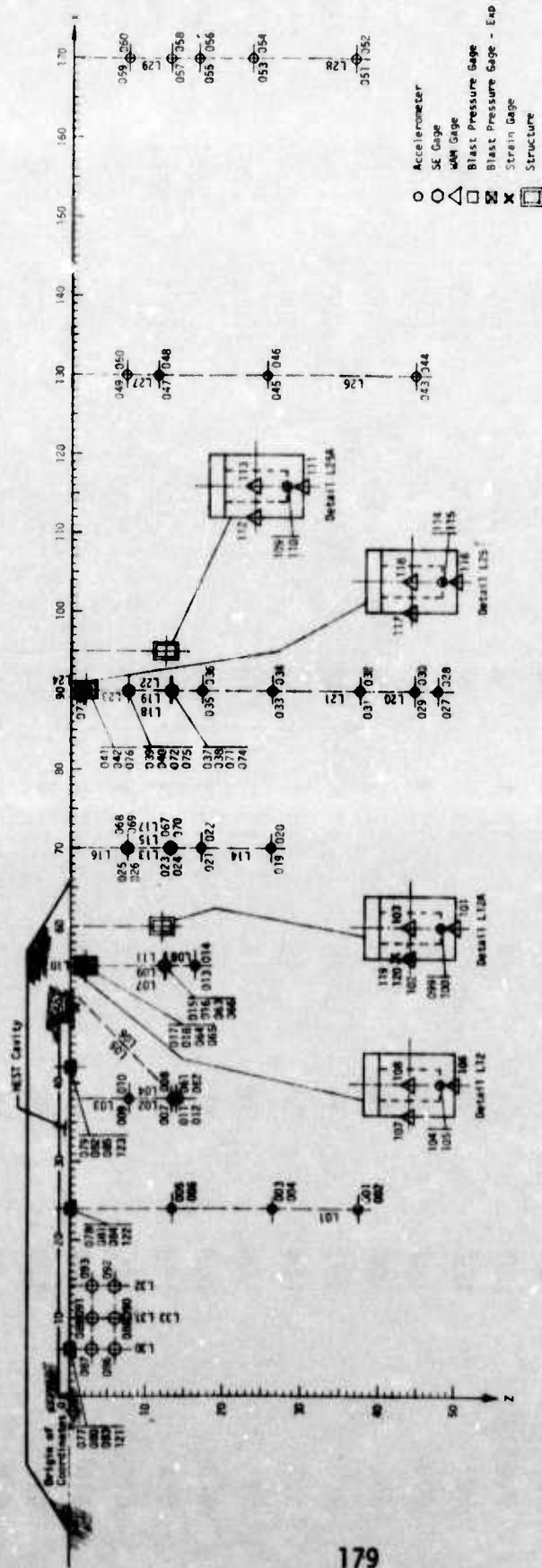

Table P-56. Measurement List for HBL III

Measurement Number	Hole Number	Location X (ft) Y (ft)	Depth Z (ft)	Measure. Type	Predicted Level	Xducer Nominal Range	Xducer Model	Xducer Serial Number
001	L01	24 24	37.2	AV	500	5000	2264A	AH63
002	L01	24 24	37.2	AH	500	5000	2264A	AG92
003	L01	24 24	26.4	AV	1000	5000	2264A	AG89
004	L01	24 24	26.4	AH	500	5000	2264A	AG88
005	L01	24 24	13.4	AV	5000	10000	2264A	AC42
006	L01	24 24	13.4	AH	3000	5000	2264A	AH34
007	L02	38 32	13.3	AV	5000	10000	2261C	AH29
008	L02	38 32	13.3	AH	3000	5000	2264A	AH12
009	L03	38 24	7.8	AV	5000	10000	2264A	AB68
010	L03	38 24	7.8	AH	4000	10000	2264A	AB86
011	L04	38 16	13.9	AV	5000	10000	2264A	AC36
012	L04	38 16	13.9	AH	3000	5000	2264A	AF78
013	L08	55 26	16.3	AV	1500	5000	2264A	AH15
014	L08	55 26	16.3	AH	2100	5000	2264A	AH92
015	L09	55 24	12.5	AV	2000	5000	2264A	AH64
016	L09	55 24	12.5	AH	2500	5000	2264A	AH07
017	L09	55 24	2.0	AV	2000	5000	2264A	AF80
018	L09	55 24	2.0	AH	4000	10000	2261C	AE80
019	L14	70 26	26.1	AV	500	5000	2264A	AH68
020	L14	70 26	26.1	AH	700	5000	2264A	AH23
021	L14	70 26	17.1	AV	400	5000	2264A	AG36
022	L14	70 26	17.1	AH	900	5000	2264A	AG40

Table P-56. Measurement List for HBL III (Continued)

Measurement Number	Hole Number	Location		Depth Z (ft)	Measure. Type	Predicted Level	Xducer Nominal Range	Xducer Model	Xducer Serial Number
		X (ft)	Y (ft)						
023	L15	70	24	13.1	AV	400	5000	2264A	AH37
024	L15	70	24	13.1	AH	1000	5000	2264A	AH89
025	L15	70	24	7.6	AV	500	5000	2264A	AH31
026	L15	70	24	7.6	AH	1200	5000	2264A	AH22
027	L20	90	26	47.5	AV	150	500	2260C	AD62
028	L20	90	26	47.5	AH	200	500	2260C	AE53
029	L20	90	26	44.4	AV	170	500	2260C	AB86
030	L20	90	26	44.4	AH	240	500	2260C	AB87
031	L21	90	24	37.2	AV	180	500	2260C	AD65
032	L21	90	24	37.2	AH	275	500	2260C	AF07
033	L21	90	24	26.2	AV	150	500	2260C	AE07
034	L21	90	24	26.2	AH	350	500	2260C	AD96
035	L21	90	24	17.2	AV	125	250	2260C	AE72
036	L21	90	24	17.2	AH	400	5000	2264A	AH46
037	L22	90	22	13.1	AV	100	250	2260C	AE92
038	L22	90	22	13.1	AH	400	5000	2264A	AH35
039	L22	90	22	7.6	AV	100	250	2260C	AE46
040	L22	90	22	7.6	AH	450	5000	2264A	AH87
041	L22	90	22	2.0	AV	200	500	2260C	AB49
042	L22	90	22	2.0	AH	500	5000	2264A	AH32
043	L26	130	26	44.6	AV	40	250	2260C	AE02

Table P-56. Measurement List for HBL III (Continued)

Measurement Number	Hole Number	Location		Depth Z (ft)	Measure. Type	Predicted Level	Xducer Nominal Range	Xducer Model	Xducer Serial Number
		X (ft)	Y (ft)						
044	L26	130	26	44.6	AH	90	250	2260C	AE95
045	L26	130	26	25.4	AV	40	250	2260C	AE51
046	L26	130	26	25.4	AH	110	250	2260C	AE13
047	L27	130	24	11.43	AV	25	250	2260C	AD98
048	L27	130	24	11.43	AH	130	500	2260C	AA75
049	L27	130	24	7.2	AV	25	250	2260C	AD95
050	L27	130	24	7.2	AH	130	500	2260C	AD64
051	L28	170	26	36.5	AV	15	250	2260C	AD70
052	L28	170	26	36.5	AH	50	250	2260C	AD13
053	L28	170	26	23.5	AV	10	250	2260C	AB94
054	L28	170	26	23.5	AH	50	250	2260C	AC50
055	L28	170	26	16.6	AV	15	250	2260C	AC01
056	L28	170	26	16.6	AH	55	250	2260C	AB95
057	L29	170	24	12.9	AV	15	250	2260C	AB72
058	L29	170	24	12.9	AH	55	250	2260C	AA99
059	L29	170	24	7.4	AV	15	250	2260C	AA84
060	L29	170	24	7.4	AH	60	250	2260C	AA78
061	L05	38	34	13.95	FS 45	3000	4000	SE	348
062	L06	38	41	13.92	FS 45	3000	4000	SE	358
063	L07	55	34	12.4	FS V	1000	2000	SE	385
064	L07	55	34	2.0	FS V	1500	2000	SE	383
065	L10	55	22	2.0	FS H	1500	2000	SE	322
066	L11	55	20	12.4	FS H	1000	2000	SE	325

Table P-56. Measurement List for HBL III (Continued)

Measurement Number	Hole Number	Location X (ft) Y (ft)	Depth Z (ft)	Measure. Type	Predicted Level	Xducer Nominal Range	Xducer Model	Xducer Serial Number
067	L13	70 32	13.1	FS V	400	2000	SE	321
068	L13	70 32	7.45	FS V	500	2000	SE	373
069	L16	70 22	7.6	FS H	500	2000	SE	353
070	L17	70 20	13.1	FS H	400	2000	SE	324
071	L18	90 30	13.2	FS V	150	2000	SE	345
072	L18	90 30	7.6	FS V	200	2000	SE	308
073	L18	90 30	1.6	FS V	175	2000	SE	298
074	L19	90 28	13.2	FS H	150	2000	SE	222A
075	L23	90 20	7.6	FS H	200	2000	SE	283
076	L24	90 18	2.0	FS H	175	2000	SE	366
077		6 6	0	BP	2700			E09
078		24 6	0	BP	2700			SE47
079		42 6	0	BP	2700			SE37
080		6 20	0	BP	2700			SE48
081		24 20	0	BP	2700			SE002
082		42 20	0	BP	2700			SE50
083		6 42	0	BP	2700			E23A
084		24 42	0	BP	2700			SE045
085		42 42	0	BP	2700			E07
086	L30	6 39	6	FS V	2000	4000		198
087	L30	6 39,	3	FS V	2400	4000		372
088	L33	10.05 29	6	FS V	2000	4000		317

Table P-56. Measurement List for HBL III (Continued)

Measurement Number	Hole Number	Location		Depth Z (ft)	Measure. Type	Predicted Level	Xducer Nominal Range	Xducer Model	Xducer Serial Number
		X (ft)	Y (ft)						
089	L33	10.05	29	3	FS V	2400	4000		391
090	L31	10.05	39	6	FS V	2000	4000		180
091	L31	10.05	39	3	FS V	2400	4000		320
092	L32	14.10	39	6	FS V	2000	4000		313
093	L32	14.10	39	3	FS V	2400	4000		340
099	L12A	60	15	13.4	AV	2000	5000	2264A	AH24
100	L12A	60	15	13.4	AH	2000	5000	2264A	AH86
101	L12A	60	15	13.83	WAM-V	1000	4000	WAM	51
102	L12A	59	15	12.4	WAM-H	500	4000	WAM	46
103	L12A	60	14	12.4	WAM-H	1000	4000	WAM	83
104	L12	55	15	3.0	AV	2000	5000	2264A	AH67
105	L12	55	15	3.0	AH	2000	5000	2264A	AH83
106	L12	55	15	3.5	WAM-V	1000	4000	WAM	67
107	L12	54	15	2.0	WAM-H	500	4000	WAM	61
108	L12	55	14	2.0	WAM-H	1000	4000	WAM	72
109	L25A	95	13	13.07	AV	500	5000	2264A	AH80
110	L25A	95	13	13.07	AH	500	5000	2264A	AG45
111	L25A	95	13	13.07	WAM-V	200	4000	WAM	79
112	L25A	94	13	12.07	WAM-H	100	4000	WAM	56
113	L25A	95	12	12.07	WAM-H	200	4000	WAM	58
114	L25	90	13	3	AV	500	5000	2264A	AG43
115	L25	90	13	3	AH	500	5000	2264A	AG44

Table P-56. Measurement List for HBL III (Continued)

Measurement Number	Hole Number	Location X (ft) Y (ft)	Depth Z (ft)	Measure. Type	Predicted Level	Xducer Nominal Range	Xducer Model	Xducer Serial Number
116	L25	90 13	3.5	WAM-V	200	4000	WAM	73
117	L25	89 13	2	WAM-H	100	4000	WAM	64
118	L25	90 12	2	WAM-H	200	4000	WAM	76
119		59 15	12.4	SE	600		Strain	
120		59 15	12.9	SE	300		Strain	
121		6 17.5	0	BP-X	2700			SE09
122		24 17.5	0	BP-X	2700			SE10
123		42 17.5	0	BP-X	2700			SE12

Table P-57. Measurement Recording List - HBL III

Measure Number	Measurement Designation	Recorder	Track	VCO	Cal. Level Actual (EU)	% Bandedge @ Cal. Level
001	HP-I HBL III-F-E-24-24-37.2-A-V	1	3	-	505.4g	50
002	HP-I HBL III-F-E-24-24-37.2-A-H	1	4	-	495.21g	50
003	HP-I HBL III-F-E-24-24-26.4-A-V	1	5	-	1007.68g	50
004	HP-I HBL III-F-E-24-24-26.4-A-H	1	6	-	503.99g	50
005	HP-I HBL III-F-E-24-24-13.4-A-V	1	7	-	4934.68g	50
006	HP-I HBL III-F-E-24-24-13.4-A-H	1	8	-	2954.25g	50
007	HP-I HBL III-F-E-38-32-13.3-A-V	1	9	-	4980.50g	50
008	HP-I HBL III-F-E-38-32-13.3-A-H	1	10	-	2993.83g	50
009	HP-I HBL III-F-E-38-24-7.8-A-V	1	11	-	5084.97g	50
010	HP-I HBL III-F-E-38-24-7.8-A-H	1	12	-	3979.56g	50
011	HP-I HBL III-F-E-38-16-13.9-A-V	1	13	-	5000.68g	50
012	HP-I HBL III-F-E-38-16-13.9-A-H	2	3	-	2994.39g	50
013	HP-I HBL III-F-E-55-26-16.3-A-V	2	4	-	1516.13g	50
014	HP-I HBL III-F-E-55-26-16.3-A-H	2	5	-	2096.25g	50
015	HP-I HBL III-F-E-55-24-12.5-A-V	2	6	-	2013.97g	50
016	HP-I HBL III-F-E-55-24-12.5-A-H	2	7	-	2497.50g	50
017	HP-I HBL III-F-E-55-24-2-A-V	2	8	-	2005.01g	50
018	HP-I HBL III-F-E-55-24-2-A-H	2	9	-	4000.00g	50
019	HP-I HBL III-F-E-70-26-26.1-A-V	2	10	-	499.39g	50
020	HP-I HBL III-F-E-70-26-26.1-A-H	2	11	-	706.37g	50
021	HP-I HBL III-F-E-70-26-17.1-A-V	7	3	1	405.50g	50
022	HP-I HBL III-F-E-70-26-17.1-A-H	7	3	3	927.05g	50

Table P-57. Measurement Recording List - HBL III (Continued)

Measure Number	Measurement Designation	Recorder	Track	VC0	Cal. Level Actual (EU)	% Bandedge @ Cal. Level
023	HP-I HBL III-F-E-70-24-13.1-A-V	7	3	5	397.63g	50
024	HP-I HBL III-F-E-70-24-13.1-A-H	7	3	7	999.40g	50
025	HP-I HBL III-F-E-70-24-7.6-A-V	7	3	9	513.07g	50
026	HP-I HBL III-F-E-70-24-7.6-A-H	7	3	11	1191.81g	50
027	HP-I HBL III-F-E-90-26-47.5-A-V	7	3	13	148.93g	50
028	HP-I HBL III-F-E-90-26-47.5-A-H	7	3	15	202.34g	50
029	HP-I HBL III-F-E-90-26-44.4-A-V	7	3	17	171.43g	50
030	HP-I HBL III-F-E-90-26-44.4-A-H	7	4	1	240.11g	50
031	HP-I HBL III-F-E-90-24-37.2-A-V	7	4	3	174.31g	50
032	HP-I HBL III-F-E-90-24-37.2-A-H	7	4	5	284.28g	50
033	HP-I HBL III-F-E-90-24-26.2-A-V	7	4	7	148.07g	50
034	HP-I HBL III-F-E-90-24-26.2-A-H	7	4	9	350.34g	50
035	HP-I HBL III-F-E-90-24-17.2-A-V	7	4	11	124.45g	50
036	HP-I HBL III-F-E-90-24-17.2-A-H	7	4	13	412.49g	50
037	HP-I HBL III-F-E-90-22-13.1-A-V	7	4	15	98.53g	50
038	HP-I HBL III-F-E-90-22-13.1-A-H	7	4	17	399.11g	50
039	HP-I HBL III-F-E-90-22-7.6-A-V	7	5	1	97.15g	50
040	HP-I HBL III-F-E-90-22-7.6-A-H	7	5	3	438.75g	50
041	HP-I HBL III-F-E-90-22-2-A-V	7	5	5	199.07g	50
042	HP-I HBL III-F-E-90-22-2-A-H	7	5	7	502.85g	50
043	HP-I HBL III-F-E-130-26-44.6-A-V	7	5	9	40.11g	50
044	HP-I HBL III-F-E-130-26-44.6-A-H	7	5	11	88.18g	50

Table P-57. Measurement Recording List - HBL III (Continued)

Measure Number	Measurement Designation	Recorder	Track	VCO	Cal. Level Actual (EU)	% Bandedge @ Cal. Level
045	HP-I HBL III-F-E-130-26-25.4-A-V	7	5	13	40.38g	50
046	HP-I HBL III-F-E-130-26-25.4-A-H	7	5	15	110.51g	50
047	HP-I HBL III-F-E-130-24-11.43-A-V	7	5	17	24.95g	50
048	HP-I HBL III-F-E-130-24-11.43-A-H	7	6	1	134.35g	50
049	HP-I HBL III-F-E-130-24-7.2-A-V	7	6	3	25.27g	50
050	HP-I HBL III-F-E-130-24-7.2-A-H	7	6	5	130.01g	50
051	HP-I HBL III-F-E-170-26-36.5-A-V	7	6	7	15.23g	50
052	HP-I HBL III-F-E-170-26-36.5-A-H	7	6	9	50.69g	50
053	HP-I HBL III-F-E-170-26-23.5-A-V	7	6	11	10.01g	50
054	HP-I HBL III-F-E-170-26-23.5-A-H	7	6	13	49.68g	50
055	HP-I HBL III-F-E-170-26-16.6-A-V	7	6	15	15.15g	50
056	HP-I HBL III-F-E-170-26-16.6-A-H	7	6	17	52.44g	50
057	HP-I HBL III-F-E-170-24-12.9-A-V	7	9	1	15.62g	50
058	HP-I HBL III-F-E-170-24-12.9-A-H	7	9	3	53.04g	50
059	HP-I HBL III-F-E-170-24-7.4-A-V	7	9	5	15.11g	50
060	HP-I HBL III-F-E-170-24-7.4-A-H	7	9	7	61.94g	50
061	HP-I HBL III-F-E-38-34-13.95-FS-45	3	15	-	2996.91 psi	50
062	HP-I HBL III-F-E-38-41-13.92-FS-45	3	16	-	3021.20 psi	50
063	HP-I HBL III-F-E-55-34-12.4-FS-V	3	17	-	987.00 psi	50
064	HP-I HBL III-F-E-55-34-2-FS-V	3	18	-	1499.04 psi	50
065	HP-I HBL III-F-E-55-22-2-FS-H	3	19	-	1499.40 psi	50
066	HP-I HBL III-F-E-55-20-12.4-FS-H	3	20	-	989.10 psi	50

Table P-57. Measurement Recording List - HBL III (Continued)

Measure Number	Measurement Designation	Recorder	Track	VCO	Cal. Level Actual (EU)	% Bandedge @ Cal. Level
067	HP-I HBL III-F-E-70-32-13.1-FS-V	3	21	-	400.04 psi	50
068	HP-I HBL III-F-E-70-32-7.45-FS-V	3	22	-	497.42 psi	50
069	HP-I HBL III-F-E-70-22-7.6-FS-H	3	23	-	497.39 psi	50
070	HP-I HBL III-F-E-70-20-13.1-FS-H	3	24	-	398.50 psi	50
072	HP-I HBL III-F-E-90-30-7.6-FS-V	3	26	-	201.48 psi	50
073	HP-I HBL III-F-E-90-30-1.6-FS-V	3	27	-	169.92 psi	50
074	HP-I HBL III-F-E-90-28-13.2-FS-H	2	12	-	150.56 psi	50
075	HP-I HBL III-F-E-90-20-7.6-FS-H	2	13	-	200.75 psi	50
076	HP-I HBL III-F-E-90-18-2-FS-H	4	3	-	174.93 psi	50
077	HP-I HBL III-A-E-6-6-0-BP	3	3	-	2716.00 psi	50
078	HP-I HBL III-A-E-24-6-0-BP	3	4	-	2702.06 psi	50
079	HP-I HBL III-A-E-42-6-0-BP	3	5	-	2660.66 psi	50
080	HP-I HBL III-A-E-6-20-0-BP	3	6	-	2489.36 psi	50
081	HP-I HBL III-A-E-24-20-0-BP	3	7	-	2715.35 psi	50
082	HP-I HBL III-A-E-42-20-0-BP	3	8	-	2681.32 psi	50
083	HP-I HBL III-A-E-6-42-0-BP	3	9	-	2698.54 psi	50
084	HP-I HBL III-A-E-24-42-0-BP	3	10	-	2689.07 psi	50
085	HP-I HBL III-A-E-42-42-0-BP	3	11	-	2709.50 psi	50
086	HP-I HBL III-A-E-6-39-6-FS-V	4	4	-	2069.74 psi	50
087	HP-I HBL III-A-E-6-39-3-FS-V	4	5	-	2392.00 psi	50
088	HP-I HBL III-A-E-10.05-29-6-FS-V	4	6	-	2000.28 psi	50
089	HP-I HBL III-A-E-10.05-29-3-FS-V	4	7	-	2390.11 psi	50

Table P-57. Measurement Recording List - HBL III (Continued)

Measure Number	Measurement Designation	Recorder	Track	VCO	Cal. Level Actual (EU)	% Bandedge @ Cal. Level
091	HP-I HBL III-A-E-10.05-39-3-FS-V	4	9	-	2398.44 psi	50
092	HP-I HBL III-A-E-14.10-39-6-FS-V	4	10	-	1996.06 psi	50
093	HP-I HBL III-A-E-14.10-39-3-FS-V	4	11	-	2431.68 psi	50
099	HP-I HBL III-S-E-55-15-13.4-A-V	4	12	-	2010.51g	50
100	HP-I HBL III-S-E-55-15-13.4-A-H	4	13	-	1985.50g	50
101	HP-I HBL III-S-E-55-15-13.83-WAM-V	5	3	-	1008.19 psi	50
102	HP-I HBL III-S-E-54-15-12.4-WAM-H	5	4	-	503.89 psi	50
102A	HP-I HBL III-S-E-55-15-12.4-WAM-H	5	5	-	503.89 psi	12.5
103	HP-I HBL III-S-E-55-14-12.4-WAM-H	5	6	-	1014.19 psi	50
104	HP-I HBL III-S-E-55-15-3-A-V	5	7	-	1968.90g	50
106	HP-I HBL III-S-E-55-15-3.5-WAM-V	5	9	-	986.75 psi	50
107	HP-I HBL III-S-E-54-15-2-WAM-H	5	10	-	499.49 psi	50
107A	HP-I HBL III-S-E-54-15-2-WAM-H	5	11	-	499.49 psi	12.5
108	HP-I HBL III-S-E-55-14-2-WAM-H	5	12	-	500.24 psi	50
109	HP-I HBL III-S-E-90-12-13.07-A-V	5	13	-	999.70g	50
110	HP-I HBL III-S-E-90-12-13.07-A-H	6	3	-	501.75g	50
111	HP-I HBL III-S-E-90-12-13.47-WAM-V	5	8	-	199.55 psi	50
112	HP-I HBL III-S-E-89-12-12.07-WAM-H	6	5	-	99.63 psi	50
112A	HP-I HBL III-S-E-89-12-12.07-WAM-H	6	6	-	99.63 psi	10
113	HP-I HBL III-S-E-90-12-12.07-WAM-H	6	7	-	200.69 psi	50
114	HP-I HBL III-S-E-90-13-3-A-V	6	8	-	503.81g	50
115	HP-I HBL III-S-E-90-13-3-A-H	6	9	-	504.98g	50

Table P-57. Measurement Recording List - HBL III (Continued)

Measure Number	Measurement Designation	Recorder	Track	VCO	Cal. Level Actual (EU)	% Bandedge @ Cal. Level
116	HP-I HBL III-S-E-90-13-3.5-WAM-V	6	10	-	200.72 psi	50
117	HP-I HBL III-S-E-89-13-2-WAM-H	6	11	-	99.88 psi	50
117A	HP-I HBL III-S-E-89-13-2-WAM-H	6	12	-	99.88 psi	10
118	HP-I HBL III-S-E-90-12-2-WAM-H	6	13	-	200.24 psi	50
119	HP-I HBL III-X-E-59-15-12.4-SE	7	9	9	617.23 μ E	50
120	HP-I HBL III-X-E-59-15-12.9-SE	7	9	11	294.40 μ E	50
121	HP-I HBL III-X-E-6-17.5-0-BPX	3	12	-	2740.30 psi	50
122	HP-I HBL III-X-E-24-17.5-0-BPX	3	13	-	2710.00 psi	50
123	HP-I HBL III-X-E-42-17.5-0-BPX	3	14	-	2710.68 psi	50

DISTRIBUTION LIST

DDC		Hq. USAF	
2 cy	ATTN: TC	ATTN: PREE	
Dir		2 cy	ATTN: RDQS
DNA		AUL	
3 cy	ATTN: SPSS	ATTN: LDE	
DDR&E		SAMSO	
2 cy	ATTN: Asst. Dir. Strat. Wpns.	ATTN: Lib.	
JSTPS		5 cy	ATTN: MNNH, Capt Kaiser
	ATTN: JLTW	CERF	
AFSC		2 cy	
2 cy	ATTN: DOB	Civ. Nuc. Sys.	
AFWL		ATTN: Dr. Crawford	
	ATTN: HO, Dr. Minge	GE-Tempo	
	ATTN: DEV, Capt McGrath	ATTN: DASIAC	
	ATTN: DEP, Capt McNickle	ATTN: Dr. Doran	
2 cy	ATTN: SUL	TRW Sys. Gp.	
5 cy	ATTN: DEX	ATTN: Tech. Lib.	
20 cy	ATTN: DEV	2 cy	ATTN: Dr. Farrell, R1/2178
CINCSAC			
	ATTN: DEE		
4 cy	ATTN: XPQT		

Official Record Copy, Capt McNickle, AFWL/DEP